

BYTE®

JULY 1982 Vol. 7, No. 7
\$2.95 in USA
\$3.50 in Canada/1.85 in U.K.
A McGraw-Hill Publication

the small systems journal



COMPUTERS IN THE ARTS AND SCIENCES

Powerful.

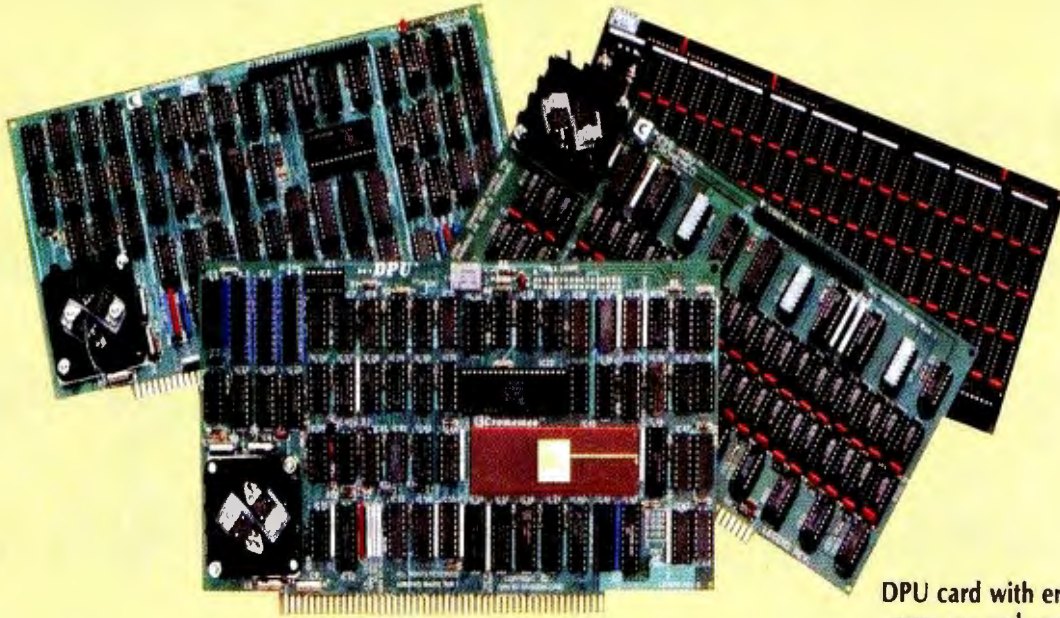

DPU card with error-correcting memory and controller cards

68000-Powered for tomorrow

Once again you get a big stride forward with Cromemco. This time it's our new DPU Dual Processor Unit. It gives enormous power to Cromemco computer systems such as our System One shown here.

Compares with mainframes

With the new DPU you get the almost unbelievably powerful 68000 processor and its 32-bit data-handling capabilities combined with its **16 Megabyte** address space.

In other words with the System One/DPU combination you get a small machine that's the equal of superminis and mainframes in some areas.

8-Bit and 68000 software

The dual part of the DPU refers to its on-board Z-80A processor. With this you have access to existing CP/M* software.

But besides being compatible with this wealth of existing 8-bit software, the System One/DPU has available a whole family of new 68000 system software. This includes a wide range of high-level software such as our 68000 Assembler, FORTRAN 77, Pascal, BASIC, COBOL, and C.

Beyond all this there's a version for the 68000 of our widely admired CROMIX† Operating System. It's like UNIX‡ but has even more features and gives multi-tasking and multi-user capability. In fact, one or more users can run on the Z-80A processor while others are running on the 68000. Switching between the Z-80A and 68000 is automatically controlled.

The System One itself is a bus-oriented machine that has options for color graphics, for 390K or 780K of floppy storage, a 5 MB hard disk option, communications capability, and multi-processor capability using our I/O processor card.

Powerful new micro. Powerful software.



3715 Printer

System One CS-1H



3102 Terminal

Highly expandable

With the System One/DPU combination, you get tremendous expandability. Right now you can have up to 2 MB of RAM storage. You get this with our new Memory Storage cards and our Memory Controller. The Controller fully supports the 16 MB storage space of the 68000, allowing you vast future expansion capability.

Further, the memory has built-in **error detection and correction**, a feature normally found only in much more costly systems.

Present customers can field-upgrade their Cromemco systems to use the DPU and still be able to run their present software using the Z-80A on the DPU. It's one more

instance of Cromemco's policy of providing obsolescence insurance for Cromemco users.

Low priced

With all this performance you might not be ready for the low price we're talking about. With 256K of RAM and 780K of floppy storage, the price of the System One/DPU is only \$5495. That's hard to beat.

So contact your rep now. He'll fill you in on the many more features that this outstanding and powerful machine offers.

*CP/M is a trademark of Digital Research
†CROMIX is a trademark of Cromemco, Inc.
‡UNIX is a trademark of Bell Telephone Laboratories



Cromemco™
I n c o r p o r a t e d

280 BERNARDO AVE., MOUNTAIN VIEW, CA 94040 • (415) 964-7400

Tomorrow's computers today

Circle 120 on inquiry card.

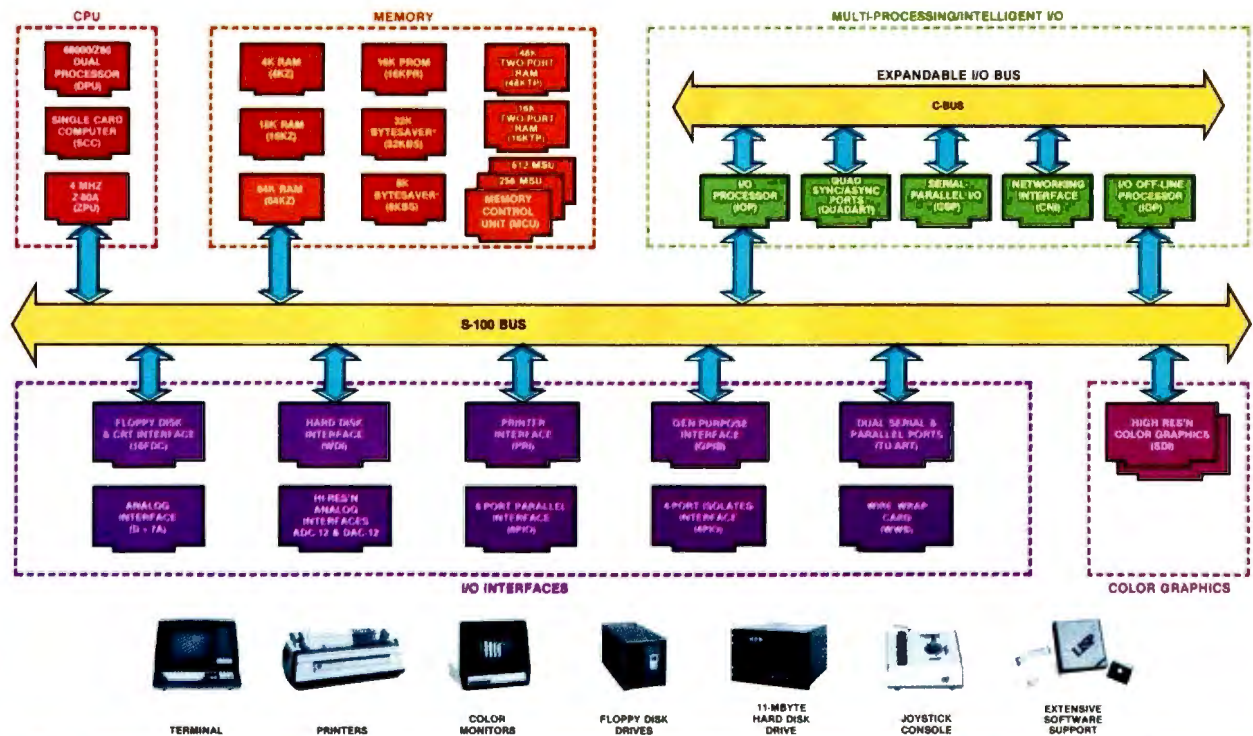

What Cromemco computer card capability can do for you

The above diagram shows in a functional way one of the most complete lines of computer cards in the industry.

Look it over carefully. It could be well worth your while.

These are all cards that plug into our S-100 bus microcomputers.

You can also assemble them into a custom system in convenient Cromemco card cages.

MULTI-PROCESSING AND INTELLIGENT I/O

The range of capabilities and versatility you can draw upon is enormous.

In processors, for example, you have a choice of CPU's including our extremely useful new I/O Processor. This can be used as a satellite-processor to do off-line processing, multi-processing, and to form intelligent I/O. It opens the door to a whole new group of applications and tasks. Ask us about it.

HIGH RESOLUTION COLOR GRAPHICS

Again, you can have beautiful high-resolution color graphics with our color graphics interface. You can select from over 4000 colors and have a picture with a resolution at least equal to quality broadcast-TV pictures.



You have an unprecedented selection of memory including our unusual 48K and 16K two-port RAMs which allow high-speed color graphics.

LOTS OF STORAGE

These days you often want lots of disk storage. So you can select from our disk controller card which will operate our 5" and 8" floppy disk drives (up to 1.2 megabytes). Or select our WDI interface to operate our 11-megabyte hard disk drives.

POWERFUL SOFTWARE AND PERIPHERAL SUPPORT

There's much more yet you can do with our cards. And, of course, there's an easy way to put them to work in our 8-, 12-, and 21-slot card cages. Our PS8 power supply makes it simple to get the system into operation.

Finally, Cromemco offers you the strongest software support in the industry

with languages like FORTRAN, C, COBOL, ASSEMBLER, LISP, BASIC and others. There is also a wide choice from independent vendors.

To top it all off, you can draw from a substantial array of peripherals: terminals, printers, color monitors and disk drives.

There is even more capability than we're able to describe here.

NOW AT HALL-MARK AND KIERULFF

For your convenience Cromemco products are now available at Hall-Mark Electronics and Kierulff Electronics. Contact these national distributors for immediate product delivery.

CROMEMCO COMPUTER CARDS

- **PROCESSORS** — 4 MHz Z-80 A CPU, single card computer, I/O processor • **MEMORY** — up to 64K including special 48K and 16K two-port RAMs and our very well known BYTESAVERS® with PROM programming capability • **HIGH RESOLUTION COLOR GRAPHICS** — our SDI offers up to 754 x 482 pixel resolution. • **GENERAL PURPOSE INTERFACES**—QUADART four-channel serial communications, TU-ART two-channel parallel and two-channel serial, 8PIO 8-port parallel, 4PIO 4-port isolated parallel, D+7A 7-channel D/A and A/D converter, printer interface, floppy disk controller with RS-232 interface and system diagnostics, wire-wrap and extender cards for your development work.



CromemcoTM
Incorporated

280 BERNARDO AVE., MOUNTAIN VIEW, CA 94040 • (415) 964-7400

Tomorrow's computers today

Circle 121 on inquiry card.

Features

34 The Input/Output Primer, Part 6: Interrupts, Buffers, Grounds, and Signal Degradation by Steve Leibson / The conclusion of a six-part series that covers fundamental issues in computer interfacing.

50 Computers, Fiction, and Poetry by Kevin McKean / Computer-generated stories and poems shed some light on the complex process known as creativity.

60 Add Programmable Sound Effects to Your Computer by Steve Ciarcia / Silicon replaces gunpowder for producing sound effects.

76 Breaking the Jargon Barrier: Designing Programs for Humanists by Ned Heite and Lou Heite / Two archaeologists design practical programs in the language their colleagues understand.

108 Microcomputers in the Study of Politics, Predicting Wars with the Richardson Arms-Race Model by Philip A. Schrodtt / A Pascal program helps predict the outcome of arms races and other two-party conflicts.

138 Software Tools for Writers by Wayne Holder / Your computer can take the tedium out of the process of writing and put new life into the final product.

166 The Historian and the Microcomputer, A Student of the Past Meets the Machine of the Future by Don Karl Rowney / The microcomputer promises to change the nature of historical research methods and the teaching of history.

178 Simulating Neighborhood Segregation by Edwin Dethlefsen and Carlisle Moody / A BASIC program gives surprising insights into some of the forces that hamper integration.

208 Measuring Attitudes with a PET, A BASIC Program That Finds Out How People Feel by David R. Heise / This BASIC program gives microcomputer owners sophisticated attitude-measurement tools once the domain of politicians and big corporations.

250 Microcomputers in Cultural Anthropology, APL Programs for Qualitative Analysis by Oswald Werner / Microcomputers on-site help the study of Navajo and other cultures.

290 User's Column: Ada, MINCE, CP/M Utilities, Over-priced Documentation, and Analiza II by Jerry Pournelle / An inveterate user of microcomputers expresses firm opinions on hardware, software, and other subjects.

330 Upward Migration, Part 2: A Comparison of CP/M-86 and MS-DOS by Roger Taylor and Phil Lemmons / An end user and a system programmer examine the two operating systems vying for dominance in the 16-bit arena.

360 Using the Model I/III RS-232C Port by William Barden Jr. / Some mysteries of the TRS-80 Model I and III RS-232C interface are solved and instructions are given for building a data communications plugboard.

378 Programming the Critical-Path Method in BASIC by Steven Zimmerman and Leo M. Conrad / This program helps managers assess the productivity trade-offs of time and money.

392 Computers for Humanity by Jerry Pournelle / A first-hand report on the newest products introduced at the Seventh West Coast Computer Faire.

Reviews

54 Scion Color System by Mark Dahmke

284 Mediamix's ET² by Robert Welborn

312 Color Computer Disk System by Colin Stearman

408 It All Depends on Your Viewpoint by Allen D. Moore

412 Database Management with Ashton-Tate's dBASE II by Jack L. Abbott

Nucleus

6 Editorial: The Briefcase Computer Market Heats Up

14 Letters

32 BYTE's Bugs

402 Book Review: Computer Power and Human Reason

406 Technical Forum: INS8070 Series Instruction Set Summary

417 Clubs and Newsletters

417, 432, 440 BYTE's Bits

418 Software Received

420 Ask BYTE

422 Event Queue

426 BYTELINES

431 Books Received

434 Desk-Top Wonders: Draw Poker for the TI-59

441, 452 Programming Quickies: Generate Huffman Codes; Idiot-proof Input in Pascal

442, 448 System Notes: Tuning Up the 1802; Double Your TRS-80's Graphics Resolution

454 What's New?

509 Unclassified Ads

510 BOMB, BOMB Results

511 Reader Service



Page 50



Page 54



Page 60



Page 76



Editor in Chief

Christopher Morgan

Managing Editor

Mark Haas

Technical Editors

Gregg Williams, Senior Editor;
Richard S. Shuford, Curtis P. Feigel,
George Stewart, Arthur Little,
Stanley Wszola, Pamela Clark, Steve Ciarcia,
Mark Dahmke, Philip Lemmons, Consulting
Editors; Jon Swanson, Drafting Editor

Copy Editors

Beverly Cronin, Chief;
Faith Hanson, Warren Williamson, Anthony J.
Lockwood, Hilary Selby Polk, Nancy Hayes,
Elizabeth Kepner, Margaret Cook, Junior
Copy Editor

Assistants

Faith Ferry, Debe Wheeler, Beverly Jackson

Production

David R. Anderson, Assoc. Director;
Patrice Scribner, Jan Muller, Virginia Reardon;
Sherry McCarthy, Chief Typographer;
Debi Fredericks, Donna Sweeney,
Valene Horn

Advertising

Thomas Harvey, Director;
Marion Carlson, Rob Hannings, Deborah
Porter, Vicki Reynolds, Cathy A. R. Drew, Lisa
Wozmack; Jacqueline Earnshaw, Reader
Service Coordinator; Wai Chiu Li, Advertising
Production Coordinator; Linda J. Sweeney

Circulation

Gregory Spitzfaden, Manager;
Andrew Jackson, Asst. Manager;
Agnes E. Perry, Barbara Varnum,
Louise Menegus, Pinky Krulis,
Sheila A. Bamford;
James Bingham, Dealer Sales;
Deborah J. Cadwell, Asst;
Linda Ryan

Marketing

Wilbur S. Watson, Marketing Coordinator;
Timothy W. Taussig, Marketing Production
Coordinator

Controller's Office

Daniel Rodrigues, Controller;
Mary E. Fluhr, Acct. & D/P Mgr.; Karen
Burgess, Jeanne Cilley, Linda Fluhr,
Vicki Bennett

Traffic

N. Scott Gagnon, Scott Jackson,
Kathleen Reckart

Receptionist

Jeanann Waters

Publishers

Virginia Londoner, Gordon R. Williamson;
John E. Hayes, Associate Publisher;
Cheryl A. Hurd, Michele P. Verville, Publisher's
Assistants;

Officers of McGraw-Hill Publications Company: Paul F. McPherson, President; Executive Vice Presidents: Daniel A. McMillan, III, Gene W. Simpson; Senior Vice President-Editorial: Ralph R. Schulz; Vice Presidents: Kemp Anderson, Business Systems Development; Harry L. Brown, Special Markets; Robert B. Doll, Circulation; James E. Hackett, Controller; Eric B. Herr, Planning and Development; H. John Sweger, Jr., Marketing.

Officers of the Corporation: Harold W. McGraw Jr., Chairman and Chief Executive Officer; Joseph L. Dionne, President and Chief Operating Officer; Robert N. Landes, Senior Vice President and Secretary; Ralph J. Webb, Treasurer.



In This Issue

The availability of small, powerful, and inexpensive computers has brought the power of the computer out of its traditional domain—science, mathematics, engineering, and business-data processing—and into the hands of historians, anthropologists, artists, musicians, political scientists, and others involved in the humanities, arts, and social sciences. Philip Schrodt (of "The Generic Word Processor" fame) presents a program to predict wars in his article "Microcomputers in the Study of Politics." Kevin McKean shows how computers can spin tall yarns in "Computers, Fiction, and Poetry," and Wayne Holder helps you spin them yourself in "Software Tools for Writers." Ned and Lou Heite present their views on what is needed to advance the use of computers in the humanities in "Breaking the Jargon Barrier: Designing Programs for Humanists." We also have a computer simulation of neighborhood segregation, a program for measuring people's attitudes, and more.

Roger Taylor and Phil Lemmons conclude their two-part article "Upward Migration" with an in-depth comparison of CPM-86 and MS-DOS, and their findings may surprise you. Jerry Pournelle gives his impressions of the West Coast Computer Faire in "Computers for Humanity," Steve Ciarcia shows you how to create sound effects with your computer, and William Barden Jr. illustrates how to use the RS-232C port on TRS-80 Models I and III. A generous sprinkling of product reviews and regular features round out our July issue.

BYTE is published monthly by BYTE Publications Inc, 70 Main St, Peterborough NH 03458, phone (603) 924-9281, a wholly-owned subsidiary of McGraw-Hill, Inc. Address subscriptions, change of address, USPS Form 3579, and fulfillment questions to BYTE Subscriptions, POB 590, Martinsville NJ 08836. Second class postage paid at Peterborough, N.H. 03458 and additional mailing offices. USPS Publication No. 528890 (ISSN 0360-5280). Canadian second class registration number 9321. Subscriptions are \$19 for one year, \$34 for two years, and \$49 for three years in the USA and its possessions. In Canada and Mexico, \$21 for one year, \$38 for two years, \$55 for three years. \$43 for one year air delivery to Europe. \$35 surface delivery elsewhere. Air delivery to selected areas at additional rates upon request. Single copy price is \$2.95 in the USA and its possessions, \$3.50 in Canada and Mexico, \$4.50 in Europe, and \$5.00 elsewhere. Foreign subscriptions and sales should be remitted in United States funds drawn on a US bank. Printed in United States of America.

Address all editorial correspondence to the editor at BYTE, POB 372, Hancock NH 03449. Unacceptable manuscripts will be returned if accompanied by sufficient first class postage. Not responsible for lost manuscripts or photos. Opinions expressed by the authors are not necessarily those of BYTE. Entire contents copyright © 1982 by BYTE Publications Inc. All rights reserved. Where necessary, permission is granted by the copyright owner for libraries and others registered with the Copyright Clearance Center (CCC) to photocopy any article herein for the base fee of \$1.00 per copy of the article or item plus 25 cents per page. Payment should be sent directly to the CCC, 21 Congress St, Salem MA 01970. Copying done for other than personal or internal reference use without the permission of McGraw-Hill is prohibited. Requests for special permission or bulk orders should be addressed to the publisher.

BYTE® is available in microform from University Microfilms International, 300 N Zeeb Rd, Dept PR, Ann Arbor MI 48106 USA or 18 Bedford Row, Dept PR, London WC1R 4EJ England.



Office hours: Mon-Thur 8:30 AM - 4:30 PM, Friday 8:30 AM - Noon, Eastern Time

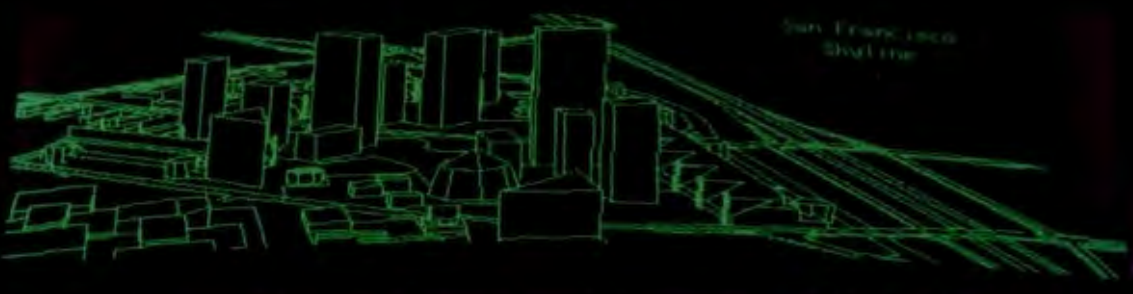
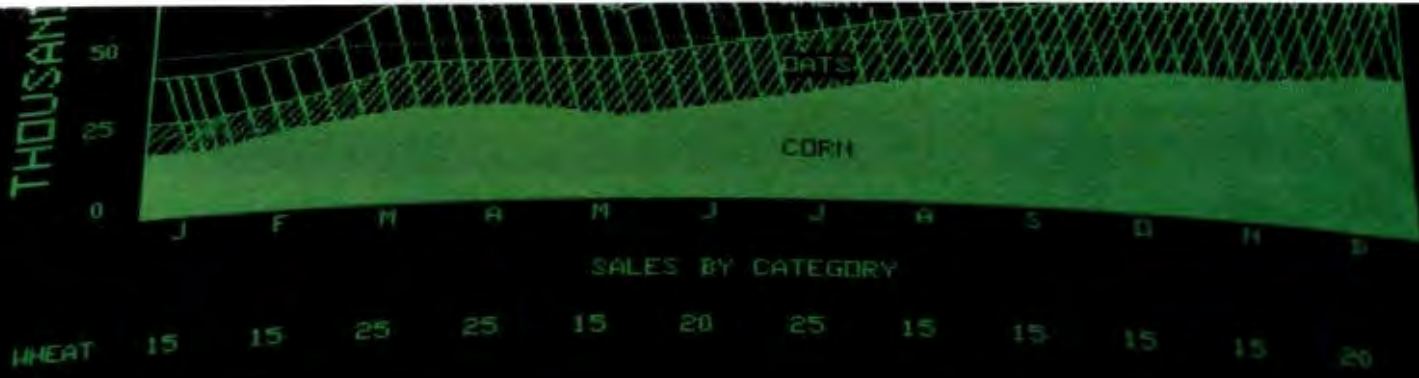

ADD QUALITY GRAPHICS For Just \$711.*

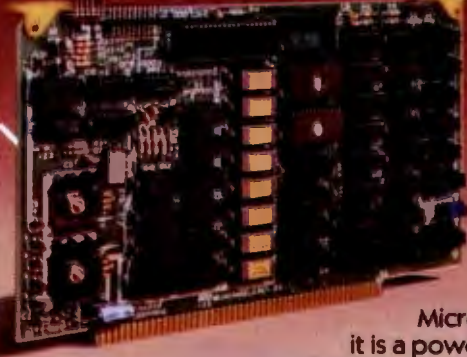

The OEM's best choice for graphics is MicroAngelo™, the single board graphics display computer from SCION. Install MicroAngelo in your Multibus or S-100 host and let this intelligent display processor bring your screen to life with full graphics and text. MicroAngelo features 512 by 480 pixel graphics and 40 line by 85 character text displays.

Save development time and overhead with SCREENWARE™, SCION's high level display firmware language. SCREENWARE provides point, vector, region, circle, flood, crosshair, light pen interface, tracking cross, screen load and dump, split screen, macro, and full terminal emulation commands. Use MicroAngelo both as your main console and as your application software's display screen.

MicroAngelo's on-board processor frees your host processor and bus to perform other tasks, while on-board memory and firmware reduce the size of your application programs. With our direct, easy interface to any high level language, you are no more than a simple sub-

routine call away from MicroAngelo's powerful capabilities. Use one MicroAngelo for monochrome graphics displays. And combine two or more MicroAngelos to create high resolution color graphics.

MicroAngelo is the OEM's choice because it is a powerful self-contained graphics display computer that is easy to add to your host. A graphics display computer that is proven reliable in over 1000 field installations. A graphics display computer that is so affordable you don't have to design your own.

Think SCION for your graphics display needs. Think MicroAngelo. Call us at (703) 476-6100.

*OEM quantity 25 price for Multibus or S-100 board.

SCION

if the image is important.

12310 Pinecrest Rd./Reston, VA 22091
(703) 476-6100 TWX: 710-833-0684



FILEFIX™

THE EASIEST WAY TO RECOVER LOST FILES

FILEFIX UNDELETES files in your CP/M directory (data in the actual files are not altered.)

- With FILEFIX you may view your CP/M directory block allocation map.
- Display your files in short form - including ERASED files.
- Display your files in long form with block and sector status.
- Display your disk status completely.

With FILEFIX its easy to PROTECT a file and CLEAN erased files or FORGE multi-user links to the same file.

FILEFIX is easy to use by both the novice and the experienced CP/M user. Your FILEFIX disk will not only allow you to recover erased files in the directory; several utilities are provided which allow you to SHOW textfiles one screenful at a time; ENCRYPT files with a one or two letter password; COPY files; RENAME files; VERIFY files and more.

FILEFIX is \$100. and works with CP/M 2.2

CP/M is a trademark of Digital Research. FILEFIX™ is a trademark of Alan R. Miller, PhD.

SEE YOUR COMPUTER DEALER FOR MORE DETAILS, OR CALL DIRECT.

SOFTWARE
SOFTWARE
DIGITAL MARKETING
DIGITAL MARKETING™



DIGITAL MARKETING CORPORATION

2670 Cherry Lane • Walnut Creek, CA 94596
(415) 938-2880 • Telex 17-1852 (DIGMKTG WNCK)

Editorial

The Briefcase Computer Market Heats Up

by Chris Morgan, Editor in Chief

Last April I predicted that "within two years the market will be flooded with portable computers having built-in screens of every size and shape." My prediction is coming true sooner than I expected. Several machines on the market now feature flat-screen displays; the most heralded is the Compass computer from Grid Systems in Mountain View, California. The Compass has many fascinating features. At \$8150, though, it's in the premium class. But some competitively priced machines have sprung up as well. This month I'll examine some of the new briefcase computers.

Diverse in price, size, and quality, these new briefcase computers have at least one thing in common: they use a flat screen rather than a cathode-ray tube to display characters. Several technologies exist for building flat-screen displays, but the two that currently dominate the field are liquid-crystal displays (LCDs) and electroluminescent displays. (The Osborne 1 computer, though it qualifies as a portable computer because of its size, uses a conventional 5-inch CRT.)

Liquid-crystal displays can be found in the IXO Telecomputing System (featured on the April 1982 BYTE cover); the Epson HX-20 (April 1982 BYTE, page 104); the Toshiba T100 (May 1982 BYTE, page 109); the Panasonic Link—formerly known as the HHC (January 1981 BYTE, page 34); the Sharp-manufactured Radio Shack Pocket Computer (January 1981 BYTE, page 45); and several other models. The Grid Compass is currently the sole example of an electroluminescent-display computer. (The display is manufactured by Sharp in Japan.)



Photo 1: Compass computer from Grid Systems.

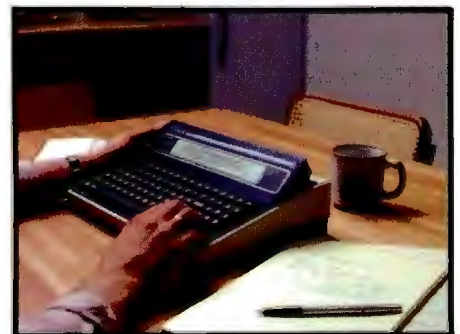

Photo 2: Teleram T-3000.

Fit Right in



Of course Percom diskette drives for the IBM Personal Computer fit right in. They fit right outside your Personal Computer, too. And they're fully compatible, providing the same full double-density storage capacity.

But just as important, Percom diskette drives also fit the same high standards set by IBM.

At Percom we've been making disk storage systems since 1977. We build quality, high-performance disk drive systems. From proven design through quality inspections that include 100% two-day operational tests. And Percom dealer support ensures competent after-sale service.

So expect more from Percom. You won't be disappointed.

Percom disk drives for the IBM Personal Computer are available in 40-track single- and dual-head models, and 80-track single-head models. Call or visit your independent IBM Personal Computer dealer — and fit right in with Percom. For the names of dealers carrying Percom products for your Personal Computer call toll-free 1-800-527-1222.

PRICES AND SPECIFICATIONS SUBJECT TO CHANGE WITHOUT NOTICE.



PERCOM DATA COMPANY, INC.

11220 PAGEMILL RD • DALLAS, TX 75243 • (214) 340-7081

IBM and IBM PERSONAL COMPUTER are trademarks of International Business Machines, Inc.
PERCOM is a trademark of Percom Data Company, Inc.



Minimum system requirements are an IBM System Unit with 16 Kbytes of RAM and 5¼" Diskette Drive Adapter. Drive models supported depend on DOS used. An optional cable available from Percom is required for external (add-on) drives.

Yes ... I'd like to know more about Percom diskette drives for my IBM Personal Computer. Rush me free literature.

Send to: PERCOM DATA COMPANY, Inc., Dept. 2-B01
11220 Pagemill Road, Dallas, Texas 75243

name _____

street _____

city _____ state _____

zip _____ phone number _____

I intend to add a hard-disk system to my computer yes no.

MAIL TODAY!

The company known for its state-of-the-art hardware, now has software to match.

With technology as advanced as you'll find in its hardware, Ithaca InterSystems offers an impressive collection of software products for business, academic and academic environments. **InterEdit™**, a business-oriented version of the well-known Pascal/Z compiler for Z-80™ based machines running the Digital Research CP/M-MP/M II® operating systems, enhances the use of Pascal as a business programming language. It gives you greater precision, efficiency and flexibility.

InterEdit™ screen editor is designed so that novice computer-users can create, edit and save files with a minimum of keystrokes. InterEdit features an automatic paragraph indent, making it extremely useful for intensive typing programs.

InterProof™ spelling checker and corrector is an all-in-one utility. InterProof checks the words in any text file against its 14,000 literal word dictionary, and automatically corrects the word spelling.

InterComp™ source compare utility eliminates time wasted reading and re-reading revisions. It's ideal for word processing and programming applications.

All Ithaca InterSystems software runs on any Ithaca computer system and on any Z-80 based machine running CP/M-MP/M. You'll find that Ithaca's service after the sale is just as advanced as hardware and software products. We believe in what we sell and support our products... after the sale.

For more information on these new software products, just call 800-847-2088, or in New York State 607-257-0190.

Get the facts about Pascal before you buy. Don't buy a Pascal compiler until you've read "The Facts About Pascal". Call us for a free copy.



Ithaca InterSystems™

We think as fast as you do.

Ithaca InterSystems, Inc.

1650 Hanshaw Rd., P.O. Box 91, Ithaca, N.Y. 14850
TWX 510-255-4346

* Pascal/BZ, Pascal/Z, InterComp, InterProof and InterEdit are trademarks of Ithaca InterSystems, Inc.

• Z-80 is a registered trademark of Zilog, Inc.

• CP/M-MP/M is a registered trademark of Digital Research, Inc.

Circle 198 on Inquiry card.

Editorial

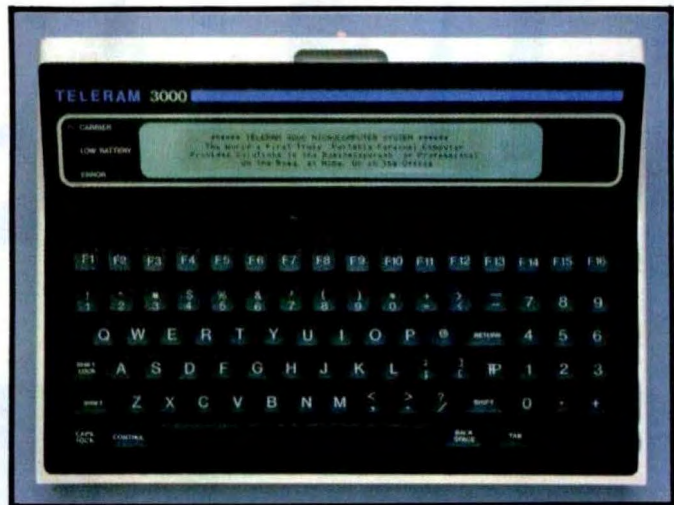

Photo 3: The T-3000's liquid-crystal display is the best around. The characters stand out clearly against a light, nonglare background.

Although electroluminescent displays offer a superior image, they consume a lot of power—so much that they cannot be battery operated as can LCDs. So the otherwise portable Compass computer has to be plugged into an AC receptacle. The Compass, however, offers compensations, such as a sophisticated custom operating system and a simplified set of "modeless" commands that let you, say, jump out of a word-processing program, do some calculations, and jump back in with a minimum of fuss. At present, the Compass is available to corporate customers only; the first delivery is scheduled for September. It will be available in quantity to consumers some time in 1983.

A Good Portable Computer for Writers?

I do a lot of writing in remote places, and I've searched for a battery-operated computer that will let me use Wordstar, Magic Wand, or a similar word-processing program to write articles, edit them, and relay them back to the office via phone. None of the computers listed above, including the Compass, completely fits my needs. They don't accept commonly available software, or they are not truly portable. The Sony Typecoder doesn't make it, either. The Typecoder is a portable, dedicated word processor with a one-line LCD display. Unfortunately, its editing function controls are awkward to use, and only half a line of text can be displayed at once. The Typecoder falls just short of being a really useful product. A multiline display would help immeasurably. And that brings me to another new electronic aid for writers: Teleram's new T-3000.

The Teleram T-3000

The T-3000, which will probably sell for less than \$3000, has all the right features. It's small in size and

Circle 199 on Inquiry card. →

Ithaca 525/800™

A computer system so advanced, the technology you'll need later is already here. And waiting.



The Ithaca 525/800 gives you the ability to address an almost unlimited number of applications in business, scientific, and educational environments.

Its state-of-the-art hardware gives you a single or multi-user 8-bit system in one machine that handles 5 1/4" or 8" floppy and hard disks.

It has a processor that's 50% faster than conventional systems. A unique Cache CP/M® - MP/M® system that's typically 500% faster. That's right, 500%. And up to 1 Mbyte of memory.

It has add-on capacity built-in now, ready to expand when you're ready. There are no hidden costs to pay for later. Everything you need comes with the

Ithaca 525/800. In fact, it could be the only system you'll ever need.

It's simply the finest price/performance Z-80® based system available. And it's here now, waiting for your call.

800-847-2088

In New York State
(607) 257-0190

Ithaca
InterSystems™

We think as fast as you do.

1650 Hanshaw Road, P.O. Box 91
Ithaca, NY 14850
TWX: 510-255-4346

weight (13 by 9¼ by 3½ inches, under 10 pounds); battery powered with rechargeable batteries; it has an 80-column by 4-line liquid-crystal display that tilts for better visibility; it has built-in bubble memory with up to 256K bytes (the bubble memory emulates drive A in the CP/M environment, thus letting the user run CP/M programs); 64K bytes of RAM; 4K bytes of ROM; a low-power version of the Z80 processor; standard keyboard with 16 function keys and a numeric keypad; and an RS-232C interface. An office module is also available from Teleram that lets you add a video monitor, up to four 5¼-inch floppy-disk drives, printers, additional bubble memory, and other peripherals.

Teleram, with headquarters in White Plains, New York, has been manufacturing portable computer terminals for reporters and writers for several years. On a recent trip to the Teleram offices I auditioned a prototype of the T-3000. Its most striking feature is the liquid-crystal display. It's the best-quality LCD I've seen. Characters stand out in sharp relief against a light, matte-finish background. Readability is good even at 45 degrees off axis. But the screen flips up during use, so angles shouldn't be a problem.

The keyboard layout is simple and logical, making it comfortable to use. And with an overlay, the 16 function keys could be used with word processors and the like.

As of this writing, Teleram plans to offer a variety of software with the machine, including a word processor (Wordstar or equivalent), a spread-sheet program, and a BASIC package (to be determined). The LCD acts as a "window" onto a standard 80-character by 24-line screen. Separate window and cursor controls let you move around on the page.

The T-3000 uses lead-acid batteries (the same technology as car batteries) rather than the more common nickel-cadmium batteries. Lead-acid batteries cost much less, but cannot be allowed to discharge too far lest they lose their recharging efficiency. To prevent this, the T-3000 gives you two separate warnings when the batteries get low. If you still fail to turn the machine off, the computer then saves the current file and turns itself off. The batteries should last for a minimum of five hours between charges, even longer when using a word processor because word processing does not unduly exercise the power-consuming bubble memories.

So it is possible to create a relatively inexpensive computer with real word-processing capability. Teleram has done an excellent job with the T-3000. I'll be using it over the coming months, and I expect to write an update later this year. By then there should be many more briefcase computers on the market from both Japanese and American manufacturers. I like the trend. ■

Compare our price and performance. *Le Monitor is second to none!*



A complete line of monitors with these outstanding features.

- 9" and 12" models
- Green or white phosphor
- 80x24 character display
- High resolution-800 lines, non-glare CRT
- 1 year warranty!

Dealer Inquiries Invited

Pi-Tech Limited
2 Douglas Pike
Smithfield, RI 02917
(401) 231-2080
TWX 710-381-8788

Q.I. Distributors
18720 Oxnard
Tarzana, CA 91356
(800) 423-5886
in CA (213) 996-2252

MORROW DESIGNS

Cost effective answers to floppy disk problems.

DMA answers. Standard, accumulator transfer floppy disk controllers can stall your microcomputer system's CPU for as long as 160 milliseconds. Just to access and transfer a sector of data to main memory. If CPU processing speed and system performance are critical, you need something better. That's where Morrow Designs' new intelligent Disk Jockey DMA™ controller comes in. This new breed of peripheral handles both 5¼" and 8" drives and can read almost any format in existence. Speed? Your CPU runs at full tilt while the DMA controller seeks and gathers a sector of data. How? Information transfers to and from main memory occur as "cycle steals" from the system bus. And the missing memory cycles are transparent to the CPU totaling only two milliseconds instead of the usual 80.

Build a buffer. Give the Disk Jockey DMA a little extra memory and your system's performance gets even better. The extra storage is used as a track buffer. So, whenever a sector on a new track is read, the track buffer is automatically filled with the other sec-



tors on the track. The result? Additional data on the track is immediately available. Without the 80 millisecond rotational latency normally encountered. And similar efficiencies occur with disk writes. Sectors in the track buffer are conditionally written on the disk only if a new track is accessed. And only one revolution of the disk is required.

Now, prices.* All systems listed are supplied with a floppy disk drive, Disk Jockey Direct Memory Access Controller, CP/M** 2.2 operating system, power supply, fan, cables, cabinet and Microsoft 5.2 BASIC.

Even lower prices. Morrow Designs' floppy disk systems with Disk Jockey™ 2D controllers offer the same high quality at even lower prices. Now without memory mapping!

Fast answers. See Morrow Designs' family of cost effective floppy disk systems at

your computer dealer. For a somewhat more leisurely answer, circle the reader service number below. For immediate answers, phone us at (415) 524-2101.

LOOK TO MORROW FOR ANSWERS.

5¼ Inch Systems (formatted data)

400,000 Bytes (1) Dual Sided 48 TPI Drive	\$ 995
800,000 Bytes (2) Dual Sided 48 TPI Drive	\$1695
800,000 Bytes (1) Dual Sided 96 TPI Drive	\$1495
1,600,000 Bytes (2) Dual Sided 96 TPI Drive	\$2495

OEM pricing available

8 Inch Systems (formatted data)

500,000 Bytes (1) Single Sided Drive	\$1195
1,000,000 Bytes (2) Single Sided Drive	\$1975
1,000,000 Bytes (1) Dual Sided Drive	\$1495
2,200,000 Bytes (2) Dual Sided Drive	\$2575

OEM pricing available

*Prices subject to change without notice.
Disk Jockey DMA and Disk Jockey 2D are trademarks of Morrow Designs

**CP/M is a trademark of Digital Research.

MORROW DESIGNS

5221 Central Avenue, Richmond, CA 94804
(415) 524-2101



PRINTERS

EPSON

- MX-100 729.00
List: 995.00
- MX-80 FT with GRAFTRAX 619.00
List: 795.00
- MX-80 FT 549.00
List: 745.00
- MX-80 with GRAFTRAX .. 479.00
List: 645.00
- 8141 SERIAL INTERFACE. 64.00
- 8150 SERIAL INTERFACE 140.00
WITH 2K BUFFER
- 8151 SERIAL INTERFACE 155.00
WITH 2K BUFFER AND Xon/Xoff PROTOCOL
- 8230 APPLE® CABLE ... 24.00
PARALLEL
- 8131 APPLE® INTERFACE 63.00
PARALLEL
- GRAPPLER INTERFACE AND CABLE: 125.00
FOR APPLE®, MX-80 (MUST have Graftrax), MX-80 FT, MX-100, IDS PAPER TIGERS AND C. ITOH PROWRITER

IDS

- PRISM PRINTER 132 ... 1699.00
List: 1995.00
- PRISM PRINTER 80 799.00
List: 895.00
- PAPER TIGER 560G ... 1149.00

OKIDATA

- MICROLINE 84 1199.00
- MICROLINE 83A 749.00
- MICROLINE 82A 499.00
- MICROLINE 80 365.00

C. ITOH

- PROWRITER PARALLEL . 499.00
List: 845.00
- PROWRITER SERIAL 650.00
List: 865.00
- F-10 PARALLEL 1560.00
- F-10 SERIAL CALL

MODEMS

HAYES

- CHRONOGRAPH 199.00
List: 249.00
- SMARTMODEM 227.00
- MICROMODEM II 299.00
APPLE®

NOVATION

- APPLE® -CAT 325.00
List: 389.00
- AUTO-CAT 213.00
- D-CAT 156.00

APPLE®

VISICORP

- VISICALC® APPLE DOS 3.3 190.00
List: 250.00
- VISICALC® IBM 64K 158.00
List: 200.00
- VISICALC® IBM 256K ... 190.00
List: 250.00
- VISIDEX 190.00
List: 250.00
- VISILOT 158.00
List: 200.00
- VISITERM 79.00
List: 100.00
- VISITREND 249.00
List: 300.00
- VISIFILE 190.00
List: 250.00
- DESKTOP PLAN II 190.00
List: 300.00
- DESKTOP PLAN III 149.00
List: 250.00
- VISIPACK: 599.00
INCLUDES VISICALC, VISIFILE, & VISITREND/VISILOT.
List: 700.00

MICROSOFT

- TIME MANAGER 125.00
List: 150.00
- TASC APPLESOFT COMPILER . 150.00
- FORTRAN 80 165.00
- COBOL 80 550.00
- A.L.D.S. 105.00

MICROPRO

- WORDSTAR 234.00
List: 375.00
- CALCSTAR 149.00

CP/M®

ASHTON TATE

- dBASE II VERSION 2.3A . 529.00
DATA BASE MANAGEMENT SYSTEM AVAILABLE IN MANY FORMATS.
List: 700.00

FOX&GELLER

- QUICKSCREEN 129.00
List: 149.00
- dUTIL 75.00
List: 99.00

MICROSOFT

- BASIC 80 285.00
- BASIC COMPILER 315.00
- COBOL 80 568.00
- FORTRAN 80 345.00
- muSIMP/muMATH. 215.00
- MACRO 80 140.00

LEXISOFT

- SPELLBINDER 299.00
List: 495.00
- SPELLCHECK 225.00
List: 295.00

MICROPRO

- WORDSTAR 293.00
List: 495.00
- WORDSTAR FOR IBM ... 289.00
List: 495.00
- SUPERSORT 168.00
- MAILMERGE 103.00
- DATASTAR 235.00
- SPELLSTAR 155.00
- CALCSTAR 199.00

ACCESSORIES

APPLE®

VIDEX

- VIDEOTERM 290.00
- KEYBOARD ENHANCER. 105.00

MOUNTAIN

- MULTI I/O 178.00

MICROSOFT

- PREMIUM SYSTEM: 619.00
INCLUDES: Z-80 SOFTCARD, 16K RAMCARD, VIDEX VIDEOTERM, and CP/M USER GUIDE.
List: 775.00
- Z-80 SOFTCARD 299.00
- 16K RAMCARD 150.00

TO ORDER:

THE MICROHOUSE ORDER CENTER IS OPEN 9:00 AM - 8:00 PM EASTERN TIME MONDAY THROUGH FRIDAY.

CALL TOLL-FREE FOR ORDERS, PRICE QUOTES, AND AVAILABILITY:

1-800-523-9511

IN PENNSYLVANIA, AND FOR TECHNICAL SUPPORT:

1-215-868-8219

MICROLINE:

MICROHOUSE OFFERS 24 HOUR COMPUTER SHOPPING WITH MICROLINE. MICROLINE IS A COMPUTERIZED ORDER-ENTRY SYSTEM, SIMILAR TO ACCESSING TIME-SHARING SYSTEMS. MICROLINE ENABLES YOU TO ACCESS SPECIFIC INFORMATION ON OVER 1000 MICROCOMPUTER HARDWARE AND SOFTWARE PRODUCTS, IN ADDITION TO NUMEROUS SUPPLIES AND ACCESSORIES.

MICROLINE GIVES YOU THE OPTION OF ORDERING AS MUCH AS YOU WANT, AS OFTEN AS YOU WANT. MICROHOUSE WILL PROCESS YOUR ORDER WITHIN 24 HOURS.

1-215-868-1230

MICROLINE OPERATES AT 300 BAUD, 8 BITS, NO PARITY, 1 STOP BIT.

SHIPPING:

ADD 2% TO ALL ORDERS. DIFFERENCE WILL BE CREDITED. OUTSIDE CONTINENTAL UNITED STATES ADD AN ADDITIONAL \$5.00.

ALL ITEMS SHIPPED UPS GROUND. OTHER SHIPPING METHODS AVAILABLE UPON REQUEST.

PAYMENT:

ACCEPTED PAYMENT BY PERSONAL CHECK, MONEY ORDER, C.O.D., MASTERCARD, OR VISA. PURCHASE ORDERS NEED PRIOR APPROVAL.

MICROLINE PAYMENTS BY PERSONAL CHECK, MONEY ORDER, C.O.D., MASTERCARD, OR VISA ONLY.

PENNSYLVANIA RESIDENTS ADD 6% SALES TAX.

MICROHOUSE
1444 LINDEN STREET
P.O. BOX 498
BETHLEHEM, PA 18018

PRICES AND SPECIFICATION SUBJECT TO CHANGE WITHOUT NOTICE

ALL ITEMS SUBJECT TO AVAILABILITY.

SUPERCALC is a trademark of SORCIM. VISICALC, VISIDEX, VISIPLLOT, VISITERM, VISITREND, DESKTOP PLAN, and VISIFILE are trademarks of VISICORP.

SOFTCARD, RAMCARD, TIME MANAGER, and PREMIUM SYSTEM are trademarks of MICROSOFT.

WORDSTAR, SUPERSORT, MAILMERGE, DATASTAR, SPELLSTAR, and CALCSTAR are trademarks of MICROPRO INTERNATIONAL.

dBASE II is a trademark of ASHTON-TATE.

SPELLBINDER and SPELLCHECK are trademarks of LEXISOFT.

MICROMODEM II is a trademark of HAYES MICROCOMPUTER PRODUCTS, INC.

PRISM is a trademark of INTEGRAL DATA SYSTEMS, INC.

APPLE is a registered trademark of APPLE COMPUTERS

CP/M is a registered trademark of DIGITAL RESEARCH.

The Micro Computer People

MICROHOUSE™

**SAVINGS
SUPPORT.** *plus*

SORCIM'S SuperCalc™

for the IBM® PC

\$199

How New Is Skip Sequential?

I share Jack Purdum's enthusiasm for what he calls the Skip Sequential file processing method (see "Skip Sequential: A New File Structure for Microcomputers," March 1982 BYTE, page 466). Certainly a number of BASIC programmers will realize enhanced file processing with this very simple and elegant technique. However, I want to call to the attention of both Mr. Purdum and your readers the fact that the term "skip sequential" is an existing one that has been described in computer-science and data-processing literature.

Although the technique described by Mr. Purdum is most probably new (at least as applied to microcomputers), the term "skip sequential" is most certainly not. "Skip sequential" processing is in fact one of the methods of processing an ISAM (indexed-sequential access method) file and is used in PL/I and COBOL. A discussion of this technique, explicitly referred to as "skip sequential processing," appears on page 145 in a recent book, *File and Data Base Techniques* by James Bradley (CBS Educational and Professional Publishing, 1982).

Given the above, I highly recommend that Mr. Purdum consider a new nomenclature for his technique. His use of an existing term for the technique he has described is inappropriate and will only cause confusion within the computing community and will probably result in his technique's being lost in obscurity. The new name should also better reflect the true nature of the technique, which I would classify as direct access of variable-length records. In any case, I'd be interested to see the results of his trademark search should he decide to stick with the term "skip sequential."

Michael David Stebel
UPA Technology Inc.
60 Oak Drive
Syosset, NY 11791

I had to laugh at Jack Purdum's article "Skip Sequential: A New File Structure for Microcomputers." Mr. Purdum states that his "'new' [Mr. Purdum's quotes] file structure . . . is based on such a simple idea that many computerists will wonder why they didn't think of it." Indeed. And many more will wonder why Mr. Purdum

thinks he invented an idea that has been around for over 20 years.

I have to admire the guy's brass, though. After explaining his technique (which, to give him credit, is useful and needed to be publicized), he graciously grants us permission to use it personally, but requests that we contact him before making commercial use of it. I wonder if his company, Ecosoft, has notified the legal departments at IBM, AT&T, DEC, Digital Research, the Massachusetts Institute of Technology, and the U.S. Department of Defense, to name only the more well-known organizations who have had the temerity to pirate this "invention."

In essence, Mr. Purdum has described a useful method for getting around a limitation in BASIC (i. e., the lack of an "OPEN FOR APPEND" statement) by keeping an internal copy of the end-of-file pointer. At the end of the article, he extends this idea to the more general one of keeping an index to a fully random file. Apparently he is unaware of the following:

First, the lack of an "OPEN FOR APPEND" is highly unusual, found only in BASIC and a few other special-purpose languages. "OPEN FOR APPEND" is considered essential by most operating-system designers.

Second, all operating systems keep an internal end-of-file pointer for every file; this is inherent in providing a filing system. Most modern operating systems make this pointer available by way of a system call for use in random seeks.

Third, the idea of keeping an index of pointers to records or bytes in a file, whether kept in that or another file, is also very old. Since my library goes back only 10 years, I cannot give a reference to even an early, let alone the original, description.

And finally, regardless of the originality of the idea, there is currently no legal basis in the United States for claiming any kind of ownership of a software construct, algorithm, or coding technique. Most of us decry this situation, but it is a fact. Programs can be protected by copyright (maybe) and trade secret (almost certainly, although you had better know what you are doing), but algorithms are considered to be "mathematics" (sure), and mathematics, being a naturally occurring phenomenon or "law of the universe" (hah!), cannot be patented or otherwise protected.

Oh, yes. In case you haven't guessed, I

am going to make use of Mr. Purdum's technique without asking permission; or rather, I will continue to make use of it, because I have been using it for so long that I can't remember who taught it to me. I would recommend that all other BYTE readers do likewise. If they feel ambitious, they might also write their congressmen to complain about the lack of legal protection for software, so that they will have some protection when they come up with an original idea.

Geoffrey H. Kuenning
Design Interface
216 25th St.
Manhattan Beach, CA 90266

Jack Purdum Replies

Mr. Kuenning's letter seems to raise two issues: (1) the "newness" of Skip Sequential (SS) files and (2) the right to use them. Concerning the first issue, I am aware that similar file structures are available on other, usually larger, systems either as part of a language or through system calls. Indeed, this was the reason for placing the word "new" in quotes (see the third paragraph of the article). However, as Mr. Kuenning points out, this structure is not available in any dialect of BASIC with which I am familiar. In that respect, it is a new file structure for the BASIC programmer.

Concerning the second issue, at the time the article was written (in the fall of 1980), our accounting package was the mainstay of our product line. We were concerned that SS files would be used by someone in direct competition with us. We thought that if a product was in direct competition with the accounting package, a nominal fee might be charged. By the time this letter is printed, however, we will have sold the package to another firm. We have, therefore, dropped the idea of licensing altogether.

I have had a surprising number of letters from individuals that hope to be using SS files in the near future. I am pleased that Mr. Kuenning plans to be among them.

The Base 2 Printer

I enjoyed Walter Jeffries's article "Base 2 Printer" (March 1982 BYTE, page 206).

Our "Personal" Improvement Plan

MICROBYTE Add-Ons for the IBM Personal Computer from ASAP

MICROBYTE lets your IBM Personal Computer become all that it can be with a wide variety of enhancements. We can stretch memory, increase computing ability, provide printer support, improve storage capacity and expand the overall capability of your system to reach limits you never thought possible.

With MICROBYTE and ASAP your Personal Computer has all the potential you need for a variety of applications: video games, educational use, home budget applications or business use.

All MICROBYTE add-ons are constructed of high quality components and feature gold contacts and clear solder mask. Built to MICROBYTE's rigid standards, each board is fully assembled and tested.

Choose the IBM add-ons you need for your applications. Then call ASAP today, and start your own "Personal" improvement plan.

- Expansion Chassis with 5-slot motherboard
- 256K RAM Board
- Winchester Disk Drive and Controller, 6 and 12 megabytes (specify)
- Expansion Chassis with one or two 5¼" floppy disk drives, either 48 TPI or 96 TPI, single-sided or double-sided, double-density
- 32K Serial Printer Buffer Board
- 32K Parallel Printer Buffer Board
- EPROM Board up to 32K



ASAP offers a 15-day buyer protection policy: full money-back guarantee if not totally satisfied.

Ordering Information: name, address, phone; ship by: UPS or Mail. Shipping charge: add \$2.90 up to 1 lb. (UPS blue), U.S. Mail add \$1.50 (U.S. only) (\$25.00 minimum order). **Terms:** We accept cash, check, money orders, Visa and Master Charge (U.S. funds only). Tax: 6% Calif. res., COD's and terms available on approval (School PO's Accepted).

Toll free outside California: (800) 421-7701 inside California: (213) 595-6431 (714) 891-2663

ASAP Computer Products LTD., 116 Viceroy Road., D-12 Concord, Toronto, Ontario, Canada L4K 1A9
(416) 738-0500 (800) 268-1996

Circle 33 on Inquiry card.

asap
computer
products, inc.

1198 E. Willow St., Signal Hill, CA 90806

Letters

I, as well as many other people in a club to which I belong, own one or more Base 2 printers.

Owners should be aware of two possible problems. The first can lead to repeated failures of the type experienced by Mr. Jeffries. The cause is bad bypass capacitors; Base 2 must have been unlucky enough to get a bad batch. There are two checks that can be made. First, measure the +5 volts DC with respect to ground on pin 18 of the Centronics connector (J3). If it reads low (less than +5 volts) you can suspect a bad bypass capacitor. Next check each bypass capacitor's temperature. Most owners have been able to find the bad capacitor(s) by touching each one to detect a temperature rise. One person even found one capacitor discolored.

The second problem is much less likely to happen, but you still may want to protect your investment. It occurs when one of the print-head transistors does not turn off due to failure or other reasons. It ruins the print head at a repair cost of between \$35 and \$45. The solution is to fuse each print wire solenoid. The easiest place to do this is where the print-head cable mates

to the chassis cable. A socket can be rigged at this point to accept a 14- or 16-pin header. To the header solder seven 3-amp fuses. Any miniature 3-amp fuse will do. You may also want to protect the stepper motors similarly.

If anyone has any related information they would like to share, I can be reached at the address below.

John A. McKinney
2430 Bethel Drive
Anaheim, CA 92806

In 1979 I was evaluating various printers for use with my Z80 S-100 system. At the time, no one printer was able to satisfy all my needs. Then at the '79 WESCON show in Los Angeles I came upon John Amos, then president of a small Fullerton firm named Base 2.

The product on display at WESCON was a model 800 MST printer. After reviewing the printer specifications and a demonstration, I knew that I simply had to have one of those printers. Hence, I became one of the first people to place an order for this product. The first deliveries were expected to take place in the spring

of 1980. Five months of waiting weren't that bad, since they were accepting no money until deliveries could be made.

I received my printer, S/N 474, in February 1980. After only one hour of use, the printer malfunctioned. When I returned the unit to the factory it was discovered that some of the internal fuses used to protect the print head had opened. The fuses used at that time were considerably underrated for that particular use because of power surges that occurred whenever the unit was turned on and off. Since there was little space for a larger set of fuses, a design change was made by replacing the fuses with straight pieces of wire.

Three weeks later, I was again back at the factory. This time the problem was caused by a component failure on the power-supply board. Between March and June, I made four return trips to the Base 2 factory to have various modules replaced due to component failure.

I continued to encounter problems, on and off, for the next year and a half. I had been making return trips to Base 2 on an almost regular basis. They had been very courteous and understanding of the problems I experienced; but I did not wish to be dependent upon them for continuous support. I then decided to seek a complete refund of my purchase price plus an additional \$100 incurred for printer number four.

My first attempts at obtaining a \$749 refund were met with outright hostility. I was unable to contact president John Amos or any other of the personnel whom I had dealt with previously. I even sent a letter, which was never acknowledged, requesting my \$749. I then filed for a court action against Base 2, seeking a \$749 refund plus court costs.

The court date was set for November 25, 1981. But on October 29, I received a notification of nonservice from the Orange County Marshal. Apparently, sometime during the month of November, Base 2 went out of business. What happened after that is somewhat sketchy. I was informed that contact with Base 2 could be made through Advanced Computer Products (ACP). I was further informed that only written requests for information would be acknowledged. I wrote a letter to this company but didn't receive any response. It was my feeling that perhaps the advice about contacting ACP was given to prevent people like myself from directly reaching the corporate officers of Base 2.

THE MULTI-USER FRIENDLY MEMORY BOARD WITH

NO COMPROMISE

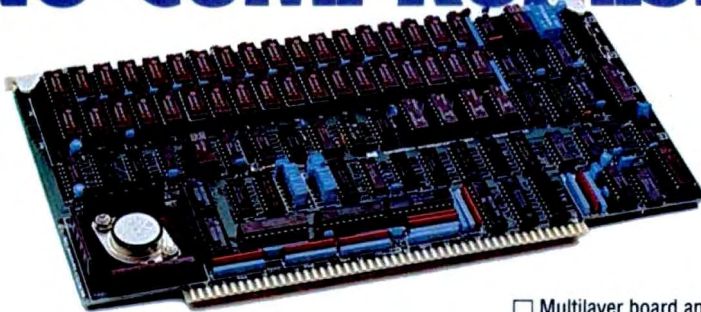

- 256 kilobytes 150 NS dynamic ram
- Designed to operate in any S-100 System IEEE or Non-IEEE
- 16-bit addressing option: Powerful Macrotech Memory Mapping (M³) bank select architecture allows each 4K block of the 16 bit (64K) logical addresses to be dynamically translated to any 4K block of the 256K on board physical memory.
- 24-bit direct addressing option

- "Educated" cycle control module generates all timing on board *asynchronously* for maximum access speed and uniform operation
- Comprehensive technical manual with complete installation guide and source listings for MP/M II™* and "Virtual Disk" solid state disk applications.
- DMA operation fully supported in strict accordance with IEEE 696 standard.
- 8/16 data transfer protocol
- Parity error detection

- Multilayer board and bus signal filtering for noise-free operation.

- Full one year warranty

If you wish, send a check or money order for \$1,379 (in California add 6% sales tax where applicable).

Manual available at \$25.00 each refundable with order.

*Registered Trademark of Digital Research Corp.
OEM & Dealer Inquiries Invited



MACROTECH International Corp.,
22133 Cohasset St., Canoga Park,
California 91303
(213) 887-5737

897 N.W. Grant Ave. • Corvallis, Oregon 97330 • 503/758-0521

THE DAWN OF A NEW ERA FOR APPLE II: THE ENHANCER II

Introducing the Enhancer II: a new Standard which is improving the relationship between Humans and Apples. The Enhancer II can help your Apple II's keyboard become more sociable by remembering words or phrases which can be entered into the Apple by the mere touch of a key. Life can become even easier because the Enhancer II can remember what you typed while your Apple was busy talking to your disc (or doing other things). Naturally, it knows the difference between upper and lower case letters and what shift keys are supposed to do. It even knows to auto repeat any key held down. The Enhancer II replaces the encoder board making installation simple.

Suggested retail price: \$149.00.

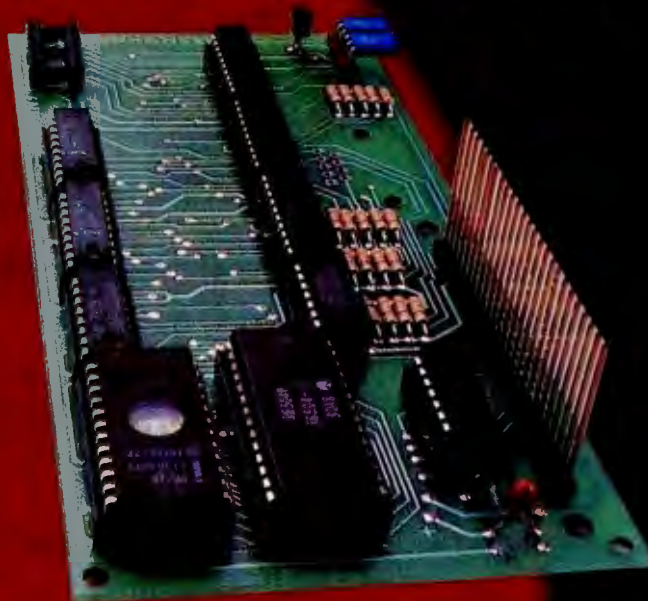

VIDEOTERM



The time tested Videoterm 80 column card:

- 80 characters x 24 lines
 - True decoders
 - 7 x 9 character resolution
 - Low power consumption
 - Compatible with most word processors
 - Softcard and CP/M compatible
 - Modem compatible
 - Most popular character set of any 80 column card
 - Alternate character fonts available
- Suggested retail price \$345.00

SOFT VIDEO SWITCH

The Soft Video Switch is an automatic version of the popular Switch-plate. It knows whether it should display 40 or 80 columns or Apple graphics. It does the tedious work of switching video-out signals so you don't have to. The Soft Video Switch can be controlled by software. Any Videoterm with Firmware 2.0 or greater may be used with the Soft Video Switch. The single wire shift mod is also supported. Package price is \$35.00.



KEYBOARD AND DISPLAY ENHANCER

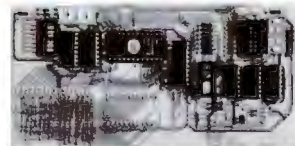

The original Keyboard and Display Enhancer is still available for Revision 0-6 Apples (on which the new Enhancer II will not fit). These Apples have memory select sockets at chip locations D1, E1 & F1. The Keyboard and Display Enhancer allows entry and display of upper & lower case letters with fully functional shift keys. It does NOT have user definable keys nor a type ahead buffer. The price is \$129.00

ACCESSORIES:

- Videoterm Utilities Disc \$37.00 (includes)
- Font Editor
 - Pascal Mid-Res Graphics
 - Applesoft Read Screen Utility
 - Top & Bottom Scrolling
 - Pascal Vidpatch
 - Graphics Template
- Character Set EPROMs \$29.00 ea
- Half Intensity
 - Inverse
 - German
 - Katakana (Japanese)
 - Line Drawing Graphics (Expanded)
 - Spanish
 - French
 - Math & Greek Symbols
 - Super & Subscript
- Dvorak EPROM (Enhancer) \$29.00
- Lower Case Chip \$29.00

IS IT A ROLLS OR A BENTLEY?

It's a Delta. The "Private Computer."

For systems integrators only, not mass merchandisers.

Whether your customer wants a single-user system or a 64-user distributed processing network, you get the same impeccable Delta quality.

As it were, only the hood ornament is different.

And Delta support is legendary. Software library, extensive factory service, engineering and software development assistance, flexible financial program.

The whole is greater than the sum of the parts.

Delta.
Value, not cost.
Look into it today.*



DELTA PRODUCTS INC.

15392 Assembly Lane, Huntington Beach, California 92649
(714) 898-1492 Telex: 681-367 DELTAR HTBH

*Request Delta's half-inch video tape promo
(specify BetaMax or VHS).

* Registered Trademark of Rolls-Royce, Ltd

Circle 132 on Inquiry card.

Letters

What has happened since? Well, immediately afterwards I bought an Epson MX-80 F/T. It has performed flawlessly and looks a lot better too. The Base 2 printer sits on a shelf gathering dust. One of these days I hope to repair it when I have the time. My co-workers at Rockwell occasionally rib me and ask if I've found John Amos yet or if my Epson still works.

Base 2 really had a good idea for what a printer should be. Too bad it didn't work.

Victor Ung
1980 Magnolia Drive
Monterey Park, CA 91754

I read with great interest Walter Jeffries's very well done review of the Base 2 printer. Unfortunately, Base 2 is no longer in business. I discovered this fact when I had trouble with my printer.

I realized that I was not the only one that might need service, so I located the management of Base 2 and made arrangements with them to provide service on the Base 2 printers. We were fortunate enough to locate some of Base 2's former technical staff who trained our engineers

in every aspect of the printer, including sources for all parts, ribbons, tractor assemblies, cases, boxes, and so forth.

We understand that there are several thousand Base 2 printers in the field and eventually some of them will need service. We at Computer Peripheral Repair are prepared to provide prompt service and/or spare parts at a reasonable cost.

I appreciate the near disaster the author had with the shorted rectifier. To prevent this in the future, try lifting the rectifiers off the printed-circuit board about an eighth of an inch to allow the air to circulate around them and keep them cool. We have found that keeping the rectifiers cool will prevent them from shorting out and blowing fuses. If the fuse does not react quickly enough you will certainly burn out your print head. The print heads are expensive, but we have found that we can usually repair them at a fraction of the cost of a new one.

Thomas B. Torrence
Customer Service
Computer Peripheral Repair
1483 East Warner Ave.
Santa Ana, CA 92705

Infernal Documentation

There are three rings in hell reserved for the writers of computer documentation.

Ring One is for people who use names like "FILE.TXT" in examples. Angels, of course, use names like "FRODO.TXT" so that the novice is never confused between key words and arbitrarily chosen names.

Ring Two is reserved for people who document some 200 commands and 20 subcommands of a word processor without a single worked example or without showing how the commands interface to any other popular hardware or software. Angels provide a few *complete* (from logon to logoff) annotated examples showing the most commonly used command *sequences*. Archangels provide source listings.

Ring Three is for people who fail to proofread the documentation. Angels use word processors to avoid transcription errors. They print the documentation *without* proportional spacing so that it is abundantly clear if "PR #1" is or is not supposed to have a space between the "R" and the "#." They lovingly select a print element that makes a dramatic distinction

Mountain Computer Presents The Hard Disk System with Dynamic File Allocation

Long before you are out of space
on our system, other disk systems
will have given up!

The DYNAMIC 5M Disk System™ with—
The Mountain Virtual File System (MVFS)™
software:

- Uses dynamic file allocation which automatically consumes file space only when needed, not when initialized.
- Makes available up to 50% more disk space than competitive units and uses no extra memory space.
- Allows large files, up to 5 MBytes for database applications in CP/M and Pascal.
- Supports DOS, CP/M, & PASCAL for Apple II and MS DOS & CP/M 86 for the IBM Personal Computer.

QUALITY — The Mountain Computer reputation for quality peripherals combined with a one year warranty.

RELIABILITY — The dependable disk system from a leading supplier of personal computer peripherals, with a service organization to support it.

**DYNAMIC 5M Disk System™...
for the Apple II and the IBM PC.**
(available soon for other systems)

(Includes everything you need: disk controller, power supply, interface card, cabinet, cabling, and the Mountain Virtual File System software)

See your local computer store for
this and other innovative
Mountain Computer Products



Mountain Computer
INCORPORATED

300 El Pueblo Rd. Scotts Valley, CA 95066
TWX: 910 598-4504 (408) 438-6650

Quality and Performance,
at an affordable price — \$2,695.

Letters

between the letter "O" and the digit "0." They are very careful to distinguish between the ASCII (American Standard Code for Information Interchange) character for the digit zero and the binary number zero.

Roedy Green
1478 East 27th Ave.
Vancouver, B.C.
V5N 2W5 Canada

Update on VEDIT

The same week that I received the March 1982 BYTE containing my review "Text Editing With Compuview's VEDIT" (page 262), I received an update of VEDIT, version 1.34. Two improvements may be of interest to readers of my review: (1) you now *can* send text to your printer from within VEDIT (and a lot more easily than you can from Wordstar); (2) word-wrap and paragraph-reformatting have been added, which make VEDIT better suited for word processing. In my opinion, VEDIT's worst remaining drawback in word-processing applications is the awkward procedure for inserting control characters.

Compuview has added a lot in going from version 1.32 to 1.34. I wonder what version 2.00 will have.

Oh, and many thanks for Phil Lemmons's review "Five Spelling-Correction Programs for CP/M-Based Systems" (November 1981 BYTE, page 434). I bought The Word as a result, and it is everything Phil said it was.

Brad Thompson
Department of Chemistry
University of Toledo
Toledo, OH 43606

Service Above and Beyond the Call of Duty

Integral Data Systems (IDS) and the printers it manufactures were prominent in the March 1982 BYTE (see Curtis P. Feigel's "BYTE Printer Directory," page 278, and Ed Umlor's "Integral Data Systems' Prism Printer," page 44), and rightly so. One aspect of IDS worth emphasizing is the quality of its customer support. In my experience, IDS goes beyond providing knowledgeable and courteous telephone assistance, as the following anecdote illustrates.

In developing a complex graphics application, we couldn't figure out the source of mysterious extra graphics characters embedded in our printouts. Mr. Tom Churlis of IDS suggested that we check for self-generated characters from the interface card. Sure enough, the card automatically issues a carriage return after a certain number of characters is transmitted, and in the graphics mode the carriage return is recognized and printed only as a pattern of dots.

Although the company's hardware was not to blame and its manual was thorough, IDS has always been courteous and helpful. In fact, Mr. Churlis even called me back to see how my project was going. I have contacted IDS on several occasions and have always been gratified by a competent and polite response.

IDS is not the only company that staffs its phones with truly competent personnel. The people I've dealt with at Lazer Micro Systems Inc. are both knowledgeable and reliable; at Videx Inc., a competitor of Lazer Micro Systems, someone once copied and mailed information to me at no charge, even though I could have been sold a much more expensive solution.

If there is a hall of fame for outstanding customer support, these companies get my vote.

Peter G. Bartlett, Jr.
Bartco
529 West Belden Ave.
Chicago, IL 60614

Descenders for the MX-70

I was very excited to see Bruce Piggott's article "Lowercase Descenders for the Epson MX-70" in the March 1982 BYTE (page 248) on getting the MX-70 to print lowercase descenders. My enthusiasm quickly subsided, however, when I found that the program was for Apple users only. I have a TRS-80 connected to an MX-70, and I use Scripsit extensively.

Do you or any of your readers have any leads on any programs similar to Mr. Piggott's program that can be used with the TRS-80/MX-70 combination? I would certainly appreciate any help you can give me.

Kenneth Knael
733 Sligo Ave., Apt. 316
Silver Spring, MD 20910

The Context MBA is available now at the leading personal computer retailers listed below:

California

ComputerLand/Almaden 408/267-2182
ComputerLand/Belmont 415/595-4232
ComputerLand/Burlingame 415/348-7731
ComputerLand/El Cerrito 415/527-8844
ComputerLand/Pasadena 213/449-3205
ComputerLand/San Diego 714/560-9912
ComputerLand/San Diego East 714/464-5656
ComputerLand/San Diego North 714/434-7001
ComputerLand/San Fernando Valley 213/716-7714
ComputerLand/Sonoma 707/528-1775
ComputerLand/South Bay 213/371-7144
ComputerLand/Thousand Oaks 805/495-3554
ComputerLand/Ventura 805/656-7711
ComputerLand/West Covina 213/960-6351
ComputerLand/West Los Angeles 213/559-3353

Connecticut

ComputerLand/Danbury 203/748-2300
ComputerLand/Fairfield 203/255-9252
ComputerLand/Hartford 203/561-1446
ComputerLand/New Haven 203/288-5162
ComputerLand/Stamford 203/964-1224

Delaware

ComputerLand/New Castle County 302/738-9656

Illinois

ComputerLand/Arlington Heights 312/870-7500
ComputerLand/Downers Grove 312/964-7762
ComputerLand/Joliet 815/741-3303
ComputerLand/Lake County 312/949-1300
ComputerLand/Naperville 312/369-3511
ComputerLand/Niles 312/967-1714
ComputerLand/Northbrook 312/272-4703
ComputerLand/Oak Lawn 312/422-8080
ComputerLand/Schaumburg 312/843-7740

Massachusetts

Business Data Systems/Hanover 617/878-7888

Minnesota

ComputerLand/Bloomington 612/884-1474
ComputerLand/Hopkins 612/933-8822
ComputerLand/Minneapolis 612/333-3151

New Jersey

ComputerLand/Morristown 201/539-4077
ComputerLand/Princeton 609/882-1400

New York

ComputerLand/Nassau County 516/742-2262
ComputerLand/Suffolk County 516/499-4484
Merris Decision Systems/New York 212/742-9590
Super Business Machines/New York 212/943-4130

Oregon

ComputerLand/Multnomah County 503/295-1928
ComputerLand/Salem 503/620-6170
ComputerLand/Portland 503/620-6170

Pennsylvania

ComputerLand/Dresher 215/542-8835
ComputerLand/Harrisburg 717/763-1116
ComputerLand/Paoli 215/296-0210
ComputerLand/Philadelphia

Texas

ComputerLand/Dallas 214/363-2223
ComputerLand/Fort Worth 817/292-7114
ComputerLand/Houston Bay Area 713/488-8153
ComputerLand/North Dallas 214/235-1285
ComputerLand/Southwest Houston 713/977-0909
ComputerLand/Westwood 713/270-1200

Virginia

ComputerLand/Richmond 804/741-3502
ComputerLand/Tyson's Corner 703/893-0424
ComputerLand/Woodbridge 703/491-4151

Washington

ComputerLand/Bellevue 206/746-2070
ComputerLand/Federal Way 206/838-9363
ComputerLand/Lynnwood 206/774-6993
ComputerLand/Renton 206/271-8585
ComputerLand/Seattle 206/223-1075
ComputerLand/Tacoma 206/383-4951
ComputerLand/Vancouver 206/695-1540

Washington, DC

ComputerLand/Washington, DC 202/835-2200

THE CONTEXT MBA: IT PUTS ADVANCED BUSINESS SCHOOL TECHNIQUES TO WORK FOR YOU TODAY.

Will The Personal Computer Revolution Leave You Behind?

You've read all the stories about how personal computers are going to revolutionize the way you work. The stories are true. But until now, you had to be a computer expert to exploit this amazingly powerful new tool.

The Context MBA is a remarkable new software program that lets any manager utilize advanced business techniques. All you need is an IBM Personal Computer.

A Complete Set of Management Tools.

Some of the computer programs available today can help you in one phase or another of your job. But only the Context MBA combines five powerful functions into one easy-to-use system.

You start with a giant electronic spreadsheet for your projections, budgets and models. You can ask "what if" questions simply by changing one number—every effected item is instantly recalculated.

Want a chart to summarize your results? The graphics feature gives it to you with a few keystrokes. And—unlike any other program—C-MBA automatically revises your charts to reflect changes you make in the spreadsheet numbers.

C-MBA's database saves information in a vast electronic library for near instant recall.

Still another unique feature is the ability to access other computers and data banks. It's a simple matter to tap into your company data center, a financial information service, or electronic mail system. The data you need goes directly where you need it, without tedious re-typing.*

Finally, the C-MBA's executive word processing capability lets you assemble text and figures into neat, error-free reports—without the hazards of typing and transcription errors. You can actually revise a document yourself faster than you can explain the changes to your secretary.

Synergy in Software

By itself, each of the Context MBA's functions would be a significant productivity booster. But it's only when all these capabilities are combined—with a simple, consistent set of commands—that you will begin to appreciate the true power at your

fingertips. With just a bit of practice, you'll be accomplishing in hours what used to take days.

The Context MBA is sold only by selected computer retailers who have completed special training courses to help managers get the most from the program.

Personal Computers Are Full of Promise. Context Makes Them Deliver.

IBM is a trade mark of IBM. *Version 1 of the C-MBA will not include communications. Version 1 owners will receive a free upgrade to version 2 which will include communications. The MBA is currently available for the IBM Personal Computer. Versions for other second generation personal computers are under development.

Context

Management Software for Personal Computers

23864 Hawthorne Boulevard
Torrance, CA 90505

(213) 378-8277

Telex 181149 WEST LSA

Source ID TCA442

© Copyright 1982 Context Management Systems.

Circle 114 on inquiry card.



Thank You, Mr. Heldner

After all the uproar about software piracy in the past few months, I just had to write you. I am selling an operating system called HEXDOS for the Ohio Scientific Inc. C1P computer, and I recently received a letter from Mr. Vern Heidner of Mound, Minnesota, which restored my faith in the basic honesty of the majority of computerists. It seems a friend had given him a copy of HEXDOS, which he liked and kept. He sent me a check in payment for it, though I would probably never have known he had it. He

also sent a two-page letter describing some of his applications and some suggestions. Thank you, Mr. Heidner, and pirate prosecutors take note!

Steve Hendrix
415 South Pierce
Enid, OK 73701

Turn the Tables

The review of RSCOBOL in the March 1982 BYTE ("COBOL for the TRS-80 Models I and III" by Rowland Archer Jr.,

page 384) was very complete and well written. You have, however, switched the descriptions of table 1 and table 2. The files in table 1 are required during run time and for debugging and do not have to be online during program compilation. The files listed in table 2 must be online during compilation. Conversely, the files in table 2 do not have to be online during program execution, but they do have to be online during program compilation, since they represent the compiler and its overlays.

Mr. Archer also failed to mention what I consider the most outstanding quality of the compiler—it works as advertised. Ryan-McFarland Corporation has done an outstanding job of creating a piece of systems software that is not full of bugs, that is well documented, and that does what it says it does. I run RM COBOL (from which RSCOBOL was derived) on a CP/M system every day and I have yet to find an error in it. As a producer of high-quality software for manufacturing firms, I cannot afford the time to debug someone else's product. Of the three COBOL compilers I own, only one of them works reliably. The other two will remain unnamed.

I hope to see more reviews and samples of COBOL software in the pages of BYTE in the coming months. I have been using it for more than 16 years and I still find it to be the most useful of all languages for business-oriented applications. It may not be esoteric but it does the job and that's what counts.

Roger S. Erickson, President
Nordic Systems
23 Carriage Hill West
Williamsville, NY 14221

As a long-time proponent of COBOL and a recent convert to Radio Shack's TRS-80 Model III, I was pleased to find Rowland Archer Jr.'s software review of RSCOBOL. Unfortunately, Mr. Archer did a grave injustice to a magnificent software product.

The overall negative tone of the article obviously reflects Mr. Archer's lack of experience with COBOL and his narrow exposure to microcomputers.

BYTE's choice of article highlights was poor. How detracting is a non-full-screen editor compared to the powerful global Find and Change commands available in CEDIT? How many minicomputer, or for that matter, large-computer systems provide for compiler output listings to be routed to disk, printer, or screen? What

★ ★ ★ FEATURING 8 and 16 BIT S-100 SYSTEMS ★ ★ ★

WE OFFER A WIDE RANGE OF CRTs, PRINTERS, GRAPHICS EQUIPMENT, SOFTWARE FOR ALL SYSTEMS. EACH SYSTEM IS COMPLETELY TESTED, INTEGRATED AND READY FOR PLUG-IN OPERATION WHEN YOU RECEIVE IT. WE TAILOR & CONFIGURE SYSTEMS TO MEET YOUR BUDGET AND NEEDS. WE WELCOME YOUR REQUEST FOR TECHNICAL INFO BY PHONE OR LETTER.

GRAPHICS SYSTEM: Architects • Designers • Engineers • Create & store own designs. Create arrays. Zoom, windows. Completely interactive. Easy to edit. Powerful and fast. Package includes software + MicroAngelo Graphics Subsystem + M9900 16 bit, S-100 w/dual 8" floppies, + HI PAD Digitizer + Plotter \$10,200.

CROMEMCO: New dual processor 6800/Z80 systems w/256K-512K memory.
SYSTEM I: Z80 system with 5MB hard disk \$5,246.
SYSTEM I: W/O hard disk \$2,996. Cromix multi-user systems starting at \$4,713.
High resolution color graphics hard disk system Model Z2HGS \$10,875.

NEW SYSTEMS FROM IMS 2 yr. warranty on boards! SX systems w/8" or 5 1/4" drives, optional 10, 20 or 40MB Winchester, built-in tape back-up, multi-user capability (TURBODOS or MP/M). Z-80, S-100 bus. On site service for NY tri-state area.

SEATTLE 8086 SYSTEMS Featuring 86-DOS, the IBM PC Operating System.
System I: 8MHZ CPU set w/1 serial, 1 parallel I/O (additional I/O option) 64KB 16 bit Static RAM, Tarbell DD controller, TEI 22 slot mainframe w/constant voltage transformer \$2,695 System II: with 128K Static RAM \$3,550.
Interfaced to dual Shugarts 801 \$1,275. or dual QUME DT-8 \$1,680.

CALIFORNIA COMPUTER SYSTEMS 2210A High quality, low price. Z80 CPU, 1 serial port, disk controller w/CP/M 2.2 64K RAM \$1,775.
Add our Max Box w/dual Shugarts or Qumes and IMS I/O w/2 serial, 1 parallel.

LOMAS DATA 8086 SYSTEM: Complete Lomas card set in TEI 12 slot mainframe, 86-DOS, dual Shugart 801s, Televideo 912, assembled & tested \$4,599. Options: 8087 add \$600; 8089 add \$100.

GODBOUT: New CPU 86/87 includes Intel 80130 operating system firmware w/iRMX Kernel. Complete GODBOUT line at discount prices.

MAX BOX DISK DRIVE SUBSYSTEM mfg by John D. Owens Assoc. Dual drive cabinet w/regulated power supply, fan, complete internal cabling. Will hold Shugarts, Qumes, Tandons and/or 8" Winchester, horizontally mounted. Excellent design and engineering. 17 1/2 x 5 1/2 x 22. Attractive buff color.
W/2 Shugart 801 \$1,275 W/2 QUME DT-8 dble sided drives \$1,680.

TURBODOS: Spectacularly FAST CP/M® Compatible Multi-user Operating System. Cuts link/edit time in half. Z80 Code interrupt driven. Up to 6X faster than CP/M; up to 35% increased disk capacity. Available for NorthStar, IMS, TRS-80 Model II, CCS 2210A & Tarbell controllers.

Prices subject to change without notice Write or call for free catalogue

JOHN D. OWENS Associates, Inc.
12 Schubert Street, Staten Island, New York 10305
212 448-6283 212 448-2913 212 448-6298

are the true trade-offs to ISAM (indexed-sequential access method) files? What about the power of inter-program communications, program segmentation, run-time speed, source-code protection, and portability of application software?

Ryan-McFarland Corporation's RS-COBOL is a superior development system for the TRS-80. Although it is not a 100 percent implementation of the ANSI X3.23-1974 COBOL Standard, it is a major step in bringing quality mainframe software to the microcomputer. The \$199 price is probably the best buy on the market today. By comparison, COBOL for the Apple II costs close to \$1000 (five times as much) when you add the price of the software and the necessary add-on Z80-processor hardware (the Microsoft Softcard).

Our company, C.O.P.E., is presently marketing an accounts-receivable and billing system written entirely in RSCOBOL. A pharmacy management system will be completed shortly. Contrary to Mr. Archer's article, both systems utilize disk space very well. The use of computational fields (COMP-3) and intelligent choices of file accesses take full advantage of the two 5¼-inch disk drives the systems were designed for. I challenge any other language to maintain over 1500 customer records on one floppy disk with multiple access through ISAM organization, thus eliminating the need to sort.

Ronald Pokorny, President
C.O.P.E.
POB 227
Cooperstown, NY 13326

Learning from Pascal

My contact with computers started with solving hyperbolic partial differential equations on the ENIAC computer in 1945. Since then I have been involved with many programming languages. Now retired, I have an Apple II with a Corvus hard disk. Being a novice with Pascal, I decided to put the timely Pascal programs in the February 1982 BYTE into my Apple as a learning exercise (see Edward Heyman's "FIT—A Federal Income Tax Program in UCSD Pascal," page 148, and Thomas E. Doyle's "Pascal NOW, Let Pascal Balance your NOW Account," page 290).

From Heyman's tax program I found that Pascal is somewhat wordy. The program to handle three of the 57 IRS tax

forms took 60 pages of listings when I included the cross-reference listings. I expect it will be a useful program for the reasons he mentions.

From Doyle's NOW account check-book balancer I learned several things. First I discovered that Pascal (at least Apple Pascal) has a data-entry flaw. READ and READLN for integers and real numbers produce fatal errors which cause the system to reboot and lose your check-book file. There is an 'IORESULT' defined but the following sequence does not work:

```
REPEAT
```

```
WRITELN(ITEMNUMBER);
READLN ITEMNUMBER
UNTIL IORESULT=0
```

After studying the way Heyman handled this problem I wrote two procedures, INTGR(I:INTEGER) and REALE (R:REAL), which read in a string, examine the characters to ensure that they are indeed digits, and then generate the desired integer or real. If an error was contained in the string it forgives and allows you to reenter the string. While I was making these changes to make data entry I also changed the program to (1) put balance amount in the record, (2) allow a choice

★ ★ ★ SYSTEMS INTEGRATION SPECIALISTS ★ ★ ★	
HOUSTON INSTRUMENTS PLOTTERS Standard & Intelligent models w/surface areas of 8½" x 11" to 11" x 17". Front panel electronic controls. DMP-2 ... \$ 935. DMP-3 ... \$1,195. DMP-4 ... \$1,295. DMP-5 ... \$1,455. DMP-6 ... \$1,685. DMP-7 ... \$1,865.	IBM PC USERS BABY BLUE: Z-80B, 64K RAM substitutes for IBM memory card in IBM PC. Will run Z80, CP/M [®] software ... \$600. w/Wordstar & Mail Merge totally configured for IBM keyboard ... \$980.
HAYES MICRO MODEM 100 ... \$359. Smartmodem. \$251. Chronograph. \$224.	SEATTLE COMPUTER RAM PLUS 64K RAM + BD \$418. 128K RAM + BD \$594. 192K RAM + BD \$770. 256K RAM + BD \$942. 64K Chip Kit \$176. Each RAM card has an RS232 serial port which uses IBM supplied software.
EPSON MX 80 \$475. MX80 FT .. \$575. MX 100 .. \$725. RS232 .. \$ 70. 2K BUFFER .. \$140.	8080/8086 EMULATOR runs CP/M [®] on IBM PC. All I/O runs at operating system speed \$200.
PER SCI: Model 299B & 277 with or without cabinet & power supply.	3M SCOTCH DISKETTES FOR IBM PC 744 ss/sd \$ 26.
TELETYPE MODEL 45 Cluster controllers, terminals, printers. IBM 3270 compatible; Bisync or SNA/SDLC protocol. Up to 32 devices on one cluster at 9600 baud. Cost effective! Fast delivery!	TELEVIDEO 950 \$980. 3 pg. memory upgrade \$150.
TEI MAINFRAMES, S-100 MCS 112 ... \$620. MCS 122 ... \$745. RM 12 ... \$655. RM 22 \$790. OEM & Qty. discounts offered	MICROANGELO GRAPHICS SUBSYSTEM W/LIGHT PEN ... \$2,300. Without light pen \$1,930. Graphics card alone \$ 975. Screenware Pak II or TEKEM ... \$ 350. Color systems from 4 to 256 colors. Basic color system (4 colors) .. \$2,330.
TARBELL Z80 CPU \$395. New I/O card 4S + 2P \$347. Double Density Controller \$435.	IDS PRISM COLOR PRINTER .. \$1,795. Enhanced 560 w/software selectable colors; high speed printing at 200cps.
PMMI S-100 Modem \$385. Compatible w/telex & Twx. 51 to 600 baud. On board pulse dialer.	KONAN SMC-100 hard disk controller. S-100, 2400MB control \$1,469.
NEW ITEMS AVAILABLE Summagraphics Bit Pads • ALTOS systems • Microline printers • PIICEON	COMMUNICATIONS SOFTWARE Micro to terminal to micro to mainframe to modem. HAWKEYE GRAFIX Source Code . \$500. Object Code . \$75.
CORVUS HARD DISK SYSTEMS 6.7MB ... \$3,005. 11.3MB ... \$4,655. 20.5MB \$5,595. For S-100 and most other systems.	dbASEII demo package \$ 75. dbASE complete software \$595.
TELETYPE Model 4320 AAK \$1,140. Model 43ASR, 8 level, 1" tape .. \$2,595.	MICROSOFT/MICROPRO SOFTWARE
MEMORY MERCHANT 64K RAM \$716.	
WE EXPORT Overseas Callers: TWX 710 588 2844 Phone 212 448-6298 or Cable: OWENSASSOC	
JOHN D. OWENS Associates, Inc. SEE OUR AD ON FACING PAGE	

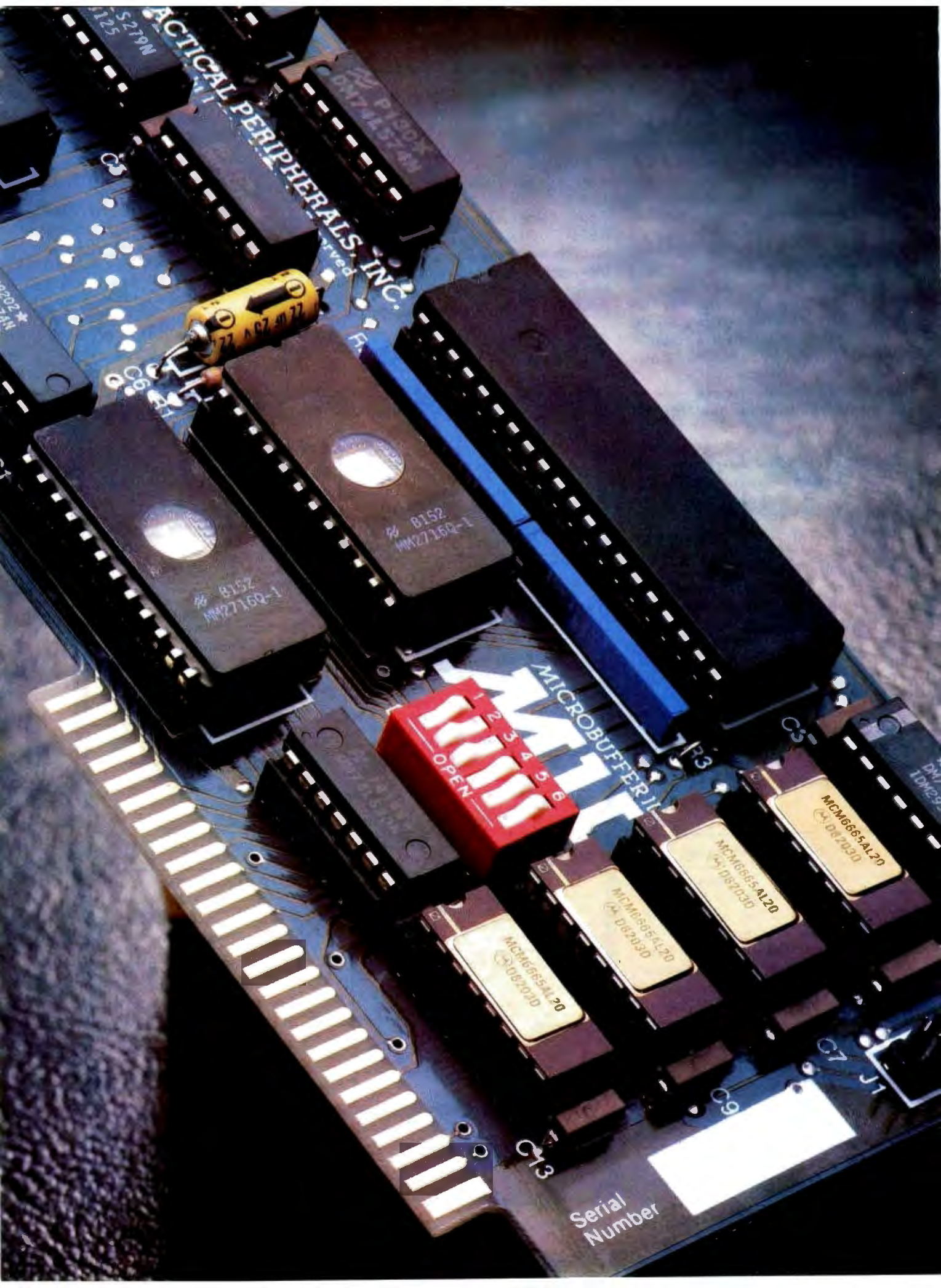

ACTUAL PERIPHERALS, INC.

8152
MM2716Q-1

MICROBUFFER II

1 2 3 4 5 6
OPEN

MCM6865AL20
DS2D3D

Serial Number

INTRODUCING MICROBUFFER.

NOW YOU CAN USE YOUR PRINTER WITHOUT WASTING COMPUTER TIME.

As you know, your computer drives your printer. And when it's performing this function, you can't use it for anything else.

A program that takes fifteen minutes to print makes you wait fifteen minutes before you can compute again. And if it takes two hours to print, you wait two hours.

A waste of valuable time.

THE NEW MICROBUFFER™ INCREASES YOUR EFFICIENCY.

Microbuffer allows you to print and process simultaneously. No waiting!

MICROBUFFER ACCEPTS PRINTING DATA AS FAST AS YOUR COMPUTER CAN SEND IT.

Microbuffer first stores the data in its own memory buffer and then takes control of your printer. This frees the computer for more productive functions.

Additional output may be dumped to the buffer at any time and it will be printed in turn.

MICROBUFFER WILL SPEED UP ANY PROGRAM THAT REQUIRES PRINTING.

The full line of Microbuffers is designed to accommodate virtually any computer/printer combination.

Microbuffers are available in Centronics-compatible parallel or RS-232C serial versions.

FOR APPLE II COMPUTERS, Microbuffer II features on-board firmware for text formatting and advanced graphics dump routines. Both serial and parallel versions have very low power consumption. Special functions include Basic listing formatter, self-test, buffer zap, and transparent and maintain modes. The 16K model is priced at \$259 and the 32K, at \$299.

FOR EPSON PRINTERS, Microbuffer starts at \$159 in either an 8K serial or a 16K parallel version. The serial buffer supports both hardware handshaking and XON-XOFF/ETX-ACK software handshaking at baud rates up to 19,200. Both Epson interfaces are compatible with all Epson commands including GRAFTRAX-80. Both are user-expandable to 32K.

ALL OTHER COMPUTER/PRINTER COMBINATIONS are served by the in-line, stand-alone Microbuffers.

Both serial and parallel versions are expandable up to 256K. The serial stand-alone will support different input and output baud rates and handshake protocol. The 32K model starts at \$299, 64K for \$349. 64K add-ons for up to a total of 256K are just \$179.00.

SIMPLE TO INSTALL.

Microbuffer II, being slot-independent, will fit into any slot directly inside the Apple except zero.

Microbuffer for your Epson mounts easily in the existing auxiliary slot directly inside the Epson printer.

The stand-alone Microbuffer is installed in-line between virtually any computer and any printer.

MICROBUFFER FROM PRACTICAL PERIPHERALS.

When you think of how much time Microbuffer will save, can you afford to *not* have one?

PRACTICAL PERIPHERALS, INC.™
31245 LA BAYA DRIVE
WESTLAKE VILLAGE, CA 91362
(213) 991-8200

THINK. BUY SMART.

YOU SAVE WHEN WE BUY FOR YOU...

It's that simple! Our fee is one-fourth of your savings off list price, and it's still a better deal than mail order. Why?

- Better prices
- Exporting
- Leasing
- Full service and support
- Access to 500 manufacturers
- Assembly integration, testing

Sample prices paid by our clients (including fee) are:

COMPUTERS

Adds Multivision	\$ 3,075.00	IBM Personal comp.	CALL
Adds Multivision I	3,074.00	Seattle boards	CALL
Alpha Micro 1030	12,047.00	IBC Cadet	4,211.00
Alpha Micro 1051	17,634.00	Micromation	CALL
Alspa AC1-2/SS	2,320.00	NEC 8001A	750.00
Altos 8000-02	2,629.00	NEC 8012A	490.00
Altos 8000-10	6,295.00	NEC 8031A	750.00
Altos 8000-15	3,585.00	NorthStar Advantage	2895.00
Altos 8600-10	7,586.00	NorthStar Adv. HD 5	4,995.00
Altos Series 5-15D	2,182.00	NorthStar Hor 64K QD	2,650.00
Altos Series 5-5D	4,372.00	Onyx 5001 MU-6	7,350.00
Apple 2 + 48K	1,208.00	Onyx 8000 MU-10	7,900.00
BMC 20 B	5,422.00	Osborne	CALL
CCS Series 300-1A	4,414.00	Sanyo 2000	2,708.00
Columbia Data	CALL	Seattle System 2	3,251.00
Cromenco System 0	3,200.00	Televideo TS-802	2,600.00
Cromenco System 1	2,946.00	Televideo TS-802H	4,550.00
Cromenco System 2	3,400.00	Televideo TS-806	5,100.00
DEC VT-180xx	3,344.00	Vector 2600	4,221.00
Dual	12,636.00	Vector 3005	5,495.00
Dynabyte	26% OFF	Vector 5005	7,308.00
Eagle II	3,796.00	Xerox 820 8"	2,995.00

PRINTERS

Amperex GP 300	3,695.00	NEC 3510	CALL
Brother, parallel	853.00	NEC 7710 R/0	2,325.00
C. Itoh F-10, daisy	1,400.00	NEC 7720 KSR	2,685.00
C. Itoh Comet II, dot	799.00	Olivetti 231	2,104.00
Diablo 630, daisy	2,098.00	Qume 9/45	2,045.00
IDS 560/G	995.00	Smith Corona TP-1	681.00
IDS Prism 80	744.00	Sellem 1, 16K + trac.	2,595.00
IDS Prism 132 column	1,430.00	Tally	CALL

DISK DRIVES, MODEMS, ETC.

Amdek Color II term.	740.00	Houston Instr. DMP-2	1,147.00
A-J 1256 modem	641.00	Houston Instr. DMP-4	1,460.00
Corvus 10 meg H.D.	3,825.00	Houston Instr. DMP-7	2,077.00
DEC VT-100 terminal	1,390.00	Morrow 20 meg H.D.	3,650.00

Call Toll Free 800-227-2288

In California (415) 376-9020

Ask about our Leasing Program. We are buying agents for overseas computer dealers and distributors.

EXPORT SERVICES available.

International Telex 470851

Mastercard, VISA at 3% handling fee. Prices subject to change without notice. Minimum fee \$150. 15% restocking charge.

THE PURCHASING AGENT

1635 School Street, Suite 101, Moraga, CA 94556

Letters

between displaying the checks on the monitor or printer, and (3) permit modifying any quantity on any check.

Any reader interested in this modification of Mr. Doyle's program can send me an Apple 5¼-inch disk and a stamped self-addressed envelope and I will send him or her a copy.

R. F. Clippinger

57 Rockview St.

Jamaica Plain, MA 02130

More on Apple Pascal Units

Dr. Ross Tonkens's "A Guided Tour of Apple Pascal Units and Libraries" (February 1982 BYTE, page 225) has highlighted an elegant method of breaking down logically separate modules into physically separate "units." However, he did not mention the drawbacks and obscurities of units in UCSD Pascal.

UCSD Pascal units consist of an interface, an implementation, and an initialization part. Objects declared in the interface are global, just as if they had been declared in the host program. Objects declared in the implementation part are hidden from the host program; they are "private" to the unit. Private variables can be initialized by the initialization part; this happens at run time, *before* the host program is executed.

A good question is whether those peculiar "private" variables retain their initial value even if the unit containing them is *not* referenced. In Pascal, local variables and parameters are lost whenever the function or procedure containing them is exited. Thus one cannot expect a local variable to have the same value when the same procedure is called several times. In units, however, one can. Private variables are not removed from the stack, even if a unit is not active. This is a FORTRAN-like "feature," which clearly violates the spirit of Pascal and wastes space. The Apple Pascal compiler, however, is smart enough to detect variables which are declared in the implementation part but referenced nowhere. For such variables no space is allocated.

While private variables may be regarded as just obscure, the missing symmetry between the host program and its units can turn out to be a serious drawback to top-down program development. Units can be compiled without their host

PICK A WINNER

Be Picky. Get Economy, Quality, Flexibility and Compatibility from Board Level Products to Complete Multi-User Computer Systems.

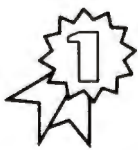

Bank Selectable S-100 128K Memory. Systems Group's new 128K dynamic memory board has eight independent

16K software selectable memory banks, each addressable on any 16K boundary. It's jumper selectable so you're not PROM locked in to any one configuration. And with more advanced features, it's the most flexible in the industry.



Fully Compatible — S-100 Boards. Use any of Systems Group's bank select memory boards for Alpha

Micro, Cromemco/CROMIX, Dynabyte, North Star, MP/M, OASIS and most other S-100 systems. Other high quality S-100 microcomputer boards include the newest high performance single and multi-user Z80 CPU board with up to 4 serial I/O's, floppy and hard disk controllers with a super CP/M and much more. All fully burned in and tested.



Eight-Inch Add-On Floppy Disk, Hard Disk, and Tape Drive Subsystems. This series was created to

provide a full range of mass storage products to complement the System 2800 computers. The subsystems also offer universal systems expansion to the users of other S-100 systems.

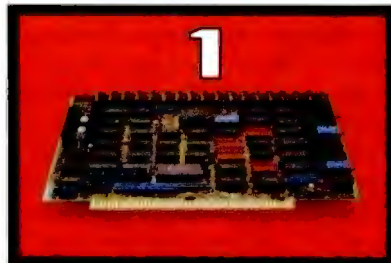

Series 2800 Business Computers. Systems Group offers a choice of expandable systems with dual floppies (up to 2.4M Bytes) or hard disk (up to 40M Bytes) w/ floppy (1.2M Bytes) or tape (20M Bytes) for back-up.



Expandability. Add-on memory, I/O and drive subsystems means never being trapped into systems without flexibility. With Systems Group's reliable designs you can add more floppy and hard disk drives or tape back-up for increasing mass storage requirements. Add more memory and I/O for up to 12 independent users per system. Choose from super CP/M, MP/M II, or OASIS operating systems.

Come to Systems Group for any of your microcomputer needs. Everything from our new 128K Memory Board to complete systems. We're helping make computers what they should have been in the first place.

All Systems Group's products are warranted for one year. Ask about our 30 day dealer/OEM evaluation policy.

CP/M and MP/M are Registered Trademarks of Digital Research. OASIS is a Trademark of Phase One Systems, Inc.

Systems Group

A Division of MEASUREMENT systems & controls incorporated
1601 Orangewood Avenue
Orange, California 92668, (714) 633-4460
TWX/TELEX 910 593 1350 SYSTEMGRP ORGE

program, but the host program cannot be compiled without the units it uses. The reason for this is that all objects declared in the interface of a unit are *simultaneously* part of the global declaration part of the host program.

Let us imagine a unit containing functions and procedures which expect variables of type COLOR = (GREEN, YELLOW, RED) as input. Then the type COLOR has to be declared in the unit's interface part; otherwise the unit will not compile, due to an "UNDECLARED IDENTIFIER" error.

A host program which uses this unit must not declare the type COLOR; otherwise compilation will stop with the error message "IDENTIFIER DECLARED TWICE." This is true even if COLOR is used elsewhere in the host program.

The logic of the problem might now dictate the use of a second unit whose functions and procedures also deal with variables of type COLOR. In order to compile this second unit, we again have to declare the type COLOR in its interface part. But now we have got two units with

the same type declaration, and therefore we get the "IDENTIFIER DECLARED TWICE" message when we try to compile the host program.

There are two ways around this problem: first, we could nest the second unit inside the first one—but this implies a hierarchical relationship that has nothing to do with the structure of the problem.

Second, we could declare two types: type COLOR1 = (GREEN, YELLOW, RED). This works because variables of type COLOR can be assigned to variables of type COLOR1 and vice versa: UCSD Pascal employs structure compatibility (as opposed to name compatibility).

The second trick is even worse than the first. Multiple declarations have to be used where the problem requires just one.

In my opinion this interface problem is a serious design flaw. A solution could have been a "symmetrical" construction: the interface part must appear both in the unit and the host program, allowing both the unit *and* the host program to be compiled separately. The price to be paid for this solution would have been the invoca-

tion of the linker every time a unit had to be used—no "prelinked" units would have been possible. But I consider this price to be small if compared with the present messy situation that seriously hampers the use of units in the development of large programs.

Finally, let me correct an error in Dr. Tonkens's article. He states that Pascal cannot express the concept of absolute addressing; i. e., there are no PEEKs, POKEs, or CALLs. On the other hand, he shows a unit that does the "dirty trick" of mapping absolute hardware addresses to integer variables through the use of variant records. Variant records, however, are in no way special to Apple/UCSD Pascal; they are part of the standard language as defined by Jensen and Wirth. Therefore this "dirty trick" works with *any* Pascal on *any* machine that embodies the Jensen and Wirth standard. No unit is necessary for this purpose.

Ulrich Schmidt
Am Höfling 4
5100 Aachen
West Germany

A minor error has been brought to my attention by an alert BYTE reader concerning a statement made by me on page 236 of my article in the February 1982 BYTE, "A Guided Tour of Apple Pascal Units and Libraries."

I stated that the interface section of a unit must always declare at least one procedure or function. This is not strictly true. In fact, it is true only if there is also an *implementation* section to the unit. According to the syntax diagrams on pages 201 and 202 of the *Apple Pascal Language Reference Manual*, an implementation section is optional. Thus, if there is no implementation section, there need be no procedure or function declarations in the interface section. This situation could arise if the unit were written solely to declare a set of global variables which many programs could share by using the same declaration-only unit.

I wish to express my thanks to Leslie Hogben, Assistant Professor of Mathematics at Iowa State University, for bringing this fine point to my attention.

Ross M. Tonkens, M.D.
Cedars-Sinai Medical Office Towers
8635 West Third St., Suite 1185W
Los Angeles, CA 90048

Now add time-keeping capability to your RS-232C compatible computer. The Hayes Chronograph calendar clock coordinates and logs system activities by date and time... down to the second.

The Chronograph is ideal for business or home applications. Use it with your computer for timing everything from time-sharing access... to electronic mail and lights and sprinklers.

Hayes Stack

Microcomputer Component Systems

Plus Chronograph is designed to stack neatly on top of other Hayes Stack component systems... like the RS-232C compatible Smartmodem. (Each requires a dedicated RS-232C port.)

Keep your computer system up-to-date with the Hayes Stack Chronograph. Only \$249 at computer stores everywhere. There's no better time.

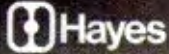

The Hayes Stack™ Chronograph

It's time. And it's now.



Hayes Microcomputer Products Inc. 5835 Peachtree Corners East, Norcross, Georgia 30092 (404) 449-8791

Hayes Stack is a trademark of Hayes Microcomputer Products, Inc.
© 1981 Hayes Microcomputer Products, Inc. Sold only in the U.S.A.



Every week,
2500 more people
like you
are going to work with
an Osborne®
personal business
computer.

Henry Ford revolutionized personal transportation.

Adam Osborne has done the same for personal business computing.

Virtually everything you need in a personal business computer to work faster and better with words, numbers, and ideas is included in a portable carrying case you can take anywhere.

It is easy to learn, fun to use, and quickly becomes indispensable.

One price, \$1795, buys it *all*. The Osborne is available from a computer retailer near you.

And you can buy it in any color you want. As long as it is blue.

Put away your buggywhips.



\$1795. Complete. Including Software.

In California call 800 772-3545 ext. 905; outside California call 800 227-1617 ext. 905, for your near-
OSBORNE
COMPUTER CORPORATION

The \$1795 suggested retail price for the Osborne 1 (a registered trademark of Osborne Computer Corporation) includes a full business keyboard, built-in CRT display, two built-in floppy disk drives, CPU and 64 kilobytes of RAM memory, RS-232 and IEEE 488 interfaces, and the following software packages: WORDSTAR® word processing with MAILMERGE® (a trademark and a registered trademark of MicroPro International Corporation of San Rafael, California), SUPERCALC® electronic spreadsheet system (a trademark of Sorcim Corporation), CBASIC® (a registered trademark of Compiler Systems), MBASIC® (a registered trademark of Microsoft), and CP/M® (a registered trademark of Digital Research)

It's the best part of any Apple.



Your Apple computer can grow from ordinary to awesome in a matter of minutes.

The Elite disk drive Series by Rana Systems gives you that kind of magic. Quickly, easily and cost-effectively.

This superb family of sophisticated floppy drives was designed and perfected by a team of industry-respected engineers expressly for Apple® computer owners who have long been demanding more disk drive for their money.

Now they *have* a drive that makes an Apple perform the way it should. For example;

Elite One, the most economical Rana drive, delivers 15% more storage capacity than Apple's drive. The top-of-the-line Elite Three will provide an astonishing *four-times* more storage,

approaching hard disk performance. It's done through exclusive high-density single and double-sided disks and heads.

Here's a tantalizing taste of just how formidable your Apple can become.

Next to enormously increased disk space, Apple buyers are most excited about Rana's fingertip Write/Protect feature. A pushbutton on the LED-lit panel gives you a new measure of failsafe control.

While Elite drives are all plug-compatible with Apple's controller, Rana's vastly superior controller card is a *must* for those with growing data processing demands. With it, you control up to *four* floppy drives using only one slot... while still utilizing your

Apple computer to achieve dramatic new heights of system flexibility and processing power.

A specially programmed Rana utility disk assures you of far-reaching compatibility, and extra dimensions of business, leisure and learning applications with your Rana-enhanced Apple computer.

There are many, many more operating refinements: Uncanny head-positioning accuracy, 300% faster track-to-track speed, better operating economy, and gentler clamping action through an all-new diskette centering cone, to name just a few.

A disk drive package like this doesn't grow on trees, so write or call today for more information about the Elite Series.

RanaSystems



Rana Systems Distributors

MicroDistributors Incorporated
Los Angeles, California
714-540-4781

**Trak MicroComputer
Corporation**
Chicago, Illinois
312-968-1716

Computer Data Services
Boston, Massachusetts
603-673-7375

DRV Electronics
British Columbia, Canada
604-576-1045

Regional Service Centers

Rana Systems
Los Angeles, California
213-538-2353

Peripheral Marketing Inc.
Palo Alto, California
415-964-4652

Peripheral Marketing Inc.
Boston, Massachusetts
617-449-5404

Peripheral Marketing Inc.
New York, New York
201-584-0010

YOUR VALUABLE DATA

**Precise head-positioning
saves your valuable time, your
disks and your temper.**

Your factory-supplied Apple® disk drive has a plastic head positioner. Like a toy, it's a workable but sloppy way to capture data. Characters are obscured, and multiple passes are needed to deliver a given bit of information.

Rana's head positioner is 50 percent more precise. It uses finely machined lead screws and metal band positioners that assure fast data recognition and optimum disk life.

Your local Rana Dealer can give you the complete picture on this and other major operating advantages.

Rana Systems



20620 South Leapwood Avenue
Carson, CA 90746 213-538-2353

® Apple is a registered trademark of Apple Computer, Inc.

Circle 331 on inquiry card.

Letters

Getting Rid of QWERTY

It is my understanding that the arrangement of keys on the traditional QWERTY keyboard is about the most inefficient layout that could be devised. This was the intent of the designer of the layout, whose early mechanical typewriter had considerable backlash so that an efficient typist using an efficient key layout would have typed too quickly, locking up the mechanical parts. Modern typewriters have overcome these mechanical limitations, but conservatism on the part of typists who have been trained on the QWERTY keyboard has resisted all attempts to introduce more efficient key layouts. This resistance to change is understandable but ill-advised, because retraining to a better layout takes very little time and its use allows the typist to work more efficiently with less fatigue.

Be that as it may, it seems to me that the designers of computers, and particularly microcomputers, are missing a great opportunity in not offering the option (or standard) of a more efficient key layout. The majority of people buying and using microcomputers have little or no professional typing experience and would welcome a more efficient and more easily mastered key layout.

The option of a different layout should be easy to offer—the main requirement would be a character-generator chip in the required configuration. In fact, the most tedious part of any conversion would be changing the keycaps on the keyboard to reflect the new layout.

Of course, it would be preferable if a change in layout could be to a new international standard layout. I believe that some work has been done on this, but perhaps agreement on a standard would (as usual) be the main stumbling block.

I am certain that if microcomputer manufacturers were to offer this option (or standard) it would be widely accepted by users and, in use, might overcome the resistance of established typists so that in time we might witness the demise (with no regrets) of the terrible QWERTY layout.

C. W. Green
POB 2972
Singapore 9049

Paging Malfunction

I wish to compliment Joseph Holmes on his excellent article about the Commodore

4022 and Epson MX-80 printers, "Commodore 4022 Printer" (March 1982 BYTE, page 26). Although I have owned a 4022 since last July, I was not familiar with the MX-80, but I suspected they were kissing cousins. The plotting routine for the MX-80 contained elsewhere in that issue could easily be adapted for use with the CBM/PET and 4022 combination.

However, Mr. Holmes's description of the 4022's paging function is not quite accurate. When paging is turned on initially, the printer does a linefeed, yielding one less than the set number of lines for the first page. Subsequent pages will have the correct number of lines. This can be quite annoying when printing out data in tabular form that requires more than one page. This will also happen if the set number of lines per page is changed.

Jack B. Cooper
46 Henry Ave.
Princeton, NJ 08540

No Discount—No Sale

Thank you for printing the letter from Mr. Dennis Pratt in the March 1982 BYTE (page 14). The information regarding the new sales rules and retail restrictions established by Apple Computer Inc. was most interesting.

In this day and time when everyone is making every possible effort to boost sales, it is interesting to find the management at Apple directing its sales outlets to stop all mail and phone discount sales. You can't blame a company for wanting to offer the best possible service; however, sales decisions of this type are not only foolish and very risky, but certainly show little consideration for those who have an Apple system and want to add to it by buying from those dealers that offer the best prices.

We were going to build a small-business computer system based on the Apple; however, with the nonavailability of discount components, I have today sold the Apple products that we had in the system. The computer, disk drives, monitor, printer, and other items were sold at a loss to us; nevertheless, I cannot see continuing with a system which is manufactured by a "no discount" company.

We will pick up and install our new brand of computer system tomorrow. I am sure there are others out there who make computers that perform just as well

as the Apple. This decision by Apple comes at a time when there are other firms entering the small-business computer marketplace—firms that will discount their products in appreciation of our business. Maybe if other businesses follow actions like ours, we can offer Apple the challenge it's apparently looking for, and put that company in its proper position in today's marketplace.

This move by Apple is about as smart as adding a surcharge to the price of a new car. Lots of luck, Apple. You're going to need it.

William D. Mauldin
Broadcasting/Recording Productions
POB 547
Delray Beach, FL 33447

More Microcomputer Forms

I recently read Phil Lemmons's interesting article titled "Custom and Standardized Forms for the Microcomputer User" (March 1982 BYTE, page 198). I thought

the article was well written and presented a true picture of what is happening in the microcomputer forms market.

UARCO is one of the world's largest business-forms manufacturers. For some time now, we have been developing business forms for the microcomputer market. In addition to being software-compatible with a number of systems on the market, UARCO forms are graphically appealing. We have manufactured most of these in three colors to give the appearance of a custom form at the price of a stock form. We also provide one of the largest selections of computer supplies found anywhere.

If Mr. Lemmons decides to write another article on microcomputer forms or supplies, we would appreciate being included.

Jack M. Resnick, General Manager
Direct Mail Marketing
UARCO
121 North Ninth St.
POB 948
De Kalb, IL 60115

Optical Reader Interface

I am attempting to interface an IBM 1230 Optical Reader to a TRS-80 Model II. I would appreciate hearing from anyone who has or intends to do the same.

Louis M. Ferrari
3919 Octave Drive
Jacksonville, FL 32211

BYTE's Bugs

Switched Assignments

A few bugs were found lurking in David Staehlin's article "An 8080-Based Remote Appliance Controller" (January 1982 BYTE, page 239). In figure 1 on page 240, pin 4 and pin 6 of IC1 (IC1b) were switched. Pin 6 should be where pin 4 was located and vice versa. As it is shown, the circuit will fail to oscillate. ■

Systems II Ex™



Westware
Software Inc.

2455 S.W. 4th Ave.
Ontario, OR 97914 • (503) 881-1477



One Step Above The Competition

- General Ledger
- Payroll
- Inventory
- Accounts Receivable
- Accounts Payable
- Data Base

The **Systems II Ex** helps you gain complete financial control over your business by providing reports such as:

- Balance Sheets
- Aged Receivables
- Payroll
- Ledger Reports
- Inventory List
- Database Reports

It makes office operations more efficient by printing: **payroll checks, invoices, vendor file and statements.** The KSAM card provides fast online sorting capability, making the EX one of the fastest accounting systems available on the APPLE II.

available on CORVUS hard disk.

Optional Modules - Job Costing - Cycle Billing

Take a step above YOUR competition with the **Systems II Ex**

Source # TCK 757

APPLE II is a trademark of Apple Computer; CORVUS is a trademark of Corvus Systems; SYSTEMS II EX is a trademark of Westware, Inc.

And The Winner Is... IBC By Four Users!

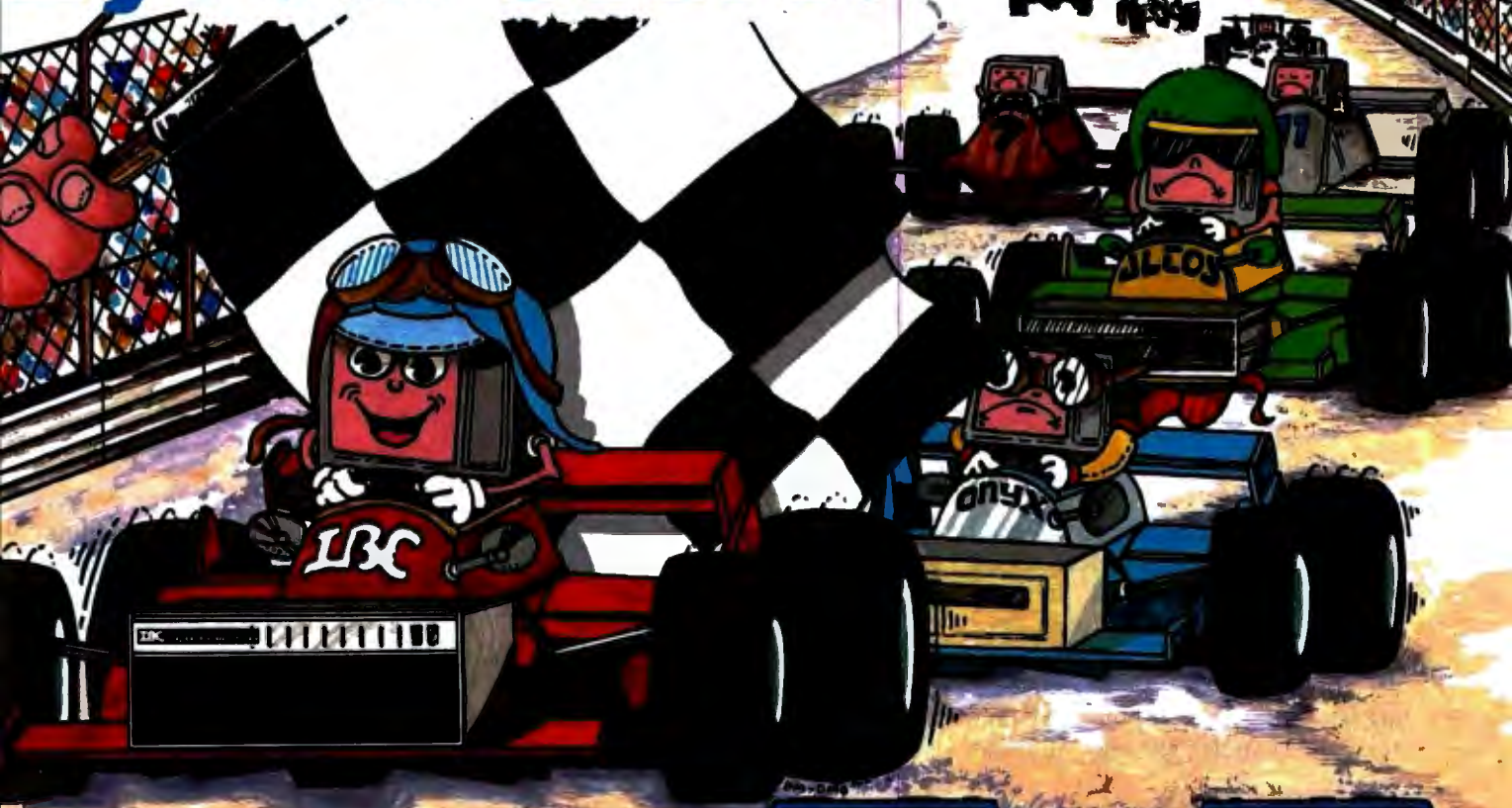

When you are racing toward that finish line, beating the competition is everything. IBC is the choice of OEM's, system integrators and dealers throughout the world, because in benchmark after benchmark our small business computer systems finish first.

We finish first because we are faster, offer higher quality peripherals and can expand our system significantly beyond our nearest competitors. In fact, looking at the chart below, you can quickly see why knowledgeable resellers are choosing IBC.

	IBC	onyx	ALLOS
Oasis Operating System (Max. Users)	9	5	4
CPU Speed (MHz)	6	4	4
Disk Speed I/O (MB/Sec.)	.81	.65	.54
Seek (Milli Sec.)	35	50	65
Cache Disk Memory	Yes	No	No



Circle 179 on Inquiry card.

Join us in the winners circle with high performance equipment and the best dealer plan in the industry. Call or write:

OUTSIDE THE USA

IBC / Integrated Business Computers

21592 Marilla Street
Chatsworth, CA 91311
(213) 882-9007 TELEX NO. 215349

WITHIN THE USA

IBC / DISTRIBUTION

4185 Harrison Blvd., Suite 301
Ogden, UTAH 84403
(801) 621-2294

The Input/Output Primer

Part 6: Interrupts, Buffers, Grounds, and Signal Degradation

The conclusion of a six-part series covering fundamental issues in computer interfacing.

Steve Leibson
Cadnetics Corporation
5797 Central Ave.
Boulder, CO 80301

In our discussions about I/O hardware, we talked about the needs of a wide range of peripheral devices. Some devices are much slower than internal computer processes, some are about the same speed, and some are faster than the computer can comfortably handle through normal means.

We discussed the three hardware handshakes associated with these three classes of peripherals. Slow devices are best handled by interrupt. Only when the device is ready for another data transfer is the processor interrupted so that it can service the peripheral.

Medium-speed devices can interact with the processor directly since they

will not degrade system performance. High-speed devices require special hardware for direct memory access (DMA) because the processor alone is not fast enough to service them.

The hardware to perform interrupt I/O and DMA is useless without software to support the capability. In the discussion of formatted I/O, we were referring only to the simpler handshake or programmed I/O. Most computers support this type of I/O even if it is only by using the PRINT statement.

Hewlett-Packard desktop computers support interrupt I/O in two ways: user interrupt-service routines and buffer transfers. DMA is supported only through buffer transfers. We will briefly discuss user interrupt-service routines and devote the rest of this discussion to buffers and buffer transfers.

High-level languages frequently have subroutine capability. In HPL (Hewlett-Packard's high-performance language for the 9825A/B), subroutines are invoked with the "gsb" statement and the main program is returned by using an "ret." BASIC uses the corresponding statements GOSUB and RETURN.

User interrupt-service routines are a variation of the subroutine. After

interrupts are enabled, the subroutine is invoked because a peripheral interrupt. The subroutine is written in the high-level language of the computer and is terminated with an interrupt-return statement such as "iret" in HPL. The following HPL program fragment illustrates how user interrupt-service routines are written:

```
10: 1-I
11: oni 6, "send"
12: eir 6
•
•
•
87: "send": wtb 6,A${I,I}
88: I+1-I;if I<=len(A$);eir 6
89: iret
```

Line 10 sets a counter that points to individual characters in string A\$. Should an interrupt occur, line 11 directs the program to line 87, labeled "send," and line 12 enables the interface hardware and software to accept interrupts. Line 87 sends a single character from string A\$ each time the user interrupt-service routine is called. Line 88 increments the counter I to the next character and reenables interrupts if there are more characters to transmit. Line 89 forces a branch back to the main program.

This article concludes Steve Leibson's six-part series, The Input/Output Primer. Covering the basics of how computers communicate with the world, the articles have described how some of the problems in this area have been solved. Steve's "An I/O Glossary," a valuable reference for the series, was published in the series' first installment (February 1982 BYTE, page 122). Figure numbers are continued from Part 4.

Microcomputer Business Industries Corporation

presents

Two Practical Peripherals For Your Apple™ II

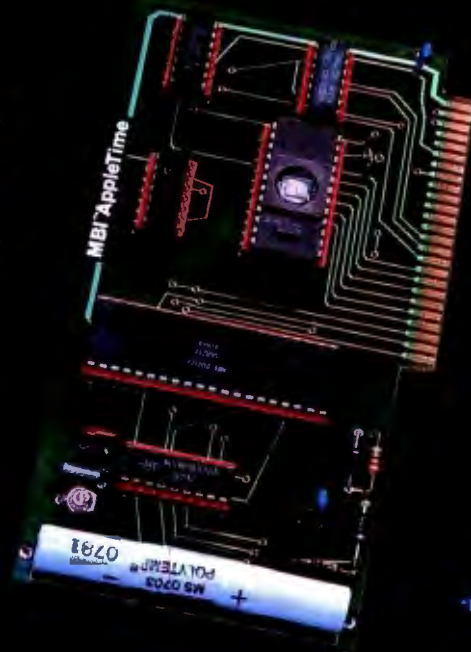

*Recommended
Retail Price

Appletime™ Clock Card

\$9900*

- Fully Mountain Computer Software compatible
- Disk included with all software
- Includes Datebook™ - a complete desk calendar
- Time of day • International time-keeping ability
- Calendar date • Recharging battery backup
- Day of week • Complete software formatting
- Program timer • Offset time/date/day readout

VIP™ Card - "Versatile Interface Peripheral"

(Available for EPSON, NEC, C-ITOH, IDS PRISM, OKIDATA and other graphic printers soon.)

VIP™ G- The Ultimate Graphics Card

\$11900*

- A Centronics Parallel Interface and Cable featuring:
- Text and graphics screen dump routine
- Graphics with inverse & emphasized modes

- Enlarged picture mode
- Variable line length with left & right margins
- Block graphics
- 90° picture rotation
- Chart Recorder Mode
- Upgradable to VIP™ G+

VIP™ G+

\$14900*

- has all the features of the VIP™ G plus:
- A serial port with full RS232 capability
- Software baud rate control from 140 to 9600 baud

VIP™ P

\$11900*

- an Interface card featuring:
- Two parallel ports
- Upgradable to VIP™ SP

VIP™ SP

\$14900*

- an Interface card featuring:
- Two parallel ports
- One serial port

VIP™ Graphics Diskette

\$1995*

for the person who already owns a parallel interface and cable. Features:

- Full VIP™ I software capabilities
- Plus side-by-side twin picture capability
- Self-documentation



Microcomputer Business Industries Corporation

Suite 200 • 1019 8th Street
Golden, Colorado 80401
(303) 279-8438 TWX: 910-934-0191

National and international
dealer inquiries welcome.

LIGHTNING FAST SAFE AND SOUND

Rapidly write programs and save your files with **Audio Light** utilities for CP/M:

BACKFIELD

MPL—MENU PROGRAMMING LANGUAGE

Our Quality Software will improve your productivity.

THE BACKFIELD

Our backfield software saves and protects your hard disk data with these fine features:

- Backs up a hard disk to floppies
- Backs up selected files or all files
- Automatically selects files that have changed since last backup
- "Squeezes" text if desired

The **BACKFIELD** consists of three programs:

FULLBACK backs up an entire disk to another set of disks file-by-file, optimizing the use of all available memory. It writes a special checksum directory file for later use by **QUARTERBACK**.

HALFBACK backs up a large file to multiple disks.

QUARTERBACK automatically determines which files have been changed since the last backup, and backs up these files only.

MPL—MENU PROGRAMMING LANGUAGE

MPL simplifies application programming by using menus to structure programs:

- Data is displayed as items in a menu
- Data is organized by connecting menus together
- Selecting an item in a menu may call an application module
- Message area at top of each menu for module communication
- Selection causes data to be placed in the message area
- Interfaces with other programming languages

MPL is a revolutionary new programming language for the system developer or end user to structure applications in a natural easy-to-use manner. The design of MPL allows application modules to be written in any compiled language supported by CP/M.

PRICE—ORDER INFORMATION

THE BACKFIELD	\$150.00
MENU PROGRAMMING LANGUAGE	\$175.00

MPL requires a 24x80 CRT. All software is supplied on 8" single density diskette for CP/M 2.2.

Call (408) 395-0838, or send check to:

AUDIO LIGHT, INC.
146 Town Terrace, Suite 4
Los Gatos, CA 95030

*California residents add 6% for sales tax
Dealer Inquiries Welcome

MPL is a trademark of Audio Light, Inc.
CP/M is a trademark of Digital Research.

Audio Light

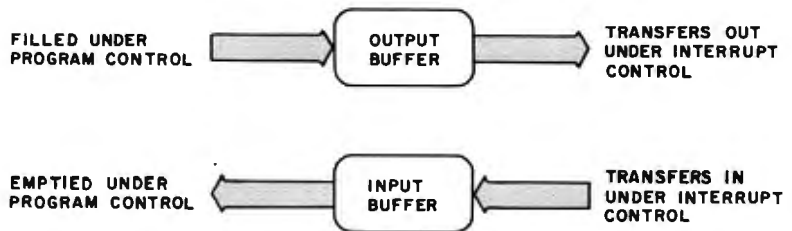

Figure 16: A diagram showing the function of software buffers. These buffers store data for data-transfer routines that use interrupts. A program fills an output buffer and an interrupt-service routine empties it. An interrupt-service routine fills an input buffer and a program empties it. The program initiates both input and output transfers.

Several things should be noted from this example. The "eir 6" enables the interface. The meaning of an interrupt is that the interface is not busy. The first interrupt will occur immediately after the computer executes line 12. Novices at interrupt routines always fall prey to this. If the interface has not been made busy by sending it a character before interrupts are enabled, interrupt is immediate.

Note that the program must use a counter to keep track of where the next character will come from in A\$. Also, interrupts must be reenabled in the interrupt-service routine if the transfer is not finished. This is necessary because the "eir" is canceled when it is invoked. That prevents the interrupt-service routine from being interrupted.

Buffers

High-level-language program lines are slow compared to the native processor speed. User interrupt-service routines can support only low data rates. Buffer transfers are a much better choice for data transfers, leaving user routines to service special situations.

Buffers are blocks of computer memory allocated for I/O. Data passes through the buffer on the way into or out of the computer. Enabling of interrupts and character counters is taken care of automatically and new features are available. Data transfers can be terminated on a count, as in the above example, or by a character match for buffered input. Figure 16 shows how buffers are used for I/O.

The following sample program

lines perform the same task as the first sample, but use buffered I/O:

```
10: buf "OUT",100,1
11: wrt "OUT",A$
12: tfr "OUT",6
```

As you can see, this is much simpler. Line 10 creates a buffer of 100 characters, line 11 fills the buffer with the contents of string A\$, and line 12 sends the data to the peripheral. The 1 at the end of line 10 specifies an interrupt buffer.

Why is this technique superior to simply writing out the data directly to the peripheral? Line 12 only initiates the data transfer. After that process is started, the program will continue with line 13. When the peripheral interrupts, it will automatically be given the next character. Meanwhile, the computer is executing the rest of the program.

Interrupt buffers are faster than user interrupt-service routines for one primary reason. The only safe place to interrupt a high-level-language program is at the end of a line. In the execution of a line of high-level-language code, temporary locations are set up, addresses are calculated, and a whirl of activity is taking place.

An interrupt routine must be able to return to where the program left off after the interrupt is serviced. If the user routine accesses variables being used by the main program, or worse yet, changes those variables, there could be disastrous results.

That is why high-level-language interrupts are restricted to the end of a line. Things are safe there.

Conversely, the routines used by the buffer-transfer interrupt-service

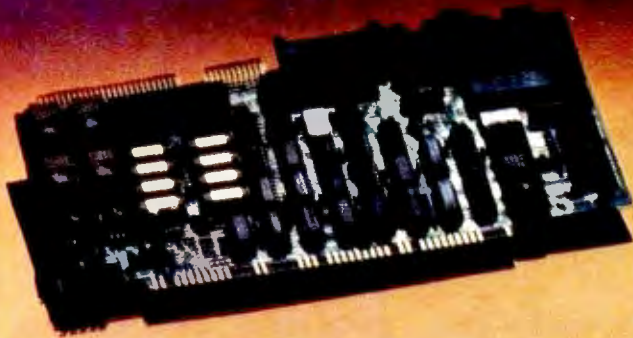

Performance . . .

SBC-100S SLAVE PROCESSOR

- Z80A CPU
- 64K Bank Switchable Memory
- 16K EPROM
- 2 RS-232 Chan. (up to 19.2K BAUD)
- 4 Parallel Ports
- 4 Timers
- IEEE 696 Buss Interface
- Expansion Interface (X-Buss)
- On Board EPROM Burner (Opt.)
- \$795.00 Single Unit Quantity

SBC-100 MASTER PROCESSOR

- Z80A CPU
- 64K Bank Switchable Memory
- 4K EPROM
- NEC 765 FDC with PLL interfaces to all Shugart compatible Drives
- 2 RS-232 Chan. (up to 19.2K BAUD)
- 2 Parallel Ports
- 4 Timers
- IEEE 696 Buss Interface
- \$895.00 Single Unit Quantity

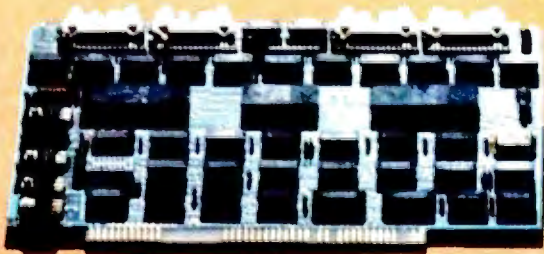

SDS-ZSIO/4
ZSIO 4 Port RS-232
Serial Expansion Board
\$295.00 Single Unit Quantity



SDS-HARD DISK INTERFACE
Micropolis 1220 Series
Interface Adapter
\$150.00 Single Unit Quantity
(Includes Software Drivers, Cabling, and Mounting Hardware.)

Software Support . . .

- *CPM 2.2 for Single User Systems
- **TURBODOS Single User or Networking
- *Registered Trade Mark of Digital Research Corporation.
- **Registered Trade Mark of Software 2000.

. . . And Quality

- Boards Tested on "Bed of Nails"
- Support Logic meets MIL-STD-833 Specifications
- Gold Plated Connectors
- Full One Year Warranty

We have it ALL!

**HARDWARE
SOFTWARE**



SIERRA DATA SCIENCES

Fresno, California

Marketing Division
21162 Lorain Avenue
Fairview Park, Ohio 44126
(216)331-8500
TELEX 980131 WDMR

Up-to-the-minute information.

Down-to-earth prices.

Our low prices speak for themselves.

Everything considered, we believe we offer you the best bottom line in the business — on a consistent basis.

However, we invite you to take advantage of more than just our low prices.

When you call Alpha Byte, you'll be tapping-in to what is possibly the most comprehensive wealth of information available anywhere.

Our people are state-of-the-art experts who live and breathe microcomputers. We require that they stay on top of this constantly changing business — using the new products, reading the literature about them, understanding their applications, advantages, and disadvantages.

So if you have any questions — if you're not sure about *exactly* what you need, or if you'd just like to discuss the pros and cons of a particular piece of equipment — call us.

We love to talk about microcomputers.

16K RAM KITS . . . 13.95

Set of 8 NEC 4116 200 ns. Guaranteed one full year.

DISKETTES

ALPHA DISKS 21.95

Single sided, certified Double Density 40 Tracks, with Hub-ring Box of 10. Guaranteed one full year.

VERBATIM DATALIFE

MD 525-01, 10, 16	26.50
MD 550-01, 10, 16	44.50
MD 557-01, 10, 16	45.60
MD 577-01, 10, 16	34.80
FD 32 or 34-9000	36.00
FD 32 or 34-8000	45.60
FD 34-4001	48.60

DISKETTE STORAGE

5 1/4" PLASTIC LIBRARY CASE	2.50
8" PLASTIC LIBRARY CASE	3.50
PLASTIC STORAGE BINDER w/ Inserts	9.95
PROTECTOR 5 1/4" (50 Disk Capacity)	21.95
PROTECTOR 8" (50 Disk Capacity)	24.95
DISK BANK 5 1/4"	5.95
DISK BANK 8"	6.95

NEC PERSONAL COMPUTERS

PC-8001A CPU	899.00
PC-8012A I/O	559.00
PC-8033A DISK I/O	125.00
PC-8031A DUAL DISK	899.00

ALTOS COMPUTER SYSTEMS

Call Alpha Byte for our low Altos prices.

ATARI COMPUTERS

ATARI 800	679.00
ATARI 400 (16K)	339.00
ATARI 810 DISK DRIVE	445.00
ATARI 850 INTERFACE	169.00
ATARI 410 PROGRAM RECORDER	75.00
EPSON CABLE	35.00
MEMORY MODULE (16K)	89.95
JOYSTICK CONTROLLER	10.00
PADDLE CONTROLLERS	19.95
STAR RAIDERS	35.00
MISSILE COMMAND	35.00
ASTEROIDS	35.00
PACMAN	\$CALL

INTEC PERIPHERALS RAM MODULES

48K FOR ATARI 400	279.00
32K FOR ATARI 800	125.00

ACTIVISION ATARI CARTRIDGES

LAZAR BLAST	21.95
SKING	21.95
DRAGSTER	21.95
BOXING	21.95
CHECKERS	21.95
BRIDGE	21.95
KABOOM	21.95

HEWLETT PACKARD

HP CALCULATORS

HP-11C LCD SCIENTIFIC	115.95
HP-12C LCD BUSINESS	128.95
HP-37E BUSINESS	64.95
HP-32E SCIENTIFIC w/ STATS	46.95
HP-33C Programmable Scientific	76.95
HP-41C Advanced Programmable	211.95
HP-41CV Advanced Prog 2K mem	274.95

HP-41 PERIPHERALS

HP-82106A MEMORY MODULE	27.95
HP-82170A Quad Memory Module	89.00
HP-82143A PRINTER/PLOTTER	324.95
HP-82160A IL INTERFACE	119.00
HP-82161A DIGITAL CASSETTE	419.00
HP MATH PAC	29.00
HP STATISTICS PAC	29.00
HP REAL ESTATE PAC	39.00
HP SURVEYING PAC	29.00
HP STRUCTURAL ANALYSIS PAC	39.00

HP COMPUTERS

HP-85A PERSONAL COMPUTER	2195.00
HP SINGLE 5 1/4" DISK DRIVE	1295.00
HP DUAL DISK DRIVE	1995.00
HP-85A 16K MEMORY MODULE	239.00
HP-7225B GRAPHICS PLOTTER	2195.00
HP PLOTTER MODULE	605.00
HP HP-IB INTERFACE	329.00
HP STD APPLICATIONS PAC	83.00
HP GENERAL STATISTICS PAC	83.00
HP GRAPHIC PRESENTATIONS	159.00
HP VISICALC PLUS	159.00
HP ROM DRAWER	39.00
HP PRINTER/PLOTTER ROM	116.00
HP MASS STORAGE ROM	116.00
HP RS-232 INTERFACE	329.00

PRINTERS

ANADEX DP 9500	1295.00
ANADEX DP 9501	1295.00
C-ITOH F-10 40 CPS PARALLEL	1595.00
C-ITOH 45 CPS PARALLEL	1770.00
C-ITOH 40 CPS SERIAL	1295.00
C-ITOH PROWRITER PARALLEL	549.00
C-ITOH PROWRITER SERIAL	695.00
EPSON MX-80 W/GRAFTRAX	\$CALL
EPSON MX-80 F/T W/GRAFTRAX	\$CALL
EPSON MX-100 W/GRAFTRAX	\$CALL
EPSON GRAFTRAX	90.00
IDS-560G PAPER TIGER	1195.00
IDS PRISM 80 W/O COLOR	1099.00

IDS PRISM 80 W/COLOR	1599.00
IDS PRISM 132 W/COLOR	1799.00
NEC 8023A	659.00
NEC SPINWRITER 3530 P. RO	1995.00
NEC SPINWRITER 7710 S. RO	2545.00
NEC SPINWRITER 7730 P. RO	2545.00
NEC SPINWRITER 7700 D SELLUM	2795.00
NEC SPINWRITER 3500 SELLUM	2295.00
OKIDATA MICROLINE 80	389.00
OKIDATA MICROLINE 82A	549.00
OKIDATA MICROLINE 83A	799.00
OKIDATA MICROLINE 84	1199.00
OKIGRAPH 82	33.95

CORVUS

FOR S-100, APPLE OR TRS-80 MOD I, III

Controller, Case/P.S., Operating System, A & T.	
5 MEGABYTES	3245.00
10 MEGABYTES	4645.00
20 MEGABYTES	5545.00
MIRROR BACK-UP	725.00

APPLE HARDWARE

VERSA WRITER DIGITIZER	259.00
ABT APPLE KEYPAD	119.00
SOFTCARD PREMIUM SYSTEM	625.00
MICROSOFT Z-80 SOFTCARD	299.00
MICROSOFT RAMCARD	159.00
VIDEX 80 x 24 VIDEX CARD	299.00
VIDEX KEYBOARD ENHANCER II	129.00
VIDEX ENHANCER REV 0-6	99.00
M & R SUPERTERM 80 x 24 VIDEX BD.	315.00
SSM AIO BOARD (INTERFACE) A & T	165.00
SSM AIO BOARD (INTERFACE) KIT	135.00
APPLE COOLING FAN	44.95
T/G JOYSTICK	54.95
T/G PADDLE	34.95
T/G SELECT-A-PORT	54.95
VERSA E-Z PORT	21.95
MICRO SCI A2 W/O CONTROLLER	419.00
MICRO SCI A40 W/O CONTROLLER	479.00
MICRO SCI A40 W/O CONTROLLER	409.00
MICRO SCI A70 W/O CONTROLLER	629.00
MICRO SCI A70 W/O CONTROLLER	549.00
THE MILL-PASCAL SPEED UP	329.00
PROMETHEUS VERSACARD	229.00
SUPERLOCK II	129.00
LAZAR LOWER CASE +	59.00
MICROBUFFER II 16K W/GRAPHICS	259.00
MICROBUFFER II 32K W/GRAPHICS	299.00

MONITORS

NEC 12" GREEN MONITOR	179.00
NEC 12" COLOR MONITOR	399.00
SANYO 12" MONITOR (B & W)	249.00
SANYO 12" MONITOR (GREEN)	269.00
SANYO 13" COLOR MONITOR	469.00
ZENITH 12" HI RES GREEN MON	124.00
AMDEK COLOR I	389.00
AMDEK RGB COLOR	659.00
AMDEK RGB INTERFACE	169.00

MOUNTAIN HARDWARE

CPS MULTIFUNCTION BOARD	199.00
ROMPLUS W/ KEYBOARD FILTER	179.00
ROMPLUS W/O KEYBOARD FILTER	130.00
KEYBOARD FILTER ROM	49.00
COPYROM	49.00
MUSIC SYSTEM	369.00
ROMWRITER	149.00
APPLE CLOCK	252.00
A/D + D/A	299.00
EXPANSION CHASSIS	625.00
RAMPLUS 32K	139.00

CALIF. COMPUTER SYSTEMS S-100 BOARDS

2200A MAINFRAME	459.00
2065C 64K DYNAMIC RAM	539.00
2422 FLOPPY DISK CONT. & CP/M*	359.00
2710 FOUR SERIAL I/O	279.00
2718 TWO SERIAL/TWO PARALLEL I/O	269.00
2720 FOUR PARALLEL I/O	199.00
2810 Z-80 CPU	259.00

APPLE BOARDS

7710A ASYNCHRONOUS S. INTERFACE	149.00
7712A SYNCHRONOUS S. INTERFACE	159.00
7424A CALENDAR CLOCK	99.00
7728A CENTRONICS INTERFACE	105.00

VISTA COMPUTER CO.

APPLE VISION 80-80 COL CARD	329.00
APPLE 8" DISK DRIVE CONTROLLER	549.00

MODEMS

NOVATION CAT ACOUSTIC MODEM	145.00
NOVATION D-CAT DIRECT CONNECT	165.00
NOVATION AUTO-CAT AUTO ANS	219.00
NOVATION APPLE-CAT	349.00
UDS 103 LP DIRECT CONNECT	175.00
UDS 103 JLP AUTO ANS	209.00
HAYES MICROMODEM II (APPLE)	299.00
HAYES 100 MODEM (S-100)	325.00
HAYES SMART MODEM (RS-232)	249.00
HAYES CHRONOGRAPH	225.00
LEXICON LX-11 MODEM	109.00

TERMINALS

TELEVIDEO 910	639.00
TELEVIDEO 912C	745.00
TELEVIDEO 920C	830.00
TELEVIDEO 950C	995.00
ZENITH Z-19	799.00

TRS-80 MOD I HARDWARE

PERCOM DATA SEPARATOR	27.00
PERCOM DOUBLER II	159.00
TANDON 80 TRACK DISK DRIVE	429.00
TANDON 40 TRACK DISK DRIVE	289.00
LNW DOUBLER W/ DOSPLUS 3.40	159.00
MOD III DRIVE KIT	649.00

MORROW DESIGNS FLOPPY DISK SYSTEMS

Controller, P.S., Microsoft Basic, CP/M*	
A & T	
DISCUS 2D (Single Drive — 500K)	869.00
DISCUS 2D (Dual Drive — 1 MEG)	1499.00
DISCUS 2 + 2 (Single Drive — 1 MEG)	1099.00
DISCUS 2 + 2 (Dual Drive — 2 MEG)	1999.00

HARD DISK SYSTEMS

Controller, P.S., Microsoft Basic, CP/M*	
A & T	
DISCUS M10 (10 Megabytes)	3099.00
DISCUS M26 (26 Megabytes)	3749.00

ISOLATORS

ISO-1 3-SOCKET	53.95
ISO-2 6-SOCKET	53.95

BARE DRIVES

TANDON 5 1/4 INCH	
100-1 SINGLE HEAD 40 TRK	209.00
100-2 DUAL HEAD 40 TRK	275.00
100-3 SINGLE HEAD 80 TRK	275.00
100-4 DUAL HEAD 80 TRK	399.00

TANDON THINLINE 8 INCH

848-1 SINGLE SIDE	420.00
848-2 DUAL SIDE	515.00

MICRO PRO

APPLE CP/M*

WORDSTAR*†	249.00
SUPERSOFT*†	145.00
MAILMERGE*†	90.00
DATASTAR*†	215.00
SPELLSTAR*†	169.00
CALCSTAR*†	169.00

CP/M*

WORDSTAR	310.00
SUPERSOFT	195.00
MAILMERGE	110.00
DATASTAR	245.00
SPELLSTAR	195.00
CALCSTAR	239.00

MICROSOFT

APPLE

FORTRAN*	165.00
BASIC COMPILER*	315.00
COBOL*	595.00
Z-80 SOFTCARD	299.00
RAMCARD	159.00
TYPING TUTOR	17.95
OLYMPIC OECATHLON	24.95
TASC APPLESOFT COMPILER	159.00

CP/M*

BASIC 80	299.00
BASIC COMPILER	319.00
FORTRAN 80	369.00
COBOL 80	595.00
MACRO 80	189.00
mu MATH/mu SIMP	219.00
mu LISP/mu STAR	175.00

APPLE SOFTWARE

MAGIC WINDOW	79.00
MAGIC SPELL	59.00
BASIC MAILER	59.00
DB MASTER	179.00
DB MASTER UTILITY PACK	79.00
DATA CAPTURE 4.0/80	59.95
PFS: (NEW) PERSONAL FILING SYSTEM	85.00
PFS: REPORT	79.00
Z-TERM*	89.95
Z-TERM PRO*	129.95
ASCII EXPRESS	63.95
EASY WRITER-PRO	199.00
EASY MAILER-PRO	79.00
EXPEDITER II APPLESOFT COMPILER	73.95
A-STAT COMP. STATISTICS PKG.	129.00
SUPER TEXT II	129.00
LISA 2.5	59.95

CONTINENTAL SOFTWARE

G/L	199.00
A/R	199.00
A/P	199.00
PAYROLL	199.00
PROPERTY MGMT	399.00
THE HOME ACCOUNTANT	59.95

PERSONAL SOFTWARE

DESKTOP PLAN II	199.00
VISILOT	179.00
VISITREND/VISIPLOT	239.00
VISIDEX	199.00
VISITERM	79.00
VISICALC	199.00
VISIFILES	209.00

CP/M* SOFTWARE

THE WORD-SPELL CHECK	75.00
d BASE II	599.00
SUPER CALC	229.00
SPELLGUARD	239.00
P & T CP/M* MOD II TRS-80	175.00
COMM X TERMINAL PROG.	82.50
C BASIC 2	115.00
PASCAL Z	349.00
PASCAL MT +	439.00
PASCAL/M	205.00
SYSTEMS PLUS —	
G/L, A/R, A/P, P/R	1799.00
CONDOR I	579.00
CONDOR II	849.00

DIGITAL RESEARCH

MAC	89.00
SID	69.00
ZSID	97.00
PL/ 1-80	439.00

SUPERSOFT

DIAGNOSTIC I	69.00
DIAGNOSTIC II	89.00
'C' COMPILER	179.00
UTILITIES I	59.00
UTILITIES II	59.00
RATFOR	89.00
FORTRAN	239.00

TRS-80 GAMES

TEMPLE OF APSHAI	34.95
HELLFIRE WARRIOR	34.95
STAR WARRIOR	34.95
RESCUE AT RIGEL	24.95
CRUSH, CRUMBLE AND CHOMP	24.95
INVADERS FROM SPACE	17.95
PINBALL	17.95
STAR TREK 3 5	17.95
MISSILE ATTACK	18.95
STAR FIGHTER	24.95
SCARFMAN	17.95

TRS-80 SOFTWARE

NEWDOS/80 2.0 MOD I, III	139.00
LAZY WRITER MOD I, III	165.00
PROSOFT NEWSRIPT MOD I, III	99.00
SPECIAL DELIVERY MOD I, III	119.00
X-TRA SPECIAL DELIVERY MOD I, III	199.00
TRACKCESS MOD I	24.95
DMNITERM SMART TERM MOD I, III	89.95
MICROSOFT BASIC COMP FOR MOD I	165.00
LDOS 5 1 MOD I, III	159.00

APPLE GAMES

PERSONAL SOFTWARE

CHECKER KING	21.95
GAMMON GAMBLER	21.95
MONTY PLAYS MONOPOLY	29.95
ZORK I	32.95
ZORK II	32.95
MONTY PLAYS SCRABBLE	34.95

BRODERBUND

GALAXY WARS	20.95
ALIEN TYPHOON	20.95
APPLE PANIC	24.95
MIDNIGHT MAGIC	29.95
SPACE QUARKS	24.95

AUTOMATED SIMULATIONS

INVASION ORION	20.95
STAR WARRIOR	32.95
TUES. MORNING QUARTERBACK	25.95
CRUSH, CRUMBLE AND CHOMP	24.95
THE DRAGON'S EYE	20.95

MUSE SOFTWARE

ROBOT WARS	32.95
THREE MILE ISLAND	32.95
A. B. M.	20.95
GLOBAL WAR	20.95
CASTLE WOLFENSTEIN	24.95

ON-LINE SYSTEMS

WIZARD AND PRINCES	29.95
MISSILE DEFENSE	25.95
SABOTAGE	20.95
SOFT PORN ADVENTURE	24.95
THRESHOLD	31.95

To order or for information call
(213) 706-0333
Modem order line: (213) 883-8976

We guarantee everything for 30 days. If anything is wrong, return the item and we'll make it right. And, of course, we'll pay the shipping charges.

We accept Visa and Master Card on all orders; COD up to \$300.00. Add \$2.00 for standard UPS shipping and handling on orders under 50 lbs, delivered in continental U.S. Call for shipping charges over 50 lbs. Foreign, FPO and APO orders, add 15% for shipping. Californians add 6% sales tax.

Prices quoted are for stock on hand and subject to change without notice.

31245 LA BAYA DRIVE, WESTLAKE VILLAGE, CALIFORNIA 91362

JAW BREAKER	24.95
CROSSFIRE	24.95
TIME ZONE	69.95
H/R FOOTBALL	32.95
H/R CRIBBAGE	20.95
PEGASUS II	25.95

SIRIUS SOFTWARE

SPACE EGGS	24.95
GORGON	32.95
SNEAKERS	24.95
EPOCH	29.95
BEER RUN	24.95
HADRON	29.95
PULSAR II	24.95
EPOCH	29.95

EDU-WARE

PERCEPTION PKG.	19.95
COMPU-READ	24.95
COMPU-MATH: ARITHMETIC	39.95
COMPU-MATH: FRACTIONS	34.95
COMPU-MATH: DECIMALS	34.95
COMPU-SPELL (REQ. DATA DISK)	24.95
CDMPU SPELL DATA DISKS 1-4, ea	17.95

MORE GREAT APPLE GAMES

COMPUTER QUARTERBACK	32.95
TORPEDO FIRE	49.95
THE SHATTERED ALLIANCE	49.95
POOL 1.5	29.95
ULTIMA	33.95
RASTER BLASTER	24.95
FLIGHT SIMULATOR	27.95
INTERNATIONAL GRAND PRIX	25.95
SARGON II	28.95
SHUFFLE BOARD	29.95
FIREBIRD	24.95
SNACK ATTACK	24.95
THIEF	24.95
ROACH HOTEL	29.95
JABBERTALKY	24.95
THE WARP FACTOR	32.95
COSMO MISSION	24.95
WIZARDRY	37.95

SUPPLIES

AVERY TABULABLES

1,000 3 1/2 x 15/16	8.49
3,000 3 1/2 x 15/16	14.95
5,000 3 1/2 x 15/16	19.95

FAN FOLD PAPER

(Prices F.O.B. S.P.)	
9 1/2 x 11 18lb WHITE 3,000 ct.	29.00
14 7/8 x 11 18lb WHITE 3,000 ct.	39.00

Alpha Byte

COMPUTER PRODUCTS

routines are in machine code and are restricted. Their effect on the system is well known because all they are allowed to do is transfer data.

Buffer interrupts are allowed any time they are enabled. Thus, interrupt-buffer transfers can be much faster than user interrupt-service routines for data transfer. They are also easier to use.

The IBM Personal Computer has interrupt-input buffers that are used with the asynchronous communications adapter. In Personal Computer Advanced BASIC, the statement COM ON activates the buffer while ON COM specifies the line number of the program subroutine that will periodically empty the buffer. After executing each program line, the Advanced BASIC interpreter checks to see if any characters have been received. If so, a GOSUB is executed to the subroutine specified by the ON COM statement.

Once you understand interrupt-buffer transfers, DMA buffers are

easy because they work the same way. A buffer is set up, filled, and transferred. The syntax is also the same. The only parameter that changes is the buffer type.

Only certain interfaces can support DMA transfers and only certain devices require DMA service. Since DMA requires special hardware, Hewlett-Packard desktop computers have only one DMA channel. Thus, only one DMA transfer can be active at one time.

Buffered I/O is a real convenience. It is another way of taking I/O hardware, such as interrupt and DMA circuitry, and making the capability available in an easy-to-use form.

How High Is the Ground?

It is a paradox that of all the signal wires used in interfacing, the most complex is the one that seems simple. Ground wires are generally ignored in the design of computers and interfacing circuitry. No signals are intentionally impressed on them.

Often, the number of ground wires in an interface cable is determined by how many conductors are left over after signal wires have been allocated. Naturally, this type of interface design leads to problems. These problems can lead to signal degradation, loss of data, and even destruction of equipment.

Why do designers include ground wires in the first place? Electricity flows in loops. The laws of physics dictate that current must always return to its point of origin. When we send a logic signal to a peripheral device, we send it in the form of a current. This current must have a return path of low impedance so that the peripheral device will observe the full signal strength. Any impedance in the return path (or the signal path) will diminish the signal observed by the peripheral. It should be clear, then, that one reason to provide a ground is to supply a low-impedance signal-return path. This type of ground is called a *logic ground*

PICK A SYSTEM!

\$2495. .5 MB STORAGE **COMPLETE** **\$2995. 1.2 MB STORAGE**

We're offering you our SB-80 system in either 5 1/4" or 8" disk drives, your choice. Either way your system comes with a full size (12" diagonal) non-glare tiltable green screen with 24 lines by 80 character format. Its multi-character set offers blinking cursor, underlining, reverse video, and half and zero intensity. The movable, detachable keyboard has a numeric pad with cursor control and function keys.

- Single Board Technology ■ CP/M® Operating System
- 4 MHz Z80A CPU ■ 64K 200ns Main Memory
- 8-Inch Dual Density Floppy Drives
- 5 1/4-Inch Dual Density Floppy Drives
- 2-Serial Ports ■ 2-Parallel Ports
- 4-Counter/Timers ■ Expandable

For further information about this limited offer call or write:



Colonial Data

Nationwide on-site and depot repair service
through the professionals at INDESERV

®CP/M is a registered trademark of Digital Research, Inc.

Colonial Data Services Corp., 105 Sanford Street, Hamden, Conn. 06514 • (203) 288-2524 • Telex: 956014

QUME

It doesn't cost more
to make the best
impression
with Qume.



When you buy a Qume daisywheel printer, you get superior speed and reliability at competitive prices, while other companies simply offer inexpensive printers. Now you can have close-to-home quality and service at across-the-ocean prices. So make the best possible impression with a Qume daisywheel printer. For more information and a free copy of our booklet, "There's a lot around in circles", call or write Qume (408) 942-4000. 2350 Qume Drive, San Jose, California 95131.

Qume.
A Subsidiary of ITT

Circle 323 on inquiry card.



The Only Complete Document Proofreading System
From Aspen Software
For CP/M, TRS-80 and IBM-PC Word Processors

PROOFREADER™

Featuring Official Version of Random House Dictionary

- *Complete Accuracy—looks up every word; does not use less accurate root word analysis
- + *Full Interactive Correction—standard (optional of TRS-80 Model I/III)
- *Instant Access to Dictionary
- *Compact—Random House Dictionary supplied in sizes to fit your system (50,000 words standard)

GRAMMATIK™

Beyond Spelling Checking

- *Detects typos, punctuation and capitalization errors, misused words and phrases
- *Analyzes Poor Writing Styles
- *Suggest Alternative Usages

= NO ERRORS

"The programs together (Proofreader and Grammatik) offer a dynamic tool for comprehensive editing beyond spelling corrections."

—Dona Z. Meilach in *Interface Age*, 5/82
"Grammatik is the perfect complement to a spelling check program."

—Dr. Alan R. Miller in *Interface Age*, 5/82
"If you use a word processor and a spelling checker, then you should investigate the unique capabilities of this program. Grammatik is a surprisingly fast and easy tool for analyzing writing style and punctuation."

—Bob Loudon in *InforWord*, 12/81

"For the user who is as tight with his dollar as I, Proofreader is the program of choice."

—Stephen Kimmel in *Creative Computing*, 3/82

Aspen Software also has its own full featured word processor called Writer's Companion for all these systems. One of the best implementations of Ratfor (Rational Fortran) is available, too, along with an automatic Ratfor pretty printer. Please call or write for more details about these products.

Grammatik and Proofreader are compatible with all CP/M, MS-DOS (incl. IBM PC), and TRS-80 word processors. Current CP/M formats: standard B, Northstar, Omikron, Osborne, Apple. Please call/or write for details of minimum system sizes and availability of additional disk and operating system formats. Shipping costs included. Please specify your system configuration when ordering. Dealer inquiries invited.

	Proofreader	Grammatik
CP/M, MS-DOS	\$129.00	\$150.00
TRS-80 Model II	\$99.00	\$99.00
TRS-80 Mod. I/III	\$59.00	\$59.00
Model I/III interactive correction option	- \$30.00	

Random House is a registered trademark of Random House, Inc. Other registered trademarks: CP/M: Digital Research; TRS-80: Tandy Corp.; MS-DOS: Microsoft; IBM: IBM; Proofreader, Grammatik: Aspen Software Co.

Aspen Software Co.

P.O. Box 339-B Tijeras, NM 87059
(505) 281-1634

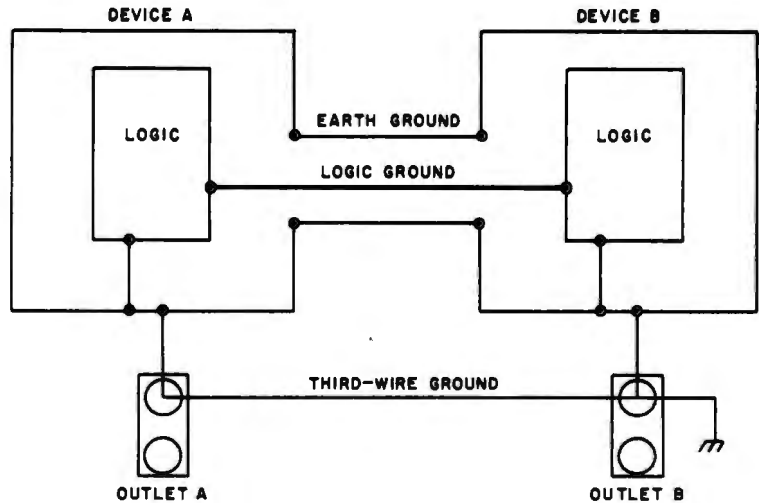

Figure 17: A diagram of the grounding of a typical computer system. Three ground wires connect devices A and B. One wire is the signal ground, which serves as the return path for signal currents. The second wire is the earth ground in the interface cable between the two devices. It provides safety by equalizing the potential between the two devices. The third wire, usually invisible and forgotten, is the ground wire in power cords.

This triple grounding can cause two kinds of problems. Ground-fault currents in other devices may flow through the third-wire ground, up the power cord, through the logic ground, and back down the other power cord. These currents usually exceed what the logic ground is designed for and a voltage develops between logic grounds of the two devices because of the small resistance in the wire. The voltage degrades signal margins by changing the voltage reference levels of the two devices.

The second problem is electromagnetic interference caused by a "noisy" logic ground, as represented in figure 18.

because it is associated with the logic signals. A second type of ground serves to ensure that the devices at either end are at or near the same potential.

One of the laws of interfacing states that there are never enough sockets on a wall power outlet to supply a complete computer system. At least one device will be plugged into another outlet several feet away. Most computer devices currently sold have three-pronged power plugs and use the third wire of the power outlet as an *earth ground*.

This earth ground is used as a safety ground to keep the voltage of exposed metal parts within safety limits. Unfortunately, due to haphazard wiring practices, there may be several volts of difference in potential between the third wire of one electrical outlet and the third wire of another outlet only a few feet away in the same room.

This potential difference is usually not large enough to pose a hazard to

humans, but it can kill a computer system. Signal levels for most interfacing systems today are 5 volts (V). A potential difference of only 2 or 3 V can destroy all trace of a signal. A potential difference of 20 or 30 V can destroy circuitry.

A safety or earth ground between devices can minimize this difference in potential. Once again, we seek the lowest possible impedance so that the potential difference is as small as possible.

Now that we have good logic and safety grounds between our computer and our peripherals, we can relax, right? Probably not. Chances are we have created the infamous *ground loop*. Figure 17 shows a system with just such a problem.

The computer and the peripheral are tied together with three grounds: a logic ground for the signal return, a safety ground for potential minimization, and the third wires in the power cords. The safety and third-wire grounds are connected together inten-

Your guide to the world of microprocessors.

The Micro-Professor™ - A low cost tool for learning, teaching and prototyping.

Here in one attractive package and at a price of only \$149.00 is a Z80* based microcomputer to lead you step by step to a thorough knowledge of the world of microprocessors.

The Micro-Professor is a complete hardware and software system whose extensive teaching

* Z80 is a trademark of Zilog Inc.

manual gives you detailed schematics and examples of program code. A superb learning tool for students, hobbyists and microprocessor enthusiasts, as well as an excellent teaching aid for instructors of electrical engineering and computer science courses.

But the Micro-Professor is much more than a teaching device. With it you can do breadboarding and prototyping, designing your own custom hardware and software applications with Z80, 8080 and 8085 compatible code.

The standard 2K bytes of RAM is expandable to 4K, and the standard 2K bytes of ROM can be increased to 8K.

All this plus a built-in speaker, a cassette interface, and

sockets to accept optional CTC/PIO. Bus is extendable.

As well as being an exciting learning tool, the Micro-Professor is a great low-cost board for OEM's. Call for details.

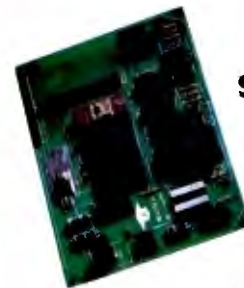

SSB-MPF Speech Synthesizer Board \$129

A vocabulary of up to 400 words based on the TMS 5200 chip.

EPB-MPF EPROM Programming Board \$169

For all +5V 1KB/2KB/4KB EPROMs. Read/Copy/List/Verify Capability.

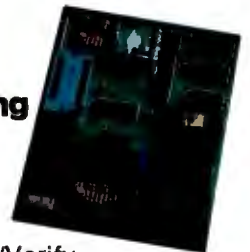

BASIC-MPF Tiny Basic \$19

2KB BASIC interpreter with hardware control capability. Machine-code subroutine accessible.

Circle 276 on inquiry card.

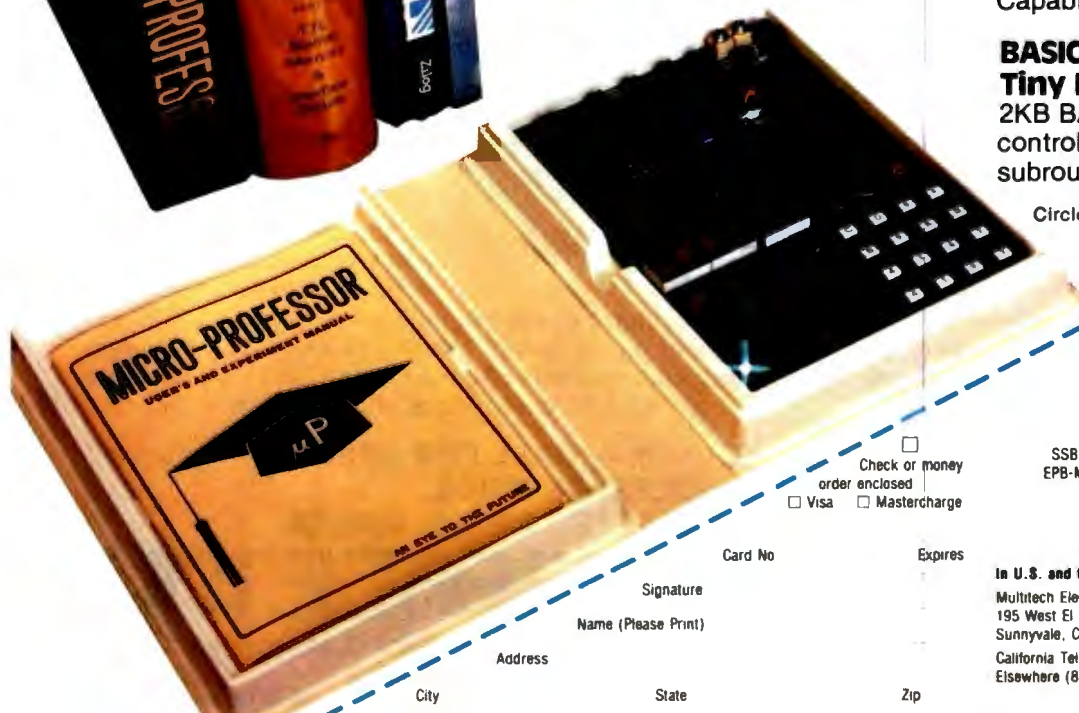

I'm ready to enter the world of microprocessing

Call toll free to order.

	Price	Qty.	Amount
MPF-I Micro-Professor	\$149.00		
SSB-MPF Speech Synthesizer Board	\$129.00		
EPB-MPF EPROM Programming Board	\$169.00		
BASIC-MPF	\$ 19.00		
Shipping and Handling	\$ 4.95		4.95
California residents add sales tax.			
TOTAL			

In U.S. and Canada mail to:
Multitech Electronics Inc.
195 West El Camino Real
Sunnyvale, CA 94086
California Tel. (408) 773-8400
Elsewhere (800) 538-1542

Outside of North America mail to:
Multitech Industrial Corporation
977 Min Shen E Road, 105
Taipei, Taiwan, ROC
Tel. 02-769-1225
TWX 19162 MULTIC.
23756 MULTIC

Check or money order enclosed
 Visa Mastercharge

Card No _____ Expires _____
Signature _____
Name (Please Print) _____
Address _____
City _____ State _____ Zip _____

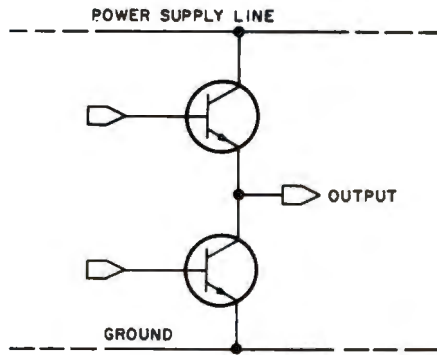

Figure 18: A diagram showing the frequent cause of electromagnetic interference by a computer system. Most digital systems have noisy logic grounds. Earth grounds usually shield this noise, but if the earth and logic grounds are connected, the noise will transfer to the shield and radiate from it. The result is interference with radio and television reception.

tionally. That loop cannot be avoided. The logic grounds in both devices are connected to a third-wire ground that is common in computer design. Loops are formed between logic and safety, logic and third-wire, and third-wire and safety grounds.

Two kinds of problems threaten this system. First, current may be flowing in the third-wire conductor

due to a faulty or leaky device someplace else in the power system. This will cause a voltage difference at the two power outlets A and B. We installed the good safety ground to add a low-impedance path and minimize this difference.

The current sees the dual paths of third-wire and safety grounds, and the voltage difference will indeed be

small. Unfortunately, the current will also see a third path to flow through, the logic ground. Typically, logic grounds are not designed to carry power-fault currents. They have higher impedance. Thus, a large current flowing through signal ground may prevent communications from taking place.

Since we added the grounds to allow the logic signals to be received reliably, we must also prevent ground loops from destroying that reliability. The best method is to plug all devices in a computer system into one electrical outlet. This assumes that there is enough current capacity on that circuit to supply the computer and all its peripherals with power. If there are not enough sockets on the outlet, use a power strip. The third-wire ground in a power strip is short and well defined, and will be of low impedance.

Electromagnetic Interference

Now that we have eliminated the effects of ground loops and our

DATAFACE GRQ SERIES INTERFACE

URNS YOUR ELECTRONIC TYPEWRITER INTO A PRINTER/TYPEWRITER



The Dataface GRQ-11 Interface expands your Olympia ES Series or Remington 200 Series electronic typewriters into a letter press quality printer for your personal or business computer. And, you still have a fully featured electronic typewriter—two machines in one.

The GRQ Series Interface features:

1. Standard EIA RS-232-C Serial Interface and Parallel (Centronics compatible).
2. Standard asynchronous ASCII code, 7 bit data; 1 start bit; accommodates 1 or 2 stop bits automatically; accommodates odd, even or absence of parity bit.
3. Fifty thru 9600 Baud data rate options.
4. Two K buffer; supports X-on, X-off protocol as well as RTS signals.

5. Circuit board is installed inside typewriter back panel along side logic board. The

connection between boards accomplished by 40 pin jumper cable using existing socket. No soldering required. Power is provided to the GRQ thru two pins of the 40 lead cable. Installation in 10 minutes.

GRQ-10 — CALL FOR SPECIAL WHOLESALE PRICE. SUGGESTED RETAIL \$349.50.

DATAFACE INC.

2372 A WALSH AVE., SANTA CLARA, CA 95050
(408) 727-6704

PKASO™

Interface

Your Color Connection

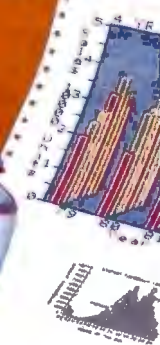

Now your Apple II or Apple III and
IDS Prism Printer can make beautiful
colors together.

New and exciting from Interactive Structures—the PKASO Color Interface is the latest family member in the PKASO line of high-quality, economical interfaces. A low-cost interface capable of adding a multitude of beautiful colors to your images and text.

With PKASO's advanced features, a few simple commands allow you to print in black and white or color: A quick copy of anything you see on the screen, SuperRes graphics up to 2160 x 1380 points on a standard page, photo-like graphics with 16-level gray scale processor. Plus . . . you can design your own printing symbols and characters. PKASO Interfaces are compatible with all major languages and options and are available for the following black and white printers: Epson, NEC, Okidata, Centronics, IDS and C. Itoh.

EVERY PKASO INTERFACE IS A MASTERPIECE OF QUALITY AND INNOVATION. And every one is backed by Interactive Structure's super service team. Discover PKASO today. Call us now for the PKASO dealer near you.

Dealer inquiries welcome to: Micro Distributors
(714) 641-0205 Micro Source of Texas (214) 690-5111

For ● II or ● III . . .

PKASO brings COLOR
& Graphics to your
Word Processor!!



PKASO Interfaces come complete with Cable, Instructional Diskette and Comprehensive Manual.



Interactive Structures Inc.
146 Montgomery Avenue
Bala Cynwyd, PA 19004
Telephone: (215) 667-1713

system is performing flawlessly, we can relax and listen to some music on the radio. Unfortunately, whenever the computer system is on, a lot of static appears on the radio. Worse, our neighbor down the hall notices the same effect. Welcome to the world of electromagnetic interference (EMI), the second problem in interfacing grounding.

Figure 18 is a picture of the output stage of a typical logic circuit. A transistor is connected to ground and the output signal line, and another transistor is connected between the power supply and the output signal line. If both transistors are turned on at the same time, a large current will flow and destroy the circuit. If only the top transistor is turned on, the output voltage will be close to that of the power supply. If only the lower transistor is turned on, the output voltage will be close to ground potential. The signal is switched by changing which transistor is on and which is off.

When this switching takes place, both transistors will be partially on

for a brief period of time. One is partially on but going off; the other is partially off but turning on. At this instant, a large current is allowed to flow from the power supply to ground through both transistors. This current spike will make the ground jump a bit through the small but finite impedance of the ground line.

Literally thousands of these output circuits are in a computer, switching constantly. All are adding their share of noise to the logic ground. This noise is carried out to the interface cable and over to the peripheral on the logic ground wires we ingeniously ran between the devices in our computer system.

The voltage spikes in the ground are too small to affect the interface logic signals, but the interface cable acts as an antenna and transmits this noise for all to receive. The thousands of output circuits team up to form a low-voltage but high-current signal. The actual logic signals are much lower current and don't cause as much trouble.

Two solutions to this problem are available. The first involves the use of low-impedance ground planes in the computer and peripherals to minimize the ground noise. The second is to shield the interface cabling to prevent the noise from escaping. These techniques are both used in Hewlett-Packard's desktop computers.

Finally, interface designers are attacking the ground-loop and EMI problems using a new interfacing technology: fiber optics. Glass optical fibers carry modulated light signals between devices. No grounds are used, which means no loops. Also, no antennas pick up and transmit noise.

Fiber-optic interfacing now costs more than the conventional interfaces covered in this series. Some applications requiring long distance or good noise immunity are already using fiber optics. Many more applications will do so in the future.

Conclusions

This primer has been written to expose you to many of the elementary concepts in computer interfacing. The connection of computers to peripherals and other computers is a vast and complex subject.

Microcomputers do not yet have the types of interfacing problems that larger computers face. The software tends to be simpler and smaller, and the data rates are slower.

But microprocessor manufacturers are determined to change the situation. The newer 16-bit microprocessors are every bit as complex as minicomputers. Software for these processors will also be as large and complex as that for minicomputers. And the interfacing requirements for the computers based on these microprocessors are sure to be more complex than the requirements of 8-bit machines.

Although the Chinese did not invent the microprocessor or an electronic interface, they do have a curse appropriate for the engineers who must master the complexity of the 16-bit microprocessors: May you live in interesting times! I hope that this primer will help you get through the interesting times that lie ahead. ■

ATTENTION APPLICATION PROGRAMMERS MCDISPLAY IS HERE

MASTERCOMPUTING has the answer to your biggest headache: user data entry.

Now devote your valuable time as a professional to the actual application rather than complex input prompt control and data entry checking.

DISPLAYMASTER is a two part screen oriented data entry system

- | | |
|--|--|
| <p>1. DISPLAYDEF - Development Utility</p> <ul style="list-style-type: none"> • Define screen formats • Define entries, prompts, messages, text • Document screen format • Build screen files | <p>2. DISPLAYASM - Powerful assembly calls</p> <ul style="list-style-type: none"> • Build screens, process entries • Handle messages and prompts • User callable directives and primitives • Screen fields transparent to program |
|--|--|

DESIGN CONCEPTS

- | | |
|--|--|
| <ul style="list-style-type: none"> • Large system approach • User friendly • Language and system independent • Complete entry checking, conversion & protection • Low RAM and Disk overhead | <ul style="list-style-type: none"> • High speed operation • Screens easily changed & tested • Professional documentation • Maintenance free • Low cost - \$175.00 with Manual |
|--|--|

SYSTEM REQUIREMENTS

- CP/M™ 1.4 or 2.2 with cursor addressable terminal or CRT
- Languages - Microsoft Basic-80 and BASCOM. Other popular languages to follow

FUTURE ATTRACTIONS

- MCFILE - a data base definition system with user directives
- MCPRINT - a page oriented print system with user directives

BASIC 80 and BASCOM
are products of Microsoft
CP/M is a trademark
of DIGITAL RESEARCH



MasterComputing Inc.
P.O. Box 17442
Greenville, SC 29606
(803) 244-8174

Plot your next meeting yourself.

Read how 2 pens can become your best presentation tools.

Introducing the New Personal Computer Plotter from Hewlett-Packard.

Now you can use your personal computer to generate your own presentation charts, graphs, and pie charts. How? Simply add on the new high quality, low cost HP 7470A Personal Computer Plotter.

The 7470A helps you save time and save money, and lets you communicate quickly, accurately and *effectively*.

Quicker understanding.

Data, when visualized graphically, becomes information fast. Charts and bar graphs can make any presentation clearer and more readily understood. But asking your staff to produce the graphics manually for your next presentation doesn't ensure accuracy or artistic talent. And going to outside graphics suppliers can be costly. Combined with your personal computer, the new HP 7470A plotter does the communicating for you. Quickly. Logically. And with off-the-shelf software available from most HP dealers.



Fast and pretty.

The 7470A gives you high plotting speed with excellent line quality...faster than any competitive small plotter. On top of all that, it comes in an attractive design package that looks nice on your desk. And it does it for only \$1,550. (U.S.A. domestic suggested retail price.)

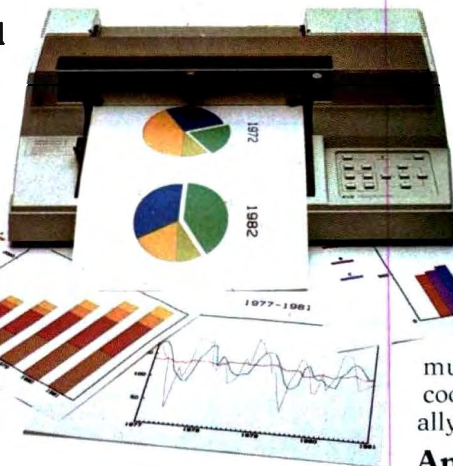

Count on it.

The 7470A is built the Hewlett-Packard way. To last. Designed and engineered with only a few parts, none of which require adjustment. And with customized integrated circuits that ensure reliability.

Pen pals.

The HP 7470A has two single-pen stables. Simple pen changes give you multi-color plots in your choice of ten coordinated colors. Pens are automatically capped and stored.

An option you'll want, too.

For only \$95, you can also get a 17057 Overhead Transparency Kit that turns your plots into transparencies for overhead projectors. For "I need it tomorrow at 9:00 A.M.!" meetings, it's a necessity.

Start plotting your next presentation today. Clip and mail the coupon below. Now.

Mail the coupon below and we'll send you—absolutely free—a sample plot, a more detailed brochure, and a sample overhead transparency.

Then...stop in at your nearest Hewlett-Packard Dealer. See the HP 7470A in action. Once you see it demonstrated you'll find a hundred ways to make your own applause-winning presentations.

When performance must be measured by results



Circle 177 on inquiry card.

Seeing is believing. Send me a sample plot, an overhead transparency, and more detailed information.

Name _____ Title _____

Company _____

Address _____

City, State & Zip _____

Phone Number () _____

Send to: Hewlett-Packard, 16399 W. Bernardo Drive, San Diego, CA 92127—Attn: Nancy Carter

11203 BT-7

Computers, Fiction, and Poetry

Stories and poems written by computers are hardly masterpieces, but they do shed some light on creativity.

Kevin McKean
c/o BYTE Publications
POB 372
Hancock, NH 03449

Writing poetry with a computer is like eating spaghetti with a fork a yard long. It can be done, but it's not easy. —computer poet Louis Milic

Pity the poor computer poet. While the computer has gained grudging acceptance as a tool for the artist or musician, it remains an odd duck in the hands of the creative writer—except, perhaps, as a word processor. True, computers are used for many other literary tasks: preparing concordances (indexed lists of all the words in a text), studying the quantitative aspects of style, and resolving questions of authorship. Yet computer poets and writers often are regarded by fellow literati with a mixture of fear, derision, and antagonism. Even computer scientists sometimes consider this work either wasted or doomed to failure. Part of the hostile reaction stems from the general quality of computer-generated verse and prose. It is frankly

awful, as its human programmers readily admit.

Yet computer-assisted literature shows no signs of dying out. From the whodunit to medieval Chinese verse, from the fairy tale to the operatic libretto, virtually every literary form has been, or is being, attempted with computers. (Last October *Omni* magazine even published a piece of science fiction said to be written by computer.) Computer authors maintain they are not trying to produce great literature, but rather to understand the workings of the human mind. As researcher Natalie Dehn of Yale University puts it: "I'm trying to construct a model of what makes people creative. If my model is correct, then my program should be able to make up interesting stories." In this respect, delving into the workings of the mind, the slender works of computer literature speak volumes.

Prose Becomes Poetry

Computer poetry traces its origins to a discovery made accidentally by Louis Milic and other early workers in the field of computer-generated prose. Milic, now a 59-year-old

English professor at Cleveland State University, had programmed a computer to generate simple sentences—"A shirt thought with a dog," "A house sat to a picture," and so forth—by randomly substituting words in a rigid framework. To his surprise, he found that this sort of nonsense made people think of poetry.

"The question was," Milic says, "why would a sentence generated by a computer be mistaken for poetry?" The answer, he reasoned, must be that many people are used to poems' not making sense.

A Comparison

Compare the following two poetic excerpts:

1

*Because the pleasure-bird whistles
after the hot wires,
Shall the blind horse sing sweeter?*

2

*What does she put four whistles
beside heated rugs for?*

The first is from the poem "Because the Pleasure Bird Whistles" by Dylan

About the Author

Kevin McKean is a staff writer for *Discover* magazine.

Thomas; the second was written by a computer. True, Thomas's lines are more melodic and haunting. But isolated from context, they make just as little sense as the computer's odd question.

Milic decided to test his theory that readers are accustomed to poems' not making sense. He took some of Dylan Thomas's poems and let a computer rearrange them. "My students couldn't always tell which poems had been doctored and which were genuine," Milic recalls. He then wrote a program called Erato, ambitiously named for the muse of lyric poetry, that used an elaborate algorithm to scramble and rescramble words from the first lines of 10 famous poems. Readers who know Gerard Manley Hopkins's poem beginning, "Margaret, are you grieving" will recognize it in one of Erato's more successful attempts:

*Margaret, are you saddening
Above the windy jumbles of the tide.*

*Wave to me in the peace of the night.
Jealousy is not all: It is not refreshment
nor water.*

*Return to me in the pause of the
shade,
Darling, because my spirit can chime*

*Above the early flounces of the
stream.
Margaret, are you saddening?*

Milic explains: "What we accomplish by this is to learn something about poetry. It doesn't weaken our admiration for poets. On the contrary, it deepens it because we see how much easier they do what the programmer and machine are trying to do." Milic produced a computer-scrambled version of the poem "Return" by Alberta Turner that prompted Turner to write four new poems in response. "The random-generating power of a computer can produce combinations which the human brain normally would exclude as either meaningless or offensive to its sense of order," Milic says. Turner agreed, calling this randomizing "a

valuable step in initiating or restimulating the poetic process."

Although Milic's experiments would give nightmares to an Oxford don, they are not without precedent. Jonathan Swift, in *Gulliver's Travels*, described a mechanical writing machine that allowed "the most ignorant person . . . [to] write books in philosophy, poetry, politics, law, mathematics, and theology without the least assistance from genius or study." More recently, the dadaists in the 1920s and the beatniks in the 1950s experimented with composing poems by randomly clipping words from newspapers and other printed sources. A computer, however, is far more efficient.

This efficiency points to one of the first problems with computer

"I'm trying to construct a model of what makes people creative."

poetry—the sheer volume of poetry that can be produced very quickly. Richard Bailey, a University of Michigan professor who has studied this subject, says it reminds him of the sorcerer's apprentice who ordered his broom to fetch water and then was nearly drowned in the deluge. Bailey cites the case of one poet, Robert Gaskins, who wrote a program to create haiku and then sent the output directly to a video-display terminal. New haiku would appear at the bottom of the screen, scroll slowly to the top and disappear forever. Within months, Bailey says, Gaskins and his computer "became the most prolific poetic collaborators of all time." But there was never any sense of loss in seeing a haiku scroll up into infinity, Bailey says, because another one would be along in a moment.

The Seeds of Revolt

While programs like Erato and the haiku generator left the computer with little more to do than randomly select from among lists of words, other scientists were trying to give the machine more responsibility. One of

these researchers was Sheldon Klein at the University of Wisconsin. In the early 1970s, Klein, a linguist and professor of computer science, collaborated with his students to devise a program to write 2100-word mystery stories in 19 seconds each. The group soon followed with a program to create Russian fairy tales.

More recently, Klein says, he and his students have invented a program to write operas. Like the earlier two programs, the opera-writer is divided into two parts. A simulator generates the plot in a special symbolic language devised by the group, then translators turn the symbolic plot into words, music, and moving pictures of the action. (The music is generated by an Apple; other functions take place on a Terak computer. The simulation language, whose name is written as five vertical slashes and pronounced "bar-bar," is based on UCSD Pascal.)

To facilitate display on a video terminal, the opera is based on Edwin Abbott's nineteenth-century fantasy *Flatland* about a two-dimensional world, and it is titled *Revolt in Flatland*. Klein and his colleagues showed a video-taped sample at the Fifth International Conference on Computers and the Humanities in Ann Arbor, Michigan, last year. But, says Klein, "I'm not keen on showing it because, to be perfectly frank, the music is superb but the action is quite dull." This is because the action simulator treats the cast's movements as if they were taking place on a realistic scale, rather than compressed onto a stage. "Most of what's happening in the current version is that little squares and triangles and polygons are moving slowly from one house to another. The action only happens occasionally, when they meet," Klein says. A refined version of *Revolt in Flatland* is being prepared which will automatically omit the boring scenes. In the meantime, says Klein, "Potentially, our opera could be five hours long, like a real opera, but at the end there would be nobody watching."

Klein's early programs allowed the computer to develop a plot but gave only limited consideration to the motivations of individual characters.

One of those who set out to solve that problem was Jim Meehan, now an artificial-intelligence researcher at the University of California at Irvine.

Tale-Spin's Fables

Meehan's 1976 program, called Tale-Spin, created stories that were modeled loosely after Aesop's fables. Characters with names like Joe Bear, George Ant, and Irving Bird lived in a simple universe with rivers, fields, caves, and trees. The human author set the plot in motion by giving one of the characters a motive such as hunger, thirst, sleepiness, or a desire for sex (primly referred to by Tale-Spin as "fooling around"), and the characters then wheeled and dealt with one another in symbolic form to resolve their goals. Meanwhile, a natural-language translator reported on their movements to the outside world. Here is a sample of the raw output:

Once upon a time George Ant lived near a patch of ground. There was a nest in an ash tree. Wilma Bird lived in the nest. There was some water in a river. Wilma knew that the water was

in the river. George knew that the water was in the river. One day Wilma was very thirsty. Wilma wanted to get near some water. Wilma flew from her nest across a meadow through a valley to the river. Wilma drank the water. Wilma wasn't thirsty any more.

In this particular story, George Ant goes on to fall in the river and is rescued by Wilma Bird. The fall has been planted by the human programmer; the rescue came about because all characters are automatically motivated to rescue any other character they know is in danger of dying. Tale-Spin kept track of the social relationships between its characters, and it made a list of each character's goals, crossing out goals as they were accomplished. But it was prone to silly mistakes. For example, in one fable, a character named Henry Crow inadvertently dropped a piece of cheese and was soon mired in an endless loop of bargaining with himself to get the cheese back. The program didn't realize that its internal representations of "Henry Crow" and "himself" were the same character.

When Tale-Spin worked, it created stories of a natural simplicity reminiscent of folk tales (see the illustration below).

The problem with Tale-Spin, says Meehan, who is 32, was that its stories lacked purpose. "There was no overall goal as to what the story would be about. It might be filled with perfectly rational behavior, but it might not be particularly interesting, just as what you and I do in a day may be rational but may not constitute a story." For this reason, Meehan doubts that efforts to invent a "story grammar"—a set of rules for creating good fiction—will ever succeed, although many authors and scholars have tried to devise such rules. Says Meehan: "It doesn't take much literary education to find a half-dozen great stories that don't fit the model and another half-dozen terrible stories that do."

Author's Purpose

Building on Tale-Spin's approach, Yale's Natalie Dehn is creating a more ambitious program that considers what the author wants from a story. "The author has goals, things she



Once upon a time, there were two bears named Jack and Joe, and a bee named Sam. Jack was very friendly with Sam but very competitive with Joe, who was a dishonest bear.



One day, Jack was hungry. He knew that Sam Bée had some honey and that he might be able to persuade Sam to give him some. He walked from his cave, down the mountain trail, across the valley, over the bridge, to the oak tree where Sam Bee lived.



Jack asked Sam for some honey. Sam gave him some.

wants to accomplish," says Dehn, a 28-year-old researcher in artificial intelligence. "She starts off with an initial intent but may wind up with something quite different. I'm trying to model what the author is doing."

Dehn's program, appropriately called Author, starts with a general idea for a story but then refines and focuses the idea as it goes. It may even abandon the first idea in favor of a better one. But, thanks to a memory model developed by Roger Schank, the program is also capable of being "reminded" of earlier ideas and returning to them. In this respect, it is like a human author who is reminded of people, situations, and events from his or her own life, or from earlier versions of a work of fiction, and then incorporates them into a story. Dehn's interest in such problems dates to high school when, she says, "I began to think that the most interesting problems were in the humanities but that the best methods for problem-solving were those of science."

A program like Author has come a long way from the random-generated poetry writers of the 1960s and early

1970s because it "understands" what it is doing. Dehn calls the earlier programs, which only simulated intelligence, "hack programs"; the classic of these was the popular Eliza, or Doctor, program that mimicked a psychiatrist talking to a patient.

The story-generating methods being developed for Author will find practical use in another program, which Dehn is writing to help adults

**When Tale-spin
worked, it created
stories of a natural
simplicity reminiscent
of folk tales.**

who are poor readers. This program, called Starship, will generate a story in which the user is a crew member on a space vessel engaged in an important mission. At crucial times in the plot the program will ask the reader what should be done next. "The moves he makes," says Dehn, "will tell how well he has understood the story so far." As a training tool, the Starship program will have elements in common with such games as

Dungeons and Dragons, in which the user becomes the lead character in what amounts to an adventure novel, or with commercial software adventures that allow the user to walk through branches of fictional possibilities.

Where Will It Lead?

Today's computer-generated literature is limited in part by the difficulties of producing a natural language but even more so by the fundamental problem of giving a computer the capacity to find interesting things to say. As a result, computer literary products are still quite crude. Yet they point to exciting things ahead: poems that write or revise themselves, novels in which the reader is a character or author, and so forth. All of this may not satisfy critics today, but it heralds an interesting and lively future. As computer poet Milic says, "People who scoff at computer poetry are simply not thinking. It would be like complaining, as people did when Gutenberg came around, that the word of God was not meant to be printed by machine." ■



Then Joe Bear walked over to the oak tree and saw Jack Bear holding the honey.



He thought that he might get the honey if Jack put it down, so he told him that he didn't think Jack could run very fast. Jack accepted this challenge and decided to run. He put down the honey and ran over the bridge and across the valley.



Joe picked up the honey and went home. (This story was created by Meehan's Tale-Spin program. He translated the story into more conventional English from the choppy sentences of the original.)

Illustration by Coni Porter

Scion Color System

Mark Dahmke
Consulting Editor

In the November 1980 BYTE (see "The MicroAngelo Video Display," page 196) I reviewed the Scion Microangelo graphics display—an S-100 board that provides 512 by 480 dot resolution. The board contains a Z80 microprocessor and 32K bytes of memory, making it one of the most powerful graphics displays of its class. It has only one limitation—no color or gray levels. Each dot out of 245,760 dots is either on or off.

Now, Scion has announced the Microangelo Color System, which consists of a set of Microangelo boards connected together through a color mixer or palette board. With more than one board contributing to the display, each dot or pixel (picture element) can be described by enough bits to specify a color or other intensity for each pixel.

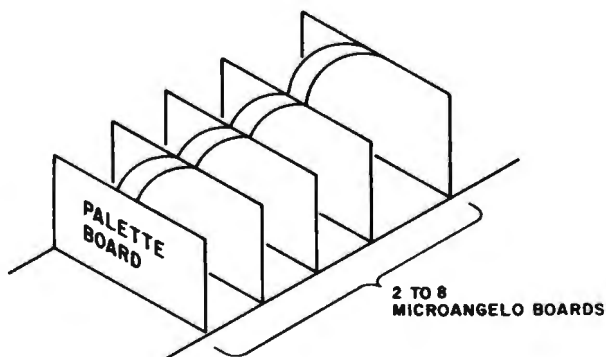

Figure 1: Scion Color System hardware organization. From two to eight Microangelo S-100 boards may be connected via 20-pin ribbon cable to the palette board, which selects colors and generates RGB output for a color monitor.

The color system offers unprecedented capabilities for its low price. Because each Microangelo has an on-board computer, you can send commands to each board and have them processed simultaneously. The palette board mixes the outputs of multiple (from two to eight) Microangelo boards by looking for the color value represented by parallel bits in the parallel Microangelo boards. In a two-board system, you could display 4 different colors; in an eight-board system, 256 different colors. Each color-palette entry is defined in red, green, and blue (RGB) components, each of which can range from 0 to 100 percent in 256 steps. This means that on a full system, you could choose 256 colors out of a palette of more than 16 million colors.

Figure 1 shows the hardware organization of the color system. The palette board must be present on all versions, but you can start with two Microangelo boards and work up to eight. A 20-conductor ribbon cable connects the boards to the palette board. Each Microangelo has its own Z80 running at 4 MHz and on-board firmware in PROMs (programmable read-only memories). The firmware can be either Screenware Pak I or Screenware Pak II, which offers the additional capabilities of region flooding, hardware and software test routines, split screen for separate alpha and graphics regions, firmware circle drawing, and macro definition allowing the on-board Z80 to draw frequently used shapes or objects. I will not spend much time describing the firmware features of the Microangelo; I suggest that you read my review in the November 1980 BYTE.

The Palette Board

Figures 2 and 3 show how the palette board converts bitplane information into colors. The software must set

the appropriate bits in the Microangelo boards so that the bits make up the number of the color-palette entry. When the display is generated, the palette board converts the number into separate red, green, and blue values, which are in turn sent to the RGB color monitor. The process is really quite simple and powerful. Note that the color of an object on the screen can be changed after the fact by simply changing the color-palette entry for that combination of bits.

Software and Firmware

As mentioned earlier, the Screenware Pak I and II PROMs are on board the individual Microangelo bitplanes. The system is very fast because each board receives its commands and executes functions such as drawing a vector or circle. A software package called Colorpak that manages these high-level functions is included. Colorpak is written as a subroutine library, callable from FORTRAN-80. It greatly simplifies the development of an application program. If you want to draw a vector in color number 3, you would code the following:

```
CALL CURCLR(3)
CALL GRCUR(100,100)
CALL VECTOR(120,150,-1)
```

The first statement selects color 3 (which was previously defined in the program). The second line moves the graphics cursor to screen coordinates 100,100. The third statement draws a vector from the graphics cursor location to 120,150. The -1 parameter tells the Colorpak to draw the vector in the currently selected color.

It is also possible to group bitplanes into "transparencies." This is like having several windows or screens that overlap each other. For example, you could set up two transparencies with four bitplanes, allowing 16 colors per transparency. One transparency could have a grid on it, while the other could display a floor plan for a building. The two transparencies can be displayed separately or overlaid in several ways. First, you could display the floor plan on top of the grid, or for measurement purposes, you could put the grid on top. This can be changed dynamically by subroutine calls without redrawing the image.

You can also decrease the intensity of a transparency to any percentage of full intensity. Whenever there are multiple transparencies, the color palette is automatically configured to display the color that has precedence—the color from the transparency that overlays all others. You can mix colors that overlap, creating a new color. One possible use for this feature would be in circuit-board layout. The wiring diagram for a circuit could be displayed, with the cross-over points highlighted in a different color.

The hardware also allows winking bitplanes. When configured to wink, the display will alternate between

At a Glance

Name

Scion Color System

Type

512-by-480-resolution color graphics system that can display up to 256 colors out of a palette of more than 16 million colors

Manufacturer

Scion Corporation
12310 Pinecrest Rd.
Reston, VA 22091

Price

Color System with two Microangelo boards (4 colors), \$2,495; with six boards (64 colors), \$6,495; with eight boards (256 colors), \$8,495; for Screenware Pak II, add \$400, plus \$40 for each extra board beyond the first. A fully configured eight-board system with Pak II would cost \$9,175. RGB color monitors are available at \$2,495.

Features

Up to 256 colors on one display with a full eight-board system; a light pen is optional. Each board has a Z80 running at 4 MHz (which can run at 6 MHz), 32K bytes of main memory, room for 8K bytes of EPROM memory (used for Screenware Pak I or II), and 512 by 480 dot display. Palette board has RGB generation circuits and high-speed look-up memory for palette selection.

Firmware

Full firmware to generate vector graphics and characters; high-level commands sent via parallel ports. Functions include: drawing vectors, plotting points, and generating characters (normal or double size; rotation is also available). Screenware Pak II can flood a region with a color.

Software

Several CP/M-compatible programs are available including COED, a color editor program that displays a palette on the screen and lets you build colors from either the RGB or HLS models. A FORTRAN-80-compatible subroutine library (Colorpak) is provided so that high-level commands can be executed without having to understand or program the hardware. Three sample programs are also on the distribution disk as well as the source listing (in FORTRAN) for the Colorpak subroutine library.

Computer Needed

Any S-100-compatible computer or any computer that has an S-100 bus adapter. Although the Color System uses a Z80 microprocessor, the host processor does not have to be Z80 or 8080 compatible. If you plan to use the COED and Colorpak software, you must be able to run it with CP/M and FORTRAN-80 (or a similar language). You will also need a wide-bandwidth (15 MHz or more) RGB color monitor. Monitors are also available from Scion.

Documentation

A 131-page Color System manual is provided along with a pocket reference card for the Colorpak subroutine library calls and the Microangelo hardware manual (80 pages). Documentation is adequate but not exceptional.

Audience

Anyone requiring high-resolution color graphics on an S-100 system

two colors about every second. This feature also could be used to highlight information on the screen.

The Color Editor

Defining an organization of transparencies and colors can be difficult at best. It is very handy to be able to see the colors as you mix them on the palette. Scion has gen-

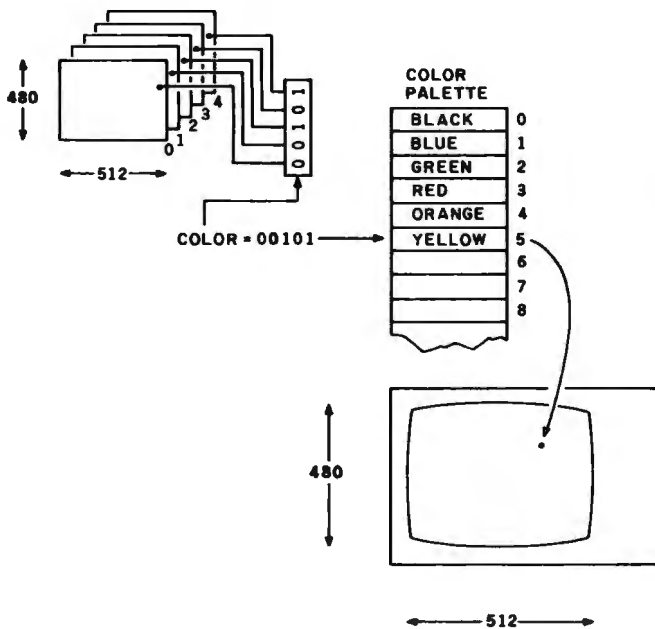

Figure 2: The palette board uses information from each bitplane as a color number that points to a color palette entry. The user may load the color palette with any of 16 million colors by mixing red, green, and blue.

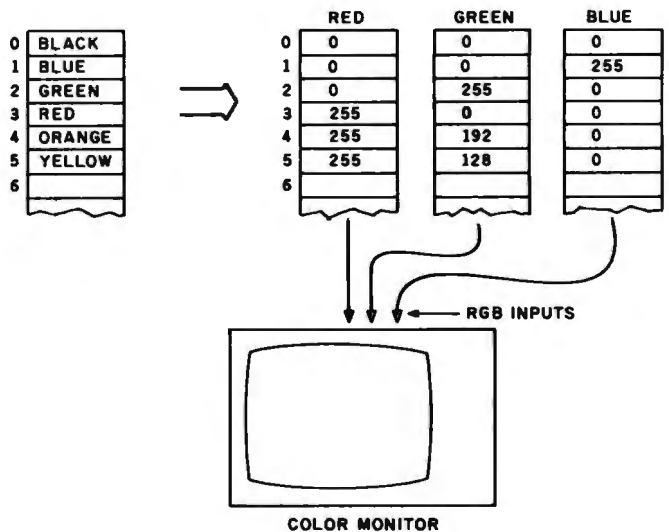

Figure 3: The color palette actually consists of three separate values, one for each primary color. Red, green, and blue may each be specified, in a range of 0 to 100 percent, in 256 steps. The resulting color values are sent to the red, green, and blue guns on an RGB color monitor. This process is repeated for each of the 245,760 dots or pixels every 1/60 second.

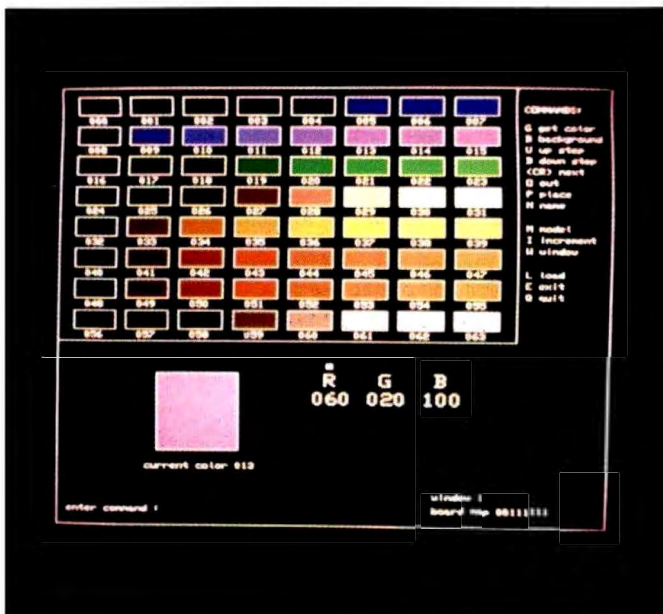

Photo 1: A sample display of the Scion Color Editor. This utility program allows you to create color libraries for application programs. After setting up a group of colors, the library may be stored and later loaded into a user program. This particular display was used in my application program for demonstration purposes. It represents the spectral colors of the main sequence of stars. Each horizontal row is a spectral color: very blue, blue, green, white, yellow, orange, red, and a second white row. Photo by Mark Dahmke.

erously provided a color editor that aids in the design of an application. The color editor is a large program that draws a set of one-inch-long boxes on the color display. A small command language allows the user to vary each of the RGB components of each palette entry to see the resulting colors. When a color has been selected, it can be stored in one of the 64 palette entries. Actually, there are up to 256 palette entries (if you have eight bitplanes), but only 64 are displayed at one time. Photo 1 shows the color editor with a typical palette of colors.

The editor normally uses the RGB method of building and mixing colors, but the HLS (hue, lightness, saturation) model can also be used. Figure 4 shows the topology of this model. At first it may look quite confusing but is really a useful model. Hue is measured in degrees, from 0 to 360. Blue is at 0, red is at 120, and green is at 240. Note that all of the primary additive colors are at 120-degree increments around the circle. Yellow appears at 180 degrees. Lightness is measured in percent, from 0 to 100. Zero percent is black, regardless of the hue and saturation values, and 100 percent will produce white. Saturation is also measured from 0 to 100 percent and is really a measure of the chroma or amount of color visible. It is graphically represented in figure 4 as the radius of the color circle.

Colorpak Functions

Working with Colorpak is like working with a combination of a Tektronix graphics terminal and the IBM 2250 graphics display. Most of the subroutine calls are obvious, e.g. "CALL VECTOR" and "CALL POINT,"

and the color system requires a fair amount of initialization. You must do one of two things: use the color editor to define a set of colors and one or more transparencies, or use Colorpak to define the same. With the color editor, the task is quite simple. To load a screen organization and color palette, you would code:

```
CALL GETSYS('FILENAME',0)
```

where "FILENAME" is the file defined by the color editor, and 0 indicates that it is on the current disk drive.

If you wish to do it the hard way, the following sequence might be used:

```
CALL CINIT(112,3,240,224,208,0,0,0,0,2)
CALL DEFTRN(1,3,0,0,0,0,0,0,0)
CALL PUTCLR(1,1, 0, 0,255,0,0,0)
CALL PUTCLR(1,2, 0,255, 0,0,0,0)
CALL PUTCLR(1,3,255, 0, 0,0,0,0)
CALL PUTCLR(1,4,255,192, 0,0,0,0)
CALL PUTCLR(1,5,255,128, 0,0,0,0)
CALL ERASE(1,1)
```

The first statement initializes the color system and defines it as having three bitplanes at decimal I/O (input/output) port addresses 240, 224, and 208. The last parameter is 2, which tells the Colorpak that you are using Screenware Pak II. The second line defines a transparency structure with one transparency of three bitplanes. The next five lines assign colors to the palette. This particular initializa-

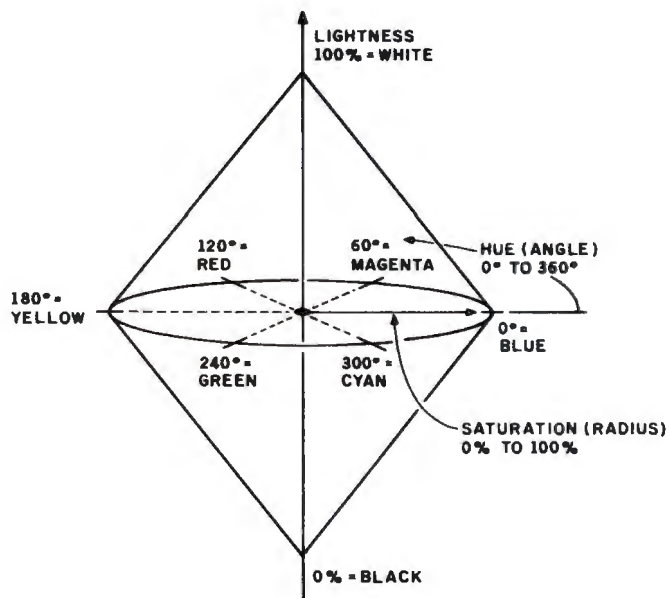

Figure 4: The HLS color model. Either the RGB or HLS models may be used in the Scion Color Editor (COED) program. The HLS model is diagrammed as a pair of cones, with the vertical axis representing lightness. The top is 100 percent white; the bottom is black. Hue is represented as an angle where 0 degrees is pure blue, 120 is red, and 240 is green. Saturation is represented as the radius of the cone. A saturation of 0 percent will produce a gray scale of lightness from 0 to 100 percent.



Photo 2: A sample illustration on the Scion Color System. Photo courtesy of Scion Corporation.

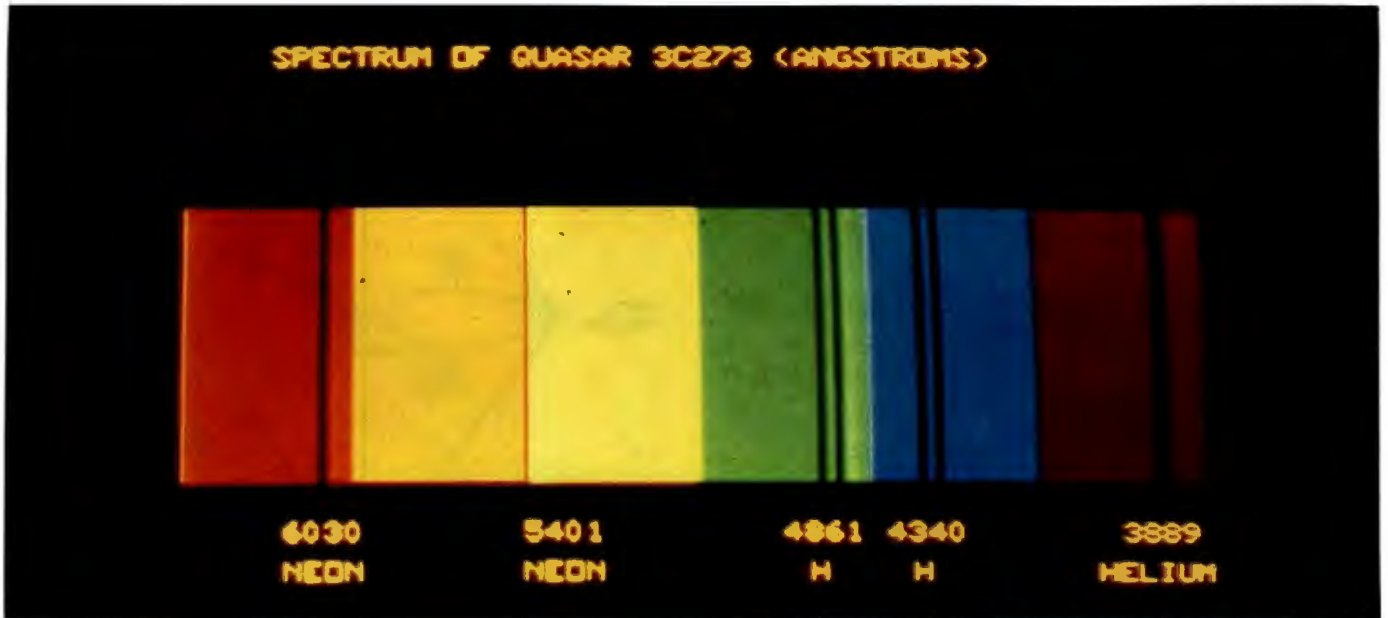

Photo 3: A simulation of an absorption spectrum of a quasar on the Scion Color System. Photo courtesy of Scion Corporation.

tion will make the system look like the examples in figures 2 and 3. The last call is made to erase transparency 1.

Colorpak has some useful subroutines such as FLOOD, which will fill a bounded region with the currently selected color. The fill algorithm is in firmware, so it runs very fast. FADE will fade out a transparency to a percentage of its full brightness, and FUSE will fuse colors in

overlapping transparencies. MOVTRN allows you to change the display precedence of transparencies. As with the Microangelo video display, cross hairs and a light-pen interface are available.

A Real-Life Application

After trying out the samples included on the CP/M dis-

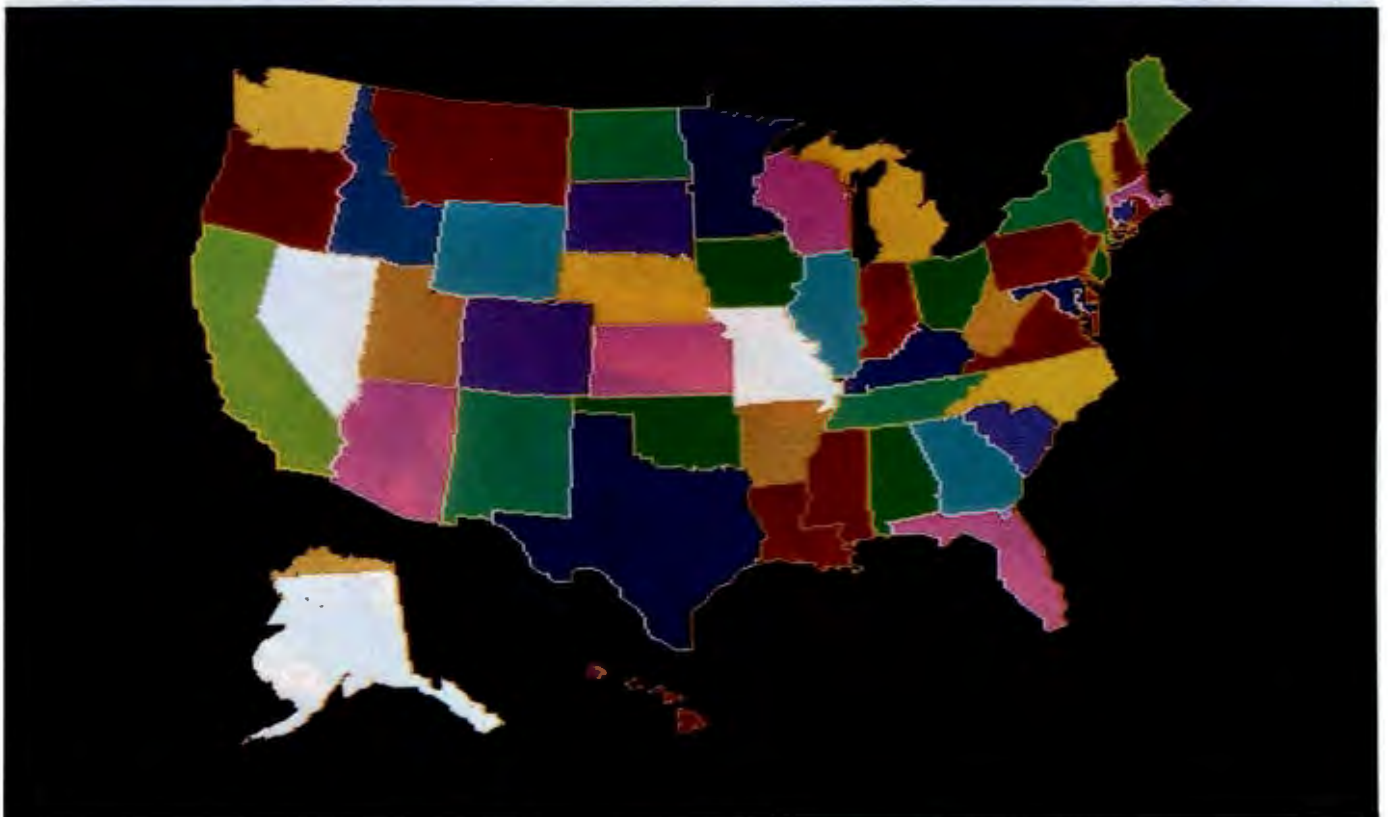

Photo 4: A sample illustration on the Scion Color System. Photo courtesy of Scion Corporation.

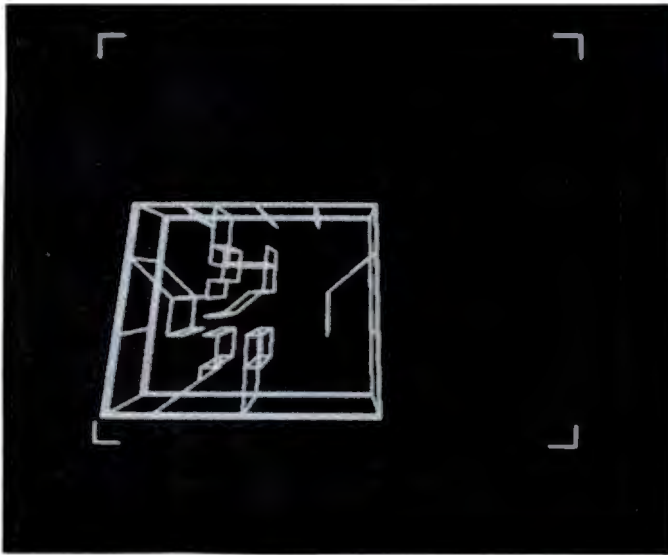

Photo 5: A sample of Ken Livingston's three-dimensional architectural modeling program on the Scion display. Photo by Mark Dahmke.

tribution disk, I pulled out my old favorite—the three-dimensional model of the galaxy (see "A Simulated View of the Galaxy" April 1979 BYTE, page 66). I decided to include stellar magnitudes (brightness) and spectral color for a better effect. I down-loaded the FORTRAN program from an IBM System/370 on which I had been run-

ning it and recompiled the program on my CP/M system. I added the initialization calls, using a color library I defined with the aid of the color editor. Photo 1 shows the resulting color palette, which has seven different colors, each with eight intensity levels. In astronomy, the colors of the stars are categorized as O, B, A, F, G, K, and M. These are very blue, blue, green, white, yellow, orange, and red, respectively. (A second white row appears at the bottom.) Other samples of color graphics are shown in photos 2, 3, 4, and 6.

Conclusions

I have had the Scion Color System for several months, and I really don't want to give it up. It is one of the most convenient graphics systems I have ever worked with. The best test I could give it was my star map program, which used almost all the features of the system. The fact that I down-loaded the FORTRAN program from an IBM computer and modified it to run on the Scion system in less than three hours also says a lot for the system. BYTE author Ken Livingston and I also down-loaded Ken's architectural three-dimensional modeling system. It took one evening to change the graphics interface and recompile it on my CP/M system, then a few more hours to fine tune it. After that we were able to generate wire models of buildings and project different views of them. Photo 5 shows a sample of Ken's program. ■

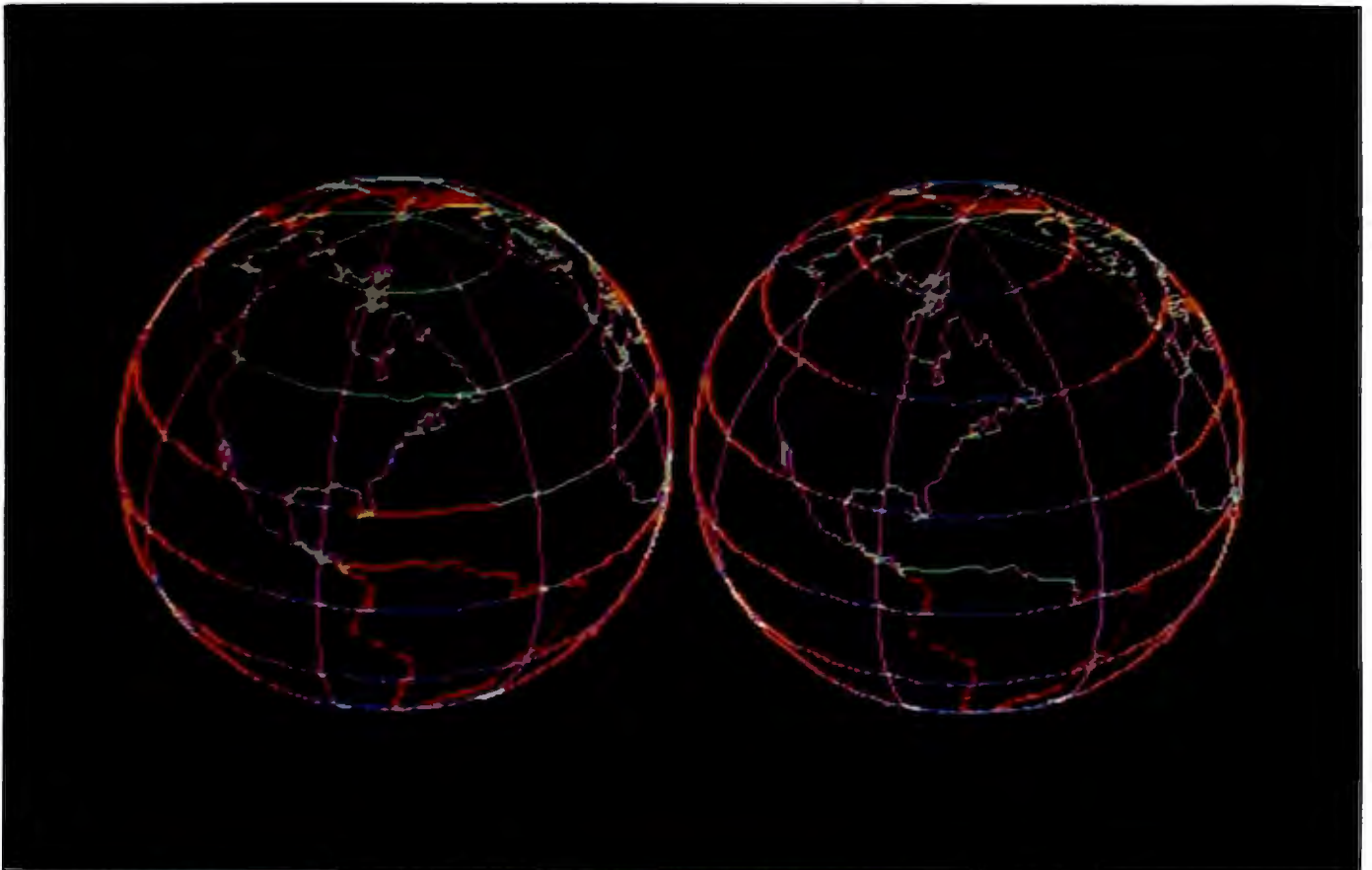

Photo 6: A sample illustration on the Scion Color System. Photo courtesy of Scion Corporation.

Add Programmable Sound Effects to Your Computer

Silicon replaces gunpowder for producing sound effects.

Steve Ciarcia
POB 582
Glastonbury, CT 06033

The explosions were still ringing in my ears as I peered through the smoky atmosphere. Suddenly behind me I heard someone open fire with a phaser. I whirled, expecting to be vaporized. Then I remembered where I was.

I had gone down to the local convenience store to get a quart of milk, and I had walked past a row of video arcade games.

The lifelike sound effects associated with arcade games represent the fruit of years of work in various technologies. In the past, sound men for radio serial dramas kept in their bags of tricks such objects as coconut shells, squeaky hinges, and watering cans. Producing sound effects involved physically producing the noise through mechanical means. This often required talent rivaling that of the actors.

Copyright © 1982 by Steven A. Ciarcia.
All rights reserved.

Today the sand board and coconut shells are gone. Physically produced sound effects have given way to the electronic synthesizer and the computer. You can simply sprinkle a little pink noise through a programmable attenuator to make a horse gallop or trot on command.

Surprising sound effects can be obtained with relatively little hardware.

Computerized sound generation has not eliminated a profession, however. It has added a new dimension to entertainment. The sound effects used in movies such as *The Empire Strikes Back* could not have been produced 30 years ago.

Sound generation of that quality is of course beyond the typical Circuit Cellar project, but surprising results

can be obtained with relatively little hardware. This month I'm working with the SN76489A sound-generator integrated circuit from Texas Instruments. (Another TI product, the SN76494N, is identical to the 76489A except that it runs at a lower clock frequency.) These two chips are shown in photo 2 on page 62.

In this article, I'll describe a sound-generating circuit that can be connected to virtually any computer. I'll also provide some sound-effects routines in BASIC for you to use with your own computer arcade games.

SN76489A: General Structure

Figure 1 is a block diagram of the SN76489A integrated circuit. The chip contains four signal sources: three independent generators of single-frequency tones and one generator of noise. In addition, each source has its own attenuator with a 28-dB (decibel) attenuation range. The output signals from the four attenuators



Photo 1: You don't need a pistol to produce the sound effect of a gunshot. The Texas Instruments SN76489A integrated circuit can produce the same sound under program control.

are summed together as a single amplified output.

The 76489A is sealed in a 16-pin DIP (dual-inline package) and is designed for connection to and operation with computer address and data buses, appearing to the computer as a write-only location in memory or I/O (input/output) address space. Commands are communicated to the sound-generator chip's internal registers via its own 8-bit data bus during the interval of activation of the Write Enable and Chip Enable lines by corresponding strobed signals. Typically, this is accomplished by tying the address decoder's output to the 76489A's Chip Enable pin and the computer's Read/Write line to the Write Enable pin.

The SN76489A is designed to run at a maximum clock frequency of 4 MHz (megahertz) and loads data rather slowly. The input data must remain stable during the 32 clock cycles (16 μ s [microseconds]) that the

76489A requires to load an 8-bit data value. When the loading has been completed, the sound-generator chip brings its Ready line to an active-low state. This signal can be used to halt the computer processor for the required time if necessary. We'll find out more on the process of loading data later.

Sound Possibilities

Each of the three tone generators in the 76489A contains a presettable 10-bit programmable down counter used as a variable frequency divider. The output frequency of each generator is selected by loading the 10-bit count register through a command from the processor. The counter is decremented by a submultiple of the clock frequency; when the count register reaches zero, it toggles a flip-flop. The output signal from the flip-flop becomes the output of the tone generator, which is a square wave.

With a 2-MHz clock frequency, as

is found in many typical computer systems, the 10-bit counters allow the 76489A to cover a range of five octaves: from two octaves below middle C to three octaves above it. This is wide enough for most applications. The output frequency of a given tone generator is defined by the following equation:

$$f = n / 32 \times I$$

where f is the tone generator's output frequency, n is the system's clock frequency (here assumed to be 2 MHz), and I is the decimal equivalent of the 10-bit counter register's contents.

The noise generator is a 15-bit exclusive-OR feedback shift register that produces pseudorandom noise, which is generally used for sound effects such as explosions and gunshots. The rate at which the register shifts determines whether the noise contains a majority of high-frequency or low-frequency components. The

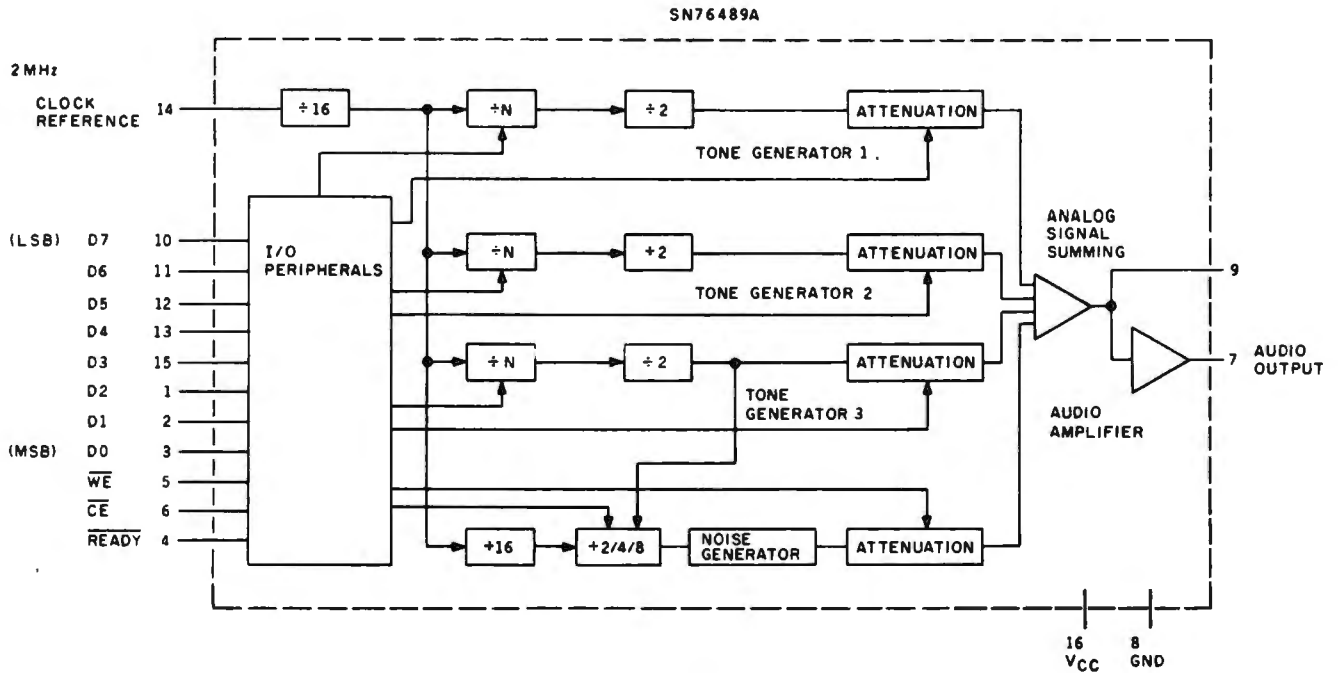

Figure 1: Block diagram of the Texas Instruments SN76489A sound-generator integrated circuit, which runs at a maximum clock rate of 4 MHz. The similar SN76494N runs at a clock frequency of 500 kHz (kilohertz).

shift rate can be controlled by the frequency set on tone generator 3 or independently through the noise-generator-control register.

The output attenuators, one for each of the four sources, are loga-

rithmic and designed primarily for musical applications. The 4-bit attenuator range is from 0 dB (maximum amplitude) to -28 dB (minimum amplitude). The sixteenth step, which would be predicted to set the amplitude to -30 dB, turns the attenuator off. By very quickly turning the attenuators on and off or changing their control values, you can synthesize interesting envelope effects to simulate bells or a piano.

The four attenuator outputs are added together through an analog summing circuit, and the combined output is then amplified to 10 mW (milliwatts) with a voltage swing of about 2 V (volts), but an external power amplifier is required to drive a speaker.

An Easily Built Interface

While the 76489A can be attached directly to a microprocessor's bus, given a suitable address-decoding and data-latching scheme, the details of such a connection depend on which processor is used, and the design requires attention to accommodating the register-loading delay. To avoid this, I designed a parallel interface

that is neither processor- nor load-time-dependent.

The design, shown in the schematic diagram of figure 2, is a four-chip sound-generator circuit that incorporates the SN76489A. It can be attached to an 8-bit latched parallel output port that uses a data-ready strobe line (a Centronics-compatible printer port will work). A prototype of the circuit is shown in photo 3 on page 65.

In the figure, note that the data lines B0 through B7 are oriented to follow general interfacing conventions in the matter of bit hierarchy rather than the Texas Instruments format. In the TI hierarchy, bit 7 of every byte is the LSB (least significant bit), and conversely bit 0 is the MSB (most significant bit). This just happens to be the way TI does things. The TI system is used later in the descriptions of the SN76489A's internal registers.

I have chosen to run the sound generator at 2 MHz. IC1 and IC2 (inverter sections and a flip-flop) generate this frequency, dividing a 4-MHz crystal-oscillator output by 2. (If you have a 2-MHz or 4-MHz signal handy

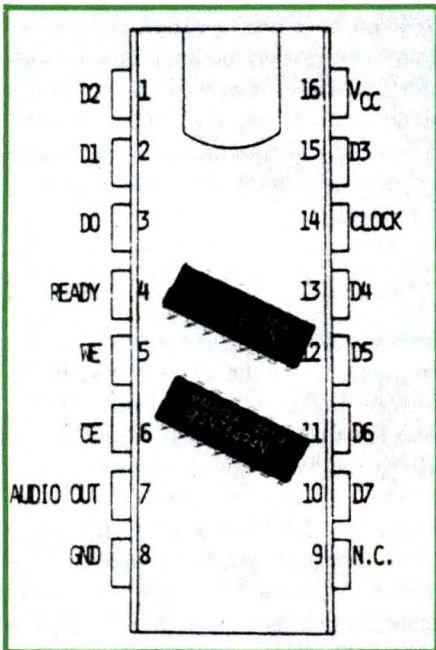

Photo 2: The SN76489A and its sibling the SN76494N are nearly identical, but operate at different clock frequencies.

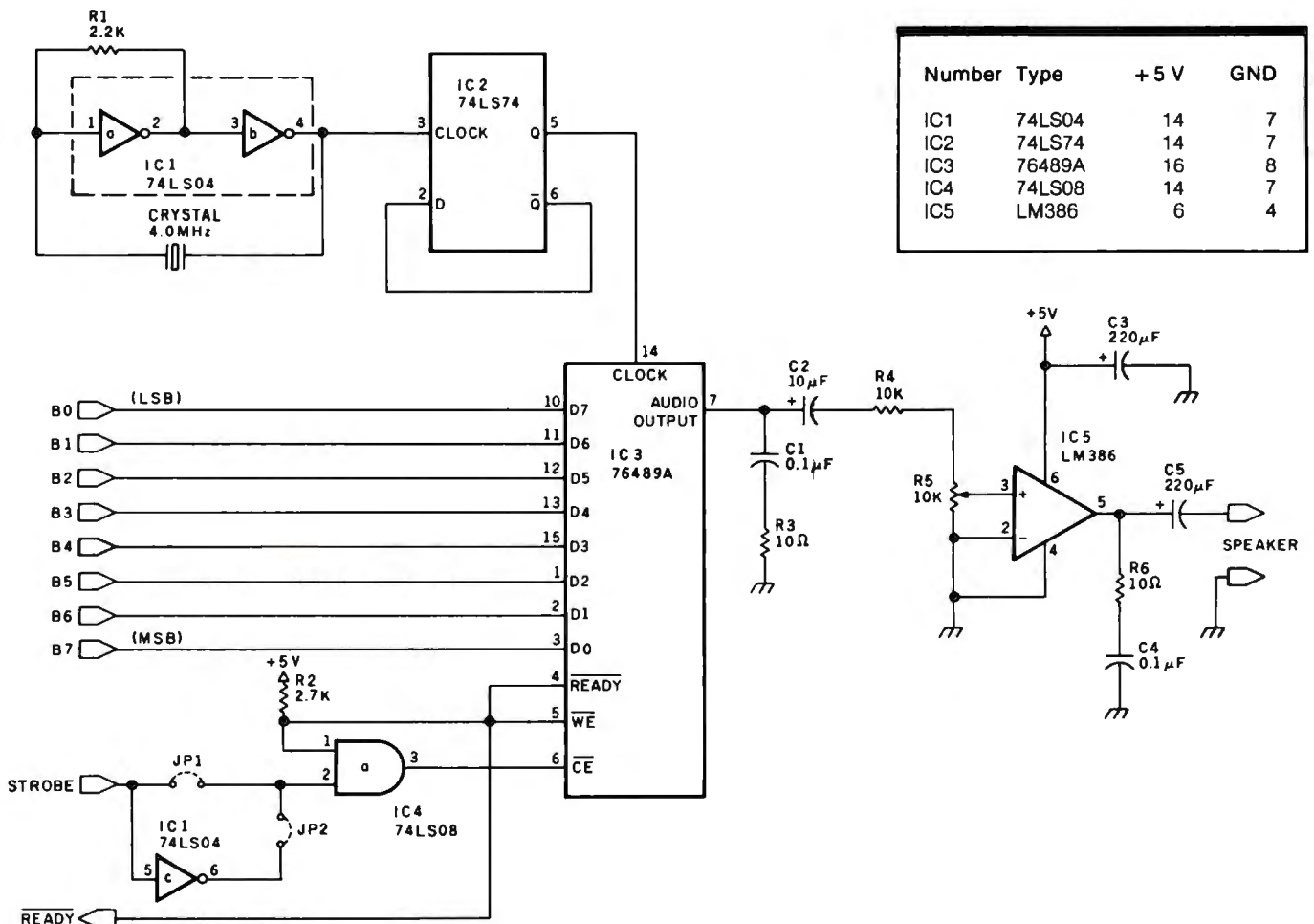

Figure 2: Schematic diagram of a sound-generating circuit incorporating the SN76489A designed to be attached to a computer system through a parallel I/O port. A source for parts is given in the text box at the end of the article.

in your computer, you could use it instead by connecting it to IC2 or IC3 [the SN76489A] as required, omitting the crystal.)

How It Works

The computer loads a byte of data into the SN76489A (IC3) by making it available on the data lines and then pulsing the Strobe input line. (The jumper connections JP1 and JP2 respectively select use of a negative-going strobe or a positive-going strobe signal.) This signal is passed through IC4 (an AND gate) to the Chip Enable (\overline{CE}) line of IC3. When the \overline{CE} line is strobed, the Ready line (IC3 pin 4) goes to a logic 0, triggering the Write Enable (\overline{WE}) input (IC3 pin 5). With a 2-MHz clock the Ready line stays low for 32 μ s while IC3 is being loaded. When it is finished, the Ready line goes high, and another byte can be loaded in a

similar manner. Configured as in this circuit, the processor must wait at least 32 μ s between byte transfers to the sound generator.

If you will be controlling the interface with a BASIC program, there is no possibility of sending data too fast. Most BASIC interpreters take at

Changes to registers will cause immediate changes in the audio output.

least 2 ms (milliseconds) to execute a statement. But some sound effects and music may not be easily generated by BASIC. In such cases, the interface must be driven with a machine-language program. To properly time the data transfer, the Ready line from the interface can be moni-

tored through an input port (such as the Printer Busy input of your Centronics port) or connected directly to the Wait input of the processor.

The output of the sound generator is amplified through a 1-W (watt) power amplifier (IC5) to drive a speaker.

Data Formats

Figure 3 on page 64 shows the three data formats used in programming the 76489A, which contains 8 registers (listed in table 1) that control the various noise and tone outputs. Noise or attenuation parameters are loaded as 1-byte values, while frequency updates require 2 bytes. (Figure 3 uses the TI bit hierarchy.)

The 76489A's input channel appears as a single address to any processor. To differentiate between the first and second byte of any data transfer, all first-byte or single-byte

R0	R1	R2	Control Register	
0	0	0	tone 1	frequency
0	0	1	tone 1	attenuation
0	1	0	tone 2	frequency
0	1	1	tone 2	attenuation
1	0	0	tone 3	frequency
1	0	1	tone 3	attenuation
1	1	0	noise control	
1	1	1	noise attenuation	

Table 1: Register addresses for controlling various functions of the SN76489A. These 3-bit values determine which of the registers receives that remainder of the bits in the control byte as data.

A0	A1	A2	A3	Attenuation Weight
0	0	0	0	0 dB
0	0	0	1	2 dB
0	0	1	0	4 dB
0	0	1	1	6 dB
0	1	0	0	8 dB
0	1	0	1	10 dB
0	1	1	0	12 dB
0	1	1	1	14 dB
1	0	0	0	16 dB
1	0	0	1	18 dB
1	0	1	0	20 dB
1	0	1	1	22 dB
1	1	0	0	24 dB
1	1	0	1	26 dB
1	1	1	0	28 dB
1	1	1	1	off

Table 2: Attenuation parameters for each of the signal sources. The SN76489A must receive an attenuation-control byte, formatted as shown in figure 3, before any output can be heard.

transfers have the most significant bit equal to a logic 1. The second byte always has the MSB equal to logic 0.

Programming Tones

Setting a frequency of 440 Hz for tone generator 1 is done as follows. First find *I*

$$I = n/32 \times f$$

$$I = (2 \text{ MHz}) / (32 \times 440)$$

$$I = 142.045$$

(3a) Update Frequency (2-byte transfer)

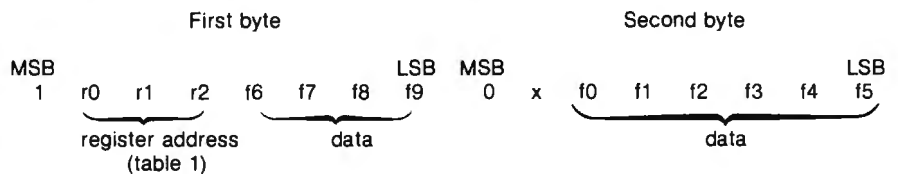

(3b) Update Attenuator (single-byte transfer)

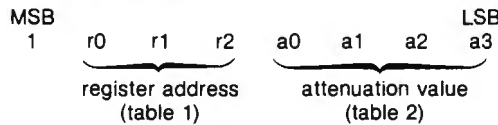

(3c) Update Noise Source (single-byte transfer)

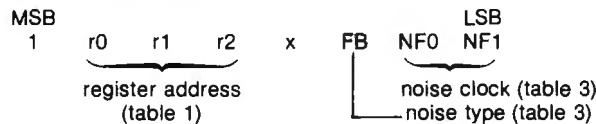
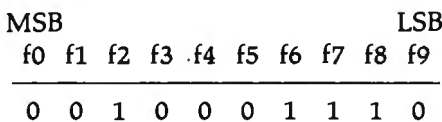

Figure 3: Formats required for programming the control registers in the 76489A. The first bit of the first control byte is always 1; the second byte, if used, has a first bit with a value of 0.

Since *I* must be an integer quantity, we set it to 142. The actual frequency will be 440.14 Hz.

Next, we convert *I* to a 10-bit binary value (using the TI bit hierarchy, where bit f0 is the MSB and f9 is the LSB):



(While I could have converted everything to follow the bit-hierarchy conventions of the rest of the world, anyone comparing this article to the specification sheets of the 76489A would become utterly confused. But the external interfacing connections to my circuit in figure 2 do follow the ordinary convention.)

The frequency data for tone generator 1 must be transferred to the 76489A as a 2-byte quantity. From figure 3a, we see that byte 1 must contain three register-designation bits, r0, r1, and r2, which denote that the value is to be applied as a frequency change for generator 1. We chose the value 000 from table 1 for these three bits.

We then see from figure 3 that 4 of the data bits go in the 4 low-order bits

of byte 1 and that the remaining 6 bits go in the 6 low-order bits of byte 2. The MSB in byte 2 must be 0, and one of the bits in byte 2 is not used.

Therefore, to set tone generator 1 at 440 Hz, the first control byte becomes

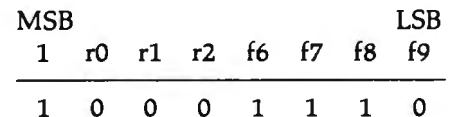

which is the same as hexadecimal 8E or decimal 142, and the second byte becomes

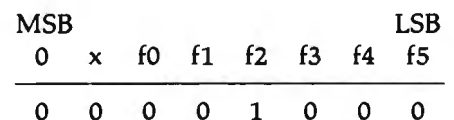

which is the same as hexadecimal 08 or decimal 8.

A simple way to load these values via BASIC is to execute the statements OUT *n*,142 and OUT *n*,8 where *n* equals the port address of the sound-generator interface. The argument of the first statement conveys the register address and the 4 low-order bits of the value to be loaded into the down counter. The second

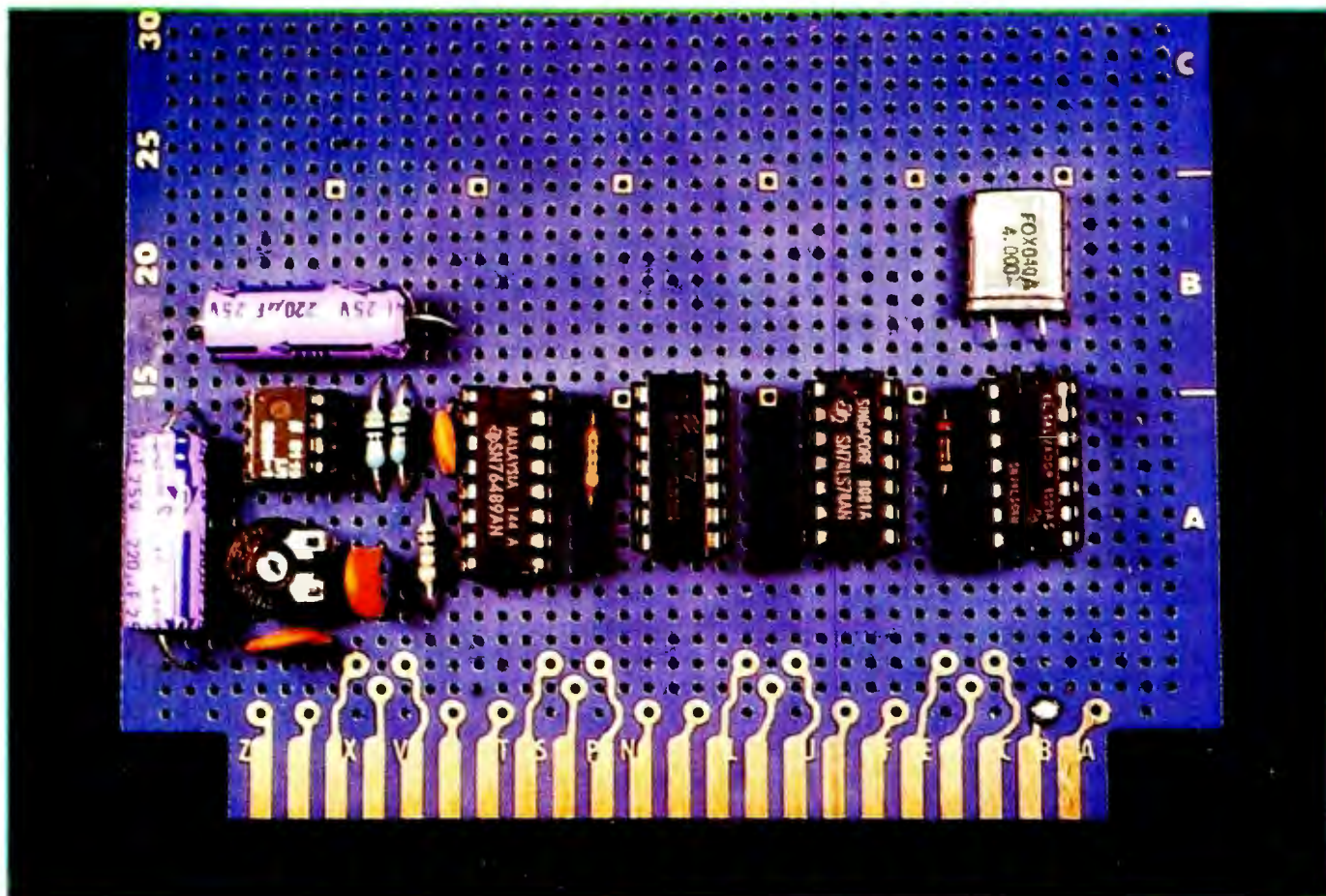

Photo 3: Prototype of the parallel-port-driven sound-generation circuit shown in figure 2.

argument contains the remaining 6 bits for the counter.

Once these values have been transmitted, tone generator 1 is loaded, but the attenuator has not been set to enable any output. Changing the attenuator setting requires only a single byte of data, set according to the attenuation parameters shown in table 2.

From table 1, we select the attenuation-register address of 001 for tone generator 1. A 0-dB attenuation setting (0000 from table 2) turns the volume on full. The resulting formatted control byte, according to figure 3b, is

MSB				LSB			
1	r0	r1	r2	a0	a1	a2	a3
1	0	0	1	0	0	0	0

which is the same as hexadecimal 90 or decimal 144.

To turn on the 440-Hz tone at full

volume, therefore, we have to execute the statement `OUT n,144` after we have set the tone parameters. To reduce the output amplitude by 4 dB, an `OUT n,146` statement would be executed.

Programming Noise

To change the output of the noise source, we change the noise-control and noise-attenuation registers. Both use single-byte commands, shown in figure 3c.

As shown in table 3 on page 66, the one of the bits is called the FB, or feedback, bit. This bit controls the feedback in the noise-generator shift register. If the FB bit is a logic 1, the result is white noise. If the FB bit is a logic 0, the feedback is disabled, and a lower-frequency repetitive (periodic) noise is produced.

Two bits, NFO and NF1, control the clock frequency fed to the noise-generator shift register. Four options are available: three options select fixed

rates (in the formulas, n is the 2-MHz clock frequency), or you can select the output of tone generator 3 as the shift-register clock. In the latter case, some interesting effects, such as sweep frequency noise, are produced when the frequency of tone generator 3 is varied.

Performance Hint

One last comment on loading registers. The SN76489A runs in real time. If you change a register, the results will be heard immediately after each byte is loaded. On a 2-byte frequency-change command, if the time delay between loading the first and second byte is extraordinarily long, it can result in some off-frequency notes being heard. When exercising the 76489A with a slow interpreted language such as BASIC, it is generally a good idea to shut off a tone generator's output before changing its frequency. After you have loaded the 2-byte value (or only a single byte if

FB	Configuration
0	periodic noise
1	white noise

NF0	NF1	Shift Rate
0	0	$n/512$
0	1	$n/1024$
1	0	$n/2048$
1	1	tone generator 3 output

where n = clock rate

Table 3: Noise-control parameters for the noise source. White or periodically varying noise may be produced; the output of tone generator 3 may be used to control the noise generator.

Note	I Value	Frequency
C	239	261.50 Hz
C#	225	277.77 Hz
D	213	293.43 Hz
D#	201	310.95 Hz
E	190	328.95 Hz
F	179	349.16 Hz
F#	169	369.82 Hz
G	159	393.08 Hz
G#	150	416.67 Hz
A	142	440.14 Hz
A#	134	466.42 Hz
B	127	492.13 Hz

Table 4: A diatonic scale may be played by the tone generators using the values of I shown here as control parameters loaded into one of the down counters. The frequencies produced are quite close to standard.

all 10 bits of the frequency specification don't have to be changed), the output can be turned on again. For single-byte register changes, the only concern is that the rate of change be consistent with the type of sound you are trying to produce.

Producing Tones in BASIC

Many variations are possible with such a versatile sound generator, and much of the experimenting can be accomplished without having to think in binary radix. A few simple lines of BASIC allow you to determine the value of I for a particular frequency and automatically format the 2-byte tone parameters.

Listing 1 is a program that facilitates testing of the interface and demonstrates some simple formatting techniques. You can hear the tone produced by any value of the down-counter register. The register value is entered as the value I. The second byte B becomes the result of the calculation:

$$B = \text{INT}(I/16)$$

and the first byte A is derived and formatted:

$$A = I - B * 16 + 128$$

In BASIC the sequence is executed as OUT n,A and OUT n,B (where n is the port address). Again, to turn on the tones, it is necessary to execute a statement to set the attenuators to some state other than off, as was

done before by the statement OUT n,144.

Should you care to experiment with a diatonic scale, a list of the appropriate values of I and the corresponding frequencies is shown in table 4.

Demonstration Programs

The program in listing 2 on page 68 uses these notes to play a few bars of "The Entertainer" by Scott Joplin. In this program, DATA statements are used to list each note (BASIC variable F) and its duration (D) as it is played on the tone 1 output. In addition, the program takes this same data and shifts it an octave and outputs it to tone generator 2 as well. The result is an interesting effect and a pleasing sound.

Listing 3 is a further example of using the tone generators. This program simulates a clock chime, striking 12 times. The sound is synthesized by mixing and linearly attenuating two tones that are close in frequency.

Finally, no article on sound effects would be complete without a program to produce phaser and explosion sounds. Listings 4 and 5 on page 70 fulfill this requirement. In both cases, the noise generator is the key ingredient.

To produce a phaser sound, the noise generator is set to white noise with its clock rate controlled by the output of tone generator 3. When the phaser sound is to be heard, the frequency of tone generator 3 is swept, and the attenuation is linearly ramped down.

Listing 1: A BASIC program to test and demonstrate the SN76489A circuit, and to possibly inspire other ideas for programming it. The sound generator is assumed to be interfaced to the computer through a parallel I/O port.

```

100 REM      ****      SN76489A TONE TEST      ****
110 N=17 :REM Sound Generator port address
120 OUT N,159:OUT N,191:OUT N,223:OUT N,255 :REM Clear Outputs
125 REM Tone output is clock/32*I -- Enter I to test tone output
130 PRINT"Divider Valve = ";INPUT I
150 B=INT(I/16)
160 A=I-B*16+128
200 OUT N,A :OUT N,B :REM Set 2 byte tone value on 76489A
220 OUT N,144 :REM Turn on Tone 1 Output
230 FOR X=0 TO 1000 :NEXT X :REM Delay
240 GOTO 120

```

Introducing **INTEX-TALKER™**

The Professional Voice Quality Text-to-Speech Synthesizer that makes sense



Unlimited Vocabulary

64 Programmable levels of inflection

Built-in 6k text-to-speech algorithm

INTEX-TALKER, the new second generation text-to-speech synthesizer, incorporates all of the features of earlier synthesizers that have requested. Created by Steve Ciarcia, nationally known computer and peripheral equipment designer, INTEX-TALKER provides a new high level of speech intelligibility and voice quality. You've got to hear it to believe it!

INTEX-TALKER translates ASCII characters into speech with an advanced text-to-speech algorithm. Simply type English text and a talk command into your keyboard. User friendly? What could be simpler?

Important Uses of Speech Synthesis

INTEX-TALKER brings a new dimension to interactive computer communications. Available as a stand-alone peripheral or at the board level, INTEX-TALKER provides a real time audio interface for applications in data processing, telecommunications, automation, education or handicapped markets. It can announce data transmitted at high baud rates over telephone lines or serve as an unlimited vocabulary audio interface for telephone transaction applications. Featuring 64 digitally programmable levels of inflection, INTEX-TALKER offers a unique, high fidelity professional voice quality.

Equipped with keyboard, INTEX-TALKER can function as a typewriter for the blind or as a communicator for the vocally impaired. Every ASCII character is recognized (including punctuation) as it is typed and can be echoed automatically.

As a computer-aided educational device, INTEX-TALKER can provide interactive student instruction on literally any subject. For entry level students, INTEX-TALKER can provide a user friendly environment enhancing the learning process and encouraging the development of student familiarity with the computer keyboard.

And with home computers, INTEX-TALKER adds both fun and utility. Computer games come to life. Your computer can now speak instructions, warnings, praise — and it has music and sound effects capabilities, too.

You can easily apply the capabilities of INTEX-TALKER to any of your home computer uses; security, education, or home management.

Easy to Operate

ASCII code is sent to INTEX-TALKER through either the RS232C or parallel interface. The English text is stored in a 750 character buffer until the processor commands it to be automatically translated into electronically synthesized speech. For example: type the ASCII characters spelling "I-N-T-E-X" to cause the word "INTEX" to be spoken on command.

Independent Operation/No Overhead

INTEX-TALKER can also be used as a dedicated controller. It has user expandable memory with 16k ROM and 8k RAM capacity.

With its own 6502 microprocessor and built-in 6k text-to-speech algorithm, INTEX-TALKER operates without overhead. The host computer is free to execute other programs while INTEX-TALKER is speaking.

At Only \$295.00 INTEX-TALKER

Offers These Features:

- Phoneme based speech synthesizer chip
- 64 crystal controlled inflection levels - digitally programmable
- 6k text-to-phoneme algorithm
- 750 character buffer
- Full ASCII character set recognition and echo
- Adjustable Baud Rate (75-9600)
- RS232C or Parallel connectors
- X-on/X-off handshaking
- Phoneme access modes
- User expandable memory
- Music and sound effects capability (programming language for notes included)
- Onboard amplifier & power supply ±12V; +5V
- Spelling output option

Order Now

Call the number below to order or request additional information. Master Charge or Visa accepted. Charge to your credit card or send a check for \$295.00 plus \$4.00 delivery. Add 4% sales tax in Michigan.

Dealer inquires invited.

INTEX

Intex Micro Systems Corporation
755 West Big Beaver Road - Suite 1717
Troy, Michigan 48064
Telephone: 313/362-4280

Listing 2: A BASIC program that plays part of "The Entertainer" by Scott Joplin.

```
100 REM      **** THE ENTERTAINER by Scott Joplin ****
110 REM      **** Played on the SN76489A ****
120 REM
130 N=17 :REM Tone Generator Address
140 GOSUB 370 :REM Clear Outputs
150 DATA 239,8,213,8,201,8,190,8,120,8,190,4,120,8,190,4,120,16
160 DATA 2,2,120,8,107,8,101,8,95,4,120,4,107,4,95,4,127,6,107,8
170 DATA 120,16,0,0
180 DIM F(50),D(50)
190 FOR I=1 TO 30
200 READ F(I),D(I)
210 IF F(I)=0 THEN 230
220 NEXT I
230 E=I :I=1
240 B=INT(F(I)/32)
250 A=F(I)/2-B*16+128
260 OUT N,A :OUT N,B :REM Set 1ST Octave Value
270 B=INT(F(I)/16) :A=F(I)-B*16+160
280 OUT N,A :OUT N,B :REM Set 2ND Octave value
290 OUT N,144 :REM Turn on Tone 1
300 OUT N,176 :REM Turn on Tone 2
310 FOR X=0 TO 20*D(I) :NEXT X :REM Hold Tone 1/4,1/2, or Whole
320 I=I+1 :REM Increment Note Counter
330 IF I=E THEN GOSUB 370 :END
340 GOTO 240
350 REM
360 REM
370 OUT N,159 :OUT N,191 :OUT N,223 :OUT N,255
380 RETURN
```

Listing 3: Program that simulates the ringing of chimes.

```
100 REM      **** CHIME SOUND ****
110 REM
120 N=17 :REM Tone Generator Address
130 GOSUB 1000 :REM Clear All Outputs
135 REM
140 REM Set Tone 1 to 679 Hz
150 OUT N,140 :OUT N,5
160 REM
170 REM Set Tone 2 at 694 Hz
180 OUT N,170 :OUT N,5
185 REM
190 FOR T=0 TO 11 :REM Strike Chime 12 Times
200 FOR A=145 TO 159 :REM Loop to Generate Attenuation Steps
210 OUT N,A :OUT N,(A+32)
220 FOR Q=0 TO 65 :NEXT Q :REM Delay While Sounding Chime
230 NEXT A
240 NEXT T
250 REM
1000 OUT N,159 :OUT N,191 :OUT N,223 :OUT N,255
1010 RETURN
```

WHY THE MICROSOFT RAMCARD™ MAKES OUR SOFTCARD™ AN EVEN BETTER IDEA.

Memory — you never seem to have quite enough of it.

But if you're one of the thousands of Apple owners using the SoftCard, there's an economical new way to expand your memory dramatically.

16K ON A PLUG-IN CARD.

Microsoft's new RAMCard simply plugs into your Apple II®, and adds 16k bytes of dependable, buffered read/write storage.

Together with the SoftCard, the RAMCard gives you a 56k CP/M® system that's big enough to take on all kinds of chores that would never fit before (until now, the only way to get this much memory was to have an Apple Language Card installed).

GREAT SOFTWARE: YOURS, OURS, OR THEIRS.

With the RAMCard and SoftCard, you can tackle large-scale business and scientific computing with our COBOL and FORTRAN languages. Or greatly increase the capability of CP/M

applications like the Peachtree Software accounting systems. VisiCalc™ and other Apple software packages can take advantage of RAMCard too.

And RAMCard gives you the extra capacity to develop advanced programs of your own, using the SoftCard and CP/M. *Even with the RAMCard in place, you can still access your ROM BASIC and monitor routines.*

JOIN THE SOFTCARD FAMILY.

The RAMCard is just the latest addition to the SoftCard family — a comprehensive system of hardware and software that can make your Apple more versatile and powerful than you ever imagined.

Your Microsoft dealer has all the exciting details. Visit him soon, and discover a great idea that keeps getting better.

Microsoft Consumer Products, 10700 Northup Way, Bellevue, WA 98004. (206-828-8080)

16k

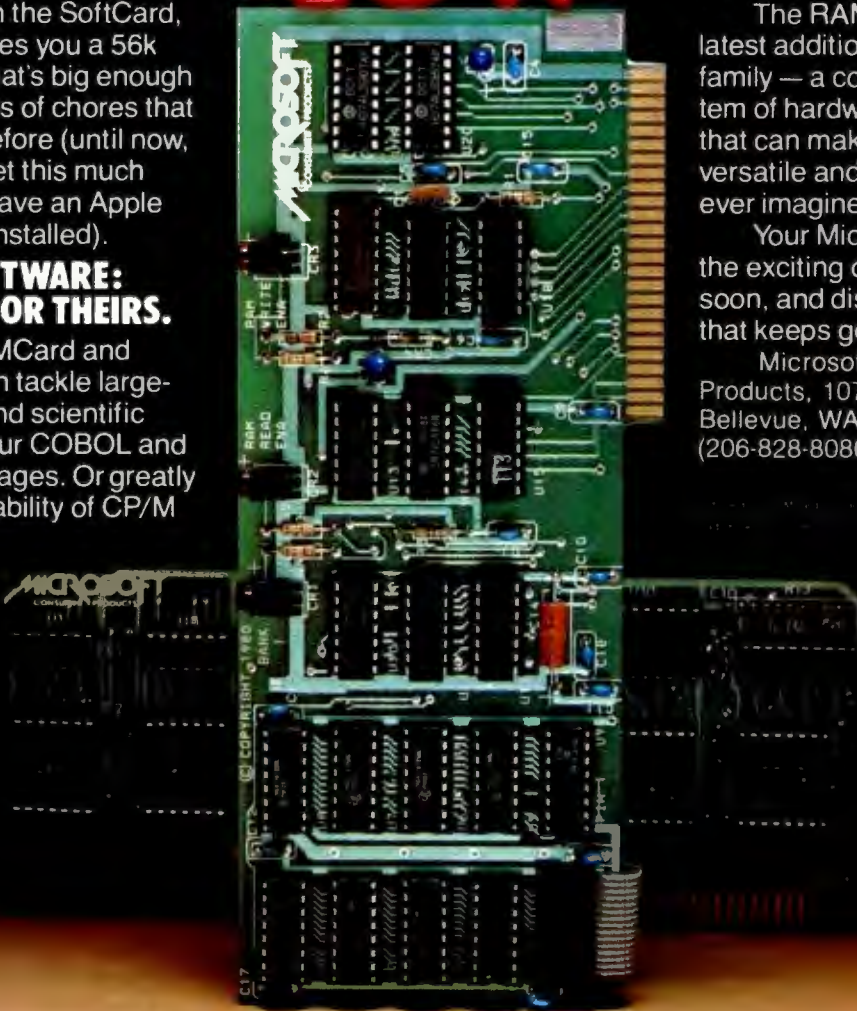

MICROSOFT

Circle 283 on inquiry card.

Listing 4: Program that simulates the sound of a phaser firing.

```

100 REM      **** PHASER SOUND ****
110 REM
120 N=17 :REM Sound Generator Address
130 GOSUB 1000
140 OUT N,231 :OUT N,240 :REM set noise and attenuation
150 FOR L=0 TO 15
160 FOR A=192 TO 207
170 OUT N,A :OUT N,L
180 NEXT A
190 OUT N,(240+L)
200 NEXT L
210 END
1000 OUT N,159 :OUT N,191 :OUT N,223 :OUT N,255
1010 RETURN
    
```

Listing 5: Program that produces an explosion sound.

```

100 REM      **** EXPLOSION ****
110 N=17
120 GOSUB 1000
130 OUT N,228 :REM Set high pitched white noise
140 FOR A=240 TO 255
150 OUT N,A :REM STEP ATTENUATION
160 FOR D=0 TO 50 :NEXT D :REM delay
170 NEXT A
180 GOSUB 1000 :END
1000 OUT N,159 :OUT N,191 :OUT N,223 :OUT N,255
1010 RETURN
    
```

800-SOFTWARE DECLARES WAR ON CP/M[®] PRICES!

MICROPRO™	For Apple	For CP/M	PERFECT SOFTWARE™	SELECT™ "the word processor" . . . \$449	TCS ACCOUNTING™
Word Star	\$199	\$239	Perfect Writer	\$199*	PICKLES and TROUT™
CalcStar	\$119	\$199	Perfect Speller	\$129*	ADVANCED LOGIC SYSTEMS™
MailMerge	\$69	\$79	Perfect Mailer	\$129*	Z-Card
SpellStar	\$119	\$169	SMARTERM™	\$49*	Smarterm
DataStar	\$169	\$199	ARTIFICIAL INTELLIGENCE		Add-Ram
SuperSort	\$119	\$169	medical	\$595	The Synergizer
dBASE II™		\$495	dental	\$595	FOX AND GELLER™
SUPERCALC™		\$199	VISACOUNT™	\$109	Quickcode
SPELLGUARD™		\$199	CBASIC™	\$99	Quickscreen

* Unconditioned 30 day moneyback guarantee

TO ORDER CALL TOLL FREE 800-227-4587* * VISA-MASTER-AM. EX.

- UNCONDITIONAL GUARANTEE on many products
- FREE CUSTOMER SERVICE 415-974-5990
- RELIABLE UPS BLUE LABEL DELIVERY
- WE SPECIALIZE IN BUSINESS CP/M[®]

** 800-622-0678 in California (Calif. residents add sales tax)

800-SOFTWARE™
185 Berry Street
San Francisco, California 94107

WE OFFER TECHNICAL SUPPORT ON ALL SALES

First, the *IBM Personal Computer*, The Next Step . . .

Tecmar

The **TECMAR** Expansion series is the first and only, complete line of expansion options available for the IBM Personal Computer.

Now totaling over twenty-five separate options, the **TECMAR** series gives you the broadest range of expansion available for your IBM Personal Computer.



SYSTEM EXPANSION with a complete Expansion Chassis providing six additional system slots, a separate power supply and styling that complements the IBM system.

MEMORY EXPANSION in 64K, 128K, 192K and 256K Byte increments of Dynamic RAM with parity, 32K Bytes of Static RAM, 32K Bytes of CMOS RAM with battery backup, or up to 128K Bytes of Read Only Memory.

PRACTICAL EXPANSION with two Serial ports and one Parallel port on a single board, or a Time of Day calendar with battery backup, a Voice Synthesizer with vocabulary in ROM and phoneme speech generation, even a BSR X10™ device controller for lights and appliances.

DISK EXPANSION through the addition of a five or ten megabyte Winchester disk. The disk options come enclosed in the **TECMAR** Expansion Chassis, providing additional expansion slots as well as Winchester disk storage. This approach assures you of unmatched system expandability for nearly any application.

FUNCTIONAL EXPANSION is also available with **TECMAR** Speed Disk™ and print Spooling Software that give new functionality to memory options.

UNMATCHED EXPANSION for the serious IBM Personal Computer user through these and the many other **TECMAR** Expansion products available through participating **COMPUTERLAND** stores, and other fine computer retailers nationwide.

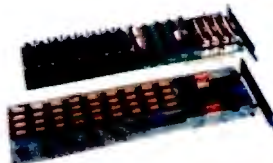

LABORATORY/INDUSTRIAL EXPANSION through an IEEE 488 interface, the Lab Tender with an 8 bit A/D and D/A, or the Lab Master for 12 bit A/D and D/A, a two axis Stepper Motor Controller, or the Parallel Digital-In/Digital-Out Base Board™, Video Digitization with Video VanGogh™.

DEVELOPMENT EXPANSION using an E+EEPROM programmer, Protozoa prototyping boards or a **TECMAR** Extender card.

NEW PRODUCTS are currently under development with many soon to be announced. At present shipping 26 unique IBM add-on products, we are still looking for needs to meet. If you have a need for a new product for the IBM Personal Computer, and would like to ask us about it, give a call on our Product Input Hotline at (216) 464-8317.

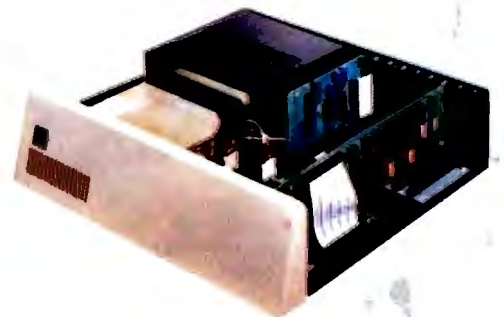

For IBM Personal Computer Expansion, **TAKE THE NEXT STEP . . .**

Tecmar Inc.

Circle 378 on inquiry card.

PERSONAL COMPUTER PRODUCTS DIVISION
23600 Mercantile Road, Cleveland, Ohio 44122
Telephone: (216) 464-7410 Telex: 241735

Producing an explosion is easier. The procedure is simply to set the white noise to a high volume and linearly attenuate the output. Abruptly shutting off the output will make it sound more like a gunshot.

In Conclusion

The SN76489A has some truly remarkable features for a 16-pin integrated circuit. I have only scratched the surface of the sound effects that it can produce, and the programs I have included are merely a first attempt at producing sound effects. I even think that given proper incentive and a bank of SN76489As, I could give the Cleveland Symphony Orchestra a run for its money.

In reality, I probably won't use this interface for music as much as I might use it as a warning device or annunciator on one of my computer systems. The good old days of bells, whistles, and lights on computers aren't gone. And now these accessories are programmable.

Next Month:

A spritely attempt at building a simple, versatile color-video graphics and animation circuit. ■

A complete kit of parts, including a printed-circuit board, for the sound-generator circuit of figure 2 is available from:

*Micro Projects
POB 420
South Windsor, CT 06074*

The kit sells for \$40 postpaid in the United States. For foreign orders, please include \$5 for shipping. For orders within Connecticut, please include 7½-percent sales tax.

To receive a complete list of Ciarcia's Circuit Cellar project kits available from the Micromint, circle 100 on the readers service inquiry card at the back of the magazine.

Editor's Note: Steve often refers to previous Circuit Cellar articles as reference material for each month's current article. Most of these past articles are available in reprint books from BYTE Books, 70 Main St., Peterborough, NH 03458. Ciarcia's Circuit Cellar, Volume I, covers articles that appeared in BYTE from September 1977 through November 1978. Ciarcia's Circuit Cellar, Volume II, contains articles from December 1978 through June 1980. Ciarcia's Circuit Cellar, Volume III, contains the articles that were published from July 1980 through December 1981.

Editor's Note: Many readers have inquired about the experimental multicolor (red, green, and blue) light-emitting-diode component mentioned in the text box I wrote to accompany Steve's article "Use Infrared Communication for Remote Control," April 1982 BYTE, page 40. Sanyo Electric expects that a blue-only LED based on the same technology will be available in mid-1983, with a multicolor device possibly following. North American distribution will be handled by Sanyo Semiconductor Corporation, 7 Pearl Ct., Allendale, NJ 07401, (201) 825-8080. . . . R.S.S.

NEW!



An advanced microprocessor controlled daisy wheel printer • Fully formed letter quality printing • Speed—120 words per minute • Simple • Reliable • User "friendly" operator controls • Available with parallel or serial data interface • 10 or 12 characters per inch • Six fonts for each pitch • Handles single sheets or continuous forms up to 5 parts • Tractor optional • Noise level—63 dB or better • 117VAC or 240VAC • 50/60 HZ.

Terms of sale: bank wire transfer, certified or cashier's check, or money order. Please include telephone number with order. PA residents add 6% sales tax. Advertised price is for pre-paid orders F.O.B. shipping point. Price subject to change without notice. Manufacturer's warranty only.

Lowest Price Anywhere . . .

SMITH-CORONA-TPI

\$649.

**We'll
beat
any
price!**

**LETTER QUALITY
ELECTRONIC
TEXT PRINTER**

**To Order, Write . . .
or Call Toll Free:**

800-523-1449

In PA (215)644-6341

SPECTRA MARKETING

600 Swedesford Rd. Berwyn, PA 19312

Circle 422 on inquiry card.

SuperBrain II™



Summa Cum Laude!

Just three years ago, Intertec stunned the microcomputer industry when its SuperBrain™ desktop computer graduated with honors . . . outperforming all the others by achieving the best price/performance ratio in its class. Today, that scholastic achievement remains unchallenged. At least until now. . .

Announcing SuperBrain II™ . . . our latest microcomputer marvel that's destined to be the "Most Likely to Succeed" in the Class of '82. With thousands of SuperBrains in use worldwide, it's no surprise that SuperBrain II users have given our new model the highest honors yet. Standard features include a powerful 64K of internal memory, a CP/M* operating system, a 24 line × 80 column display on a 12-inch non-glare screen, a full-featured ASCII keypad with operator convenience keys, twin Z80 processors and dual RS-232 communications and printer ports. But SuperBrain II outsmarts its Class of '79 counterpart by

offering *leaner* pricing, *more* features and *better* overall system performance. New SuperBrain II features include a faster, enhanced disk operating system, a library of new visual attributes including reverse video, below-the-line descenders and impressive graphics capabilities *and* Microsoft® BASIC — all included at absolutely no extra cost!

SuperBrain II's internal circuitry has also been completely redesigned and is now computer tested to ensure optimum field reliability. Plus, there are four new SuperBrain II models from which to choose, offering disk storage capacities from 350K bytes to 10 megabytes! But, best of all, prices start as low as \$2,495, including software!

Of all the single-user microcomputers available today, our SuperBrain II is certainly in a class by itself. Not only does it outprice *and* outperform its competitive classmates, it's also backed by our comprehensive customer protection

programs — depot maintenance, extended warranties, a satisfaction guarantee and a factory sponsored users group. All in all, the SuperBrain II™ represents the most incredible microcomputer value we've ever seen (or probably ever will see) in a long, long time.

Contact your local dealer or call or write us at the address below for more information on our full line of single and multi-user microcomputers. Ask for our SuperBrain II "Buyers Guide" and find out why so many microcomputer buyers who insist on quality and value . . . insist on Intertec.



2300 Broad River Rd. Columbia, SC 29210
(803) 798-9100 TWX: 810-666-2115

Circle 195 on inquiry card.

CompuView

CP/M-86 Now Mainframe Features For Your IBM Personal Computer

The CompuView implementation of CP/M-86 for the IBM Personal Computer has the features needed to run the full range of CP/M-86 application programs. Included are serial and parallel printer support, a 'smart' screen driver which can emulate many popular CRT terminals, and 193K/disk capacity. Innovative features include built-in horizontal scrolling for up to 254 columns and screen line editing, which lets the user extensively edit or re-enter any command line on the screen for CP/M-86 and application programs. In addition to IBM hardware, the TECMAR, Inc. Winchester hard disk, other hard disks and 80 tpi double sided drives are also supported.

Screen line editing is a desirable, time saving feature common on large mainframe computers, but not previously available on any CP/M system. Besides editing the line being typed in, the cursor may be moved to any line on the screen, and the line edited by overtyping or inserting and deleting characters. Typing the 'Return' key will then enter the line,

as it appears on the screen, to CP/M-86. Also, a string of 10 long commands can be repeated by moving the cursor to the first command and just typing the 'Return' key 10 times. This greatly reduces the amount of re-typing necessary due to mis-typed or repeated commands. Another common mainframe feature implemented is page control, which allows the screen to automatically stop after each new screen full of text.

The CompuView CP/M-86 is licensed from Digital Research and comes complete with all CP/M-86 utility programs. Software interchange is simplified by the ability to read and write IBM-MSDOS disks, IBM CP/M-86 disks and transfer files with other CP/M and CP/M-86 computers via the serial port. The screen driver includes a useful status line, horizontal scrolling for up to 254 columns, and faithful CRT terminal emulation, including editing functions, cursor movement and display attributes. Application programs can use the status line for their own purposes or to emulate a Z19 terminal.

We encourage you to compare our CP/M-86 with the version available from IBM. We have been careful to insure software compatibility and can read/write their disks. The table lists the major points of comparison between the two versions.

Compare CompuView With IBM

	IBM	CompuView
Horizontal Scrolling	No	Yes
Screen Line Editing	No	Yes
Page Control	No	Yes
Emulate popular terminals	No	Yes
'Smart' CRT functions	No	Yes
Read/Write IBM MSDOS disks	No	Yes
Serial file transfer	No	Yes
Support non-IBM hardware	No	Yes
Programmable Function Keys	Yes	Yes
Status Line	Yes	Yes
Support Light Pen	Yes	Soon
File Capacity	154K	193K

CP/M-86 for IBM P.C. \$325

VEDIT-86 with above purchase (This version of VEDIT has horizontal scrolling for up to 254 columns) \$100

V-COM Disassembler

Finally a Z-80 disassembler for CP/M which produces easy to read code, a cross reference table and handles INTEL and ZILOG mnemonics. V-COM is exceptionally fast and produces an .ASM file directly from a .COM file. The disassembly of a 12K program producing a 76K .ASM file containing 7500 lines of source code and a 33K cross reference file will typically take less than two minutes.

V-COM can accept two user created information files to make the resulting code more readable. One contains assignments of labels to 8 and 16 bit values; the second specifies the location of tables and ASCII strings. The resulting .ASM file will then contain labels and proper storage allocation for tables and

strings. Each information file may contain nested 'INCLUDE' to other files. Each package includes a 30 page manual, sample program files and variations of V-COM compatible with TDL, MAC and two types of ZILOG assemblers \$80

8086 Software

VEDIT full screen editor for CP/M-86, MSDOS, IBM Personal Computer and IBM Displaywriter \$195

CP/M-86 BIOS for popular S-100 disk controllers and SCP 8086 computer. Source Code \$90

Bootable CP/M-86 disks for popular S-100 computers Call

Software Mainframe Features for Microcomputers



State of the Art Full Screen Text Editor
The newest generation VEDIT combines sophisticated program development editing with useful word processing features and new powerful 'TECO' like macros.

User Oriented Fast and easy editing for program development and word processing. Includes automatic screen scrolling, a status line with the cursor's line and column positions, an 'Undo' key, and recovery from full disk conditions (you can delete files or change disks). Fully adapts to your system with a menu driven customization for keyboard layout, CRT selection and more. Plus you're assured that VEDIT will always be state of the art because of our inexpensive update option and support you can count on.

Performance Exceptional speed and true 'What you see is what you get' full screen editing with a convenient array of cursor movements and editing functions. Edits files up to one disk in length, and holds up to 45K of a file entirely in memory. You can insert a specified line range of another file anywhere in the text, and change disks in the middle of an edit session. Includes search and replace, text move and copy, complete file handling and flexible macros. Unique automatic indenting for use with structured languages such as Pascal, 'C' and PL/I. Other features for assembly language, Fortran and Cobol.

Word Processing Features include word wrap, adjustable left margin, reformatting of paragraphs, word and paragraph oriented cursor movement and deleting, and printing with imbedding of printer control characters. May be used stand-alone or in conjunction with most text processors.

Hardware Support CRT version supports over 40 terminals and utilizes 'smart' terminals. Your keyboard layout can use any available function and cursor keys. Memory mapped version offers high speed, flexibility, and supports bank select.

New Macros Ten buffers can hold macro command strings. These may be executed, edited, saved and loaded from disk. Macros can perform complex editing operations. (For example, a macro could automatically perform a series of global search and replace on many files). The buffers may also hold text, allowing extensive text 'cut and paste', including multiple files.

Ordering Please specify your microcomputer, video board or the CRT terminal version, 8080, Z80 or 8086 code, and disk format.

VEDIT - Disk and manual
For 8080 or Z80 \$150
For CP/M - 86 or MSDOS \$195
Manual only \$18
VISA and MASTERCARD



1955 Pauline Blvd., Suite 200
Ann Arbor, Michigan 48103
(313) 996-1299

CompuView
PRODUCTS, INC.

CP/M and MP/M are registered trademarks of Digital Research, Inc. Apple II is a registered trademark of Apple Computer, Inc. Softcard is a trademark of Macrosoft. TRS-80 is a trademark of Tandy Corporation. IBM Personal Computer is a trademark of International Business Machines, Inc.

Circle 108 on Inquiry card.

Breaking the Jargon Barrier

Designing Programs for Humanists

Archaeologists design programs for their colleagues using the language of the profession.

Ned Heite and Lou Heite
Heite Consulting
POB 53
Camden-Wyoming, DE 19934

The belief that knowledge and the students thereof are divisible into two bodies, one scientific, the other "humanistic," is indeed one of the constitutive ideas that frame contemporary intellectual life.

John Higham, *Writing American History: Essays on Modern Scholarship* (Indiana University Press, 1970), page 6.

Humanists seldom are trained to deal with quantified information or to express ideas in numerical form. Because computers are numerical devices and computer specialists belong to the scientific branch of society, a communication gulf often exists between computerists and humanists.

About the Authors

Ned and Lou Heite, both archaeologists and office information management consultants, are developing computer programs for other archaeologists, including an archaeological drafting and statistical package in Commodore's BASIC.

Some humanists, such as "cliometric" historians (those who apply statistics to Clio, the muse of history), do use statistical methods to interpret information. These brave humanists must fight their way through one set of technical jargon in order to master statistics; and if they use computers in their statistical work, they must face the even more formidable barrier of computer jargon.

Humanists who persevere and master the new methods and jargon find that they are now working in the *social sciences*, with the emphasis on *sciences*. Traditional humanists, put off by the incomprehensible jargon, sometimes seem to feel that their quantitative colleagues have left the humanities and become scientists. Traditional scientists, on the other hand, are unlikely to regard social scientists as scientists of any kind. This situation hardly encourages more humanists to start using computers.

Computers in Archaeology Today

At a recent national conference attended by more than 700 archaeologists, only seven—less than 1 percent—attended the session on microcomputer applications in archaeology. This poor turnout confirms the existence of the jargon barrier. Busy professionals have no time for re-education in a new discipline. Because many humanists believe that buying a microcomputer would involve learning computer science, they can hardly be expected to queue up at their campus computer stores. Microcomputer manufacturers reinforce the barrier when they pack five thick volumes of documentation with each system, each volume filled with mystifying computer jargon. The humanist has a subtle appreciation of language. When he or she flips through one of these manuals, terms like *initialize*, *diskette*, and even *user-friendly* are sure to catch the eye and grate on the sensibility.

In short, the jargon barrier current-

The World's First

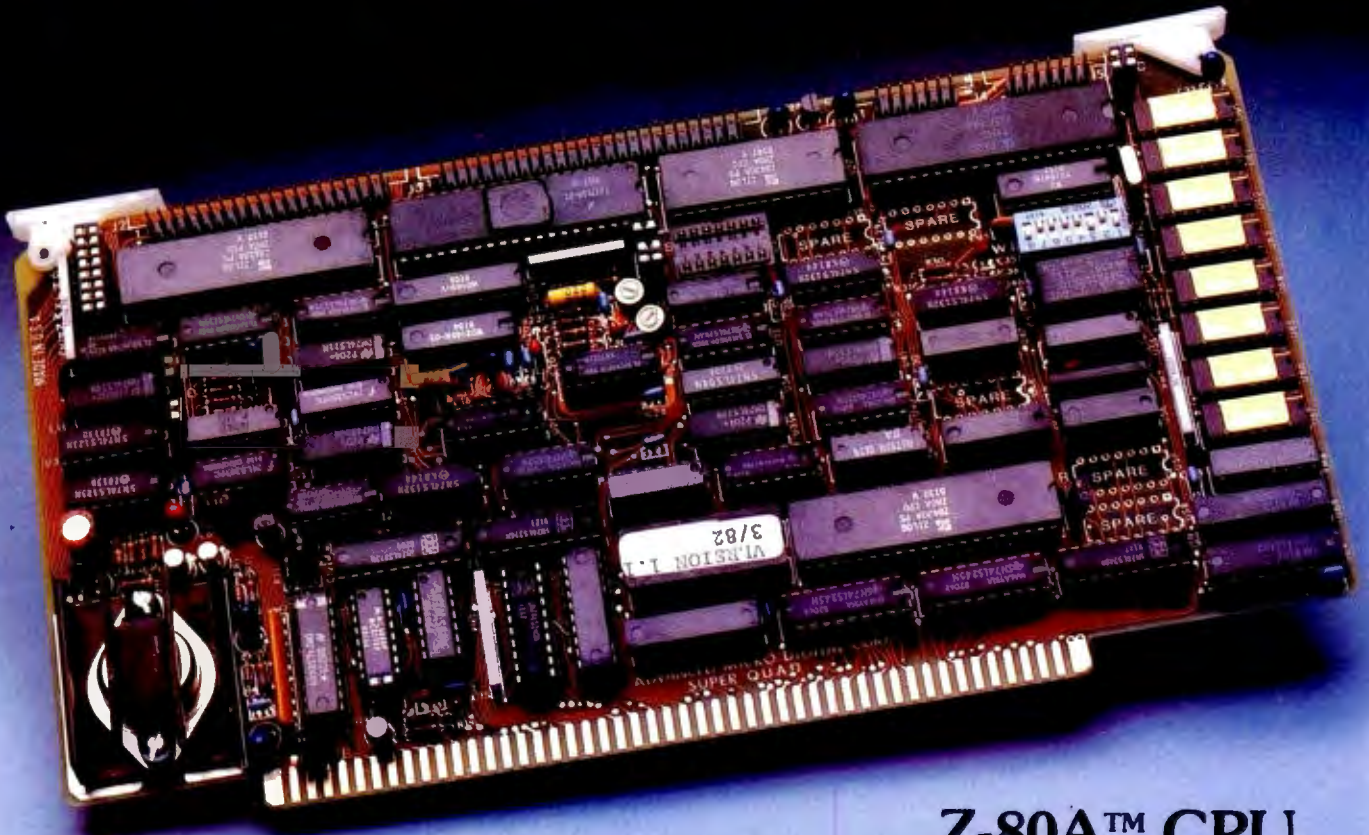

Z-80A™ CPU, Floppy Disk Controller, 64K of Memory, Serial & Parallel I/O Ports . . . all on a SINGLE S-100 BOARD!

Don't Buy Another One of Those 3 Board Sets Till You See What One Can Do!

Advanced Micro Digital has been producing the SUPER QUAD for some time now and it's truly one of a kind. Just plug this board into any S-100 mother board and hook-up your disk drives to it. It files. Runs with CP/M, MP/M, and turbo-DOS. You can also plug in additional boards, I/O, hard disk controllers, etc. SUPER QUAD is a BUS master. The cost of this board is one third to one half of what you have been paying for the three board set. Just take a look at these features:

- IEEE S-100 Standard
- Z-80A CPU
- 64K of Bank Select Memory as well as extended addressing
- Double density floppy disk controller. Both 8 or 5¼" Disk Drives
- 2 serial & 2 parallel I/O ports (RS-232 and intelligent hard disk interface).
- 2K or 4K of monitor EPROM
- Runs with CP/M®, MP/M® and turbo-DOS™
- One year warranty.
- Free copy of superbios disk

Also introducing SUPER/SLAVE to run multi-processing operating systems such as turbo-DOS™. With 128/64K of memory, serial & parallel I/O, you can plug multiple of the slaves with the master and each user will have its own CPU and memory local.

NOTE: off-board DMA supports



Now it's time to replace or throw away the old S-100 boards and plug the SUPER QUAD in. Save space, money and power.

Retail price is \$875.
For more information write or call: Sales Dept.



12700 B Knott St. • Garden Grove CA 92641 • (714) 891-4004

TELEX: 678401 tab Irin

© Registered Trademark of Digital Research Corp.
™ Registered Trademark of Software 2000 Inc.

Circle 9 on inquiry card.

© Copyright 1981 Advanced Micro Digital Corp

Expand Your IBM P.C.



\$229⁰⁰

■ Memory Expansion Board

(PC)²'s Expansion Board offers 4 TIMES the amount of memory offered by IBM P.C. Configurations can be set at 64K,

128K, 192K and 256K Bytes. Board can be easily upgraded in 64K capacities. Upgradability is the key!



\$1895⁰⁰
For
6M Bytes

■ Add-In Winchester Disk System

(PC)²'s Add-In Winchester Disk System is housed within the IBM chassis and is easy to install directly into the floppy

slot, reducing desktop space. Also available in 12 and 18 M Bytes capacity.

■ Asynchronous Communications Controller

1 or 2 line capability on one card.

Totally compatible with IBM software and diagnostics.

■ DS-Disk Software

(PC)²'s software program doubles the IBM single-sided diskette capacity by using both sides. Increases capacity

from 160K to 320K. Used with Tandon TM100-2 disk drive or equivalent.

As
little as
\$85⁰⁰

PHONE OR WRITE — BUT ORDER NOW!

(PC)², P.O. Box 678
510 Lawrence Expressway
Sunnyvale, CA 94086

(408) 749-9313

Postage and Handling included within continental U.S.A.
One year warranty on all board products.
MasterCard, Visa and Checks accepted.

\$40⁰⁰



PLUG COMPATIBLES FOR PERSONAL COMPUTERS

ALPHANUMERIC or GRAPHIC?

If high resolution required, install
BMC color/green monitor in your system.

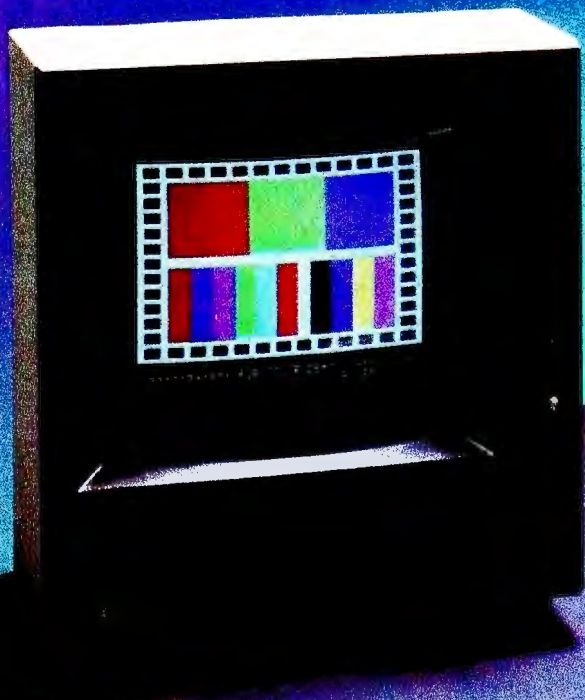

BM-1401RGB

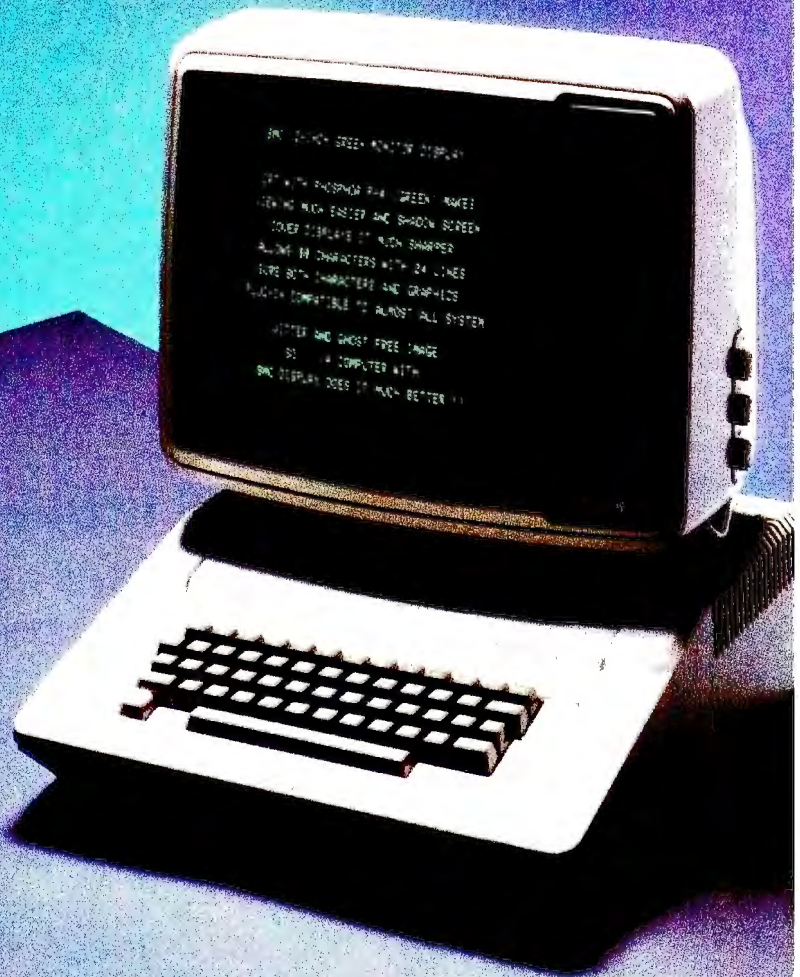

BM-120A

RGB Interface Board for

Apple-II is available now.

for a doctorate in the humanities. Computerese, even rudimentary computerese, is considered to be a foreign language.

Microcomputers are not yet as friendly as SPSS. Jinsam, a microcomputer extended database system, does have available many of the essential functions of SPSS. However, procedures in Jinsam cannot be designed and executed in plain English. Therefore, even experienced SPSS users cannot simply sit down at a microcomputer and run stats on Jinsam using their SPSS experience. The foreword to the Jinsam manual clearly states the problem: "It is assumed that the Customer is familiar with the basic operation of the Commodore PET/CBM and the necessary peripheral devices." Then follow 72 pages of jargon-filled, obscure prose, plus two volumes on supplemental modules. By contrast, the same person needs absolutely no knowledge of the IBM 370 to use SPSS on it.

Suppose an archaeologist buys a computer, printer, disk drive, database manager, Visicalc, and word processor. Despite the big investment, 10 or more volumes of heavy reading, and getting used to a strange machine, he still will not be equipped

**The program must
actually reduce
the users' work load
and not complicate
their lives.**

to compute a mean ceramic date or a bore-diameter mean date. Without studying the 10 volumes in detail, he probably won't be able to keep an excavation register either. So why should he leave the friendly embrace of the university's computer department to blaze trails in microcomputing?

What Archaeologists Do

The most basic archaeological activity is brute data handling. Every artifact and its associated find-spot is detailed in a document, commonly called an excavation register, that allows complete paper reconstruction of field observations for later analysis. To supplement the written register, archaeologists keep detailed drawings and maps of their sites, recorded in a three-dimensional grid system. Every drawing, every object discovered on the site, and every observed condition are carefully documented and keyed to numerical coordinates.

Archaeological sites often contain confusing patterns of post holes, pits, and foundations created at different times for different purposes. Traditionally, these patterns have been sorted intuitively, sometimes with controversial results. In one English example, over 2500 post holes occurred in an area of 8000 square

Marymas INDUSTRIES, INC.

**In Texas Orders
Questions & Answers
1-713-392-0747**

**21969 Katy Freeway
Katy (Houston) Texas 77450**

**To Order
1-800-231-3680
800-231-3681**

SAVE BIG DOLLARS ON ALL TRS-80[®] HARDWARE & SOFTWARE

TRS-80[®] BY RADIO SHACK. Brand new in cartons delivered. Save state sales tax. Texas residents add only 5% sales tax. Open Mon.-Fri. 9-6, Sat. 9-5. We pay freight and insurance. Come by and see us. Call us for a reference in or near your city. Ref: Farmers State Bank, Brookshire, Texas.

WE OFFER ON REQUEST

- Federal Express (Overnight Delivery)
- Houston Intercontinental Airport Delivery (Same Day)
- U.P.S. BLUE (Every Day)
- References from people who have bought computers from us probably in your city

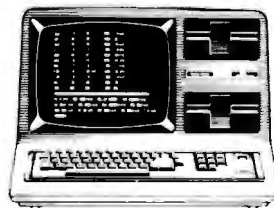

In stock TRS-80 Model II and III

No Tax on Out of Texas Shipments!

**Save
10% 15%**

OR MORE

Reserve Your Model 16 Today

Telex 77-4132 (Fleks Hou)

WE ALWAYS OFFER

- NO extra charge for Master Card or Visa.
- We use Direct Freight Lines. No long waits.
- We always pay the freight and insurance
- Toll free order number
- Our capability to go to the giant TRS-80[®] Computer warehouse 5 hours away, in Ft. Worth, Texas, to keep you in stock.

JOE McMANUS



* TRS-80 is a Registered Trademark of Tandy Corp

ED McMANUS



you have one apple... now get a whole bushel

of apple add-ons

from **Vista** COMPUTER
COMPANY,
INC.

Available through your
local computer dealer.

MODEL GB75© Typewriter Interface

Apple to IBM Electronic 50, 60, 75 Typewriters Interface ■ Reads IBM keyboard in parallel with Apple keyboard ■ Supports the IBM code functions using an escape sequence ■ Types at about 13 characters per second ■ Prints from Integer or Applesoft programs ■ Supports the "Control I Number N" parallel line length mode sequence ■ Has switch selectable upper/lower case I/O 60, 66, 78 continuous from feed page lengths, 40+video, 80, 95, 132 character line lengths

Suggested price \$225.00

TIMECARD III©

Multi-function time utility for the APPLE III computer system. Contains the year of the century, the month, the date, the day of week, the hour, the minute, the second. ■ A countdown timer with a range of one millisecond to 999 hours, 59 minutes, 59 seconds, 999 milliseconds ■ Selectable 12 or 24 hour time formats ■ Diagnostic error reporting ■ Fully compatible with the APPLE SOS operating system

Suggested price \$195.00

MODEL 150 TYPE AHEAD BUFFER

■ Up to 40 character type ahead capability ■ Enter commands or data while your Apple is processing previous instructions ■ Compatible with all Apple computers, keyboards and software ■ No cuts — no jumpers — no software patches required ■ Includes complete instructions for quick and easy installation

Suggested price \$49.95

A800© FLOPPY DISK CONTROLLER

■ High speed DMA transfer of data (1 micro-second/byte) ■ Documentation provided — includes theory of operation, schematics and diskettes ■ Uses all standard Apple DOS commands (OPEN, CATALOG, LOCK, DELETE, LOAD, etc.) except for INIT which has been improved and enhanced in a Vista format routine ■ Compatible with Apple DOS 3.3, Pascal 1.1 and CP/M 2.2 (with the Z80 soft card by Microsoft) ■ 2K x 8 PROM contains Autoboot functions and all eight-inch

floppy driver code allowing complete compatibility with Apple DOS 3.3

Suggested price \$595.00

PROM DEVELOPMENT SYSTEM©

■ Menu driven program development monitor ■ Programs 2708, 2716, 2532, 2732 and 48016 EPROMS ■ Simulates PROM from RAM 4K ■ Data and address interface for operator location and control ■ Complete user documentation

Suggested price \$495.00

VISION 80

■ Full upper and lower case character with 3 dot descenders ■ 9x10 dot matrix per line U.S. (9x11 Europe) ■ 128 ASCII character set ■ BASIC, FORTRAN and Pascal languages supported ■ Z80™ and CP/M™ compatible ■ Compatible with all standard Apple™ peripherals

Vista COMPUTER
COMPANY,
INC.

Circle 396 on inquiry card.

©Copyright 1981 Vista Computer Company, Inc.
™Apple Computer Company, Inc.

■ Shift and lock for upper and lower case ■ Source switches between 40x24 and 80x24 software and hardware ■ Rated #1 video card by Softalk and Call Apple

Suggested price \$395.00

VISION 40

Softscreen programmable character/generator card for the Apple II computer ■ Allows use of DOS tool kit upper/lower case character sets in Apple 40 column mode ■ Permits creation of new alpha/numeric and graphic characters under Am-inatrix ■ Ideal for non-English language applications ■ Compatible with most popular word processing software packages

Suggested price \$195.00

VISION 20

■ Cost effective ■ Compatible with the latest Apple II ■ Complete easy to follow installation guide ■ 120 day warranty ■ Immediate delivery

Suggested price \$29.95

1317 E. Edinger
Santa Ana, CA 92705
(714) 953-0523

©Digital Research, Inc.
©Designed by Burtronix

DISCOUNT LINE

1-800-528-8960

GUARANTEED LOW PRICES

APPLE CARDS

16K RAM — \$99 Z80 CARD — \$210
Videx Card — \$249 Smart Term — \$269
Graphic Card — \$89 Clock CARD — \$120

ALTOS

8000-2 — \$2675 8000-15 — \$3850

ANADEX

9500 — \$1200 9501 — \$1200

ATARI

400-16K — \$399 800-16K — \$659
410 — \$79 810 — \$429
825 — \$569 850 — \$167

C-IOTH

F-10P — \$1380 F-10S — \$1525

DATASOUTH

DS120 — \$595 DS180 — \$1259

DIABLO

630RO — \$1945 630KSR — \$2475

DISKETTES/BOXES

Elephant — \$20 Scotch — \$25 Dyan — \$35

EPSON WITH GRAPHICS

MX70 — \$289 MX80 — \$429
MX80FT — \$519 MX100 — \$689
GRAPHIC ROM — \$69 RS232 — \$69

HAZELTINE

1500 — \$995 ESPRIT — \$595

LOBO

Apple Drive/Card — \$350/\$50

MODEMS

HAYS — MICROMODEM — \$290
HAYS — SMARTMODEM — \$229
Penril — 300/1200 (212A) — \$795

MONITORS

Teco-BW — \$99 Teco-Green — \$115
Sanyo-Green — \$249 Color — \$425
Amdek-Green — \$159 Color — \$349

NORTHSTAR

Advantage — \$2995 HR64QD — \$3025

NEC

8023 — \$489 7710 — \$2350

MPI

88G — \$550 99G — \$650

SOROC

120 — \$659 135 — \$689

TELEVIDEO

912 — \$669 950 — \$915

TI

810 — \$1240 820 — \$1795

SOFTWARE

All Major Brands — \$CALL

MOUNTAIN HARDWARE

CPS Card — \$169 Music System — \$429

OKIDATA

M80 — \$320 SL125 — \$3150
M82A — \$450 SL250 — \$4200
M83A — \$699 M84 — \$1059

XEROX

820 — \$2399

ZENITH

Z19 — \$669 Z89 — \$2129

All Prices Subject To Change

EXPOTEK

2723 W. Windrose • Suite 3
Phoenix, Arizona 85029

meters distributed apparently at random. For 20 years, the site plan sat undeciphered; then a mainframe computer reanalyzed the pattern and found circular house patterns where none had been visible to the unaided eye (see reference 1).

Once the site records are complete, archaeologists commonly interpret them through fairly simple statistical procedures. Descriptive statistics (frequencies and histograms) and measures of central tendency and dispersion (means, medians, and standard deviations) form the bulk of archaeological statistics. Few archaeologists have explored more sophisticated descriptive techniques such as measures of skewness or kurtosis (the peakedness or flatness of a graph representing a frequency distribution).

Chi-square is the most commonly used measure of association, and lately some investigators have begun to employ higher-level correlation measures such as dummy variable analysis, Student's t, and variations of the Pearson's correlation formula. A very few also have begun to use probability distributions such as the Poisson distribution for certain types of site-location prediction.

Beyond these standard procedures, archaeologists use statistical tools peculiar to the field, such as the mean ceramic date and the bore-diameter date formulas. While off-the-shelf programs can be adapted for standard statistical applications, they are nearly useless to the archaeologist in performing field-specific analyses.

Fairly standard recording systems are used throughout the profession, and reporting formats are almost ritualized. Since archaeological procedures already have been adapted to large computer systems, microcomputers are a natural next step.

Writing Software

About a year ago, we began to develop a program package for specific archaeological applications. To promote its acceptance, we set down certain strict ground rules that could apply equally to any programming project in the social sciences and humanities:

1. Procedures should follow as closely as possible the usages of archaeology, regardless of the traditions of computing.
2. The manual must be minimal. After simple instructions for loading the program, the users should be guided by screen prompts written in language familiar to them from their previous professional training.
3. Operating instructions and input procedures must follow archaeological practice. Wherever possible, people familiar with archaeology should be able to perform the operations without computer training.
4. The program must actually reduce the users' work load and not complicate their lives.
5. The system must be completely free of rough edges and must compensate for users' lack of knowledge in such areas as legal string entry and other arcane subjects that computerists take for granted.

An *archaeological* program should result, even if it might be a clumsy *computer* program. With these principles in mind, we set out to create programs to meet some real needs in the profession.

The Pipes Program

About 30 years ago, J. C. Harrington observed that the bore diameters of white clay smoking pipes decreased through time. Most pipes made in 1600 had stem holes 9/64 inches in diameter, whereas pipes made in 1790 generally had holes 4/64 inches in diameter. Over the intervening years, the English smoking pipe industry gradually reduced the size of the wires used to bore the holes. Harrington discovered that a histogram of the bore diameters of pipestem fragments from any site could accurately reflect the date of the site's occupation (see reference 6).

Ten years later, Lewis Binford observed that the reduction in bore diameter over time was a fairly regular process, decreasing at a rate of about 1/64 inches every 38.26 years. If the reduction trend had continued

36Mhz Z-80

Parallel multiprocessor power.

We've put nine 4 Mhz Z-80's working in parallel to give you this performance.

Here's the key: eight SLAVENET™ processors, each a complete S-100 computer that can handle two timeshared users, with 128K RAM plus parity, 2K EPROM, full interrupts, software bank boundary and two serial ports for synchronous and asynchronous protocol.

PASCAL & CP/M™

We have full compatibility with UCSD PASCAL II™ and CP/M™ through IBS PASCAL™ and TURBODOS™, which are fully interrupt driven, allowing up to 16

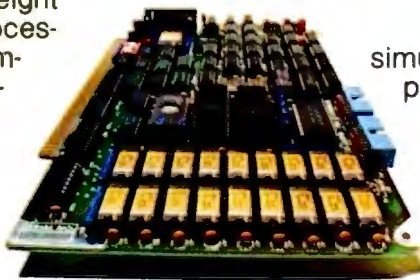

simultaneous and independent users. Our operating system includes such features as semaphores, concurrency, chaining and true word processing. And

we have an impressive library of applications software too.

Store up to 600 Mbytes on hard disk.

Hang on 5", 8" or 14" Winchester disk drives with from 5 Mbyte to 600 Mbyte storage. Or go with 5" or 8" floppies. With our system you can even use your video tape recorder for

backup. Get up to 100 Mbytes on a single videotape cartridge.

Get the most computer bang for the buck.

That's because you can get started with a low-cost, single user system and grow from there. Just plug in boards to go from one to sixteen users. And we've made it easy to reconfigure our I/O system so you can interface a remarkable variety of peripherals and controllers without special programming.

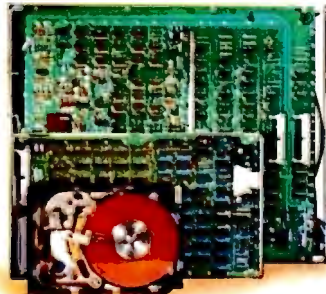

ibs

INDEPENDENT BUSINESS SYSTEMS

(415) 443-3131

5915 Graham Ct.
Livermore, CA 94550

OUR DEALERS: DOMESTIC • CEB3, Los Gatos, CA, (408) 559-0288 • Donald Coffman, Cupertino, CA (408) 253-2327 • ICE, Gaithersburg, MD, (301) 869-2896 • QUALI-TYPE, Livermore, CA, (415) 447-6121 • ERS, Brea, CA, (714) 524-2470 • Innovative Interfaces, Berkeley, CA, (415) 524-8416 • Khalsa Consultants, Cambridge, MA, (617) 235-3580 • Khalsa International, Herndon, VA, (703) 437-4177 • FOREIGN • Philip Baksh, London, England, Tel: 44 1 7413707 • EEI, Sharjah, United Arab Emirates, Tel: 97 1 6 354 688 • JH Systems, Etobicoke, Ontario, Canada, Tel: (416) 621-0538 • ELIF, Inc., Montreal, Quebec, Tel: (514) 337-3214 • FDM, Madrid, Spain, Tel: 34 1 255 14 04 • Micro Service, Saint-Clement La Riviera, France, Tel: 33 67 84 31 88 • Servonic, Munich, Germany, Tel: 37 089 483253 • Terrace Computer Services, Terrace, British Columbia, Canada, Tel: (604) 635-7606 • Technisch Bureau Muller, Amsterdam, The Netherlands, Tel: 31 20 868110 • ICE, 6 Youssef Abbaf #808, Nasr, Cairo, Egypt •

**Right away,
you can see a difference.**



Stop in a store near you. Take a look.
You'll be instantly taken with some of the features that make the IBM Personal Computer so different.

Like the non-glare screen—easy on the eyes during those number-crunching tasks like payroll and general ledger.

80 characters a line—with upper and lower case letters for a quick and easy read.

And the flexibility of a system that lets *you* move the components around at will.

(To get really comfortable, try the keyboard on your lap and put your feet up.)

Go ahead, compare.

As you progress from casual observer to comparison shopper, you'll want the inside story of the IBM Personal Computer.

Like user memory expandable up to 256KB. And 40KB of permanent memory. (Which not only includes the BASIC language, but diagnostic instructions that automatically check the system every time you turn it on.)

A 16-bit microprocessor that can improve speed and productivity.

A mix of crisp text and high-resolution color graphics on your own TV set—clearly helpful for creating charts to target forecasts and trends.

Or the 10 programmable function keys that let you bid goodbye to the tedium of repetitious tasks.

And the list goes on. Which is why we've included a box (at right) that tells all.

There's more than meets the eye.

Some of the best things about the IBM Personal Computer aren't part of the computer.

Like the instruction manuals that help you set up your system and teach you to use it with the greatest of ease.

IBM PERSONAL COMPUTER SPECIFICATIONS		
User Memory 16K-256K bytes* 16-bit, 8088*	Display Screen High-resolution* 80 characters x 25 lines Upper and lower case Green phosphor screen*	Permanent Memory (ROM) 40K bytes* Color/Graphics <i>Text mode:</i> 16 colors* 256 characters and symbols in ROM* <i>Graphics mode:</i> 4-color resolution: 320h x 200v* Black & white resolution: 640h x 200v* Simultaneous graphics & text capability*
Auxiliary Memory 2 optional internal diskette drives, 5¼", 160K bytes or 320K bytes per diskette	Operating Systems DOS, UCSD p-System, CP/M-86†	Communications RS-232-C interface Asynchronous (start/stop) protocol Up to 9600 bits per second
Keyboard 83 keys, 6 ft. cord attaches to system unit* 10 function keys* 10-key numeric pad Tactile feedback*	Languages BASIC, Pascal, FORTRAN, MACRO Assembler, COBOL.	
Diagnostics Power-on self testing* Parity checking*	Printer Bidirectional* 80 characters/second 12 character styles, up to 132 characters/line* 9 x 9 character matrix*	

*ADVANCED FEATURES FOR PERSONAL COMPUTERS

And an expanding library of software programs that meet IBM's demanding specifications.

Programs for business. Education. The lab and the home. Programs that make the IBM Personal Computer *your* tool for modern times.

See for yourself.

The quality, power and performance of the IBM Personal Computer are what you'd expect from IBM. The price isn't.

So stop in and take a look.

Visit an authorized IBM Personal Computer dealer. For a store near you, (or for information from IBM about quantity purchases) call (800) 447-4700.

In Illinois, (800) 322-4400. In Alaska or Hawaii, (800) 447-0890.

The IBM Personal Computer A tool for modern times

†UCSD p-System is a trademark of the Regents of the University of California. CP/M-86 is a trademark of Digital Research, Inc.

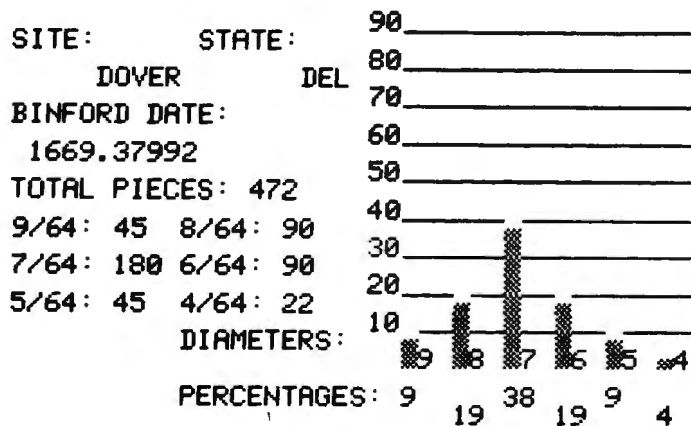

Figure 1: The data that the Pipes program displays on the video screen after data entry. Based on data about the bore diameters (ranging from 9/64 inches to 4/64 inches) of clay smoking pipes found at the site, the program has calculated that the mean date of the site is the year 1669.

beyond 4/64 inches, the hole would have disappeared altogether at 6 a.m., November 6, 1931 (Greenwich mean time), which didn't happen. About 1760, bore diameters stopped diminishing. Binford expressed this phenomenon as a straight linear function:

$$y = 1931.85 - 38.26x$$

where x is the mean bore diameter of the sample and y is the mean date. This seemingly exact date is just an approximation, but it provides a useful benchmark for a site's occupation.

To relieve the tedium of calculating mean dates and drawing histograms

for each site and feature (which can involve hundreds of calculations in a large dig), we wrote the Pipes program. In this program, the computer asks the user to type the name of the site, the state or province, and the count for each diameter. The computer thereupon displays a histogram, counts, percentages, and the mean date on the screen. Figure 1 mimics the screen display produced at that stage of the program. The printer then copies the same data in two different formats. Figure 2 shows one of these formats.

The Pots Program

Flushed with success from this exercise, we tackled a more complicated

project that eventually involved more than 25,000 bytes of code to execute a single formula: mean ceramic date analysis, which incorporates probably the largest specialized formula commonly used by American archaeologists. The formula has 410 constants.

About 10 years ago, Stanley South developed a statistical procedure to derive mean occupation dates for sites, based on the known manufacture dates of pottery types made in America, China, and Europe between 1600 and 1900 (see reference 4). He chose 82 different wares and charted their first manufacture date, last manufacture date, and median date. South multiplied the number of fragments of each type by its median date and added the products. When the total of the products was divided by the total number of sherds from the site, a mean occupation date for the site resulted.

William and Sarah Turnbaugh elaborated the formula with a technique for bracketing the site's probable occupation date with the means of the beginning and ending dates (see reference 5).

More recently, Steven Mrzowski of Brown University and Marley Brown of Colonial Williamsburg have observed that the standard deviation of the South mean date can delineate with startling accuracy the dates when a property changed occupants (see reference 2). As the formula becomes more sophisticated, its

TOTAL NUMBER OF FRAGMENTS IN THE SAMPLE: 472

DATE CALCULATED BY BINFORD'S FORMULA: 1669.37992

RESULTS ARE ROUNDED TO THE NEAREST INTEGER PERCENTAGE.

9/64 PIECES	████████	9 %
8/64 PIECES	██████████	19 %
7/64 PIECES	████████████████████	38 %
6/64 PIECES	██████████	19 %
5/64 PIECES	████████	9 %
4/64 PIECES	████	4 %

COUNT: 9/64: 45 8/64: 90 7/64: 180 6/64: 90 5/64: 45 4/64: 22

Figure 2: The Pipes program's output, including a compact histogram. This printout is designed for incorporation in a site report.

THE NEW CENTRONICS 122 GRAPHICS PRINTER.

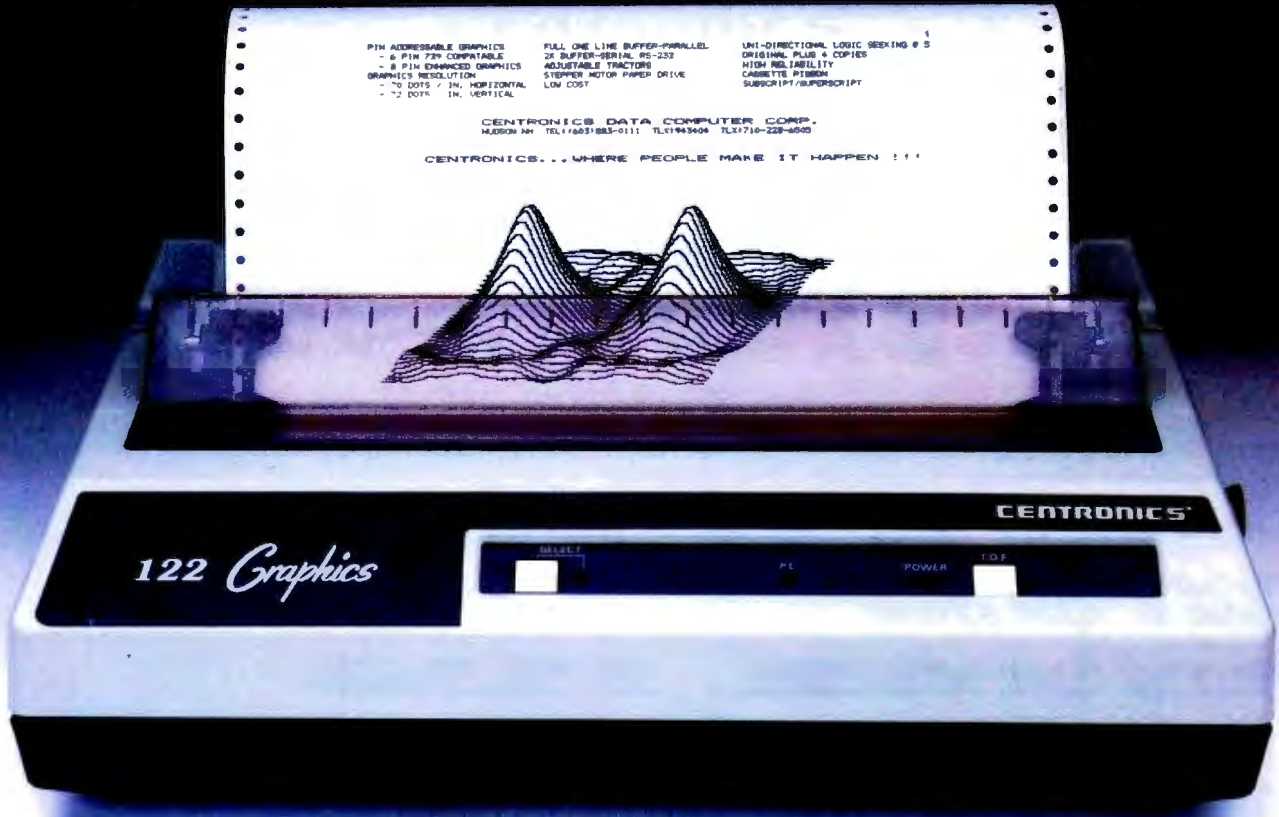

BUILT RUGGED YET AFFORDABLE. BECAUSE YOUR COMPUTER SHOULD'N'T BE PLAYING WITH "TOYS."

When you look for a printer, take a good close look at the critical points that separate a professional printer from the toys.

Look at the factors that add up to reliability. Look at the built-in operating features. Look at the service. *Then*, check the price.

We did. Then we built the "122 Graphics." That's why we'll stack it up against any desk-top printer. Especially the toys.

IT'S PRICED FOR VALUE

The "122 Graphics" is truly a commercial grade printer, but its price is comparable to the top-of-the-line toys. You see, even most of the toy printers lose their price advantage when you add the options that are standard on the "122 Graphics."

IT'S BUILT TOUGHER

The "122 Graphics" uses the same technology as the work-horse printers that have made Centronics the top choice among OEM's in brand preference studies. And, it provides the high reliability and low cost of ownership required by the professionals.



IT DOES MORE

If you want features, built-in, not added on, use the "122 Graphics" for comparison:

- 132 Column Paper Width
- Adjustable Tractor Width
- Forms Handling—up to 5 parts
- Graphics—Business and Image Graphics 6- and 8-Pin Switch Selectable
- Large Library of "Off-the-Shelf" Software
- High Throughput—120 CPS Bi-Directional Operation.

WITH BETTER SERVICE

Centronics has the largest network of factory service and walk-

in service centers in the printer industry. Not third-party service—**FACTORY SERVICE!** Worldwide. Ask the competition about service.

What's your computer? IBM? Apple? TRS-80? Xerox? Atari? It doesn't matter, the "122 Graphics" has the software flexibility to interface with virtually every one of them and many others.

And finally, consider this. The "122 Graphics" is from Centronics. The company that has built and sold nearly half a million printers to businesses and OEM's of every size worldwide.

See your nearby authorized Centronics Dealer or Distributor soon and see first hand why the toys are no match for the Centronics "122 Graphics" printer.

CENTRONICS PRINTERS

Centronics Data Computer Corp.
One Wall Street, Hudson, New Hampshire 03051
Tel. 603-883-0111

manual operation becomes more cumbersome.

The calculations are extremely time-consuming, even though the operations are quite simple. One archaeologist complained that statistical analysis of a single artifact deposit took a whole day to calculate by hand. Even a simple site may contain dozens of different artifact deposits, containing thousands of specimens.

We wrote the Pots program to do the donkey work of calculating mean date, mean bracket date, and stan-

dard deviation, as well as to draw histograms of the results. Input takes less than 10 minutes, and the full repertoire of reports and graphics can be printed in a half hour on a slow printer.

Input is simple for an archaeologist. The user enters data on a work sheet copied from South's original article, which has become a professional standard. The type name and number flash on the screen in worksheet sequence, and the user is asked only to type the sherd count for that

type or to hit return for a null entry. Screen prompts and menus guide the user through each step relatively painlessly. There is no manual, and none is needed. Listing 1 shows the summary sheet that the Pots program prints when the user has finished entering data.

The test came when a visiting archaeologist, with no computing experience, sat down at the computer without any prior instruction and successfully analyzed a collection. That's user-friendliness!

Listing 1: The summary sheet produced by the Pots program. Based on the input listed, the program calculated a mean date of 1850 for the site where the ceramics were found (Liston Point, Delaware).

SUMMARY OF ALL SPECIMENS

SITE: 79/157 DATE: 2/23/82
 REPORTED BY: ALICE GUERRANT

NO	BEGIN-END	MEDIAN	SHERDS	PRODUCT	TYPE NAME (INH, 1970)
5	1800 1830	1815			CANTON PORCELAIN
7	1790 1825	1808			OVERGLAZE ENAMEL CHINA TRADE PORCELAIN
26	1660 1800	1730			OVERGLAZE ENAMEL CHINESE EXPORT PORCELAIN
31	1745 1795	1770	6	10620	ENGLISH PORCELAIN
39	1660 1800	1730			UNDERGLAZE BLUE CHINESE PORCELAIN
41	1750 1765	1758			LITTLE'S BLUE ON PORCELAIN
69	1574 1644	1609			LATE MING UNDERGLAZE BLUE PORCELAIN
1	1820 1900	1860			BROWN STONWARE INK, BEER BOTTLES
46	1700 1810	1755			LUSTERED NOTTINGHAM STONWARE
52	1700 1775	1738			BURSLEM 'CROUCH' PALE BROWN STONWARE MUGS
53	1690 1775	1733			BROWN FULHAM SALT GLAZED MUGS
54	1690 1775	1733			OTHER BRITISH BROWN STONWARES
66	1620 1700	1660			DETERIORATED BELLARMINE FACE BOTTLES
74	1550 1625	1588			WELL-MOLDED BELLARMINE FACE BOTTLES
75	1540 1600	1570			RHENISH BROWN GLAZED SPRIGGED, MOULD DECOR
44	1700 1775	1738			WESTERWALD, STAMPED BLUE FLORAL DEVICES, 3
58	1650 1725	1668			WESTERWALD, BLUE & MANGANESE, SPRIG MOLDED
59	1690 1710	1700			EMBELLISHED HOHR GRAY RHENISH STONWARE
77	1700 1775	1738			WESTERWALD CHAMBER POTS
16	1740 1765	1753			MOLDED WHITE SALTGLAZE STONWARE
24	1765 1795	1780			DEBASED 'SCRATCH-BLUE' WHITE SALTGLAZED ST
30	1755 1765	1760			TRANSFER-PRINTED WHITE SALTGLAZE
34	1744 1775	1760			'SCRATCH BLUE' WHITE SALTGLAZE STONWARE
40	1720 1805	1763			WHITE SALTGLAZE STONWARE NOT PLATES AND M
41	1750 1765	1758			LITTLE'S BLUE ON STONWARE
43	1740 1775	1758			WHITE SALTGLAZE STONWARE PLATES
48	1715 1775	1745			SLIP-DIPPED WHITE SALTGLAZE STONWARE
55	1720 1730	1725			SCRATCH BROWN OR TRAILED WHITE SALTGLAZED
3	1813 1900	1857			IRONSTONE OR GRANITE CHINA
27	1750 1820	1785			BLACK BASALTES STONWARE
28	1763 1775	1769			ENGINE TURNED UNGLAZED RED STONWARE
37	1690 1775	1733			SPRIGGED REFINED UNGLAZED RED STONWARE
50	1732 1750	1741			RALPH SHAW BROWN SLIPPED STONWARE
56	1670 1795	1733			LEAD GLAZED COMBED YELLOW SLIPWARE
63	1650 1710	1680			NORTH DEVON SGRAFFITO SLIPWARE
67	1612 1700	1656			WROTHAM SLIPWARE
68	1630 1660	1645			METROPOLITAN SLIPWARE
70	1610 1660	1635			NORTH ITALIAN RED MARBELIZED SLIPWARE

Listing 1 continued on page 90

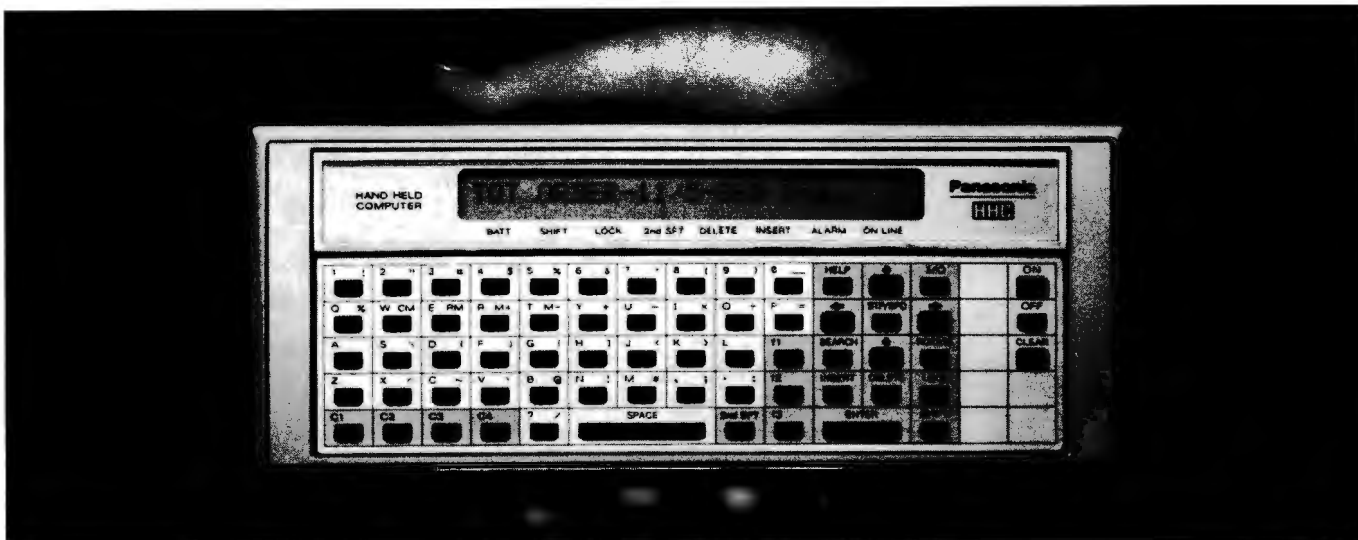

The Link™ from Panasonic.

The portable computer that lets you take the advantages of an office computer anywhere you go.

The Link. It's the next major business tool because it's a full-logic computer that's fully portable.



Exchange information with other computers with the telephone modem.

By itself, it can perform a wide variety of sophisticated computer functions because it can store 4K bytes of information. Equally important, it can link you to the information and brainpower of your main office computer — wherever you go. You can program in Microsoft Basic.® Yet it's easy to operate, even if you've never worked with a computer before.

Imagine. Using just The Link, anyone in the field, the plant or on the sales floor — like salesmen, managers, engineers or retailers — can now answer questions that used to mean a trip back to the office. A sales engineer, for example, types data into The Link and gets detailed product information and specs on the spot.

And The Link is part of an entire computer system: By adding different optional components, you can create whatever kind of computer you need. Wherever you need it.

By adding the telephone modem, for example, a salesman can put his company's main office computer or a data bank

to work for him from any telephone booth. He can check credit ratings and inventory, trace

shipments, enter orders, make bids and estimates, and much more. So The Link can make him and his office computer much more productive.

By adding the microprinter, the salesman gets hard copies of information right on the spot — an instant record of his transactions.

By adding the TV adapter, he can display information and 8-color charts on any color TV

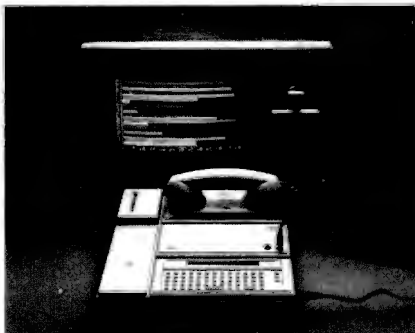

Display information and charts with the TV adapter.

screen. So he can use data from his office computer to develop a sales presentation in a motel room. And show it on a client's video monitor the next day.

If the salesman needs to work with a bigger program and

more memory, other optional components increase The Link's capacity to 52K RAM plus 64K ROM. That's more than many desktop computers.

The Link measures only 9" x 4", weighs only 21 ounces,

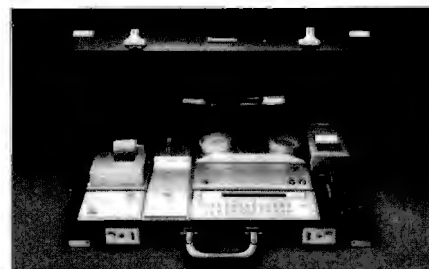

Take The Link and all its components anywhere in its slim attaché case.

and runs on AC or rechargeable batteries.

And it costs only \$600.00.* That's amazingly small when you realize the big change it could make in the way you do business.

*Manufacturer's suggested price.

Panasonic Company, Portable Computers
One Panasonic Way, Secaucus, N.J. 07094

- Please send me information on The Link.
 Please have a salesman call me.

NAME _____ PLEASE PRINT

TITLE _____

COMPANY _____

TYPE OF BUSINESS _____

ADDRESS _____

CITY _____ STATE _____ ZIP _____

PHONE NUMBER _____

Panasonic
just slightly ahead of our time. B

Listing 1 continued:

73	1580	1625	1603			WANFRIED SLIPWARE
2	1820	1900	1860	133	247380	WHITE REFINED EARTHENWARE
6	1795	1890	1843			MOCHA ON REFINED WHITE EARTHENWARE
29	1740	1780	1760			'JACKFIELD' WARE
33	1759	1775	1767			GREEN GLAZED CREAM BODIED WARE
36	1740	1770	1755			CLOUDED WARES, TORTOISESHELL, MOTTLED, CRE
42	1740	1775	1758			REFINED AGATE WARE
51	1725	1750	1738			'ASTBURY' WARE, WHITE SPRIGGED & TRAILED
78	1790	1840	1815			LUSTER DECORATED WARES
35	1750	1810	1780			COARSE AGATEWARE (NOT DOORKNOBS)
38	1745	1780	1763			IBERIAN STORAGE JARS
47	1720	1775	1748			BUCKLEY WARE
61	1650	1775	1713			NORTH DEVON GRAVEL TEMPERED WARE
21	1775	1800	1788			DEBASED ROUEN FAIENCE (ON BRITISH SITES)
32	1730	1830	1780			PEDESTAL FOOT DELFT OINTMENT POT
45	1700	1800	1750			EVERTED RIM, PLAIN DELFT OINTMENT POT
49	1600	1802	1701			DECORATED DELFT (EIGHTEENTH CENTURY)
57	1750	1800	1775			PLAIN DELFT WASH BASINS
60	1710	1740	1725			MIMOSA PATTERN DELFT
62	1620	1720	1670			ENGLISH DELFT (BLUE DASH CHARGERS)
64	1630	1700	1665			CYLINDRICAL DELFT OINTMENT POTS
65	1640	1800	1720			PLAIN WHITE DELFTWARE
71	1620	1775	1698			MONOCHROME DELFT APOTHECARY JARS
72	1580	1640	1610			POLYCHROME DELFT APOTHECARY JARS AND POTS
76	1660	1800	1730			DELFT CHAMBER POTS
8	1790	1820	1805			FINGERPAINTED POLYCHROME SLIP ON CREAMWARE
14	1780	1815	1798			ANNULAR WARES CREAMWARE
15	1775	1820	1798			LIGHTER YELLOW CREAMWARE
18	1765	1810	1788			OVERGLAZE ENAMELLED HAND PAINTED CREAMWARE
22	1762	1820	1791			CREAMWARE
23	1765	1815	1790			TRANSFER PRINTED CREAMWARE
25	1762	1780	1771			DEEPER YELLOW CREAMWARE
41	1750	1765	1758			LITTLER'S BLUE ON CREAMWARE
4	1820	1840	1830			UNDERGLAZE POLYCHROME PEARLWARE, DIRECT ST
6	1795	1890	1843			MOCHA PEARLWARE
8	1790	1820	1805			FINGERPAINTED POLYCHROME PEARLWARE
9	1800	1820	1810			EMBOSSSED FEATHERS, SCALES, ETC. ON PEARLWA
10	1795	1840	1818			WILLOW TRANSFER ON PEARLWARE
11	1795	1840	1818	3	5454	TRANSFER PRINTED PEARLWARE
12	1795	1815	1805			UNDERGLAZE POLYCHROME PEARLWARE
13	1790	1820	1805	3	5415	ANNULAR WARES PEARLWARE
17	1780	1820	1800			UNDERGLAZE BLUE HANDPAINTED PEARLWARE
19	1780	1830	1805	8	14440	BLUE & GREEN EDGED PEARLWARE
20	1780	1830	1805	4	7220	UNDECORATED PEARLWARE

RAW TOTAL OF SHERD COUNT: 157
 RAW TOTAL OF PRODUCT: 290535
 SHERD COUNT, ELIMINATING TYPES 26 AND 39: 157
 PRODUCT, ELIMINATING TYPES 26 AND 39: 290535

MEAN DATE : 1850.5414

MEAN BRACKET DATES :

1813.02548 AND 1887.96178

PRODUCED ON THE ARCHAEOLOGICAL REPORT GENERATING PROGRAM TITLED
 'POTS' WRITTEN BY EDWARD F. HEITE AND COPYRIGHT©1981
 BY EDWARD F. HEITE, P.O. BOX 53, CAMDEN, DELAWARE 19934.

FORMULA AND REPORTING FORMAT BASED ON STANLEY SOUTH'S ARTICLE,
 'EVOLUTION AND HORIZON AS REVEALED IN CERAMIC ANALYSIS IN
 HISTORICAL ARCHAEOLOGY, PUBLISHED IN THE PAPERS OF THE CONFERENCE
 ON HISTORIC SITE ARCHAEOLOGY 1971, JUNE 1972, PAGES 71-107
 TYPOLOGY DERIVED FROM I. NOEL HUME'S CLASSIFICATION IN HIS BOOK,

Listing 1 continued on page 92

"IBM Personal Computer" USERS YOU DESERVE THE BEST!

choose what the professionals use*

NEW!

Available Now
DISK++

Up to 12 MB Winchester Disk,
256KB parity memory
AND
1 Async Port

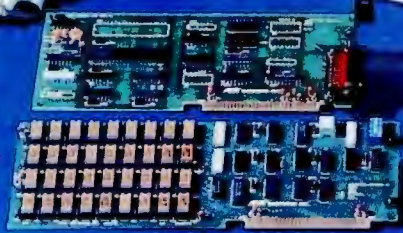

Combo Card (User Upgradeable)

- MC-064 64K From \$435
- MC-128 128K From \$635
- MC-192 192K From \$835
- MC-256 256K From \$1035
- Suffix S = ASYNC comm. option \$60
- Suffix P = parallel printer option \$60
- Suffix SP = both options \$120
- User upgrade document available for sale, order model MC-001SP
- Program compatible with IBM's

64KB-256KB Parity Memory

- MP-064: \$395 • MP-128: \$595
- MP-192: \$975 • MP-256: \$995
- User upgradeable
- Fully assembled, tested & burned-in
- 1-year warranty

Advanced Communication

- CC-232: \$295
- 2 RS232 ports
- Capable of ASYNC, BISYNC, SDLC, HDLC

ASYNC Communication

- CC-032: \$145 • CC-132: \$275
- CC-032 offers 1 serial port
- CC-132 offers 2 ports
- Program compatible with IBM's Serial Com. Card

Hardware Prototype

- WW-068: \$75 • WW-069: \$55
- WW-068 wire wrap card (13" x 4.2")
- WW-069 extender
- Get both for \$95

*Our customers include: IBM, TRW, Bell Labs, Visicorp, Softech Microsystems Inc., Information Unlimited Software, Context Management, Network Consulting Inc., etc.

AST

RESEARCH INC.

17925 Sky Park Circle, Suite B
Irvine, CA 92714 (714) 540-1333
Dealer Inquiries Welcome

Circle 3 on Inquiry card.



Listing 1 continued:

A GUIDE TO ARTIFACTS OF COLONIAL AMERICA, PUBLISHED BY ALFRED A. KNOPF, 1970.

MEAN BEGINNING AND ENDING DATES FROM TURNBAUGH AND TURNBAUGH IN HISTORICAL ARCHAEOLOGY VOLUME 11 FOR 1977

Histo-Grandma: A Permissive Histogram Program

Histograms are simple statistical reports, commonly used and understood even by people who are not inclined to express their thoughts in numbers. In our archaeological practice, we often use histograms to illustrate or simplify numerical relationships. Even rudimentary histograms require considerable drafting, scaling, and measuring. We wanted a simple drafting program that would

let us draw a histogram, inspect the results, and then edit if necessary. Not being inclined to think in the abstract, we wanted a program that would help us visualize a finished result and redraw it until it was exactly what we wanted.

Histo-Grandma, a permissive bar-plot program, was the result. It lets you draft a histogram, inspect it, change it, and reprint it. It calculates and, if necessary, recalculates the scale, helps select symbols, and

doesn't print a double line if you overrun the capacity of the line on the page. The edit routine can change anything in the illustration, except the number of bars, which would involve redimensioning arrays.

Grandma is written to be used by noncomputerists or to be modified by users with little computer experience. No manual is necessary. The program loops back through the edit routine until the user tells it to stop. Histo-Grandma's style is conversational, even breezy, on purpose, to help users feel more comfortable.

In writing the program, we spent as much effort on the screen prompts and on aesthetics as in developing the rather simple routines themselves. As a result, REM and PRINT statements constitute the bulk of the code. While the verbal paraphernalia is technically unnecessary, it is the prime ingredient in a user-friendly program. Programmers may be aghast at the apparently inelegant programming style, which in fact is designed to help inexperienced users follow the logic more closely.

Listing 2 presents Histo-Grandma in its entirety. The program uses Commodore BASIC, with PET graphics, but probably can be adapted for other machines with little difficulty. The print routine at line 10,000 uses formatting features peculiar to Commodore dot-matrix printers. With the details provided in REM statements, it should be fairly simple to adapt it for wider printers or for daisy-wheel printers.

Figure 3 shows two graphs generated by Histo-Grandma. We hope the program proves as useful to you as it has been to us.

What Next?

With the advent of truly portable computers, we expect that archaeological field notes will be written on cassette tape in digital form. When

Text continued on page 102



Photo 1: An archaeological project involves painstaking record-keeping as well as massive earth-moving. In this excavation at Naamans, Delaware, workers are scraping the subsoil to reveal faint stains left by post holes and ditch lines in a garden.

Introducing the DMS-3/F "Fox." More than another portable— it's a low-cost stand-alone or network station.

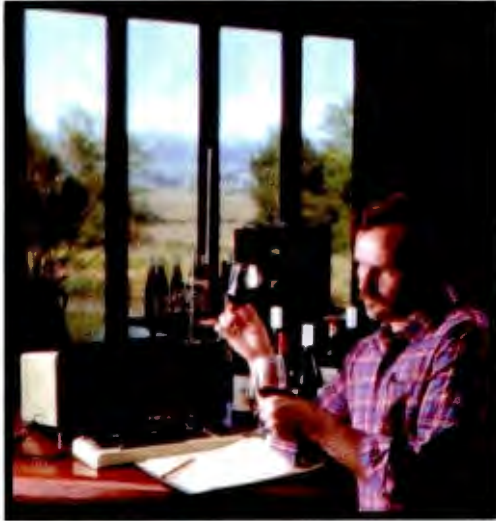

With its 9" diagonal screen, "The Fox" has triple the capacity of the most popular portable. Yet the outstanding feature of the 30 lb. portable "Fox" is its performance on or off the HiNet™ Local Area Network.

HiNet is a complete hardware/software network—so inexpensive that you can add a computer anywhere your business requires for about the cost of a good typewriter. Because HiNet is a network of interconnected computers, you can get information from other departments instantly.

And HiNet electronic mail saves wasted telephone time and aids interoffice communication.

The CP/M®-based "Fox" combines a 64K Z80A processor, local storage, drives, four RS-232C serial ports, an 8 bit bidirectional parallel port, the HiNet networking port, and 32 (x3) programmable function keys. It's also capable of emulating any terminal.

The DMS-3/F "Fox." Catch one now.



Digital Microsystems



Because man was not meant to work alone.

How to make work like a

First, neatly cut out the "370" label.

Now, when nobody's looking, nonchalantly tape it to your terminal, just under the "IBM," as if it really belonged there.

Then wait for your chance and quickly slip a dBASE II™ disk into your main drive.

That's it.

Your IBM Personal Computer is now ready to run a relational database system, the kind that IBM put on their mainframes last year.

And you're ready with more data handling power than you would have dreamed possible before dBASE II.

You'll wonder how you managed without it.

You'll find that dBASE II, because it's a relational database management system (DBMS), starts where file handling programs leave off.

dBASE II handles multiple databases and simplifies everything from accounting to department staffing to monitoring rainfall on the Upper Volta.

With a word or two, you CREATE databases, APPEND new data instantly, UPDATE, MODIFY and REPLACE fields, records and entire databases. Organize months worth of data in minutes with the built-in REPORT. Do sub-field and multi-field searches, then DISPLAY some or all of the data for any condition you want to apply.

And you've just begun to tap the power of dBASE II.

Easy to look at, easy to use.

Input screens and output forms couldn't be easier—just "paint" your format on the CRT and what you see is what you'll get.



You can do automatic calculations on fields, records and databases, accurate to 10 digits.

And you can use dBASE II interactively for answers right now. Or save your instructions, then repeat everything with two words: DO Manhours, DO ProjectX, DO whatever has to be done.

Use dBASE II to help make your choice:

If you've got a 96k IBM PC, send us \$700 and we'll send you a copy of dBASE II to use free for 30 days.

e your micro mainframe.



Instead of just poring over a manual, run it and make sure that it does what you need done.

Then if you find it isn't right for you, send it back and we'll return your money, no questions asked.

But if you do that, you'll have to remove that label. Because nothing short of a mainframe works like dBASE II.

Call (213) 204-5570 today or drop by your local computer store for the rest of the story.

Ashton-Tate, 9929 Jefferson Blvd.,
Culver City, CA 90230.

Ashton-Tate

© 1982 Ashton-Tate
CP/M is a registered trademark of Digital Research

Listing 2: *Histo-Grandma*, a program that prompts the user for input and then generates histograms based on the data entered. Written in Commodore BASIC, *Histo-Grandma* produces bar graphs but does not require the user to know any technical terms. The formatting routine starts at line 13, the input routine at line 250, the print routine at line 10000, the revision routine at line 32075, and the edit routine at line 35000.

```

1 PRINT"THIS PROGRAM IS CALLED HISTO-GRANDMA":PRINT
2 PRINT"BECAUSE IT LETS YOU DO ANYTHING YOU":PRINT
3 PRINT"WANT WITH HISTOGRAMS. IT SPOILS YOU.":PRINT
6 PRINT"HISTO-GRANDMA WILL NOT CRITICIZE OR":PRINT
7 PRINT"CORRECT YOU; SHE IS VERY PERMISSIVE":PRINT
8 PRINT"IN LETTING YOU BE CREATIVE.":PRINT:PRINT:PRINT:PRINT
10 INPUT"TO START, HIT RETURN":Z$:PRINT"
13 REM***** FORMATTING ROUTINE *
15 INPUT"HOW MANY BARS IN THIS GRAPH":A:PRINT:PRINT
17 PRINT"WHAT IS THE TITLE FOR THE TOP OF THE"
18 INPUT"GRAPH":C$:PRINT:PRINT
20 PRINT"NOW WE NEED A MAGNITUDE FOR THE WHOLE":PRINT
21 PRINT"GRAPH. YOU HAVE ABOUT 65 BLOCKS TO USE":PRINT
22 PRINT"IN CONSTRUCTING YOUR BARS. PICK A VALUE":PRINT
23 INPUT"FOR EACH BLOCK":C:PRINT:PRINT
24 B=(C*65):PRINT:PRINT"MAXIMUM VALUE ON A BAR IS":PRINT:PRINTB:PRINT
25 PRINT"NOW, DEFINE THE MINIMUM VALUE THAT WILL":PRINT
26 PRINT"BE DISPLAYED. IF YOU HIT RETURN, IT'LL":PRINT
27 INPUT"DEFAULT TO ZERO":D:PRINT
40 PRINT"NOW IT IS TIME TO CREATE YOUR GRAPH":PRINT:PRINT:PRINT
42 PRINT"EACH BAR WILL HAVE A NAME, LIMITED":PRINT
44 PRINT"TO SEVEN CHARACTERS, INCLUDING":PRINT
45 PRINT"SPACES. YOU WILL ALSO BE ABLE TO":PRINT
46 PRINT"DECIDE WHICH GRAPHIC CHARACTER WILL BE":PRINT
47 PRINT"USED IN THAT PARTICULAR BAR. YOU MAY":PRINT
48 PRINT"ALSO SKIP A SPACE BY HITTING RETURN":PRINT
49 PRINT"WHEN IT ASKS FOR THE VALUE.":PRINT
55 INPUT"PRESS RETURN TO CONTINUE":Z$
200 DIMJ$(A):DIMX$(A):DIMY$(A):DIMY(A):DIMV(A):PRINT"
250 REM***** INPUT ROUTINE **
300 FORJ=1TOA:PRINT:PRINT:PRINT:Y$(J)=""
315 PRINT"CREATING BAR NUMBER":PRINT:PRINT
316 PRINT"      J:PRINT:PRINT
320 INPUT"NAME THIS BAR":J$(J)
330 PRINT INPUT"SYMBOL FOR THIS BAR":X$(J):PRINT
340 INPUT"VALUE OF THIS BAR":V(J)
345 Y(J)=V(J)-D
350 FORX=1TOY(J)STEPD
360 Y$(J)=X$(J)+Y$(J)
365 IFV(J)<=DTHENY$(J)=""
366 NEXTX
367 PRINT"THIS WILL APPEAR AS FOLLOWS":PRINT
368 PRINTV(J);J$(J);Y$(J)
370 NEXTJ
373 PRINT"BE SURE THE PRINTER IS SET UP TO PRINT"
375 FOR J=1TO5000
400 NEXT J
2500 GG=D+(10*C)
2505 HH=GG+(10*C)
2510 JJ=HH+(10*C)
2520 KK=JJ+(10*C)
2530 LL=KK+(10*C)
2540 MM=LL+(10*C)
5000 PRINT"          PRINTING"
10000 REM***** PRINT ROUTINE *
10010 OPEN2,4,2
10015 G$=""

```

Listing 2 continued on page 98

HEATH/ZENITH & YOU... ONE STRONG PARTNERSHIP.

Buying a computer is only the beginning of a long-term partnership between you and the people from whom you buy. Your ongoing need for software, peripherals and accessories requires a partner who will stand by you. With a growing line of products to meet your needs with professional service and support, Heath/Zenith is that strong partner. Look at what we have to offer:

THE ALL-IN-ONE COMPUTER – The heart of the Heath/Zenith line is the stand-alone *89 Computer*. It's a complete system with built-in 5.25-inch floppy disk drive, professional keyboard and keypad, smart video terminal, two Z-80 micro-processors and three RS-232C Serial I/O Ports. It comes with 48K bytes of RAM, expandable to 64K.

PERIPHERALS AND ACCESSORIES – These include the popular *Heath/Zenith 19 Smart Video Terminal*, loaded with professional features. We also offer color and black and white monitors, modems, computer language courses, and high-speed typewriter-quality printers.

SOFTWARE – Our complete library of software includes the SuperCalc Spreadsheet and Condor Data Base Management System. *Word processing*, includes three different programs. *Small Business Programs* feature Peachtree's P5 Series, General Ledger and Inventory Control. *HUG, Heath Users' Group*, offers members a library of over 500 low-cost programs for home, work or play.

PROGRAMMING LANGUAGES – To write your own programs, Microsoft BASIC (compiler and interpreter), FORTRAN and COBOL Languages are available.

APPLICATIONS SOFTWARE – Expand the performance range of your computer with a broad selection of software, including the best of *Digital Research* and *Micropro* – as well as the complete line of *Softstuff™* products.

OPERATING SYSTEMS – Three versatile systems give you the capability to perform your specific tasks. *CP/M by Digital Research* makes your system compatible with thousands of popular CP/M programs. *UCSD P-System with Pascal* is a complete program development and execution environment. And *HDOS, Heath Disk Operating System* gives you a sophisticated flexible environment for program construction, storage and editing.

DISK SYSTEMS – The new *Heath/Zenith 67 Winchester Disk System*, for commercial use, adds nearly 11 megabytes of storage to your 89 computer. It includes an 8-inch floppy disk drive for data portability. The new 5.25-inch 37 disk system, available with 1 or 2 drives, adds up to 1.28 megabytes of storage. Both plug-in systems have write protection.

SERVICE AND SUPPORT – Prompt and professional service and assistance is available nationally through Heathkit Electronic Centers, Zenith Data Systems for commercial users or through Heath factory servicing and phone-in technical assistance.

Complete, integrated computer hardware and software, designed to serve and grow with you – that's what to look for in a strong partner. And with Heath/Zenith, you get it all.

Heath/Zenith computer products are sold nationwide through Heathkit Electronic Centers* (check your white pages for locations). For a FREE colorful full-line catalog, write: Heath Co., Dept. 334-914, Benton Harbor, MI 49022.

HEATH/ZENITH

Your strong partner



Product specifications are subject to change without notice.
Heath Company and Veritechnology Electronics Corporation are wholly-owned subsidiaries of Zenith Radio Corporation
*Heathkit Electronic Centers are operated by Veritechnology Electronics Corporation

CP-210R1

```

10019 H$="9999          9999          9999          9999          9999          9999          9999"
10021 H$=G$+H$:PRINT#2,H$:OPEN1,4,0:OPEN3,4,1:PRINT#1,"J"
10111 PRINT#1,CHR$(1)C$CHR$(10)
10113 PRINT#3,D,GG,HH,JJ,KK,LL,MM
10122 E$="_____ "
10133 F$="          "
10134 E$=F$+E$:PRINT#1,E$:PRINT#1,CHR$(10):CLOSE2:CLOSE3:OPEN5,4,2
10170 F$="AAAAAAAAAAAAAAAAAAAAAAAAAAAAAAAAAAAAAAAAAAAAAAAAAAAAAAAAAAAAAAAA"
10180 G$="9999 AAAAAA AA"
10190 F$=G$+F$:PRINT#5,F$:OPEN3,4,1:N=0:FORJ=1TOA:N=N+V(J)
10200 PRINT#5,F$
10220 PRINT#3,V(J),J$(J),CHR$(29),Y$(J):PRINT#1,CHR$(10)CHR$(10):NEXTJ
10221 REM *****
10222 REM ***** PROGRAMMER'S NOTE: *****
10223 REM ***** TO COMPRESS SPACE BETWEEN *****
10224 REM ***** BARS, DELETE CHR$(10) IN 10220*****
10225 REM *****
10226 REM *****
10227 PRINT#1,E$CHR$(10)CHR$(10)"N ="N
10236 PRINT#1,CHR$(19):CLOSE1:CLOSE3:CLOSE5:GOSUB32000
31999 REM***** SELECT REVISION *****
32000 PRINT"DO YOU WANT TO REVISE ANY ASPECT":PRINT
32050 PRINT"OF THE GRAPHIC YOU HAVE PRINTED?":PRINT
32060 INPUT"IF SO, STRIKE  AND  RETURN  N";Q$
32070 IFQ$="Y"THEN GOTO32090
32071 IFQ$<"Y"THEN END
32075 REM***** REVISION ROUTINE **
32090 PRINT"REVISION ROUTINE BEGINS":PRINT:PRINT:PRINT
32100 PRINT"THE MAGNITUDE OF EACH INCREMENT OF THE"
32105 PRINT·PRINT"BAR IS "C:PRINT:PRINT"IS THIS SATISFACTORY?":PRINT
32115 PRINT:PRINT"TO CHANGE IT, HIT THE  AND  RETURN":PRINT
32120 INPUT"KEY  N";Q$
32125 IF Q$="Y" THEN GOTO 32130
32126 IF Q$<"Y"THENGOTO35000
32130 INPUT"NEW VALUE IS ";C
33340 FOR J=1TOA:Y$(J)="":Y(J)=V(J)-D:FORX=1TOY(J)STEPC:Y$(J)=X$(J)+Y$(J)
33365 IFV(J)<DTHENY$(J)="
33370 NEXTX
33375 NEXTJ
35000 REM***** TITLE EDIT ROUTINE **
35001 PRINT"THE TITLE AT THE HEAD IS:"
35005 PRINT:PRINTC$:PRINT:PRINT"IF YOU WISH TO CHANGE THIS TITLE,"
35015 PRINT:PRINT"PRESS THE  AND  RETURN KEYS;" PRINT
35020 PRINT"OTHERWISE, PRESS THE  RETURN KEY ALONE":PRINT
35120 INPUT"  N";Q$:IFQ$="Y"THENGOTO35130
35126 IF Q$<"Y"THENGOTO36000
35130 INPUT"NEW NAME IS ";C$
36000 REM***** BAR EDIT ROUTINE ***
36005 PRINT"WE WILL NOW BEGIN EDITING THE BARS"
36010 PRINT"ON YOUR CHART. YOUR HUMBLE MECHANICAL"
36015 PRINT"SERVANT WILL FLASH EACH BAR'S DATA"
36020 PRINT"ON THE SCREEN, AND WILL ASK YOU FOR"
36030 PRINT"A JUDGMENT ON IT. IF THE BAR IS OK,"
36035 PRINT"SIMPLY PRESS THE  RETURN KEY, AND THE"
36040 PRINT"NEXT BAR WILL BE PROJECTED ON THE"
36045 PRINT"SCREEN FOR YOUR PERUSAL.":PRINT:PRINT
36100 PRINT"IF YOU WISH TO USE THIS ROUTINE,"
36110 PRINT"PRESS THE  KEY AND THE  RETURN"
36120 INPUT"KEY  N";Q$:PRINT:PRINT:PRINT
36125 IF Q$="Y" THEN GOTO 36129
36126 IF Q$<"Y"THENGOTO37000
36129 FORJ=1TOA
36130 PRINT"THE VALUE OF BAR NUMBER "J:PRINT:PRINT"IS "V(J):PRINT
36160 PRINT"AND THE SYMBOL IS "X$(J):PRINT

```

SBC I

SBC I

SYSTEMASTER®

The Next Logical Step

Teletek FDC-I, The First Step

A CPU, floppy disc controller and I/O all on one board. Until SYSTEMASTER® the most powerful IEEE-S-100 board on the market.

Teletek SBC-I, The Second Step

A board designed for use in high performance, multiprocessing systems. SBC-I combines its own CPU, serial and parallel ports, 128K of segmented memory and FIFO.

SYSTEMASTER®, The Next Logical Step

Teletek's newest product — a breakthrough in S-100 board design. SYSTEMASTER® is a complete system. No other boards are required. It doesn't even require a bus!

But, when used with an S-100 bus, SYSTEMASTER® has even more capabilities. You can readily expand to multi-user or multi-processor systems using SYSTEMASTER® as the master board.

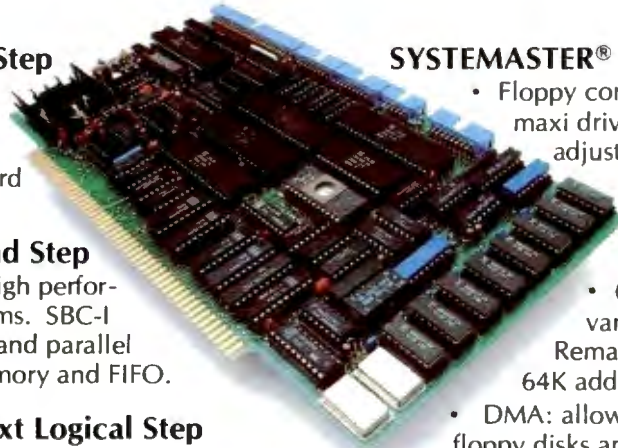

SYSTEMASTER® Features:

- Floppy controller: controls mini and/or maxi drives; variable independently-adjustable pre-write compensation.
- CPU: 4MHz Z80A
- Two RS-232C ports.
- Two full parallel ports.
- 64K bank-selectable memory variable from 32K to 60K. Remaining memory is fixed at top of 64K address space.
- DMA: allows transparent data transfer to floppy disks and other devices without CPU wait states.
- Relocatable EPROM/ROM/PROM: 2K, 4K or 8K with deselect capability.
- Real-time clock.
- Operating systems available: Digital Research or Turbodos.
- Parallel ports may be connected to Teletek's PSC board for RS-422 capability.

TELETEK

9767F Business Park Drive Sacramento, CA 95827 (916) 361-1777

Listing 2 continued:

```

36170 PRINT"NAMED "J$(J):PRINT:PRINT:PRINT
36180 INPUT"DO YOU APPROVE  Y####";Q$:PRINT:PRINT:PRINT:PRINT
36190 IF Q$<"Y" THEN GOTO 36200
36195 IF Q$="Y"THENGOTO36999
36200 REM***** CORRECT BARS ****
36310 Y$(J)=" "
36320 INPUT"NAME THIS BAR  X####";J$(J)
36330 INPUT"SYMBOL FOR THIS BAR  #####";X$(J)
36340 INPUT"VALUE OF THIS BAR  @####";V(J)
36345 Y(J)=V(J)-D
36350 FORX=1TOY(J)STEPC
36360 Y$(J)=X$(J)+Y$(J)
36365 IFV(J)<=DTHENY$(J)=" "
36370 NEXTX
36375 PRINTJ$(J);Y$(J)
36999 NEXT J
37000 GOTO2500
39000 REM***** VARIABLES LIST ****
61000 REM  A=NUMBER OF BARS AND DIMENSION OF ARRAYS
61005 REM  B=TOTAL POSSIBLE VALUE OF EACH BAR ON THE GRAPH
61010 REM  C$=TITLE OF GRAPH LIMITED TO FORTY CHARACTERS
61015 REM  C=VALUE OF EACH GRAPHIC CHARACTER BLOCK
61020 REM  D=MINIMUM VALUE SHOWN IN GRAPHIC REPRESENTATION
61025 REM  E$=INDEX LINE AT TOP AND BOTTOM
61030 REM  F$=TEMPORARY FORMATTING VARIABLE
61040 REM  G$=THIRTEEN BLANK SPACES
61045 REM  H$=FORMAT STRING FOR SCALE LABELLING
61050 REM  J=SUBSCRIPT OF ARRAY DURING MAIN FOR-NEXT LOOPS
61055 REM  J$=BAR NAME
61060 REM  N=TOTAL NUMBER OF ITEMS COUNTED
61065 REM  Q$=INPUT VARIABLE IN REVISION SUBROUTINE
61070 REM  V=VALUE OF EACH BAR AS INPUT BY THE USER
61075 REM  X=LOOP DEFINITION VARIABLE FOR NESTED FOR-NEXT LOOPS
61080 REM  Y$=UTILITY INPUT VARIABLE
61085 REM  Y=MAGNITUDE OF BAR UNDER CONSTRUCTION
61095 REM  Z$=UTILITY INPUT VARIABLE
62000 REM  GG=D+(10*C)---TEN SPACES LABEL
62100 REM  HH=GG+(10*C)---TWENTY SPACES LABEL
62200 REM  JJ=HH+(10*C)----THIRTY SPACES LABEL
62300 REM  KK=JJ+(10*C)-----FORTY SPACES LABEL
62400 REM  LL=KK+(10*C)-----FIFTY SPACES LABEL
62500 REM  MM=LL+(10*C)-----SIXTY SPACES LABEL

```

\$\$ READ THIS IF YOU WANT TO SAVE MONEY \$\$
BEST HARDWARE AND SOFTWARE DEALS AVAILABLE!

APPLE BUSINESS SOFTWARE
 Visicalc \$210
 Versaform \$299
 Milestone \$255
 Supercalc \$225
 DB Master \$185
 DB Master Util. Pak \$ 79
 Pro Easywriter \$199
 Accounting Plus } Call for Best Prices
 BPI Software }
 d Base II }
 FMS-80, 81, 82 }
 VSI Series Software }
*** THE LAST ONE ***
 The program that writes programs! Special Offer with purchase. Call.
APPLE PERIPHERALS
 Thunderclock \$125
 Basis Encoder Board (U/L Case) \$109
 Mountain Computer Products Call

Videx Products } Call for Best Prices
 Microsoft Products }
 Corvus Products }
 SVA Products }
APPLE II Plus 48K
 Apple II Drive } Call for Best Prices
 w/Controller }
 Apple II Drive Only }
 Apple III }
*** SPECIAL * MICROSOFT PREMIUM SYSTEM, incl.**
 Microsoft Z-80 Card } All for Only \$825
 Microsoft 16K Card }
 Videx 80 Column Card }
 Videx Soft-Switch }
 Osborne CP/M }
 User's Guide }
*** DISKETTE SPECIALS ***
 Maxell MD-1 (Box of 10) \$ 32
 Maxell 8" (Box of 10) \$ 41
 Verbatim 5 1/4" \$ 29
 Verbatim 8" \$ 35
 BASF 5 1/4" \$ 32

COMMUNICATIONS
 Hayes Micromodem II \$275
 Hayes Smart Modem \$235
 Hayes Chronograph \$225
 Novation Apple Cat II \$335
 Micro Courier \$210
PRINTERS & INTERFACES
 NEC Spinwriter 7710 \$2350
 Anadex DP-9501
 w/2K Buffer \$1295

Okidata Microline 83A \$745
 CCS Interface Cards Call
 Qume and Diablo Call
MICRO PRO
 Wordstar \$230
 Supersort \$130
 Mail Merger \$ 99
 Data Star \$230
 Spell Star \$130
 Calc Star \$130
 CP/M 8" Versions Call
COMPUTER SYSTEMS
 Xerox 820 Computer Call
 Xerox Peripherals Call
MONITORS
 NEC Hi-Res 12" Green \$170
 NEC Hi-Res 9" Green \$165
 NEC RGB 12" Color \$995
 Sanyo Monitors Call
 Amdek Monitors Call
MISCELLANEOUS
 TG Joysticks \$ 45
 TG Paddles \$ 30
 ABT Keypads \$ 99
 System Saver (Fan & Surge Prot.) \$ 77
 Disk Storage Pages (10 per Set) \$ 6



Minimum order \$100. Customers checks and money orders accepted. Add 3% for VISA or MC. Add 3% for shipping/insurance/handling. UPS. No COD. Prices subject to change. Call to verify. Order hours 9-5 PDT. Non-Fin. Personal checks allow 20 days to clear. All products with full manufacturer's warranty, factory sealed. Calif. residents add 6% sales tax.
 Apple is a registered trademark of Apple Computer, Inc. All brand names are registered trademarks.



1400 GRANT AVE. / NOVATO, CALIFORNIA 94947
IMMEDIATE DELIVERY • CALL COLLECT
415-892-7139 or 415-897-1414

One of the great masters?

Although the Datasouth DS180 matrix printer may not exactly rate as a work of art, our customers have a *very* high opinion of its value. Over the past year, we have shipped thousands of DS180 printers to customers throughout the world. Many of our sales now come in the form of repeat business—a strong testimonial to the acceptance of a product.

The success of the DS180 in a very competitive market did not happen by accident; rather through our sensitivity to the needs of the industry. This sensitivity we carry through research and development, production and quality control and finally to after sales support and service.

Recently we introduced new enhancements to make the DS180 printer even more versatile. Dot addressable raster scan graphics produces output of computer generated charts, maps and graphs at a resolution of 75 x 72 dots per inch. Variable horizontal pitch selection allows printing at 10, 12 or 16.5 characters per inch plus double wide printing at 5, 6 or 8.25 characters per inch. The expanded 2K FIFO print buffer handles a full CRT screen dump at up to 9600 baud without delaying the host system. We also offer transparent mode for isolating communications problems, and for APL users, the dual ASCII/APL character set option.

Check our list of features and we think you will agree that the DS180 offers the most complete performance package in matrix printers.

DS180 PRINTER STANDARD FEATURES

- Microprocessor Control
- 180 CPS Print Speed
- Bidirectional Toner Suckling
- 1000 Character Buffer (Expandable)
- 9x7 Dot Matrix
- Expanded Characters
- Adjustable Printhead 1 to 6 Copies
- 96 ASCII Character Set
- Cartridge Ribbon
- 1.32 Column Print Width
- Traction Feed (Front or Bottom)
- Non-Volatile Form Retention
- Top of Form
- Horizontal Tabs

- Vertical Tabs
- Portionation Skip Over
- Auto Line Feed
- 6 SFL
- Auto End of Line Carriage Return
- 5 IPS Paper Skew
- Parallel and Serial Interfaces
- 110 9600 Baud Communications
- Terminal Status Indicators
- Audio Alarm
- Self Test
- X on, X off
- Paper Out Detection

OPTIONAL FEATURES

- Compressed Print 10, 12, 16.5 cps
- High Resolution Dot Addressable Graphics
- 2K Expanded Print Buffer
- APL/ASCII Character Set



The DS180 is available nationwide through our network of sales/service distributors.

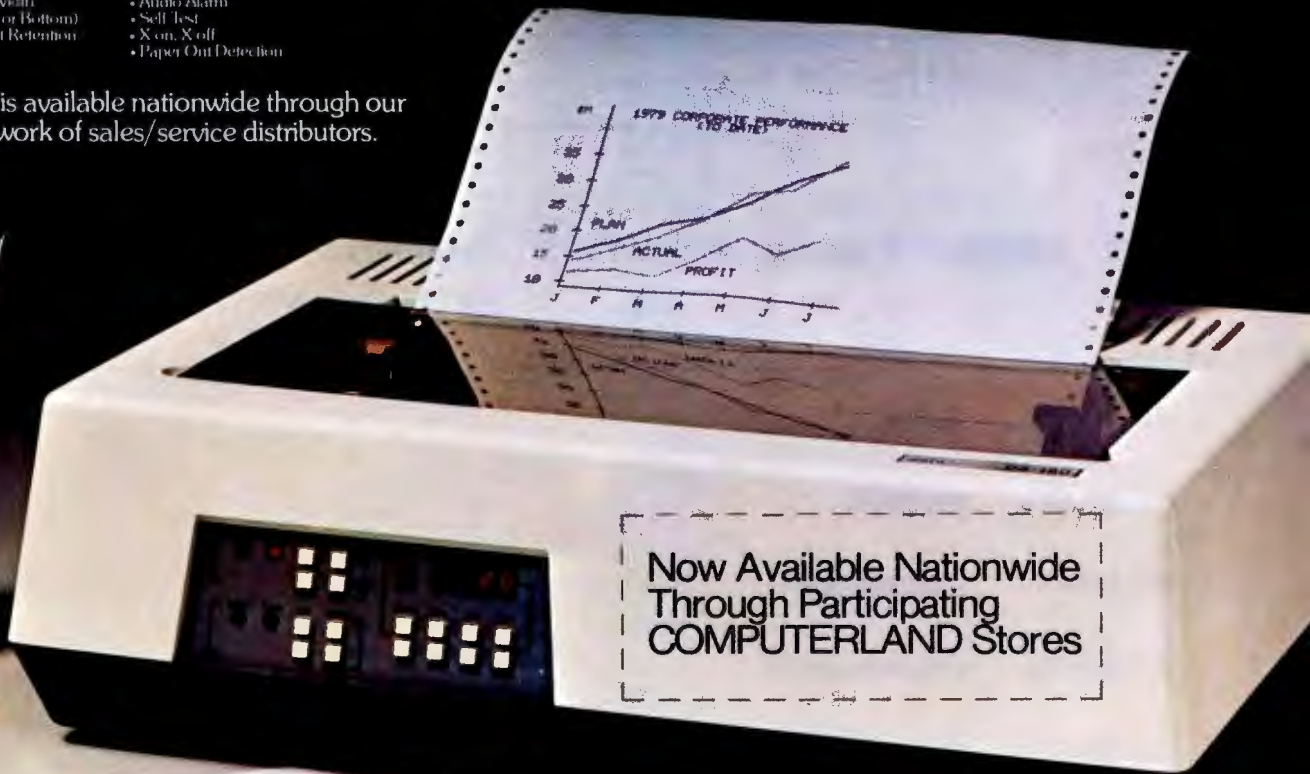

Now Available Nationwide
Through Participating
COMPUTERLAND Stores



Circle 128 on inquiry card.

datasouth
computer corporation

P.O. Box 240947 • Charlotte, NC 28224 • 704/523-8500

Text continued from page 92:

the cassette is returned to the lab, the field notes can be printed out on clean sheets of paper and electronically merged into the report. Electronic recording would be a tremendous labor-saver, since the present method of transcribing and retranscribing from smudged and dirty field notes is the source of many errors.

Such a system now exists in

England. The Museum of London's Department of Urban Archaeology has installed a PDP-11 minicomputer in its laboratory for artifact analysis. Data is recorded in the field by three microcomputers that move from site to site. Floppy disks are used to transport data files from the microcomputers to the minicomputer (see reference 7).

The principal bottlenecks in archaeology, where work slows and errors creep in, are retyping and reproofing. Every archaeological report passes through several review and rewrite processes, which in the past have been among the most costly aspects of the profession. Some offices add as much as 140 percent overhead, largely for unproductive clerical work. In

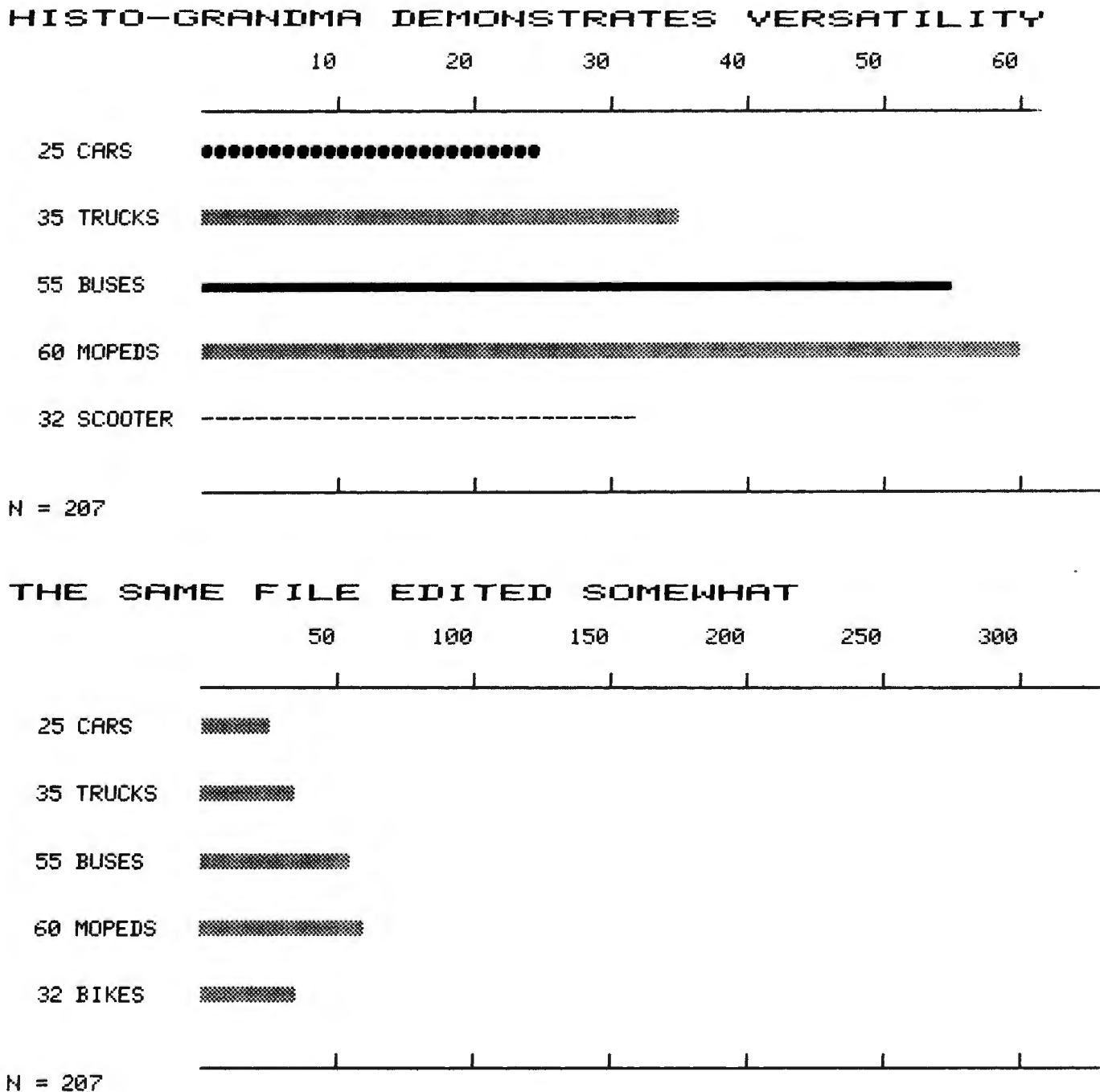

Figure 3: Two graphs that Histo-Grandma produced from the same input data. This illustrates the power of Histo-Grandma's edit routine, which begins at line 35000 of listing 2.

Columbia Data's New Multi-Personal Computer Is Now Ready For Business

With IBM Personal Computer Software And Hardware Compatibility . . . For Starters.



Columbia Data Products Multi-Personal Computer can use software and hardware originally intended for the IBM® Personal Computer . . . while enjoying the flexibility and expandability of all of Columbia Data's computer systems.

Available operating system software includes either single-user MS-DOS® (also called IBM PC-DOS or 86-DOS) or CP/M 86™ or multi-user, multi-tasking MP/M 86™ providing users with a host of compatible software packages for both personal and business applications. QAS/D-16™ and XENIX™ operating systems will also be available soon.

Our standard 16-bit 8086 hardware configuration provides 128K RAM with parity, two RS-232 serial ports, Centronics parallel printer port, DMA controller, eight levels of interrupt, dual floppy disk system with 1 Megabyte storage, Winchester disk interface and eight IBM-PC compatible expansion slots and bays for only \$2,995.

Columbia Data additionally provides 256K RAM boards, 8087 Arithmetic co-processor for high speed math functions, dual RS-232/RS-422 boards, networking capability, and Winchester disk based system . . . our expansion capability can easily accommodate just about any imaginable hardware configuration, including a 1 Megabyte RAM 8-user system. Call us for more information.



COLUMBIA

DATA PRODUCTS, INC.

Home Office
2000 Avenue 100
Columbia, MD 21046
Telephone: (301) 992-1400
FAX: (301) 992-7881

West Coast
1001 MacArthur Blvd.
Suite 277
Newport Beach, CA 92660
Telephone: 714/797-6666
Telex: 893001

Europe
P.O. Box 1116
4050 Mellebekepad
West Germany
Telephone: (051) 661616
Telex: 61616

IBM is the trademark of International Business Machines. IBM and MP/M are trademarks of Digital Research. QAS/D is the trademark of Prolog, Inc. MS-DOS and CP/M are trademarks of MICROSOFT.

Circle 80 on inquiry card.

our office, professionals draft their reports directly into a word processor, from field notes to finished copy, without any retyping. Reports are cleaner, better organized, and at least \$1500 less expensive, even for the simplest job. The obvious professional and financial advantages of eliminating clerical typing may, in fact, be the key to expanded microcomputer use in the social sciences and humanities.

Social scientists have learned that human activity obeys certain statistically expressed rules, provided the sample is large enough to eliminate anomalies caused by individual differences between people. The corollary of this statement is that researchers will continue to use large samples in order to derive general principles. The practical limit is about 1500 cases, which is well within the abilities of a microcomputer. It naturally follows that social scientists will need many new application programs tailored to their professions and in a language that these scholars

can easily understand. Some of these needs probably will be met by such shortcuts as the use of Visicalc overlays or front-end programs added to existing systems. In many cases, however, wholly new programs must be written.

Unfortunately, most subdisciplines in the humanities and social sciences are too small to support commercial development of the specialized, user-friendly microcomputer software that is needed immediately. Such systems already are available for the large legal, medical, and retail markets. The most practical way to market software for social scientists and humanists for some applications may be through modified off-the-shelf systems. We may see an "after-market" develop for customized database programs already being sold.

But until the microcomputer community begins to communicate in plain English, microcomputers will be slow to arrive on the humanistic market. ■

References

1. Fletcher, M. and Lock, G. R. "Computerised Pattern Perception within Post Hole Distributions," *Science and Archaeology*, no. 23 (1981), pp. 15-20.
2. Mrzowski, Steven and Brown, Marley, III. "The Social and Economic Dynamics of Property-holding and Property-transmission: A Key to Understanding Formation Process in Historical Archaeology." Presented at the Fifteenth Annual Meeting of the Society for Historical Archaeology, Philadelphia, January 8, 1982.
3. Nie, Norman H. *SPSS: Statistical Package for the Social Sciences* (2nd ed.). New York: McGraw-Hill Book Company, 1975.
4. South, Stanley. "Evolution and Horizon as Revealed in Ceramic Analysis in Historical Archaeology," *Conference on Historic Site Archaeology Papers 1971*. Columbia, SC: Conference on Historic Site Archaeology, 1972, p. 71.
5. Turnbaugh, William and Turnbaugh, Sarah Peabody. "Alternative Applications of the Mean Ceramic Date Concept for Interpreting Human Behavior," *Historical Archaeology*, vol. 11 (1977), pp. 90-104.
6. Walker, Iain C. "Statistical Methods for Dating Clay Pipe Fragments," *Post-Medieval Archaeology*, vol. 1 (1968), pp. 90-101.
7. *The London Archaeologist*, vol. 4 (5), p. 140.

SAVE \$\$

DISCOUNT PRICES

SAVE \$\$

 apple computer



APPLE COMPUTER SYSTEMS SOLD ONLY IN STORE. CALL FOR PRICES.

RAM MEMORY

FOR TRS-80, APPLE II
16K SET 4116's (200 NS) 24.95

General Information:

We carry a large selection of hardware and software by other companies. Send for our catalog.

We are an authorized repair center for **APPLE, ATARI, NORTH STAR, AND EPSON.**

 ATARI



400 16K	349.00
800 16K	699.00
410 Recorder	89.00
810 Disk	449.00
822 Printer	359.00
825 Printer	779.00
830 Modem	159.00
850 Interface Module	179.00
CX853 RAM	89.00
CX70 Light Pen	64.00
CX30 Paddle	18.00
CX40 Joystick	18.00

VERBATIM DISKETTES

Box of 10 5 1/4"	29.50
Box of 10 8"	39.50

 NorthStar

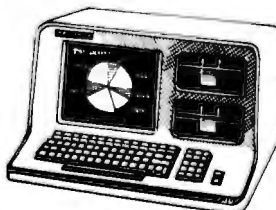

ADV-2Q-64K	3150.00
ADV-1Q-64K-HD-5	5195.00



HRZ-2Q-64K	2795.00
HRZ-1Q-64K-HD-5	4695.00
HRZ-1Q-64K-HD-18	6295.00
5 MB HARD DISK	2350.00
18 MB HARD DISK	4195.00

PRINTERS

EPSON	
MX-70	299.00
MX-80	469.00
MX-80 F/T	569.00
GRAFTRAX	90.00
INTERFACE (APPLE)	75.00
CABLE (APPLE)	22.50

IDS	
560G	1450.00
PRISM	1795.00

NEC	
3510 35CPS	1995.00
7710 55CPS	2650.00
8023A	599.00

OKIDATA	
MICROLINE 80	389.00
MICROLINE 82A	549.00
MICROLINE 83A	849.00
MICROLINE 84	1245.00

C.I.T.O.H.	
STARWRITER 25CPS	1595.00
STARWRITER 45CPS	2195.00
FORMS TRACTOR	275.00

PRICES SUBJECT TO CHANGE WITHOUT NOTICE. MARYLAND RESIDENTS ADD 5% SALES TAX

FREDERICK COMPUTER PRODUCTS, INC. 5726 INDUSTRY LANE

TO ORDER CALL:
(301) 694-8884

Store Hours:
MON. THRU THURS. 9:30 AM-9:00 PM
FRI. AND SAT. 9:30 AM-5:00 PM
FREDERICK, MD. 21701

Aladdin's slave was pretty good . . . but ours is even better.

MBI Introduces

The PERFECT SLAVE™

APM™ Multibus* and CP/M† compatible

At MBI, we think a slave shouldn't have to rely on the system master. That's why we created The Perfect Slave — the first intelligent slave board containing *everything* you need to run software, even an "operating system." No bootstrapping or additional boards are required, which means you save time and money.

- Z-80A‡
- 4 MHz
- 256K RAM (dual port)
- 4 Serial I/O ports (to 38.4K BAUD)
- 2 Parallel Ports (configurable)
- 4 28-Pin ROM Sockets (1K-32K)
- 4 Clocks (programmable)
- Bank Select
- Byte or Word Accessible
- Operating System

The Perfect Slave allows you to . . . perform background processing . . . overlap I/O functions . . . double buffer I/O . . . and expand memory while adding full I/O and processor. A special feature of The Perfect Slave, dual ported memory, enables you to perform high speed data manipulations for 8 or 16 Masters.

Special Evaluation Price: \$1295

Offer expires August 31, 1982 Limit 2 boards per customer



™ Trademark of M.B.I., Inc.

*Multibus is a registered trademark of Intel, Inc.

†CP/M is a registered trademark of Digital Research

‡Z-80A is a registered trademark of Zilog, Inc.

Circle 235 on inquiry card.

THIS IS A TELEVIDEO TERMINAL;
THE SIMILARLY-PRICED
TERMINAL ON THE RIGHT IS NOT.

WHICH WOULD YOU RATHER READ ALL DAY?

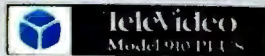

Unretouched photos — identical condition
Screens not actual size

Which would you

Our competitor on the right claims high resolution. But what about that glare? The washed-out background? And the black and white screen? It's enough to give you a headache.

The TeleVideo terminal on the other hand, with its finer character dot matrix, sharper background contrast, and a black-on-green non-glare Panasonic screen, is much easier on the eyes.

Obviously.

Every TeleVideo terminal has just four basic modules. Each module is the best that can be made.

Every screen, keyboard switch, power supply and video module on every TeleVideo terminal is identical. For the same high reliability. And same ease of service.

None of our competitors can say that.

If you order 200 terminals today, we can ship them tomorrow. If you order 500, we can still ship them tomorrow.

And if you order 1,000, well, maybe you'll have to wait a day or two.

The
920C



The 910
PLUS



We put our terminals through five bad days so you'll never have even one bad day.

Our terminals are designed to withstand heat up to

THIS IS NOT A TELEVIDEO TERMINAL.
 THE SIMILARLY-PRICED
 TERMINAL ON THE LEFT IS.
 WHICH WOULD YOU RATHER READ ALL DAY?

rather read all day?

155°F and shocks that simulate being tossed in the back of a truck. And before any terminal reaches you, every major component goes through a five day series of thermal and power-on cycling tests.

The result?

The highest reliability rate in our industry.

TeleVideo sells 50% more terminals a month than our nearest competitor.

Three years ago, TeleVideo shipped its first terminal. Today, we're the number one



The 910

independent terminal supplier.

One reason is because our advantages are clearly visible.

8 hours a day.

For more information call, toll-free, 800-538-8725. (In California, call 408-745-7760.) Or call your nearest TeleVideo sales office.

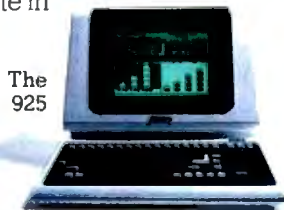

The 925

The 950



TeleVideo[®]

All TeleVideo terminals can be serviced by your nearest GE Instrumentation and Communication Equipment Service Center

Circle 380 on Inquiry card.

Microcomputers in the Study of Politics

Predicting Wars with the Richardson Arms-Race Model

*A Pascal program gives insight into arms races and
other two-party conflicts.*

Philip A. Schrodt
Associate Professor of Political Science
Northwestern University
Evanston, IL 60201

Mention the words "computer" and "war" and the image comes to mind of either massive Pentagon electronic brains monitoring the global military situation or civilization reduced to radioactive dust through some minor computer glitch. ("Drat!" says the programmer, mushroom clouds billowing on the horizon. "It was only a little bug. . .") While the big machines may tend to these matters, political scientists are extensively using microcomputers for the study, prediction, and, perhaps, eventual prevention of war.

Computers have long been associated with the biological and physical sciences, but they are also beginning to find uses in the social sciences. Many political science departments are acquiring microcomputers or minicomputers to supplement existing remote terminals, and students taking political science are as likely to use the computer as their peers in physics or engineering. The Political Science Department at Northwestern University has spent more than \$30,000 to equip a computer laboratory with terminals and microcomputers. At the University of

Iowa, the Political Science Department decided to forgo an additional typist and purchased dozens of Commodore microcomputers for word processing, statistical work, and simulation.

Traditionally, the primary use of computers in political science has been for statistical analysis. Computers are now being applied more and more to the study of formal models of political systems. Some of these models are large-scale simulations with memory requirements exceeding the microcomputer's capability, but many are small enough to be programmed into a machine with only 64K bytes of RAM (random-access read/write memory). This article presents the Richardson arms-race model, including a Pascal program for its implementation.

The Richardson Arms-Race Model

In 1918, British meteorologist Lewis F. Richardson returned from ambulance service in World War I shocked by the violence and destruction he had seen. A skilled mathematician who would soon achieve recognition for his pioneering

work in numerical weather forecasting, Richardson was determined to apply his mathematical skills and modern scientific techniques to the understanding of war.

Since an arms race had preceded World War I, Richardson turned his attention to this phenomenon. From his work in physics, he was well acquainted with differential equations, which are used to model dynamic processes. Arms races, he reasoned, are also a dynamic process and could be approximated with a mathematical model.

After experimenting with dozens of detailed mathematical formulations, Richardson finally settled on a relatively simple model involving only three factors. First, nation X feels threatened by the arms of its opponent, nation Y. The more arms Y has, the more arms X will want to acquire. At the same time, however, nation X must meet basic social needs and can't devote its entire economy to producing weapons. Hence, the more arms X has, the fewer additional arms it will be able to acquire. Finally, Richardson reasoned, past grievances also affect the overall arms levels

WE HAVE A NEW APPROACH TO DISTRIBUTED PROCESSING THAT WORKS

Already implemented are electronic mail, word processing, complete cost accounting with inventory control and more. The secret is a new technology called Functionally Structured Distribution (FSD). At last, a system to organize and manage distributed processing applications that is really up and running. FSD technology is especially applicable to installations that require:

- Unlimited expandability supporting extremely large data bases and terminals in many cities.
- User-friendly software easily programmed in high level languages (COBOL, FORTRAN, and BASIC).
- System reliability (due to distributed hardware) while maintaining multiple levels of data security.
- Compatibility with existing mainframes and networks (including the Bell System).

We are presently installing Billings 6000 Computer Systems which take full advantage of distributed processing utilizing FSD technology. The 6000 Computer supports multiple hard disk drives with capacities of up to 64 Mbytes (formatted), streaming tapes for backup, auto-dial modems (2400 baud synchronous) for communications, and flexible disk drives for smaller installations.

For more information about FSD and the complete line of Billings Computers, contact your local computer store.

Billings Computer Corporation

18600 East 37th • Independence, MO 64057

(816) 373-0000



The Distributed Processing Specialists **Billings**

North Star's Advantage over IBM and Apple is easy to see.

The North Star ADVANTAGE desktop computer has higher precision graphics, better software, and greater disk capacity than the IBM Personal Computer or the Apple III. Plus, nationwide on-site service and free business graphics software. See it for yourself. Then check the price. You'll see how easy it is to own the North Star ADVANTAGE. For the name of the North Star dealer nearest you, call today.

CALL TOLL FREE
1-800-447-4700
(ILLINOIS 1-800-322-4400)



FOLLOW THE STAR
NorthStar™

14440 Catalina Street, San Leandro, California 94577

and are unaffected by the current levels. The same logic that applies to nation X also applies to Y, which has a similar equation. Mathematically, this reduces to:

$$\begin{aligned} X(t + 1) &= kY(t) - aX(t) + g \\ Y(t + 1) &= mX(t) - bY(t) + h \end{aligned}$$

The constants k , m , a , and b are all positive; g and h are either positive or negative depending on whether the two nations are basically hostile or basically friendly toward each other. The terms $X(t)$ and $Y(t)$ are the values of the arms levels at time t ; $X(t + 1)$ and $Y(t + 1)$ are those values for time $t + 1$. I have presented the model as a pair of finite difference equations, rather than using Richardson's original differential equations, because that is the form used in most research and the form most easy to compute.

The beauty of the Richardson model is that it is self-contained: if you know the values of the coefficients, and the values of the arms levels X and Y for one year, you can predict the arms levels for all future years. This gives the model the potential, in theory, of predicting the future. Richardson hoped that if politicians could predict wars, they could learn to avoid them.

Richardson's strikingly original work was ignored for decades. He continued his efforts in the field of mathematical international relations throughout his career and into his retirement, but achieved no recognition for it in scholarly or political circles. Richardson died in 1953, famed for his work in mathematical meteorology, but unknown in the field of political science.

Reviving Richardson

In the late 1950s, a group of mathematical social scientists at the universities of Chicago and Michigan—Anatol Rapoport, Quincy Wright, Nicolas Rashevsky, Kenneth Boulding, Frederick Mosteller, and others—rediscovered Richardson's work and began to publicize it. Rapoport's new *Journal of Conflict Resolution* devoted an entire issue to

IT'S CRISP. IT'S CLEAR. IT'S COMPATIBLE.



Amdek's Video-300 green phosphor monitor is the easy-reading choice for almost any system – including IBM and Apple.

Everything about our 12" Video-300 monitor was designed to be easy. Easy to read. Easy to use. And easy to match up with practically any computer or word processing system, including the popular Apple and IBM personal computers. So it's easy to see why you should choose Video-300 for your text display needs.

Amdek's Video-300 monitor features:

- Non-glare screen to eliminate distracting reflections
- P-31 green phosphor display for no-strain viewing
- 80 x 24 character display
- 18MHz band width 900 lines (center) resolution
- Built-in carrying handle for portability
- Light-weight, industrial-grade cabinetry (only 17 lbs.)
- UL, FCC approved
- Full one-year warranty covering parts and labor

So ask your dealer about Video-300 – part of Amdek's complete line of color, green phosphor and black and white monitors. Then match Video-300's performance and price against any other display monitor. For quality and value, you'll choose Amdek.

AMDEK

Amdek Corporation, 2420 E. Oakton St., Suite E, Arlington Heights, IL 60005. (312) 364-1180 • TLX: 25-4786

Circle 21 on inquiry card.

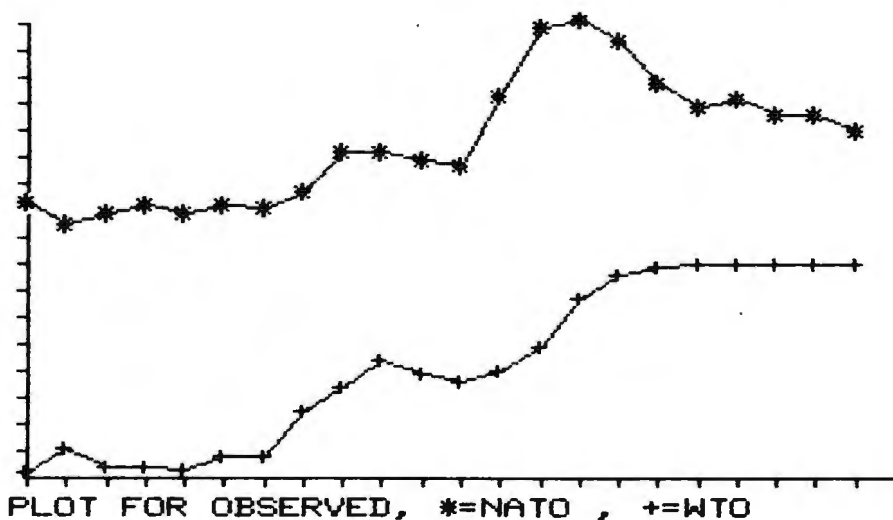

Figure 1: A plot of the total defense expenditures of NATO and the Warsaw Treaty Organization. The y axis shows expenditures in constant dollars adjusted for inflation; the x axis shows the passage of years. The plot, for the years 1955-1978, shows a stable arms race.

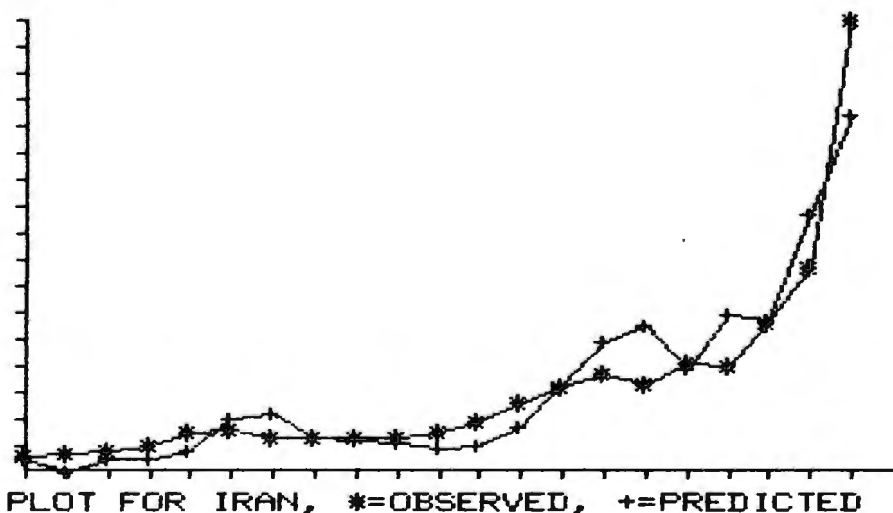

Figure 2: A plot of the observed and predicted arms expenditures of Iran, engaged in an unstable arms race with Iraq. The data, for the years 1954-1975, shows how closely actual expenditures approached those predicted by the Richardson model.

Richardson. Publication of Richardson's two microfilmed manuscripts, *Statistics of Deadly Quarrels* and *Arms and Insecurity*, was arranged, and his work became a keystone in the new field of mathematical international relations. By the 1970s, the model had been tested on dozens of different arms races in hundreds of variations.

And the Richardson model worked. Not perfectly, by any means. God gave the easy problems to the physicists, as Charles Lave and

James March point out; political scientists have to deal with the messiness of human behavior. But the model works well for short-term predictions and, more important, no other self-contained model works better. From the European confrontation between NATO and the Warsaw Pact, to the massive arms races of the countries in the Middle East, to the tragic 30-year war in Southeast Asia, the Richardson arms-race model captures the basic characteristics of the arms race. And over the years,

another feature of the model came to light.

Arms-Race Stability and War

An important characteristic of the Richardson model is stability. Experimenting with the model, you will find that it usually produces one of two forms. These are illustrated in figures 1 and 2. Figure 1 gives the total defense expenditures of NATO and the Warsaw Pact. It is a stable arms race—arms levels converge on two values, an equilibrium, and stay there. If the arms levels are moved from the equilibrium, as they were during the Vietnam War period for NATO, they will return to it after the disturbance is removed.

Figure 2 illustrates the observed and predicted values of one nation in an unstable arms race—Iran, which reacts unstably to Iraq. In an unstable race, once arms levels start increasing, they continue increasing indefinitely. In the model, they go to infinity—or to the point at which the computer crashes with an overflow error. In the real world, war would usually intervene first.

War was Richardson's interest in the beginning. The arms-race model has proven to be a good predictor of war since almost all modern wars are preceded by unstable arms races. Richardson postulated this in his original work, and it has been verified in more systematic studies.

In the late 1970s, Michael Wallace of the University of British Columbia found that arms-race instability correlated strongly with war. Using a somewhat more complicated definition of an arms race than Richardson, but one based on Richardson's models, Wallace found that in 28 serious international disputes involving an arms race during the 1816-1965 period, 23 resulted in war. In 71 disputes where no arms race was involved, only 3 resulted in war.

Iran and Iraq:

A Prediction Comes True

Another example will further illustrate this point. In 1976, W. Ladd Hollist, then at Northwestern University, studied four arms races using the Richardson model and defense expen-

Ain't that a peach!



\$649

Single Board Computer Only

The Data-Neve Model 8064 is a complete general purpose single board Z80A based computer running under the CP/M 2.2 Operating System. Features include 64K 200nS RAM with parity check, 2 serial and 2 parallel ports, bootstrap ROM, high speed floppy disk controller, and expansion bus for attaching our hard disk interface option. Nearly one thousand 8064's have been delivered over the past year. This one works and is generally available from stock!

See it, try it and buy it at our sales and service locations below.

\$2,395

Full Computer with Dual 8" Drives

The Model 8864 is the system packaged version of the 8064 single board computer including full size dual 8" drives with total capacity of 1.2 MB, and powered by a very efficient switching power supply. The total power dissipation is so low, no fan is required. Double-sided drives providing total storage capacity of 2.4 MB are available in Model 8964 at \$2,995. CP/M 2.2 on 8" diskette, \$150.

Data-Neve is part of a 500 people, \$30 million world-wide group.

CP/M-Trademark of Digital Research
Prices are subject to change.
Sales taxes are added in Connecticut,
California, Tennessee
and Ontario (Canada).

Data-Neve

A Division of Rupert Neve Incorporated



For Mail Delivery
Call (203) 744-6230

Headquarters: Berkshire Industrial Park, Bethel, Connecticut 06801 Tel: (203) 744-6230 Telex: 969638

West Coast: 7533 Sunset Blvd., Hollywood, California 90046 Tel: (213) 874-8124 Telex: 194942

Nashville: P.O. Box 120907, Nashville, Tennessee 37212 Tel: (615) 385-2090

Canada: Rupert Neve of Canada, Ltd. 2721 Rena Road, Malton, Ontario L4T 3K1, Canada Tel: (416) 677-6611 Telex: 983502

Europe: Neve Electronics International, Ltd. Cambridge House, Melbourn, Royston, Hertfordshire, SG8 6AU England Tel: (0763) 60776

diture data from the Stockholm International Peace Research Institute *Yearbooks*, a standard source for such figures. The arms races involved the United States and Russia, India and Pakistan, Iran and Iraq, and Israel and Egypt, covering the period 1948-1973. Of the four cases, all but the United States/Russia race were unstable. That presented something of a problem. India/Pakistan and Israel/Egypt were unstable, and had resulted in war, as Richardson predicted. United States/Russia was stable, and had not resulted in war, also as predicted. The Iran/Iraq arms race was unstable and should have resulted in war, but did not—until 1980. Four years after Hollist's article, the long-simmering dispute between Iran and Iraq finally erupted into war. The Iran/Iraq arms race had been stable until the late 1960s, only becoming unstable in the 1970s, further narrowing the prediction of when war might occur.

In short, the Richardson model,

forgotten for decades, has become one of the most widely studied models in political science. Its short-term accuracy is relatively high—figure 2 provides one demonstration of this in a relatively difficult arms race, achieving an accuracy of roughly plus or minus 15 percent. The predictions for the stable NATO/Warsaw Pact race are even better—plus or minus 3 percent.

The Richardson model is not, of course, a flawless crystal ball for predicting international conflict. Several limitations must be kept in mind when using the model. For starters, the coefficients of the model may change as governments and political climates change. Therefore, the model is only accurate for a few years. Unstable arms races can often be detected only a couple of years before a war breaks out, by which time it is normally too late to do anything about them. While arms races increase the likelihood that a serious international dispute will escalate to

war, predicting when those disputes will occur is a more difficult problem. Finally, in Richardson's scheme, the threat and economic burden coefficients should be positive. In practice, however, they often are not, and may take on ridiculous values. This is due in part to a statistical problem called multicollinearity, wherein it is very difficult to sort out the effects of data points that are moving in similar directions. In such situations, the predictions of the model are accurate, but interpreting the parameters is difficult.

Other Applications

The Richardson arms-race model was developed for a very specific international problem that most people are unlikely to encounter unless they do political risk analysis. The "Richardson process," however, may be applied more generally. In many social, political, and economic situations, two opposing parties are driven to increase some behavior by mutual

ADVENT PRODUCTS, INC.

965 N. MAIN ST. ORANGE, CA 92667 (714) 997-0800

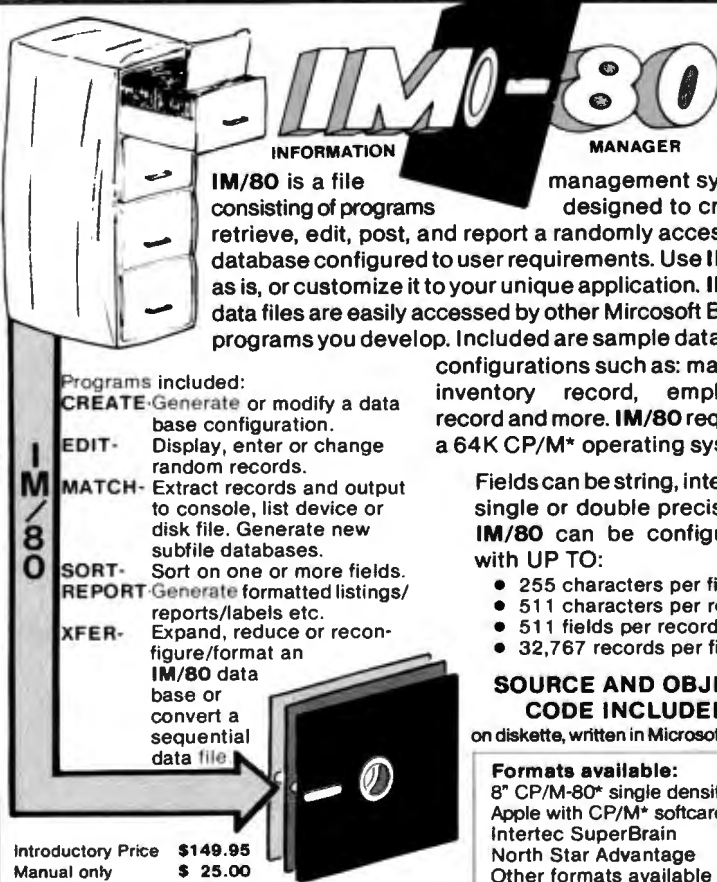

IM-80
INFORMATION MANAGER

IM/80 is a file management system consisting of programs designed to create, retrieve, edit, post, and report a randomly accessible database configured to user requirements. Use IM/80 as is, or customize it to your unique application. IM/80 data files are easily accessed by other Microsoft BASIC programs you develop. Included are sample database configurations such as: mail list, inventory record, employee record and more. IM/80 requires a 64K CP/M* operating system.

Fields can be string, integer, single or double precision. IM/80 can be configured with UP TO:

- 255 characters per field
- 511 characters per record
- 511 fields per record
- 32,767 records per file

SOURCE AND OBJECT CODE INCLUDED
on diskette, written in Microsoft BASIC

Formats available:

8" CP/M-80* single density	NEC
Apple with CP/M* softcard	Osborne
Intertec SuperBrain	TRS-80 Mod 2 with CP/M*
North Star Advantage	XEROX 820
Other formats available soon.	

Programs included:

- CREATE:** Generate or modify a database configuration.
- EDIT:** Display, enter or change random records.
- MATCH:** Extract records and output to console, list device or disk file. Generate new subfile databases.
- SORT:** Sort on one or more fields.
- REPORT:** Generate formatted listings/reports/labels etc.
- XFER:** Expand, reduce or reconfigure/format an IM/80 data base or convert a sequential data file

Introductory Price **\$149.95**
Manual only **\$ 25.00**

UP-8 EPROM PROGRAMMER

The Price/Performance Leader

- **COMPATIBLE WITH Z80/8080/85 CP/M* DISK BASED COMPUTERS**, eprom data stored on disk for easy, low cost storage and retrieval.
 - **STANDARD RS-232 SERIAL INTERFACE**, selectable 1200 to 9600 baud.
 - **COMPLETE USER ORIENTED SOFTWARE & DOCUMENTATION INCLUDED**, 21 single keystroke commands including copy, verify and a complete editor. Octal or Hex entry & display supported.
 - **NO PERSONALITY MODULES REQUIRED.**
 - **PROGRAMS ALL POPULAR 24 & 28 PIN EPROMS**, single or triple supply voltage, including 2704/08, TMS2716, 2716/32/64, 2732A, 2532, 68732/64 (and the new 27128 on request).
- *CP/M Digital Research trademark

Formats available:

8" CP/M-80* single density	NEC
Apple with CP/M* softcard	Osborne
Intertec SuperBrain	TRS-80 Mod 2 with CP/M*
North Star Advantage	XEROX 820
Other formats available soon.	

\$695.00 DEALER INQUIRIES INVITED

People can be trained to know how computers work. But we've trained QDP to know how people work.

QDP COMPUTER SYSTEMS

SYSTEM UTILITIES

CP - COPY PROGRAM
 CO - RECONFIGURE SYSTEM
 ST - SYSTEM STATUS REPORT
 MM - MAP OF MEMORY USE
 ID - INITIALIZE DISKETTE

BUSINESS APPLICATIONS

AR - ACCOUNTS RECEIVABLE
 AP - ACCOUNTS PAYABLE
 PR - PAYROLL
 IN - INVENTORY
 GL - GENERAL LEDGER

WORD PROCESSING

WP - WORD PROCESSOR
 SP - SPELLING DICTIONARY
 MP - MAILING PROGRAM

UTILITIES & MENUES

HE - HELP PROGRAM
 TT - SET DATE & TIME
 BH - BACKUP HARD DISK
 RH - RESTORE HARD DISK
 CM - COMMUNICATIONS
 M2 - MENU 2

FINANCIAL MENU

FM - FINANCIAL MODELING

Enter Selection :



QDP 100H
 10 MB (Formatted)
 HARD DISK



QDP 100
 2.4 MB (Formatted)
 FLOPPY

Introducing QDP's "user-friendly" computer system.

And other new QDP simplicities that make QDP easiest to sell, install, and use.

Simply pressing one key will start the user off right with QDP. Up comes a user-friendly menu (now standard on all QDP computers) and even untrained operators have access to the full power of QDP to do whatever job they select. Users never have to see QDP's operating system.

If help is needed to understand a QDP program or system function, QDP has an on-line "HELP" system. Ask for help, and QDP delivers definitions, examples, documentation and explanations. New items? Add them to QDP's user-library function.

Our software warns users of many impending problems before they happen. A built-in SYSTEM STATUS program monitors performance of the electronics and drive systems. This way QDP helps

assure a profit-generating reliable system that has all these features as standard equipment:

- One-year, on-site warranty service performed by the Installation & Service Engineering Division of General Electric Company—with more than 50 service locations nationwide.
- Proprietary "caché memory" system which makes QDP one of the fastest microcomputers available today.
- Unique system configuration program that allows users to easily modify operating system parameters via a menu-driven program.
- Best user-friendly implementation of a CP/M compatible operating system on the market — competitors, after two years, are finally trying to catch up.

- Z80 (4-6 MHz), IEEE 696 (S-100) — CP/M, MP/M compatible operating system.

- CBASIC language.

- Excellent user documentation and reference manuals.

And these options:

- Multi-user timesharing systems.
 - Hard Disk sub systems.
 - Memory disk to allow from 64K to 2MB of silicon memory to be accessed as a disk drive for extremely fast disk operations.
 - Software Languages: COBOL, FORTRAN, C, PASCAL, and Microsoft BASIC.
 - 16 bit version available this fall.
- Write or call for complete information.

CBASIC, CP/M and MP/M are registered trademarks of Digital Research Corp.
 Z80 is a registered trademark of Zilog Corp.

Circle 320 on inquiry card.



Quasar Data Products

10330 Brecksville Road, Cleveland, Ohio 44141
 216/526-0838 Telex 241596

MICROMAIL OFFERS THE LOWEST PRICES AND PERSONAL SERVICE.

LETTER QUALITY PRINTERS

DIABLO

• 630 RO
\$1949.00
• 630 KSR... CALL
• 620 CALL
• 1640 CALL

QUME

"ON-SITE WARRANTY"
• SPRINT 9/45
\$1949.00
• SPRINT 9/35
CALL FOR PRICE

NEC

• 7700 SERIES
• 3500 SERIES
**CALL FOR OUR
LOW PRICES**

★ NEW ★ DEC LA 100

DUAL MODE
MATRIX PRINTER
CALL FOR PRICE!

★ NEW ★ 3M

WHISPER WRITER
• TWX • TIME SHARE
• COMPUTER TERMINAL

DEC

LA 34 DA \$899.00
DEC LA 120KSR..... \$2049.00
VT 100 \$1449.00
VT101 CALL
VT131 \$1499.00

TELEVIDEO

910 \$569.00
912 \$689.00
920 \$725.00
950 \$939.00
925 **NEW!** CALL

ANADEX

DP 9500/9501 \$1149.00
DP 8000AP \$749.00
DP 9620A **NEW!**
6000 **NEW!** CALL

TEXAS INSTRUMENTS

810/2 \$1299.00
(includes upper/lower case option)
810/2 VFC/CP \$1499.00
(includes u/l case, forms
control & compressed print)

"PORTABLES SPECIAL"

T.I. 745 \$1399.00
T.I. 743KSR \$849.00
TELETYPE 43 (TTL) \$999.00

LABOR SAVER!

• CUT SHEET FEEDERS
**CALL FOR OUR
SPECIAL PRICES**

CALL TOLL FREE (800) 854-6028

SAVE ON
PREPAID
ORDERS

MASTERCARD
VISA
ACCEPTED

C.O.D.
REQUIRES
15% DEPOSIT

SHIPPING IS
FREIGHT
COLLECT

WE SELL INTERNATIONALLY

MICROMAIL

P.O. Box 3297
Santa Ana, CA 92703
Phone: 714/731-4334
TWX: 910 595 1146

threat, but are constrained from further increases by economic factors or other consequences. Some examples of this, ranging from the trivial to the potentially useful, follow:

- Two tennis players are competing fiercely to become the champion of the Swinging Singles Apartment Complex. Each realizes that additional practice time will improve his game. The more one practices, the more the other will practice. But the practice time of each is constrained by the fact that practicing tennis detracts from the remainder of his social life, which the status as tennis champion was supposed to improve.

- Two gas stations are engaged in a price war. The prices are going down, rather than up, but the pattern is the same. Each station feels compelled to decrease prices to match the price decreases of its competitor, but is constrained by the necessity of maintaining a profit margin.

- Two Silicon Valley firms are attempting to hire each other's programmers by offering higher salaries and benefits. As each raises salaries, the other must match the raise or lose valuable employees. Both, however, are constrained by the need to maintain some level of profits and investment. Much as we programmers would like this race to be unstable, it will either level out at an equilibrium or the two firms will go bankrupt.

- The Democratic and Republican parties compete every four years in the presidential campaign. William Linehan, a political scientist at the State University of New York at Stony Brook, has pointed out that until campaign expenditure controls were passed, each successive election saw higher levels of spending by each side, based in part on projections based on previous spending by the other party, and constrained by the difficulties in raising money. This pattern should follow a Richardson model.

- Two firms are trying to acquire a company by bidding competitively for its stock. Each bid by one firm must be met by the other, but both are constrained by the total amount available for acquisition. More gen-

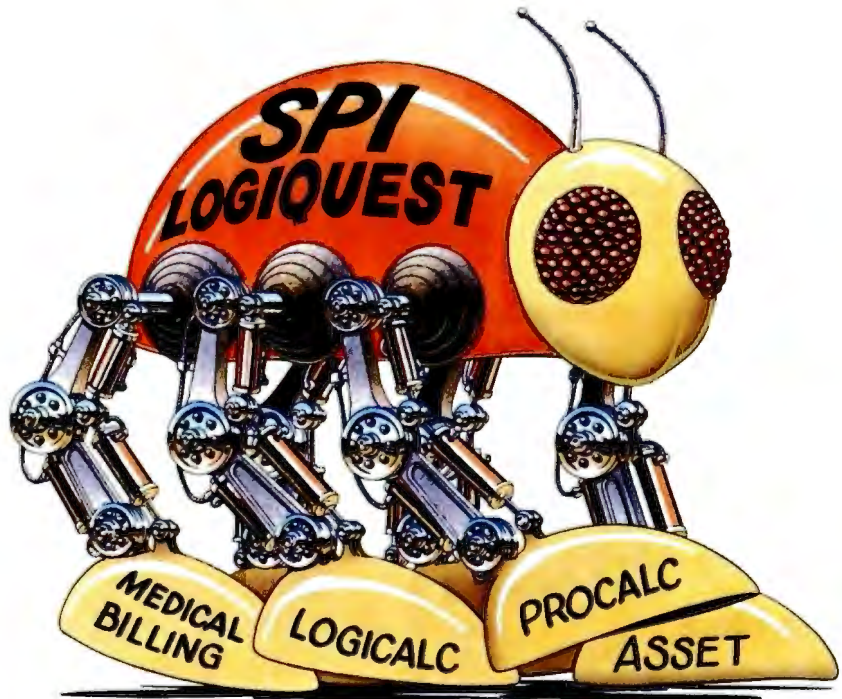

SPI ANNOUNCES THE GOOD SOFTWARE "BUG": SPIDER™

Not all software bugs are bad.

In fact, there's one that can actually make your system a lot more capable, while saving you plenty of time and work in the process.

Spider, from SPI.

Its body is the powerful, SPI Data Base Management System, LogiQuest.

Its extremities are individual, specialized SPI programs in Pascal.

And its legs are communication links that make the programs totally interactive with the DBMS and each other.

That way, you only have to enter information once in order for it to be utilized by several different programs. Operator intervention is greatly reduced.

What's more, LogiQuest has both single and multi-user capabilities.

And since it's a true, relational database, non-programmers can generate useful reports and documents with relative ease. Also, modifying or developing

your own applications programs is significantly easier and faster.

Professional quality Pascal programs from SPI for use with the LogiQuest DBMS include General Ledger, Accounts Receivable, Accounts Payable, Inventory Control, Order Entry, Asset (featuring all of the above programs), ProCalc, LogiCalc, Medical Billing, and Clothing Store Management.

For complete details, bug us today. 10343 Roselle Street, Suite A, San Diego, CA 92121, 714/450-1526.



**SOFTWARE PRODUCTS INTERNATIONAL
MARKETING**

Now operating on these Systems and Hardware: UCSD-p, UNIX, CP/M, IBM, DEC, TRS-80II, Apple II & III, Commodore, NEC, Corvus, Philips, Altos and many more.

Circle 359 on inquiry card.

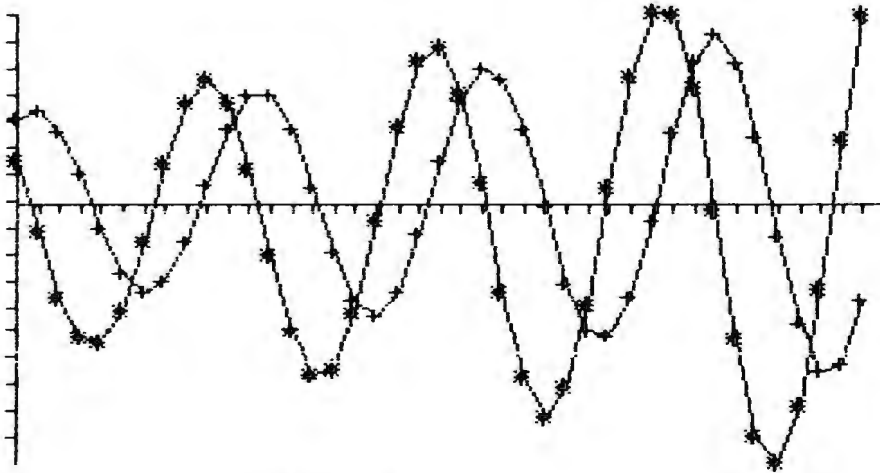

PLOT FOR SIMULATED, *=X, +=Y

Figure 3: A plot of the arms levels in a hypothetical arms race in which the Richardson model predicts cyclical behavior.

erally, most competitive bidding situations are candidates for following a Richardson model in the short run.

These examples should suffice to make the point. The Richardson

model will not fit perfectly—in some instances it may not fit at all—but in some situations it may provide insight into the underlying process. Furthermore, the issue of stability could prove important—it could, for exam-

ple, predict whether bidding on a stock price will continue to very high levels, or whether it will level out at an equilibrium, and give the value of that equilibrium. In some situations, the Richardson model generates cyclical behavior, as illustrated in figure 3. It has been suggested that Richardson-like processes may account for some of the apparently cyclical behavior observed in political and economic processes.

The Richardson model has not been extensively explored in these other applications—I present them only as cases in which the model might apply. But just as the obscure work of a quiet British meteorologist in 1918 can be used to predict the wars of our time, so might that same model have applications outside the field of international relations.

The RICHDEMO Program

RICHDEMO is a Pascal program for demonstrating the characteristics of the Richardson model. Listing 1

Bare Bones **APPLE II**

w/o Keyboard
\$450. 48k RAM
w/o Pwr. Supply

Microswitch: \$95.00
Power Supply: \$124.00
Keyboard / Pad: \$18.00

Apple: APPLE Reference Manl.

COMPUTERS

ATARI 800™ COMPUTER SYSTEM

400 w/16K \$350.00
800 w/16K \$699.00
*800 Computer w/48K
★ BEST BUY ★ **\$825.00**

ATARI PERIPHERALS:

Printer 825 - 650.00
Disk Dr 810 - 485.00
Record 410 - 82.00
Paddle (pr) > 16.95
Joystick (pr) > 16.95
32k RAM - 179.95
Basic Cart - 49.00

Asteroids
Missile Com -> 32.50
Sup. Brk Out
Assam Edit - 49.00
Star Readers - 45.00
Basketball - 28.00
Chess - 32.00

COMPONENTS

74LS SERIES			
74LS00	24	74LS83	70
74LS02	24	74LS86	38
74LS03	24	74LS90	60
74LS04	24	74LS91	85
74LS05	24	74LS92	85
74LS06	30	74LS93	60
74LS08	28	74LS95	80
74LS10	24	74LS107	38
74LS11	33	74LS109	38
74LS12	33	74LS112	40
74LS13	45	74LS113	40
74LS14	89	74LS114	45
74LS20	24	74LS122	40
74LS21	24	74LS123	85
74LS26	30	74LS125	90
74LS27	28	74LS128	85
74LS28	32	74LS132	70
74LS30	24	74LS136	50
74LS32	32	74LS138	65
74LS37	50	74LS139	65
74LS38	32	74LS145	110
74LS42	50	74LS151	70
74LS48	70	74LS153	70
74LS51	24	74LS157	70
74LS55	35	74LS158	70
74LS74	45	74LS161	85
74LS76	38	74LS162	85
74LS78	50	74LS163	85
		74LS164	85

7400 SERIES			
7400	18	7454	19
7402	18	7470	30
7406	1	7474	50
7408	23	7475	40
7409	18	7476	30
7410	18	7490	35
7411	22	7481	100
7412	28	7489	35
7413	32	7490	30
7414	32	7490	35
7416	24	7492	45
7417	24	7494	60
7420	18	7495	50
7421	30	74100	30
7425	25	74107	35
7427	25	74122	40
7430	18	74125	40
7432	25	74144	25
7436	25	74145	25
7440	18	74148	100
7442	45	74154	100
7443	60	74157	45
7445	60	74158	80
7446	60	74161	80
7447	60	74166	90
7448	60	74174	80
7449	15	74175	100
7451	18	74393	100
7453	19		

DYNAMIC RAMS			
4027	200ns	2.00	8/1.75
4118	200ns	9.50	8/13.00
4164	200ns	9.50	

STATIC RAMS			
2111	2.85	8/2.50	
2112	2.85	8/2.50	
2114	2.00	4/1.00	
2114L	2.25	4/2.00	
HM6116	200ns	11.50	4/10.50

MISC			
8128	120		
8128	120		
8008	275		
8008A	375	8212	1.95
8155	1050	8216	1.80
8255	4.50	1103A	95
MC1300	1.80	UPD765	19.85
MC1300	1.15	AY5 1013A	3.00
MC1358	1.50	1488	95
MC1458	55	1489	95
LM380	1.10	MC6802	14.95
LM380	1.40	MC6821P	4.95
LM566	95	MC6850P	4.50
LM741	25		
LM1310	2.80		
LM1800	2.85		
LM1889	1.45		

MORE MISC			
1702	4.25	8/3.95	
2708	2.95	8/2.65	
2715 (SV)	5.00	8/4.50	
TM52716	8.95	8/8.00	
2732 (SV)	10.50	8/9.75	
TM52532	11.50	8/10.25	

E PROMS			
81			
10/5 30	6	10/1 20	
10/5 70	18	10/1 60	
10/5 90	18	10/1 80	
10/5 120	20	10/1 100	
10/2 70	22	10/2 70	
10/3 70	24	10/2 70	
10/4 70	28	10/2 70	
10/4 90	40	10/2 90	
10/4 120	48	10/2 120	

VOLTAGE REGULATORS			
7808			
7808			
7812			
7815			
7818			
7808			
7812			
7815			
7818			

CPU'S			
Z80	8.50		
Z80A	6.00		
Z80A PRO	6.00		
6502	6.00		
6502A	12.00		
8085A	6.50		
MC6800	7.75		

I.C. SOCKETS			
81			
10/5 30	6	10/1 20	
10/5 70	18	10/1 60	
10/5 90	18	10/1 80	
10/5 120	20	10/1 100	
10/2 70	22	10/2 70	
10/3 70	24	10/2 70	
10/4 70	28	10/2 70	
10/4 90	40	10/2 90	
10/4 120	48	10/2 120	

REAL-TIME CLOCK CALENDAR (MSM 5832)

Direction: Mono Metal Gate CMOS I.C.
Features:
Time Month Date Year & Day of Week
Bus Oriented
1 Bit Data Bus
1 Bit Address
R/W Hold Select
Inter Signal
32 768KHz stat Control
5v Pow Sup
Low Power Dissipation

\$7.45 XTAL
8/SPEC1
\$2.85

* MONITORS *

ZENITH 1: 1 Green Phos 12in 15MHz Hi-Res -> **\$118.50**

J.C.S 2: 2 Green Phos 12in 18MHz Hi-Res -> **\$155.50**

AMDEK 3: 3 Green Phos 12in 12MHz Screen -> **\$165.50**

13in Color 3a: 3a Lo-Res -> **\$375.50**

CONCORD COMPUTER PRODUCTS

1971 SO STATE COLLEGE ANAHEIM CALIF 92806
(714) 937-0637
MasterCard NO COD
10 MIN ORDER L.A. RES. ADD 6% FR

NO P.O. BOX SHIP

DISKETTE SALE!!

'WABASH'

5 1/4 8inch
SS/SD \$25.00 \$25.00
SS/DD 27.40 30.40
DS/DD 32.40 37.40

Box of 10 pcs
QTY. PRICE AVAIL

82 I.C. MASTER

\$59.95

GLOBAL LPK-1:
Logic Probe Kit - complete nothing extra to buy Min. pulse width 300nsec
\$18.95

'Apple™
Heath™
IBM
North Star™
TRS-80 (I, II, III)
S-50 S-100
TI
Zenith

DISK DRIVES

Contact your nearest authorized
Traxx® dealer

Central Kansas Computers
Herrington, KS (913) 258-2575

CMD Performance
Windsor, CT (203) 688-3862

Connection 80
Vancouver, WA (206) 573-0319

Cottage Software
Wichita, KA (316) 683-4811

Dataflow Systems
Indianapolis, IN (317) 888-3640

Everett Computer Center
Everett, WA (206) 259-0024

H & S Microsystems
Burnaby, BC Canada (604) 430-4145

Insync Systems Corp.
Alvin, TX (713) 331-2024

Meta Technologies
Euclid, Ohio 1-800-321-3552

Mitronix Computer Corp.
Richmond, ME (207) 737-4447

Web Products, Inc. Software Div.
Carol Stream, IL (312) 653-5229

TRAXX
COMPUTER CORPORATION

Dealer Inquiries

1-800-621-3102
(312) 987-1024
Telex-724389
Telespan SKO
Attention: Traxx

Circle 386 on Inquiry card.



TRAXX

WE PROVIDE THE CONNECTION

And your Commodore PET/CBM, HP-85, or Osborne-1 does the rest—with our serial interfaces, of course. Since 1978 we've led the way, connecting RS-232 devices to IEEE-488 computers.

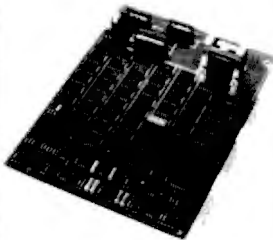

With our products, you can interface your computer to printers, modems, CRT terminals, plotters—even other computers. Write us today for details on TNW's output-only Model 1000, our input/output Model 2000, and our 2-channel TNW-232D.

Auto-answer/auto-dial 103 Modem and data communications software for the PET/CBM also available.



Units complete with cabinet, documentation, one-year warranty.



Details from George Masters:



Dept. B, 3444 Hancock St.,
San Diego, CA 92110
(714) 296-2115
TWX 910-335-1194
VISA/MasterCard
Dealer Inquiries Welcome.

presents RICHDEMO in its entirety. Written and tested on an Apple II, RICHDEMO should work with little or no modification on any UCSD Pascal system. It is designed for either classroom demonstrations or experimentation with the properties of the model. The program contains three modules, which are called by typing the first letter of the module's name.

E)STIMATE

The E)STIMATE module estimates the parameters of the model from a set of data. You can enter data from a text file or from the keyboard.

Creating the text files (via the Pascal Editor) is advisable for anything but the most cursory use of the program.

You enter data in this order: the two nations' names, the number of data points, and the data points themselves. Enter two values—the arms levels of nations X and Y—for each year, separating the values with a blank. Due to memory constraints, you can enter a maximum of 50 points, though you may be able to enlarge this slightly. The program provides prompts for keyboard entry.

The data is entered from the file in the same order as from the keyboard,

Text continued on page 128

Listing 1: RICHDEMO, a Pascal program that demonstrates the Richardson arms-race model. The E)STIMATE module takes a set of data and estimates the parameters of the model. The C)HANGE PARAMETERS module lets the user experiment with the model's behavior. The P)LOT module draws plots like those in figures 1, 2, and 3.

```
PROGRAM RICHDEMO;
(* PROGRAM FOR ESTIMATING AND DEMONSTRATING
THE RICHARDSON ARMS RACE MODEL

PHILIP A. SCHRODT, NORTHWESTERN UNIVERSITY
MARCH, 1982

*)
(**$+ *) (* PUT COMPILER INTO SWAPPING MODE *)

USES TURTLEGRAPHICS, TRANSCEND;

CONST MAXNY=50; (* SIZE OF DATAVECT'S -- CONSTRAINED BY MEMAVAIL... *)

TYPE DATAVECT=ARRAY[0..MAXNY] OF REAL;
MATRIX=ARRAY[1..2, 1..2] OF REAL;
VECT2=ARRAY[1..2] OF REAL;

VAR VMIN, HMIN, HHI, HLO, VHI, VLO, HDIM, VDIM, NY, FA, FB, KC: INTEGER;
XO, YO, RK, RM, RA, RB, RG, RH: REAL;
MAXVAL, PR, ABER, VSCL, HSCL, RR, G: REAL;
SE, DET, XN, YS, YSA: REAL;
YS1, YS2, YP1, YP2, Y1, Y2, X1, X2: DATAVECT;
VV, XS, B, SB: VECT2;
NATNAM: ARRAY[1..2] OF STRING;
INF: TEXT;
S: STRING;
CH: CHAR;
XM: MATRIX;
AUTOSCALE: BOOLEAN;

PROCEDURE ESTIMATE; FORWARD;

PROCEDURE CLEARSCREEN; (* BLANKS OUT SCREEN *)
BEGIN WRITE(CHR(12)); END;

(* ***** PROCEDURES FOR E)STIMATE ***** *)

FUNCTION COVAR(XA, X1, X2, N: REAL): REAL;
(* COMPUTES VARIANCE OR COVARIANCE *)
BEGIN COVAR:=(XA - (X1*X2/N))/N; END;

PROCEDURE SOLVL2(VAR R: VECT2; XM: MATRIX; Y: VECT2);
(* SOLVES SET OF TWO LINEAR EQUATIONS *)
VAR DET: REAL;
BEGIN DET:=XM[1, 1]*XM[2, 2] - (XM[1, 2]*XM[2, 1]);
IF DET<>0.0 THEN BEGIN
R[1]:=(Y[1]*XM[2, 2] - (XM[2, 1]*Y[2]))/DET;
R[2]:=((Y[2]*XM[1, 1] - (XM[1, 2]*Y[1]))/DET; END
ELSE BEGIN
R[1]:=0.0; R[2]:=0.0;
WRITELN('ZERO DETERMINANT IN SOLVL2; R SET TO ZERO '); END;
END;

PROCEDURE COMPVAR;
(* COMPUTE COVARIANCES *)
BEGIN YSA:=COVAR(YSA, YS, YS, XN);
YV[1]:=COVAR(YV[1], YS, XSE[1], XN);
YV[2]:=COVAR(YV[2], YS, XSE[2], XN);
```

Listing 1 continued on page 122

ALL MATTER IS MODULAR. YOUR PRINTER SHOULD BE, TOO.



Introducing the Prism Printer™ from Integral Data Systems, the first truly modular, field-upgradeable dot matrix printer. Now your printer can be as flexible as the rest of your system.

Start with the basic printer which features text-quality printing; then add the performance options you need — when you need them. Add the automatic cut sheet feeder for word processing. Install the Sprint Mode™ for high-speed data output. For communicating information and ideas faster, nothing is more effective than the Dot Plot™ graphic option and Prism Color™ option — this gives you high-quality, multi-color output in text, graphs and charts. And that's just the beginning. More Prism option modules will be available soon.

If you're an APPLE™, IBM™ or other professional microcomputer user, Prism Printer is the key to your system solution. At last, the chemistry is right between you and your printer. You'll never pay too much or get too little again. The Prism Printer from Integral Data Systems.

For the name of your nearest Integral Data Systems Dealer, call toll free (800) 258-1386. In New Hampshire, Alaska and Hawaii, call (603) 673-9100.



Integral Data Systems, Inc.
Milford, NH 03055
Telex: 953032

APPLE is a registered trademark of Apple Corporation.
IBM is a registered trademark of International Business Machines Corporation.

**Compliment
your
Apple III®
or IBM...**



**simply
\$599⁰⁰**

- ✱ 13" RGB Color.
- ✱ 16 Colors on your Apple III® or IBM.
- ✱ Up to 80 Characters per line.
- ✱ 360 Dots per color. (horizontal resolution)
- ✱ Available for immediate shipment.

Other models available:

**12" Green Phosphor for IBM
(1200 lines resolution) \$199.00**

**12" Green Phosphor
(1200 lines resolution) \$179.00**

**12" Black & White
(15 Mhz) \$139.00**

Toll Free 1-800-258-6370



® Apple III is a registered trademark of Apple Computer.

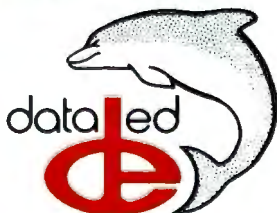

18 Bridge Street, Salem, NH 03079
Tel. (603) 893-2047
TWX: 710-366-0502

Listing 1 continued:

```

XMC1,1]:=COVAR(XMC1,1],XSC1],XSC1],XN);
XMC2,2]:=COVAR(XMC2,2],XSC2],XSC2],XN);
XMC1,2]:=COVAR(XMC1,2],XSC1],XSC2],XN);
XMC2,1]:=XMC1,2];END;

PROCEDURE LINREGRESS(Y,X1,X2:DATAVECT);
(* LEAST-SQUARES FIT OF Y WITH X1,X2 *)
BEGIN XN:=NY;YS:=0.0;YSA:=0.0;
(* DO ASSORTED SUMS OF SQUARES *)
FOR KA:=1 TO 2 DO BEGIN XS[KA]:=0.0;YV[KA]:=0.0;
FOR KB:=1 TO 2 DO XM[KA,KB]:=0.0;END;
FOR KC:=1 TO NY DO BEGIN (* MAIN SUMMING LOOP *)
YS:=YS+Y[KC];YSA:=YSA+SQR(Y[KC]);
XSC1]:=XSC1]+X1[KC];XSC2]:=XSC2]+X2[KC];
XMC1,1]:=XMC1,1]+ SQR(X1[KC]);
XMC2,2]:=XMC2,2]+ SQR(X2[KC]);
XMC1,2]:=XMC1,2]+ X1[KC]*X2[KC];
YVC1]:=YVC1]+Y[KC]*X1[KC];
YVC2]:=YVC2]+Y[KC]*X2[KC]; END;
(* SOLVE FOR COEFFICIENTS *)
COMPAR;
SOLVL2(B,XM,YV);
G:=(YS - B[1]*XSC1] - B[2]*XSC2])/XN;
(* COMPUTE R-SQUARE, AVE % ERROR, STANDARD ERRORS *)
SE:=0.0;ABER:=0.0;
FOR KC:=1 TO NY DO BEGIN
PR:=Y[KC]-B[1]*X1[KC] - B[2]*X2[KC] - G;
IF Y[KC]>0.0 THEN ABER:=ABER+ABS(PR/Y[KC]);
SE:=SE + SQR(PR);END;
ABER:=ABER/XN; RR:=1.0 - (SE/(XN*YSA));
DET:=XN*(XMC1,1]*XMC2,2] - (XMC1,2]*XMC2,1]);
SB[1]:=SORT((SE/(XN-2.0))*XMC2,2]/DET);
SB[2]:=SQRT((SE/(XN-2.0))*XMC1,1]/DET);
END;

PROCEDURE PREDICT(VAR YP:DATAVECT;X1,X2:DATAVECT;B1,B2,A:REAL);
(* PREDICTS YP FROM X1*B1 + X2*B2 + A *)
BEGIN YP[0]:=X2[1];
FOR KA:=1 TO NY DO YP[KA]:=B1*X1[KA] + B2*X2[KA] + A; END;

PROCEDURE CHECKNY;
(* CHECKS BOUNDS ON NY -- USED IN READDATA *)
BEGIN IF NY>MAXNY THEN BEGIN
WRITELN('Program can only handle ',MAXNY,' points ');
NY:=MAXNY;END;
IF NY<=0 THEN BEGIN WRITELN(' Negative? ' -- try again... <RETURN>');
READLN(S);EXIT(ESTIMATE);END;
END;

PROCEDURE READDATA;
(* READS IN DATA VECTORS *)
BEGIN CLEARSCREEN;

WRITE('Read data from a file? -- ');READ(CH);WRITELN;
IF (CH='Y') OR (CH='y') THEN BEGIN
WRITE('Enter TEXT file name ');READLN(S);S:=CONCAT(S,'.TEXT ');
RESET(INF,S);
READLN(INF,NATNAM[1]);READLN(INF,NATNAM[2]);
READLN(INF,NY);CHECKNY;
FOR KA:=1 TO NY DO READLN(INF,G,X1[KA],X2[KA]); END
ELSE BEGIN
FOR KA:=1 TO 2 DO BEGIN
WRITE('Enter name of nation ',KA,' -- ');
READLN(NATNAM[KA]);END;
WRITE('Enter number of data points-->');READLN(NY);
CHECKNY;
WRITELN('Enter two values for each year, separated by a blank');
FOR KA:=1 TO NY DO BEGIN
WRITE('Data for year ',KA:3,' -->');READLN(X1[KA],X2[KA]);END;
END;
(* MOVE DATA INTO Y1,Y2 *)
FOR KA:=1 TO NY-1 DO BEGIN
Y1[KA]:=X1[KA+1]; Y2[KA]:=X2[KA+1];END;
NY:=NY-1; X0:=X1[1];Y0:=X2[1];X1[0]:=X0;X2[0]:=Y0;
Y1[0]:=X0;Y2[0]:=Y0;
END;

PROCEDURE WRITEIGEN;
(* COMPUTES AND WRITES EIGENVALUES *)
VAR R,DISC,EA,EB:REAL;STABL:BOOLEAN;
BEGIN GOTOXY(0,17);
DISC:=(SQR(RA-RB) + 4.0*RM*RM)/4.0; R:=(RA+RB)/(-2.0);
IF DISC<0.0 THEN
BEGIN DISC:=SQRT(-DISC);
WRITELN('EIGENVALUES COMPLEX:REAL PART=',R:8:4);
WRITELN(' COMPLEX PART=',DISC:8:4 );
WRITELN('MODEL IS OSCILLATING');
END
ELSE BEGIN DISC:=SQRT(DISC);EA:=R+DISC;EB:=R-DISC;
STABL:=((ABS(EA)<1.0) AND (ABS(EB)<1.0));
WRITELN('EIGENVALUES : ',EA:10:5,' ');
WRITELN(' ',EB:10:5,' ');

```

Listing 1 continued on page 124

CASH FLOW PROBLEMS?



IT'S NICE TO KNOW SOMEONE WHO HAS THE SOLUTION.



MicroAge is your Solution Store . . . that means at MicroAge Computer Stores we have a wide selection of time-saving computerized business systems designed specifically to solve the daily cash flow problems every businessman faces.

MicroAge has computerized business systems that quickly and affordably allow you to regain control of your critical accounts receivable . . . at last making it possible for you to carry out effective collection procedures on a consistent basis. MicroAge has accounts receivable program packages to automatically display and update account information; prepare trial balance including a balance-due and delinquency aging

report, and take care of dozens of other tasks that eat into your time and profit!

Computerized business systems from the MicroAge Computer Store are available in the \$5,000 to \$15,000 range, to suit the individual budget of your small business or professional practice. MicroAge backs up every system with personalized service, warranty service and repair, installation, systems consulting, even customer training. Visit the MicroAge Computer Store in your area soon with your business problems, and let us help you with the solution.

MicroAge
COMPUTER STORE

"The Solution Store" SM

VISIT THE STORE IN YOUR AREA:

El Paso, Texas
(915) 591-3349

Tucson, Arizona
(602) 790-8959

Albuquerque, New Mexico
(505) 883-0955

Pleasant Hill, California
(415) 680-1489

Aurora, Colorado
(303) 696-6950

Rochester, New York
(716) 244-9000

Hurst, Texas
(817) 284-3413

Salina, Kansas
(913) 823-7596

Orland Park, Illinois
(312) 349-8080

Milwaukee, Wisconsin
(414) 257-1100

Mountain View, California
(415) 964-7063

Scottsdale, Arizona
(602) 941-8794

Anchorage, Alaska
(907) 279-6688

San Diego, California
(714) 278-0623

Richardson, Texas
(214) 234-5955

Minneapolis, Minnesota
(612) 338-1777

Omaha, Nebraska
(402) 339-7441

Phoenix, Arizona
(602) 265-0065

Columbus, Ohio
(614) 868-1550

Indianapolis, Indiana
(317) 849-5164

Portland, Oregon
(503) 256-4713

Norwalk, Connecticut
(203) 846-0851

St. Louis, Missouri
(314) 567-7644

Oklahoma City, Oklahoma
(405) 728-1837

Houston, Texas
(713) 440-7547

W. Palm Beach, Florida
(305) 683-5779

Toronto, Canada
(416) 487-5551

Houston, Texas
(713) 270-9647

Wilmington, Delaware
(302) 658-3664

Allentown, Pennsylvania
(215) 434-4301

FOR FRANCHISE OPPORTUNITY INFORMATION CALL (602) 968-3168

ERG/68000 MINI-SYSTEMS

- Full IEEE 696/S100
compatibility

HARDWARE OPTIONS

- 8MHz or 10 MHz 68000 CPU
- 4-8 RS232 Serial Ports
- 64K STATIC RAM (70 nsec)
- 256K Dynamic RAM, with full
parity
- 8" D/D, D/S floppy disk drives
- 5MB-32MB hard disk drives
- Full DMA host adaptor
- 20MB tape streamer
- 10 to 20 slot backplane
- 30 amp power supply

SOFTWARE OPTIONS

- 68KFOR¹ systems language
with MACRO assembler
- Fast Floating Point package
- Motorola's MACSBUG
- IDRIS² operating system with
C, PASCAL, FORTRAN 77,
68K-BASIC¹ compilers

Trademark 'ERG, Inc.
²Whitesmiths

**30 day delivery
with valid Purchase Order**

**OEM prices available
For CPU, Integrated Card Sets
or Systems.**



Empirical Research Group, Inc.
P.O. Box 1176
Milton, WA 98354
206-631-4855

Listing 1 continued:

```

WRITE('MODEL IS ');
IF STABL THEN WRITELN('STABLE ');
ELSE WRITELN('UNSTABLE ');
END;
END;

PROCEDURE WRITERES(S:STRING);
(* WRITES LEAST-SQUARES RESULTS *)
BEGIN WRITELN;WRITELN(' EQUATION FOR ',S);
WRITELN(' THREAT ECON BURDN GRIEVNC');
WRITELN('COEFF: ',BC[1]:10:5,' ',BC[2]:10:5,' ',G:10:5);
WRITELN('STD ERROR:',SB[1]:10:5,' ',SB[2]:10:5);
WRITELN('R-SQUARE: ',RR:10:5);
WRITELN('MEAN ABSOLUTE PERCENT ERROR:',ABER:10:5);
END;

PROCEDURE ESTIMATE;
(* DRIVING PROCEDURE FOR ESTIMATE *)
BEGIN READDATA; CLEARSCREEN;
WRITELN(' *** ESTIMATED COEFFICIENTS ***');
LINREGRESS(Y1,X2,X1); RA:=-B[2];RK:=B[1];RG:=G;WRITERES(NATNAM[1]);
LINREGRESS(Y2,X1,X2); RB:=-B[2];RM:=B[1];RH:=G;WRITERES(NATNAM[2]);
WRITEIGEN;
PREDICT(YP1,X1,X2,RA,RK,RG); PREDICT(YP2,X1,X2,RM,RB,RH);
GOTOXY(10,23);WRITE('<RETURN> TO MONITOR ');READLN(S);
END;

(* ***** PLOTTING ROUTINES ***** *)

PROCEDURE SCALE (YA,YB:DATAVECT);
(* FINDS SCALING FACTORS FOR PLOT *)
VAR MAX,MIN:REAL;
BEGIN MIN:=YA[1];MAX:=YA[1];
FOR KA:=0 TO NY DO BEGIN
IF YA[KA]<MIN THEN MIN:=YA[KA]; IF YB[KA]<MIN THEN MIN:=YB[KA];
IF YA[KA]>MAX THEN MAX:=YA[KA]; IF YB[KA]>MAX THEN MAX:=YB[KA];
VSCL:=(VDIM)/(MAX-MIN+1); VMIN:=TRUNC(MIN-1.0);
HSCL:=HDIM/(NY+1);HMIN:=0;
END;

(* FUNCTIONS FOR COMPUTING SCREEN COORDINATES FROM CURRENT SCALING *)
FUNCTION YCORD(Y:REAL):INTEGER;
BEGIN YCORD:=ROUND((Y-VMIN)*VSCL)+VLO;END;
FUNCTION XCORD(X:INTEGER):INTEGER;
BEGIN XCORD:=ROUND(((X-HMIN)*HSCL))+HLO;END;

PROCEDURE DRAWAXIS(NAT,LA,LB:STRING);
(* DRAWS THE X AND Y AXII (AXISES,WHATEVER...) *)
BEGIN (* Y-AXIS *)
INITTURTLE;GRAFMODE;
MOVE TO(HLO,VLO);PENCOLOR(WHITE);MOVETO(HLO,VHI);
TURNT(180); KA:=VLO+10;
REPEAT PENCOLOR(NONE);MOVETO(HLO,KA);PENCOLOR(WHITE);MOVE(3);
KA:=KA+10; UNTIL KA>VHI;
(* X-AXIS *)
KB:=YCORD(0.0); IF (KB>VHI) OR (KB<VLO) THEN KB:=VLO;
PENCOLOR(NONE);MOVETO(HLO,KB);PENCOLOR(WHITE);MOVETO(HHI,KB);
TURNT(270);
FOR KA:=0 TO NY DO BEGIN PENCOLOR(NONE);MOVETO(XCORD(KA),KB);
PENCOLOR(WHITE);MOVE(3);END;
PENCOLOR(NONE);MOVETO(0,0);
(* WRITE PLOT LABEL *)
S:=CONCAT('PLOT FOR ',NAT,' ',*=',LA,' '+=',LB);WSTRING(S);
END;

PROCEDURE PLOTCHAR(I:INTEGER);
(* PLOTS CHAR I CENTERED AT CURRENT TURTLE POSITION *)
VAR XP,YP:INTEGER;
BEGIN XP:=TURTLE X;YP:=TURTLE Y;PENCOLOR(NONE);TURNT(225);MOVE(5);
PENCOLOR(WHITE);WCHAR(CHR(I));PENCOLOR(NONE);
MOVETO(XP,YP);PENCOLOR(WHITE);END;

PROCEDURE PLOTDATA(Y:DATAVECT;IC:INTEGER);
(* PLOTS DATAVECT Y WITH CURRENT SCALING, LABELING WITH CHR(IC) *)
BEGIN
PENCOLOR(NONE);MOVETO(XCORD(0),YCORD(Y[0]));PLOTCHAR(IC);
PENCOLOR(WHITE);CHARTYPE(14);
FOR KA:=1 TO NY DO BEGIN MOVETO(XCORD(KA),YCORD(Y[KA]));PLOTCHAR(IC);END;
END;

PROCEDURE SIMULATE;
(* GENERATE SIMULATED VALUES USING CURRENT COEFFICIENTS *)
VAR TR:BOOLEAN;
BEGIN TR:=FALSE;
YS1[0]:=X0;YS2[0]:=Y0;
FOR KA:=1 TO NY DO BEGIN
YS1[KA]:=RK*YS2[KA-1]-RA*YS1[KA-1]+RG;
YS2[KA]:=RM*YS1[KA-1]-RB*YS2[KA-1]+RH;
IF ABS(YS1[KA])>MAXVAL THEN BEGIN TR:=TRUE;YS1[KA]:=MAXVAL;END;
IF ABS(YS2[KA])>MAXVAL THEN BEGIN TR:=TRUE;YS2[KA]:=MAXVAL;END;
END;
END;
    
```

Listing 1 continued on page 126

top shelf

Software for the IBM PC
and the Apple II



**With spoken instructions,
our tested software doesn't try your patience.**

EASY Every Alpha software package contains spoken instructions on cassette to guide you through the program on the disk. You get professional software that a novice can use.

PROVEN Our business software for the IBM PC has been used since 1979 on the Apple. Thousands of people agree that our versatile **Data Base Manager** and **Mailing List** programs are effective time- and money-saving devices.

INNOVATIVE **Question** is a fun game based on artificial intelligence. It tries to guess what city, person or animal you're thinking of, and gets smarter as you play. You can even teach it new topics.

Type Faces lets your dot matrix printer generate 15 different kinds of large lettering.

With **The Apple-IBM Connection**, you'll be able to transfer files from the Apple II to the IBM and vice versa. Your VisiCalc work can be transferred without retyping or errors. Requires no technical knowledge. The software does all the work for you.

Alpha software products available at participating **ComputerLands**.
Or call us for your nearest dealer: 617 229-2924

 **alpha**
SOFTWARE CORP

6 New England Executive Park • Burlington, Massachusetts 01803

Data Base Manager: \$185 Mailing List: \$95 Question: \$45 Type Faces: \$95 The Apple-IBM Connection: \$120

A0C4C9D3CBA0D5D4C9CCC9D4D9A0A4B5B0A0

Disk Utility for Apple DOS 3.3

LOST PROGRAM RECOVERY

If you haven't
written over that
program accidental-
ly deleted, this
software can re-
cover it for you.

Also, it can
reorganize your disk
and inform you of
the remaining
space available.

And, it allows
you to patch any
sector: display in
Hex and ASCII on
standard Apple
screen.

Menu driven and
easy for the novice
while still efficient
for the professional.
Compatible with
M & R Superterm.

For more information or
to place your order call:
(208) 263-1213

Cost: \$50

We pay first class postage and
insurance. You may use VISA or
Master Card.

TO ORDER: Send us your
check, money order or credit card
number and expiration date.
Certified checks avoid clearance
delay.

ANSWER Corporation
502A North Second Ave.
Sandpoint, Idaho 83864

A0A0C2D9A0CAC5D2D2D9A0D4C9C6C6D4A0A0

Listing 1 continued:

```

IF TR THEN BEGIN GOTOXY(0,22);
WRITELN('NOTICE -- VALUES TRUNCATED IN SIMULATE ');END;
END;

PROCEDURE DRAWPLOT(YA,YB:DATAVECT;LM,LA,LB:STRING);
(* DRAWS A PLOT OF VECTORS YA AND YB, LABELED WITH LM,LA,LB *)
BEGIN
IF AUTOSCALE THEN SCALE(YA,YB);
DRAWAXIS(LM,LA,LB);
PLOTDATA(YA,42);PLOTDATA(YB,43);
READLN(CH);TEXTMODE;
END;

PROCEDURE PLOTS;
(* DRIVING PROCEDURE FOR PLOT *)
BEGIN REPEAT CLEARSCREEN;
WRITELN(' ENTER PLOTTING OPTION --> ');
WRITELN(' 1. OBSERVED DATA');
WRITELN(' 2. OBSERVED AND PREDICTED FOR ',NATNAM(1));
WRITELN(' 3. OBSERVED AND PREDICTED FOR ',NATNAM(2));
WRITELN(' 4. SIMULATED DATA');
WRITELN(' 5. QUIT');
WRITELN;WRITELN('TO STOP PLOT PRESS RETURN');
GOTOXY(27,0);READ(CH);
WRITE(' PLOTTING...');
CASE CH OF
'1':DRAWPLOT(Y1,Y2,'OBSERVED',NATNAM(1),NATNAM(2));
'2':BEGIN PREDICT(YP1,X1,X2,-RA,RK,RG);
DRAWPLOT(Y1,YP1,NATNAM(1),'OBSERVED','PREDICTED');END;
'3':BEGIN PREDICT(YP2,X1,X2,RM,-RB,RH);
DRAWPLOT(Y2,YP2,NATNAM(2),'OBSERVED','PREDICTED');END;
'4':BEGIN SIMULATE;
DRAWPLOT(YS1,YS2,'SIMULATED',NATNAM(1),NATNAM(2));END;
END; (* CASE *)
UNTIL (CH='5') OR (CH='Q');
END;

(* ***** CHANGE PARAMETER VALUES ***** *)

PROCEDURE WRITEVALUES;
(* WRITES OUT CURRENT VALUES OF PARAMETERS *)
BEGIN CLEARSCREEN;
GOTOXY(8,0);WRITELN('RICHARDSON'S S ARMS RACE MODEL');
GOTOXY(10,2);WRITELN('X(T+1) = KY(T) - AX(T) + G');
GOTOXY(10,3);WRITELN('Y(T+1) = MX(T) - BY(T) + H');
GOTOXY(0,5);WRITELN('K= ',RK:10:4,' M= ',RM:10:4);
WRITELN('A= ',RA:10:4,' B= ',RB:10:4);
WRITELN('G= ',RG:10:4,' H= ',RH:10:4);
WRITELN('X(0) = ',X0:10:3);
WRITELN('Y(0) = ',Y0:10:3);
WRITELN('NUMBER OF YEARS = ',NY); (* 11 *)
GOTOXY(0,12);
WRITELN('HORIZONTAL SCALE: ',(NY+1)*HSCAL/HDIM:7:3,' ('R' TO CHANGE)');
WRITELN('VERTICAL SCALE: ',(10.0/VSCAL):10:3);
WRITELN('LOWEST VALUE: ',VMIN);
IF AUTOSCALE THEN S:=TRUE ELSE S:=FALSE;
WRITELN('SCALING AUTOMATIC: ',S); (* 16 *)
WRITELN;
GOTOXY(0,21);WRITELN('CHANGE PARAMETER -->');WRITELN('Q TO QUIT');
GOTOXY(22,21);
END;

PROCEDURE READPAR(VAR R:REAL;X,Y:INTEGER);
(* MOVES CURSOR TO (X,Y), BLANKS OUT NUMBER, READS NEW VALUE *)
BEGIN GOTOXY(X,Y);WRITE(' ');
GOTOXY(X,Y);READLN(R);END;

PROCEDURE CHANGEPAR;
(* CHANGES PARAMETER VALUES *)
BEGIN
REPEAT READ(CH);
CASE CH OF
'K':READPAR(RK,4,5);'M':READPAR(RM,20,5);
'A':READPAR(RA,4,6);'B':READPAR(RB,20,6);
'G':READPAR(RG,4,7);'H':READPAR(RH,20,7);
'X':READPAR(X0,7,8);'Y':READPAR(Y0,7,9);
'N':BEGIN REPEAT READPAR(RR,17,10);
IF TRUNC(RR)>MAXNY THEN BEGIN
GOTOXY(20,11);WRITE('N MUST BE <=',MAXNY);END;
IF RR<0.0 THEN BEGIN GOTOXY(20,11);
WRITE('N MUST BE > 0 ');END;
UNTIL (TRUNC(RR)<=MAXNY) AND (RR>0.0);
GOTOXY(20,11);WRITE(' ');NY:=TRUNC(RR);END;
'R':BEGIN READPAR(RR,18,12);HSCAL:=HDIM*RR/(NY+1);END;
'V':BEGIN READPAR(RR,18,13);VSCAL:=10.0/RR;END;
'L':BEGIN READPAR(RR,15,14);VMIN:=TRUNC(RR+1.0);END;
'S':BEGIN CH:= ' ';
WHILE (CH<>'T') AND (CH<>'F') DO BEGIN
GOTOXY(18,15);WRITE(' ');GOTOXY(18,15);READ(CH);END;
IF CH='F' THEN WRITE('FALSE') ELSE WRITE('TRUE');

```

Listing 1 continued on page 128

Someday, in the comfort of your home, you'll be able to shop and bank electronically, read instantly updated newswires, analyze the performance of a stock that interests you, send electronic mail across the country, then play Bridge with three strangers in LA, Chicago and Dallas.

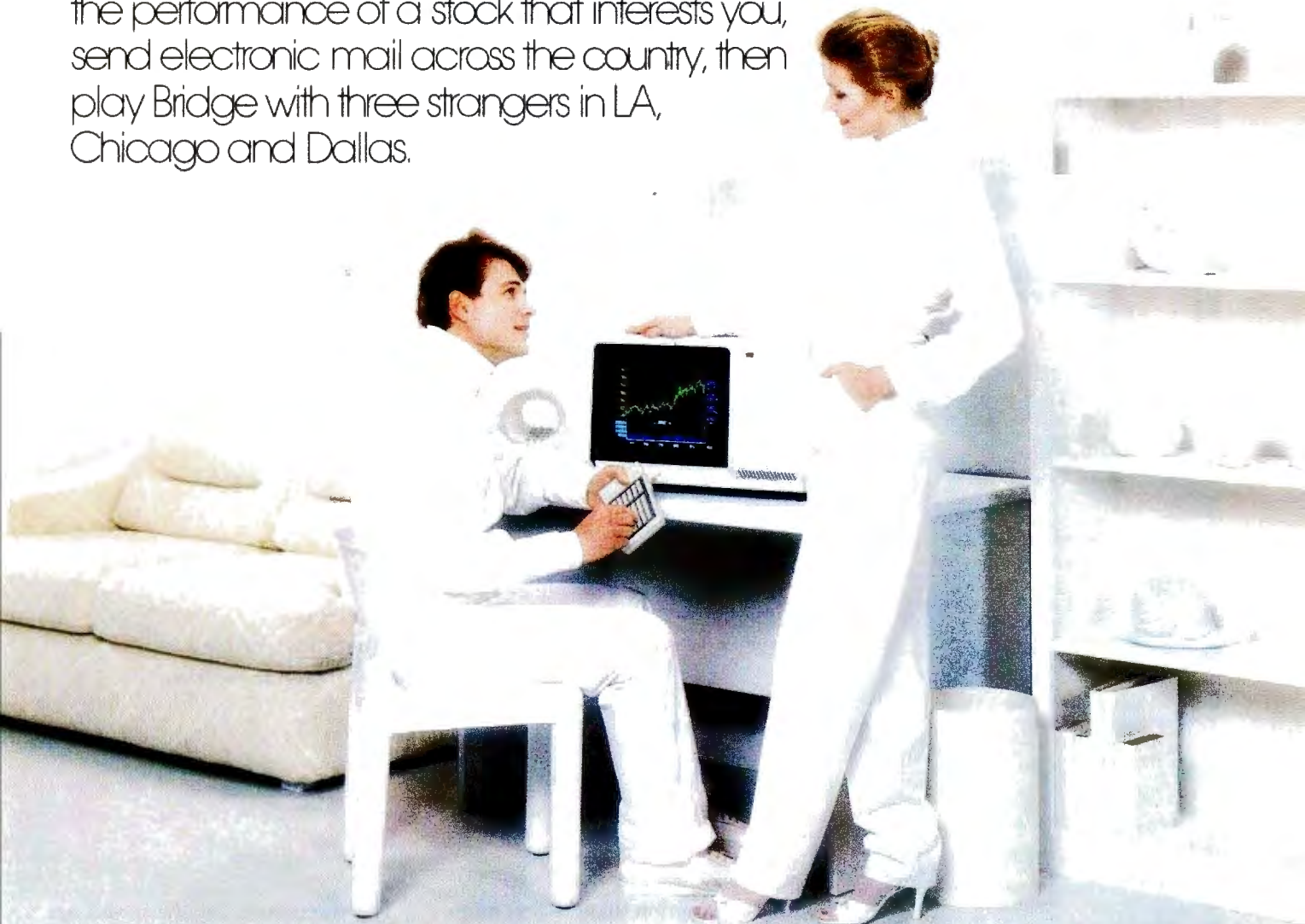

Welcome to someday.

Someday is today with the CompuServe Information Service. CompuServe is available through a local phone call in most major U.S. cities. It connects almost any brand or type of personal computer or terminal with our big mainframe computers and data bases. All you need to get started is an inexpensive telephone coupler and easy-to-use software.

CompuServe's basic service costs only \$5.00 per hour, billed in minute increments to your charge card.

The CompuServe Information Service is available at many computer stores across the country. Check with your favorite computer center or contact CompuServe.

Welcome to someday.

CompuServe

Information Service Division, 5000 Arlington Centre Blvd.
Columbus, Ohio 43220 (614) 457-8650

An H&R Block Company

Circle 89 on Inquiry card.

INTELLIGENT PRINTER INTERFACE

Free Your Computer from the
Mundane Task of Printing



Imagine being able to use your computer seconds after beginning an extensive printout.

Visualize your printout with page breaks, page numbering and titles, margins of your choice, indented carryover lines, on any size paper!

Appreciate the time and money you will save by not waiting for your printer.

SooperSpooler, a buffered printer interface, maintains control over your printer while you go on using your computer for more productive activities. Eliminate waiting while your printer pecks through a long document. SooperSpooler accepts information from your computer at up to 3000 characters per second and feeds it to your printer as fast as it can handle it—without using any of your computer's memory or time!

SooperSpooler features include:

- 16K Memory (62K optional)
- Buffer Status Readout
- Space Compression
- Pagination
- Single Sheets
- Headers and Page Numbering
- Indentation on Carryover Lines
- Self Test Routine
- Features also Software Controllable
- Plugs into Most Computer Systems
- ★ 16K Parallel I/O Unit—\$349.00!
- ★ Serial I/O Option—\$95.00
- ★ 46K Memory Option—\$159.00

SooperSpooler by Compulink—
The missing link that gives your microcomputer mainframe printing.

COMPULINK CORPORATION

1840 Industrial Circle
Longmont, CO 80501 (303) 651-2014

Send for brochure
Dealer inquiries welcome
Call for information: 800-525-6705

Listing 1 continued:

```

AUTOSCALE:=(CH='T');END;
END; (* CASE *)
IF CH IN ['K','A','M','B'] THEN WRITEIGEN;
GOTOXY(22,21);WRITE(' ');GOTOXY(22,21);
UNTIL CH='Q';
END;

(* ***** MAIN PROCEDURES ***** *)

PROCEDURE MONITOR;
(* MAIN DRIVING PROCEDURE *)
BEGIN CLEARSCREEN;GOTOXY(0,5);
WRITELN(' ***** DEMONSTRATION PROGRAM FOR *****');
WRITELN(' ***** RICHARDSON'S ARMS RACE MODEL *****');WRITELN;
WRITELN(' ENTER OPTION --->');
WRITELN(' E) ESTIMATE ');
WRITELN(' C) CHANGE PARAMETER VALUES ');
WRITELN(' P) LOT ');
WRITELN(' Q) QUIT '); GOTOXY(18,8);READ(CH);
CASE CH OF
'E':ESTIMATE;
'C':BEGIN WRITEVALUES;CHANGEPAR;END;
'P':PLOTS;
'Q':EXIT(PROGRAM);
END (* CASE *)
END;

PROCEDURE INITPROG;
(* SETS ASSORTED PROGRAM PARAMETERS *)
BEGIN
HLO:=5;HHI:=275;VLO:=15;VHI:=185;
HDIM:=HHI-HLO;VDIM:=VHI-VLO; (* SETS DIMENSIONS OF PLOT *)
MAXVAL:=PWOFTEN(12);
(* IDIOT-PROOF BY INITIALIZING PARAMETERS TO SOMETHING SAFE... *);
RK:=0.2;RA:=0.4;RG:=1.0;RM:=0.3;RB:=0.5;RH:=2.0;
XO:=10.0;YO:=20.0;
IF MAXNY>30 THEN NY:=30 ELSE NY:=MAXNY;
NATNAM[1]:='X';NATNAM[2]:='Y';
AUTOSCALE:=TRUE;
HSCL:=1.0;VSCL:=1.0;VMIN:=0;
SIMULATE;
FOR KA:=0 TO NY DO BEGIN YP1[KA]:=YS1[KA];YP2[KA]:=YS2[KA];
Y1[KA]:=YS1[KA];Y2[KA]:=YS2[KA];
X1[KA]:=YS1[KA];X2[KA]:=YS2[KA];END;
END;

(*MAIN PROGRAM *)
BEGIN
INITPROG;
REPEAT MONITOR UNTIL FALSE;
END.

```

Text continued from page 120:

with the exception that the first number in each line of arms data is skipped, which allows the file to contain year numbers or other identifying numbers. For example, the first lines from the file used to produce figure 2 are:

IRAN		
IRAQ		
21		
1954	78	75
1955	107	67
1956	126	94
1957	151	102
1958	243	110
1959	271	129
...		

Note that the program automatically supplies the .TEXT suffix for the file name.

The coefficients for the model are estimated using ordinary least-squares estimation. The program computes the coefficients of the model, the standard error of those coefficients, and two measures of the fit of the prediction. The correlation coefficient R-square is a statistical measure of the fit of the predicted and observed values—an R-square of 0.0 means there is no fit, an R-square of 1.0 means there is a perfect fit. The *mean absolute percent error* is a more conventional measure: the average error of the prediction as a percentage of the value that is being predicted.

The standard error of the coefficients gives a rough idea of whether the coefficients are distinct from zero—in other words, whether a nation is actually reacting to threat or economic burden. In large samples, a

The revolutionary Discovery multiprocessor is the only system that allows the total integration of powerful 16 bit 8086 processors with the more standard Z-80 user processors. The DISCOVERY system may be configured in any 8 bit/16 bit combination, or as a totally exclusive 16 bit system only to provide the ultimate in performance and flexibility in advanced micro systems.

Ultimate performance. The dpc-186 is the most sophisticated single board microcomputer available today offering more power and faster processing time through the 8086 CPU for bigger, more complex programs. Memory starts at 128 K (compared to the Z-80's 64 K), and is expandable to 1 megabyte. And the dpc-186 is fully compatible with the standard DISCOVERY multiprocessor system permitting efficient upgrading as future needs develop, without sacrificing any of your extensive hardware and software investment.

World's best multiprocessor system. The DISCOVERY system provides separate processors and memory for each of its 16 users. It offers full CP/M™ and CP/M-86™ compatibility, interprocessor communication, and shared and private files. Each user can take advantage of shared peripherals and cross submitting of tasks between processors. The system is controlled by a unique, two board dpc-280 service processor and dpc/os distributed processing operating system.

By the board or by the system. The DISCOVERY multiprocessor is ready for immediate delivery as a complete system, as processor boards, and everything in between. It offers exclusive technology in multiprocessing, yet is fully compatible with existing standards including CP/M and S-100. It is quite simply unmatched in performance, capabilities and offers a far greater degree of flexibility.

DISCOVERY—offering a whole new world of possibilities.

For the first time, 8 and 16 bit processor intermixing.



Action Computer Enterprises, Inc.



The Multiprocessing Company
55 West Del Mar Boulevard, Pasadena, CA 91105 USA
(213) 793-2440, TWX 910-588-1201

Circle 6 on Inquiry card.

Dealer and OEM inquiries invited.

*CP/M is a registered TM of Digital Research, Inc.

Doris believed herself the most "fully formed" character in the office.



Until she became an Orange Micro Printer Expert.

Printers Can Be Confusing. Sometimes, even the informed personal computer owner is caught short by the mound of technical differences in printers. Had Doris come to Orange Micro sooner, she'd know a *fully-formed character* was similar to the crisp, solid typestyle that came from her office typewriter.

We Educate First. With so many different printers out there

with as many different features, we feel a printer education is in order. We take what you already

know about computers and explain printers in the same terms. Our current customers seem to like that because of the friends they refer. (Nearly 50% of our business is referral.)

It's Easy To Be An Expert. Orange Micro printer specialists are there to make you feel comfortable with your newfound printer knowledge. And when you decide on the printer right for you, you'll know exactly why you picked it from all the rest. With over 35 popular models to choose from, and a com-



plete selection of cables, options and interface accessories, we have everything you need to get your new printer up and operating in minutes.

We Have The Right Printer For You. Bring along your toughest printer questions. Our salespeople will answer them honestly and practically. In less time than you'd imagine possible, you'll be a printer expert too! After all, printers are our only

business, so we always do a better job at finding the right one for you.

Orange Micro Printer Stores

3150 E. La Palma, Suite I
Anaheim, CA 92806 (714) 630-3622

13604 Ventura Boulevard
Sherman Oaks, CA 91423 (213) 501-3486

3216 Scott Boulevard
Santa Clara, CA 95051 (408) 980-1213



Orange Micro™
PRINTER STORE

Limited Franchise Opportunities Now Available. Call (714) 630-3620.

© Orange Micro Inc., 1982

coefficient that is twice the size of its standard error means that you can be 95 percent certain that the coefficient is actually nonzero and was not produced by chance. It should be noted that many processes appear to fit a Richardson model when no interaction is taking place and the model

$$X(t + 1) = aX(t) + g$$

$$Y(t + 1) = bY(t) + h$$

would fit as well as the Richardson model. If the fit of the model is good, but the standard error of the threat coefficient is large, this is probably what is happening.

**Missing
Do To
Page
Mis-Feed**

parameter list, which is displayed by entering C. Alternatively, you can skip the estimation and set the parameters manually to experiment with the behavior of the model. You change parameters by entering the first letter of the parameter and typing in the new value. You can also change the scales on the plots and the number of years in the same way.

Three scaling parameters are contained in this module. When horizontal scaling is equal to 1, all years of data are displayed. Setting horizontal scaling greater than 1.0 will expand the graph horizontally, and some later years will not be plotted. Setting the horizontal scaling to less than 1 will squeeze the graph into a smaller space. Note that horizontal scaling is changed with 'R' rather than 'H.' The vertical scaling is the number of units between tic marks on the vertical axis; the lowest value is the value at the bottom of the screen. The horizontal axis is drawn at the value 0 if that is on the plot; otherwise, the

horizontal axis is drawn at the lowest value.

This module also computes the eigenvalues of the model. These two numbers are a function of the parameters k, m, a, and b and determine the stability of the model. If both eigenvalues are real and less

Parameters can be set manually to experiment with the behavior of the model.

than 1 in absolute value, the model is stable; otherwise, it is unstable. Complex eigenvalues produce oscillating behavior. The larger the eigenvalues, the more rapidly the arms levels change.

P)LOT

This module draws a screen plot of either (1) the data points entered in

E)STIMATE; (2, 3) the observed and predicted values of one of the nations entered in E)STIMATE; or (4) the values produced by simulating the behavior of the system using the equations and the initial values X0,Y0.

Figures 1, 2, and 3 were produced by P)LOT options 1, 2, and 4, respectively. In options 2 and 3, the program makes predictions from the previous year's data at each point—in other words, the predictions are short-term rather than long-term. Each axis is marked with tic marks that correspond to the scales given in the C)HANGE procedure. Each plot is rescaled to fit the entire screen unless you have set automatic scaling to FALSE in C)HANGE. Predicted values are done using the current parameters set in C)HANGE.

Option 4 simulates the behavior of the system using the current parameters and initial values, without comparing them to actual data. The parameters are displayed and

Olympic Sales Company

SERVING YOU SINCE 1947

CABLE: "OLYRAV" LSA
Main Showroom & Offices:
216 So. Oxford Ave.
Los Angeles, CA 90004
Telex: 67 34 77

WE HONOR VISA and MASTERCARD

ORDER DESKS
open 6 days a week!
7:00 am to 7:00 pm Mon thru Sat
Order Desks: (213) 739-1130

TOLL-FREE (outside Calif.) TOLL-FREE (within Calif.)
800-421-8045 800-252-2153

Prices shown are for mail or phone orders; Walk-in slightly higher.

Goods subject to availability; OSC will meet or beat almost any advertised price as long as the competition has the goods on hand; not responsible for typographical errors; prices & specifications subject to change without notice; this ad supercedes all previous ads; min shpg & hndlg \$5.95; Send \$2 for 112-pg catalog!

HEWLETT PACKARD

HP-87 32K Bytes standard \$1885.00

82907A	32K Mem. mod.	239.00
82908A	64K Mem. mod.	337.00
82909A	128K Mem. mod.	537.00
HP-85A	Computer	\$1985.00
HP-125	Computer	1985.00
HP-41C	Prog. scientific	188.00
HP-41CV	Prog. scientific	248.00
HP-41	Card reader	169.00
HP-41	Printer	287.00
HP-41	Optical wand	99.00
82105A	41C Memory module	26.00
82170A	41C Quad mem. mod.	84.00
82160A	HP-IL interface	109.00
82161A	Cassette drive	437.00
82162A	HP-IL printer	397.00
HP-97	Prog. scien/printer	584.00
HP-32E	Scientific	55.00
HP-33C	Prog. scientific	74.00
HP-34C	Adv. prog. scientific	114.00
HP-37E	Business	74.00
HP-38C	Prog. financial	119.00
HP-11C	Prog. scientific	114.00
HP-12C	Prog. financial	127.00
82905A	Impact printer	619.00
82901M	5K" dual drive	1699.00
9895A	8" dual drive	4499.00
2631B	Impact printer	2999.00
2601A	Letter qual. ptr.	2999.00
85-15001	Mass storage ROM	124.00
85-15002	Plot/print ROM	124.00
85-15003	I/O ROM	239.00
85-15004	Matrix ROM	239.00
85-15005	Adv. prog. ROM	124.00
85-15007	Assembler ROM	124.00
82903A	16K mem. module	239.00
82937A	HP-IB interface	169.00
82938A	Serial interface	328.00
82940A	GPIO interface	338.00
82941A	BCD interface	408.00
82949A	Parallel ptr. int.	408.00
HP-7470A	Hi-speed color graphic plotter w/interface	239.00

Texas Instruments Home Computer

New TI-99/4A - 48K RAM
100% TI parts w/Extended Basic
or TI-LOGO Re: \$1300 Y/C: \$5689.95

TI-99/4A Only \$299.95

16K
10" color monitor high res
32K memory module
Extended Basic
Speech synthesizer
Disk memory drive
Telephone coupler (modem)
Printer (solid state)
TI-LOGO

RETAIL	Your Cost
374.95	339.95
399.95	314.95
100.00	75.00
149.95	129.95
499.95	394.95
224.95	189.95
399.95	319.95
250.00	99.95

AMDEK Leadex

High Quality Monitors

Model	Description	Retail	Your Cost
100	12" B/W, 12 MHz	189.00	149.00
300-G	12" Green, 18 MHz	268.00	198.00
Color I	13" Color, NTSC comp. input, audio amp & vcr; 499.00	499.00	359.00
Color II	13" Color, RGB input, hires graphics, opt; 1295.00	1295.00	799.00

SANYO MONITORS

High resolution, number one seller!

Model	Description	Retail	Your Cost
15"	Black & white	390.00	199.00
13"	color (DM 6113) RGB, High Res	1195.00	989.00
13"	color (new) high quality!	650.00	449.00
12"	Green phosphorous	360.00	269.00
12"	Black & white	340.00	249.00
9"	Black & white (the best seller)	235.00	179.00
9"	Green phosphorous	295.00	199.00

Commodore VIC-20

5K Personal Computer
(Expands to 32K) Works with any TV!
Retail: \$300.00 Your SPECIAL Cost: \$259.95
FREE with purch of VIC-20 one \$49.50 LCD Pen Watch!
Commodore Datasette Recorder for VIC-20 Your Cost: \$68.95 We carry all peripherals, software & access. for the VIC-20 (we will beat any price!)

ATARI COMPUTERS IN STOCK

Model	Retail	Your Cost
800 16K	1080.00	689.95
800 48K	1280.00	789.95
800 160K		
(800-32K + 128 RAM disk)		1299.95
810 Disk drive	600.00	469.95
Atari VisiCalc	200.00	169.95
825 Impact Ptr	1000.00	779.95

SUPER SPECIAL - ATARI 400 (16K)
Your Cost \$299.95
Retail \$595.00
400 Lang. card opt. \$49.95

FOR ATARI 400 & 800 -
GHOST HUNTER (similar to Pac-Man)
Disk \$34.95 Cassette \$29.95

ATARI Pac-man

Atari's game cartridge \$35.95

APPLE COMPUTERS

Graphics Tablet
Second disk drives
Disk with controller DOS 3.3
Pascal-Fortran-Cobol languages
VisiCalc for Apple II & III
more available!

EPSON PRINTERS

Model	Your Cost
MX70	\$299.95
MX80	429.95
MX80 with graftrax	499.95
MX80 FT	599.00
MX100	749.00
Graftrax chip	95.00

AXLON HOTLINE Model 1

HAND-HELD Personal Communication TERMINAL with BUILT-IN Modem Y/C: \$399.95

AXLON Memory Expansion for ATARI & APPLE

RAMCRAM Instant 32K boost for your Atari 400 or 800
Re: \$189.00 Y/C: \$119.95

RAMDISK 128K for Atari 800-comp w/existing Atari 800 software; can be used as ad disk function for function.
Retail: \$695.00 Your Cost: \$499.95

RAMDISK for APPLE. 320K bytes of RAM (200NS) mem. designed to function like 2 35 track floppy disk drives; comp. atible w/ Apple DOS 3.3 & Apple Pascal 1.1.
Retail \$1395.00 Your Cost \$1095.00



Think Now!

Multi-user MP/M™ 8-16* runs 8 bit CP/M® software better than it's ever been run before.

With an **MP/M 8-16** system, your 8 bit programs are . . .

- **BIG**—over 61K! That's over 6K more user space than conventional CP/M 2.2™!
- **FAST**—DMA floppy and hard disks with cache buffering. Solid state memory disks. High speed (8 MHz) CPU's.
- **MULTI-USER**—Programs shine and applications flourish in a multi-user environment designed by the best (Digital Research) to meet the demands of professionals.

Think Ahead!

MP/M 8-16 runs 16 bit CP/M 86™ software, so you can get what's coming!

■ You can **UPGRADE** effortlessly from 8 to 16 bit software (for example, from CBASIC™ to CBASIC 86™) without leaving your programs or data behind. You get complete file compatibility between 8 and 16 bit CP/M. Other systems make you choose between 8 and 16 bits. **MP/M 8-16** systems have two CPUs—one 8 bit, one 16 bit. You get it all. Now. And tomorrow.

■ Even the hardware is upgradable. Our boards are compatible with the IEEE 696 bus (and we've got 20 bus slots!). Our state-of-the-art systems can keep pace with the state-of-the-art. Just add boards.

■ All boards in our **MP/M 8-16** systems are CompuPro's Certified System Components, which includes a two year immediate replacement warranty.

G&G Engineering and CompuPro™ do it best!

MP/M 8-16 systems start at \$8995, terminals not included.

G&G Engineering is an authorized CompuPro systems center. We offer completely integrated CompuPro based systems running CP/M, MP/M, and UNIX.®

Think **G&G** ENGINEERING!

1922 Republic Avenue, San Leandro, California 94577 (415) 895-0798

*MP/M 8-16 is a proprietary implementation of Digital Research's MP/M 86 operating system, configured for CompuPro by G&G Engineering.
CompuPro is a trademark of Godbout Electronics; MP/M 86, CP/M, CP/M 2.2, CP/M 86, CBASIC and CBASIC 86 are trademarks of Digital Research; UNIX is a trademark of Bell Laboratories.

Circle 168 on inquiry card.

We'll pay \$50 for your IBM Personal Computer word processor.

EDIX + WORDIX is the world's most advanced, most flexible microcomputer word processor. If you've missed the chance to buy it, we'll give you another chance.

No word processor has the features of EDIX + WORDIX. Multiple windows. Side-to-side scrolling. Completely automatic hyphenation. Automatic footnote placement. User-defined macros. Online help. And much more.

If you haven't yet bought your IBM Personal Computer word processor, then you're even luckier. Just send us \$195 for EDIX (the editor) or \$325 for EDIX + WORDIX. Or write for our detailed brochure.

To sell us your old word processor (or screen editor): Along with your order for EDIX + WORDIX, send us the original diskette, the original manual and binder, and the license agreement. We'll send you a \$50 check. Or you can take a \$50 discount instead. Offer applies only to commercially available word processors or screen editors for the IBM Personal Computer.



Emerging Technology Consultants, Inc.
Box 154
Louisville, CO 80027
(303) 447-9495

EDIX and WORDIX are trademarks of Emerging Technology Consultants, Inc.

COPIES WITHOUT PROBLEMS:

FAST: Turnaround time in hours and days, not weeks. You get your disks when you need them.

ACCURATE: Each copied track is checked bit by bit. If it doesn't match your original, it isn't shipped.

FLEXIBLE: Standard, double-boot, and copy-resistant formats. 50 copies minimum, no maximum.

REASONABLE: Set-up as low as \$10 per disk. Copying only from 30¢, copying and 3M disk from \$2.00. Other disks and services also available.

RELIABLE: Years of disk duplication experience insures a problem-free shipment on time — time after time.

For all your Apple® compatible copying needs.

THE ALF COPY SERVICE.



1448 Estes Denver, CO 80215 (303) 234-0871

changed in C)HANGE. This procedure is useful for experimenting with the behavior of the model. If the values of the model become too large, the program truncates the simulation to avoid overflow errors.

Option 4 provides a nice demonstration program for showing the behavior of systems of linear difference equations. Of course, such systems apply to many phenomena other than arms races. A few minor modifications would enable the program to handle a differential equation system. In classroom discussions of linear models, I've found this to be an effective way of demonstrating the influence of the eigenvalues on the behavior of the system. ■

Availability of the Programs

If you wish to avoid typing, this program is available on disk as part of a package of three political science programs:

RICHDEMO: Estimation and demonstration of the Richardson arms-race model.

BANZDEMO: Computation and demonstration of the Banzhaf Index of voting power in weighted voting situations. Includes options for direct and Monte-Carlo computations, and for excluding coalitions.

VOTEDEMO: Demonstration of the majority, plurality, Condorcet, Copeland, Borda, and STV voting systems for a given set of preference orderings.

All programs are written in Apple Pascal and require the Apple Language System. They are available on disk from the author at the Department of Political Science, Northwestern University, Evanston, IL 60201. The cost is \$25 prepaid.

References

1. Olnick, Michael. *An Introduction to Mathematical Models in the Social and Life Sciences*. Reading, MA: Addison-Wesley, 1978.
2. Rapoport, Anatol. *Fights, Games and Debates*. Ann Arbor: University of Michigan Press, 1974.
3. Richardson, Lewis F. *Arms and Insecurity*. Chicago: Quadrangle Books, 1960.
4. Zinnes, Dina A. *Contemporary Research in International Relations*. New York: Free Press, 1976.

COMMODORE VS. APPLE

IBM, TANDY, ATARI AND ALL THE OTHERS



"The new Commodore 64 personal computer has 33% more user memory than Apple II+® and 300% more than IBM®. And, at an incredible \$595, it's well under half the cost."

—William Shatner

COMPARE OUR \$595 PERSONAL COMPUTER					
FEATURES	COMMODORE "64"	APPLE II+®	IBM®	TANDY TRS-80® III	ATARI 800®
Base Price	\$ 595	\$1530	\$1565	\$ 999	\$ 899
Advanced Personal Computer Features					
Built-in User Memory*	64K	48K	16K	16K	16K
Programmable	YES	YES	YES	YES	YES
Real Typewriter Keyboard	YES (66 keys)	YES (52 keys)	YES (83 keys)	YES (65 keys)	YES (61 keys)
Graphics Characters	YES	NO	YES	NO	YES
Upper and Lower Case Letters	YES	Not Included	YES	YES	YES
Maximum 5¼" Disk Capacity Per Drive	500K	143K	160K	178K	96K
Audio Features					
Sound Generator	YES	YES	YES	NO	YES
Music Synthesizer	YES	NO	NO	NO	NO
Hi-Fi Output	YES	NO	NO	NO	NO
Video Features					
TV Output	YES	YES	YES	NO	YES
Input/Output Features					
"Smart" Peripherals	YES	NO	NO	NO	YES
Software Features					
CP/M Option (Over 1,000 Packages)	YES	YES	YES	YES	NO
Game Machine Features					
Cartridge Game Slot	YES	NO	NO	NO	YES
Game Controllers	YES	YES	YES	NO	YES

*Each "K" equals 1,000 characters or digits of information. Disk drives and printers are not included in prices. Models shown vary in their degree of expandability.

The new Commodore 64 may well be the most outstanding personal computer ever introduced.

It represents a breakthrough in microcomputer technology, with an amazing 64K of memory, and features not found in systems costing many times more. (See chart)

- How can Commodore do it? Commodore is the *only* U.S. personal computer company that manufactures its own microprocessors, the "heart" of all personal computers. (Commodore microprocessors are used in Apple and Atari computers, and many others.)
- Commodore is the *only* personal computer company with a full line of computers—from our \$299.95 VIC-20 to the remarkable new \$1995 Super PET that speaks 7 high-level computer languages.
- And with over a quarter of a million computers sold worldwide, Commodore is proven for performance and reliability.

PERIPHERALS

The Commodore 64 also has a



full range of low-cost peripherals, including disk drives, printers and communication devices. Our low-priced telephone modem permits you to access data banks and interface with other computers.

USES AND APPLICATIONS

- **Word Processing.** It's easy and inexpensive on the Commodore 64.
- **Electronic Spreadsheet:** Lets you plan budgets and explore all your financial alternatives in seconds. And with the optional graphic program, you can create bar and line graphs from your spreadsheet data.
- **Financial Planning Tools:** Such as loan amortization, total loan cost and buy vs. lease are handled with ease.
- **Executive Diary/Memo Pad:** Quick and simple way to keep appointments, save messages and plan future work loads.
- **Doctors' Accounting System.** A fast, flexible billing and accounts receivable package.

- **Legal Time System:** Automatically processes activities by client, attorney and action.
- **Accounting and Bookkeeping Systems.** Accounts receivable. Accounts payable. Payroll. Inventory control. Job costing. Engineering. Personnel recordkeeping. Tax preparation.
- **Video Games.** Challenging and exciting recreation for every member of the family.
- **Plus CP/M* Compatibility.** A simple cartridge enables you to run thousands of additional CP/M software programs.

FULL SERVICE, FULL SUPPORT

Commodore dealers throughout the country offer prompt local service. In addition, our new national service contract with TRW provides nationwide support. Visit your local Commodore dealer for a hands-on demonstration.

*CP/M is a trademark of Digital Research, Inc.

Available only at computer stores after June 1st.

Commodore Computer Systems BY7
681 Moore Road,
King of Prussia, PA 19406

Please send me more information.

Name _____

Company _____ Title _____

Address _____

City _____ State _____ Zip _____

Telephone _____

Interest Area _____

Business Education Personal F426

commodore
COMPUTER



Performance, Quality, Reliability...

Disk Products

Disk 1. DMA floppy disk controller; single and double-density, single and double-sided (soft-sector). Available in 8" and 5.25" formats. **\$495, \$595 CSC. CP/M[®] 2.2 \$175, CP/M-86 \$240.**

Disk 2. DMA hard disk controller handles up to four disk drives, up to sixteen heads per drive. MP/M, CP/M-80, and CP/M-86 compatible. Includes CP/M 2.2. **\$795, \$895 CSC.**

Floppy Disk Sub-System. Two Qume quad-density drives deliver 2.4 Mbytes of on-line storage. All-metal enclosure: Disk 1 DMA controller, CP/M-80, and CP/M-86 included. **\$3295.**

CPUs

CPU 8085/88. The first dual processor board runs 8 bit and 16 bit software. **\$425, \$525 CSC.**

CPU Z. Excellence in a high speed Z80A board. **\$295, \$395 CSC (with Z80B).**

CPU 8086/87. 16 bit CPU with 80130 interval timer/interrupt controller and socket for 8087 math co-processor. Works with any mix of IEEE 696/S-100 8 or 16 bit memory. **\$695 (8 MHz), \$850 CSC (10 MHz).** Add \$600 for 8087 (limits clock speed to 5 MHz).

Interfacers

Interfacer 1. Two RS-232C serial ports, full handshake, independently selectable Baud rates. **\$249, \$324 CSC.**

Interfacer 2. Three full duplex parallel ports plus one full-feature RS-232C serial port. **\$249, \$324 CSC.**

Interfacer 3-5. Five RS-232C serial ports (2 sync/async, 3 async) with full handshake and selectable Baud rates. **\$599, \$699 CSC.**

Interfacer 3-8. Eight RS-232C serial ports (2 sync/async, 6 async) with full handshake and selectable Baud rates. **\$699, \$849 CSC.**

Interfacer 4. Three RS-232C serial ports, one parallel port, and one Centronics parallel port that even gives Epson printers full graphics capability (no buffer needed). **\$350, \$450 CSC.**

Memories

M-DRIVE. When you need computing in the fast lane, you need M-DRIVE—the first "solid-state disk drive" for microcomputers. **128K M-DRIVE \$1198, 256K M-DRIVE \$2395.**

RAM 16. Static, 10 MHz, works automatically with 8 or 16 bit systems. (64K X 8 or 32K X 16). **\$650, \$750 CSC.**

RAM 17. Static, 10 MHz, 64K X 8, ultra low power (1.6 Watts typical). **RAM 17-64K: \$599, \$699 CSC.**

RAM 20. Static, 10 MHz, extended addressing or bank select. **RAM 20-8K: \$210, \$280 CSC. RAM 20-16K: \$285, \$355 CSC. RAM 20-24K: \$355, \$425 CSC. RAM 20-32K: \$425, \$495 CSC.**

RAM 21. Static, 12 MHz, low power/high density. Works automatically with 8 or 16 bit systems (128K X 8 or 64 K X 16). **\$1695, \$1895 CSC.**

...is exactly what you expect from the company which pioneered active termination, dual processing for microcomputers, DMA soft and hard disk controllers, M-Drive (the "solid-state" disk), and now, **MP/M® 8-16**—the first multi-user operating system that runs any mix of 8 and 16 bit software within a multi-user system.

As you might also expect, our computers are as impressive as our track record. Visit your authorized **CompuPro Systems Center** to experience the state of the art in business, industrial, and scientific microcomputing.

Other Products

MP/M 8-16 Operating System.

CompuPro's proprietary version of Digital Research's multi-user MP/M-86 (V2.X) runs 8 bit (CP/M 2.2) and 16 bit (CP/M-86) software—**simultaneously**—in a multi-user environment. Available only for CompuPro systems. **\$1000.**

MPX 1-4 (4K on-board RAM); **MPX 1-16** (16K on-board RAM). Front end processor for multi-user systems. 4K: **\$495, \$595 CSC.** 16K: **\$649, \$749 CSC.**

Enclosure 2. Rugged, all-metal construction. With 20 slot motherboard, constant voltage power supply, line filter, cutouts for connectors, positive pressurized fan with filter, attractive styling.

Desktop model \$825, rack mount \$895.

System Support 1. Battery clock/calendar; sockets for battery backup RAM, 9511 or 9512 math processor, and 2716 ROM options; RS-232C serial port; triple interval timers; dual interrupt controllers; power fail interrupt; more. **\$395, \$495 CSC** (add \$195 for optional math processor).

Motherboards

6 Slot Motherboard (with active termination, Faraday shielding). **\$140, \$190 CSC.** 12 slots: **\$175, \$240 CSC.** 20 slots: **\$265, \$340 CSC.**

Documentation

"CompuPro Product User Manuals: 1975-1980". 250 + pages of data on Godbout/CompuPro products. **Softcover, \$20.**

"CompuPro Product User Manuals, Volume 2". 300 + pages of data on newer CompuPro products. **Softcover, \$25.**

"Interfacing to S-100/IEEE 696 Microcomputers". By Mark Garetz and Sol Libes (McGraw-Hill). Covers operating requirements and characteristics of the S-100 bus. **Softcover, \$15.**

CP/M, CP/M-86, and MP/M are trademarks of Digital Research. MP/M 8-16 is used under license from Digital Research.

All CompuPro system components are backed by a one year limited warranty (two years for boards qualified under the Certified System Component high-reliability program).



CompuPro division, Godbout Electronics, Oakland Airport, CA 94614-0355

Software Tools for Writers

*A programmer describes his experiences
developing tools that make writing easier.*

Wayne Holder
Oasis Systems
2765 Reynard Way
San Diego, CA 92103

Word processors have changed the way I think about writing. To be honest, I don't think I would even try to write if I didn't have a computer and a good text editor. A word processor lets me *experiment* with my prose. It removes the fear of making a mistake. Nothing takes the fun out of writing faster than having to retype pages over and over again.

My word processor also gives me a copy of my writing that my computer can read, which makes it easy for my computer to do more than just help me type neat pages. In this article I'm going to talk about some of the ways in which computer programs that read and analyze writing can help you write better. I'll also present listings of two assembly-language routines that are useful in dictionary programs.

Your computer can help you improve your writing in many ways. A spelling checker is an obvious example. Computers also can analyze how "readable" your writing is by using

various statistical formulas that measure how easy your writing is to comprehend. Or they can check your punctuation, grammar, use of passive voice, and overuse of words and phrases.

Once you get used to the idea of a computer looking over your shoulder while you write, I think you'll realize that writing can be fun! Then you'll start wanting your computer to do more than just make your writing OK. You'll want programs that make it easier for you to experiment with your text, rearranging it in novel ways.

I based much of this article on my experience writing such programs. My interest began when I started planning a commercial spelling-checker program. While researching the project, I discovered that many other people had developed interesting computer aids for writers. Inspired by these aids, I began to modify my plans as I considered making the spelling checker the basis of a

much more ambitious writing analysis system for microcomputers.

Sources of Inspiration

The most inspirational software package I came across was The Writer's Workbench, developed at Bell Laboratories for the Unix operating system. The Writer's Workbench is a system of programs that work with the existing Unix text editors and formatters to do prose evaluation. Many of the programs can be used only on the Unix system, but The Writer's Workbench served as a helpful guide to the kinds of computer analysis that could be useful to writers.

I was also inspired by the book *Software Tools* by Brian W. Kernighan and P. J. Plauger (see reference 6). I wanted my system to grow as I added new kinds of analysis programs, so the idea of "software tools" appealed to me greatly. Kernighan and Plauger advocate writing programs as small, multipurpose

INCREASE SALES OF CP/M®

**ANYONE CAN USE CP/M
WITH SUPERVYZ**

SUPERVYZ is a revolutionary software concept that serves as a mediator between the user and CP/M, requesting information in plain English and translating the response into the form CP/M recognizes. Users are led from one application to another in a courteous and step-by-step sequence of menus. Aided by descriptive error messages and computer-assisted tutoring, the operator avoids mistakes and is advised of the next step in a polite and friendly manner.

**EXPAND YOUR MARKET
AND LOWER COSTS**

As a Dealer, SUPERVYZ allows you to sell CP/M computers and application software to non-technical markets, without the added expense of teaching the operating system. EPIC supplies the menus or you create your own to meet the exact needs of your customers. Because SUPERVYZ is compatible with over 2,000 programs and 300 computers, you can bundle software from different suppliers and SUPERVYZ does the teaching. This eliminates costly after-the-sale handholding.

For further information about EPIC SUPERVYZ, call or write us today.



Supervyz is a trademark of
Epic Computer Corporation.
CP/M is a Trademark of
Digital Research.



Epic Computer Corporation
7542 Trade Street
San Diego, CA 92121
Tel. 714-695-3560

NOW SOLO THROUGH DISTRIBUTORS
IN POPULAR FORMATS
800-421-0814
DEALERS ONLY PLEASE

Circle 157 on inquiry card.

Normal Word	Compressed Word
ABACK (first word not compressed)	ABACK
ABANDON	3NDON
ABANDONING	7ING
ABANDONMENT	7MENT
ABASEMENT	3SEMENT
42 characters	26 characters

Figure 1: The technique of text compression in a computerized dictionary. A letter count replaces the number of letters at the beginning of a word that are the same as the letters at the beginning of the previous word. The number of letters in the words is reduced in this example from 42 to 26. Listing 1 shows how this technique was coded in 8080 assembly language.

units that can be strung together in different ways to achieve a more sophisticated result. I knew right from the start that I wouldn't be able to foresee all of the things that people might want to do with my system, nor would I know exactly what sort of new analysis programs I might write in the future. So a modular approach seemed the most flexible.

Spelling Checkers Reduce Anxiety

It is my personal conviction that people shy away from writing because they can't spell properly. I know that the fear of embarrassing myself because of my "creative" spelling has been a problem for me. Computerized spelling checkers are a great way of reducing "misspeller's anxiety." They let you write text privately at your computer terminal and quickly check and correct spelling errors before anyone else can see them.

One of the first spelling checkers was written by Ralph Gorin for the DEC-10 computer at Stanford University in 1971. Gorin's program was the model for others to come. The Unix operating system, a later development, provides two spelling checkers called SPELL and TYPO. TYPO uses a statistical approach to find spelling errors by looking at pairs and triplets of letters called *digrams* and *trigrams* (see reference 2). TYPO works by noting that certain combinations of letters are very rare. Words using these combinations are likely misspellings. This technique is not as accurate as one that uses an on-line dictionary because it will not locate misspelled words that contain legal trigrams and digrams. However,

I want to discuss this idea again a bit later because it offers a way to catch typos and spelling errors as you type in your text.

The Word is a series of programs that I planned originally as a spelling-checker system. During development I tested my program on my wife, Nancy, who writes and publishes romantic fiction. Her comments as a novice computer user helped me make the programs more flexible and useful.

The Word has a program called SPELL that is similar in principle to the Unix program of the same name. The Word, however, works on the CP/M operating system. I designed SPELL to check for misspellings by looking up words in a dictionary. I did not use any form of "suffix stripping" (removing suffixes from words before checking the spelling of the root) because I felt that it would compromise the accuracy of the program.

In order to be useful, a microcomputer-based spelling checker must overcome several limitations of small microcomputers: limited size and hardware specificity. A good spelling checker needs a reasonably large dictionary, and the dictionary must fit onto a floppy disk. In addition, the spelling checker must be able to read the text file formats of different text editors and word processors.

Dictionary Compression

To fit a large dictionary onto a microcomputer, some form of text compression must be used. The Word has a dictionary of about 45,000 words, which, in a text file, require over 440K bytes of disk space. A dic-

tionary for a spelling checker is simply an alphabetized list of words, and such lists can easily be compressed. The first few letters of successive dictionary words usually share identical letter combinations at the beginning of each word as a result of alphabetical ordering. To avoid this redundancy, the compression program removes common letters from successive words and replaces them with a one-byte count. Figure 1 gives an example. This compression method, when combined with several other techniques, squeezed the dictionary into 136K bytes of space.

Listing 1 shows an early version of the dictionary compression program. In later versions, I added some improvements that resort to esoteric programming, so for clarity I have left them out. The program in listing 1 reads characters from an input file via the subroutine GET\$UPPER (not shown). The program writes compressed output to a file via the subroutine WRT (also not shown). Words are delimited by setting the MSB (most significant bit) of the last character. When the program detects an EOF (end-of-file) code it branches to the Exit routine. The program expects the Exit routine to close the output file and exit to the operating system. The program is written in 8080 assembly language and conforms to CP/M file conventions.

Listing 2 shows a subroutine that does the inverse operation to "uncompress" words and pass them back to a calling program. On each call, the subroutine reads a single word from the dictionary and returns it in WORD\$BUFFER. The end of the word in the buffer is delimited by a null byte. The subroutine assumes that it can read characters from the compressed dictionary by calling GET\$CHAR. You should not alter the content of WORD\$BUFFER because the subroutine needs it to "uncompress" subsequent words.

Compatibility with Text Editors

My biggest headache in developing SPELL was designing it to read text files from many different word processors. Document files composed

UP TO 16 USERS ON THE S100 BUS!

INTRODUCING THE TELETEK LINE OF MULTIPROCESSOR PRODUCTS

SYSTEMMASTER® SINGLE BOARD COMPUTER

- 4 MHZ Z-80A Microprocessor
- 64 Kx8 Bank Switchable RAM
- NEC 765 Floppy Disk Controller implemented with DMA! Runs any combination of single or double sided, 5 1/4 or 8 inch drives in single (IBM 3740) or double (IBM2D) density
- 2 RS-232C 45-19.2K Baud Serial Ports for terminals, modems, or printer
- 2 Parallel Ports for printer or intelligent hard disk controller
- Real Time Clock

\$795.00

SBC-1 SLAVE PROCESSOR BOARD

- 4 or 6 MHZ Z-80A Microprocessor
- 64K or 128K of Bank Switchable RAM
- 2 RS-232C 45-19.2K Baud Serial Ports
- 2 Parallel Ports for printer or can be used with PSC board for synchronous RS-422 communication up to 163K baud
- 1K or 2K FIFO Buffer for S-100 bus communication with master

\$795.00

4 MHZ/64K

TYPICAL DISTRIBUTED PROCESSING SYSTEM CONFIGURATION

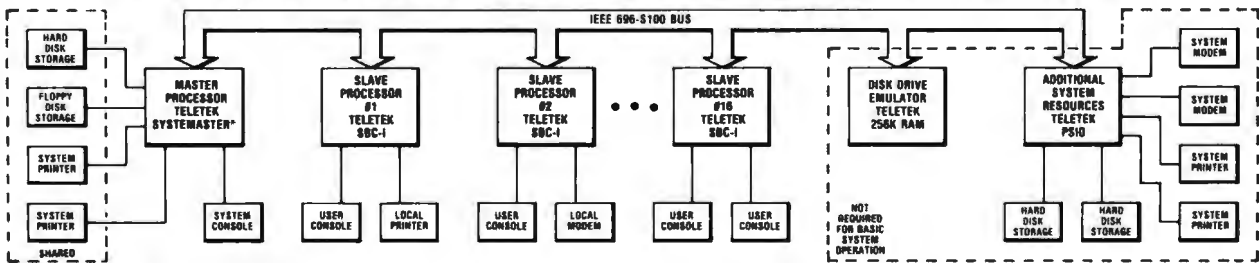

POSSIBLE CONFIGURATIONS:

- Basic single user system — SYSTEMMASTER® with CP/M*
- Two user system — add 64K memory board and MP/M*
- Six user system — add 256K memory board, MP/M* and PSIO board
- Sixteen user system — add one SBC-1 per user and TURBODOS**

*Product of Digital Research **Product of Software 2000

16 USER DISTRIBUTED PROCESSING SYSTEM FEATURES:

- SYSTEMMASTER® manages shared resources (disks, printers)
- SBC-1 services individual users (CRT terminal, modem, local printer)
- S-100 bus used only for interprocessor communications — all programs execute within each processor board
- Additional system resources (modems, printers, disk/tape storage, and memory) can be added by using other TELETEK S-100 boards:
 - Disk emulation — add TELETEK 256K memory board(s) and RAM drive software
 - Printers/modems/hard disk interface — add TELETEK PSIO board

OTHER TELETEK S-100 BOARDS:

- 64K/256K Bank Switchable Memory Board — OK: ***495.00**; 64K: ***595.00**; 256K: ***995.00**
- PSIO — 4 serial port/2 parallel port I/O board — ***295.00**
- FDC-I — same as SYSTEMMASTER® except has PROM programmer and 8K RAM/ROM — ***595.00**
- FDC-II — Floppy Disk Controller with NEC765, Bootstrap PROM, sector buffer — ***295.00**
- I* — Intelligent Interface Board with own Z-80A and 6 parallel ports (ideal for interfacing to hard disk or tape controllers) — ***275.00**

NEW for CENTRONICS 779

& Radio Shack Line Printer I

MAKE YOUR PRINTER A REAL WORKHORSE WITH OUR

NEW PRINTER CONTROLLER BOARD

Replaces the existing controller board in your printer and adds:

- Bidirectional logic-seeking print capability
- Full UPPER/lower case ASCII plus TRS-80 graphics or RADIX scientific character sets in 9x7 or 9x9 dot matrix format (9x9 requires that a nine wire print head be installed)
- Motor control — turns off the motor when the printer is not in use
- 2048 character buffer — for faster throughput of text
- Software selectable print densities (10, 12, 15 and 16.5 characters per inch plus DOUBLE WIDTH in each), forms length control, and self-test

\$350.00

Assembled and Tested

GO PIGGYBACK!

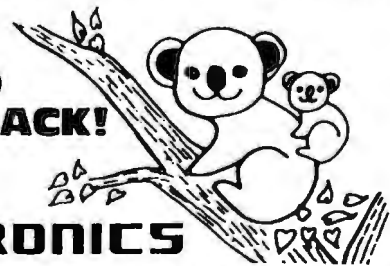

CENTRONICS

ADD lowercase with our PLUG-IN piggyback board
9Wx7H Dot Matrix ***135**; 5Wx7H Dot Matrix ***95**

TWO complete character sets on board: 96 character ASCII PLUS choice of APL, TRS-80/H-19 Graphics or Scientific. Most printers convertible: specify logic board number.

Radix Technologies

Suite 400 Carolyn Building

10400 Eaton Place

Fairfax, VA 22030 **(703) 385-0900**

VISA, MasterCard, check, COD accepted

IBM

personal computer

UCSD

p-System™ IV.1

A superior implementation of the UCSD p-SYSTEM is available NOW for your IBM Personal Computer.

Network Consulting has added many features that the professional programmer will find useful. These features are not available from any other sources.

- Hard disk support for Corvus, Tall Grass Technology and others
- 25% more floppy storage, without adding or modifying hardware, retaining compatibility with standard IBM diskettes
- Double sided and double sided/double tracking stepping floppy disk drive support
- Up to 800K on each mini-diskette
- RAM disk support (a pseudo-floppy volume that uses up to 512k RAM)
- 8086/87/88 macro assembler
- Extended memory support
- Adaptable system support available for adding custom I/O drivers
- Remote Terminal support
- XON/XOFF flow control for serial printers
- A library of program modules and other utilities
- Disk write verification
- and more!

Standard p-System features include:

- Standard I/O redirection (including command files)
- Dynamic program overlays
- Support for asynchronous processes and concurrency primitives in Pascal
- Fast Pascal p-code compiler
- Fast FORTRAN and Basic p-Code compilers also available
- A powerful screen oriented editor
- A filer for handling both files and volumes
- A Native Code Generator that processes your Pascal, Fortran and Basic programs to convert parts of them to native machine code
- Dynamic runtime binding of separately compiled programs and units
- Turtlegraphics for easy graphics displays
- Print spooler for background printing
- Symbolic debugger

**UCSD p-SYSTEM from
Network Consulting**

The only serious choice for business

TM The Regents of the University of California



Network Consulting Inc.
A106 - 1093 W. Broadway
Vancouver, B.C.
Canada V6H 1E2
(604) 738-3500

Listing 1: An early version of The Word's dictionary compression routine. Written in 8080 assembly language, the routine reads in a word list by calling the subroutine GET\$UPPER (not shown) and writes a compressed file by calling the subroutine WRT (also not shown). The compression routine compares a word to its predecessor, counts the number of beginning letters that are the same, and then replaces the beginning letters in the second word with the count of the duplicates. The rest of the second word is stored literally. Figure 1 illustrates the technique embodied in this subroutine.

```

; This program reads an alphabetized word list as input
; via calls to GET$UPPER (returns characters converted
; to upper case) and writes a compressed file via calls
; to WRT. At the end of the input file the program exits
; to EXIT.
;
; COMPRESS:
; Read a word from input file into 'WORD$BUFFER'.
; Words can only begin with a letter, but may contain
; letters and apostrophes
LXI H,WORD$BUFFER
MVI B,0
CALL GET$UPPER
CPI LAH ; CP/M End of File?
JZ EXIT
CPI 'A'
JM WORD$READ
CPI 'Z'+1
JP WORD$READ
; Get here when input character is a letter
ALPHA$READ:
MOV M,A
INR B
INX H
CALL GET$UPPER
CPI 27H ; apostrophe
JZ ALPHA$READ
CPI 'A'
JM WORD$END
CPI 'Z'+1
JM ALPHA$READ
WORD$END:
; Get here with word in 'WORD$BUFFER' and B=Length
; set MSB of last character in word
DCX H
MOV A,M
ORI 80H
MOV M,A
MOV A,B
; Reject words of less than 2 characters
CPI 2
JM WORD$READ
; Compare new word to old word
LXI H,WORD$BUFFER
LXI D,LAST$WORD
MVI C,0
COMP$LOOP:
PUSH B
MOV A,M
ANI 7FH
MOV C,A
LDAX D
ANI 7FH
CMP C
POP B
JNZ COMP1
INR C
LDAX D
ORA M
INX H
INX D
ANI 80H
JNZ COMP1
DCR B
JNZ COMP$LOOP
COMP1:
; Write compression count and remaining characters to disk

```

Listing 1 continued on page 144



Boldly Go Where No Drive Has Taken You Before...

Give your APPLE II® a Fourth Dimension — the totally compatible 5¼" drive that takes your system farther, faster. With read/write electronics so advanced that reading errors are virtually eliminated. With a track zero microswitch that keeps boot and track access smooth and quiet. With the ability to read half-track software and up to 143,360 bytes on DOS 3.3®. With similar performance on DOS 3.2.1®, Pascal® or CP/M® operating systems. And, the disk enclosure mates perfectly with APPLE cabinetry.

EXTENDED WARRANTY — We offer a 12 month parts and labor warranty extension at no cost to you.

IMMEDIATE DELIVERY — Immediately available in quantity. We offer same-day shipment if your order is received by noon (PST).

\$30 FACTORY REBATE — Receive a \$30 factory rebate if the warranty card is received by us on or before August 31, 1982. See participating dealer, or call direct. Suggested Retail Price: \$419.00.

TAKE YOUR APPLE TO THE LIMIT WITH A FOURTH DIMENSION DRIVE. Ask for additional information. Dealer inquiries invited. Contact:

Fourth Dimension Systems
3100 W. Warner Avenue, #7/Dept. B
Santa Ana, CA 92704
(714) 850-1228

FOURTH DIMENSION SYSTEMS

Mastercard and Visa accepted.

MINIMUM INVESTMENT, MAXIMUM PERFORMANCE ...IN FIVE STARBYTE COMPUTERS



Starbyte ... A powerful processing board with expandable disk storage capability.

Starbyte ... Special design features enhance its operation under CP/M™.

Starbyte ... Ready to out perform any computer twice its size.

Starbyte offers power, versatility, and speed at a size and price you can afford. **Starbyte** utilizes the Zilog Z80A microprocessor family, 128K of RAM, and a Western Digital Floppy Disk Controller, all combined on a single board. To further bolster its power, **Starbyte** incorporates the Western Digital "smart" Hard Disk Controller allowing for more than 10 megabytes of storage.

Features of All Five Systems:

- 4 megahertz Z80A (no wait states)
- 128K RAM
- 2 serial ports
- 1 Centronics parallel port
- CP/M™ compatible
- Track buffer for rapid floppy access
- 5 1/4" dual-sided, double-density floppy disk drives

Individual System Features:

- Starbyte SBC I:** Includes two 96TPI 5 1/4" floppies and controller.
- Starbyte SBC II:** Includes one 96TPI 5 1/4" floppy and a 6.4 meg hard disk and controllers.
- Starbyte SBC III:** Includes one 5 1/4" 96TPI floppy and one 12.8 meg 5 1/4" hard disk with controllers.
- Starbyte SBC IV:** Includes two 96TPI slimline floppies and one 6.4 meg 5 1/4" hard disk with controllers.
- Starbyte SBC V:** Includes two 96TPI slimline floppies and one 12.8 meg 5 1/4" hard disk with controllers.

asap
computer
products, inc.

1198 E. Willow St.
Signal Hill, CA 90806
(800) 421-7701
(213) 595-6431 (714) 891-2663

ASAP COMPUTER PRODUCTS LTD.

116 Viceroy Road, D-12 Concord, Toronto, Ontario
L4K1A9 Canada (416) 738-0500 (800) 268-1936

DAYSTAR
TECHNOLOGY INC.



GOTCHA COVERED

If you're looking for computer terminal desks and work stations, CF&A has "gotcha covered". Not with just a desk or two, but with a full line of modular, integrated computer furniture. From our 24" x 26" Classic Series terminal stand to our 72" x 32" DR Series console with left or right-mounted twin RETMA enclosures...and everything in between. Like Microshelves, Datashelves, Apple or IBM desks, printer stands, media stands, turntables, returns, drawers, doors, color selections...the list goes on and on. You also get durable construction, competitive prices, quick delivery, and friendly service. Call or write for more information. We're the straight shooters. We're Computer Furniture and Accessories. We've "gotcha covered".

CF&A

**Computer Furniture and
Accessories, Inc.
515 West 132nd Street
Gardena, CA 90248
(213) 327-7710**

Listing 2 continued:

```

MAIN$READ$LOOP:
; Read remaining letters of word
  CALL GET$CHAR
SINGLE$LETTER:
  MOV M,A
  INX H
  ANI 80H
  JZ MAIN$READ$LOOP
  RET
;
DICT$BUFFER:
  DB 40
    
```

only of text do not cause much of a problem. However, most word processors include special control codes to indicate underlining, superscripting, and hyphenation. You can ignore most of these codes, but if the word processor has inserted them in the middle of a word (as with optional hyphenation points), SPELL must remove them before processing the word.

SPELL also had to be designed to ignore formatter commands. Word processors and text formatters use these codes (sometimes called dot commands) to convey information about page length, margin settings, etc. Formatting commands are usually on a line beginning with a special character, such as a period. Or, in some cases, they are bordered by special characters, such as back slashes.

I designed SPELL to read the text file formats of most of the currently available word processors and text editors. The only ones that I had any real problems with were the more advanced, such as Wordstar and Magic Wand. Wordstar has the nasty habit of setting the MSB of certain file characters. This bit controls the justification of words on a line. Clearing the bit, if set, partially solves the problem. However, when reading and altering a Wordstar document file, programmers must be careful to restore the setting of this bit before writing the altered file to disk.

Deciding what to do about hyphenated words was another challenge in designing a spelling checker. If you treat a hyphenated word as a single word, what do you do with constructs such as *state-of-the-art*? Do you add all hyphenated words to

the dictionary, even if the individual words are already there?

SPELL breaks hyphenated words into their component words except when the hyphen occurs at the end of a line of text. When that happens, it usually means that the word has been divided to fit onto the line. Divided words must be reassembled before processing. SPELL also ignores so-called soft hyphens that are inserted into words as optional hyphenation points, regardless of where they occur.

Automatic Hyphenation

My idea of a useful computer program is one that performs tasks that I find tedious. Looking up the proper place to divide a word at the end of a sentence is tedious. Several word-processor programs currently provide features to hyphenate lengthy words as they are entered, but all rely on fairly simple hyphenation algorithms that do not perform very well in practice. Adding hyphenation information to the on-line dictionary would seem to be one way of solving the hyphenation problem. After considering this solution, however, I concluded that dictionary-based hyphenation would be too slow and would greatly reduce the compression of the dictionary. I did find a very good solution in Donald Knuth's book *TEX and METAFONT: New Directions in Typesetting* (see reference 7). Knuth discusses an efficient algorithm that uses a series of rules for dividing words. The rules are supplemented by a list of words that disobey them.

The Word's hyphenation tool, called HYPHEN, which is designed around Knuth's rules, can operate in

FMS-80. THE TWO DOOR DATA BASE PLUS



Door # 1: Reports you'll use *today*.
Door # 2: The sky is the limit.

We've split the proven, best-selling FMS-80 micro data base manager into two parts. And we've split the price.

Part one (FMS-81) gives you the essential file and reporting features. You can quickly create programs with input questions a clerk can understand, and with reports a manager can use.

And FMS-81 with its new manual, is so easy to use, you'll be generating reports the first day. FMS-81 sells for \$495.

Part two (FMS-82) has all the fancy stuff. Including an Extended File Maintenance language that lets you perform virtually unlimited manipulation on up to 19 different data files simultaneously.

Using FMS-82, you or your computer dealer can make FMS-80 do *just about anything*. FMS-82 sells for \$495.

Naturally, FMS-82 is fully compatible with all the files and functions you generate with FMS-81.

FMS-81 is so useful, it might seem like you'll never need FMS-82.

But as you expand your use of computers, isn't it nice to know it's there?

The FMS family runs under CP/M, MP/M, CDOS, and Turbodos. Call or write today for a brochure detailing the extensive capabilities of the Two Door Data Base Manager, and the name of your nearest dealer.

You'll be impressed.

Systems Plus, Inc.



1120 San Antonio Road
Palo Alto, CA 94303
(415) 969-7047

a *djr* product
DJR Associates, Inc.
2 Highland Lane
North Tarrytown,
NY 10591

FMS-80, FMS-81, FMS-82
TM DJR Associates
CP/M, MP/M TM Digital Research
CDOS TM Cromemco
Turbodos TM Software 2000, Inc.

Circle 372 on Inquiry card.

BRAINS-MAINFRAMES

SUPERBRAINS



SUPERBRAIN QD 64K

List \$2995.....only \$2449



Z-89 48K
List \$2895.....only \$2099
Z-90 64K DD 3195
ONLY \$2489

COMPUSTARS

Available to Dealers

NORTH STAR

Minicomputer
Performance

Green Phosphor

Options:

Graphics + CP/M

List..... \$3,999

Only..... \$2,989

ADVANTAGE



Monitor Green Phosphor \$114

TERMINALS Z-19.....\$638
INTERTUBE III Super Smart \$710

EPSON

MX-80 FT. \$598

MX-80 \$474

MX-100 \$749

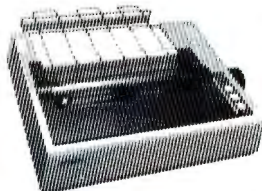

ANADEx 9501.....\$1290
NEC Letter Qual Friction & Tractor..... call
ZENITH printer Z-25 list 1595 only.....\$1256
C. Itoh F10 Letter quality\$1449



ATARI 400 List \$399.....only \$340
800 List \$899.....only \$675

Wonderful Games—Education for your family

Main Frames-S-100.....\$200 up
Advanced Micro Digital Superquad Single Board Computer
with Z80 64K and FDC..... \$749
Dual 68000 CPU S100-Super Fast—Save.....CALL

AMERICAN SQUARE COMPUTERS is organizing a World Wide Association of Computer Dealers. Open a Store or Start Work Out of Your Home! We Charge NO FRANCHISE FEE! (Our Competitors charge a FRANCHISE FEE of from \$15,000.00 to \$45,000.00.) Be a Winner! Let US help YOU get started MAKING MONEY by HELPING PEOPLE to put COMPUTERS to WORK. Write or Phone today.

TELEVIDEO TERMINALS... 910 \$518, ... 925 \$718

GODBOUT COMPUPRO

Super Sixteen 8085/8088 is the fastest combo 8/16 CPU. LIST \$3904 Special \$2873

SEATTLE'S

16 bit COMPUTER is here! 8 MHz 8086 CPU the fastest S-100 computer! 128K Static RAM, DD Disk Controller, 22-slot Main Frame, 86-DOS, #2 128K

LIST \$4185 ONLY \$3349
#1 As above but 64K LIST ... \$3190 ... ONLY 2649

CALIFORNIA COMPUTER 2210A

LIST \$1995.....ONLY \$1722
Z80, 64K, I/O, Disk controller + CP/M.

Model 302 is the larger system: 2.4 Mb 8" Z80, 64K, and optional OASIS, CP/M, or MP/M operating system.
LIST.....\$5295.....ONLY \$4674

SYSTEMS GROUP SYSTEM 2800

Runs CP/M or OASIS. Supports single user & multi-user & multi task. Up to 5 megabytes with 8" drives. Optional 10-megabyte hard disk. Optional tape back up #2812 \$5035..... ONLY \$3775

TARBELL'S

Empire I&II have two 8" disk drives. The I is single sided, the II is double sided.

FREE Business Software

Empire I LIST \$4888 Only \$3666

We sell The Finest Hardware

We sell The Finest Software

AMERICAN



COMPUTERS

919-889-4577

4167 Kivett Dr.

Jamestown, NC 27282

919-883-1105

LOWEST PRICE-BEST QUALITY

NORTH STAR Horizon 2



2-5/4" Disk Drives
64K Double Density
Factory assem. & tested
Factory guaranteed

A few left
Low Price only

\$2499

**Powerful North Star BASIC Free
Superb for Business & Science**

HORIZON STANDARD IS NOW HRZ-2-64K QUAD

Factory Assembled & Tested	List	Only
Horizon-2-64K-Quad	\$3599	\$2689
Horizon-1-64K-QHD 5.....	\$5999	\$4559
Horizon RAM ASM.....32K = \$424		64K = \$594
Big Sale on Multi-User Time-Sharing		.. call
English to Basic Translator.....		\$99
North Star Hard Disk 18 Mb.....	\$5375	\$4568
North Star Time Sharing Multi User		.. call
Zbasic 2 to 5 times faster!.....	\$350	.. call
Secretary Word Processor.....		\$99
Wordstar Word Processor.....		\$296
Floating Point Board.....	\$399	\$339
Oasis Multi-User Software.....	SAVE	.. call
CP/M for N* Extra features.....		\$230
Micro Mike Software.....	SAVE	.. call
Ecosoft Accounting MICROSTAT		\$265
Pascal-80.....	\$600	\$515
Extra Precision Basic.....		\$50
Northwood.....	\$199	\$179
Mailmanager.....	\$299	\$224
Infomanager.....	\$399	\$349
General Ledger.....	\$499	\$429
Accounts Receivable.....	\$499	\$429
Accounts Payable.....	\$499	\$429
Inventory.....	\$499	\$429
Order Entry.....	\$499	\$429
PROPAC.....	\$1499	\$1274
DOS + Basic 5.2.....		.. 27

DECISION I



"The IBM-360 on the Z-80 & S-100 BUS!"

Sixteen Programs running simultaneously! Free CPM, Microsoft BASIC and WORDSTAR with Complete system!

	LIST	ONLY
DECISION 1 + 65K Static + 8" Disks	\$4375	3377
DECISION 1 + 65K Static + 2 - " Disks	4195	3149
DECISION 1 + 65K Static + 5" Disk + 5MB Hard Disk.....	5990	4784
DECISION 1 3 user 195K Static + 5" Disk + 5Mb Hard Disk + MICRONX	8035	6428
DECISION 1—Z-80 + 1/0 = Power.....	1725	1294

MORROW 8" Disk

Discus 2D + CP/M 600K only \$834
Discus 2 + 2 + CP/M 1.2 MEGA B \$1074
Add Drives 2D = \$599 2 + 2 = \$795
Discus 2D-dual + CP/M Only \$1384
Free Microsoft BASIC from MORROW with Discus system or hard disk



M-26 MORROW Hard Disk
26,000,000 Bytes!!
List \$4495.....Only \$3394
Free CPM + BASIC
M-20 List \$4795..Only \$3835
M-10 List \$3695..Only \$2955
M-5 List \$2495..Only \$1994

InterSystems

Z-80A CPU 4 MHz
64K Dynamic RAM
Front Panel

VI/0-1 - with interrupts
FDCII Disk Controller
20 slot motherboard

List \$3795 Only \$2839

Without front panel as above only \$2716
Front Paneless Recommended for Business

Save on Memory and Programs

Systems Memory 64K A&T \$459
Systems Memory 64K Bank \$555
Microangelo \$985

Corvus Hard Disk SAVE
SSM Video BRD VB3 kit \$361
Spectrum Color ASM \$326

Cat Novation Modem \$169
Memory Merchant 16K \$159

Which Computers are Best?—FREE.
Insured Shipping at Low Rates. Call
For Latest Prices, Details. We Beat
Advertised Prices.

Factory Guarantees

Expert Advice

AMERICAN



COMPUTERS

919-889-4577

4167 Kivett Dr.

Jamestown N.C. 27282

919-883-1105

MicroShell™ conducts your CP/M™ computer with more power than ever before!

What is MicroShell?

- A normal CP/M program which adds a powerful set of commands to all programs running under CP/M.

What will MicroShell do?

- Automatic Disk and User Management - Finds your programs from another drive or user number - automatically! Save time and precious disk space.
- Powerful Redirection Capability - Send screen output to a file or printer. Send printer output to a file. Take program input from a file instead of the keyboard.
- Much More - Multiple commands on a line, more powerful and faster "submit" capability, user-definable prompt and many more features.

Dealers - MicroShell gives you:

- A user-friendly interface to the computer.
- Automatic execution of an application program at startup.
- Self-running demonstrations of your favorite software packages.

Will MicroShell run on my computer?

- Requires CP/M 2.2. Available on 8" and 5" disks (North Star, Heath, Apple-CP/M, Osborne, SuperBrain and IBM-PC w/Baby Blue).

CP/M - TM Digital Research, UNIX - TM Bell Labs, Wordstar - TM MicroPro, Baby Blue - TM Xerox, dBase - TM Ashton Tate.

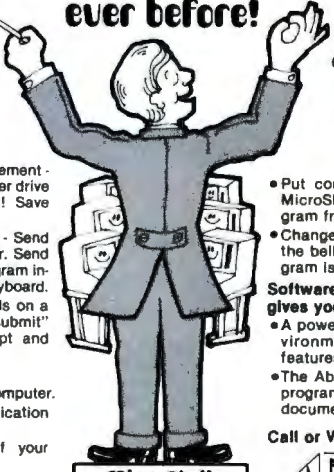

microShell

MicroShell \$150.00
Manual Only \$25.00
VISA, MC accepted
VA residents add 4%
Overseas orders add \$20.00
for air mail

Give me some examples!

- Run Wordstar or dBase II from any disk drive or user area.
- Save the screen from a program for later use or to edit into a report. Save printer output in a file.
- Put commands into a file and have MicroShell supply them to the program from the file.
- Change MicroShell's prompt to sound the bell on your terminal when a program is done!

Software Developers - MicroShell gives you:

- A powerful UNIX-like development environment for CP/M with some features that even UNIX doesn't have!
- The Ability to collect the output of a program in a file and ease the documentation chore.

Call or Write Today!



**NEW
GENERATION
SYSTEMS, inc.**

2153 Golf Course Drive
Reston, Virginia 22091
Phone: (703) 476-9143

two ways. You can use it as an on-line hyphenation dictionary, or you can have it read a file and automatically insert soft hyphens into words that exceed a specified length. When used in this way, HYPHEN is very handy for setting narrow column text such as would be needed for periodicals and newsletters. Used for on-line lookup, HYPHEN accepts words typed in at the console and prints back an acceptable hyphenation.

How a Spelling Checker Works

Now that you know about most of the problems in designing spelling checkers, let's see how they actually work. The principle is simple. First, you find a word, and then you see if it's in the dictionary. However, looking up each word as you find it in the text would be extremely slow because of the time needed to read from a floppy disk. So instead, SPELL reads the text file and builds a list of all of the file's unique words. The word *microcomputer*, for example, would be saved only once. SPELL keeps the list in memory for speedy access. After compiling the list, the program looks up each word in the dictionary. SPELL looks up words by matching them sequentially against the dictionary. Words are removed from the list when they are found in the dictionary. When the program finishes, the remaining list of words contains those suspected of being misspelled.

In designing The Word, I decided to split the entire spelling checking process into three phases: one to find the incorrect words, one to help review them, and one to fix them. A separate program handles each phase. Each program, therefore, has the greatest amount of memory available to build word lists. In addition, this modularity allows you to use the programs for other purposes. I'll describe some of these uses later.

I just described phase one, the suspect-word finder, above. The program for phase two, REVIEW, helps you review the list of suspect words. This program provides several helpful features, such as an automatic lookup that searches the dictionary to locate possible correct spellings of

PHONE 1 FILLS THE VOID IN DATA COMMUNICATION

Powerful Z-80® communications software tools are now available. Fill the void between your microcomputer and mainframe.

Z-80 is a registered trademark of Zilog.

3276-2 REMOTE CLUSTER CONTROLLER EMULATION SOFTWARE



CLEO

3740 FORMATTED DATA ENTRY SOFTWARE



KTDS

WORKSTATION EMULATOR



3780

HAND HELD ORDER ENTRY RECEIVER



HHOE



PHONE 1

1011 River Lane • Loves Park, Illinois 61111 • 815/877-9008

For top quality performance from your computer, use the flexible discs known for memory excellence. Now, buy a specially marked box of 10 Memorex® 5¼" mini flexible discs and we'll send you an additional mini disc FREE.

Features like our uniquely sealed jacket and protective hub ring make our discs last longer. And a soft inner liner cleans the ultra-smooth disc surface while in use. It all adds up to better performance and reliability.

Our proprietary high density media formulation and 100% error-free certification guarantee reliable performance in all single or double density applica-

tions. So for business, word processing, or personal computer applications, Memorex mini discs are sure to do the job. And we back them with a full year warranty to prove it.

So see your local Memorex distributor or dealer or call (800) 538-8200 (In California (408) 987-1893) today. Buy a box of 10 flexible 5¼" mini discs. Then send the coupon in the box to Memorex for your free mini disc. It's that simple.

It's a great way to improve your memory and get a big bonus in computer performance.

MEMOREX
A Burroughs Company

Improve your memory by 10%.

Dealer inquiries invited.

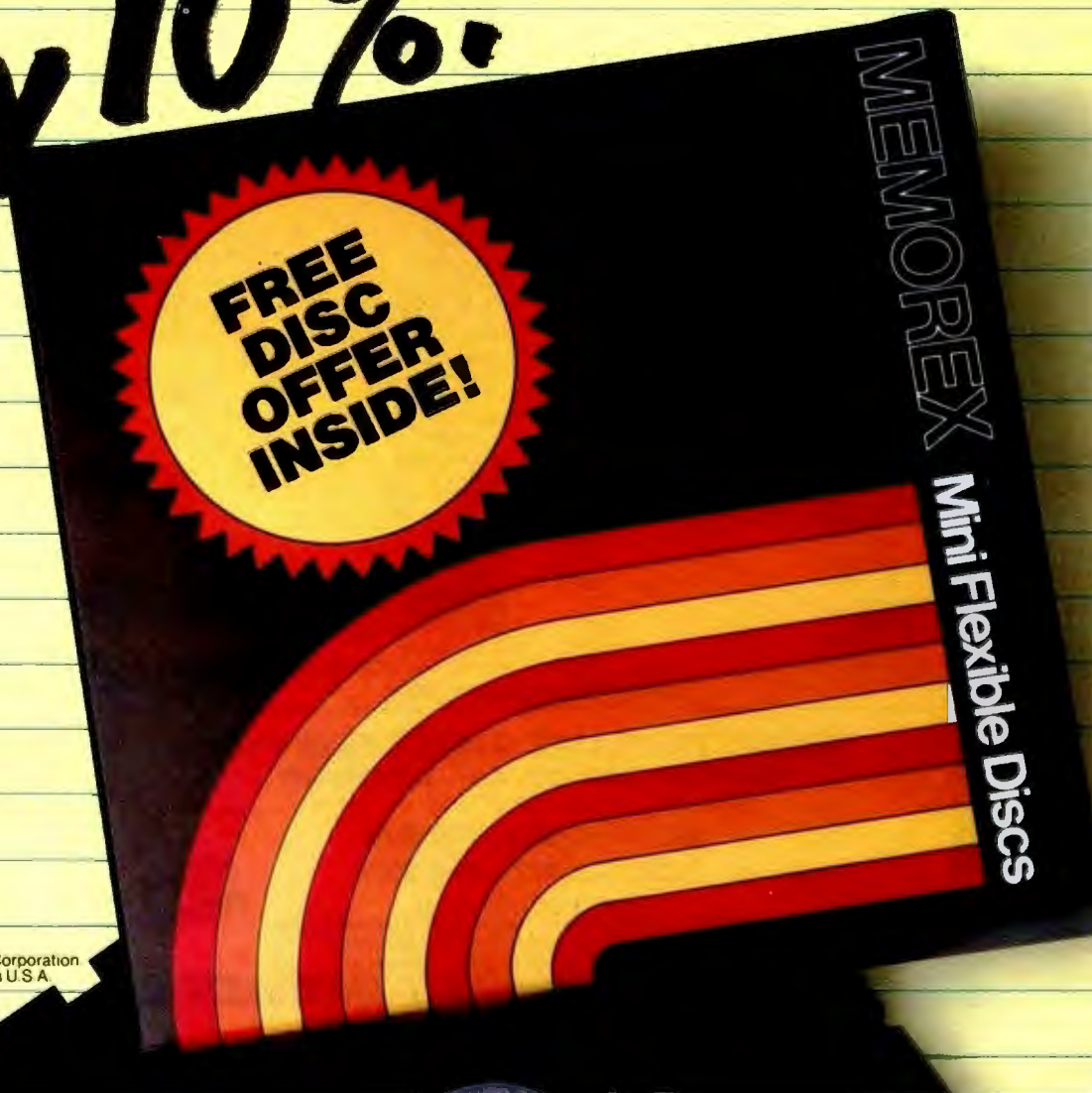

Circle 239 on inquiry card.

© 1982 Memorex Corporation
Memorex is a registered trademark of Memorex Corporation
Offer ends December 31, 1982 Offer good only in U.S.A.

CP/M® and IBM SOFTWARE

OUR MONTHLY SPECIAL

dBASE II \$479.00
and
QUICKCODE \$229.00

IBM PERSONAL SOFTWARE

WORDSTAR	279.00
MAILMERGE	89.00
CROSTALK	129.00
EASYSPELLER	139.00
EASYWRITER II	289.00
TIM III	399.00
SPELLGUARD	239.00

IN STOCK—MORE ITEMS TO COME!

ACCOUNTING PLUS®

General Ledger	
Accounts Payable	
Accounts Receivable	
Payroll	
Inventory	
Sales Order Entry	
Purchase Order Entry	
Point of Sale	
1 MODULE	\$ 400
2 MODULES	750
3 MODULES	1109
4 MODULES	1465
5 MODULES	1820
6 MODULES	2140
7 MODULES	2440
8 MODULES	2720

DIGITAL RESEARCH®

MAC	85
SID	65
ZSID	90
TEX	90
DESPOOL	45
PL/1-80	449
BT-80	175
PASCAL MT+	425
CB-80	419
CBASIC 2	110

FOX & GELLER®

Quickscreen	139
d UTIL	69

LEXISOFT®

Spellbinder	299
-------------	-----

LIFEBOAT®

T/Maker II	229
------------	-----

MICRO - AP®

S-Basic	269
Selector IV	259
Selector V	399

MICROCRRAFT®

Legal Billing	\$ 495
Time Billing	495

MICROPRO®

Wordstar	279
Mailmerge	89
Spellstar	159
Datastar	249
Calcstar	219
Supersort	199
Customization Notes	349
Wordmaster	119

MICROSOFT®

Basic 80	284
Basic Compiler	325
Fortran 80	345
Cobol 80	569
Macro 80	144
Edit 80	84
MU Math /MU Simp	219
MU Lisp/MU Star	165
M-Sort	129

PICKLES & TROUT®

CP/M	179
CP/M (Hard Disk)	259

SORCIM®

Supercalc	199
-----------	-----

DATA BASE®

FMS-80	649
CONDOR 20-I	249
CONDOR 20-II	529
CONDOR 20-III	839
CONDOR 20-R	249
CONDOR 20-Q	149

XEROX 820 ACCESSORIES®

DUAL DENSITY BOARD	395
SERIAL PRINTER DRIVER	99
SMARTERM	129
PARALLEL PRINTER SOFTWARE	99

AND MUCH MORE!

standard software

CORPORATION OF AMERICA

10 MAZZEO DRIVE, RANDOLPH, MA. 02368

617-963-7220

ORDER LINE 800-343-8420

MasterCharge, VISA, C.O.D.

3% Discount on prepayment made by check (software only)

All items subject to availability and price change

CP/M Is A Trademark Of Digital Research



suspect words. In addition, the program can display the context of the word in the original document by using information provided by SPELL in a special file. Once you know the correct spelling, you can pass it on to the next program, which will automatically correct it in the original document. If words are found that are correctly spelled, REVIEW will add them, at the press of a key, to an extension of the main dictionary.

The third program in the series corrects the mistakes in your document. MARKFIX reads in a list of misspelled words (and corrections, if supplied) and then reads the text file. Then MARKFIX either marks words in the text file that match words in the list of misspelled words by placing a special character in front of them or corrects a misspelling by replacing it with the correct spelling. When replacing a word, MARKFIX changes the capitalization of the replacement word to match the word being replaced.

MARKFIX expects to read a list of corrections from a CP/M text file in the following format:

misspelled/replacement

When used for spelling correction, the review phase produces the word list file automatically. However, MARKFIX doesn't care where it gets its list file from. This allows several really useful auxiliary applications.

Automated Rewrite

For example, say you had written a story about two characters, Jim and Mark, who live in Centerville and Smallton. After finishing the manuscript, you decide to shift the setting to Costa Rica and change the names of the characters to Raul and Julio, and the towns to Limon and Guadalupe. With most text editors, that would require many passes through the file, making it a tedious job. MARKFIX simply needs the following replacement list to get the job done.

JIM/RAUL
MARK/JULIO
CENTERVILLE/LIMON
SMALLTON/GUADALUPE

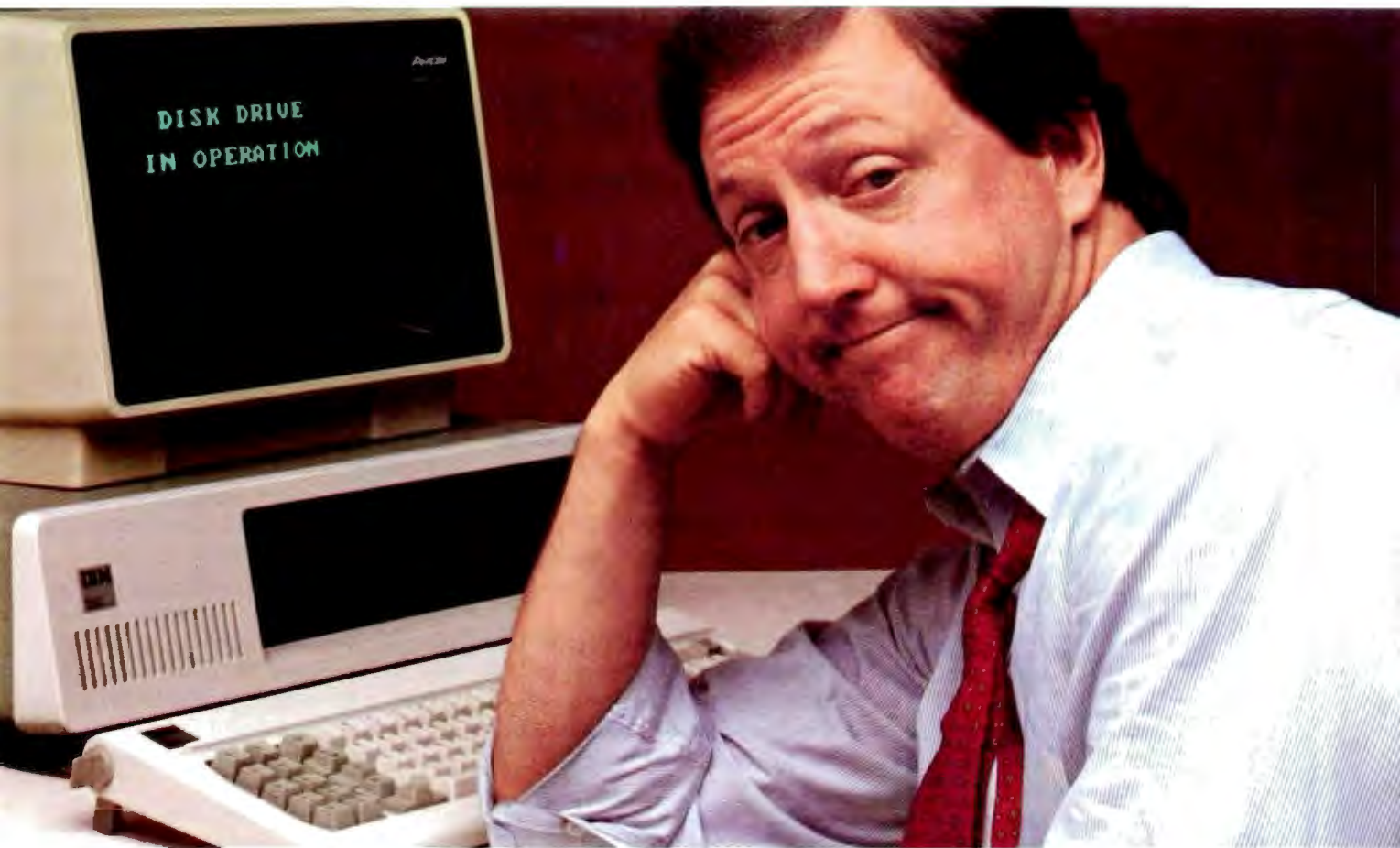

Microsoft's RAMCard™ with RAMDrive™ takes the whir, click and wait out of the IBM PC.

Solid State Disk. When you add the Microsoft™ RAMCard to your IBM® Personal Computer, you also add RAMDrive, which lets you use memory as you would normally use a disk. That gives you "disk access" that's typically 50X faster than disk. Without the whirring, clicking and waiting of mechanical data access.

Fast and easy. You simply designate a portion of memory as "disk." RAMDrive takes it from there, instructing the program to go to RAM rather than disk whenever data access is needed. The result is faster, smoother, no-wait computing.

64K to 256K. You can start small, but think big. Start with 64K and add Microsoft RAMChips™ in 64K blocks. Or, buy the full 256K now. Either way, you get both RAM and "disk" capabilities. All in a single slot.

A complete subsystem. The RAMCard package comes complete with the memory board (64K,

IBM is a registered trademark of International Business Machines Corp. Microsoft, RAMChips, RAMCard, and RAMDrive, are trademarks of Microsoft Corporation



128K, 192K or 256K), documentation, a diskette which adds RAMDrive and, a full one year warranty.

More tools for IBM. Microsoft wrote PC-DOS, the standard operating system for the IBM Personal Computer. And Microsoft is first in providing a full range of languages, applications programs and utilities for the IBM PC. The addition of RAMCard with RAMDrive is our way of saying that Microsoft will continue to offer more and better supported tools for the IBM PC.

See for yourself. Ask your Microsoft or IBM PC dealer for a demonstration of both main memory and disk features of the Microsoft RAMCard with RAMDrive. It's solid state memory you can also use like a disk. And it takes the whir, click and wait out of the IBM PC.

BETTER TOOLS FOR MICROCOMPUTERS

MICROSOFT

Microsoft Corporation
10700 Northup Way
Bellevue, WA 98004

Circle 262 on inquiry card.

INDUCTIVE COUPLED MODEM

Eliminates noise, vibration problems. Originate/Answer. Bell 103. Cassette port saves data.

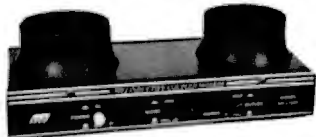

\$129.95 Money back if not delighted

MFJ-1230 INDUCTIVE COUPLED MODEM eliminates room noise, vibration caused by acoustic coupling. Gives more reliable data transfer. Used like acoustic modem. 0-300 Baud, Bell 103 compatible. Originate/answer. Half/full duplex. RS-232, TTL, CMOS compatible. Use any computer. Cassette tape ports save data. 110 VAC or 9 V batteries. Crystal controlled. Carrier detect, power LEDs. 9x1 1/2x4". **MFJ-1231, \$39.95.** Optional cable, software for Apple II, II Plus. Plugs into game port. No serial board needed.

\$99.95 **MFJ-1108 AC POWER CENTER.** Adds convenience, prevents data loss, head bounce, equipment damage. Relay latches power off during power transients. **Multi filters** isolate equipment, eliminate interaction, noise, hash. **Varistors** suppress spikes. 3 isolated, switched socket pairs. One unswitched for clock, etc. Lighted power, reset switch. Pop-out fuse. 3 wire, 6 ft. cord. 15 A/125 V, 1875 watts. Aluminum case. Black. 18x2 3/4 x2 in. **MFJ-1107, \$79.95.** Like 1108 less relay. 8 sockets. 2 unswitched. Other models available.



It's like having an extra port **\$79.95**

MFJ-1240 RS-232 TRANSFER SWITCH. Switches computer between 2 peripherals (printer, terminal, modem, etc.). Like having extra port. **Push button switches** 10 lines (pins 2,3,4,5,6,8, 11,15,17,20). Change plug or cable to substitute other lines. Push button reverses transmit/receive lines. LEDs monitor pins 2,3,4,5,6,8,20. PC board eliminates wiring, crosstalk, line interference. 3 RS-232 25 pin connectors. 7x2x6 in.

Order from MFJ and try it. If not delighted, return within 30 days for refund (less shipping).

One year unconditional guarantee.

Order yours today. Call toll free 800-647-1800. Charge VISA, MC Or mail check, money order Add \$4.00 each for shipping and handling.

CALL TOLL FREE ... 800-647-1800

Call 601 323 5869 for technical information, or der/repair status Also call 601 323 5869 out side continental USA and in Mississippi.

MFJ ENTERPRISES, INCORPORATED

921 Louisville Road, Starkville, MS 39759

MARKFIX will also preserve possessive endings of the corrected names.

MARKFIX can also rewrite something for you. Because MARKFIX can replace a word with more than a single word, you can build the following kind of replacement list:

I'LL/I WILL
I'VE/I HAVE

Consider also the potential for deflating stuffy writing by making a replacement list to change words like *utilize* to the generally better *use*. Of course, if you want to "pump up" your prose, you can also do the reverse.

All sorts of additional uses will no doubt occur to you. One suggestion I've received mentions using a tool like this to shift tone and mood in a piece of writing. Consider:

SOFT/HARSH
SOFTLY/HARSHLY
WHISPER/BLAST
WHISPERED/SHOUTED

MARKFIX's ability to mark words within a text file also offers a way of finding misused homonyms. Homonyms are words that sound alike but have different spellings. Examples are *there* and *their*, or *stationary* and *stationery*. You can compile a list of troublesome homonyms and feed it into MARKFIX, which will then mark them in your document for closer review with your text editor

Word Counting

No computerized writing system is complete without a program to count words. I use my word-counting program every time I write. I originally wrote the program for my wife, who is extremely concerned about the length of the chapters in her novels. She also uses the counting program to pace herself by setting daily word goals and writing to meet them.

A word loses its force if you use it too often. I have the habit of using the word *simply* far more than I should. I know this because of a program I wrote called WORDFREQ. It

prints a list for me of all the words I used in a particular document and shows me how often I used each word. Thus, I can use this program to help reduce the problem of overused words.

Catching Typos at the Source

Spelling checkers are great for catching typos and spelling errors. If used faithfully, these programs can help you produce virtually error-free text. Using a checker does take an extra minute or two. For short documents, such as one-paragraph letters, there is a temptation to save time and skip the spelling check altogether. Rather than try to change everyone's habits, I decided to implement a simple way to catch spelling errors as words are typed in. This program catches a lot of typos without doing a separate check. I based the technique on the trigram and digram analysis mentioned previously.

A lookup table for letter trigrams takes up only slightly over 2700 bytes. I wrote a very simple on-line checker that monitors letters typed on the keyboard, looks up trigrams, and beeps the console bell whenever an illegal combination is entered. This technique will fail to catch many misspelled words, but it will catch many common typos and also alert typists whenever they slip on the keyboard. TYPO is designed to link into a CP/M system in such a way as to be invisible to the resident text editor or word-processing software.

Punctuation Checking

There are several common writing problems that a computer can check for, such as doubled words, unbalanced quotes and parentheses, and inconsistent capitalization. I built a program called CLEANUP to indicate when these errors occur. CLEANUP is similar to MARKFIX because it indicates trouble spots in your file by placing a marking character at the site of the problem. In future revisions of CLEANUP, I want it to detect proper use of commas before conjunctions.

Words at Play

Writing the spelling checker was

COMPUTER WAREHOUSE

CALL TOLL FREE **1-800-528-1054**

ATARI

Special 32K 800 System 800 w/32K, recorder, star raiders, joysticks Above w/48K	Call Call
--	----------------------

800 (16K)	\$670
400	\$340
810 Disk Drive	\$440
825 Printer	\$590
850 Interface	\$170
410 Recorder	\$ 75
830 Modem	\$155
16K Memory	\$60
32K Memory	\$90

MOUNTAIN HARDWARE
All products..... **Call**

DISK DRIVES

Lobo
Apple 1st Drive **\$430**
Apple 2nd Drive **\$365**

Percom
Atari D/D Drives..... **Call**

PRINTERS

C. Itoh
F-10 — Parallel **Call**
F-10 — Serial **Call**
55CPS — Series **Call**
Prowriter **Call**
Tractors for star writer **\$147**

Comrex
CR-1-S **Call**
CR-1-P **Call**
CR-1-Q **Call**

Datasouth
DS 180 **\$1260**

Diablo
630 RO w/Tractors **\$2260**
630 RO wo/Tractors **\$2050**
630KSR wo/Tractors **\$2435**

Epson
MX-80 **Call**
MX-80 F/T **Call**
MX-100 **Call**

Integral Data Systems
Prism 80 **Call**
Prism 132 **Call**

NEC
PC-8023A **Call**
3510 **\$1690**
7710 **Call**
7720 **Call**

Okidata
Microline 80 **\$330**
Microline 82-A **\$455**
Microline 83-A **\$740**
Microline 84 **Call**

Tally
1805/1802 **\$1555**
1605/1602 **\$1325**

Texas Instruments
810 Basic **Call**

MONITORS

Zenith
12" Green Screen **\$115**

Amdex
Video 100 **Call**
Video 300 **Call**
Color I **Call**
Color II **Call**

Comrex
13" RGB Color **\$460**

INTERNATIONAL DEALER INQUIRIES INVITED

To celebrate
the beginning of our
3rd YEAR we are offering
FREE SHIPPING on
all U.P.S. shipments

SPECIAL WORD PROCESSING SYSTEM

Televideo 802, NEC 3510 w/ Tractors,
WordStar, CalcStar **\$4900**

VIDEO TERMINALS

Adds
Viewpoint **\$499**

Altos
Altos I **Call**

Soroc
IQ 120 **Call**
IQ 130 **Call**
IQ 135 **Call**
IQ 140 **Call**

Televideo
910 C **\$570**
912 C **\$675**
920 C **\$735**
925 C **\$730**
950 C **\$915**

Zenith
Z-19 **\$680**

DISKETTES

Elephant
5 1/4" 0. Sector (100)..... **\$215**

Maxell
5 1/4" 0. or 10. Sector
(100) **\$300**
8" 0. Sector (100) **\$370**

SOFTWARE

WordStar **\$295**
Mailmerge **\$100**
SpellStar **\$160**
DataStar **\$240**
CalcStar **\$220**

COMPUTERS

Altos
ACS 8000-15 **\$3850**
ACS 8000-2
w/CPM* **\$2650**
Series 15D **Call**
Series 5-5D **Call**

Alspa
ACI-1 **Call**
ACI-2 **Call**

**California Computer
Systems**..... **Call**

IBM
Personal Computer **Call**

NEC **Call**

Northstar
Advantage **Call**
Horizon II 64K QD **\$2625**

Televideo Systems
TS-802 **Call**
TS-802H **Call**

Zenith
Z-90 64K w/CPM* **\$2385**

Dynabyte **Call**
Sanyo **Call**

MODEMS

Novation
CAT **\$140**
D-CAT **\$155**
Apple Cat II **\$349**
Auto Cat **\$235**



2222 E. Indian School Rd. • Phoenix, Arizona 85016

Order Line: 1-800-528-1054

Other Information: 602-954-6109

Store Hours: Mon.-Fri. 10-5 MST Saturday 9-1 MST

Prices reflect 3% cash discount. Product shipped
in factory cartons with manufacturers warranty.

Personal checks will delay shipping two weeks
Prices & availability subject to change without notice



"DISCOUNT PRICING ON QUALITY PRODUCTS"



ORDER TOLL-FREE! 1-800-854-2833

NEW SUPER VIC



CALL

16K RAM
40 Col. Output

HARDWARE

Vic Datasette	64
Vic Disk Drive	489
Vic Graphic Printer	329
Vic 8K Memory Expander	49
Vic 16K Memory Expander	99
Vic 24K Memory Expander	179
Vic Modem	99
3 Slot Expansion (Mini-Mother)	59
RS232C Terminal Interface	43
IEEE-488 Interface	84
Super Expander	49
Programmers Aid Cartridge	44
Vic Mon	43
Programmers Reference Guide	14
Introduction to Basic Programming	18
Vic Term	9
Prog Charc Set Game Ed	11
Joysticks/Paddles (pair)	4
Reference Card	12
Monitor Cables	12
PROM Simulator	199
40/80 Col Card	199
Epson MX-70 (Configured for Vic)	CALL

CALL FOR FREE CATALOG

COMMODORE CBM 8032

HARDWARE

\$995

4016 Pet	739
4032 Pet	949
Super Pet	1489
CBM 8032	1095
CBM 8096	1395
4022 Dot Matrix Printer	589
4040 Dual Disk Drives	939
8050 Dual Disk Drives (1 meg)	1248
8250 Dual Disk Drives (2 meg)	1650
2031 Single Disk Drive	489
8300P Letter Quality Printer	1599
8023 136 Col Dot Matrix	699
8096 64K Mem Board (CBM)	379
C2 N Recorder	65
The Soft Box by SSE Run CP/M!	795
Smart Modem by Hayes	CALL
D9090 Winchester Hard Disk (7.5 MB)	2699
D9060 Winchester Hard Disk (5.0 MB)	2195

CALL FOR LATEST PRODUCTS

SOFTWARE

Software Encyclopedia	9
TCL Pascal Version 1.6	139
Assembler Development	79
Integer Basic Compiler	119
CMAR Record Handler	109
UCSD Pascal (without board)	139
Petspeed BASIC Compiler	219
OZ2-8050	299
OZ2-4040	259
Wordcraft 80	286
Wordcraft 40-9	219
Wordcraft 40-12	219
Wordcraft 8096	296
Professional Tax Prep Sys	599
Personal Tax Calc	55
Professional Tax (Off-season)	219
Professional Tax Update	369
Dow Jones PMS (80 col RS232)	119
BPI A/R	299
BPI General Ledger	299
BPI Job Cost	299
BPI Inventory	299
BPI Payroll	299
Legal Time Accounting	449
Medical Acc System	449
Atlas 1200 Service & Mainten	453
Titan Job Cost System	448
Freight Rating and Invoice	448
I.R.M.A.	379

VIC 20

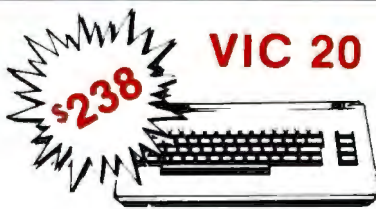

\$238

SOFTWARE ON CARTRIDGE

Spiderman	36
Robot Blasters	30
Meteor Run	36
Sattelites & Meteors	36
Amok	29
Alien Blitz	29
Renaissance (Othello)	36
Aline	19
Cosmic Kamakazi	19
Vic Avengers	21
Super Slot	21
Super Alien	19
Super Lander	21
Draw Poker	20
Midnight Drive	21

NEW

Radar Rat Race	23
Adventure Land Adventure	29
Pirate Cove Adventure	29
Mission Impossible Adventure	29
The Count Adventure	29
Voodoo Castle Adventure	29
Sargon II (Chess)	33

ON TAPE

Star Wars	11
Vic Term A	15
Vi Calc	11
Vi Check	18
Vi Cat	18
Amok	14
Alien Blitz	18
Sky Math	11
Space Division	11
Vic Math Improvement (Grades 1-6)	49
Globber	18
B-1 Nuclear Bomber	12
Blastoids**	14
Nuke War	13
Planet Miners	12
Lords of Karma	15
Vic Games (3 on 1)	19
Household Finance Pack (4 on 2)	26
Home Inventory (2 Programs on 1 Tape)	12
Recreational/Educational Pack I (2 on 1)	12
Recreational/Educational Pack II (2 on 1)	12
Car Cost (2 on 1)	12
*Needs 3K **Needs 8K	

COMMODORE 64

NOW SHIPPING \$479

The Commodore 64 is a compact unit (will fit into briefcase). Full size typewriter keyboard, high res. color, this computer is the major breakthrough you've been waiting for.

- 64K Built in RAM • CP/M option
- Upper/lower case • Graphics characters
- TV interface • Music synthesizer
- 40 col. color display • "Smart" peripherals
- Cartridge game slot

The Commodore 64 can use the VIC or CBM/Pet Accessories.

Hewlett Packard



- Computers
- Plotters
- Calculators

Call For Prices



ACCESSORIES APPARAT

Prom Blaster	129
Clock Calendar	109
Combo Card	239

AST

MC-064 SP (64K Combo Card)	469
MC-128 SP (128K Combo Card)	639
MC-192 SP (192K Combo Card)	799
MC-256 SP (256K Combo Card)	979

(All Above Include Asynch & Parallel Ports)

64K Mem	335	192K Mem	669
128K Mem	499	256K Mem	799

CHRISLIN INDUSTRIES

192K Mem Board	629
256K Mem Board	689
512K (with Serial RS232)	995

DAVONG

DSI-501 SMB Winchester Drive	1595
DSI-64K Mem Card	CALL
DSI 192K Mem Card	CALL
DSI 256K Mem Card	CALL

MACROLINK

64K Memory Card	369
128K Memory Card	519
192K Memory Card	659
256K Memory Card	729

QUADRAM

Quadboard 64K	495
Quadboard 256K	795

(Quadboard includes memory, clock/calendar

Parallel Printer I O. Asynch RS232)	
Parallel Interface Card (8 Cable)	129
Time Clock (Clock/Calendar W Software)	129

SEATTLE COMPUTER

64K Ram + Board	389
128K Ram + Board	539
192K Ram + Board	689
256K Ram + Board	799

(All Ram + Boards Include RS-232 Serial Port)

TANDON

TM 100-1 5 1/4" Floppy Drive	CALL
------------------------------	------

TECMAR

Expansion Chassis (Incl Adapters & Cable)	789
Time Master	85
Device Tender	159
Device Master	194
Winchester Drive, Controller & Assem	2595
Scribe Tender	169
Scribe Master	335
Speech Master	329
Protozoa	69

XEDEX

Baby Blue	599
Run CP/M-80!	

MONITORS & MISC.

Amdek Color II	769
Electro Home RGB	CALL
Joystick	47
Modems	CALL

SOFTWARE

Everest Explorer by Acorn	17
Money Manager by Acorn	29
CP/M-86 by CompuView	299
Vedit by CompuView	123
VCOM by CompuView	69
Fastscreen by CompuView	73
JANUS-86 by CompuView	CALL
Write On by Datamost	99
Super Calc by Sorcim	219
CP/M 86 by Digital Research	279
The Organizer by Conceptual Instr	209
C Basic by Digital Research	259
Software from Digital Marketing	CALL
Zork I, Zork II by Infocom	29
Deadline by Infocom	39
Easy Writer II by IUS	289
Easy Speller by IUS	158
Easy Filer by IUS	349
Volks Writer by Lifetree	149
Basic-80 by Microsoft	297
Basic Compiler by Microsoft	335
Fortran-80 by Microsoft	419
M-Sort by Microsoft	159
Easy by Denver Software	569
Home Accounting by Continental	129
Visicalc (Std) by Visicorp	169
Visicalc (256K) by Visicorp	199
Mathematic by ISM	69
Total Info Management by Innovative	389
Logon by Ferox	129

You don't have to join a club and pay dues for a comprehensive catalog of IBM P/C Accessories and Software — ours is FREE!

BASIS 108

The Alternative

CALL!

- 6502 and Z80 Microprocessors
- 64K RAM, expandable to 128K
- RGB and Composite Video Output
- Selectable 80 or 40 column text display
- High Resolution Graphics: 6 colors, 280x192 or 280x160 with four lines of text
- 8 bit Parallel I/O • RS-232c Serial I/O
- Detached Keyboard: All standard keyboard functions, Upper/Lower case characters, Numeric keypad, Cursor block, and 15 Programmable special function keys
- Built-in mounting for two 5 1/4 inch floppy disk drives
- Six Apple compatible slots for plug-in peripherals • Game paddle I/O

SOFTWARE

Bus Pkgs by Continental	199 ea
DB Master by Stoneware	169
Desktop Plan by Visicorp	189
Home Money Minder by Continental	CALL
Magic Window by Art-Sci	88
Peach Tree Accting Pkgs	CALL
Personal Filing System	95
Screen Writer II (formerly Super Scribe II)	99
TASC by Microsoft	159
The Last One	449
Visifile	199
Visicalc	189
Visidex	189
Visischedule	239
Visitrend/Visiplot	199

Entertainment

Alkemstone	34
Apple Panic	24
Castle Wolfenstein	24
Gorgon	35
Olympic Decathlon	24
Time Zone	79
Softporn	29
Complete Selection in Stock	CALL

CALL!

FOR COMPLETE SELECTION

FRANKLIN CALL! ACE 100

NEC

PC-8001A
32K



CALL!

PC-8001 A
NEC I/O Unit
NEC add on Dual Drive
NEC Green Screen

Call For
Total System
Price and
SAVE!!!

Call for Bill Jones and ask Bill for a free NEC catalog... and the lowest prices possible.

ATARI 800 16K \$669

Atari 400 w/16K (Mem. Expanders Avail.) 319
410 Disk Drive 439
850 Interface 159

We offer a huge selection of software (the latest) and hardware (the greatest). Call toll free and receive our full product catalog just for your Atari!



PLUS 48K

FOURTH DISK DRIVE
WITH CONTROLLER

\$1758



ACCESSORIES

(Note: The hardware and software listed here is compatible with Apple, Basis 108, and the Franklin ACE-100).

Disk Drive W Cntr by Fourth	CALL
Disk Drive W. O by Fourth	CALL
Videoterm by Videx	259
Z-80 Card by Microsoft	249
16K Card by Microsoft	119
AIO II by SSM	189
CCS Multifunction	159
Micro Sci Drives	CALL
Rana Sys Drives	CALL
32K by Saturn	189
Numeric Keypad (23 Key)	119
Signalman Modem	79
Micro Modem II	288
Soooper Spooler	CALL
RGB Card	159
Enhancer II	124
Metacard	895
Joystick by T G	46
App-L-Cache 256K	CALL
Versacard	169
Vista Vision 80	CALL
Vista 8" Drives/Cntrls	CALL
In Fone by Novation	CALL
Microbuffer II 16K	199
Microbuffer II 32K	239
The Mill by Stellation	319
Expansion Chassis by Mtn	559
Chronograph* by Hayes	190
Keyboard Enhancer II by Videx	124
Microbuffer II by Practical Peripherals	CALL
32K RAM (incl. Software) by Saturn	209
Lowercase for Apple	29
Numeric Keypad (23 Key) by Keyboard	119
Sup R Mod (TV Interface)	35
Music System W. Software by Mtn Hardware	299
Expansion Chassis by Mtn Hardware	559
The Clock by Mtn Hardware	219
D-Cat Modem by Novation	169
Corvus Hard Disk	CALL
Corvus Mirror	CALL
A/D + D/A (no cable) by Mtn	269
Supertalker SD200 by Mtn	154
8" Disk Controller by SVA	199
The Grappler by Orange Micro	124
Versawriter Digitizer	209

*APPLE IS A REGISTERED TRADEMARK.



16K RAM CARD
2 YEAR WARRANTY
LANGUAGE COMPATIBLE
JUST \$79⁰⁰

PARALLEL INTERFACE CARD
GREAT FOR EPSON AND OTHER GRAPHIC PRINTERS
2 YEAR WARRANTY
INCLUDES CABLE
ONLY \$69

Z-CARD \$789
YOUR KEY TO CP/M
Advanced Logic Systems

5 1/4" DISKS
SINGLE SIDED
DOUBLE DENSITY
2 YR. WARRANTY
INCLUDES LIBRARY CASE!
NOW \$35

FREE SHIPPING
(with prepaid cash orders)

ORDER TOLL FREE! 1-800-854-2833

PRINTERS in stock MAJOR BRANDS

CALL FOR BEST PRICE & FAST SERVICE

C. ITOH PROWRITER	
120 CPS F/T	479
NEC 8023A	489
TRANSTAR 140	
DAISY WHEEL	1350
40 CPS 132 COL	
IDS PRISM	
80 OR 132	CALL

- OKIDATA • QUME •
- ANADIX • DIABLO •

Epson MX-100
MX-80 F/T
MX-80
with new graphics

COMPUTER



SPECIALTIES

FREE CATALOGUE CALL

TO ORDER Phone orders invited using Visa, MasterCard or bank wire transfers. Visa and MC service charge of 2%. Mail orders may send charge card number (include expiration date), cashiers check, money order, or personal check (allow 10 business days for personal or company checks to clear). Please add 3% (\$5.00 minimum) for UPS shipping, handling, and insurance. APO and FPO include 5% (\$7.00 minimum) for postage. Calif. residents add 8% sales tax. Please include phone number on all orders.

FOREIGN ORDERS include 1% handling — shipped air FREIGHT COLLECT only. Credit cards not accepted on foreign orders. All equipment is in factory cartons with manufacturer warranty. Opened products not returnable. Restocking fee for returned merchandise. Equipment subject to price change and availability. Retail prices differ from mail order prices. WE SHIP THE SAME DAY ON MOST ORDERS!
*Excludes certain printers & monitors & foreign orders.

MAIL TO: 1251 BROADWAY EL CAJON, CA. 92021 (714) 579-0330

Circle 101 on Inquiry card.



What does the Oryx, an African antelope, have in common with reliable service? They are both almost extinct. Oryx Software wants to bring trustworthy service back to life. We're here to stay.

GUARANTEED LOWEST PRICES!
We will match any advertised price.
Just show us the ad.

ORDER TOLL FREE - Outside WI
1-800-826-1589

ACCESSORIES

Mountain Expansion Chassis	625.
CPS Multifunction	199.
100,000 Day Clock	375.
Mountain Clock	252.
A/D + D/A	299.
CCS 12K ROM/PROM Board	99.
CCS A/D Converter Board	99.
CCS Serial Asynch. Board	139.
CCS Calendar/Clock Board	99.
VOTRAX Type-n-Talk	375.
ABT Pascal Tools I or II	75.
Scitronic Remote Controller	249.
Apple Speed Controller	69.
Applescope (your Apple as an Oscilloscope)	595.
Scope Driver	49.
Vidax Enhancer II	149.
K & D Enhancer	115.
Vidax Character Sets	29.
Echo Speech Synthesizer	225.
Upper/Lower Character	39.
ALS Smarterm	379.
ALS Z-Card	269.
SSM A10 s/p interface + cable	195.
Percom Doubler II	167.

PRINTERS

Epson MX 80 W/Graph Trax	495.
MX 80 F/T	615.
MX 100	CALL
NEC 8023A	515.
Okidata 82A	535.
83A	785.
84	CALL

MONITORS

Amdek 300 Hi Res Green	198.
Color II Hi Res	CALL
NEC JB 1201M, 12" Hi Res Green	215.
JC 1201M, 12" Lo Res Color	349.
Sanyo 12" Hi Res Green	275.
13" Color w/Sound	CALL
KAGA Green-Insol	172.

MODEMS

Hayes Smartmodem	225.
Chronograph	198.
Micromodem	295.

DISK DRIVES

	CALL
--	------

... AND MANY MORE!

Prices valid for stock on hand and subject to change without notice.

Write for our **NEW**
FREE catalog.

For **Software**
see our other ad, page 350

Please:

- Wisconsin residents - add 5% sales tax
- Add \$2.50 for shipping per software and small item. Call regarding others.

We Welcome:

- Visa, Mastercard - (Add 5%)
- Checks (Allow 1-2 weeks for clearing)
- CDD (Add \$1.50 per shipment)

ORDER TOLL FREE - Outside WI
1-800-826-1589

For Technical Info & in Wisconsin:

715-848-2322

Oryx Software

205 Scott St., Dept. BB
P.O. Box 1961 • Wausau, WI 54401



tedious at times. To distract myself, I wrote several programs that use the spelling checker's dictionary in unusual ways.

The first such program is called FIND. FIND lets you search the dictionary for words that match what I call word patterns. For example, if you want to find a five-letter word that starts with *s* and ends in *ed*, you would give FIND the pattern "S?7ED". Later I extended the program to allow the asterisk character to cause a match of one or more letters. With this feature you can give FIND a pattern that can locate rhyming words. An example is "*ING", which will print all words ending in *ing*.

FIND was so much fun that I decided to write more programs to use the dictionary. LOOKUP helps creative spellers look up the correct spelling for words they can *almost* spell. Inspired by several "misspellers' dictionaries," in which words are looked up by their most common misspellings, I designed LOOKUP to find words in the dictionary that are *close in* spelling to the word entered. People tend to misspell words according to four "rules." They get one letter wrong, leave out a needed letter, add a letter they don't need, or reverse two letters. Applying these rules in reverse, LOOKUP can usually locate the correct spelling of commonly misspelled words. LOOKUP proved so useful that I added it to the word-review part of the spelling checker to assist in correcting misspelled words.

More recently, I added a new program to the collection that can solve *anagrams* (sometimes called word jumbles). An anagram is a word that is made from exactly the same letters as some other word. For example, *star*, *arts*, and *rats* are all anagrams of one another. The program also makes sensible words out of jumbles of letters and can be used to solve cartoon puzzles that you can find in many newspapers.

Making Your Writing Easier to Read

If you want to write something that

reads easily, there are several guidelines you should follow. Don't use big words, and don't write long rambling sentences. If you write user's manuals or instructions for repairs, these rules become even more crucial. After all, you're writing to be understood, not to impress someone with your vocabulary.

"Readability formulas" are useful ways to check up on just how easy your writing is to read. To calculate a "readability index," you need to select several samples of text from your document. Then count the length of the sentences, number of syllables, etc., and plug these values into a formula.

Most readability formulas will yield a value that is supposed to show what grade level of education a person would need to understand your writing. However, there are a few pitfalls in getting meaningful results from these formulas. Most of the formulas work best on certain kinds of writing. For example, many produce scores that discourage the use of words with many syllables. The idea is to reduce the number of words that might not be understood by the reader. In most technical writing, however, there are many long words that are commonly used and easily understood.

A second problem is the temptation to take the results of the analysis too literally. Because the formulas try to encourage short words and short sentences, you can easily fool them by arbitrarily chopping sentences and blindly substituting short words for long ones. Obviously, this will result in good readability scores but meaningless writing.

Despite these limitations, a program to read text and compute readability scores can be useful. My program ANALYZE will read a text file as input and print a variety of statistics such as average sentence length, length of longest and shortest sentences, total number of sentences in file, average syllables per word, etc. In addition, the program calculates and prints readability indexes using several formulas. If you are interested in more information



.001 Second From Wallstreet

Now, a terminal in western Kansas is no more than a micro-second from the data of Wall Street or the Commodities Exchange.

Now, an advanced data communications system allows your CP/M[®] based computer system to access almost any dial-up computer, capture and store the received data, and transfer files between any two CP/M[®] systems — even when disk formats are incompatible.

What would you call a system like this?

CROSSTALK[™]

What Crosstalk can do for you depends mostly on what you need done. It acts as a "smart terminal," automatically dialing any dial-up system. It allows you total modem control, changing modem speed, data word format and duplex instantly. It captures on-line data for analysis off-line, saving time and money. It transfers any type of file with complete error checking.

When you equip more than one office with Crosstalk, you can exchange information instantly by phone, even if you don't subscribe to an information utilities service.

So no matter where your office is located, Crosstalk can give you access to the world, instantly. Call or write for details.

NOW AVAILABLE FOR IBM PC



Microstuf, Inc.
1900 Leland Dr., Suite 12
Marietta, GA 30067
(404)952-0267

DEALER INQUIRES WELCOME

CROSSTALK is a trademark of Microstuf, Inc.

CP/M is a registered trademark of Digital Research Inc.

JULY SPECIAL SALE ON PREPAID ORDERS
 (CHARGE CARDS, C.O.D. OR P.O.'S NOT AVAILABLE)
MUST MENTION AD FOR SPECIAL PRICES
EXPANSION KIT FOR SSM PB-1 BY EXTEK PROGRAMS
 2732, 2732 A & 2764 CP/M SOFTWARE DISC
 INCLUDED.
 KIT \$105.95, A & T \$119.95



CALIFORNIA COMPUTER SYSTEMS

\$100

2032 32K STATIC RAM A & T 200 NSEC	\$468.00
2065 64K DYNAMIC RAM A & T	\$351.00
2200 S-100 MAIN FRAM A & T	\$500.00
2422A FLOPPY DISC WITH CP/M 2.2"	\$329.95
2810A Z80 CPU A & T	\$249.95
2710A 4 SERIAL 1/0 A & T	\$291.95
2710A 2 SERIAL, 2 PARALLEL A & T	\$305.95
2720A 4 PARALLEL A & T	\$214.95
PROTO BOARDS WW	\$39.95

APPLE PRODUCTS

7114A 12K ROM/PROM	\$99.95
7424A CALENDAR/CLOCK	\$106.95
7440A PROGRAMMABLE TIMER	\$98.50
7470A A TO D CONVERTER	\$105.95
7480A GPIB (IE 488) INTERFACE	\$182.00
7710A ASYNC SERIAL	\$125.95
7712A SYNC SERIAL	\$153.95
7720A PARALLEL STANDARD	\$105.00
7720B PARALLEL CENTRONICS	\$105.00
7811B ARITHMETIC PROCESSOR W/DISC	\$342.95
7811C ARITHMETIC PROCESSOR W/ROM	\$342.95
7520A EXTENDER	\$23.50
7300A APPLE CLIP	\$8.00



MICROCOMPUTER PRODUCTS

\$100 PRODUCTS

CB-2 280 PROCESSOR BOARD	
KIT	\$198.95, A & T \$269.95
VDIC 64 x 16 VIDEO, PCBD	\$32.95
KIT	\$153.95, A & T \$199.95
VB3 80 CHARACTER VIDEO 4MHZ	
KIT	\$345.95, A & T \$425.95
104 2 PARALLEL 2 SERIAL, PCBD	\$32.95
KIT	\$155.95, A & T \$194.95
PB-1 2708, 2716 PROGRAMMER BOARD	
KIT	\$135.95, A & T \$185.95

APPLE PRODUCTS

A10 - II SERIAL/PARALLEL INTERFACE	
A & T	\$178.00
A10 SERIAL I/O	
A & T	\$97.95
A10 PARALLEL I/O W/O CABLES	
A & T	\$87.95

WMC inc. WAMECO INC.

BOARDS WITH MIKOS PARTS

MEM-3 32K STATIC RAM, PCBD	\$36.95
KIT LESS RAM	\$95.95, A & T \$135.95
CPU-2 Z80 PROCESSOR PCBD	\$32.95
KIT LESS ROM	\$109.95, A & T \$149.95
CRT-1 16 OR 24 x 80 VIDEO BOARD, PCBD	\$38.95
KIT	\$249.95, A & T \$299.95
FPB-1 FRONT PANEL, PCBD	\$48.50
KIT	\$144.95, A & T \$184.95
MEM-4 65K RAM/ROM BOARD, PCBD	\$38.95
KIT LESS MEMORY	\$99.95, A & T LESS MEMORY \$129.95

MIKOS

MONDAY-FRIDAY, 8 00 TO 12 00, 1 00 TO 5 30

THURSDAYS, 8 00 TO 9 00 P M

(415) 728-9121

P.O. BOX 955 • EL GRANADA, CA 94018

PLEASE SEND FOR IC XISTOR AND COMPUTER PARTS LIST
 VISA or MASTERCARD Send account number interbank number
 expiration date and sign your order Approx postage will be added
 Orders with check or money order will be sent post paid in U S If you are
 not a regular customer please use charge cashier's check or postal
 money order Otherwise there will be a two-week delay for checks to
 clear Calif residents add 6% tax Money back 30-day guarantee We
 cannot accept returned IC's that have been soldered to Prices subject to
 change without notice \$20.00 minimum order \$2.00 service charge on
 orders less than \$20.00

about specific readability formulas, I suggest you see references 3, 4, and 5.

Counting the Words in a Sentence

Calculating a readability score requires first that you know the number of sentences and syllables in your text. At first glance, writing a program to count the number of words in a sentence seems easy. Just start counting words until you find a period, question mark, or exclamation point. However, what about the other uses for a period? Consider what to do about abbreviations like Mr., Mrs., or Ms. What about sentences like the preceding one that end in an abbreviation? Looking to see if the next word is capitalized can sometimes help but not always: for instance, "I know a man named Mr. Smith." Also, any analysis should exclude pieces of text that are not part of a sentence (such as a section heading).

I wanted to understand and conquer this problem because I knew it would pop up in any type of text analysis. I didn't find a perfect solution, but the one I use works satisfactorily. It's based upon work done for The Writer's Workbench (see reference 1). Words that are followed by a period are checked against a small dictionary containing common abbreviations. When an abbreviation is found, the next word is checked for capitalization. If the first letter is lowercase, the program ignores the period. Otherwise, the word is checked against a list of function words (i.e., the, when, etc.). If the word is not found in the list, the program ignores the period. Periods embedded within digits (i.e., \$200.00) are ignored, as are isolated periods and the extra periods in ellipses.

Counting Syllables

I tried several methods other people had developed for counting syllables and wasn't completely satisfied with any of them. The best was suggested by Richard Parry in an article "Minding Your P's and Q's" (see reference 9), which is about writing a readability analyzer in BASIC. Using Parry's technique, the program first isolates words from the text, then

counts the number of vowels (plus the pseudovowel y) that are separated by a consonant. It also counts double vowels, as in *read*, only once and ignores the trailing e in words such as *since*, *force*, and *nice*. I extended Mr. Parry's work by counting the e in words that end in *le* if the letter before the l is not a vowel. This catches the ending syllable in words such as *sample* and *babble* but does not count an ending syllable in *agile* or *console*.

Analyzing Writing Styles

OK! You spell perfectly, even Strunk and White couldn't improve your punctuation, and the readability analyzer says you're writing at just the right level. But people still say your writing puts them to sleep. What's wrong? Can your computer help?

Revising Prose (see reference 8) is a remarkable book about how to restore body and substance to limp, lifeless writing. Written by Richard A. Lanham, it presents a relatively simple way of identifying what's wrong and how to fix it. In addition, most of Lanham's techniques fit easily into computerized analysis.

Lanham's book rebels against what he labels "The Official Style." If you've ever read documents produced by bureaucrats, you'll probably recognize the problem. In modern government, no one wants to take responsibility for anything. This results in a peculiar style of writing that has become so popular that many people don't recognize it for what it is—evasive double-talk. Worse yet, many people have adopted it as the way in which documents *must* be written.

Bureaucrats don't write, "We must fix this problem." They write, "It has been determined that effective utilization of our resources will require allocation of manpower to the target problem area." This bloated style of writing stems from overuse of passive verbs and prepositional phrases.

With sentences written in the passive voice, you can't tell who is doing what to whom. Instead of saying, "I did this," you say, "It was done." In scientific and technical writing, many people believe that writing in the pas-

S-100 STATIC MEMORY BREAKTHROUGH

MAKE YOUR NEXT PURCHASE
AN UNFORGETTABLE ONE!



16K STATIC RAM \$169

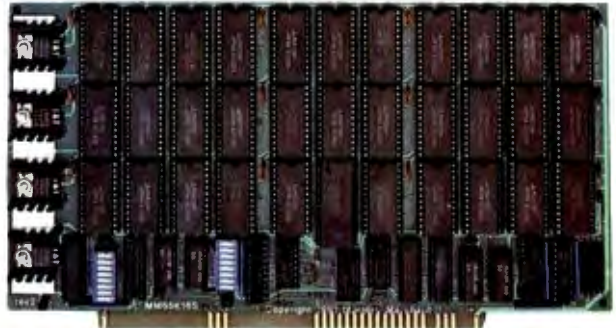

64K STATIC RAM \$795

32K PARTIALLY POPULATED \$479 48K PARTIALLY POPULATED \$669

Finally, you can buy state-of-the-art S-100 static memory for your computer at unprecedented savings.

Memory Merchant's memory boards provide the advanced features, quality and reliability you need for the kind of operational performance demanded by new high-speed processors.

COMPLETELY ASSEMBLED

These memory boards are not kits, nor skeletons—but top quality, high performance memories that are shipped to you completely assembled, burned-in, socketed, tested and insured with one of the industry's best warranties.

SUPERIOR DESIGN & QUALITY

Memory Merchant's boards are created by a designer, well-known for his proven ability in advanced, cost-efficient memory design. Innovative circuitry provides you with highly desired features and incredible versatility.

Only first quality components are used throughout, and each board is rigorously tested to assure perfect and dependable performance.

SHIPPED DIRECT FROM STOCK

All Memory Merchant's boards are shipped direct from stock, normally within 48 hours of receipt of your order.

NO RISK TRIAL

We are so convinced that you will be absolutely delighted with our boards that we extend a no risk trial offer. After purchasing one of our boards, you may return it (intact) for any reason within 15 days after shipment and we will refund the purchase price.

NEW 18 MONTH LIMITED WARRANTY!

The reliability of our boards, through quality controlled production and proven performance, has enabled us to extend our warranty to a full 18 months. This includes a 6 month exchange program for defective units.

HOW TO ORDER

Please send check, money order, VISA or MASTERCARD (add ICA#) with your order. Sorry, no C.O.D.'s. Specify model number, and quantity desired. Shipping and handling charge is \$5.00 per board. California residents add 6% Sales Tax. Credit card purchases may be telephoned to (415) 483-1008.

OEM and DEALER Inquiries Invited.



14666 Doolittle Drive
San Leandro, CA 94577
(415) 483-1008

64K RAM, Model MM65K16S

Cool running operation to 10 MHz
Ultra low-power consumption
Fully loaded 64K board draws:
Typ. 350 Ma. (Max. current 550 Ma.)

Bank Select Capability

Extended Addressing Capability

One 16K submodule equipped with a 2K window which may be located in any of the 2K segments

2716 (5V) EPROM Compatibility:
Programmed 2716 EPROM's may replace any or all of the RAM

Four independently addressable 16K submodules on one board organized as two pair of independent 32K banks or as one 64K Extended Address Page. Each 32K bank responds independently to phantom.

Bank Select logic is compatible with either Cromemco Cromix* or standard Bank Select software.

*Cromix is a trademark of Cromemco.

New 16K (2K X 8) 150ns Static RAM
Runs on any S-100, 8-bit system
MPM Conversion Option: Write for details.

16K RAM, Model MM16K14

Bank Select Capability

Extended Addressing Capability

One 4K segment equipped with 1K windows

Four independent 4K X 8 byte segments

Uses field proven 2114 (1K X 4)

Low-power consumption (Typ. 1.3 Amps)

Runs on any S-100 8080, 4 MHz Z-80 or 5 MHz 8085 system.

Prices, terms, specifications subject to change without notice.

Circle 240 on inquiry card.

LET YOUR FINGERS DO THE TALKING!

DON'T TYPE IT IN FROM THE KEYBOARD . . . POINT IT OUT ON THE SCREEN!
 IIAT's touch sensitive monitor gives you an alternative to keyboard entry
 that's easier, faster, more accurate . . . and fun.

13" Color Monitor with Integrated Touch Sensitive Bezel and Sense Circuitry: \$1595

Monitor Interface Card with cable and documentation
 For Apple II: \$159
 For IBM PC:*
 For Atari 800:*

DiscoVision or Sony Videodisk Interface Card with Monitor Interface, Cables and Documentation
 For Apple II: \$599
 For IBM PC:*
 For Atari 800:*

PILOT plus™ CAI Course Authoring Software: \$150

*IBM AND ATARI INTERFACES SCHEDULED FOR AVAILABILITY IN JUNE 1982. CALL FOR PRICE.

ALL PRICES DO NOT INCLUDE SHIPPING COSTS.



FEATURING . . .

- High Quality Color Monitor for super graphics and text
- Touch sensitive Bezel with 80 by 36 infrared sensing matrix for precise response with no loss of image quality
- High speed sensing circuitry for multi-point tracking
- Interfaces for Apple II, IBM PC and Atari 800 for flexibility
- PILOT plus™ software for programming power in Computer Aided Instruction (CAI)

USE IT for . . .

- Education, Training & Testing
- Order Entry and Processing
- Process Control
- Retail Point of Sale
- Database Query Programs
- Any application where you need quick and easy user interaction.

ALSO FROM IIAT:

NEW GRAPHICS FOR APPLE II

ULTRAPEN

Graphic pad version: \$250
 Joystick version also available

... A professional graphics editor for the Apple. Written in machine language for ultimate speed, Ultrapen provides a simple, low cost way to create still and animated graphics to stand alone for computer-based visual presentations. Ultrapen will also work with your BASIC programs. Write us for details.

Putting ACTION into interACTIVE computing

IIAT

International Institute
 of Applied Technology, Inc.
 20010 Century Boulevard
 Germantown, Maryland 20874
 (301) 428-9010

APPLE AND APPLE II ARE REGISTERED TRADEMARKS OF APPLE COMPUTER, INC. ATARI 800 IS A REGISTERED TRADEMARK OF ATARI, INC. IBM PERSONAL COMPUTER IS A REGISTERED TRADEMARK OF IBM CORPORATION. PILOT plus IS A REGISTERED TRADEMARK OF ONLINE COMPUTER SYSTEMS.

sive voice makes the writing sound more objective. I think the passive voice makes writing harder to read and boring.

Prepositional phrases are important, but using them too much fills up sentences with nouns and squeezes out the action. People like to read something with punch—not, "After discussing many options for controlling the situation in the event that there is a lack of suitable alternatives to the primary plan of action, it was decided to study the issue further in order to facilitate rapid response to future requirements."

Lanham's book has many useful "prescriptions" to help improve writing style. He suggests circling passive verbs and prepositions in the section to be revised. This shows you where the problem is. Then with the marked copy you can apply Lanham's techniques and rewrite your prose into something clearer and easier to read.

REVISE is a program I'm currently working on that will mark such sentences for you. In addition, REVISE will mark occurrences of the same word used too closely together in a document. This will show you where you might substitute a synonym in order to achieve variation. Of course, you still have to revise the sentences yourself, but the principles outlined in Lanham's book should be easier to apply with REVISE to help you.

The Future

I believe that the future will reveal new ways in which computers can help people to write and communicate better. I haven't had time in this article to discuss even a significant fraction of the possibilities. What should you watch for? Well, reading some of the articles mentioned in the bibliography should give you an idea of what other people are working on. My own ideas extend to such concepts as computerized "ghost writer" programs, which can take an outline for a piece of fiction, for example, and write a novel from it. (See Kevin McKean's article "Computers, Fiction and Poetry," page 50 in this issue.) Perhaps a form of fiction might come into vogue in which

programmed "books" would tell a different story each time you read them. The only limit on the imaginative use of computers in writing is the imagination of the programmer. Who knows?■

References

1. Cherry, Lorinda L. *Writing Tools—The STYLE and Diction Programs*. Murray Hill, NJ: Bell Laboratories, Computing Science Technical Report No. 91.
2. Cherry, Lorinda L. and Morris, Robert. "Computer Detection of Typographical Errors." *IEEE Transactions on Professional Communication*, March 1975, vol. PC-18 (1).

3. Flesch, Rudolph. *The Art of Readable Writing* (25th Anniversary ed.). New York: Harper & Row, 1974.
4. Fry, Edward. "A Readability Formula That Saves Time." *Journal of Reading*, April 1968, 513-578.
5. Gunning, Robert. *The Technique of Clear Writing* (rev. ed.). New York: McGraw-Hill, 1968.
6. Kernighan, Brian W. and Plauger, P. J. *Software Tools*. Reading, MA: Addison-Wesley, 1976.
7. Knuth, Donald E. *TEX and METAFONT: New Directions in Typesetting*. Bedford, MA: Digital Press, 1979.
8. Lanham, Richard A. *Revising Prose*. New York: Charles Scribner's Sons, 1979.
9. Parry, Richard R. "Minding Your P's and Q's." *Kilobaud Microcomputing*, June 1981, 58-67.

COMPUTER FORMS AND SUPPLIES

WE SUPPORT MORE SYSTEMS WITH FORMS THAN ANYONE!

INVOICES • STATEMENTS • CHECKS • P.O.'s • SHIPPERS • MEDICAL FORMS

Accounting Plus • Alpha Micro • Apple Computer • BPI Systems • Broderbund • CADO • Centurion/Warex/EDS • Cimarron • Compumax Associates • Continental Software • D.B. Software • Dakin-5 • Data Train • Denver Software Company • Designer Software • Digilog • Durango • Datamost • Dynabyte • IBM 5120 • IBM Sys 32/34 • IMS • Insoft • LIBRA • MCBA • NEC • Northstar • Open Systems • Osborne • Peachtree • R & B Systems • Radio Shack • Rocky Mountain Software • Serendipity • Shasta • (SSG) • Systems Plus • Taranto • TCS • The Bottom Shelf • Van Data • Vector Graphic • Wang

WE SUPPORT 170 SYSTEMS NOT LISTED HERE. SO IF YOU DON'T SEE YOUR SOFTWARE HERE CALL TOLL FREE FOR A FREE SAMPLE PACKET OF FORMS FOR YOUR SOFTWARE.

NEW! WORD PROCESSING LETTERHEAD

SHEER CUT LETTERHEAD FROM CHECKS TO-GO USES A NEW PROCESS TO PRODUCE CONTINUOUS FORM PAPER THAT TRIMS CLEAN WHEN BURST. NORMAL COMPUTER PAPER USES FIVE PERFORATIONS PER INCH, BUT SHEER CUT USES A NEW TECHNOLOGY TO PRODUCE 80 PERFS OR "TIES" PER INCH. THIS PRODUCES A VERY CLEAN AND UNIFORM EDGE WHEN BURST, AND IS ECONOMICAL IN BOTH SMALL AND LARGE QUANTITIES. SHEER CUT IS AVAILABLE ON A STOCK FORM BASIS IN FOUR "CLASSIC LAID" PAPERS, OR IN ANY TYPE PAPER ON A CUSTOM ORDER. EVERY OTHER FORM CAN BE IMPRINTED TO PRODUCE CONTINUOUS FIRST AND SECOND SHEETS. BLANK PRICES ARE \$60 FOR 1,000, \$235 FOR 5,000 AND \$400 FOR 10,000, WITH IMPRINTING, DEALER, AND VOLUME PRICING AVAILABLE.

TAX FORMS

SAVE 30% ON YOUR 1982 TAX FORMS IF YOU PLACE YOUR ORDER THIS MONTH

CALL FOR FREE 1982 TAX FORMS CATALOG!

Checks To-Go

IN CALIFORNIA
800-552-8817

8384 Hercules Street
La Mesa, CA. 92041

NATIONWIDE
800-854-2750

CALL TOLL FREE: (800) 854-2750 IN CA (800) 552-8817

Red Baron. Home of the Nation's

NEC 8023 Outstanding Graphics, Print Quality & Performance



144 x 160 dots/inch • Proportional Spacing
• Lower case descenders • N x 9 dot matrix
• 8 character sizes • 5 unique alphabets
• Greek character set • Graphic symbols
• 100 CPS print speed • Bi-directional logic-seeking • Adjustable tractors • Single-sheet friction feed • Vertical & horizontal tabbing
NEC 8023
Dot Matrix List \$795 **\$Call**

IDS Paper Tiger Prism 80/132 Affordable Color, Speed

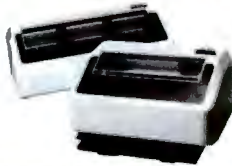

Dot Resolution Graphics • 9-wire staggered printhead • Lowercase descenders • Over 150 CPS • Bi-directional, logic-seeking
• 8 character sizes • 80-132 columns
• Hi-res dot graphics • Proportional spacing
• Text justifications • Optional Color
Prism 80 List \$999 **\$Call**
Prism 132 (Color) List \$2095 **\$Call**

NEC Spinwriter 7700 & 3500 Daisy Wheel Quality Leader



High speed, letter quality • 55/35 CPS
• Typewriter quality • Bi-directional printing & proportional spacing • Quiet • OCR quality print • Hi-res plotting/graphing • Quick change ribbon • Optional cut-sheet feeder, horizontal or bidirectional tractors • Prints up to 8 copies.
NEC Spinwriter RO
Serial Parallel 77xx List \$3055 **\$2575**
35xx List \$2290 **\$1975**

Smith Corona TP-1 Daisy Wheel Printer For Under \$900



A real character printer • Standard serial or parallel data interface • Drop-in ribbon • 144 WPM
• Various type fonts available • Loads paper like typewriter • Handles single sheets for forms
• Compatible with most micro computers

Smith Corona TP-1 List \$895 **\$Call**

The Epson Series. High-Quality Printers at a Low Price.



Epson MX80/ MX80FT

9 x 9 dot matrix • Lower case descenders
• 80 CPS • Bi-directional • Logic seeking
• 40, 66, 132 columns per line • 64 special graphic characters: TRS 80 Compatible
• Forms handling • Multipage printing
• Adjustable tractors

Epson MX80 List \$645 **\$Call**
Epson MX80FT List \$745 **\$Call**



Epson MX100

Same basic features as the MX80 • Plus friction feed for single sheets • Plus 15" wide carriage • Dot Resolution Graphics

MX100 List \$995 **\$Call**

Full Line of Epson Accessories

Anadex DP-9500A The Quiet Serial Matrix Impact Printer



Up to 200 CPS • Dot addressable graphics • Parallel and serial interfaces standard • Switch selectable protocol • Cartridge ribbon • Foreign character sets • Underlining • 1.5K to 3.5K buffer
• Correspondence quality print

Anadex DP-9500A List \$1725 **\$Call**
Anadex DP-9620 List \$1845 **\$Call**

Televideo CRT's Price, Performance & Reliability



910 List \$699 **\$600**
925 List \$995 **\$750**
950 List \$1195 **\$970**

Interface Equipment

Complete Stock of Options,
Cables and Accessories.

CCS APPLE SERIAL Interface & Cable . \$150
ORANGE INTERFACE for Apple II
Parallel Interface Board and Cable .. \$110
NOVATION D-CAT
direct connect modem \$180
COMPLETE STOCK OF EPSON
ACCESSORIES **\$Call**
CUSTOM PRINTER CABLES FOR Apple,
Atari, IBM, TRS-80 (all models) **\$Call**
HAYES MICROMODEM \$300
PRINTER STANDS: Large \$99
Small \$25
PRINTER RIBBONS—Most Types **\$Call**

OUR PEOPLE MAKE US EXPERTS.

Largest Computer Printer Inventory.

The Grappler+ Apple Graphics Interface

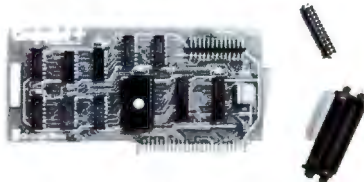

Graphic screen dumps with keyboard commands • Dual Hi-Res Graphics • Inverse graphics • Apple III compatible* • Printer dip switch • Emphasized graphics • 90° Rotation • Center graphics • Chart recorder mode and more.

*Requires Software Driver
Grappler+

\$175

The Okidata Series Hi-Res & TRS 80 Block Graphics



120 CPS • 9x9 Matrix • Bidirectional logic seeking printing • Lower case descenders • four print styles • Optional Hi-Res Graphics

Okidata 82A List \$649 **\$480**
Okidata 83A (w/Tractor) . . . List \$995 **\$745**

C. Itoh F-10 Low Priced Letter Quality



40 cps • Uses Diablo Standard Printwheels • Built-in word processing functions • Universal power supply • Optional bidirectional tractors • Prints original plus 2 copies • Quick-change cartridge Ribbon

C. Itoh F-10 List \$1995 **\$Call**

Our People, Our Product: Both Are Specialized.

Because our salespeople are printer specialists, they know the capabilities of each printer—and how to match one to your exact need. Red Baron's volume stocking assures a low, low price on a wide array of major brands. We're sure you'll like the product and services you get from Red Baron, and we know you'll love our Customer Benefit Package; an exclusive at Red Baron.



Customer Benefit Package

- Free Expert Consultation.** Before you buy, after you buy.
- Technical Staff.** Even your most involved questions get quick, helpful answers from our staff of printer technicians.
- Free Catalog.** Get your informative catalog with printer comparison chart and print samples today!
- Warranty.** The manufacturer's warranty applies where applicable.
- Same-Day Shipping.** Your order is shipped the same day when you call before 11:00 a.m.
- Free MasterCard and Visa.** Call us toll-free and charge your printer to your credit card.
- We Stock What We Sell.** No bait and switch, no hassle. We make every effort to keep a large stock of our advertised products.

Other Quality Printers at Red Baron

	List	Discount
C. Itoh 8510 Prowriter . . .	\$795	\$Call
Diablo 630/6	\$2995	\$2570
QUME Sprint 9/45	\$2475	\$2150

Here's How To Order:

Phone orders are welcome; same-day shipment on orders placed before 11:00 a.m. Free use of MasterCard and Visa. COD's accepted. Personal checks require 2 weeks clearance. Manufacturer's warranty included on all equipment. Prices subject to revision.

Call Toll Free For Catalog:

1-800-854-8275
CA, AK, HI (714) 630-3322



Member Better
Business Bureau

1100 N. TUSTIN #207, ANAHEIM, CA 92807

The Historian and the Microcomputer

A student of the past meets the machine of the future.

Professor Don Karl Rowney
Department of History
Bowling Green State University
Bowling Green, OH 43403

The computer with its ability to manipulate and analyze data at a phenomenal speed has been responsible for significant changes in historical research methods and the teaching of history. The emergence of the microcomputer is but the latest and an important step in the interaction between hardware and history.

To understand what a historian would use a computer for, you only have to realize that since the rise of modern states in the seventeenth century, vast amounts of information about economic, social, and political behavior have been stored in numerical form: numbers of people; amounts of money; casualties from war, famine, and disease; votes for or against almost anything; grain tonnage; tax records; and so on.

No competent student of social change can afford to ignore this quantitative information because it provides so much of the background within which the lives of historical figures have been framed. Everybody knows something about, say, Napoleon or Thomas Jefferson. But

to learn more than just a little, you must come to terms with the economic, demographic, and sociological conditions of their times. This is what quantitative history is about.

Quantitative history involves professionals such as political scientists, economists, and sociologists, as well as historians. Although the Quantitative Research Committee of the American Historical Association was one of the early efforts to stimulate and guide interest in this work, subsequent initiatives have gone beyond the historical profession. These include the *Journal of Interdisciplinary History*, edited by scholars at the Massachusetts Institute of Technology (MIT) and Princeton, the computerized Historical Data Archive at the University of Michigan's Center for Political Studies, and the Social Science History Association, with headquarters at Southern Illinois University. Clearly, the use of computers in research and teaching has affected many disciplines.

The Hardware Shift, 1960-1980

In the late fifties, computer systems at universities were comparatively small and difficult to use. For these reasons they could also be described as elitist. Access was limited to a tiny minority of the campus population—engineers and scientists who needed the computer's arithmetic skills. The social scientists who used these machines were few and far between, and the days of sophisticated data-

management and statistical-analysis packages that have become so important to us were still in the future. But the large computer installations that began to make their appearance in the sixties changed all of that. The size of machines such as IBM's 7090 or Control Data's 6600 together with their comparatively fast processing times resulted in both a centralization of computing and a substantial increase in the number of users. Because the machines were very expensive to acquire and to maintain, even large universities could not contemplate supporting more than one of them. Management of the big, new machines required considerable technical skill and a sizable bureaucracy to serve efficiently the increasingly diverse body of users.

The huge, multimillion-dollar installations of the sixties and early seventies were largely responsible for producing the first generation of computer scientists. Moreover, large-scale instruction in computer programming became common. Computer literacy became one of the common campus buzzwords. All this resulted in more people clamoring for time on the machines. Historians were often at the bottom of the priority list. In the end, each computer user found himself in a very long line where the most relevant question was always, "What's turnaround like today?"

The new state of affairs, however,

About the Author

Don Karl Rowney is professor of Russian and Soviet history at Bowling Green State University where he also teaches quantitative methods in history. Rowney is currently Chairman of the American Historical Association's Committee on Quantitative Research in History, and is first vice-president of the International Committee on Soviet and East European Studies.

Childhood's End: The 68000



ADDRESSING THE NEW FRONTIER... THE MICROCOMPUTER COMES OF AGE.

SAGE COMPUTER TECHNOLOGY IS NOW MANUFACTURING A 68000 BASED SINGLE-BOARD MICROCOMPUTER SYSTEM WHICH DELIVERS THE HIGHEST PERFORMANCE PER UNIT PRICE OF ANY COMPUTER IN HISTORY.

THE SAGE II MICROCOMPUTER HAS THE FOLLOWING FEATURES:

- INTERRUPT DRIVEN, 8 MHZ 68000 MICROPROCESSOR
- 2 MILLION INSTRUCTIONS PER SECOND, NO WAIT STATES
- WILL ADDRESS 16 MEGABYTES WITH UP TO 1/2 MEGABYTE OF PARITY RAM ON BOARD
- UP TO 1.3 MEGABYTES OF 5-1/4 INCH FLOPPY DISK STORAGE
- FULLY SUPPORTED IEEE-488 INTERFACE
- TERMINAL AND MODEM RS-232C SERIAL PORTS
- CENTRONICS COMPATIBLE PARALLEL PRINTER PORT
- UCSD PASCAL, BASIC, FORTRAN AND ASSEMBLER AVAILABLE

TM U OF CALIFORNIA

PRICES FOR THE SYSTEM START AT \$3600.
FOR MORE INFORMATION CONTACT OUR MARKETING
DEPARTMENT AT 702-522-6868

SAGE
COMPUTER TECHNOLOGY

135 NORTH EDISON WAY, SUITE 14 • RENO, NEVADA 89502

NEC PC-8023A-C Dot Matrix Printer

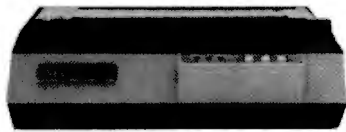

\$494.88 UPS DELIVERED

- 100 characters per second
- Adjustable tractor & friction feed
- Proportional spacing & true descenders
- Hi-Res, dot-addressable graphics
- 5 fonts, 8 sizes & Greek/Math characters
- Subscript, Superscript & underlining

IDS Printers

IDS PRISM 80 w/Sprint Mode, Dot Plot, and Cut Sheet Feeder **\$1009⁰⁰**
 IDS PRISM 132 includes all the above plus 4-color graphics **\$1714⁰⁰**

Smith-Corona Printer

TP-1 DAISY WHEEL PRINTER (Parallel or RS-232C), 10 or 12 pitch **\$699⁰⁰**

Okidata Printers

MICROLINE 82A **\$474⁰⁰**
 MICROLINE 83A **\$739⁰⁰**
 MICROLINE 84 (Parallel) **\$1084⁰⁰**
 MICROLINE 84 (RS-232C) **\$1214⁰⁰**

NEC Printers

NEC 3510/3530 Spinwriter (Parallel or RS-232C) 35cps **\$1904⁰⁰**
 NEC 7710/7730 Spinwriter (Parallel or RS-232C) 55cps **\$2559⁰⁰**

Epson Printers

MX-80 W/GRAFTRAX **\$479⁰⁰**
 MX-80/F-T W/GRAFTRAX **\$589⁰⁰**
 MX-100 **\$744⁰⁰**

C.Itoh Printers

C.ITOH PRO WRITER (Parallel) **\$509⁰⁰**
 C.ITOH PRO WRITER (Parallel & RS-232C) 3K print buffer, 120 cps **\$664⁰⁰**
 C.ITOH F-10 STAR WRITER Daisy Wheel (Parallel or RS-232C) 40cps ... **\$1499⁰⁰**

Cables and interfaces available for the APPLE, ATARI, CBM/PET, IBAM, OSBORNE, and TRS-80.

Orders & Information:

CALL (603)-673-8857

Orders Only: CALL (800)-343-0726

No Hidden Charges

No surcharge for credit cards—No charge for UPS shipping—Stock shipments next day
 All equipment shipped factory fresh with manufacturer's warranty—We accept CODs
 Prices subject to change

HIGH TECHNOLOGY AT AFFORDABLE PRICES

**THE BOTTOM
LINE**

Elm Street, Milford NH 03055-0423

did have some benefits. Big, fast, and comparatively cheap computing made low-priority work (such as historical research) possible on a large scale. It certainly seems fair to say that many historical projects and collections of data used for historical research would simply not have been possible without the million-dollar computers that made individual jobs relatively inexpensive.

Moreover, as prices in the computer industry began to drop in the seventies, software (such as the Statistical Package for the Social Sciences) and hardware (such as teleprinters and video-display terminals) became more readily available. These by-products of economies of scale often made the research process incomparably easier.

Source of a New Shift

Eventually some universities began to acquire microcomputers to take over some of the load previously carried by terminals that were connected to mainframes. This precipitated the shift away from crowded computer centers to personal computing. At the same time, microcomputers moved out of the hobbyists' domain and into the office.

Microcomputers are much more easily obtained by small institutions and individuals than big computers, and they need not present the same magnitude of technical and organizational problems usually associated with large mainframe installations. I see both positive and negative consequences of this changed state of affairs.

The advent of the microcomputer means that scholars who previously would not have used computers will now do so. I've used a microcomputer for less than a year, and I find that it has become indispensable for applications that had never even occurred to me before. For example, I now take research notes on the computer (using Software Publishing Corporation's Personal Filing System). Bibliographic materials, essential for my work as a professional historian, are easily stored on the computer and are more easily retrieved by subject, author, title, and date or

place of publication than through any card-file system. I maintain a subject- and source-ordered current events file that is based on several news sources and that has become an essential support database for consulting work I do.

Even more important, my word processor has transformed for me the process of turning ideas and research materials into text. Even though I have free access to excellent secretarial help, I prefer to use the word processor. Essentially, it's a more efficient way of producing manuscripts.

Special Headaches

The experience of having a computer dedicated to your own research problem was common in the early days of computing because of the nature of machines like the IBM 1620 (the first computer I used). In the case of these early machines time was reserved in advance because it was frequently necessary to alter the computer by inserting the appropriate circuit boards. When the computer was actually being used, it was completely dedicated to the user who had reserved it. Very importantly, turnaround was immediate because all peripheral devices were located in the same room as the computer and were, like the computer, dedicated to the user. Thus, one knew at once whether a run was successful: the gratification of success was just as immediate as the frustration of failure. This, of course, was an experience largely unknown to those who had experience only with the batch processors of the sixties and seventies. Even remote terminals, although they are designed to give the impression of exclusive access, are often handicapped by delayed response time and by the location of peripherals such as printers and data-storage devices in other places. With the coming of microcomputers, it is clear that the experience of using a dedicated computer is becoming common again. Nevertheless, user experiences with the "dedicated" 1620 and today's microcomputers are far from identical.

Users in the early days before the advent of the giant computers and the

GALAXY OF FEATURES

A GALAXY of features makes the **LNW80** a remarkable computer. As you explore the **LNW80**, you will find the most complete, powerful, ready to run, feature-packed personal and business computer ever made into one compact solid unit.



MODEL I COMPATIBILITY – The **LNW80** is fully hardware and software compatible with the Model I. Select from a universe of hardware accessories and software – from VisiCalc™ to space games, your **LNW80** will launch you into a new world of computing.

FULLY LOADED – A full payload includes an on-board single and double density disk controller for 5 1/4" and 8" single or double sided disk drives. RS232C communications port, cassette and parallel printer interfaces are standard features and ready to go. All memory is fully installed – 48K RAM, 16K graphics RAM and 12K ROM complete with Microsoft **BASIC**.

QUALITY CONSTRUCTION – Instrumentation quality construction sets **LNW80** computers apart from all the rest. Integrated into the sleek solid steel case of the **LNW80** is a professional 74-key expanded keyboard that includes a twelve key numeric keypad.

HIGH RESOLUTION GRAPHICS & COLOR – The stunning 480 X 192 resolution gives you total display control – in color or black and white. The choice of display formats is yours; 80, 64, 40 and 32 columns by 24 or 16 lines in any combination of eight colors.

PERFORMANCE – Lift-off with a 4MHz Z80A CPU for twice the performance. The **LNW80** outperforms all computers in its class.



Our down to earth price won't send you into orbit

LNW Research Corp.

2620 WALNUT, Tustin, CA 92680
(714) 611-8850 (714) 544-5744

Monitor and Disk drives not included
TM Personal Software, Inc.

accompanying bureaucratization generally weren't responsible for basic decisions concerning both hardware and software. People familiar with computers decided what equipment and programs were needed. The purchaser of a microcomputer, however, is often obliged to make decisions about software and hardware purchases himself, regardless of his technical knowledge.

Difficulties are compounded by the very advantages that we associate with microcomputers. Just as computing itself has been decentralized by microcomputers, so information about them—about what they can do, how they do it, and how much it will cost—is now vastly decentralized. There seems to be no one place to go for information that will help you make an intelligent decision about what to buy to fit your specific needs. Inevitably, decisions that sometimes involve thousands of dollars are made in a relative information vacuum.

For instance, a social scientist who

wants to know where to get a package of statistical programs that will suit his needs may find himself engaged in a major research project just to uncover this information. Computer stores—at least in my experience—are of very little help with problems like these because their biggest markets, even in large university towns, are small businesses and home users.

Moreover, many of the established resources for solving computing problems are not helpful with microcomputers. For example, since the early seventies, a standard tool for solving statistical analysis and data-management problems has been the Statistical Package for the Social Sciences (SPSS).

At this writing, any scholar who has hungered for an SPSS for microcomputers is fated to disappointment. SPSSG, the "miniversion" of SPSS, is designed to run on systems with fewer than 128,000 bytes of main core storage. Some microcomputers such as the new IBM Personal Computer

and the Apple III are designed to operate at these levels and above. (At least two RAM [random-access read/write memory] cards that will boost the Apple II into the 192K-byte range have been announced recently.) Nevertheless, there does not yet exist a microcomputer-oriented SPSS package. According to a representative of SPSS Inc., plans for a package suited to the IBM Personal Computer are in the works, but it's unlikely that anything concrete will emerge before 1983.

In fact, interest in developing software resources for microcomputers and in disseminating information about these developments appears to be quite casual among members of the social science research and education community. For example, I contacted Science Research Associates, the IBM subsidiary, to inquire about its plans for development of programmed instruction packages in history, the social sciences, or statistics. I was told that there was little done as yet by way of concrete planning and that if I wanted to send them ideas or, better yet, finished programs, they would be given careful consideration!

Apart from direct research applications such as statistical analysis and data management, one of the crying needs at the moment is for imaginative and effective simulation and programmed instruction in history. The possibilities are obvious and virtually endless. If we can replay the major naval engagements of World War II (with Avalon Hill's Midway Campaign, for example), we should certainly be able to replay the major nineteenth-century presidential elections. Anyone who has the programming skills to create one of the many imaginative games around can surely recreate the interaction of the components essential to the origin of World War I. And if it's a question either of specific subjects or of the relevant and necessary information to be included, I am quite prepared to make well-documented recommendations just as other historians would be. Developments in these areas and information about new developments are remarkably scarce.

IBM[®] P.C. UPGRADES

Aegis Systems Introduces: PHALANX

- 64K Memory (Sockets to 256K)
- 2 RS 232C Ports
- 1 Printer Port
- IBM Hardware and Software Compatible
- 1 Year Warranty
- Quality Design and Operation

\$445

Everything for the PC

- Disk Drive Kit (Single Side) \$235
- Disk Drive Kit (Double Side) \$305
- 16K Memory Kit \$24
- NEC 8023A w/cable \$529
- Rat TRAX (Total Screen Copy Utility for NEC, EPSON, OKI) \$25

Also

- Disk Drives (3rd & 4th)
- Color & Green Monitors
- Monitor Extension Cable
- Monitor Extension Cable
- Printer Cable
- Floppy Disk Adapter Board
- 3M Diskettes
- EPSON (w/GraphTrax Plus), OKIDATA and Letter Quality Printers
- Hi Res Green Plug Compatible Replacement for IBM's Monochrome with P31 Phosphor for Light Pens

More Software and Hardware Coming

AEGIS SYSTEMS

P.O. Box 401 202 W. Bennett Saline MI 48176

Volume Discounts Available

1-800-521-0521 (In Mich) 313-429-2678

WELCOME A BOARD



The high speed, cool, reliable static ram without waitstates.

Our RAM67 static RAM offers low power for cool operation and high reliability. It is the first S100 memory of its size to offer battery back up. The RAM67 will run without waitstates with any present S100 bus CPU.

Advanced features of the static RAM67:

- Low power CMOS RAM
- 100 ns access time
- No wait states with our 10 MHz *Lightning One*[™]
- 8/16 bit operation
- Phantom disable
- Battery back up option

If you need high performance and high reliability at an affordable price, the RAM67 is the memory for you.

128K RAM\$1495.00
Battery back-up option\$100.00

The Lightning One

The *Lightning One* is the fastest S100 CPU board presently available. The 8086 processor with its two co-processors, the 8087 and 8089, provide exceptional data manipulation, numeric processing and I/O handling capability.

The Lightning One features:

- 8086 or 8088 16 bit processor
- 4,5,8, or 10 MHz jumper selectable operation
- Optional 8087 and 8089 co-processors
- Onboard monitor with diagnostics
- 9 vectored interrupts expandable to 65

RAM67.

When you need mini-computer performance at micro-computer prices, the *Lightning One* should be your choice. Benchmarks available.

Prices start at\$395.00

Other LDP Products

In addition to the RAM67 and *Lightning One*, Lomas Data Products offers the following fine products:

- HAZITALL System Support**
2 serial ports, 2 parallel ports, clock/calendar, 9511 or 9512 math support (option), hard disk controller host interface A & T, \$325.00
- LDP72 Floppy Disk Controller**
Single or double density operation, single or double sided disks, controls both 8" and 5 1/4" floppy



For 16 bit computing on the S100 bus, come to the leader ...



drives, digital data separator for adjustment free reliable operation A & T, \$274.95

LDP128/256K Dynamic RAM

An advanced dynamic RAM with static like performance. An ideal choice for large memory configurations where cost is an important consideration. No DMA, or reset restrictions A & T, 128K \$795.00, 256K \$1395.00

LDP88 8088 CPU Board

Ideal for inexpensive systems requiring the processing power of a 16 bit instruction set. The LDP88 has up to 8K of on-board EPROM, 1K bytes of RAM, 1 serial RS232 port, 9 vectored interrupts, 5 MHz operation. Useable as a single board 8088 processor A & T, \$349.95

Software Available

- CP/M-86***
Full track buffered BIOS, memory disk support, double density format \$300.00
- MP/M-86***
Full MP/M-86 implementation, hard disk and floppy disk support, plus memory drive. 1, 2 and 5 user configurations.
- MS-DOS****
The IBM Personal Computer operating system, includes macro assembler \$250.00
- Other software:**
BASIC86, BASCOM86, FORTRAN86, C, FORTH.

*CP/M-86 & MP/M-86 trademark of Digital Research.

**MS-DOS trademark of Microsoft.

Lightning One trademark of Lomas Data Products, Inc.

Dealer and O.E.M. inquiries invited.

LOMAS DATA PRODUCTS, INC.

729 Farm Road, Marlboro, Massachusetts 01752 ☐ Telephone: 617-481-2822

Circle 334 on inquiry card.

Experts Voted



Software Product of the Year

InfoWorld

1/18/82

AWARDED

Proofreads 40 pages/minute for spelling errors.

Compresses 20,000 word dictionary into only 59 K.

ST

**ANNOUNCING
NEW PRODUCTS:**

For Canada, Europe, Australia, Asia, and other areas outside the U.S.A., Spellguard now has a specialized international dictionary, including British spelling, available at no extra cost. (Adds 9 K to dictionary.)

Spellguard now available for Apple with CP/M™ and IBM's PC Dos or CP/M 86.™

Handsome new packaging.

Spellguard is the latest, most compressed, most accurate spelling checker. We guarantee reliability. Spellguard works with any CP/M word processor and with hundreds of machines. It's the only award winner!

Has your work been Spellguarded?

PLACE

INNOVATIVE
software applications

The Plaza Building
1150 Chestnut Lane
Menlo Park, California 94025
Telephone 415 328 0806

Excellent dealer opportunities!
Give us a call today.

CP/M/Trademark Digital Research, Pacific Grove, CA

Hope in Ann Arbor

This is not to say that progress is nonexistent. Although it is slow in appearing, some help does seem to be at hand. One oasis of rationality in the creative chaos of microcomputers is in the Institute for Social Research at the University of Michigan. Under the auspices of Gregory A. Marks of the Inter-university Consortium for Political and Social Research a union of hardware and software is actually taking place. For example, many Zenith Z-89s complete with disk drives are wired to two Prime mini-computers and to the university's Amdahl mainframe. The combination, as Marks puts it, aims to give the user the number-crunching power of big machines under the friendly facade of microcomputers.

**An industry. . . that
aims to make its
product the bicycle
of the Information
world clearly needs
to give software
development a higher
priority.**

At the same time, Marks and his colleagues are making efforts to take the mystery out of using microcomputers in the social sciences. Their efforts include preparing introductory literature on microcomputers and their uses for distribution to members of the Inter-university Consortium. As well, they hold seminars designed to introduce the uninitiated to microcomputing (open, for a fee, to outsiders). As part of this effort, they're developing a combination statistical package/training program. The idea is to produce a program that would run on a microcomputer and that would help students grasp the uses of both statistics and computers in social research by letting them work with real historical, social, and political data.

Other hopeful signs are evident in the trade magazines. Statistical and data-management packages, such as those available from Blue Lakes Com-

puter or Ecosoft, seem promising. Strategic Simulations offers a simulation of presidential elections that appears to include some historical data and that aims to put the player in the place of a campaign strategist.

Before committing limited resources to any of these products, you will want to know whether they fit your needs; a visit to a computer store often provides only the most limited information—even if the product happens to be in stock. Product reviews in trade magazines are useful, of course, but they may be difficult to find and are often superficial. Catalogs that contain lists of products with discussions of their virtues are also helpful.

At present, making decisions about software for microcomputers is a lot like trying to direct-dial long distance in total darkness: it requires great care and experience. Learning can be frustrating, and mistakes will inevitably be costly.

A Call for Changes

I have some specific suggestions for changes that would make life easier for scholars like me who use microcomputers.

The computer revolution, sociologically speaking, is an information revolution. It should not be surprising, then, that information management has become the most central problem for computer users. The kind of information problems I have in mind here, however, concern software and hardware products that are available to solve certain problems.

Up-to-date, reliable information about available products is badly needed. The market, consisting of researchers and teachers, is an intelligent one and it generally knows what it wants. High-pressure salesmanship and elaborate packaging are, therefore, likely to be counterproductive.

One of the most imaginative marketing techniques I have seen is Context Management Systems' offer to send prospective customers a disk that demonstrates its "Context Connection." I would like to see this approach used widely.

I propose that manufacturers retain a computer network, such as the

Peripherals

Unlimited...

FANTASTIC PRICES!

OUR FAST SERVICE, PRODUCT SELECTION AND OUR CUSTOMERS' SATISFACTION MAKE US #1.

ZENITH

Z-89-48K	\$2299
Z-90-64K DO	\$2588
Z-19 Terminal	\$777
Z-121 Monitor 12"	\$149

ATARI COMPUTERS

Atari 800 16K	\$688
Atari 400	\$318
Atari Interface Module	\$174
Atari 810 Single Disk	\$444
Atari 815 Dual Disk	TBA
Atari 830 Modem	\$166
Programmer	\$59
Entertainer	\$84
Star Raiders	\$34
16K Mem. Exp. for Atari	\$74
32K Mem. Exp. for Atari	\$114

NEC PRINTERS

7710/30 Spinwriter R/O	\$2279
7720 Spinwriter KSR	\$2649
3510/30 Spinwriter R/O	\$1699
3500 Serial Spinwriter	\$1599

NEC DOT MATRIX

PC-8023	\$474
---------	-------

Call for prices on ribbons, etc.

MORE PRINTERS

Anadex 9500/9501	\$1295
Anadex DP-9000	\$1049
Okidata Microline 80A	\$339
Okidata Microline 82A	\$474
Okidata Microline 83A	\$724
Tractor (OKI 80 + 82 only)	\$60
Diablo 630	\$2044

MONITORS

Sanyo 12" GRN Phosphor	\$266
Sanyo 12" Black + White	\$239
Amdek 12" 300 GRN Phosphor	\$164
Amdek 12" Color	\$344
NEC 12" GRN Phosphor	\$164
NEC 12" Color	\$344

EPSON PRINTERS

MX-70	\$288
MX-80 w/Graphics	\$444
MX-80 FT (Friction + Tractor)	\$544
MX-100 (15" Carriage)	\$744

Call for prices on Ribbons, Cables and Interfaces

NEC-PC 8000

Series Microcomputer

PC-8001A Computer w/32K	\$888
PC-8012A w/32K + Exp. Slots	\$588
PC-8031A Dual Mini Disk	\$888
PC-8032A Add-on Mini Disk	\$777

Call for Software Prices

TOLL FREE

1-800-343-4114

ORDERING INFORMATION

Our order lines are open 9AM to 6PM EST Monday thru Friday. Phone orders are welcome; same day shipment on orders placed before 10AM. Free use of Mastercard and VISA. Personal checks require 2 weeks clearance. Manufacturer's warranty included on all equipment. Prices subject to revision. C.O.D.'s accepted.

For service, quality and delivery call:

PERIPHERALS UNLIMITED
(617) 655-7400

62 N. Main St. • Natick, MA 01760

KAYCOMP II



SPECIFICATIONS

CPU: Z80
 RAM: 64K Bytes
 DISK STORAGE: Two double density 5¼" floppy disk drives with 195K bytes each
 KEYBOARD: Detachable full typewriter keyboard with 14-key numeric pad and 4 cursor control keys
 VIDEO DISPLAY: Green phosphor P31 9" display, 80 columns x 24 rows with scrolling capability
 CASE: Portable, self contained, low-profile package with carrying handle

INPUT AND OUTPUT CONNECTIONS:

- MODEM/RS232C interface
- Centronics parallel printer interface

STANDARD SOFTWARE:

- CP/M® 2.2 - General purpose operating system
- S/BASIC™ - a structured BASIC compiler for quickly obtaining problems solutions
- PROFIT PLAN™ - Electronic worksheet for independent variable manipulation and forecasting
- SELECT™ - Complete word processing system
- TEACH™ - User friendly self-teaching guide to SELECT™

BGNLSKAYCOMP Shipping Weight 33 lbs \$1795.00
BGNLSKAYCOVER Vinyl cover for KAYCOMP II \$55.00

All You Could Want For Your Business or Family — \$1795.00

KAYCOMP II is the handy, portable business and family computer that was developed with one person in mind — You. You are now able to be more productive, apply more effort to your creativity and able to save time in your business and at home. You also save money because **KAYCOMP II** is delivered with all the hardware and software you need for the low price of \$1795.00. The many hardware and software features make the **KAYCOMP II** the greatest value when compared to any computer in the low priced field.

MINDING BUSINESS AT WORK

During business hours, **KAYCOMP II** performs at full stride. Tedious, time consuming operations like A/R, A/P, G/L, payroll, inventory control, and more may be performed with the wide variety of CP/M™ application programs available on the market.

WORD PROCESSING AND MORE

To reduce the time and expense of your "papermill," **KAYCOMP II**, with its SELECT™ word processing program will assist you in composing, editing, and printing all of your word processing requirements. You can compose business letters, advertisements, brochures, manuals, handbooks, and business forms. With SELECT's™ merge feature, take the drudgery out of mailing your standard forms and printing labels.

POWERFUL HARDWARE

The NLS **KAYCOMP II** uses the tried and proven Z80 central processing unit; the most widely used CPU in the industry. NLS packs the **KAYCOMP II** with a full 64K of memory; no more "OUT OF MEMORY" in the middle of a program! The disk storage capacity of the **KAYCOMP II** is an impressive 390Kb. The drives are formatted with 40 tracks, 512 bytes per sector, in a soft sector format. The drives will read single or double density disks for optimum storage and compatibility.

The **KAYCOMP II** has an RS232C serial port and Centronics type parallel interface for communications with the outside world. The serial port provides asynchronous information from 110 to 19,200 baud and may be hooked up to modems, printers, plotters, or any other device containing an RS232C serial interface. The parallel interface is the industry standard Centronics type for connection to a wide variety of low cost printers.

The alpha-numeric keyboard of the **KAYCOMP II** is truly a beauty. The keys have all been sculptured for your handling convenience. NLS provides a 14 key numeric pad with its own RETURN key for more efficient numeric data entry. Cursor control keys have also been added for calculating wide-word processing or numeric spreads. You will never want to use another keyboard again. For added flexibility and comfort, the keyboard is detachable so it may be positioned away from the body of the machine.

CP/M is a trademark of Digital Research. S/BASIC is a trademark of Topaz Programming Group. PROFIT PLAN is a trademark of Chang Laboratories. SELECT and TEACH are trademarks of Select Information Systems.

POWERFUL SOFTWARE

As an extra value to you, there is a **FREE** package of software to help you get started. By using a CP/M® controller, the **KAYCOMP II** allows you access to hundreds of applications or user programs already available at a moderate price. This free software package includes the CP/M® operating system, Topaz Programming's S/BASIC language, PROFIT PLAN™ electronic spreadsheet, and SELECT™ word processing software. S/BASIC™ will allow you to talk to your computer and even try your hand at programming. PROFIT PLAN™ will help you analyze data, plan your personal investments, and simplify your family budget. SELECT™ is a word processing program that turns your computer into an electronic typewriter. It also has an optional spelling checker, no more typos!

A WORD ABOUT NLS

Non-Linear Systems, Inc. is the originator of the digital voltmeter and an innovative leader in the field of electronic test equipment.

Organized in 1952, NLS has been a major supplier of digital voltmeters and ratiometers to large corporations in the aerospace industry. Since 1972 NLS has been consumer directed, providing small, portable multimeters, oscilloscopes, counters, frequency meters, temperature meters, and DMM's. And now — NLS has entered the world of computers with one thought — to provide the best value in a small, business, scientific, and family computer.

YOU DON'T NEED LARGER GLASSES!

The **KAYCOMP II** includes a large P31 phosphor green, 25MHz bandwidth, 9" screen. It displays clear, easy to read characters in an 80 character by 24 line format. This sharp display means eye strain from small computers is a thing of the past.

The 9" display also saves you money by eliminating the need to purchase an additional monitor. You don't have to settle for a 5" screen any longer!

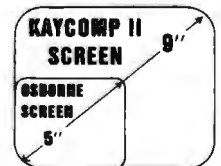

PRIORITY ONE ELECTRONICS.

9161 Deering Ave., Chatsworth, CA 91311



ORDER TOLL FREE (800) 423-5922 - CA, AK, HI CALL (213) 709-5464

TERMS U.S.: VISA, MasterCard, Check or Money Order. CA residents add 6 1/2% Sales Tax. Include \$15.00 for UPS Surface Shipping and Handling for each **KAYCOMP II**. Just in case, please include your day phone number. Prices and specifications subject to change without notice. We will do our best to maintain these prices through July, 1982. If you do not have our 68 page color catalog, send \$1.00 for your copy today!

Circle 425 on inquiry card.

COMPARE HITACHI TO TEKTRONIX



Buy with confidence from the nation's largest Hitachi distributor

BGHITV1050

100 MHz

LIST PRICE: \$2375.00

SALE: \$1595.00

DUAL TRACE WITH 3rd & 4th
TRACE TRIGGER VIEW



BGHITV352

35 MHz

LIST PRICE: \$1150.00

SALE: \$795.00

BGHITV550B

50 MHz

LIST PRICE: \$1745.00

SALE: \$1250.00

DUAL TRACE WITH 3rd
TRACE TRIGGER VIEW

SPEC	TEK 2210	HITV1050	HITV550B	HITV352
PRICE	\$1400.00	\$1000.00	\$1400.00	\$900.00
BANDWIDTH	50 MHz/50 MHz	100 MHz	50 MHz	35 MHz
SENSITIVITY	20 mV/DIV-5mV/DIV	5mV/DIV	5mV/DIV	5mV/DIV
SWEEP SPEED SELECTION	50 ns/DIV to 5 μ/DIV x 10 p/div	20 ns/DIV to 5 μ/DIV x 10 p/div	50 ns/DIV to 5 μ/DIV x 10 p/div	2 μs μ/DIV to 2 μ/DIV x 10 p/div
VERTICAL MODES	CH 1, CH 2, ALT COMP. ADD TRIG A VIEW TRIG B VIEW	CH 1, CH 2, ALT COMP. ADD TRIG A VIEW TRIG B VIEW	CH 1, CH 2, ALT COMP. ADD TRIG A VIEW	CH 1, CH 2 DUAL, ADD DIV
WIDE RANGE VERT. SENSITIVITY	2 mV to 100 V /DIV	500 μV to 50V /DIV	1 mV to 50 V /DIV	1 mV to 50 V /DIV
DELAYED OR INTENSIFIED SWEEP	YES	YES	YES	NO
DELAY TIMES	5 μs to 4 ms	10 ns to 5 μ/DIV	25 ns to 5 μ/DIV	FIXED
DUAL TIME BASE MEASUREMENTS	A, B, ALT w/D INTENSIFIED	A, B, ALT w/D INTENSIFIED	A, B, ALT w/D INTENSIFIED	---
TRIGGER "A" MODES	AUTOMATIC TV VERTICAL TV HORIZONTAL LINE EXTERNAL SINGLE SWEEP	AUTOMATIC TV VERTICAL TV HORIZONTAL LINE EXTERNAL SINGLE SWEEP	AUTOMATIC TV VERTICAL TV HORIZONTAL LINE EXTERNAL SINGLE SWEEP	AUTOMATIC TV (+, -) LINE EXTERNAL
TRIGGER "B" MODES	+, - SLOPE INTERNAL ONLY	+, - SLOPE INTERNAL EXTERNAL	+, - SLOPE INTERNAL EXTERNAL	---
ALTERNATE SWEEP SEPARATOR	YES	YES	NO	---

SPEC	TEK 2210	HITV1050	HITV550B	HITV352
CRT	8 x 10 DIV INT. BRIGHTNESS P51 PHOSPHOR 10KV ACCEL. V	8 x 10 DIV INT. BRIGHTNESS P51 PHOSPHOR 20KV ACCEL. V	8 x 10 DIV INT. BRIGHTNESS P51 PHOSPHOR 10KV ACCEL. V	8 x 10 DIV INT. BRIGHTNESS P51 PHOSPHOR 5.2KV ACCEL. V
CRT CONTROLS	BRIGHTNESS AUTO FOCUS REAR FINGER TRACE ROTATION	BRIGHTNESS AUTO FOCUS REAR FINGER TRACE ROTATION	BRIGHTNESS AUTO FOCUS TRACE ROTATION	BRIGHTNESS FOCUS TRACE ROTATION
SCALE ILLUMINATION	NO	YES	YES	YES
CHANNEL 2 INVERT	YES	YES	YES	NO
TRIGGER VIEW	NO	A, B	A	NO
HF REJECTION	NO	SWITCHABLE YES	SWITCHABLE YES	NO
LF REJECTION	NO	SWITCHABLE YES	SWITCHABLE YES	NO
HARD WITH LIMIT	NO	YES 20 DIV	NO	NO
X-Y MEASUREMENTS	YES	YES	YES	YES
CAMERA BEZEL	YES	YES	YES	NO
MULTI POSITION HANDLE	YES	YES	YES	YES
JITTER	10,000:1	20,000:1	20,000:1	---
2 AXIS BANDWIDTH	50 Hz	50 Hz	50 Hz	50 Hz
6 - 5 Typ	5 MHz	5 MHz	3.5 MHz	2 MHz
POWER CONSUMPTION	50 WATTS	50 WATTS	45 WATTS	45 WATTS
PROBE CALIBRATOR	YES	YES	YES	YES
INTF	NOT GIVEN	20,000 RES TARGET VALUE	20,000 RES TARGET VALUE	20,000 RES TARGET VALUE
A, B CHANNEL GATE OUTPUT	NO	YES	NO	NO
POWER-ON INDICATOR	NO	YES	YES	YES
WARRANTY	1 YEAR	2 YEARS	2 YEARS	2 YEARS

* USING X10 PROBE
† USING X10 PROBE WITH MAGNIFIER

* We had to obtain this specification by phone from Tektronix because it was not listed in the literature

All HITACHI Scopes come with 2, 10 to 1 Probes

ORDER TOLL FREE (800) 423-5922 - CA, AK, HI CALL (213) 709-5464

Until now, if you wanted a 50MHz or 100MHz dual trace oscilloscope of uncompromising quality, there was only one choice. Now there is a second... outstanding new delay sweep with an established name — the Hitachi V550B and the V1050.

The HITACHI V550B (50MHz) and V1050 (100MHz) offer all the capabilities you might demand from a lab grade oscilloscope. Capabilities such as a max. sweep rate of 2ns/div (V1050) 5ns/div (550B). Also features you may not expect, like sensitivity of 1 mV/div (V550B) 5mV/div (V1050) @ 10MHz, automatic focus correction, and a built-in TV sync separator circuit.

The cost? Remarkably reasonable, especially when you compare it to the other leading 50MHz or 100 MHz Dual trace oscilloscopes. It's a price breakthrough made possible by using up-to-date production techniques and a design backed up by over 20 years of oscilloscope experience.

PRIORITY ONE ELECTRONICS

9161 Deering Ave., Chatsworth, CA 91311

TERMS: U.S. VISA MasterCard. Check or Money Order. CA residents add 6 1/4% Sales Tax. All prices are FOB Chatsworth, California. **Include \$15.00 for each OSCILLOSCOPE** for UPS Surface Shipping and Handling. Inlet in case, please include your day phone number. Prices are limited to stock on hand and are subject to change without notice. We will do our best to maintain these prices through July 1987. Sale Prices are for PREPAID orders only. For complete specifications, see our 68 page color catalog. If you don't have a copy, send \$1.00 for your copy today!

CALL US FOR THESE OTHER FINE LINES:



CP/M DATA ENTRY "RADAR"

RADAR is a high speed data entry system that will run on any CP/M system providing a "3741" style key-to-disk environment. RADAR is ideal for replacing KEYPUNCH machines and older, slower key-to-disk systems like the 3741's and 42's.

Features:

- Verify Mode
- Check Digit Processor
- Auto Dup/Manual Dup
- 16 Accumulators
- Parameter Driven (No Programming)
- "Virtual" File Access
- Add or Delete Records
- Record Retrieval By Number Or Content
- Full Editing Capability
- Operator Prompts
- Extremely Fast (Written In Assembly Language)

In addition to "heavy-duty" data entry, RADAR is also the ideal "front-end" for many applications programs, providing aquisition and retrieval of keyed data with a degree of reliability simply not possible with any other technique. RADAR can cut programming time by more than 30%, simply because there is no longer any need to write the "input" portion of a program, just let RADAR handle it!

Write or call for free brochure. The RADAR manual is also available separately for \$25.00.



P.O. Box 3373A
Birmingham, AL 35255
Phone: 205-933-1659

Tymnet or Telenet systems, to archive their advertisements in the Dialog Information Retrieval Service (see "Information Unlimited" June 1981 BYTE, page 88). New products could be described and demonstrated through this medium. The system could be updated constantly, and potential consumers could search for only those items they want.

Pricing and Distribution

Producers of software need to rethink their pricing policies. Universities and local school boards don't have the resources to buy a complete set of software for each microcomputer. Even if the resources were there, multiple purchases of the same software would be regarded as wasteful. Manufacturers' insistence on single-machine use of a program is simply unrealistic and would seem to invite illegal copying of materials. Given the speed with which materials of this sort become obsolete, a general lease agreement with each institution would be more likely to produce desirable results.

In any case, software manufacturers will probably come to the same realization that book and computer manufacturers reached long ago: universities and schools require special marketing techniques and probably special marketing divisions.

Statistical Packages

One of the most serious needs at the moment is for reliable, well-documented statistical and data-management packages similar to those that social scientists and historians have been using on large computers. Obviously, the requirements for computer memory and rapid processing place certain limits on what can be achieved on microcomputers at the moment. But, as I suggested earlier, some of these limitations are disappearing. Plug-in memory—lots of it—is beginning to make its appearance among microcomputers. As this happens, the adaptability of microcomputers to scholarly work will grow. For 20 years the absence of adequate software has made using computers difficult if not frustrating. In the case of microcomputers, his-

tory is clearly repeating itself. An industry that aims—as Steve Jobs of Apple Computer put it—to make its product the bicycle of the information world clearly needs to give software a higher priority.

I am not a trained programmer in any computer language and I have no plans to study such a language. Having already studied Russian, French, German, Latin, Hebrew, and Greek, I think enough is enough! This means that I need the services of good programmers just as badly as I need the products of computer engineers. I believe I'm speaking here for thousands of other scholars and scientists.

Revolutions, if they are to survive, have to be institutionalized. It is the social experience—the use that society makes of the revolution—that provides the crucial clues as to the appropriate institutional forms. Speaking as a historian, I can say that society learns most of what it knows through experience. Development of mechanisms for storing and communicating past experience is absolutely essential to social progress. This is one of the reasons that societies tend to attach some value to the work that historians do.

Ironically, one of the great problems with the computer revolution, a revolution of information, is that it has tended to pay little attention to its accumulating experiences. The impact of hardware changes on research behavior, for example, is appreciated very little in any systematic sense. It should not be surprising, then, that we don't have a very sound understanding of what to expect in the face of fresh changes in technology or that there is a lag in the development of some of the resources that are necessary to exploit these changes.

The effort that is represented by this issue of BYTE is an illustration of what needs to be done on a continuing basis. What these observations mean so far as the microcomputer revolution is concerned is that the users' experience has to be discovered, analyzed, and then incorporated into any realistic notion of what the next step in the revolution will be. In this sense, it's time to stop playing games. ■

ATARI SAYS ITS FIRST WORD WITH A VOICE BOX BY THE ALIEN GROUP!

THE ALIEN GROUP has emerged from the underground, daring to offer a full-featured speech synthesis system that is flexible, low in cost, and needs no-accessory devices. No Interface, Cables, Speaker, Amp, or External Power Required! VOICE BOX has been designed and programmed by Atari users to become the integral voice of a 400 or 800 computer. Simply plugged into the serial port, VOICE BOX automatically routes all speech into the speaker of your television monitor. With the menu-driven operating system supplied, you'll be creating original, intelligible speech within moments after loading disk or cassette. No lengthy or obscure instructions to wade through.

The system includes a dictionary which translates typed text into VOICE BOX's phonetic language. The dictionary can be expanded to include as many as 5,000 words of your own custom vocabulary. Unlimited speech can be produced by straightforward phonetic definition at any time, even if the dictionary should be full.

The speech routines can be called from other programs for any purpose you can conceive. Here are a few suggested uses:



VOICE BOX
Speech Synthesizer

SOUND EFFECTS

- Access 64 phonemes at any of 4 pitch levels to add filtered, contoured sound to the Atari audio repertoire.

GAMES

- Program aliens to hiss threats, moan when destroyed.
- Devise weird, non-human tongues for dungeon dwellers.
- Insert cryptic spoken clues in maze games.

COMPUTER OPERATION

- Code verbal prompts and error messages that command attention and leave the current display intact.

EDUCATION

- Gain an introduction to the principles of phonetics.
- Learn touch typing through spoken feedback from the keyboard.

In addition, the *Random Sentence Generator* included in the operating system, which prints and speaks endlessly startling, amusing, even poetic combinations of words supplied by the user, helps teach school children to identify parts of speech and recognize a variety of sentence structures.

A minimum of 16K RAM is required by the operating system. Either disk or cassette includes both 16K and 32K versions. Try VOICE BOX for up to 10 days, and if it isn't the finest value you've ever seen in a computer peripheral, the most challenging and provocative addition you've ever made to your system, return it in its original condition for a full refund.

When ordering specify disk- or cassette-based operating system, and enclose check or money-order for \$169, or state your VISA or MASTERCARD number. Send mail orders to: THE ALIEN GROUP

27 West 23rd Street
Dept. BT-1
New York, New York 10010

or telephone orders from
10 AM to 6 PM New York time
(212) 924-5546

ALSO AVAILABLE AT LEADING COMPUTER STORES THROUGHOUT THE WORLD.

Simulating Neighborhood Segregation

A BASIC program gives surprising insights into some of the forces that hamper integration.

Professor Edwin Dethlefsen
Department of Anthropology
and
Associate Professor Carlisle Moody
Department of Economics
College of William and Mary
Williamsburg, VA 23185

Computers have never enjoyed a good name among some educators. Resisters have claimed that the absence of a teacher's warm body will have adverse psychological effects on the students. Some say, out of fear and ignorance perhaps, that young children exposed to computers early in their school years would turn into hard, cold, and uncompassionate adults.

Nowadays, though, for better or worse, there is at least one microcomputer in almost every neighborhood, and the children are learning faster than their teachers that despite past fears computers are here to stay. Consequently, teachers either are adopting more positive views of computers or they are being replaced by teachers eager to use the most modern devices and techniques.

The computer has shown many of us new ways of thinking about practically everything. Going farther than merely showing us new approaches to

problem solving, the computer is exposing us to a whole new spectrum of notions and methods of problem definition and problem evaluation. We no longer have a valid excuse for jumping to conclusions, for we can now test assumptions by manipulating within a relatively short time mountains of data that once would have taken lifetimes to process.

We hope that the computer's special ability to foster careful thinking will be put to many more applications, especially in the social sciences. The natural sciences enjoy a particular advantage over the social sciences in their long tradition of laboratory experimentation. While social science teachers must expound social theories, physics teachers can provide concrete illustrative demonstrations and have their students deliberately experiment with and test the principles that are considered important.

Although people are not as easy to

manipulate as pulleys, temperatures, and pressures, social scientists presume to employ the same scientific methods so handy to "hard" scientists. The absence of a "social science laboratory" and the general impossibility of performing controlled social experiments, however, frequently allow and even encourage impressionistic explanations based on the most unscientific of social science analyses. Popular social values and conventions often seriously distort and bias social scientists' approach to research. Let's look at an example, and then consider how the computer might be used to simulate a social science laboratory.

Why a Model?

If one were to ask a group of students why the neighborhoods of most multiracial communities are generally more segregated than integrated, the students would probably say that the segregation was due

Explore the excellence of your ZX81 with a

MEMOPAK

MEMOPAK

MEMOPAK

MEMOPAK

MEMOPAK



MEMOPAK 64k memory extension for **\$179.95** Give your diminishing memory more byte.

MEMOPAK 64K RAM \$179.95

The Sinclair ZX81 has revolutionized home computing. The MEMOPAK 64K RAM extends the memory of ZX81 by a further 56K to a full 64K. It is neither switched nor paged and is Directly Addressable. The unit is user transparent and accepts such basic commands as 10 DIM A (9000). It plugs directly into the back of ZX81 and does not inhibit the use of the printer or other add-on units. There is no need for an additional power supply or leads.

Description of memory

0-8K . . . Sinclair ROM

8-16K . . . This section of memory switches in or out in 4K blocks to leave space for memory mapping, holds its contents during cassette loads, allows communication between programs, and can be used to run assembly language routines.

16-32K . . . This area can be used for basic programs and assembly language routines.

32-64K . . . 32K of RAM memory for basic variables and large arrays. With the MEMOPAK 64K extension the ZX81 is transformed into a powerful computer, suitable for business, leisure and educational use, at a fraction of the cost of comparable systems.

MEMOTECH
Memory Extension Specialists

Memotech Corporation
7550 West Yale Ave., Suite 200
Denver, Colorado 80227
Ph. (303) 986-1516

MEMOPAK 16K RAM \$59.95

With the addition of MEMOPAK 16K, your ZX81 will have a full 16K of Directly Addressable RAM. It is neither switched nor paged and enables you to execute longer and more sophisticated programs and to hold an extended data base.

The 16K and 64K Memopaks come in attractive, custom-designed and engineered cases which fit snugly on to the back of the ZX81 giving a firm connection.

Free service on your MEMOPAK

Within the first six months, should anything go wrong with your MEMOPAK, return it to us and we will repair or replace it free of charge.

Try MEMOPAK with no obligation

You can use our MEMOPAK in your home without obligation. After 10 days if you are not completely satisfied, simply return it for a full refund.

Coming soon

A complete range of ZX81 plug-in peripherals:

MEMOTECH Hi-Res Graphics
MEMOTECH Digitising Tablets
RS232 Interface
Centronic Interface and
Software Drivers

All these products are designed to fit "piggy-back" fashion on to each other and use the ZX81 power supply.

Further information forthcoming.

Memotech Corp. 7550 W. Yale Ave. Suite 200 Denver, Colo. 80227

Yes! I would like to try the Memopak. I understand that if I'm not completely satisfied, I can return it in 10 days for a full refund.

	Price †	Qty.	Amount
<input type="checkbox"/> Check	Memopak 64k RAM	\$ 179.95	
<input type="checkbox"/> Visa	Memopak 16k RAM	\$ 59.95	
<input type="checkbox"/> MC	Shipping and Handling	\$ 4.95	\$ 4.95
			Total

Act. No. Exp.

† U. S. Dollars

Name

Street

City State Zip

BYT07

INTEGRATED BUSSING



with the

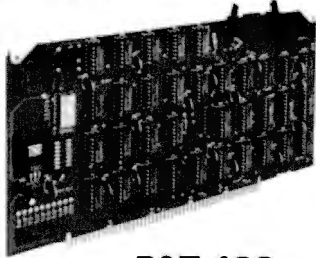

P&T-488
INTERFACE

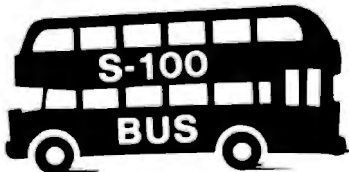

Inexpensive S-100 computers can now communicate with the IEEE-488 instrumentation bus. The P&T-488 meets the IEEE-488 1980 standard for **control**, **listener**, & **talker**.

Interface **software** allows simple communication with the 488 bus from Basic, Pascal and other high level languages. Interface software is available for CP/M®, North Star, or Cromemco.

Special features include an interactive **busmonitor** program and a functional self-test program.

Price for (1) P&T-488 with software and 18" cable, assembled and tested: \$450 (domestic price) FOB Goleta, CA.



PICKLES & TROUT

P.O. BOX 1206, GOLETA, CA 93116
(805) 685-4641

*CP/M is a registered trademark of Digital Research

to prejudice, racism, or the like. Their explanations might come from selected personal experiences or they might simply be restatements of what the students have been told. In fact, there is little hard scientific evidence on which to decide whether "prejudice" is actually a cause or a consequence of segregation.

If we had a "human laboratory," we might test this hypothetical question by creating a racially random neighborhood, populating it with people who were known to be "without prejudice," and observing whether or not in fact the neighborhood remained stable in the integrated state, recording whatever changes were observed. This experiment would certainly cast light on the process of neighborhood development, but it would obviously be so difficult to control and so expensive that it could never be performed. Furthermore, the experimenters would all die of old age before the study had processed more than a couple of generations of residents.

Until the computer era we would have been out of luck, but now we have an alternative that is in some ways better than the real thing. We can now simulate whatever variables we wish, create a situation, set the controls, and let the computer simulate the process quickly and without extraneous variables. The unique contribution of microcomputers to this process is that now this kind of computer simulation is available to almost everyone. You no longer have to have access to an expensive computer; every microcomputer is a potential social science laboratory.

Simulation Guidelines

The program presented here, based on the work of Thomas Schelling, is designed primarily for the student user-operator. In it we allow simulation of neighborhood formation using two identifiable types of individuals (or ethnic groups) represented by graphic images on the screen and referred to in the text as Xs and Os, whose attitudes toward their neighbors are under the experimenter's control.

We have had several surprises in the process of developing this simulation, and they've generated so much discussion between us that we see it as a potentially valuable learning tool, especially because at every stage we are provided with a map of the ethnic distribution of our hypothetical community. We feel that the element of surprise stimulates learning.

In our simulation, for example, we can begin with two types of persons who don't necessarily dislike each other. In fact, they may both prefer to live in an integrated neighborhood, but let's suppose that each would prefer not to be in the minority with respect to his immediate neighbors. This differentiation does not have to be ethnic or racial. One person's preference for classical music to the other's preference for rock (which is not to say that one actually dislikes the preferred music of the other) is an example of a nonethnic distinction. It's not that you can't stand the other's music, it's just nice to have a few neighbors of like taste to trade tapes with.

Let's assume, for the sake of our experiment, that each household regards only the four households on its north, south, east, and west as its immediate neighbors. If we begin with a randomly arranged neighborhood composed of equal numbers of Xs and Os, let's also begin with the supposition that every household abutted by *more than* two neighbors of the alternative type will eventually want to move to a more compatible neighborhood. The possibilities outside our experimental neighborhood are infinite, of course, so the households that move away simply vanish into the outside world. When the first such outnumbered household moves out, the space vacated can be filled only by a household of the alternative type. But when the latter moves in, it may upset the balance of another neighbor that in turn will move out, leaving yet another space to be filled only by a member of the other group.

The succession of moves results in a ripple effect that eventually makes itself felt over a large part of the neighborhood. Because each family

Announcing the Printing Breakthrough of the Century: Smith-Corona® TP-1™ Text Printer



- Low Cost Daisy Wheel Printer

\$799⁰⁰

- Microprocessor Electronics
- Serial or Parallel Interface
- Simple, Reliable Mechanism

ACT NOW: Limited Supply, Low, Low Cost

Smith Corona, one of the largest manufacturers of small printers in the world, gives a whole new perspective to printing with their electronic text printer—TP-1. The TP-1 is a microprocessor controlled, high quality **daisy wheel printer**. It produces perfectly formed, executive quality printouts at the speed of 120 words per minute. Typewriter quality printing at dot matrix prices.

Simple, durable and dependable, TP-1 may be used with word processing systems, microcomputers and most small business systems. Compact and attractively



Additional daisy print wheels \$4.95



Additional ribbons \$2.95

styled, the TP-1 blends well with any setting.

Now, all your letters, documents forms and reports can have the crisp, professional look you demand—for business or personal use—at an affordable price. TP-1, the electronic text printer.

Don't delay. Order your TP-1 TODAY at the low price of \$799.

Micro Printer Marketing offers same day shipping, nationwide service and invites dealer inquiries. Catalogues available. No shipping charges on pre-paid orders.

**Micro™
Printer
Marketing**

Call Micro-Printer Marketing

CALL TOLL FREE **1-800-523-9859** MasterCard and Visa Accepted

In PA Call Collect 215 / 433-3366





THE \$295 SOFTWARE DEALER DEMO SYSTEM

SAVE 97% ON DEMO SOFTWARE

We both know from experience that the best way to sell computers is with demonstration. The problem has always been finding quality software that is affordable for demonstration purposes.

Our software is not inexpensive, but we have developed an exclusive demonstration system that helps us both. It gives you the ability to demonstrate a broad range of business applications, and it gives us the opportunity to prove the quality of our product.

The package includes all the software listed below, plus important promotional materials and our exclusive video sales presentation designed to help you make the sale . . . all for just \$295.00. That represents a savings of 97% on the software we're making available to you.

If you believe in demonstration, we believe we have the best demonstration value in the microcomputer industry. Just give us a call, or drop us a card.

FINANCIAL

General Ledger • Accounts Payable • Accounts Receivable • Payroll • Cash Receipts/Disbursements • Job Costing • Mailing List Management

MEDICAL/DENTAL

Office Scheduler • Patient Billing • Accounts Receivable • Insurance Forms

GOVERNMENTAL/EDUCATIONAL

Student Record Keeping • Student Scheduling • Fund Accounting

WHOLESALE DISTRIBUTION

Purchasing and Receiving • Inventory Control • Invoicing and Receivables • Sales Commission Reporting • Backorder Management

MANUFACTURING INVENTORY CONTROL

Finished Goods Inventory Management • Parts Inventory Management • Parts Purchasing and Receiving • Bill of Material • Production Scheduling

All IMS business applications require CP/M* or MP/M* and CBASIC II* registered trademarks of Digital Research Corp.

Call for details (913)677-1137



INTERNATIONAL MICRO SYSTEMS
6445 METCALF • SHAWNEE MISSION, KS. 66202

moving out is replaced by a family of the alternative preference, the community must gradually become more segregated. Thus a high degree of segregation can develop in our random community, even though neither group feels any particular aversion to the other, except for a discomfort at being in the minority.

As Schelling has pointed out (*Micromotives and Macrobehavior*, New York: W.W. Norton & Co., 1979, pp. 147-155) this process can be demonstrated by placing pennies and dimes on a checkerboard, or through the use of a high-speed computer. However, the checkerboard technique is painfully tedious and the results are crude and oversimplified, and the use

of the big computer is not instructive because it doesn't give the student a hands-on experience. Our microcomputer simulation tries to combine the best of both approaches in that it allows the student to control an experiment involving 384 households and view the process in a more vivid and dramatic form on the screen. Further, the video output from the computer can be displayed so that many students can see the results as they occur.

Analysis of the Program

The best way to discuss the program and its ramifications is to go through it step by step. The main

body of the program begins at line 60 (see listing 1), which calls the introduction subroutine at lines 8000-8660. In this subroutine, the program first asks whether execution of the program will require halts between iterations. Although the halts will slow the execution of the program, they allow time for careful observation of intermediate stages and for discussion of the changes in the neighborhood. In the classroom, the halts allow the instructor to ask students to predict changes in the shape of the community: for example, to predict which households will vacate, which type of household will move in to occupy the vacancies, what effect the changes will have on

Text continued on page 192

Listing 1: *The neighborhood-segregation program. Written in Microsoft BASIC, the program first goes to an introduction subroutine at line 8000. At lines 8070-8080, the program lets you choose to start with either a planned, integrated neighborhood or a random neighborhood. If you choose the planned neighborhood, the program assumes that both types of residents want at least half of their four immediate neighbors to be members of their own group. If you choose the random neighborhood, the program asks (at lines 8180-8200) how many neighbors the Xs require to be Xs, and (at lines 8270-8290) how many neighbors the Os require to be Os. The integration index, computed in the subroutine starting at line 7000, shows the proportion of dissimilar neighbors surrounding the average household.*

```

1 REM *** NEIGHBORHOOD SEGREGATION ***
2 REM *** BY CARL MOODY AND EDWIN DETHLEFSEN ***
3 REM *** COLLEGE OF WILLIAM AND MARY ***
4 REM *** WILLIAMSBURG, VA. 23185 ***
5 REM *** (804) 253-4377 ***
10 RANDOM
20 DEFINT A-Z
30 DIM A(14, 34)
40 CLS
50 GOSUB 12000
60 GOSUB 8010
70 IF B=1 THEN L=768: W=192: GOTO 120
80 CLS
90 PRINT @ 15, "UNHAPPY HOUSEHOLDERS MOVE OUT"
100 GOSUB 4020
110 IF D=1 THEN GOSUB 6010
120 CLS
130 PRINT @ 19, "NEW HOUSEHOLDERS MOVE IN"
140 PRINT @ 69, "ITERATION NO. "; Y; " PERCENT "; CHR$(134); "="; INT((W/(384-F))*100);
" INTEGRATION INDEX="; INT((L/((384-F)*4)-88))*100)
150 K=128
160 FOR I=2 TO 13
170 FOR J=2 TO 33
180 GOSUB 5010
190 IF A(I, J)=1 THEN PRINT @ K, CHR$(134)
200 IF A(I, J)=2 THEN PRINT @ K, CHR$(143)
210 K=K+2
220 NEXT J
230 NEXT I
240 Y=Y+1
250 IF D=1 THEN GOSUB 6010
255 FOR ZZ=1 TO 2000:NEXT ZZ
260 GOTO 80
3000 REM *** CHECKING NEIGHBORS SUBROUTINE ***

```

Listing 1 continued on page 186

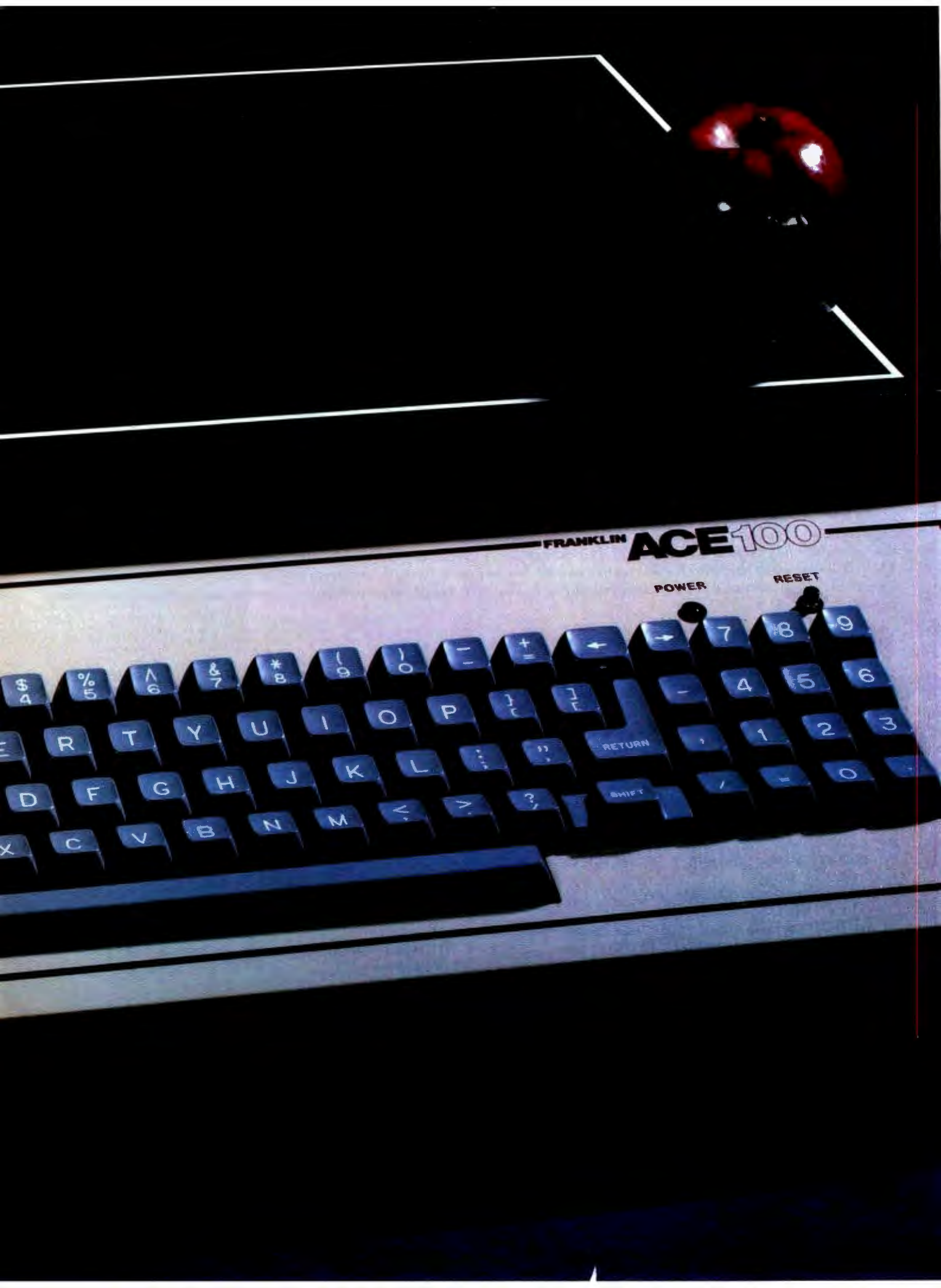

FRANKLIN **ACE100**

POWER

RESET

WHAT IS SWEETER THAN AN APPLE?

THE FRANKLIN **ACE**100

The Franklin ACE 100 is hardware and software compatible with the Apple[®] II. It is sweeter because it is more versatile, it includes 64K of RAM memory and—it costs less.

Any program that runs on the Apple II will run on the Franklin ACE 100. Any peripheral that works with Apple will work with ACE. The Franklin ACE 100 generates upper and lower case characters and includes a numeric pad, an alpha lock key and VisiCalc[™] keys.

The Franklin ACE 100—a professional personal computer with the quality and reliability for the most demanding business applications. It is sweeter than an Apple. Call or write today for the name of your local authorized Franklin dealer.



FRANKLIN
COMPUTER CORPORATION

7030 Colonial Highway
Pennsauken, NJ 08109
609-488-1700

Circle 185 on Inquiry card.

Franklin ACE is a trademark of Franklin Computer Corporation.
Apple is a registered trademark of Apple Computer Inc.
VisiCalc is a registered trademark of Visi Corp.

Listing 1 continued:

```
3010 H=0
3020 IF A(I-1, J)=A(I, J)OR A(I-1, J)=0 THEN H=H+1
3030 IF A(I+1, J)=A(I, J)OR A(I+1, J)=0 THEN H=H+1
3040 IF A(I, J-1)=A(I, J)OR A(I, J-1)=0 THEN H=H+1
3050 IF A(I, J+1)=A(I, J)OR A(I, J+1)=0 THEN H=H+1
3060 RETURN
4000 REM *** MOVING OUT SUBROUTINE ***
4010 F=0
4020 L=0
4030 E=0
4040 W=0
4050 K=128
4060 F=0
4070 FOR I=2 TO 13
4080 FOR J=2 TO 33
4090 IF A(I, J)=0 THEN PRINT @ K, "":F=F+1: GOTO 4170
4100 GOSUB 3010
4110 L=L+(4-H)
4120 IF A(I, J)=1 THEN W=W+1
4130 IF A(I, J)=1 AND H<M THEN A(I, J)=0: PRINT @ K, "": E=E+1
4140 IF A(I, J)=2 AND H<N THEN A(I, J)=0: PRINT @ K, "": E=E+1
4150 IF A(I, J)=1 THEN PRINT @ K, CHR$(134)
4160 IF A(I, J)=2 THEN PRINT @ K, CHR$(143)
4170 K=K+2
4180 NEXT J
4190 NEXT I
4200 IF E=0 GOTO 11010
4210 FOR ZZ=1 TO 2000:NEXT ZZ
4220 RETURN
5000 REM *** MOVING IN SUBROUTINE ***
5010 IF A(I, J)<>0 THEN RETURN
5020 A(I, J)=1
5030 GOSUB 3010
5040 Q=H
5050 A(I, J)=2
5060 GOSUB 3010
5070 R=H
5080 IF Q>=M AND R>=N THEN A(I, J)=RND(2)
5090 IF Q>=M AND R<N THEN A(I, J)=1
5100 IF Q<M AND R>=N THEN A(I, J)=2
5110 IF Q<M AND R<N THEN A(I, J)=0
5120 RETURN
6000 REM *** INKEY ROUTINE ***
6010 PRINT @ 979, "TO CONTINUE PRESS ANY KEY"
6020 IF INKEY$="" THEN 6020
6030 RETURN
7000 REM *** INTEGRATION INDEX SUBROUTINE ***
7010 L=0
7020 W=0
7030 FOR I=2 TO 13
7040 FOR J=2 TO 33
7050 IF A(I, J)=1 THEN W=W+1
7060 GOSUB 3010
7070 L=L+(4-H)
7080 NEXT J
7090 NEXT I
7100 RETURN
8000 REM *** INTRODUCTION SUBROUTINE ***
8010 PRINT @ 512, "DO YOU WANT THE PROGRAM TO STOP BETWEEN ITERATIONS (Y/N)?"
8020 D$=INKEY$
8030 IF INKEY$ <>"" THEN 8040
8040 IF D$="Y" THEN D=1
8050 IF D$<>"Y" AND D$<>"N" THEN GOTO 8020
8060 CLS
8070 PRINT @ 512, "TO START WITH A PLANNED INTEGRATED NEIGHBORHOOD, PRESS 1"
8080 PRINT @ 576, "TO START WITH A RANDOM NEIGHBORHOOD, PRESS 2"
```

Listing 1 continued on page 188

NEC

PC-8001A CPU/32K ...\$725



Authorized Dealer

For NEC products circle Reader Service # 49

VIC-20

Commodore\$239

BROTHER DAISYWHEEL

• 16 cps • Selectric ink cartridge

HR-1P Parallel\$855
HR-1S Serial\$895**EPSON**

With Graphtrax Plus. Factory Installed

MX-80III\$412
MX-80FT III\$522
MX-100 III\$692

For Epson Products circle Reader Service # 50

TELEVIDEO TS 802 Computer \$2665• 950 Terminal Features • Dual floppies, 720K total
• 64K Z 80A 4MHZ, CP/M • Network expansionTS-802H\$4990
TV1-910\$575
TV1-925\$725
TV1-950\$915**AMDEK**

• 12" green monitor • Anti-glare filter

AM300G\$137
• 13" RGB • IBM/Apple/NEC
Color II\$635**BMC INTERNATIONAL**

• 12" green monitor, P-31 • 15MHZ

• 80 x 24 character display

BM-12A\$88

• 13" color, composite • audio/video

• 270 line resolution

BM-1400CL\$273

PRODUCTS FOR APPLEAP-16 16K Ram Card\$68
V-80 Videx Videoterm w/ Softswitch\$258
MS-Z Microsoft Z-80 Softcard\$253
MS-PS Microsoft Premium System\$529
AP-B1 Bison Drive w/ 3.3\$459
AP-B2 Bison Drive Add-On\$349
AP-PAR Parallel Printer Card/Cable\$72
DC-2 Hayes Micromodem II\$271
NAT Novation Apple CAT\$325

For Apple Products circle reader service # 51

PRODUCTS FOR IBMIB-T1 Tandon drive-1 side\$255
IB-T2 Tandon drive-2 side w/ DOS Patch\$485
IB-T3 Tandon drive-80 track,
2 side, w/ DOS Patch\$595
AST-64 AST 64K card\$365
RAM-9 9 pcs, 64K Rams\$75

For IBM products circle reader service # 52

VIDEO MONITORSAM-300G 12" green, Amdek\$137
AM-C1 Color I, Amdek\$299
AM-C2 Color II, Amdek\$635
BM-12A 12" green, BMC\$88
BM-1400CL 13" std. BMC\$273
JB-1201 NEC 12" green\$159
JC-1201 NEC 13" color, std.\$325
JC-1202 NEC 13" RGB\$815
Z-12G 12" green, Zenith\$115**BISON PRODUCTS****MAIL ORDERS:**P.O. Box 9078-184
Van Nuys, CA 91409**WILL CALLS:**16709 Roscoe Boulevard
Sepulveda, CA 91343
(213) 891-5702Please confirm price and availability
by phone prior to ordering.

We accept VISA and Mastercard.

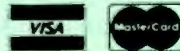
Shipping additional-\$3 minimum.
Calif. residents add 6% sales tax.

Overseas orders and dealer inquiries accepted.

All merchandise is new and
comes with factory guarantee.For Additional Product Information,
circle reader service #53**PRINTERS**MX-80 III Epson 80 cps\$412
MX-80 F/T III Friction, Tractor, Graphics\$522
MX-100 III 80 cps, wide\$692
PC-8023 NEC, 120 cps\$485
OK-82A Oki, U82A, w/ tractor\$460
OK-83A Oki, U83A, w/ tractor\$685
OK-84PS U84, 200 cps, par/serial\$1125
PRO-A Prowriter, parallel\$485
PRO-B Prowriter, parallel/serial\$610
F-10A -40 cps Daisy, parallel\$1395
F-10B -40 cps, serial\$1495
HR-1P Brother Daisy, parallel\$855
HR-1S Brother Daisy, serial\$895**SIERRA DATA SCIENCES****S-100 Master/Slave Single Board Computers**Master 4MHZ Z80A\$690
Slave 4MHZ Z80A\$625
CP/M\$160
BIOS\$100
Manual\$25
Winchester Adaptor\$145
Turbo DOS\$750104/1 5 1/4" soft\$35
14/1D 5 1/4" soft, double density\$42
3-80/1 8" soft\$45
3480/2D 8" soft, dsdd\$63**MikroPro SOFTWARE**MP-WS8 Word Star, 8"\$250
MP-WSA Word Star, Apple\$192
MP-MM8 Mail Merge, 8"\$ 77
MP-MMA Mail Merge, Apple\$ 63
MP-SS8 Spell Star, 8"\$127
MP-SSA Spell Star, Apple\$105
MP-DS8 Data Star, 8"\$175
MP-SR8 Super Sort, 8"\$127
MP-SRA Super Sort, Apple\$100
MP-SII8 Super Sort II, 8"\$105
MP-CS8 Calc Star, 8"\$149Many additional software packages are available
at similar discounts.**DISK DRIVES**Q-842 Qume #842 (replaces DT-8)\$480
MI-2D Mitsubishi 8" dsdd\$435
TN-1 Tandon Thin 8" ssdd\$382
TN-2 Tandon Thin 8" dsdd\$465**AB DIGITAL DESIGN LABS****256K BYTE - 128K****WORD DYNAMIC MEMORY S-B810A**• 4MHZ with Extended DMA
• IEEE696, Multi-Layer List\$1245
• 1 Year Warranty BISON\$825**STATIC MEMORY SYSTEMS 64K**• 24 Line Addressing
• 200NS, Lower Power CMOS
• Intermix RAM and EPROM
• New Super Low Price
S-ST64 List\$594 BISON\$440**8086 SUPER MICRO****SEATTLE COMPUTER**• 8 MHZ 8086 S-100 SET • Cable for 2 8" Drives
• 128K 70NS Static RAM • MS-DOS (86-DOS)
• DD Disk Controller • Add Drives and Terminal!
• 22 Slot Mainframe

SC-SYS2 System 2 List...\$4185 BISON\$3450

SC-2/3 8086 2 BRD Set w/DOS

List\$795 BISON\$595

QT S-100 & 8" Drive Mainframe• +8V(± 25A) / ±16V(± 5A) S-100 Power
• +5V(± 2.5A) / -5V(± .5A) / +24V(± 3A) Drive Power• Keypad Power Switch
• Shielded Motherboard
• Rugged Card Cage
• 9% x 17" x 21" (HxWxD)
• Strappable 110V or 220V AC

QT-MF6 6 Slot, 2-8" Drive\$555

QT-MF8 8 Slot, 2-8" Drive\$580

QT-MF12 12 Slot, 2-8" Drive\$605

QT S-100 & 5 1/4"**Drive Mainframe**• Similar to 8" Mainframe
• Power for 5 1/4" Drives
• 7" x 17" x 20" (HxWxD)

QT-5MF6 6 Slot, 2-5 1/4" Drive\$380

QT-5MF8 8 Slot, 2-5 1/4" Drive\$405

QT-5MF12 12 Slot, 2-5 1/4" Drive\$430

SIGNALMAN MKI 300 BPS MODEM

BISON\$89

**trah Dual 8" Drive Cabinet**• Signal extender cable
• Vertical mount • Write protect switches on front
• Power supply, fan • Highest quality construction
BISON\$325

Listing 1 continued:

```
8090 PRINT @ 640, "IF YOU START WITH A PLANNED INTEGRATED NEIGHBORHOOD,"
8100 PRINT @ 704, "THEN BOTH TYPES OF PEOPLE ARE CONTENT AS LONG AS"
8110 PRINT @ 768, "THEY ARE NOT IN THE MINORITY"
8120 C$=INKEY$
8130 IF C$="" THEN 8120
8140 IF VAL(C$)<1 OR VAL(C$)>2 THEN 8120
8150 B=VAL(C$)
8160 IF B=1 THEN GOTO 9010
8170 CLS
8180 PRINT @ 512, "HOW MANY NEIGHBORS, OUT OF FOUR, DO THE X'S DEMAND TO BE"
8190 PRINT @ 576, "LIKE THEMSELVES"
8200 PRINT @ 640, "PRESS A NUMBER BETWEEN ZERO AND FOUR"
8210 C$=INKEY$
8220 IF C$="" THEN 8210
8230 IF VAL(C$)<0 OR VAL(C$)>4 THEN 8210
8240 PRINT @ 680, C$
8250 M=VAL(C$)
8260 CLS
8270 PRINT @ 512, "HOW MANY NEIGHBORS, OUT OF FOUR, DO THE O'S DEMAND TO BE"
8280 PRINT @ 576, "LIKE THEMSELVES"
8290 PRINT @ 640, "PRESS A NUMBER BETWEEN ZERO AND FOUR"
8300 C$=INKEY$
8310 IF C$="" THEN 8300
8320 IF VAL(C$)<0 OR VAL(C$)>4 THEN 8300
8330 PRINT @ 680, C$
8340 N=VAL(C$)
8350 CLS
8360 PRINT @ 512, "ENTER THE PROPORTION OF X'S IN THE RANDOM NEIGHBORHOOD,"
8370 PRINT @ 576, "1 IN ?"
8380 C$=INKEY$
8390 IF C$="" THEN 8380
8400 PRINT @ 583, C$
8410 C=VAL(C$)
8420 CLS
8430 PRINT @ 17, "SETTING UP A RANDOM NEIGHBORHOOD"
8440 FOR I=1 TO 14
8450 FOR J=1 TO 34
8460 A(I, J)=0
8470 NEXT J
8480 NEXT I
8490 FOR I=2 TO 13
8500 FOR J=2 TO 33
8510 X=RND(C)
8520 IF X=1 THEN A(I, J)=1 ELSE A(I, J)=2
8530 NEXT J
8540 NEXT I
8550 CLS
8560 GOSUB 10010
8570 PRINT @ 7, "PLEASE WAIT WHILE I COMPUTE THE INTEGRATION INDEX"
8580 GOSUB 7010
8590 Y=1
8600 PRINT @ 900, "ITERATION NO. "; Y; " PERCENT "; CHR$(134); "="; INT((W/384)*100); "
INTEGRATION INDEX="; INT((L/1536)*100)
8610 IF D=1 THEN GOTO 8650
8620 FOR I=1 TO 4000
8630 NEXT I
8640 RETURN
8650 GOSUB 6010
8660 RETURN
9000 REM *** INTEGRATED NEIGHBORHOOD SUBROUTINE ***
9010 CLS
9020 PRINT @ 14, "SETTING UP AN INTEGRATED NEIGHBORHOOD"
9030 PRINT @ 78, "PERCENT "; CHR$(134); "= 50 INTEGRATION INDEX= 50"
9040 N=2
9050 M=2
9060 X=RND(2)
```

Listing 1 continued on page 190

COBOL the language of business.

The language of Micro Focus

CIS COBOL

Our CIS COBOL product family brings you the most successful business programming tool ever devised, COBOL, in a form optimized for today's most cost effective hardware, the microcomputer. Standard COBOL as defined by ANSI X3.23-1974.

The reliability and performance of CIS COBOL are strongly emphasized by its' continued qualification for U.S. government contracts. In January 1981 CIS COBOL entered its 2nd year of G.S.A. certification.

CIS COBOL is powerful but simple to use. Its screenhandling, dynamic module loading and fast ISAM let you take full benefit from micro computer facilities.

Our FORMS-2 utility is a COBOL source code generator to help you build interactive applications with ease. Using our unique demonstration "How to create a COBOL program in 20 minutes," you can quickly try out new application ideas.

And if you are developing software for resale, the variety of systems running CIS COBOL offers you a very large available market.



CIS COBOL and FORMS-2 are trademarks of Micro Focus. 8080 is a trademark of Intel Corp. Z80 of Zilog, LSI-11 and PDP-11 of Digital Equipment Corp. Apple II of Apple Computer, Softcard of Microsoft Consumer Products, CP/M of Digital Research and UNIX of Bell Laboratories.

WITH
FORMS-2

CIS COBOL and FORMS-2 are available through our dealers and distributors for many 8080, Z80 and LSI-11 systems including Apple II with Softcard and CP/M.

For OEM purchase on 8086, PDP-11, UNIX and other order codes approach us direct. Our system transfer technology has made CIS COBOL first on a number of processors and enabled us to interface to 30 different operating systems.

For more information about CIS COBOL fill in the coupon below.

To: Micro Focus Inc. 1601 Civic Center Drive,
Santa Clara, Ca 95050, USA.
Phone: (408) 496 0176. Telex: 278704 MFCIS UR

Please send me

- A brochure on CIS COBOL
- A brochure on FORMS-2
- A set of Applications Notes

..... (Qty) CIS COBOL manual(s) at \$75
(inc. p+p) for which I enclose a check
for \$.....

My chief interest is in: (please tick box)

- 8080
- 8086
- UNIX
- Apple II

Name

Position

Company

Address

Tel No.....

Listing 1 continued:

```
9070 FOR I=1 TO 14
9080 FOR J=1 TO 34
9090 A(I, J)=0
9100 NEXT J
9110 NEXT I
9120 J=2
9130 I=2
9140 A(I, J)=X
9150 I=I+1
9160 IF I<=13 THEN 9140
9170 IF X=1 THEN X=2: GOTO 9190
9180 IF X=2 THEN X=1
9190 J=J+1
9200 IF J<=33 THEN 9130
9210 Y=1
9220 CLS
9230 GOSUB 10010
9240 PRINT @ 909, "RANDOM HOUSEHOLDERS WILL MOVE OUT"
9250 FOR I=2 TO 13
9260 FOR J=2 TO 33
9270 E=RND(6)
9280 IF A(I, J)=E THEN A(I, J)=0
9290 NEXT J
9300 NEXT I
9310 IF D=1 THEN GOSUB 6010
9320 CLS
9330 PRINT @ 15, "RANDOM HOUSEHOLDERS MOVING OUT"
9340 GOSUB 10010
9350 Y=1
9360 IF D=1 THEN GOSUB 6010
9370 RETURN
10000 REM *** PRINT SUBROUTINE ***
10010 K=128
10020 FOR I=2 TO 13
10030 FOR J=2 TO 33
10040 IF A(I, J)=1 THEN PRINT @ K, CHR$(134)
10050 IF A(I, J)=2 THEN PRINT @ K, CHR$(143)
10060 K=K+2
10070 NEXT J
10080 NEXT I
10090 RETURN
11000 REM *** STOPPING ROUTINE ***
11010 PRINT @ 901, "THE NEIGHBORHOOD IS STABLE, NO ONE WILL MOVE IN OR OUT"
11020 PRINT @ 965, "ITERATION NO. "; Y; " PERCENT "; CHR$(134); "="; INT((W/(384-F))*100); "
INTEGRATION INDEX="; INT((L/(((384-F)*4)-88))*100)
11030 END
12000 REM *** COPYRIGHT BLOCK ***
12010 PRINT CHR$(23)
12020 PRINT
12030 PRINT
12040 PRINT" * * * * * "
12050 PRINT
12060 PRINT
12070 PRINT" NEIGHBORHOOD SEGREGATION
12080 PRINT
12090 PRINT" * * * * * "
12100 PRINT
12110 PRINT
12120 PRINT"A PROGRAM IN MICROSOFT BASIC BY
12130 PRINT"CARL MOODY AND EDWIN DETHLEFSEN"
12140 PRINT" COLLEGE OF WILLIAM & MARY"
12150 PRINT
12160 PRINT"COPYRIGHT (C) 1981.<TOUCH A KEY>
12170 GOSUB 6020
12180 CLS
12190 RETURN
```

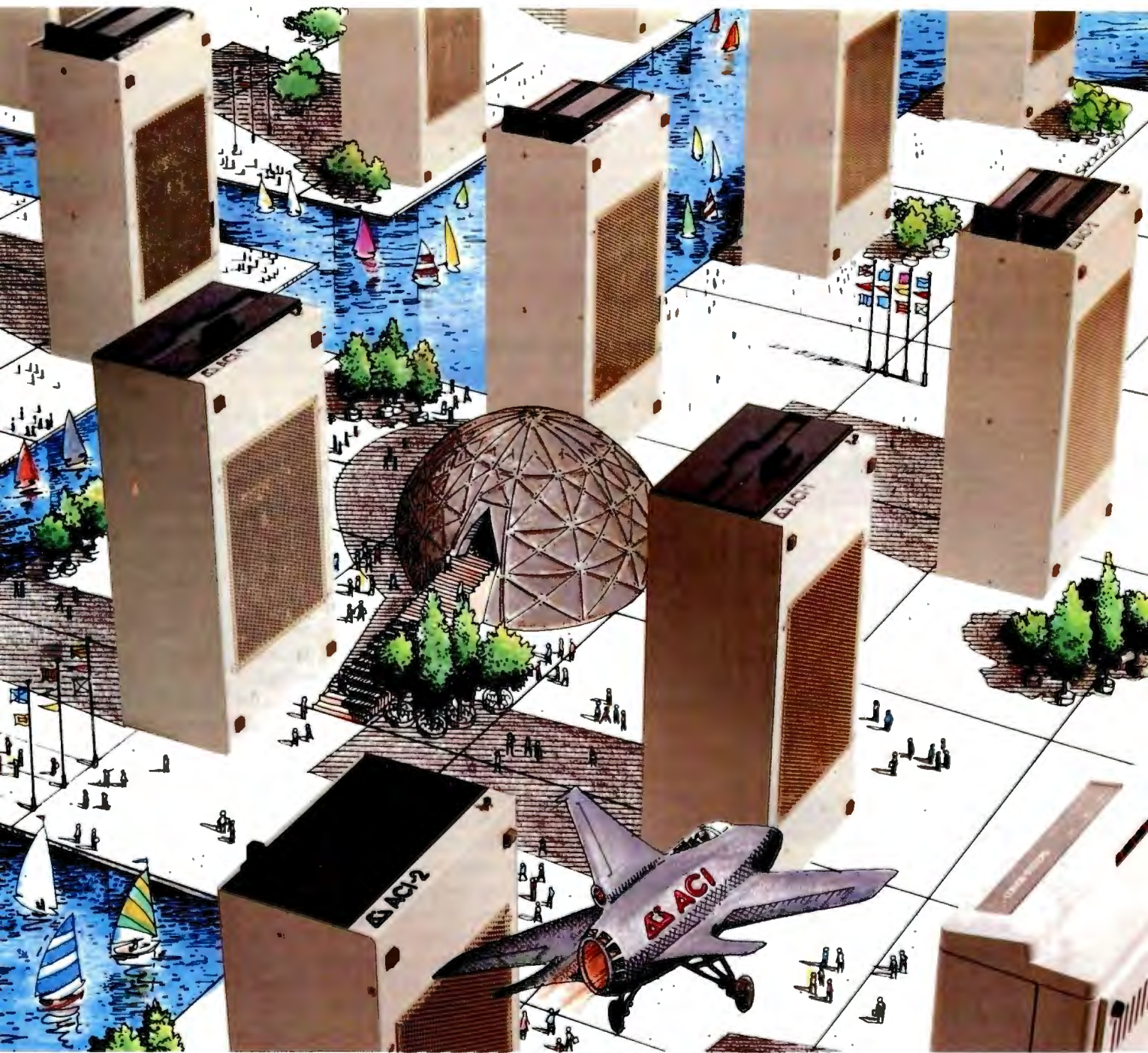

Alspa Computers PLUS Multi-User Hard Disk



SMALL SIZE AND LOW COST

ALSPA full performance, CP/M computers are the smallest 8" drive micro's around. An ALSPA computer with a 4 MHz Z80A CPU, 64K of RAM, one or two 8" floppy drives, three RS-232 serial ports, one parallel port, and one hard disk port is no larger than most single add-on drives, and weighs only about 18 lbs. An ACI-1 can be yours for as little as \$1995.00 plus CP/M.

CORVUS** INTERFACE

Standard on all ALSPA computers in a hardware interface which connects directly to either a Corvus hard disk drive or a Corvus Constellation**, multi-user hard disk system. Our Corvus operation system is easy to install and use.

SUPERIOR PERFORMANCE

One demonstration will prove that our compact and durable ALSPA computers are designed to provide dependable, powerful computing service. Look at capability and speed and you'll agree we're the best value for the dollar.

DEALER INQUIRIES INVITED



Alspa Computer, Inc.

MORE THAN OUR NAME IS UNIQUE

300 Harvey West Blvd., Santa Cruz, CA 95060 (408) 429-6000

*CP/M is a trademark of DIGITAL RESEARCH INC

Circle 19 on inquiry card.

**Corvus and Corvus Constellation are trademarks of CORVUS SYSTEMS, INC

We Beat All Prices!

hp HEWLETT
PACKARD
HP-85
or
HP-125
CP/M[®] based
\$1979
Your Choice



NEW HP-87... \$1889

- 5 1/4" DUAL MASTER DISK DRIVE..... \$1595
- HP-7470 PLOTTER..... \$1245
- 5 MEG. WINCHESTER HARD DISK..... \$3599
- 5 MEG. WIN. w/5 1/4" DD,SD FLOPPY..... \$4399

- APPLE II PLUS 48K..... CALL
- APPLE III 128K..... CALL
- NEC PC8001A 32K..... \$849
- NEC PC8031 DUAL DISK..... \$849
- SHARP PC1500 POCKET COMPUTER... \$249
- SHARP CE150 FOUR COLOR PRINTER... \$215
- SMITH-CORONA DAISY-WHL. PRNTR. \$696

- TI CALCULATORS— TI-55 II..... \$36
- TIP BUSINESS ANALYSIS II..... \$36
- TIP-58C..... \$79
- TIP-59..... \$189
- TIP-100C..... \$149

HP-41CV \$237 HP-41C \$189

up to Five times more memory List. \$325

- HP-41CV PRINTER..... \$289
- HP-41CV OPTICAL WAND..... \$99
- HP-41CV CARD READER..... \$165
- HP-821060A HP-IL MODULE..... \$99
- HP-82161A DIGITAL CASSETTE DRIVE, \$419
- HP-82162A IL PRINTER..... \$376
- HP-41C/CV EXT. FUNC. MEM. MOD. \$62.75
- HP-41C/CV EXTENDED MEM. MOD. \$62.75
- HP TIME MODULE..... \$62.75
- HP-11C..... \$107.95
- HP-12C..... \$119.95

ATARI[®] 800 \$659



ATARI 400 \$319

- ATARI 16K MEMORY MODULE..... \$75.00
- ATARI 823 80 COL. IMPACT PRNTR... \$585
- ATARI 410 PROGRAM. RECORDER..... \$79
- ATARI 810 DISK DRIVE..... \$419

—APPLE OWNERS—

APPLE II CP/M[®] Conversion Special
Included MicroSoft Softcard, (a board with Z-80, with MicroSoft BASIC and CP/M[®] included). MicroSoft's buffered 16K RAM board, the VIDEX VIDEOTERM 80 Column board, with a soft video switch and inverse video.

All for only, **\$599.** (Limited time only)

Lowest prices on CCS & SSM
APPLE Interface Boards!
Special prices on VisiCalc[®]
and other VisiCorp Software
(Formerly Personal Software)

Personal Computer Systems (315) 478-6800
All prices are subject to change without notice.
609 Butternut St.
P.O. Box 1073
Syracuse, N.Y. 13201
Prices do not include shipping

Text continued from page 183:

the old residents and the stability of the neighborhood in general. Because the neighborhood develops before the students' eyes, they have immediate feedback on their predictions. This seems a productive use of class time, and it especially exemplifies the advantages of computer applications in the classroom.

Disturbing Developments

The second question in the introduction involves choosing between a planned, integrated neighborhood or a random neighborhood to begin the experiment. In the planned community option, both types of residents will prefer not to be in the minority, demanding that at least half of their neighbors must share their preferences. This choice reveals the most powerful and disturbing aspect of our model, namely that no matter how stable and perfectly integrated the neighborhood is to begin with, a relatively slight disturbance (in the current program, one-sixth of the residents are selected at random to move out and are replaced) can lead to such a dramatic restructuring of the community that the final, stable neighborhood is much more segregated than any of the individuals comprising the population really want it to be. (This observation leads us to suspect that even the best-planned, most stable, and best-integrated neighborhoods where everyone starts out happy with his or her immediate environment are difficult at best and may even be impossible to maintain.)

The second choice in the program, for experimenters who prefer to begin with an unplanned, random neighborhood, is to select the number of immediate neighbors (out of four) that the individual householder demands should share his view of life. One person might settle for one or even no neighbors similar to himself, while another might insist that all of his neighbors be of his own persuasion.

Here's where some disturbing developments can happen. The choice of dissimilar demands by the two types of neighbors must in-

evitably lead to the total elimination of the less gregarious type. That is, if Xs settle for two while Os demand three like neighbors, then after a number of iterations, there will be no place left that will satisfy an O. For example, suppose you have a music school dormitory that houses both trombonists and cellists and that the trombonists don't care who their neighbors are but the cellists can't practice in close proximity to a group of trombonists. (Schelling uses an example of snorklers and surfers. While an encounter between the two may be a minor annoyance to the surfer, it can be devastating to the snorkler.) Consequently, if there is an unlimited supply of trombone players (or surfers) beyond the neighborhood's borders, then the cellists and snorklers will eventually move away, even though they have nothing personal or ideological against the people who are replacing them in the community.

On the other hand, if neither group insists on being in the majority (for example, if the Xs want two neighbors like themselves and the Os will settle for only one) then neither group will be completely eliminated, although the more permissive type will dominate in numbers.

But there are even more possibilities. The program allows both types of individuals to demand majority status. For example, both types could demand three or even four similar neighbors. The community will eventually stabilize with neither group completely replacing the other, as long as both groups make equal demands concerning their neighbors' sympathies. Of course, if both groups insist that all neighbors be like themselves, the final "community" will be balkanized into several completely segregated ghettos, with a network of no-man's-land vacant lots separating the typological "clots" from contact with one another.

If the two types are not quite so demanding, requiring only three similar neighbors each, then a similar scene develops except that there are occasional bridges across the vacant lots where some households will have



“WHAT IF...”

Seldom is your first solution to a problem the only one, or the one that's necessarily best to use.

That's why our VisiCalc® program is #1 in the business: the most widely-used business program ever for the personal computer.

It's a powerful “electronic worksheet” that takes the work out of working with numbers. Whether you are working with investments, cash flow, inventory, estimates, budgets, plans—nearly anything numerical, the VisiCalc program will help you work better, smarter, faster.

In just seconds, the VisiCalc program can calculate and display the answers to involved problems you could have spent hours doing by hand.

Its speed and versatility makes it easy for you to explore more alternatives. You can ask “What if?”... just change any number in your problem and instantly, the VisiCalc program recalculates all the numbers and displays the new results. So you can

readily analyze the impact of decisions before you make them.

While the VisiCalc program does a lot by itself, it can do even more for you when used with the other Visi™ programs. That's because they're all inter-related, just like your needs and tasks, to give you a fully integrated solution. For example, automatically bring in data stored in our VisiFile™ program—such as customer or inventory information—for calculation and analysis with your VisiCalc program.

In addition, our series includes the VisiTrend/Plot,™ VisiSchedule,™ VisiDex,™ VisiTerm,™ VisiPlot,™ and Desktop/PLAN™ programs.

Ask your retail computer store salesperson for a demonstration of the VisiCalc program. Discover how easy it is to take the work out of working with numbers.

VISI CALC® FROM
VISICORP™
PERSONAL SOFTWARE™



SUPERBRAIN II

**PRICE
BREAKTHROUGH**

Intertec Data Systems' new SuperBrain II has all the features of the former SuperBrain, plus:

- Impressive Graphics capability
- Below-the-line descenders and reverse video
- Faster, enhanced disk operating system
- Battery operated real-time clock
- Microsoft Basic at no extra charge

NEW

SUPERBRAIN II Jr. . . . \$1,895
350K Disk—64 RAM

NEW

SUPERBRAIN II QD . . . \$2,275
700K Disk—64KRAM

NEW

SUPERBRAIN II SD . . . \$2,655
1.5 MB Disk—64K RAM

10 MB HARD DISK. . . . \$2,995

Upgrade your SuperBrain to a CompuStar™ Compatible Network.
(Includes All Hardware and Software)

NEW

DAZY CHAINE 3 \$ 495 \$ 350

NEW

STARGRAPH \$3,890 \$ Call
Includes 350K Disk—64K RAM.

Emulates Tektronix™ 4010 Graphics Terminal, Supports SAS-Graph and all Tektronix Plot 10 Software.

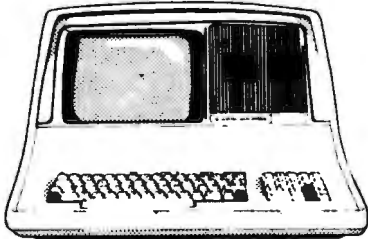

90 Day Money Back Guarantee*
120 Day Extended Warranty**

Ordering Information: Money Orders, Cashier Checks or Bank Wires Welcome. Personal or Company Checks, allow 15 days to clear. Surface Freight Standard F.O.B. Origin. Include your telephone number. No COD's, Please. Prices are subject to change without notice. Order desk hours are 9 to 5 CST.

CALL OR WRITE
(214) 931-9069

WESTSTAR MICRO

16990 Dallas Parkway • Suite 151
Dallas, Texas 75248

SuperBrain is a Registered Trademark of Intertec Data Systems.
Dazy Chaîne is a Registered Trademark of Gemini Computer, Inc.
Teltronix is a Registered Trademark of Tektronix.

* Refunds are Pro-rated.
** Extended Warranty offered by WestStar.

token contact across ethnic boundaries.

Our last example is of special demographic interest, wherein both types want at least half of their neighbors to be like themselves. If we start with a random neighborhood in which, say, the Xs are in a distinct minority, the final community, after all the dissatisfied folks have moved out and been replaced and all members are happy with their neighbors will be much more segregated than it would have been had we begun with an equal number of each type. This happens because the loss of an unhappy X has a proportionately larger effect on the remaining Xs than the loss of one of the more numerous Os. Furthermore, an O contemplating a move into the community will have more congenial places available to move into. Thus, as Os move in they encourage yet more Os to move in later, reinforcing the numerical superiority of their group.

How the Simulation Works

The actual neighborhood simulation operates as follows. If the user has chosen a random neighborhood, then the program calls the moving-out subroutine on lines 4000-4220. Here each householder counts the number of immediate neighbors that are either similar to himself or are vacant lots. (Note that special consideration must be given the top, bottom, and sides of the community. We assume that the community is bordered by vacant lots. To accomplish this we initially create a matrix of 14 by 34 zeros in lines 8440-8480 for the random neighborhood and lines 9070-9110 for the integrated neighborhood. We then populate it with Xs and Os, but only fill a submatrix that is 12 by 32. This retains a border of Os around the 12 by 32 matrix, and the program interprets the Os as vacant lots.) If there are too many dissimilar neighbors, the householder moves out, leaving a space. In this subroutine, we also keep track of the total number of similar neighbors and the total number of Xs. If no one moves out,

the neighborhood is stable and the program ends.

If one or more householders moves out, then the moving-in routine on lines 130-255 is invoked. Here both types of individuals "inspect the property" and evaluate the neighborhood. If neither has enough similar neighbors, then no one moves in and the lot remains unoccupied. If both are satisfied with the neighborhood, then they essentially flip a coin to see who moves in. After all vacant spaces have been inspected and satisfied individuals have moved in, the program simply loops to alternate the moving-in and moving-out phases of the experiment. In the case of the planned, integrated neighborhood, the logic of the program is the same, but the first iteration starts with one-sixth of the population randomly moving out. The program then goes to the moving-in routine and proceeds as outlined above.

Some Aids to Understanding

Sometimes it helps to have more than a visual impression of the degree of segregation and of the proportion of ethnic types in the neighborhood, so we provide an *Integration Index* (I.I.) at each iteration. This is a numerical statement of the proportion of dissimilar neighbors surrounding the "average" individual. We might also think of it as a *mean contact level*, as it is a statement of the length of shared boundaries between type clusters. This index is computed during the moving-out subroutine (in the checking-neighbors subroutine in lines 3000-3060) when individual households are polled to see if they want to vacate. The number of similar neighbors (and vacant lots) is subtracted from four (the total number of relevant neighbors) in line 4110 to find the number of dissimilar types adjacent to each household. We also keep track of the number of vacant lots with the variable F. The total number of dissimilar neighbors is calculated for all (384 - F) households and expressed as a percentage of the total number of possible neighbors (ignoring the vacant lots in the neighborhood and on the

Quality Computer Services presents..

Hard Disk Systems



For TRS[®], Apple[®], Heath[®], S-100, IBM.....
6,12,20,40 and 80 Megabyte systems

Completely assembled and tested subsystem including:

- Switching power supply
- Winchester drive
- Host adapter card
- Sealed case
- Expansion

The enclosure, controller and power supply have been designed to allow for future backup hardware or increased storage

- Software
- Auto attach CP/M^{*}
- Hard disk utilities
- Real time clock

- Formatting program
Assigns alternate sectors for any weak sectors detected during formatting assuring the lowest possible error rate

- Warranty: The system has a full one year warranty on all parts and workmanship
- Also available: attach for TRSDOS, OASIS^{*}, Apple DOS
- Optional 5 1/4" floppy (shown)



See local dealer
or call:
Quality Computer
Services
178 Main Street
Metuchen, New Jersey
201-548-2135

• Quantity discounts available. Distributor, Dealer and OEM inquiries invited.

*OASIS is a trademark of Phase One Systems. CP/M is trademark of Digital Research

QCS inc

Toll free number: 800 631 5944

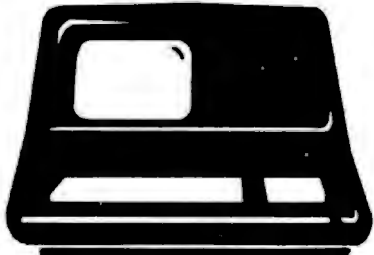

SUPERBRAIN™

The super performing, super reliable microcomputer from Intertec Data Systems features twin double-density 5¼" drives with 350K or 700K of disk storage – expandable to 10 megabytes. A CP/M* Disk Operating System, 64K of dynamic RAM and more.

\$ SUPER PRICE

Because we're a nationwide distributor of SuperBrain, the CompuStar 10 Megabyte Disk Storage System, CompuStar and the whole line of Intertec products at the absolute lowest prices in the business.

⚡ SUPER SERVICE

Better yet, we offer you a great deal of service and support because we want your business tomorrow as well as today.

- We'll burn-in your SuperBrain for 72 hours before we deliver it
- We'll help with installation and configuration
- We'll repair equipment at our service center and replace modules when necessary
- We'll fill your software needs or help you develop your own
- We'll match your SuperBrain with a super printer

For more information, call (609) 424-4700 or (215) 629-1289. To order call toll free (800) 257-5217. In NJ/call (609) 424-4700



2 Keystone Avenue
Cherry Hill, NJ 08003

* Registered trademark of Digital Research Inc. SuperBrain and CompuStar are trademarks of Intertec Data Systems.

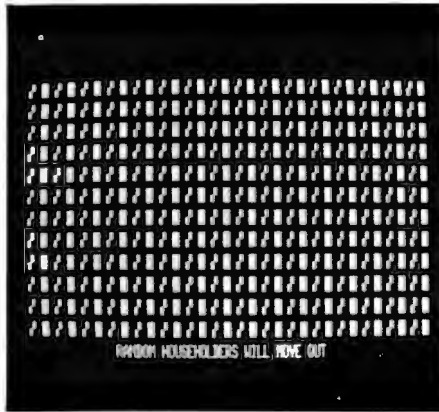

Photo 1a: Representation of a planned, integrated neighborhood at the beginning of a run of the neighborhood-segregation program shown in listing 1. One class of people, the Os, are represented by rectangles. The other class, the Xs, are represented by chair-like shapes.



Photo 1b: The same neighborhood after one-sixth of the households, chosen at random, have moved out.

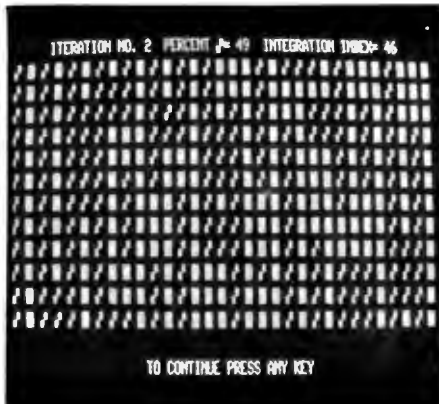

Photo 1c: The emerging pattern of segregation. Households in each group require only that at least half of their neighbors be in their own group.

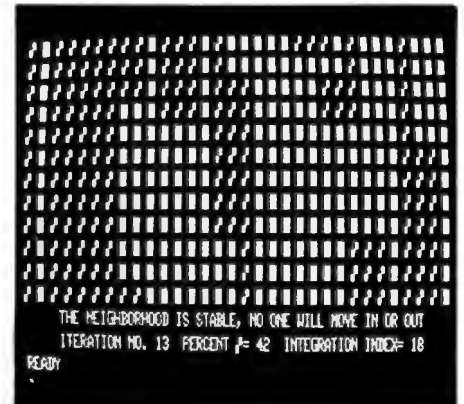

Photo 1d: The final, stable neighborhood. The extreme segregation has come about despite the willingness of every household in each group to live alongside some neighbors from the other group.

borders). By tracking the proportion of Xs and the Integration Index at each iteration, we can follow the progress of the neighborhood as it segregates itself.

Some Typical Runs

Photo 1a shows the planned integrated neighborhood that begins the simulation of this community. The Xs are represented on the screen as the chair-like shapes while the Os are represented as the rectangles. In photo 1b we have randomly moved approximately one-sixth of

the members out, leaving 65 open slots. Of course, all these slots could be filled with exactly the right sort so as to restore the community to a stable balance, but the odds against this happening are astronomical and it doesn't happen here. Photo 1c shows that even by the second iteration a segregated pattern is developing, although the integration index is still very high (46). The final, stable neighborhood is shown in photo 1d. The squares are congregated into two distinct neighborhoods in the center of the community with two smaller congregations on the edges. The

COMPUTERS

NORTHSTAR



New low price on the Incredible Advantage™. Your choice GDO5 and Basic, or GCP/M \$229. Let us burn and test your Horizon or Advantage and we'll back it with our own fast warranty service.

Advantage	\$2695
Horizon II 65K Quad	\$2795
Advantage w/5 Mg.	\$4995

TELEVIDEO - Multi-User



Powerful multi-tasking, multi-processing systems with true multi-user capabilities. Each TS-800A user station has its own C.P.U and 64K RAM for much greater throughput than normally attainable in single C.P.U. systems. Prices include CP/M and Mmmast.

806 (6-user) 10 Mg.	\$5295
816 (16-user) 23 Mg.	\$9695
800A-User Station	\$1295

TELEVIDEO



Now backed locally by T.J.W. Built-in CRT, detachable keyboard, dual floppys w/750K formatted capacity, 64K CP/M and more. Special: Telesolutions - Wordstar™ and CalcStar™ w/system \$279.

802	\$2696
802H	\$5049

ALTOS



New 3-user systems with 2 or 6 Mg. capacities. 16-Bit, 8086 based 8 user systems which run Xenix (UNIX™), Oasis-16, or MP/M-86™. Local service via Moore Business Service.

Series 5-15D	\$2295
Series 5-15D	\$4575
ACS-8600-10	\$7995

NEC



The low priced system that's big on features. 4 Mhz Z-80A, real time clock, color output, CP/M® compatible, 5 function keys and more.

PC8001A Computer	\$739
PC8012A I/O w/32K	\$479
PC8013A Dual 5 1/4" drives	\$739

ZENITH



The all-in-one that's backed by your local Zenith-Heath Service center. Green Screen, CP/M®, Supercalc, and Basic Inc.

Z-89 w/48K	\$2135
Z-90-82 w/64K	\$2395

IMPORTS



NEC 8023A	\$479
Epson MX80 w/gtrax	\$435
Okidata 82A	\$454
Epson MX100	\$719
Okidata 83A w/trac.	\$719
Okidata 84p	\$1059

HIGH SPEED

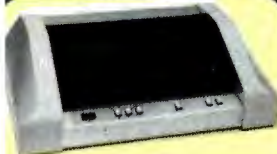

DS-180	\$1249
Anadex 9501A	\$1369
TI810 BASIC	\$1295
IDS Prism	
132 loaded	\$1469
Prism 80 w/3 opts.	\$889
Prism 80 loaded	\$1195

LETTER QUALITY



SCM-TP-1	\$795
F-10/40 cps	\$1449
F-10/55 cps	\$1649
NEC 3510 w/trac	\$1975
NEC 7710/7730	\$2340
NEC 7720	\$2695

SOFTWARE

Software sold only with systems and not warranted for suitability to particular applications. All require CP/M® - All software sales final.

Wordstar - Easy and powerful - the most popular word processing system for micros.

MailMerge - Works with or without Wordstar to keep up-to-date mailing lists and create individually produced letters.

CalcStar - Spread sheet analysis which is interactive with the other Micropro packages.

DataStar - Micropro's database system works with Wordstar to combine text and numbers.

Benchmark - CP/M based word processing that's both powerful and easy to learn. Does not use control characters on most systems.

dBASE II - The most popular CP/M based relational database.

Accounting Plus - General ledger, Accounts payable, accounts receivable, etc., plus Condor data base management.

Crosstalk - Plug into the personal computer networks and link-up with other systems via modem communications.

S.A.I.L. CP/M - For use with Northstar Horizons - Increases drive capacity 25K on doubles, 50K on Quads.

S.A.I.L.B.O.A.T. - Allows programs written under Northstar DOS and Basic to run on CP/M based systems.

NEW



Viewpoint 3A Plus: New Viewpoint emulates Lear Siegler, Televideo, or Sorac. We're selling them at a lower price than others charge for older models ... \$498

TELEVIDEO



910 Plus	\$579
925*	\$735
950*	\$927

*Xtra pg. memory \$30 - installed

TERMINALS



Falco TS-1 (VT52)	\$1069
Falco (VT-100)	\$1199
Zenith Z-19 (VT52)	\$689
Dialogue 80 Amber	\$895
Volker Craig 404	\$599



Scottsdale Systems Ltd.

6730 E. McDowell Road, Suite 110, Scottsdale, Arizona 85257



(602) 941-5856



Call 8-5 Mon.-Fri.

(We Export) TWX 910-950-0082 (IMEC SCOT)

SERVICE/ORDERING

INTEGRATION: Prices listed are for new equipment in factory sealed boxes with manufacturer's warranty. We will pretest your equipment, integrate your system, configure your software, provide special cables, etc., for an additional charge. Call for prices.

ORDERING: MAIL ORDER ONLY. Prices listed are for cash. No C.O.D.'s. We sell on a net 20 basis to Fortune 500 companies and Universities (at cash prices). Charge cards add 2%. Prices subject to change, product subject to availability. AZ. residents add 5%. Personal checks take 3 weeks to clear. 0-20% restocking fee for returned merchandise. Shipping extra - products are F.O.B. point of shipment. CP/M and MP/M are registered trademarks of Digital Research.

MORE PRINTERS

Zenith Z-25	\$1225	DEC LA34AA	\$1049
Prowriter ACD	\$639	Tally MT 1805	\$1645
MPI 99G	\$719	Xerox D80	\$2149

I/O DEVICES

Houston Instrument:		Hayes Smartmodem	\$219
Hi-Pior DMP-2	\$849	NEC 12"-G Monitor	\$169
Hi-Pior DMP-7/8	\$2057		
Hi Pad DT-11	\$669		

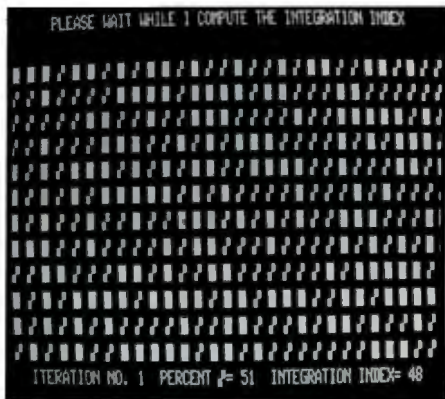

Photo 2a: Representation of a random neighborhood at the beginning of a run of the neighborhood-segregation program. Although unplanned, the neighborhood has a high degree of integration.

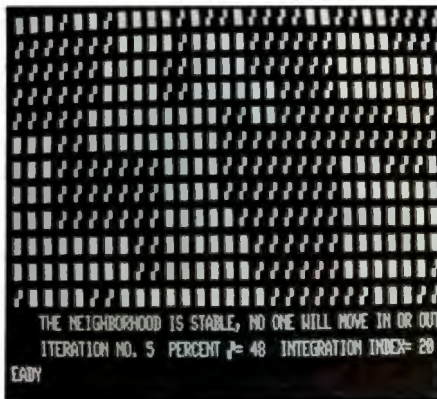

Photo 2b: The final pattern of segregation that emerges in a program run in which each household in each group wants to have two neighbors from its own group.

chairs are congregated primarily on the left-hand side, with a vertical strip in the middle and another on the right. If all anyone requires is two similar neighbors, then all vertical lines that are unaffected by the initial random disturbance will be permanent. This explains the vertical line of

squares on the left-hand side and the overall vertical look of the final pattern.

Photo 2a shows an initial random neighborhood. It is unplanned, but relatively highly integrated (the integration index is 48). However, it is not stable, and unhappy house-

holders will move out. The final, stable neighborhood is shown in photo 2b. The final neighborhood is highly segregated, with an integration index of 20 (similar to the result achieved with an initially integrated neighborhood). Because there is no necessary vertical pattern in the initial neighborhood, there is less of a corresponding vertical pattern in the resulting segregated neighborhood, although the requirement that only two neighbors be similar to oneself tends to stabilize the final patterns around vertical lines of similar types. The existence of relatively isolated individuals around the edges of the community can be explained by the fact that the community is bordered by vacant lots that are considered "friendly" by whoever locates next to them.

The final neighborhood, corresponding to a simulation in which both groups demand three neighbors be like themselves, is shown in photo 3. There is a very high level of segregation (the integration index is

SOFTWARE FOR MANUFACTURERS

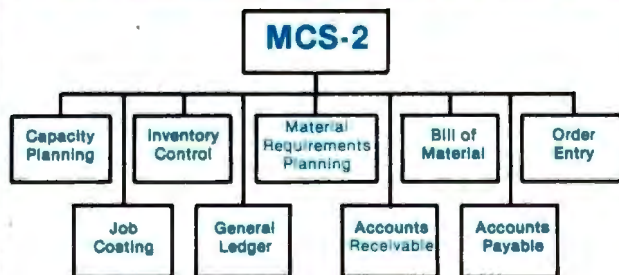

Micro Manufacturing Systems has been developing and supplying manufacturing software directly to manufacturers for several years and is now offering its MCS-2 system to dealers and OEM's.

MCS-2 is the most comprehensive manufacturing control system designed for the CPM based micro computer. MCS-2 consists of nine separate modules which can be purchased as a complete system or individually as required.

Demo Disc available - \$79.00

MM MICRO MANUFACTURING SYSTEMS

187 Shagbark Drive • Westerville, Ohio 43081

(614) 895-0738

S-100 USERS



INTERFACE 9-TRACK TAPE DRIVES

With the DTI - DMA Tape-Unit Interface

- Transfers data via DMA up to 200K bytes per second
- Allows full control over all tape-drive functions

SPEED NUMBER-CRUNCHING SOFTWARE 5-10 X's AND MORE

With the FMP - Fast Math Processor

- Kit or assembled
- 32-bit floating point operations for arith., trig., exponential, etc. functions
- Or 64-bit floating point operations for arithmetic functions



Both the DTI and FMP meet the IEEE S-100 standard. Software is available.

For further information contact:



A MEMBER OF THE SPC GROUP
SPC TECHNOLOGIES, INC.

P.O. Box 248, Arlington, VA 22210

Circle 339 on inquiry card. (703) 841-3632

**Finally
you can afford
to satisfy
your lust for
power.**



ZX81



For \$99.95 you can have a full powered personal computer.

Most people know by now that the ZX81 from Sinclair Research is the lowest priced personal computer in the world.

But serious programmers are looking for more than a low price. They're looking for true computer power. And that's where the ZX81 surprises a lot of people.

Just look at the keyboard and you'll get some idea of the ZX81's power. It has more than 60 BASIC commands, 20 graphic symbols, and complete mathematical functions. And there's even more power that you can't see.

A breakthrough in personal computers. The ZX81 offers features found only on computers costing two or three times as much.

Just look at what you get:

- Continuous display, including moving graphics
- Multi-dimensional string and numerical arrays
- Mathematical and scientific functions accurate to 8 decimal places
- Unique one-touch entry of key words like PRINT, RUN and LIST
- Automatic syntax error detection and easy editing
- Randomize function useful for both games and serious applications
- Built-in interface for ZX Printer
- 1K of memory expandable to 16K
- A comprehensive programming guide and operating manual

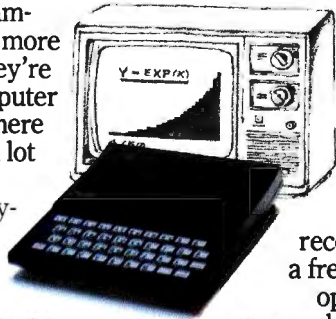

Sinclair programs are available



16K Memory Module

The ZX81 is also very convenient to use. It hooks up to any television set to produce a clear 32-column by 24-line display. And you can use a regular cassette recorder to store and recall programs by name.

What you get. When you order your ZX81, you get everything you need to start programming.

It comes with connectors for your TV and cassette recorder, an AC adaptor, and a free programming guide and operating manual that completely documents the capabilities of the ZX81.

Options and add-ons. Like any full-powered computer, the ZX81 can be expanded and upgraded.

Its 1K memory can be expanded to over 16K just by plugging the Sinclair Memory Module onto the back of the unit. The cost is only \$49.95.

Sinclair has also published pre-recorded programs on cassettes for your ZX81. We're constantly coming out with new programs, so we'll send you our latest software catalog when you order your computer.

How did we do it? The question most often asked about the ZX81 is, "How can so much computer power cost so little money?"

The answer is that Sinclair Research simply took a different approach. Our only goal was to make programming power as affordable as possible. So we developed a radical new design that cuts costs dramatically without cutting computer power. For example, our unique Master Chip replaces as many as 18 chips used in other personal computers.

The success of the ZX81 speaks for itself. It is now the fastest-selling personal computer in the world. And we stand behind our product. If anything goes wrong in the first 90 days, we'll repair or replace your unit free of

charge. Even after that, you can take advantage of our national service-by-mail facilities for a minimum fee.

Order now and try it out for 10 days. Simply send the coupon along with a check or money order. For faster delivery, call our toll-free number and use your MasterCard or VISA.

You have 10 days to try out the ZX81. If it isn't all we say it is, just send it back and we'll refund your money.

Why wait any longer? With the Sinclair ZX81, you can finally afford to have the computer power you've always wanted.

Call toll free 800-543-3000. Ask for operator #509. In Ohio call: 800-582-1364; in Canada call: 513-729-4300. Ask

for operator #509.

Phones open 24 hours a day, 7 days a week.

Have your MasterCard or VISA ready.

These numbers are for orders only. If you just want

Free guide to programming information, please write: Sinclair Research Ltd., 2 Sinclair Plaza, Nashua, NH 03061.

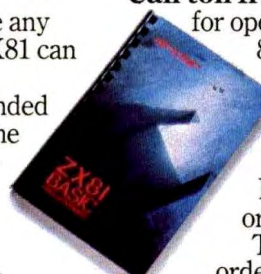

To order call toll free: 800-543-3000.

AD CODE 07BY	MAIL TO: Sinclair Research Ltd., One Sinclair Plaza, Nashua, NH 03061.		
	PRICE*	QTY.	AMOUNT
ZX81	\$99.95		
16K Memory Module	\$49.95		
Shipping and Handling	\$4.95		\$4.95
*U.S. dollars	TOTAL		
Name			
Address			
City		State	Zip

Sinclair technology is also available in Timex/Sinclair computers under a license from Sinclair Research Ltd.

sinclair

CHOOSE...

Choose an Apple Desk



A compact Bi-Level desk ideal for the Apple computer system. This 42" x 29½" desk comes with a shelf to hold two Apple disk drives. The top shelf for your TV or monitor and manuals can also have an optional paper slot to accommodate a printer. It is shown here with the optional Corvis shelf which will hold one Corvis disk drive. The Corvis shelf is available on the 52" x 29½" version of the Apple desk.

Choose a Micro Desk



The Universal Micro desk accommodates the S-100 type microcomputers. The desk is available in four sizes: 17.75 inch, 19.06 inch, and 20.75 inch wide openings with 24 inch front-to-rear mounting space. The fourth size is a 20.75 inch wide opening with a 26.50 inch front-to-rear mounting space.

Choose a Mini Rack



Mini racks and mini micro racks have standard venting, cable cut outs and adjustable RETMA rails. Choose a stand alone bay or a 48", 60", or 72" desk model in a variety of colors and wood tones. A custom rack is available for the Cromemco.

Choose a Printer Stand



The Universal printer stand fits the:

- | | |
|--------------------|------------------------|
| Centronics 700's | Diablo 1600's & 2300's |
| Dec LA 34 | T.I. 810 & 820 |
| NEC Spinwriter | Okidata Slimline |
| Lear Siegler 300's | Anadex 9500's |

Delivery in days on over 200 styles and colors in stock. Dealer inquiries invited.

ELECTRONIC SYSTEMS FURNITURE COMPANY

17129 S. Kingsview Avenue
Carson, California 90746
Telephone: (213)538-9601

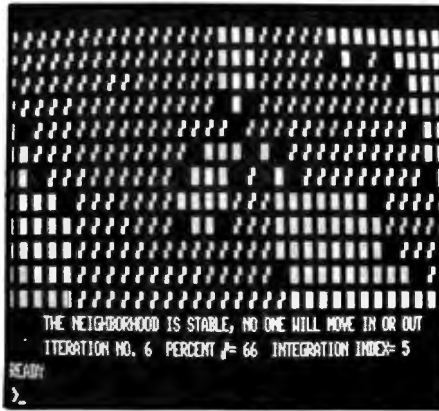

Photo 3: The final pattern of extreme segregation when each household in each group wants to have three neighbors from its own group.

only 5) and several lots will remain vacant between the isolated groups.

Photo 4a shows an initial random neighborhood with the Xs in a distinct minority (34 percent in this case). The initial integration index is 41, indicating a high level of dispersion of the minority group. However, the neighborhood is very unstable, even though both groups merely demand that they not be in a minority with respect to their immediate neighbors. After only five interactions the resulting stable neighborhood will be highly segregated, as illustrated in photo 4b, with the population of Xs severely reduced (to 15 percent).

These are only a few illustrations of the patterns that can develop accord-

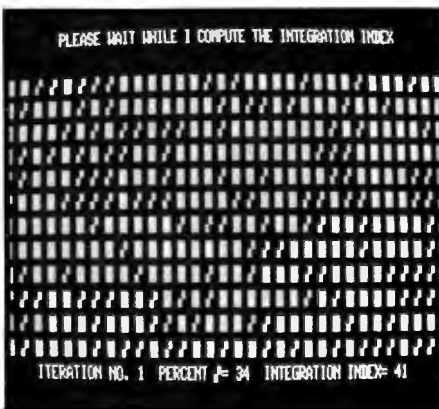

Photo 4a: An initial random neighborhood in which the Xs are a minority of 34 percent. Despite the minority status of the Xs, the neighborhood is well integrated.

ing to the various conditions put on the initial neighborhood.

Alternative Possibilities

Like good neighbors, we disagree on what are the most important aspects of using this program. The economist is mainly interested in what is ultimately going to happen to the community, while the anthropologist is more interested in the little things that happen along the way, viewing the model as a broad simulation. For the latter, it would be nice to allow some randomness in the subroutines. In this way a potential householder could make a mistake and move into a house in which he will be unhappy, perhaps because he was misled by the real estate agent. If these sorts of mistakes are not systematic, the final outcome will indeed be unaffected. However, if the user is interested in examining this phenomenon, we can add some random effects into the moving-in subroutine by adding a line such as:

```
5015 P=RND(500):IF P=1 THEN
      A(I,J)=RND(2):RETURN
```

This assigns one type or the other randomly to somewhat less than one vacant lot per iteration.

Similarly, if we add a line such as:

```
4125 P=RND(500):IF P=1 THEN
      A(I,J)=0:RETURN
```

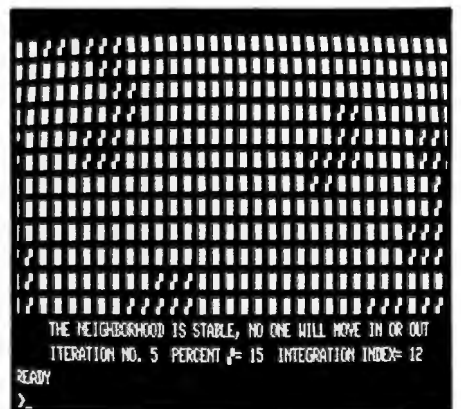

Photo 4b: The stable, highly segregated neighborhood that evolves from that shown in photo 4a when all the households in both groups just want not to be in a minority with respect to their immediate neighbors.

IBM COMPATIBLE BOARDS

BY **ZOBEX**

256 K MEMORY WITH PARITY
Limited time only! **\$598** ~~\$998~~
HARD DISC SUBSYSTEM FOR
IBM AND S-100 \$2495

HA62 IBM BUS HARD DISK INTERFACE FOR WD-1000
4SP 4 SERIAL PORTS FOR IBM
PB PROTOTYPING BOARD FOR IBM
EB EXTENDER BOARD FOR IBM

S-100 BOARDS

ZOBEX CPU
Z-80A CPU WITH 4 SERIAL AND 3 PARALLEL PORTS

ZOBEX DDFDC
DOUBLE DENSITY DISK CONTROLLER

ZMS-100
64K RAM

HDCI
S-100 HARD DISK INTERFACE FOR WD-1000

ZOBEX

7343 J. RONSON RD.
SAN DIEGO, CA. 92111
(714) 571-6971

ZOBEX is trademark of ZOBEX CORPORATION
IBM is trademark of International Business Machines Corporation

Case	M = number of like neighbors required by Xs	N = number of like neighbors required by Os	Initial percent X	Initial distribution	Integration Index			Percent X		
					Max	Min	Ave	Max	Min	Ave
1	2	2	50	integrated	31	13	19	69	32	51
2	2	2	50	random	25	15	20	76	35	50
3	1	2	50	random	29	16	22	80	60	69
4	2	3	50	random	0	0	0	100	100	100
5	3	3	50	random	8	4	6	73	27	49
6	4	4	50	random	0	0	0	71	27	51
7	1	1	50	random	45	36	40	58	43	51
8	2	2	33	random	20	3	10	27	5	13

Table 1: Experimental results of the neighborhood-segregation program shown in listing 1. The table gives the results for 50 trial runs for each of 8 different cases of initial assumptions about a neighborhood made up of 2 groups, the Xs and the Os. The integration index (i.e., proportion of dissimilar neighbors surrounding the average household) and the percent of Xs describe the heterogeneity of the neighborhoods resulting from the runs for each case. Only the seventh case, in which both the group X households and the group O households required just one neighbor belonging to their own group, shows impressive integration.

to the moving-out routine, then approximately 1/500 of all movers-out will be doing it for reasons other than dissatisfaction with their neighbors. This creates a more realistic situation at the expense of a higher number of iterations.

Experimental Findings

Table 1 presents results from trials of 50 runs of the program under 8 different sets of conditions. In the table, we record the preferences of the two types of individuals with respect to the number of like neighbors. Xs'

demands are in column (M), and the Os' demands in column (N). Also tabulated is the proportion of Xs in the initial neighborhood and whether the initial neighborhood is integrated or random. The maximum, minimum, and average Integration Index (I.I.) is tabulated for final neighborhoods from the 50 independent trials, along with corresponding maximum, minimum, and mean percentages of X in the same final neighborhoods.

The first case reported in the table is the planned, integrated neighborhood. The final I.I. averages 19 percent, even though both groups should theoretically be content with 50 percent. (How would you explain this result?) The final neighborhood shows an average 51 percent X, which demonstrates that although like has clustered with like, neither type dominates.

The second case is identical to the first except that it begins with a randomly organized neighborhood instead of our perfectly planned and integrated neighborhood. Starting from a random situation seems to have little effect on the final outcome, but it allows stability to be reached with fewer iterations.

In the third case, the Xs demand only one like neighbor while the Os' are slightly less permissive, demanding two. The final, stable neighborhood shows an integration index of 22, hardly different from the



I See a Byte Future

for the **NEC PC-8000 Series**
with the **REN TEC WEDGE**

- ★ Emulates most features of the NEC PC-8012A I/O Unit
- ★ 32K RAM card included
- ★ Two Atari™-type joystick ports
- ★ Attaches easily to the bottom of the PC-8000
- ★ NEC PC-8001A S/I/O channel brought out to a DB 25 connector
- ★ Built-in 3 channel synthesizer
- ★ NEC PC-8012A bus structure is implemented

REN TEC Peripherals for PC-8000

32K Memory Board\$199

RS-232-C Interface Card\$159

RGB to Composite Video/RF ...\$149
(40 column only)

Speech Synthesizer\$295

The REN TEC WEDGE\$595.

plus: Olympia Letter-Quality Printer
with **REN TEC ES INTERFACE**

FOR MOST MICROCOMPUTERS

- ★ Converts Olympia typewriter to letter-quality printer
- ★ Easy installation using existing ES100/101/105 cables
- ★ Accepts RS-232-C serial, Centronics parallel, and IEEE-488
- ★ Selectable auto. line feed

\$295.*
*Commodore slightly higher

Authorized Distributor for:
NEC, Olympia, Sanyo, Eagle, Sharp, Konan

DEALER INQUIRIES WELCOME

RENAISSANCE TECHNOLOGY CORPORATION

1070A SHARY CIRCLE, CONCORD, CA 94518 • (415) 676-5757

DUAL/68000

... Hard Power from
the Soft Support of

UNIX[®]

A new and powerful computer has been born... the System 83. The versatile UNIX* operating system pilots the System 83's raw power through a myriad of software such as "C", FORTRAN, PASCAL, BASIC, COBOL, and even Networking. Step into a bold new frontier with more power than you ever dreamed possible.



FEATURES:

- UNIX V7 configured by UNISOFT**
- Full IEEE 696/S-100 Compatibility
- MC68000 8Mhz Processor
- 32-Bit Data Operations with 32-Bit Internal Registers
- 16-Bit Data Transfer Operations
- Memory Management Allows Concurrent Use of Mapped and Non-mapped Address space
- Rugged Industrial Grade Components at all Levels
- 16 Mb of Main Memory Directly Addressable
- 7 Vectored Interrupt Levels
- 192 Device-supplied Interrupts
- 256 Kb of RAM with Parity Per Board Slot
- Up to 3.2 Mb of RAM Per Cabinet

* UNIX is a trademark of Bell Laboratories and is supported on the DUAL System 83 by UNISOFT

**UNISOFT is a trademark of UNISOFT Corporation of Berkeley, CA.

Circle 143 on Inquiry card.

DUAL

DUAL SYSTEMS CONTROL CORPORATION

system reliability/system integrity

720 Channing Way • Berkeley • CA 94710 • (415) 549-3854 • Telex: 172029 SPX

preceding cases, but the 69 percent proportion of Xs clearly shows the effects of their greater permissiveness. It earns them a significant majority.

In the fourth case, the Os require that at least three of their neighbors be like themselves and, like the cellists in competition with trombone players, the Os are inevitably slowly driven out. In the fifth case, both types demand a majority of like neighbors. The average I.I. is 6 percent, and it is a toss-up which group will dominate the final neighborhood. The sixth case is simply an extreme version of the fifth one, where each type demands exclusiveness. The integration index is always 0, and either group could dominate in the end, but there will always be a no-man's-land of vacant lots between completely segregated ghettos.

In the seventh case, both groups are gregarious, demanding only one similar neighbor. This gives us an average I.I. of 40, which is close to the maximum of 50, but to get even this close to the maximum each per-

son must be willing to tolerate a substantial majority of the other group around him. If this model has any relevance to actual neighborhood formation, then our results could be particularly depressing to people of goodwill who wish to encourage community integration.

There are many probabilistic as well as systemic factors in the evolution of any organization as complex as a human community.

The last experiment we have recorded assumes that each group wants at least two neighbors like themselves, but the Xs begin in a clear minority (33 percent). We end up with an average I.I. of 10, with the final proportion of Xs dropping to 13

percent, but actually sinking as low as 5 percent in one of the trials!

Conclusion

Although we both enjoyed a challenging opportunity to enhance our BASIC programming skills (that's how this project began), we have particularly come to appreciate the kinds of intellectual challenges and insights that can be made available with the help of a microcomputer. Few of us would have had the time or patience to fiddle through the thousands of coin manipulations necessary to make ourselves aware not only that maintaining an integrated community requires considerably more than goodwill, but that there are many probabilistic as well as systemic factors in the evolution of any organization of interacting parts, especially when that organization is anything as complex as a human community.

We hope that Neighborhood Segregation will stimulate discussion and creative reflection by those who use it. ■

Our DAISY puts out...
With more data analysis power at a lower price...



STATISTICS with DAISY

"... one of the best Statistical packages yet to be released for the Apple. For the price, perhaps the best..."
— Cider Press

"It covers 65-70 percent of my needs for data analysis and it provides me with options for data entry and manipulation that make it easy to prepare for the other 20-25 percent."
— The Computing Teacher

Requires an Apple* 48K with Applesoft ROM and DOS 3.3
..... \$79.95

Ideal for business, scientific, and social science applications.

FREE comprehensive Catalog and Newsletter with any purchase. Otherwise send \$2.00 U.S./\$5.50 Foreign to cover shipping and handling. Ask about our special BONUS offer.



Mail Order Dept. No. BY 7
19517 Business Center Dr.
Northridge, Calif. 91324

Phone orders only (Need Mastercard or Visa)
U.S.A. (except Calif.) (800) 423-5441
Calif. and Foreign (213) 349-0800
For information or technical questions (213) 349-5560

©1981 Tues. - Fri.
*Apple is the registered trademark of Apple Computer Inc.

Add \$2.50 U.S./\$10.00 Foreign for shipping. California residents add 6% sales tax.

\$495.

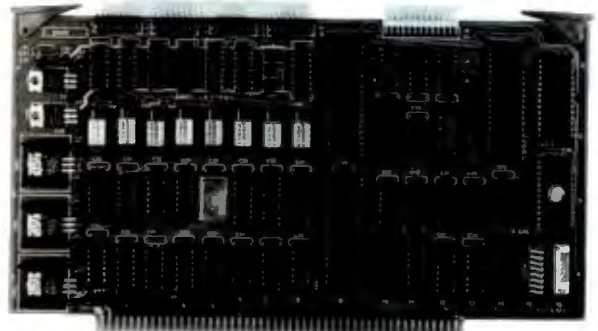

SBC can be redundant!!

- Z80A 4MHz, 64K RAM, 2K ROM
- 2 serial, 2 parallel, 4 timer ports
- Bi-directional inter-processor channel
- Multi-processor architecture capability
- Redundant processor manipulation capability
- Matching double-density disc controller with SASI
- Application note for system configurations

JC SYSTEMS (415) 657-4215
1075 Hiawatha Ct. Fremont, CA 94538



Introducing the **PERCOM** Alternative to **ATARI** Disk Storage

Your Atari 800 is the finest home computer on the market. Now you can own a floppy disk system that measures up — an RFD mini-disk storage system from Percom.

At Percom we've been making disk storage systems since 1977.

Our designs are proven, our quality is well known. And we back our dealers with service know-how. Expect more from Percom. You won't be disappointed.

- Operate in either single- or double-density storage mode using Atari DOS 2.0S. In double-density you can store almost 184 Kbytes (formatted) on one side of a 40-track diskette.

For the best thing next to your computer, see your Atari dealer about a Percom RFD floppy disk storage system. For the name of your nearest dealer, call Percom toll-free 1-800-527-1222.

- Connect your Percom RFD first-drive system directly to your computer or connect into your system through your Atari 810 Disk Drive.
- Add an RFD first-drive system with its versatile four-drive controller, then connect as many as three more low-cost RFD add-on drives.
- Write application programs that can query and set up your system to operate a different type drive at each cable position — that can even change configuration as the program executes.

- Get quality and state-of-the-art capability at competitive prices. Percom first-drive RFD systems are priced from only \$799, add-on drives from only \$399.

Watch for announcement of a new, powerful, easy-to-use disk-operating system for your Percom-equipped Atari 800 computer.

Minimum system requirements — are an Atari 800 computer with 24-Kbytes of RAM and compatible video display system; Atari's disk-operating system (ver 2.0S) and owner's manual; and, for add-on drives (if used) an optional disk drives interconnecting cable available from Percom.

PERCOM

PERCOM DATA COMPANY, INC.

11220 PAGEMILL RD • DALLAS, TX 75243 • (214) 340-7081

ATARI 800 & ATARI 810 are trademarks of the Atari Corporation.
PERCOM is a trademark of Percom Data Company, Inc.

PRICES AND SPECIFICATIONS
SUBJECT TO CHANGE
WITHOUT NOTICE.

Yes ... I'd like to know more about Percom RFD disk drives for my Atari 800 Computer. Rush me free literature.
Send to: PERCOM DATA COMPANY, Inc., DEPT 18-B01
11220 Pagemill Road, Dallas, Texas 75243

name _____

street _____

city _____ state _____

zip _____ phone number _____

I plan to add a hard disk system to my Atari: yes no.

MAIL TODAY!

Measuring Attitudes with a PET

A BASIC Program That Finds Out How People Feel

David R. Heise
Department of Sociology
Indiana University
Bloomington, IN 47405

Computers don't have feelings yet, but they can help us express and analyze our own feelings or attitudes toward everything from gun control legislation to Kiwi Kandy Bars. Until recently, only the largest organizations could afford sophisticated attitudinal assessment techniques. Now, by assigning these time-consuming techniques to your microcomputer, you can join the minors of the Nielsen and Gallup leagues.

The BASIC program presented here transforms your PET microcomputer into an attitude-measuring instrument. It gives instructions, poses questions, registers and translates responses into numerical values, calculates averages, and presents results in chart form. In fact, the program's use of advanced measurement principles provides better technology than that applied by most businesses and political organizations.

Two operational modes are available in the program: a teaching mode, developed to instruct college students in attitude theory and measurement, and a field mode for practical applications. The ability to explain itself combined with the PET's portability and novelty makes it easy to tap public opinion on a street corner, in a theater lobby, or in your own store.

About the Author

David Heise is a sociology professor at Indiana University. His books include *Causal Analysis and Understanding Events*. He has written commercial microcomputer programs for word processing and statistical analysis.

Attitude Theory and Measurement

Attitudes form the bedrock of our expectations and intentions. When properly measured and analyzed, attitudes become fairly accurate indicators of how we perceive the world and what actions we would probably take in a given situation.

Behaviors are once-removed from attitudes. What you expect to happen may not come to pass, thereby denying you the opportunity to act on your intentions. On the other hand, the opportunity may present itself, but your intended behavior may be suppressed or interrupted. Still, attitude measurements provide information that suggests what *might* occur.

Social psychologists define one's attitude toward something as the feeling or "affective response" associated with it. In addition to the good-bad (evaluative) feelings examined by early researchers, affective responses consist of at least two other components. The *potency*, or power of a person or object, and the *activity* level, or liveliness associated with same, influence our attitudes toward that person or object.

Research during the last quarter-century has established that evaluation, potency, and activity (EPA) are basic dimensions of human affect, and that any kind of stimulus produces reactions along these dimensions. Our responses, however, are more subtle than just choosing between opposites such as powerful and weak or lively and inactive. There exist gradations or shadings of

response. For example, you might feel that an eight-hour workday is slightly good but that a three-day weekend is extremely good.

Surveys usually assess this aspect of attitude by providing response categories such as "approve" and "strongly approve." Greater accuracy could be obtained by presenting a *continuous* scale (similar to a thermometer's continuum). Those responding could make distinctions as fine as they wished merely by checking a point on a line. The considerable expense of coding spatial data into numerical form prohibits this approach in many applications.

Attitude assessment is challenging because of the myriad trivial factors that can bias opinion. Response to a question or stimulus might be influenced by the previous question, by the judgment made last, or even by the way a scale is oriented (e.g., bad-good versus good-bad). *Repeated measures*, or presenting the questions more than once in random order, can be averaged together to allow the biases of one measure or scale to cancel those of another. While this is the preferred research method, the time and expense involved in making several different printed, randomized forms has limited its application.

The Attitudes Program

Microcomputers now make the use of randomized repeated measures economically feasible. The attitude measurement program (see listing 1, page 216) records respondents' reactions to questions or stimuli in terms of the EPA dimensions by means of a

MORROW DESIGNS

5 1/4" DMA Hard Disk System
M5 \$2,195 M10 \$3,195

Morrow DMA Controllers Supercharge Disk Systems.

What EDN said: "The (Disk Jockey™ DMA floppy-disk controller) offers two to three times the performance of comparable controllers." And that's for either 5 1/4" or 8" floppy-disk drives operating from an S-100 (IEEE-696) bus.

How we do it? With channel drive that's almost identical to IBM 370® channel controllers. The DJ/DMA uses 24-bit addressing. The host writes commands into memory. The DJ/DMA picks up commands from the host processor via memory on the system bus, and transfers data during DMA cycles. Channel commands may be located anywhere in the 24-bit address range. Upon completion of the command, the controller returns status. It may also generate an interrupt. Chained commands allow the controller to return status, or to execute a number of commands in succession. The controller board also contains logic which allows other IEEE-696 temporary bus masters to contend for memory cycles. That's the Morrow "channel concept." Fast and Simple.

On-board Z-80A.* By managing both memory and disk transfers, the resident Z-80A allows reading or writing to almost any floppy-disk media. 8" or 5 1/4". Single or double density. Single or double-sided. And up to eight drives per controller board (no more than four of each type).

System compatible. Disk Jockey DMA sub-systems are compatible with all IEEE-696, S-100 systems (such as the Morrow Decision I™). And, with most S-100 like systems.

Faster Winchester. Hard disks put micros in the mini category. Now, Morrow's channel driven

DMA controller concept makes Winchester lightning fast. Which Winchester? Industry standards—Seagate's 5 1/4" ST506/512, or 8" drives from Shugart/Quantum.

DMA Transfer (Burst Mode). The Morrow Direct Memory Access Hard Disk Controller (HDC/DMA) picks up commands from the host processor via memory on the system bus. Commands are accessed and data is transferred during DMA cycles. Commands and data transfers may occur anywhere in the 24-bit address range.

Interrupts. The controller can generate an interrupt at the end of each command and/or at the end of each command chain.

Imbedded μP. An on-board 8X300 supervises data transfers between the Winchester drive(s) and main memory. Microcode in this 7 MHz bipolar microprocessor implements the command structure of the controller.

Expansion. The HDC/DMA addresses one to four drives, one to 16 drive heads and an unlimited number of tracks. These capabilities allow system upgrades to additional platters and tracks as Winchester technology advances.

S-100 sub-systems. The HDC/DMA is compatible with all IEEE-696 systems and most existing S-100 systems—providing the bus clock is 2.5 MHz or faster.

Fast answers. Give us a call, or write us for more details on our new DMA controller boards and disk sub-systems.

LOOK TO MORROW FOR ANSWERS.

*Z-80A is a trademark of Zilog, Inc.

Morrow HDC/DMA
Direct Memory
Access
Hard Disk
Controller

Disk Jockey
DMA Floppy Disk
Controller

MORROW DESIGNS

5221 Central Avenue, Richmond, CA 94804
(415) 524-2101, TWX: 910-382-8132, (Power Key-Richmond)



IBM/370 is a registered trademark of IBM Corp.
Disk Jockey and Decision I are trademarks of Morrow Designs.

Circle 272 on inquiry card.

graphic rating scale. To register a reaction, the respondent controls an animated check mark. The program uses the PET's random-number generator to vary the order of stimuli, the order of the EPA scales' presentation, and the orientation of those scales. Respondents rate each stimulus more than once so errors can be reduced through averaging.

The operator loads and runs the program before turning it over to respondents. In its teaching mode, the program collects data from the respondent and also shows him or her the results. In its field mode, the program asks the operator to start a data tape before respondents begin. Then the program collects data from each respondent, stores it on the tape, and automatically sets up for the next respondent. Results of field operations are obtained later, when a special routine reads the data tape.

The first display a respondent sees tells how to enter his or her name.

The program "personalizes" its inquiries by embedding each respondent's name in the instructions. After entry of a name, the PET clears the screen and introduces itself as a microcomputer that is "going to help you express some attitudes." Then the program asks the respondent whether or not he or she has used the program before; if the answer is no, the program provides instructions:

"You'll say how you feel about some different things. I'll flash words at the top of the screen. Press R when you're ready, and I'll show you how I do it."

The screen clears and "A MICRO-COMPUTER" appears at the top of the screen in reversed lettering. The instructions continue on the screen below: "You show how you feel about it on a scale like this." The evaluation scale is constructed on the bottom half of the screen. New instructions overwrite the last ones: "A check mark will appear above the

line, and you move it back and forth with the < key or the > key. You press RETURN when the check is where you want it. Go ahead and try it. Rate ME."

The check mark appears, as shown in photo 1, and moves left or right continuously as long as the respondent presses the < key or the > key. The computer gets the respondent's first rating, then clears the screen. If the rating was on the good side, the PET prints, "Gee, (name). That's good of you." If the rating was neutral or bad, it prints, "Gosh. But (name). You hardly know me." In either case, the program pauses and then prints "Well, you've got the idea." The screen clears and prints "You rate each thing on three different scales."

In the field mode, the instructions end here and presentation of stimuli begins. Stimuli are defined beforehand in DATA statements. A stimulus may be a word, phrase, or sentence fewer than 37 characters long. In the teaching mode, the instructions continue: "We'll go through everything twice. After you've finished, I'll convert your ratings to numbers, calculate averages, and present the results in charts."

"You are to provide the words for this assignment. So let's do that now. How many things are you going to rate?" The PET drops into an error routine if the number is more than 20; otherwise it says, "Fine, now what are the words?" and the respondent enters the stimuli.

At the beginning of the rating process, the PET constructs the graphic rating scale at the bottom of the screen; this remains until all ratings are done. The scale is anchored by a series of adverbs—*slightly, quite, extremely, infinitely*—printed vertically beneath various points of the scale. The middle position is labeled "neither." Centered and highlighted stimuli are presented at the top of the screen. Each stimulus is erased before another is presented. The PET goes through the stimuli twice, randomizing order of presentation each time. Dimensions change by replacing the adjectives at either end of the scale

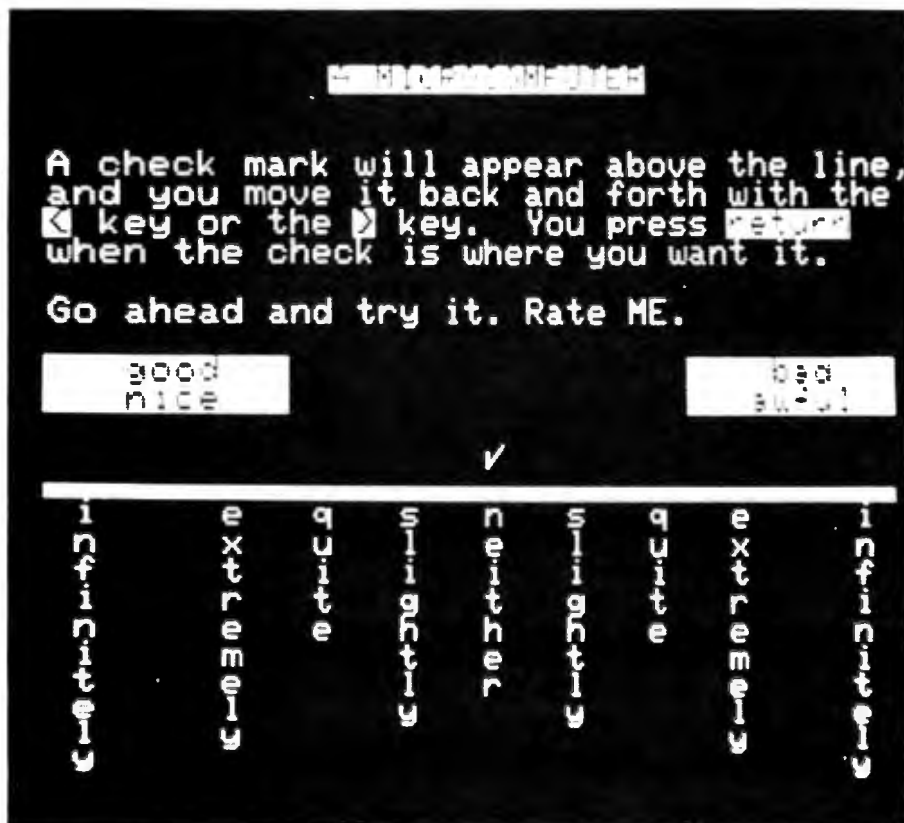

Photo 1: A screen display from the attitude-measurement program in listing 1. The stimulus is the phrase "A MICROCOMPUTER." The response is measured in the good-to-bad or nice-to-awful dimension. The respondent uses the < or > keys to move the check mark to the desired rating.

8086-SUPER MICRO.



Superfast in its class and ready to run.

Computer Benchmarks—All systems running the same BASIC program.

Manufacture-Model	Class	Operating System	Language (Type*)	Run Time (Seconds)
IBM 3033	Mainframe	VS2-10RVYL	Stanford BASIC	10
Seattle Computer System 2	Micro	MS-DOS	Microsoft BASIC (C)	33
Digital Equipment PDP 11/70	Mini	n/a	BASIC (I)	45
Prime 550	Mainframe	PRIMOS	BASIC V16.4 (I)	63
Digital Equipment PDP-10	Mainframe	TOPS-10	BASIC (I)	65
IBM System 34	Mainframe	Release 05	BASIC (I)	129
TEI System 48	Micro	MAGIC 1.0	Microsoft BASIC (C)	178
Hewlett-Packard HP3000	Mini	Time Share	BASIC (I)	250
Seattle Computer System 2	Micro	MS-DOS	Microsoft BASIC (I)	310
Alpha Micro AM-100/T	Micro	AMOS 4.3a	Alpha BASIC (SC)	317
Digital Equipment PDP 11/45	Mini	n/a	BASIC (I)	330
Data General NOVA 3	Mini	Time Share	BASIC 5.32	517
Ohio Scientific C4-P	Micro	OS65D 3.2	Level 1 BASIC (I)	680
North Star Floating Point	Micro	NSDOS	NorthStar BASIC (I)	685
Radio Shack TRS-80 II	Micro	TRSDOS 1.2	BASIC (I)	792
Apple II+	Micro	DOS 3.2	Applesoft II (I)	960
Cromemco System 3	Micro	CDOS	32K BASIC (I)	1074
Commodore Pet 2001	Micro	n/a	Microsoft BASIC (I)	1374
IBM 5100	Micro	n/a	BASIC (I)	1951
Vector MZ	Micro	n/a	Micropolis BASIC (I)	2251

*C = Compiler; I = Interpreter. Times (except for Seattle Computer) taken from August 1981 issue of Interface Age.

The Seattle Computer System 2 is the fastest micro on the block. In fact, System 2 outperforms many minis and mainframes.

Even the big boys such as: IBM System 34, Prime 550, and Hewlett-Packard HP 3000 are left in the dust when System 2 starts running.

The speedy System 2 consists of 8 Mhz. 8086 CPU set, 128K of 85 nsec. static RAM, double-density disk controller, 22-slot constant voltage mainframe, a cable for two 8" drives, and MS-DOS operating system (also called 86-DOS, IBM PC-DOS, Lifeboat SB-86).

High-level languages like Microsoft's Basic, Pascal, Fortran, Cobol are available now for your application programs.

System 2 comes fully assembled, tested and ready to run with the addition of disk drives (that we can supply) and terminal.

Call (206) 575-1830 for the location of your nearest System 2 dealer.

Dealer inquiries welcome.

 **SEATTLE
COMPUTER**

1114 Industry Drive, Seattle, Washington 98188

Circle 345 on inquiry card.

INTRODUCING THE:



SPECIAL INTRODUCTORY OFFER!

WITH CP/M™ OPERATING SYSTEM \$2,695

A Briefcase Size Computer with Full Size Abilities!

Standard Features

- 4 MHZ Z80 PROCESSOR
- 64K LOW POWER RAM
- 1.2 MBYTE ON DUAL 8" FLOPPIES
- COMPACT SIZE: 5½" X 19" X 19"
- LIGHT WEIGHT - ONLY 30 LBS
- 4 RS-232 SERIAL PORTS
- ENVIRONMENTAL PACKAGING
- SWITCHING POWER SUPPLY

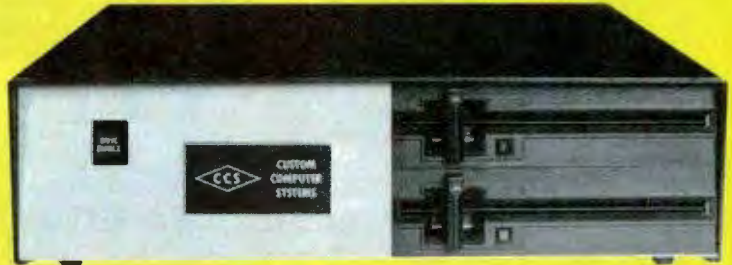

This Is Not a Personal Computer!
THE EXEC-JR IS A TRUE BUSINESS COMPUTER WITH CAPABILITIES TO HANDLE THE TOUGH JOBS.

SERIAL PORTS CAN BE USED FOR TERMINALS, PRINTERS OR MODEMS

Expansion Options

- 192K BYTE RAM MEMORY
- MULTI-USER
- DUAL SIDED DRIVES (2.4 MBYTE)
- FIXED DISK INTERFACE WITH 11, 35, OR 70 MBYTE FIXED DISK



Affordable Expansion

2.4 MBYTE
ON DUAL SIDED DRIVES
ONLY \$375

64K RAM Expansion
FOR A TOTAL OF 128K BYTE
ONLY \$149

128K RAM Expansion
FOR A TOTAL OF 192K BYTE
ONLY \$298

As a closing thought consider this . . .

Who else offers a small computer with:

192K BYTE RAM, 2.4 MBYTE on Floppies; 4 Serial Terminal Interfaces, Multi-User Capability and CP/M™ Operating System for \$3,368.

CUSTOM COMPUTER SYSTEMS INC.
AN INNOVATIVE LEADER IN PROCESSING SYSTEMS

Presented By

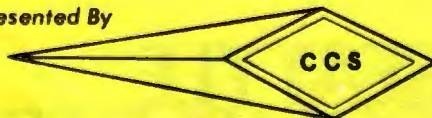

PRICE AND AVAILABILITY SUBJECT TO CHANGE WITHOUT NOTICE.
REPRESENTATIVE INQUIRIES WELCOME.
CP/M IS A TRADEMARK OF DIGITAL RESEARCH, INC.

7250 COMMERCE CIRCLE EAST • FRIDLEY, MINNESOTA 55432 • PHONE (612) 574-9493

INTRODUCING THE:



**The Executive+ System
will speak for it's self.**

Mult-User!

UP TO 21 USERS ON LINE - PER SYSTEM.

Concurrent Tasks!

EACH USER CAN RUN MULTIPLE
TASKS CONCURRENTLY.

Multi-Processing!

UP TO 7 CPU'S PER SYSTEM.

Networking!

COMPUTER SYSTEMS CAN BE TIED
TOGETHER TO SHARE DATA BASES.

**Up to 5.46 million
bytes of RAM memory!**

**Up to 1.848 billion
bytes of on line
storage!**

High Reliability!

THE SYSTEM IS HOUSED IN A SEALED
RACK WITH FORCED AIR FOR
ENVIRONMENTAL CONTROL WITH FRONT
PANEL TURN KEY OPERATION, SWITCHING
POWER SUPPLIES AND ROM BASED
DIAGNOSTICS.

FOR COMPUTATIONS WHERE THE
LITTLE GUYS DON'T COMPUTE



Cost Effective!

A 4 USER SYSTEM WITH 1.2 MBYTE ON FLOPPIES,
204K BYTE RAM, 4 PRINTER INTERFACES,
1 NETWORK INTERFACE AND A 154 MEG BYTE
FIXED DISK RETAILS FOR \$19,538.

PRICE AND AVAILABILITY SUBJECT TO CHANGE WITHOUT NOTICE.

**Send for information on our complete line of
Executive Computers, Operating Systems and Business Solutions.
Representative inquires are welcome.**

Presented By

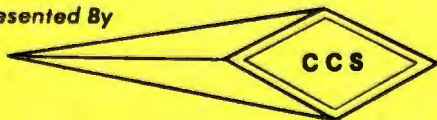

**CUSTOM COMPUTER SYSTEMS INC.
AN INNOVATIVE LEADER IN PROCESSING SYSTEMS**

7250 COMMERCE CIRCLE EAST • FRIDLEY, MINNESOTA 55432 • PHONE (612) 574-9493

while the stimulus remains constant. The order of the EPA elements is randomized, as is the placement of given adjectives on the left or right side of the screen.

As the respondent enters each rating, the spatial position of the check mark is converted to a number and stored in an array. If a respondent rates a stimulus as neutral on all three dimensions, the PET prints, "(Name), you rated this one at the middle all three times. Let's do it

again to be sure about that." This procedure guards against a respondent's pressing RETURN without moving the check. The ratings, whatever they are, are accepted the second time.

In the teaching mode, the screen clears when all of the ratings are completed, then displays: "OK. You've rated each word twice on the three scales. Now I'll show you the average profiles. Then I'll show you graphs of the results. Press C to continue." On

receiving the continue signal, the PET constructs a table with stimuli (truncated to 12 characters) listed on the left side of the screen and preceded by an index letter. The EPA ratings appear in three columns. The numbers are mean values, calculated across the different presentations. The numbers may range from -4.75 to +4.75. Negative means *bad, powerless, or quiet*; positive is *good, powerful, or lively*; zero means *neither*. (Optionally, the program can print this table on paper.)

The respondent gives another continue signal when finished viewing the EPA profiles. The program then constructs a graph showing the distribution of stimuli (each represented by its index letter) on the evaluation and activity dimensions. Plus or minus values on the potency dimension are indicated by capitals or lowercase index letters. Another continue signal produces a graph on the activity and potency axes; a third continue signal produces a potency-evaluation graph. A final continue signal produces the message "OK, (name), that's all. Hope you enjoyed it." This message stays on the screen awhile, then the program returns to the beginning, ready for another respondent.

In the field mode, the end of the ratings can initiate presentation of as many as ten background questions entered into the program beforehand. This part of the session might go as follows: "Now, (name), a few questions about you. Are you 1 Male or 2 Female?" If no background questions are included or when all background questions have been answered, the program gives the "that's all" message, saves all of the respondent's data on tape, and readies itself for another respondent.

Field-mode data collection is terminated by entering END instead of a respondent's name. This closes the data file and produces a message indicating the number of respondents who used the program. Since it's needed to run analyses, the number should be written on the data tape.

To analyze a data tape, rewind the tape and restart the program by

Text continued on page 236

THE WORD PLUS
© OASIS SYSTEMS 1981

\$150

More than a Spelling Checker

THE COMPLETE TOOL

The WORD PLUS has many features that SpellStar™ and other competitors leave out. The WORD PLUS finds errors, shows them to you *in context*, and with your consent, automatically corrects them throughout the text. SpellStar does not correct errors.

Versatile The WORD PLUS works with almost any CP/M® based word processor. SpellStar only works with WordStar™.

Accurate The WORD PLUS offers a 45,000 word vocabulary without the compromise of suffix stripping. SpellStar has only 20,000 words.

Convenient The WORD PLUS helps you find the correct spelling by consulting its dictionary. SpellStar gives no such help.

Fast The WORD PLUS proof reads 10,000 words of text in less than two minutes.

Many Extra Features The WORD PLUS offers automatic hyphenation, text analysis, and fast word counting. Also solves crossword puzzles, locates anagrams and finds rhyming words.

Inexpensive \$150 ... a low cost for freedom from the anxiety of misspelling.

The WORD PLUS - Clearly the Best Choice. For more information call Wayne Holder at

OASIS SYSTEMS | 714-291-9489
2765 Reynard Way
San Diego, CA 92103

*SpellStar and WordStar are trademarks of MicroPro Int'l
CP/M is a registered trademark of Digital Research, Inc.

Give your system some NEC, and watch its performance soar.

NEC's crisp, clear, high-performance JC1202 RGB color monitor, an industry standard. Also available: the JC1201 composite video version.

NEC's classic green monitor, (JB1201), one of computing's performance legends. Non-glare screen, easy on the eye. And the checkbook.

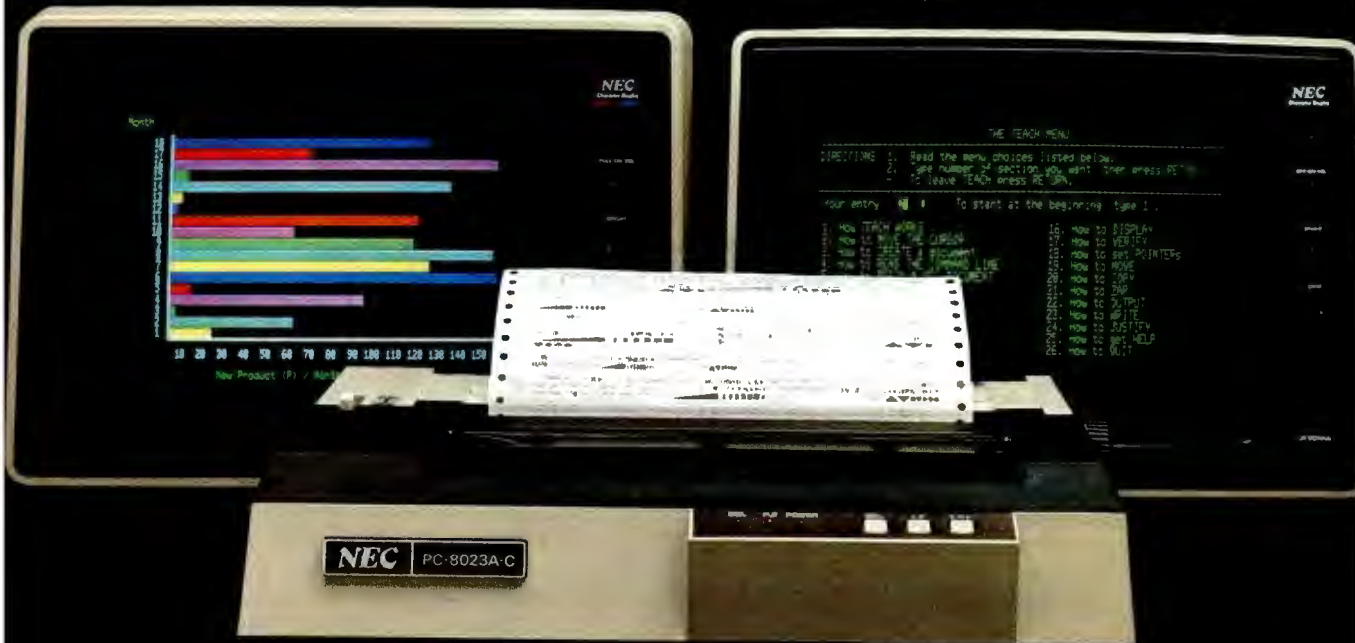

The impressive new NEC dot matrix printer. Parallel interface, 100 cps, 2K buffer, pin or friction feed. Stunning performance and versatility in the hottest new peripheral of the year.

Peripherals from NEC can make almost any computer system better.

Owners of Apple[®], Radio Shack[®], Atari[®], IBM[®], and many other personal computers will find their equipment to be compatible with NEC's famous monitors, as well as our highly-featured new PC-8023A dot matrix printer. (Some configurations may require a different interface.)

Ask your dealer for a demonstration.



**Productivity
at your fingertips**

NEC

**NEC Home Electronics (USA)
Personal Computer Division**
1401 Estes Avenue
Elk Grove Village, IL 60007

Listing 1: A BASIC attitude-measuring program that runs on a Commodore PET. An executive routine at lines 220-360 defines the program's structure. The program presents stimuli and assesses the respondent's attitudes toward them in three dimensions set by data statements beginning at line 520. The user can change the stimuli presented by using a DATA statement like the one at line 2450. At line 4530, a routine asks the respondent's gender; the routine can be expanded to gather more background information.

```

100 REM *** ATTITUDES PROGRAM FOR 8K OR MORE ***
110 :
120 REM WHEN USING PROGRAM IN THE FIELD, SET TEACHING=0
130 TEACHING=-1
140 IF NOT TEACHING THEN INPUT "<s>NAME FOR DATA FILE";NM$:OPEN 1,1,1,NM$
150 :
160 REM TO PRINT PROFILES ON PAPER, SET PAPER=-1 AND TURN PRINTER ON
170 PAPER=0
180 IF TEACHING AND PAPER THEN OPEN 4,4
190 REM SET NUMBER OF REPLICATIONS.
200 NR=2
210 :
220 REM*** EXECUTIVE PROGRAM
230 GOSUB 390 :REM SET ARRAYS AND STRING CONSTANTS.
240 IF NOT TEACHING THEN GOSUB 2340:REM DEFINE STIMULI IN PROGRAM.
250 GOSUB 3760 :REM GIVE INTRODUCTION AND INSTRUCTIONS.
260 IF TEACHING THEN GOSUB 2510 :REM LET RESPONDENT DEFINE STIMULI.
270 GOSUB 1030 :REM DRAW RATING SCALE.
280 FOR T=0 TO NR-1 :REM GET NR SETS OF RATINGS
290 FOR LI=0 TO LL-1 :REM FOR EACH STIMULUS
300 GOSUB 1460 :REM BY PRESENTING STIMULUS
310 GOSUB 1980 :REM THEN GETTING EPA RATINGS AND STORING.
320 NEXT LI,T
330 GOSUB 2850 :REM DISPLAY AVERAGES IN TABLE AND GRAPHS.
340 GOSUB 4560 :REM SIGN OFF.
350 IF TEACHING THEN CLR:GOTO 130 :REM SET UP FOR NEXT RESPONDENT.
360 GOTO 250
370 :
380 REM*** DEFINE UTILITY ARRAYS AND STRINGS
390 DIM Q$(2),DA$(2),BB$(3),AV$(4),AJ$(2,2,1),DM$(2)
400 REM STRINGS OF BLANKS
410 FOR I=1 TO 39:BB$(3)=BB$(3)+" ]":NEXT I
420 BB$(0)=LEFT$(BB$(3),19)
430 BB$(1)="[ ][ ][ ][ ][ ]":BB$(2)="[ ][ ][ ]"
440 REM SCALE ADVERBS
450 FOR I=0 TO 4: READ AV$(I):NEXT I
460 DATA "INFINITELY","EXTREMELY[ ]","QUITE[ ][ ][ ][ ]"
470 DATA "SLIGHTLY[ ][ ]","NEITHER[ ][ ][ ]"
480 REM SCALE ADJECTIVES
490 FOR I=0 TO 2:FOR J=0 TO 2:FOR K=0 TO 1
500 READ AJ$(I,J,K)

```

READY.

```

510 NEXT K,J,I
520 DATA "[ ][ ][ ][ ][ ][ ][ ][ ][ ][ ]","[ ][ ][ ][ ][ ][ ][ ][ ][ ]"
530 DATA "[ ][ ][ ]GOOD[ ][ ][ ]","[ ][ ][ ][ ][ ]BAD[ ][ ][ ]"
540 DATA "[ ][ ][ ]NICE[ ][ ][ ]","[ ][ ][ ][ ]AWFUL[ ][ ][ ]"
550 DATA "[ ][ ][ ][ ][ ][ ][ ][ ][ ][ ]","[ ][ ][ ][ ][ ][ ][ ][ ][ ][ ]"
560 DATA "[ ][ ][ ]BIG[ ][ ][ ][ ]","[ ][ ][ ]LITTLE[ ][ ][ ]"
570 DATA "[ ][ ]POWERFUL[ ]","[ ][ ]POWERLESS"
580 DATA "[ ][ ][ ]FAST[ ][ ][ ]","[ ][ ][ ][ ]SLOW[ ][ ][ ]"
590 DATA "[ ][ ][ ]YOUNG[ ][ ][ ]","[ ][ ][ ][ ]OLD[ ][ ][ ]"
600 DATA "[ ][ ][ ]NOISY[ ][ ][ ]","[ ][ ][ ][ ]QUIET[ ][ ][ ]"

```

Listing 1 continued on page 218



YOU PICK THE COMPUTER, MICROPRO™ MAKES IT PERFORM.

There are a lot of fine names in microcomputers. But there's only one name in software to remember. MicroPro. Because MicroPro has taken the best ideas in business software and put them together to make the MicroPro Software System™—a family of software products that work together on more than 100 of the most popular brands of microcomputers, probably including yours.*

Software makes the difference.

The key to getting the most out of your computer is the software you use. And the Software System is designed to get the most out, faster. The Software System is our new name for the MicroPro family of software products, each remarkably powerful and versatile—and even more so when you combine them.

The products: WordStar®(word processing), MailMerge™ (WordStar option—personalized form letters and other file-merging uses); SpellStar™ (WordStar option—spelling checker); DataStar™ (data entry and retrieval); CalcStar™ (electronic spread sheet and financial modeling); SuperSort™ (sorting, selecting, and merging); and WordMaster® (video text editing).

More solutions, less work.

The Software System enables you to use your microcomputer to its fullest with less time and effort. That's because, for one thing, most MicroPro products have similar methods of operation, so it's easier to move from one product to another. And they readily adapt to your way of doing business, instead of forcing you to make changes to fit a rigid software package, like you have to do with many other software products. Most important, you can combine MicroPro products' information and abilities. The result: a lot more ways to make your

business more productive than you'd get from just using each product by itself.

The System doesn't stop.

Count on MicroPro to keep expanding the Software System with new products that make it even more useful and powerful in your business. Coming this year: a series of in-depth accounting packages; InfoStar™, a powerful report generator and partner to DataStar; and StarBurst™, a new kind of software that will link our products together into an even friendlier and easier to use package.

If you're shopping for a computer, we recommend you shop for software even more carefully. After all, there are a lot of good hardware systems to choose from. But there's only one Software System. From MicroPro.

To get our brochure on the MicroPro Software System, visit any of our 1200 dealers around the world.

Or phone toll-free 800-227-2400, ext. 933
(In California 800-772-2666, ext. 933.)



MicroPro™
INTERNATIONAL CORPORATION

*Ask your MicroPro dealer to let you know which microcomputers can use MicroPro software. For the IBM® Personal Computer, WordStar and MailMerge are now available—other products coming. MicroPro Apple™ software requires a CP/M®-Z-80® adaptation device. IBM is a registered trademark of International Business Machines Corp. Apple is a trademark of Apple Computer Inc. CP/M is a registered trademark of Digital Research, Inc. Z-80 is a registered trademark of Zilog, Inc. © 1982 MicroPro International Corp.

Listing 1 continued:

```
610 REM NAMES OF GRAPH AXES
620 DM$(0)="EVAL.[ ]":DM$(1)="POTEN.":DM$(2)="ACTIV."
630 REM CURSOR DOWN 11 ROWS
640 CU$="<Q><Q><Q><Q><Q><Q><Q><Q><Q><Q>"
650 REM SEED THE RND FUNCTION
660 I=RND(-TI)
670 RETURN
680 :
690 REM*** INPUT WORDS, GUARDING AGAINST BREAKOUT
700 REM RESTORE STOP KEY IN CASE PROGRAMMER BREAKS OUT BY ENTERING SPACE
710 REM (OLD ROM: POKE 537,136; OS 4.0: POKE 144,88)
720 POKE 144,46
730 REM FIND CURSOR POSITION
740 REM (A=226 FOR OLD ROM)
750 A=198:X=PEEK(A)
760 REM GET INPUT STRING
770 INPUT "<]><]>[&]<]><]><]><]>";A$
780 REM IGNORE IF USER PRESSES RETURN WITHOUT PRIOR KEYSTROKE
790 IF A$="[&]" THEN PRINT"<q>";:POKE A,X:GOTO 770
800 REM DISABLE STOP KEY
810 REM (OLD ROM: POKE 537,133; OS 4.0: POKE 144,85)
820 POKE 144,49
830 RETURN
840 :
850 REM*** CAPITALIZE FIRST LETTERS OF WORDS
860 C$="":DI=128
870 REM SEARCH STRING FOR SPACES
880 FOR K=1 TO LEN(A$)
890 B$=MID$(A$,K,1)
900 REM FOR OLD ROM ADD THIS STATEMENT
910 REM B$=CHR$(128+ASC(B$)):DI=-128
920 REM CAPITAL FOR FIRST WORD
930 IF K=1 THEN K=0:B$=" "
940 REM PUT CAPITALS AFTER SPACES
950 IF B$=" " THEN K=K+1:B$=CHR$(DI+ASC(MID$(A$,K,1))):IF K>1 THEN C$=C$+" "
960 REM REBUILD STRING
970 C$=C$+B$
980 NEXT K
990 A$=C$
1000 RETURN
1010 :
1020 REM*** DRAW THE SCALE
1030 PRINT "<S><Q><Q><Q>"CU$;
1040 REM DRAW A LINE
1050 FOR I=1 TO 39:PRINT CHR$(162);:NEXT I:PRINT
1060 REM PRINT THE ADVERBS VERTICALLY
1070 FOR I=1 TO 10
1080 REM FIRST DO THE LEFT-SIDE ADVERBS AND MIDDLE
1090 PRINT "[ ]";
1100 FOR J=0 TO 4
1110 REM USE LARGER GAP AFTER 'INFINITELY'
1120 K=2:IF J=0 THEN K=1
1130 REM PRINT ONE LETTER FROM EACH ADVERB PER ROW
1140 PRINT MID$(AV$(J),I,1)BB$(K);
1150 NEXT J
1160 REM BACKSPACE AND DO THE RIGHT-SIDE ADVERBS
1170 PRINT "<}><}><}>";
1180 FOR J=3 TO 0 STEP -1
```

Listing 1 continued on page 220

MICRO



BUSINESS WORLD INC.
Information Line (213) 996-2252
TOLL FREE MAIL ORDER LINES
(800) 423-5886 Outside Calif



HP 41CV

OUR PRICE ~~MSL 325.00~~ **\$239.00** *Save 86.00*

EXPANSION BOARD
Q STAR
16K RAM BOARD



MSL 199.00

OUR PRICE ~~MSL 100.00~~ **\$99.00** *Save*

MSL 100.00

MICRO-SCI APPLE II+ COMPATIBLE DRIVE



W/ CONTROLLER MSL ~~OUR PRICE 549.00~~ **429.00**
W/O CONTROLLER MSL ~~OUR PRICE 449.00~~ **379.00**

Save COMPARE TO **216.00** APPLE DRIVE
Save COMPARE TO **146.00** APPLE DRIVE
APPLE IS A REG TRADE MARK OF APPLE COMPUTER

IBM IBM PERSONAL COMPUTER INCLUDES:



2 Drives
Colour Graphic Board
64K Memory

CALL FOR PRICE

*Subject to availability

FRANKLIN 64K ACE 100

APPLE COMPATIBLE INTRODUCTORY OFFER

MSL 1595.00 **Call for Price**



The Franklin ACE 100 is a professional personal computer that is hardware and software compatible with the Apple II+ and includes many features not found on the Apple unit. All programs written for the Apple II will run on the Franklin ACE 100 without modification including those using high and low resolution black and white graphics. The ACE 100 is plug compatible with Apple II peripherals designed for the Apple II will operate with the ACE 100 without modification.

Franklin ACE 100 Features

- Apple II compatible
- 64K of RAM memory
- Upper and lower case
- Typewriter style keyboard
- Two key numeric pad
- Alpha lock shift key
- VisiCalc friendly
- 50 watt power supply
- Built-in fan

COMPARE OUR COMPUTER

FRANKLIN ACE 100 compared to APPLE II

FEATURES	APPLE II	FRANKLIN ACE 100
Computer with 48K RAM Memory	\$1530.00	STD
Microsoft 16K RAM Card (16K RAM Memory)	195.00 (option)	STD
ABT 10 Key Pad	125.00 (option)	STD
Videx Keyboard Enhancer	149.00 (option)	STD
R.H. Electronics Super Fan II (blowin' fan)	69.00 (option)	STD
TOTAL	\$2068.00	\$1595.00

APPLE IS A REG TRADE MARK OF APPLE COMPUTER

LE MONITOR



9" GRN. PHS. MONITOR
12" GRN. PHS. MONITOR

MSL ~~OUR PRICE 189.00~~ **\$119.00** *Save 70.00*

APPLE II PLUS 48K



*Subject to availability

CALL FOR PRICE

APPLE IS A REG TRADEMARK OF APPLE COMPUTER

The Franklin ACE 100 is a personal computer with the power quality and reliability to meet the most demanding applications of the business professional. It comes complete with 64K of RAM memory which fulfills the demanding memory requirements of VisiCalc and CP/M based programs. The system includes a full upper and lower case keyboard with true shift capability and a numeric pad. The computer generates a full character set to the video screen that displays upper and lower case characters.

The 72 key keyboard includes an alpha lock key which simplifies operation with existing Apple software. The numeric pad cluster includes special keys such as period, plus, minus, greater than (go to) and asterisk (multiply) that are used frequently with VisiCalc.

The Franklin ACE 100 includes a joystick/ game paddle connector, a speaker and eight peripheral connectors. A built-in fan and a 50 watt power supply permit all eight peripheral connectors to be used without power or overheating problems.



HP 85

The professional's choice:
Hewlett-Packard's HP-85



MSL ~~OUR PRICE 2750.00~~ **\$1975.00** *Save 775.00*



HP 125



OUR PRICE ~~MSL 2750.00~~ **\$1975.00** *Save 775.00*

DUAL MASTER DRIVE
MSL ~~OUR PRICE 2500.00~~ **1595.00** *Save 905.00*



XEROX 820 WORD PROCESSING SYSTEM (INCLUDES SOFTWARE)

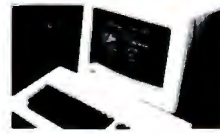

MSL ~~OUR PRICE 3495.00~~ **\$2649.00** *Save 846.00*

NEC STUDENT SYSTEM 64K



*NEC PC 80001
*NEC PC 8012
*NEC PC 8031
12" Grn. Phs Video Monitor

MSL ~~OUR PRICE 2839.00~~ **\$2095.00** *Save 744.00*



HP-87



MSL ~~OUR PRICE 2495.00~~ **\$1749.00** *Save 746.00*



VIC-20



Vic TV Modual \$19.00
Vic Cassette \$69.00
Vic Disk Drive \$ Call
Vic 6 Pack program \$44.00

MSL ~~OUR PRICE 299.00~~ **\$255.00** *Save 44.00*



OUR PRICE ~~MSL 645.00~~ **429.00** *Save 216.00*
~~MSL 745.00~~ **535.00** *Save 210.00*
~~MSL 995.00~~ **719.00** *Save 276.00*



STUDENT SYSTEM

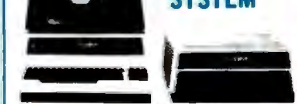

4032 - 32K 40 COL CRT
4940 - DUAL DISK DRIVE
MSL ~~OUR PRICE 2590.00~~ **\$1978.00** *Save 612.00*

WE RESERVE THE RIGHT TO CORRECT TYPOGRAPHICAL ERRORS. THIS AD SUPERCEDES ALL PREVIOUS ADS.

RADIO SHACK 48K TRS 80 W/2 DRIVE MOD III



MSL ~~OUR PRICE 2495.00~~ **\$1799.00** *Save 696.00*

1 Year Extended
WARRANTY
\$99.00
INQUIRE

AVINGS
ERVICE
LECTION
ATISFACTION

MICRO BUSINESS WORLD MAIL ORDER WAREHOUSE

18720 Oxford, #108
Torrans, CA 91398
OUTSIDE CA CALL TOLL FREE 1 (800) 423-5886 IN CA (213) 996-2252

Telex: 182852
Answer: MICKO T2NA

*California residents add 6% sales tax
**Add 3% Shipping & Handling - Add 3% surcharge for credit cards. Orders cannot be shipped unless accompanied by payment, including shipping handling and tax where applicable

Name (Please print) _____
Address _____
City _____ State _____ Zip _____
Qty Make Model Description Price Total

TOTAL ORDER \$ _____
TAX IF APPLICABLE* _____
SHIPPING & HANDLING** _____
TOTAL ENCLOSED \$ _____

Certified Check or M.O. Allow 2 weeks clearance for personal check
Bank Wire Transfer
CREDIT CARD # _____
Exp Date _____

Signature _____
VISA MasterCard

Listing 1 continued:

```
1190 K=2:IF J=0 THEN K=1
1200 PRINT BB$(K)MID$(AV$(J),I,1);
1210 NEXT J
1220 REM GO ON TO NEXT ROW
1230 IF I<10 THEN PRINT
1240 NEXT I
1250 REM RETURN CURSOR TO HOME
1260 PRINT "<S>";
1270 RETURN
1280 :
1290 REM*** DISPLAY SCALE ADJECTIVES WITH HIGHLIGHTING
1300 REM GO DOWN TO POSITION
1310 PRINT "<Q><Q><Q><Q><Q><Q><Q><Q>";
1320 REM DISPLAY THREE LINES OF ADJECTIVES
1330 FOR J=0 TO 2
1340 REM SET REVERSE VARIABLES, ON AND OFF
1350 A$="<R>":B$="<r>"
1360 REM DO NOT HIGHLIGHT IF ERASING A LINE
1370 IF AJ$(I,J,0)="[ ][ ][ ][ ][ ][ ][ ][ ]" THEN A$="":B$=""
1380 REM PRINT A ROW
1390 PRINT A$;AJ$(I,J,DI);B$;BB$(0);A$;AJ$(I,J,1-DI)
1400 NEXT J
1410 PRINT "<S>";
1420 RETURN
1430 :
1440 REM*** STIMULUS PRESENTATION
1450 REM ERASE OLD STIMULUS
1460 PRINT BB$(3)"<S>";
1470 REM SELECT STIMULUS RANDOMLY
1480 FOR K=1 TO 2000:L=INT(LL*RND(1))
1490 IF R%(L,0,T)=0 THEN K=2000:NEXT K:GOTO 1540
1500 NEXT K
1510 REM EXCESSIVE DELAY: SELECT STIMULUS SEQUENTIALLY
1520 FOR K=0 TO LL-1:L=K:IF R%(L,0,T)>0 THEN NEXT K
1530 K=LL-1:NEXT K
1540 A$=WD$(L)
1550 REM COMPUTE SPACES FOR CENTERING
1560 K=INT((40-LEN(A$))/2)
1570 REM PRINT THE STIMULUS, HIGHLIGHTED
1580 PRINT MID$(BB$(3),1,K)"<R>"A$"<r><S>";
1590 RETURN
1600 :
1610 REM*** OBTAIN JUDGEMENT
1620 REM DISPLAY CHECKMARK ABOVE SCALE
1630 PRINT "<Q><Q>";CU$;MID$(BB$(3),1,19)"[:]";
1640 REM GET KEYBOARD INPUT
1650 GET MV$
1660 IF MV$=CHR$(13) THEN 1840 :REM MOVING DONE
1670 IF MV$="<" THEN A$="<>[ ]<><>[:]":A=33288:GOSUB 1720:REM MOVE LEFT
1680 IF MV$=">" THEN A$="<>[ ][:]":A=33326:GOSUB 1720:REM MOVE RIGHT
1690 GOTO 1650
1700 REM MOVE THE CHECKMARK
1710 REM STOP WHEN CHECK IS AT SIDE OF SCREEN
1720 IF PEEK(A)=122 THEN RETURN
1730 REM ERASE OLD CHECK AND PRINT NEW CHECK
1740 PRINT A$;
1750 REM 'LIFT' KEY ARTIFICIALLY FOR AUTO REPEAT
```

Listing 1 continued on page 222

CALL "THE COMPUTER-LINE"™

When you call us, you talk to fully qualified computer specialists trained to answer all your questions pertaining to our line of microcomputers. We are renowned for our excellent after sales support and our promptness for delivery. Peace of mind and excellence in service is our pledge to all our customers.

NEC PERSONAL COMPUTER

- PC-8001A Keyboard and processor unit, including 32K Ram, 24KB N-Basic Rom, cassette tape recorder interface, parallel printer interface, display interface. **\$749**
- PC-8012A Modular expansion unit, including I/O bus extension, diskette adaptor, 32KB Ram, real-time clock, 8 priority Interrupt levels, 6 slots for additional boards. **\$479**
- PC-8023A Dot matrix printer - 100 cps, bidirectional printing, proportional printer. **\$499**
- PC-8031A Dual diskette unit, including two 163K byte diskette drives, interface cable, enclosure and operating system. **\$749**
- We carry the entire line of NEC/BPI software for the personal computer. Please call or write for information.

CALIFORNIA COMPUTER SYSTEMS

- 7710 Async. Serial Int. **\$135**
- 7490 GPIB (IEEE-488) Int. **\$239**
- 7470 Ana. to Dig. Converter **\$ 99**
- 7711 Async. Serial (Term) **\$135**
- 7712 Sync. Serial Int. **\$149**
- 7721 Apple Parallel Int. **\$109**
- Calendar/Clock Module **\$ 99**
- Programable Timer **\$ 99**

MOUNTAIN HARDWARE

- CPS Multi-Function Card **\$169**
- The Clock **\$229**
- Supertalker **\$159**
- Music System **\$319**
- Expansion Chassis **\$599**
- Romwriter **\$139**
- Ram Plus (32K Board) **\$149**

PRINTERS

- NEC**
Spinwriter 7710 **\$2339**
8023A **\$ 499**
- EPSON**
MX-80 **\$ 429**
MX-80FT **\$ 529**
MX-100 **\$ 699**

INTEGRAL DATA SYSTEMS

- PRISM 132 Color printer with all options
- 200 cps Sprint Mode
 - 4-color printing
 - Friction/Tractor feed **\$1595**

C-ITOH

- F10 word quality printer **\$CALL**
- Prowriter **\$CALL**

- OKIDATA PRINTERS** **\$CALL**
- CORONA-SMITH** **\$ 699**

All Epson and NEC dot matrix printer prices quoted are for **immediate** delivery inclusive of shipping, insurance and handling charges.



BUSINESS SOFTWARE

- VISICORP, INC.**
- Desktop Plan III **\$229**
- Desktop Plan II **\$189**
- Visifiles **\$189**
- Visiplot **\$159**
- Visitrend/Visiplot **\$229**
- Visidex **\$189**
- Visiterm **\$ 79**
- Visicalc 3-3 **\$189**
- Visipak **\$539**

STONEWARE

- DB Master **\$169**
- DB Utility Pack **\$ 69**
- MICRO PRO**
- Apple CP/M **\$219**
- Word Star **\$119**
- Super Sort **\$119**
- Mall Merger **\$ 79**
- Data Star **\$179**
- Spell Star **\$119**
- Call Star **\$119**

INFORMATION UNLIMITED

- Pro Easy Writer **\$169**

Call For Continental, Dakin 5, Broderbund, Automated Simulations, Avant-Garde, Edu-Ware, Denver, Howard, Sirius, Sensible, Synergistic Software, Etc.

HEWLETT-PACKARD PRODUCTS • PLEASE CALL OR WRITE FOR CATALOG.

APPLE SOFTWARE PLEASE CALL OR WRITE FOR OUR COMPREHENSIVE CATALOG.

Absolutely no one has lower Apple software prices!

MICROCOMPUTER BUSINESS INDUSTRIES

- Appletime™ Clock Card **\$ 89**
- VIP™ Card. (The Ultimate graphics interface + cable) **\$99**
- All other VIP™ Cards **\$CALL**

(See advertisement this Byte)

COMPARE!

DRIVES FOR APPLE

WITH CONTROLLER

\$459

ADD-ON \$389

Hard Disks + 8" Disks for Apple, TRS-80 **\$CALL**

Apple Computer Products **\$CALL**



PRODUCTS • PLEASE CALL OR WRITE FOR CATALOG.

MODEMS

- Hayes Micromodem II **\$289**
- Hayes Smartmodem **\$229**
- Hayes Chronograph **\$199**
- Novation Cat **\$145**
- Novation D-Cat Modem **\$165**
- Novation Apple Cat II **\$339**
- Novation Auto Cat **\$209**

DISKETTES (Boxes of 10)

- Verbatim Datalife **\$ 24-95**
- Verbatim 8" Double-Side/DD **\$ 39-95**

RAM CARDS

- Davong 16K Card **\$ 89**
- Microsoft 16K Card **\$129**

T and G PRODUCTS

- Game paddles **\$ 29**
- Joy Stick **\$ 44**
- Select-a-port Expander **\$ 49**

MONITORS

- Zenith ZVM-121 Phosphor 15 MHZ **\$119**
- NEC 1201 Phosphor 20 MHZ **\$179**
- NEC 0112 Composite Color **\$335**
- NEC 2112 RGB Color **\$899**
- Amdek 300 Phosphor **\$199**
- Amdek Composite Color **\$355**
- Amdek IBM Compatible Color **\$899**

80 COLUMN CARDS

- FOR APPLE**
- Wesper 80 Card **\$259**
- Vision 80 Card (Vista) **\$289**
- Videx 80 Card **\$259**

MISCELLANEOUS

- APPLE PRODUCTS**
- Enhancer II **\$ 119**
- Dana Apple Fan **\$ 39**
- Sup R Mod **\$27-95**

IN COLORADO (303) 279-2727

CALL "THE COMPUTER-LINE"™

1-(800)-525-7877

COMPUTERWORLD INTERNATIONAL, INC.

SUITE 133, P.O. BOX 81, WHEAT RIDGE, COLORADO, U.S.A. 80034-0081



TERMS: RETAIL/MAIL ORDER: ADD 1% SHIPPING (MINIMUM \$2.50) - UPS GROUND.

WE HONOR ALL MANUFACTURERS WARRANTIES AND EXCHANGE FAULTY GOODS IMMEDIATELY. SPECIALISTS IN APO AND INTERNATIONAL DELIVERIES.

RETAIL: 1019 8TH STREET
GOLDEN, CO 80401

Listing 1 continued:

```
1760 REM (FOR OLD ROM USE POKE 515,255 )
1770 POKE 151,255
1780 REM SLOW DOWN
1790 FOR A=1 TO 20:NEXT A
1800 RETURN
1810 :
1820 REM*** DEFINE SCALE VALUE AND RECORD
1830 REM MOVE ACROSS SCALE
1840 FOR I=1 TO 39
1850 REM SEARCH FOR CHECKMARK
1860 A=PEEK(33287+I)+64
1870 IF A<>ASC("[ : ]") THEN NEXT I
1880 REM POSITION = VALUE
1890 VL=I
1900 REM CLOSE LOOP
1910 I=39:NEXT I
1920 REM ERASE THE CHECK
1930 PRINT "<>[ ]<S>";
1940 RETURN
1950 :
1960 REM*** PRESENT EPA, AND SAVE DATA
1970 REM SET FLAG FOR MOTIVATION TEST.
1980 K=0
1990 REM RANDOMIZE ORDER OF PRESENTATION OF DIMENSIONS
2000 Q%(0)=INT(1+10*RND(1)/4)-1
2010 Q%(1)=INT(1+10*RND(1)/4)-1
2020 IF Q%(1)=Q%(0) THEN 2010
2030 Q%(2)=3-Q%(0)-Q%(1)
2040 REM GO THROUGH THE THREE DIMENSIONS
2050 FOR N=0 TO 2
2060 REM RANDOMIZE DIRECTION OF SCALE
2070 DI=INT(RND(1)+.5)
2080 REM DISPLAY THE SCALE
2090 I=Q%(N):GOSUB 1310
2100 REM GET THE RESPONSE
2110 GOSUB 1630
2120 REM UNRANDOMIZE THE DATA AND STORE
2130 R%(L,Q%(N),T)=ABS(VL-DI*40)
2140 NEXT N
2150 REM MOTIVATION CHECK ON WHETHER RATER IS JUST PRESSING RETURN
2160 IF K=1 OR R%(L,0,T)<>20 OR R%(L,1,T)<>20 OR R%(L,2,T)<>20 THEN RETURN
```

Listing 1 continued on page 224

COM - MU - NI - CA - TION (ka myōō' nā kā' shān)

the science of transmitting information

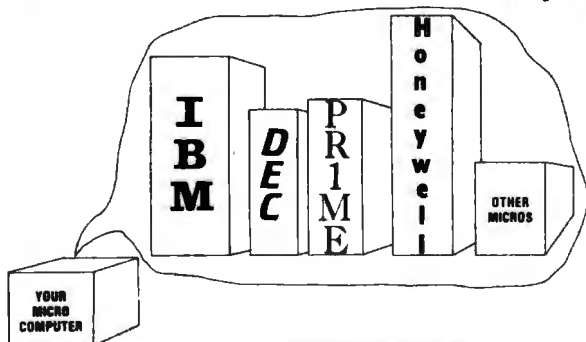

The Advanced Communications Emulator (ACE) from SST is state of the art in Z-80 CP/M communications. ACE can turn your micro-computer into a powerful communications system. ACE has such features as:

- *full duplex terminal emulation with selectable local echo
- *file transfers (including binary) to/from any computer
- *user control of communications even during file transfers

For complete information contact:

Shared Systems Technologies Inc.

Route 7 South • Box 163
Bennington, VT 05201 (802) 442-8008

SEIKOSHA
GP-100A



GP-100A: US\$389

COMMAND PERFORMANCE.

Seikoshi gives you all the best features—including economy and super-clear graphics.

Unlike some graphic printers, Seikoshi's new GP-100A Uni-Hammer Graphic Printer puts full dot addressable graphics at your command. The GP-100A lets you repeat a column of data as many times as needed with just one command. Software control enables double-width character output, and the positioning is both character and dot addressable. Designed for simple operation, it ranks among the most cost-efficient graphic printers on the market. Command performance technology that not only works for you now, but takes you well into the future.

Other valuable features:

- Graphics, regular and double width character modes can be intermixed on the same line.
- Automatic printing. When the text exceeds the maximum line length, there is no loss of data due to overflow.
- Self-test printing is a standard feature.
- Centronics type parallel interface.
- Paper width is adjustable up to 10 inches.
- Optional Interface: RS232C, IEEE488, apple II, etc.

Graphic Printer  Series

Available at COMPUTERLAND and other fine stores in your area

Distributed by **AXIOM CORPORATION** 1014 Griswold Avenue San Fernando, Calif. 91340 Phone (213) 365-9521 TWX (910) 496-1746

Manufactured by **SEIKOSHA SYSTEM EQUIPMENT DIV.** 4-1-1 Taihei Sumida-ku Tokyo Japan. Phone: 03-623-8111 Telex: 262-2620

Circle 424 on inquiry card.

Listing 1 continued:

```
2170 PRINT "<S><Q><Q><Q><Q>"NM$", YOU RATED THIS ONE
2180 PRINT "AT THE MIDDLE ALL THREE TIMES. [L]ET'S
2190 PRINT "DO IT AGAIN TO BE SURE ABOUT THAT.
2200 REM PUNISHING DELAY
2210 FOR I=1 TO 5000:NEXT I
2220 REM ERASE MESSAGE
2230 PRINT "<S><Q><Q><Q><Q>"BB$(3)
2240 PRINT BB$(3)
2250 PRINT BB$(3)"<S>";
2260 REM COUNT HOW OFTEN THIS HAPPENS
2270 REM (THIS IS SAVED ON TAPE WITH BACKGROUND QUESTIONS)
2280 BA%(0)=BA%(0)+1
2290 REM RESET FLAG SO AS TO DO OVER ONE TIME
2300 K=1:GOTO 2000
2310 :
2320 REM*** DEFINITION OF STIMULI BY PROGRAMMER
2330 REM NUMBER OF STIMULI
2340 LL=2
2350 REM NUMBER OF BACKGROUND QUESTIONS IN THE SIGN-OFF SUBROUTINE
2360 NB=0
2370 REM SAVE NUMBER OF STIMULI, REPLICATIONS, AND QUESTIONS ON TAPE
2380 PRINT#1,LL;CHR$(13);NR;CHR$(13);NB;CHR$(13);
2390 REM SET UP DATA ARRAYS
2400 DIM WD$(LL-1),R%(LL-1,2,NR-1)
2410 REM READ IN THE STIMULI; CONVERT TO CAPS/LC
2420 FOR I=0 TO LL-1:READ A$:GOSUB 860:WD$(I)=A$:NEXT I
2430 REM DEFINITIONS OF STIMULI
2440 REM EXAMPLE DEFINITIONS:
2450 DATA "MAKING LOVE","SOCIOLOGISTS"
2460 REM ADD MORE DATA STATEMENTS IF NEEDED
2470 RETURN
2480 :
2490 REM*** DEFINITION OF STIMULI BY RESPONDENT
2500 REM GET NUMBER OF STIMULI
2510 PRINT "<Q>[Y]OU ARE TO PROVIDE THE WORDS FOR THIS
2520 PRINT "ASSIGNMENT. [S]O LET'S DO THAT NOW.
2530 PRINT "<Q>[H]OW MANY THINGS ARE YOU GOING
2540 PRINT "TO RATE";
2550 GOSUB 720:LL=VAL(A$):REM INPUT
2560 IF LL<21 THEN 2640
2570 REM USER WANTS TOO MANY
2580 PRINT "<Q>[S]ORRY,[ ]"NM$",[ ][I] CAN ONLY HANDLE
2590 PRINT "20 AT A TIME. [H]OW MANY DO YOU WANT TO
2600 INPUT "DO ON THIS RUN";LL
2610 IF LL<21 THEN 2640
2620 PRINT "<Q>[P]LEASE! [N]O MORE THAN":GOTO 2590
2630 REM SET UP DATA ARRAYS
2640 DIM WD$(LL-1),R%(LL-1,2,NR-1)
2650 REM GO INTO CAPS MODE
2660 POKE 59468,12
2670 REM GET THE STIMULI
2680 PRINT "<s><Q>FINE. NOW WHAT ARE THE WORDS?<Q><Q>
2690 FOR I=1 TO LL
2700 PRINT "<Q>"I;:GOSUB 720
2710 REM CONVERT STIMULUS TO CAPS AND LOWER CASE
2720 GOSUB 860:WD$(I-1)=A$
2730 NEXT I
2740 REM RETURN TO CAPS AND LOWER CASE OPERATIONS
```

Listing 1 continued on page 226

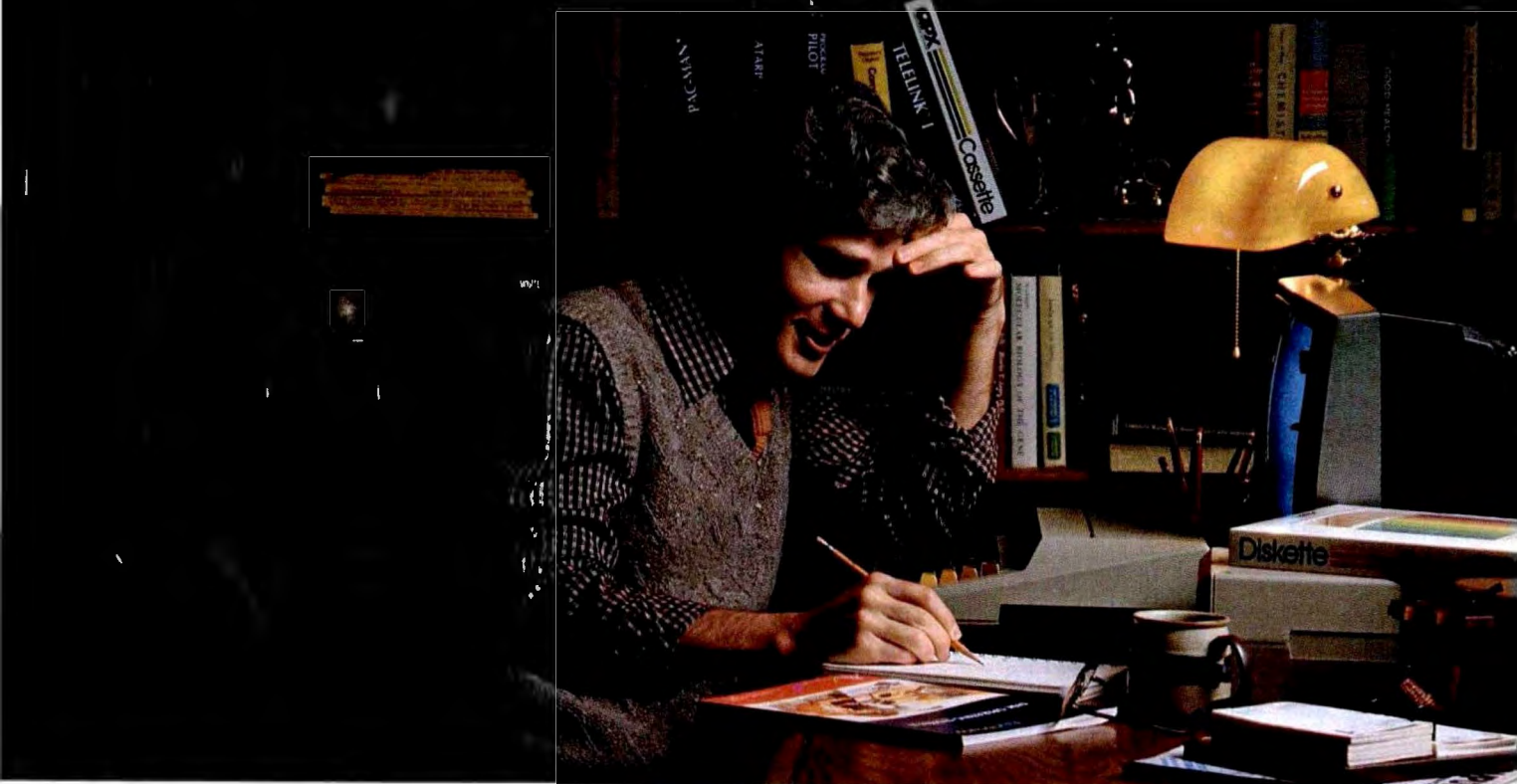

MORE THAN EVER, ATARI HOME COMPUTERS ARE SPEAKING YOUR LANGUAGE.

With more program languages than ever to choose from, you now have more opportunities than ever to utilize the amazing capabilities of the ATARI 800™ Home Computer.

Whether you're a beginning programmer, or at the forefront of the art, you'll find an ATARI programming language that can make your task quicker and simpler than ever before. Just look at what ATARI has to offer:

ATARI Microsoft BASIC—Now we offer the industry standard, most powerful Microsoft BASIC yet. With simple commands, it allows you to take advantage of unique ATARI hardware features such as our well-known player/missile graphics. For ease of programming, it includes n-dimensional arrays for numerics and string handling. And importantly, conversion procedures are simple.

ATARI Macro Assembler—Faster and more powerful than any ATARI language before, the ATARI Macro Assembler also allows you to access more memory space. And it's excellent for I/O interface and manipulation of such features as: player/missile graphics, sound registers and peripherals. In addition, the macro processor and "include" file library features speed-up program development considerably.

Fig-FORTH*—For specialized programming needs, such as educational or game applications, ATARI Fig-FORTH is uniquely effective. Fig-FORTH combines power and simplicity in an efficient 10K size, with

characteristics of an interpreter and the speed of machine language code.

ATARI BASIC—An affordable and easy to use BASIC that requires only 8K of memory. It allows you to take advantage of the spectacular ATARI graphics and sound capabilities. And its immediate mode error messages greatly simplify debugging.

ATARI Assembler Editor—An excellent tool to assist the assembler-programmer in creating, editing and debugging assembly programs.

PILOT—ATARI PILOT is an exceptional learning language, with built-in "turtle" graphics to let you create spectacular designs and pictures with very short programs. Simple one or two-letter commands allow you to create a dialogue with the computer. And a single "match" command can perform complex text evaluation and pattern-matching instantly.

ATARI is constantly developing new ways to help you get more out of your ATARI 800 Home Computer. So watch for more innovative and exciting programming languages from ATARI in the future.

In addition to bringing the computer age home, ATARI is committed to answering the needs of computer programmers.



© 1982 ATARI, Inc. All Rights Reserved
*Available from the ATARI Program Exchange

ATARI HOME COMPUTERS

We've Brought The Computer Age Home.™

Listing 1 continued:

```
2750 POKE 59468,14
2760 REM ALERT USER, THEN CLEAR SCREEN
2770 PRINT"<s>"
2780 PRINT"<S><Q><Q><Q><Q>[O][K]. [H]ERE WE GO."
2790 FOR I=1 TO 1000:NEXT I
2800 PRINT"<s>";
2810 RETURN
2820 :
2830 REM*** DISPLAY RESULTS
2840 REM OR SAVE RATINGS ON TAPE
2850 IF NOT TEACHING THEN FOR K=0 TO NR-1:FOR I=0 TO LL-1:FOR J=0 TO 2
2860 IF NOT TEACHING THEN PRINT#1,R%(I,J,K);CHR$(13);:NEXT J,I,K
2870 IF NOT TEACHING THEN RETURN
2880 PRINT "<s>[O][K]. [Y]OU'VE RATED EACH WORD TWICE ON THE
2890 PRINT "THREE SCALES.
2900 PRINT "<Q>[N]OW, [I]'LL SHOW YOU THE AVERAGE
2910 PRINT "PROFILES. [T]HEN [I]'LL SHOW YOU GRAPHS OF
2920 PRINT "THE RESULTS.";CU$
2930 REM WAIT FOR USER TO RESPOND
2940 GOSUB 3670
2950 REM PRESENT PROFILES
2960 REM PRINT HEADERS
2970 PRINT TAB(16)"<R>"DM$(0)SPC(2)DM$(1)SPC(2)DM$(2)
2980 PRINT TAB(16)"<R>+[ ][ ]=[ ][ ]"SPC(2)"+[ ][ ]=[ ][ ]"SPC(2)"+[ ][ ]=[ ][ ]"
2990 PRINT TAB(16)"<R>[G]OOD[ ][ ]"SPC(2)"[S]TRONG"SPC(2)"[F]AST[ ][ ]<Q>"
3000 IF PAPER THEN CMD 4
```

Listing 1 continued on page 228

HONORABLE...

Introducing the Honorable Shell-

OKARA™

A true breakthrough in operational technology for CP/M™ systems.

OKARA lets you, the user, create command scripts to replace the boring, repetitive, error-prone keyboard dialogs normally required by CP/M and the programs that run under it. With OKARA the machine presents any personality you design, from simple cryptic commands that do it all to elaborate, hand-holding menus. OKARA is a must for anyone who uses CP/M. And a super-must for system integrators, software developers, office managers, teachers, parents... anyone who sets up CP/M applications for others.

- Fast** - 20 to 100 times faster than SUBMIT, SUPERVYZ,™ or STOK PILOT.™
- Universal** - Nearly all present and future CP/M applications will run under OKARA without modification.
- Tiny** - Typically under 3K with all modules loaded, plus 2K for CCP.
- Price** - \$150, single copy. \$130, disk only. \$20, manual only. OEM discounts available.
- Smart** - You can use it like SUBMIT, or program it to create your own menus or other dialogs.
- Formats** - 8" single density, 5" Osborne, Apple, Northstar.
- Simple** - If you use CP/M, you can learn OKARA in an hour or less.
- System** - 8080, Z80, or 8085 cpu, CP/M 2.2 Operating System. Text editor to create scripts.
- Slick** - Provides some enhancements that CP/M has always needed.
- Friendly** - In so many ways. One example, OKARA can page console output from any program or command. No more racing to type a control-S.

*OKARA is a trademark of KIAI Systems. SUPERVYZ is a trademark of EPIC Computer Corporation. STOK PILOT is a trademark of STOK Computer Interface. CP/M is a trademark of Digital Research.

KIAI
SYSTEMS

P.O. Box 11461
Oakland, CA 94611
(415) 654-8671

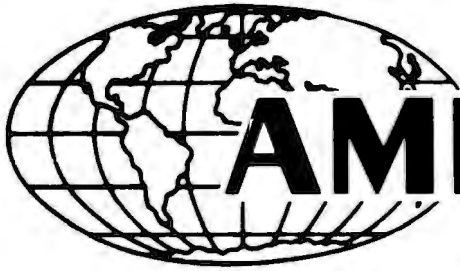

AMERICAN

SMALL BUSINESS COMPUTERS

118 SO. MILL ST
PRYOR, OK 74361
(918) 825-4844

ALL PRICES ARE CASH DISCOUNTED 3% C.O.D. AND CHARGE ORDERS ARE 3% MORE
RETAIL LOCATION: 447 S. WOOD, PRYOR, OKLAHOMA 74361

TRS-80 MODEL III

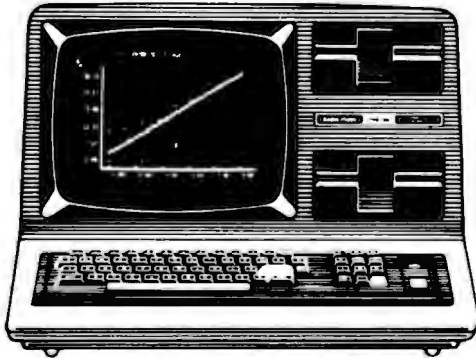

16K.....\$825

48K.....\$849

48K 1 DRIVE.....\$1499

48K 2 DRIVE.....\$1749

RS-232 (INSTALLED).....\$92.00

CASSETTE.....\$55.00

THERE'S NO SECRET

There's no secret as to why we can sell TRS-80 computer equipment for less. Low overhead — that's the reason — pure, simple and straight! As everyone knows, Radio Shack is a huge corporation...with huge expenses. We are able to buy the bare-bones computers from Radio Shack. To these computers, we add our own memory chips, disk drives, cables, etc. The result is a computer system which is equal to, or in many cases, superior to the one you would get from Radio Shack in both price and performance capabilities. There is one thing that you don't get from Radio Shack — their 90 day warranty. What you get in its place is the exclusive 180 days American Small Business Computer's Warranty. So...if you like the Radio Shack computer, but don't like the price...CHECK US OUT!!!

American Small Business Computers is not an authorized Radio Shack Dealer. We do not offer a Radio Shack 90 Day Warranty on our computers. Instead, we offer the American Small Business Computers 180 Day Warranty. If you have a problem with your computer, return it to us for about 48 hours. If we can't fix it, we'll replace it!

918-825-4844

Listing 1 continued:

```
3010 REM FOR ALL WORDS
3020 FOR I=0 TO LL-1
3030 REM TRUNCATE WORDS TO 12 CHARACTERS
3040 IF LEN(WD$(I))>12 THEN WD$(I)=LEFT$(WD$(I),12)
3050 REM PRESENT INDEX LETTER, WORD AND SPACE OVER TO E COLUMN
3060 PRINT CHR$(I+65);"[ ]";WD$(I)SPC(13-LEN(WD$(I)));
3070 REM FOR E, P, AND A
3080 FOR J=0 TO 2
3090 REM COMPUTE SUMMED RATING
3100 IF NR>1 THEN FOR K=1 TO NR-1:R%(I,J,0)=R%(I,J,0)+R%(I,J,K):NEXT K
3110 REM COMPUTE AVERAGE, SCALED INTO RANGE: + OR -4.75
3120 A=-((R%(I,J,0)-20*NR)/(4*NR))
3130 REM CONVERT TO STRING
3140 A$=STR$(A)
3150 REM ADD A SPACE IN FRONT OF FRACTIONS
3160 IF ABS(A)<1 THEN A$=" "+A$
3170 REM ADD SPACES TO NEXT COLUMN AND PRINT
3180 A$=LEFT$(A$+BB$(0),8)
3190 PRINT A$;
3200 NEXT J:PRINT
3210 REM DO NEXT WORD
3220 NEXT I:PRINT
3230 IF PAPER THEN PRINT#4
3240 REM WAIT FOR USER RESPONSE
3250 GOSUB 3670
3260 REM MAKE GRAPHS
3270 REM DEFINE HORIZONTAL, VERTICAL, AND LATENT AXES
3280 HA=0:VA=2:LA=1
3290 REM MAKE A GRID
3300 PRINT:PRINT:FOR I=1 TO 19
3310 PRINT TAB(6);:FOR J=1 TO 27:PRINT "[ ]";:NEXT J:PRINT
3320 NEXT I
3330 REM LABEL THE VERTICAL AXIS
3340 PRINT "<S><Q>"SPC(16);DM$(VA)
3350 REM EMPHASIZE THE VERTICAL AXIS
3360 FOR I=1 TO 19:PRINT TAB(19)"[ ]";:NEXT I
3370 REM MOVE TO HORIZONTAL AXIS
3380 PRINT "<S>"CU$;SPC(6);
3390 REM EMPHASIZE IT
3400 FOR I=1 TO 27:PRINT "[@]";:NEXT I
3410 REM LABEL IT
3420 PRINT DM$(HA)
3430 REM ADD NUMERICAL LABELS TO VERTICAL AXIS
3440 PRINT "<S><Q>"
3450 FOR I=-4 TO 4:PRINT "<Q>"TAB(19)"<R>"CHR$(48+ABS(I)):NEXT I
3460 REM ADD NUMERICAL LABELS TO HORIZONTAL AXIS
3470 PRINT "<S>"CU$;SPC(5);
3480 FOR I=-4 TO 4:PRINT "<]><]><R>"CHR$(48+ABS(I));:NEXT I
3490 REM FOR EACH STIMULUS
3500 FOR I=0 TO LL-1
3510 REM BEGIN AT UPPER LEFT
3520 PRINT "<S><Q>";
3530 REM GO DOWN PROPORTIONAL TO VALUE ON VERTICAL AXIS
3540 FOR J=1 TO INT((1+(2*R%(I,VA,0)/NR))/4):PRINT "<Q>";:NEXT J
3550 REM GO OVER PROPORTIONAL TO VALUE ON HORIZONTAL AXIS
3560 PRINT TAB(5);
3570 FOR J=1 TO INT((80.92-(2*R%(I,HA,0)/NR))/2.92):PRINT "<]>";:NEXT J
```

Listing 1 continued on page 230

IBM PERSONAL COMPUTER USERS

COMPLETE YOUR REFERENCE LIBRARY

Que On Systems

IBM's PERSONAL COMPUTER

Que Corporation's new 300 page book, IBM's PERSONAL COMPUTER describes the hardware, peripherals and IBM's program library. Whether you are an IBM Personal Computer user or prospective buyer, you will discover the significance of IBM's new product to your personal or business applications.

...at computer stores and fine book stores \$14.95



and...

PERSONAL COMPUTER AGE

The Definitive Journal For The IBM Personal Computer User

Keeps you updated monthly with the latest news and applications for your IBM Personal Computer. Featuring: Hardware and Software Reviews — New Product Announcements — Technical Articles — Problem Reporting — Vendor Directory — Classified Ads — Special Interest Columns.

\$18.00/YR.
(12 issues)

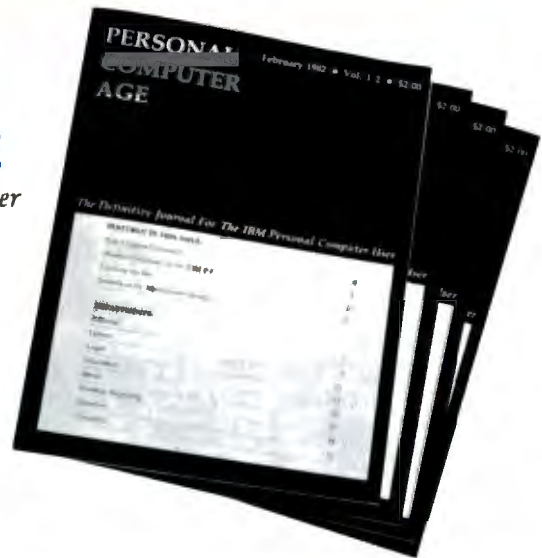

BOTH FOR ONLY \$22.95

PERSONAL COMPUTER AGE

For Credit Card Orders, Dial Toll Free
(800) 227-2634 ext. 936
In California
(800) 772-2666 ext. 936

- I Want Everything — PERSONAL COMPUTER AGE and IBM's PERSONAL COMPUTER for \$22.95
- NEW RENEWAL
- Send the Book only for \$14.95
- Just enter my subscription to PERSONAL COMPUTER AGE for \$18.00
- Payment Enclosed

Charge my: VISA MASTER CHARGE

Card # _____

Expiration Date: _____

Authorized Signature _____

Name _____

Address _____

City _____

State _____ Zip _____

PERSONAL COMPUTER AGE P.O. BOX 70725 Pasadena, California 91107 Dept B1

New from HIPLØT™

multi-pen plotting for as little as \$1480*.

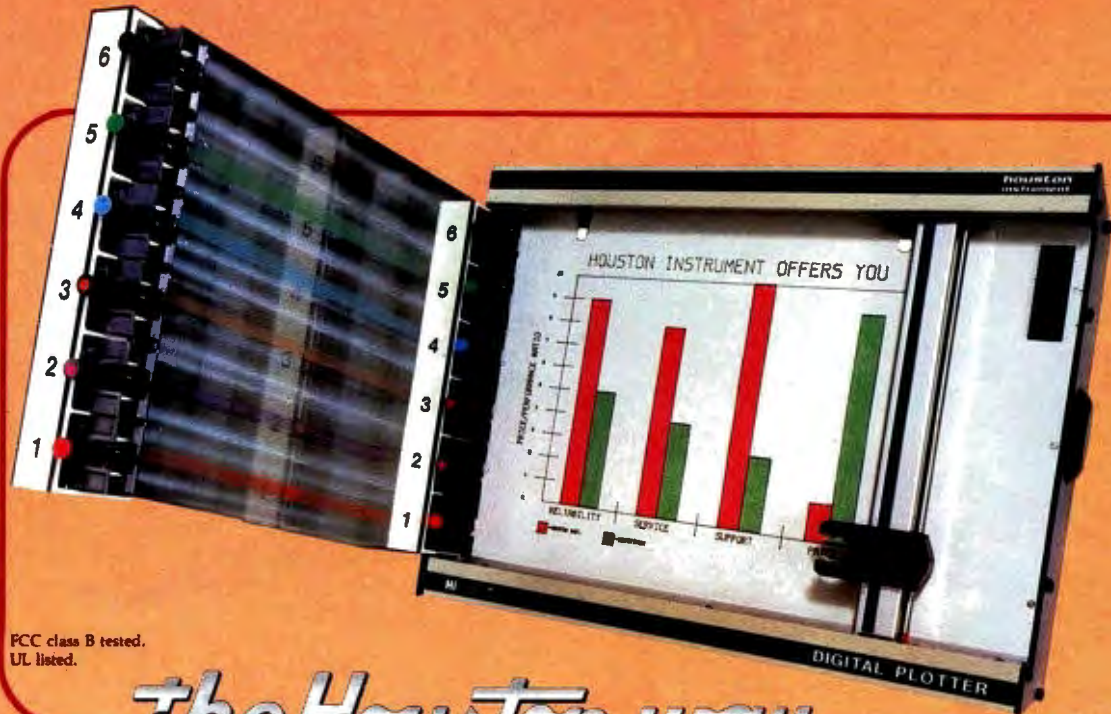

FCC class B tested.
UL listed.

The Houston way

The new HIPLØT DMP Series 6-pen option makes high performance multi-pen plotting affordable. It's available on the DMP 2, 3, and 4 models in the HIPLØT family so you can enjoy the advantages of multi-colored plots on 8½" × 11" (DIN A4) surfaces. Of course, you also get the standard HIPLØT range of capabilities such as intelligence, controls, interfaces and resolutions. There's a model for virtually every plotting application.

line which made low-cost, high performance digital plotting a reality.

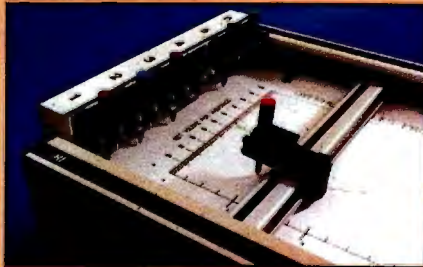

Now, with our new 6-pen option, there's an exciting new dimension in the DMP Series' versatility. Imagine two standard models with RS-232-C and parallel interfaces, four intelligent models with RS-232-C or Centronics® compatible interfaces, a choice of controls, resolutions, and pen speeds. Add to this the ability to plot with 6-pens on paper, vellum or mylar (ideal for overhead projectors) and you have the ultimate plotter price/performance combination — the perfect choice for the user or OEM.

8-Pen Models Also Available

If you need a little more capability, take a look at our new 8-pen option. It's available on the DMP 5, 6, and 7 so you can have 8-pen multi-colored plots on 11" × 17" (DIN-A3) surfaces.

Why wait? Let us send you complete information on this breakthrough in affordable, multi-pen plotting. Contact Houston Instrument, P.O. Box 15720, Austin, Texas 78761. (512) 835-0900. For rush literature requests, outside Texas, call toll free 1-800-531-5205. For technical information ask for operator #5. In Europe contact Houston Instrument, Rochesterlaan 6, 8240 Gistel, Belgium. Phone 059/27-74-45.



Big Performance in a Small Plotter
Since its introduction, the HIPLØT DMP Series has been recognized as the innovative plotter

INSTRUMENTS & SYSTEMS DIVISION
Together...we'll create tomorrow.

BAUSCH & LOMB 

Circle 42 for literature.
Circle 43 to have representative call.

TM Trademark of Houston Instrument.
* U.S. Suggested retail prices.
Centronics® registered trademark of
Centronics Data Computer Corp.

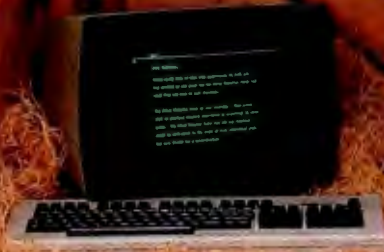

\$
4
/DAY
PER USER

Built For Dependability
ALTO
PROVEN VALUE
COMPUTER SYSTEMS
RELIABILITY
QUALITY DELIVERY
PRODUCED IN THE HEART OF SILICON VALLEY, CALIFORNIA U.S.A.
BRAND

OPEN FOR BUSINESS... THE NEW ALTOS ACCOUNTANT.

Introducing the complete multi-purpose, multi-terminal desktop business accounting system with a built-in tutor.

Get everything you need to computerize your business. An ALTOS* Series 5 computer (including 5 MByte Winchester hard disk and 1 MByte floppy), three of our smart terminals and a printer.

You also get the new ALTOS ACCOUNTANT, a completely integrated business accounting system that includes applications for general ledger, accounts payable, accounts receivable, inventory control, payroll, job costing and order processing.

There's more. You get the unique ALTOS COMPUTER TUTOR, the self-teaching tutorial that provides simple, self-paced, step-by-step training that makes using the computer easy.

Best of all, you get everything for less than \$4 per day per user.*

Complete hard disk systems start at \$9,980.

An Altos system is like having three computers in one. For example, while your bookkeeper prepares payroll, other users can check inventory, compute cost estimates or produce reports. All at the same time.

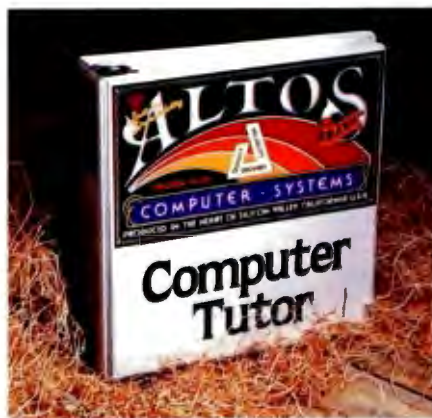

Need more? You can choose from hundreds of popular CP/M® and MP/M II™ applications like word processing, business planning, and communicating with other computers or networks. There's also nationwide on-site service available from your dealer.

Join the thousands of businesses that already rely on Altos. For more information, call our toll free number or write: Altos Computer Systems, 2360 Bering Drive, San Jose, CA 95131. We'll put you in touch with your local Altos sales and service dealer who'll introduce you to your very own ALTOS ACCOUNTANT.

Packed with fresh ideas for business



800-538-7872
(In Calif. 800-662-6265)

*Complete 3 user system for \$4 per day per user. Price approximate and may vary in your area. Daily lease based on \$12,800 principal, 20% annual interest, five-year term. Packaged system includes Altos Series 5-50 computer with 5 MByte Winchester hard disk and 1 MByte floppy, a draft quality printer, three Altos smart terminals, and the ALTOS COMPUTER TUTOR software package. Price does not include tax, installation, additional training and maintenance.

ALTOS is a registered trademark of Altos Computer Systems.
CP/M is a registered trademark and MP/M II is a trademark of Digital Research, Inc.

© 1982 Altos Computer Systems

Circle 20 on inquiry card.

Listing 1 continued:

```
4160 PRINT "SCALE LIKE THIS.<S>";
4170 REM DISPLAY EVALUATION ADJECTIVES
4180 I=0:DI=0:GOSUB 1310
4190 REM DISPLAY SCALE
4200 GOSUB 1030
4210 REM TIME DELAY
4220 FOR I=1 TO 1200:NEXT I
4230 REM OVERWRITE LAST INSTRUCTIONS WITH NEW
4240 PRINT "<Q><Q><Q>[A] CHECK MARK WILL APPEAR ABOVE THE LINE,";
4250 PRINT "AND YOU MOVE IT BACK AND FORTH WITH THE ";
4260 PRINT "<R><<r> KEY OR THE <R>><r> KEY. [Y]OU PRESS <R>RETURN<r>";
4270 PRINT "WHEN THE CHECK IS WHERE YOU WANT IT.
4280 PRINT "<Q>[G]O AHEAD AND TRY IT. [R]ATE [M][E].<S>";
4290 REM OBTAIN JUDGEMENT
4300 GOSUB 1630
4310 REM RESPONSE FOR GOOD JUDGEMENT
4320 IF VL<19 THEN PRINT "<s>[G]EE, "NM$".":PRINT "[T]HAT'S GOOD OF YOU!":GOTO 4360
4330 REM RESPONSE FOR BAD JUDGEMENT
4340 PRINT "<s>[G]OSH. [B]UT "NM$".":PRINT "[Y]OU HARDLY KNOW ME!"
4350 REM TIME DELAY
4360 FOR I=1 TO 1000:NEXT I
4370 PRINT "<Q><Q>[W]ELL, YOU'VE GOT THE IDEA.
4380 REM TIME DELAY
4390 FOR I=1 TO 1800:NEXT I
4400 REM FINISH INSTRUCTIONS
4410 PRINT "<s>[Y]OU RATE EACH THING ON THREE
```

Listing 1 continued on page 236

THE VOICE OF THE FUTURE . . . HEAR TODAY

Echo Speech Synthesizers

Now your computer can talk with an ECHO™ speech synthesizer from Street Electronics!

Our SPEAKEASY™ phoneme system provides unlimited vocabulary while using a minimum of memory. The TEXTALKER™ text-to-speech firmware allows you to simply type in a word or phrase and let the computer do the rest. With nearly 400 grammatical rules contained in the system, your computer can properly pronounce most correctly spelled words. Simple commands allow you to select from:

- Entire words pronounced or spelled letter by letter
- Different volumes
- Spoken punctuation if desired
- 63 different pitch levels
- Words spoken monotonically or with intonation
- Fast or slow speech output

The applications of the ECHO speech synthesizer are virtually unlimited, ranging from business and education to games to aiding the handicapped. The ECHO II which plugs into the Apple II is priced at \$199.95. The ECHO-GP is a complete stand alone unit which is compatible with most any computer; it sells for \$369.95.

Street Electronics Corporation
3152 East La Palma Avenue, Suite D
Anaheim, California 92806
(714) 632-9950



Introducing The FinalWord!

Word processing that goes beyond the stars.

How could anyone call their word processor The FinalWord? Take the best features of the most popular word processors, combine them and add a few more in one text editor/formatter and you'd be off to a good start. Then, write the program in C to allow user customization and make it capable of supporting any printer on the market and you'd be ahead of everybody else. If you went one step further and made your word processor transportable from one terminal to another you'd have—The FinalWord.

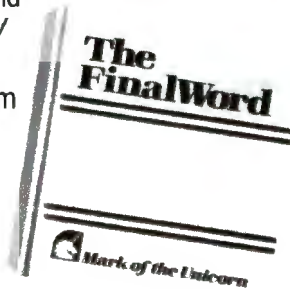

Supports multiple printers: The FinalWord allows you to produce high-speed draft copies on one printer, and letter-quality on another. It also means you'll never need another version just because you bought a new printer.

User-installable on different hardware: With The FinalWord you can upgrade your system and still have a familiar screen display. And since we've written The FinalWord in C, new versions are available almost as soon as new computers.

Features that go beyond the stars: Look at what you get with The FinalWord: automatic generation of Table of Contents, Index, footnoting and chapter/section numbering; enhanced command sets (delete/move a letter, word, sentence, paragraph, page); multiple buffers and windows, deletion recovery, true proportional spacing and more. And because we wrote The FinalWord to be easily reconfigured for different systems, our price can be lower.

Features	The FinalWord	WordStar	Magic Wand
Full-Screen Editing	Yes	Yes	Yes
Directory Access while Editing	Yes	Yes	Yes
Simultaneous Printing while Editing	Yes	Yes	Yes
External Commands while Editing	Yes	Yes	No
Video Highlighting	Yes	Yes	No
Automatic Footnotes	Yes	No	No
User-Defined Commands	Yes	No	No
Multiple File Editing	Yes	No	No
Deletion Recovery	Yes	No	No
Supports Multiple Printers	Yes	No	No
Crash Recovery	Yes	No	No
Dynamic Include Files	Yes	No	Yes
Suggested Retail Price	\$300	\$495	\$395

The FinalWord requires a 56K CP/M system and video terminal with cursor positioning character sequences. It is presently available in 8" standard format for the TRS-80 Model II, Vector Graphics and Altos Systems. There are compatible versions for the HP-125, Xerox 820, Cromemco, Micropolis, Ohio Scientific and Dynabyte Systems, and there are 5¼" versions for the Heath/Zenith Z-89, Northstar, Apple and Superbrain. **Coming Soon: The FinalWord for the IBM Personal Computer.**

The FinalWord is available through leading retailers, Westico, and Discount Software, or directly from:

Mark of the Unicorn
 PO BOX 423
 Arlington, Massachusetts 02174
 (617) 489-1387

Dealer and OEM inquiries invited.
 Call for delivery schedule.
 Reserve yours now!



Mark of the Unicorn

Listing 1 continued:

```
4420 PRINT "DIFFERENT SCALES.<O>
4430 FOR I=1 TO 1500:NEXT I
4440 IF NOT TEACHING THEN 2780
4450 PRINT "[W]E'LL GO THROUGH EVERYTHING TWICE.
4460 PRINT "[A]FTER YOU'VE FINISHED, [I]'LL
4470 PRINT "CONVERT YOUR RATINGS TO NUMBERS,
4480 PRINT "CALCULATE AVERAGES, AND PRESENT THE
4490 PRINT "RESULTS IN CHARTS.
4500 RETURN
4510 :
4520 REM*** CLOSING
4530 REM FOR BACKGROUND DATA, INCLUDE LINES LIKE THESE
4540 REM PRINT "<s>[N]OW, "NM$", A FEW QUESTIONS ABOUT YOU." :IB=0
4550 REM IB=IB+1:INPUT "[A]RE YOU <R>1<r> MALE OR <R>2<r> FEMALE";A$:BA%(IB)=VAL(A$)
4560 PRINT "<s>[O][K], "NM$", THAT'S ALL." :PRINT "[H]OPE YOU ENJOYED IT!
4570 REM SAVE BACKGROUND DATA ON TAPE
4580 IF NOT TEACHING THEN FOR I=0 TO IB:PRINT#1,BA%(I);CHR$(13);:BA%(I)=0:NEXTI
4590 REM CLEAR DATA
4600 FOR I=0 TO LL-1:FOR J=0 TO 2:FOR K=0 TO NR-1:R%(I,J,K)=0:NEXT K,J,I
4610 FOR I=1 TO 5000:NEXT I
4620 RETURN
4630 :
4640 :
4690 REM*** ENTRY TO READ AND ANALYZE SAVED DATA
4700 OPEN 1,1
4710 INPUT "<s>NUMBER OF RESPONDENTS";I2
4720 INPUT#1,LL,I1,IB
4730 NR=I1*I2
4740 INPUT "ENTER -1 FOR HARD COPY, 0 FOR NONE";PA
4750 OPEN 4,4
4760 GOSUB 390
4770 DIM R%(LL-1,2,NR-1),WD$(LL-1)
4780 FOR H=0 TO I2-1
4790 FOR K=0 TO I1-1
4800 FOR I=0 TO LL-1
4810 FOR J=0 TO 2
4820 INPUT#1,R%(I,J,H*I1+K)
4830 NEXT J,I,K
4840 FOR I=0 TO IB
4850 INPUT#1,BA%(I)
4860 NEXT I,H
4870 FOR I=0 TO LL-1
4880 INPUT#1,WD$(I)
4890 NEXT I
4900 CLOSE 1
4910 POKE 59468,14
4920 PRINT "<s>";
4930 GOSUB 2970
4940 CLOSE 4
4950 END
```

Text continued from page 214:

entering RUN 4700. You will be asked to enter the number of respondents and to indicate where you want the EPA profiles printed, on paper or on screen. The program searches the tape for the first file, opens it, and

reads the recorded data. Then the program presents results, as described above. The multiple respondents are treated as additional replications (presentations of the stimuli) when mean values are calculated. The program does not analyze background

questions, but the variables are available in the data file for analysis by other statistical programs.

Options in the Attitudes Program

The mode of operation is set in line 130. Use TEACHING=-1 for the

IMAGINE IT...

NEW
NOW WITH
**DUAL HI-RES
GRAPHICS**



CAPTURE IT

Completely Redesigned. Now, the Grappler+.

The original Grappler was the first graphics interface to give you hi-res screen dumps from your keyboard. The new Grappler+ with *Dual Hi-Res Graphics* adds flexibility with a side-by-side printout of page 1 and page 2 graphics.

Interfacing the Grappler+ to a wide range of printers is easy as changing a dip switch. 4K of exclusive firmware makes the Grappler+ the most intelligent, full-featured Apple Printer Interface made. And, the Grappler+ is Apple III compatible.*

The imitations are many, so insist on the #1 Apple Graphics Interface on the market. Insist on the Grappler+. Available now at most Apple dealers.

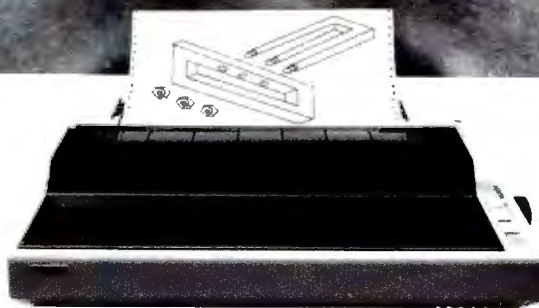

ACTUAL APPLE II PRINTOUT USING GRAPPLER+ AND EPSON MX100

With The **Grappler+** Printer Interface



The Grappler+ Features:

- Dual Hi-Res Graphics • Printer Selector Dip Switch • Apple III Compatible* • Graphics Screen Dump • Inverse Graphics • Emphasized Graphics • Double Size Picture • 90° Rotation • Center Graphics • Chart Recorder Mode • Block Graphics • Bell Control • Skip-over-perf • Left and Right Margins • Variable Line Length • Text Screen Dumps.

The Grappler+ works with Pascal and CPM.

The Grappler+ interfaces with the following printers:

- Anadex • Centronics • Datasouth • Epson** • IDS • NEC • C-Itoh • Okidata**

Orange Micro
Inc.

3150 E. La Palma, Suite G
Anaheim, California 92806
(714) 530-3620

CPM is a registered trademark of Digital Research, Inc. Apple II and Apple III are registered trade names of Apple Computer Inc.

© Orange Micro, Inc. 1982

Circle 287 on inquiry card.

*Requires additional software driver.
**Requires graphics upgrade.

teaching mode and TEACHING=0 for the field mode. (To get a hard copy of the profiles table while in the teaching mode, change line 170 to PAPER=-1 and keep the printer turned on throughout the session.)

The program obtains two complete sets of ratings from each respondent. You can change this to one set or to more than two by changing the value of NR in line 200. You also should change the word "twice" in the in-

structions if operating in the teaching mode (lines 2880 and 4550).

In the field mode, stimuli are entered using DATA statements, as illustrated at line 2450. Type the words without using the shift key because the program provides caps and lowercase. (To disable the capitalization feature, remove GOSUB 860 in line 2420.) You also must specify the number of stimuli as the value of LL in line 2340. No

definite limit on the number of stimuli exists in the field mode operation, but 50 would strain the patience of most respondents.

Background questions are entered via program lines, as illustrated in lines 4540-4550 (you wouldn't include the REM at the beginning of the lines). You'll have to experiment to get a neat format; be sure to test the altered program before using it. IB=IB+1 must precede each question. Also, you must set NB in line 2360 equal to the total number of background questions.

The data file written to tape begins by defining the number of stimuli (LL), the number of replications (NR), and the number of background questions (NB). Data are then written with the structure shown in table 1a. Each number or word in the file is followed by a "return"—CHR\$(13). EPA values are written as integers 1 to 39; to transform these to plus-minus scores, subtract 20 and divide by 4. As an example, suppose two respondents rated the stimuli "Making Love" and "Sociologists" with two replications and no background questions. The file might look like the left part of table 1b, where "\ " stands for CHR\$(13).

Scale adjectives used to define the dimensions are based on previous research and are appropriate for most applications. You can, however, change the adjectives by altering the DATA statements in lines 520-600. Each entry, enclosed in quotes, must be spaced out to ten characters. A dimension is defined by three pairs of elements which are either adjectives or blanks.

Example of a Field Application

Senator Jones is running against Mayor Smith for election to the state legislature. Jones decides to see how he's doing and has a worker take a PET to a shopping mall. The attitudes program is set up to operate in the field mode with one presentation (NR=1) of the stimuli "Candidate Alfred B. Jones" and "Candidate Thomas A. Smith." Thirty-five adults use the program. When the data tape is analyzed, mean profiles are as follows:

BYTE Clearance Sale

The installation of new microcomputer systems at BYTE allows us to sell some of our old equipment. The items for sale have been used for varying lengths of time, but are all in working order (except as noted). All units are sold as is. Prices are FOB Peterborough, New Hampshire.

Three high-performance word-processing subsystems for use with a microcomputer, each consisting of a:

Scion Screensplitter memory-mapped S-100-bus video-display board

Scion parallel-port keyboard

Scion Wordsmith text-editing software

Ball Corporation green-phosphor video monitor

The units are all in excellent condition.

Price: \$1200 each, \$3000 takes all three.

Shaffstall EDI7700 phototypesetter floppy-disk interface for use with Compugraphic Editwriter-series typesetting equipment, including standard ASCII translation software. (This device reads and writes phototypesetter disks with textual data transmitted or received through a serial RS-232C link.) Excellent condition.

Price: \$8500.

Pensee Pascal Microengine computer system, including UCSD Pascal version 3.07, 16-bit microprocessor, two Shugart 800R single-density 8-inch floppy-disk drives, and two RS-232C serial ports. Good condition.

Price: \$2000.

Teletype Corporation ASR33 teletypewriter with integral paper-tape reader and punch; uses 20-milliamp current-loop interface. Fair condition.

Price: \$100.

For more information, contact Jon Swanson at BYTE Publications Inc., 70 Main St., Peterborough, NH 03458.

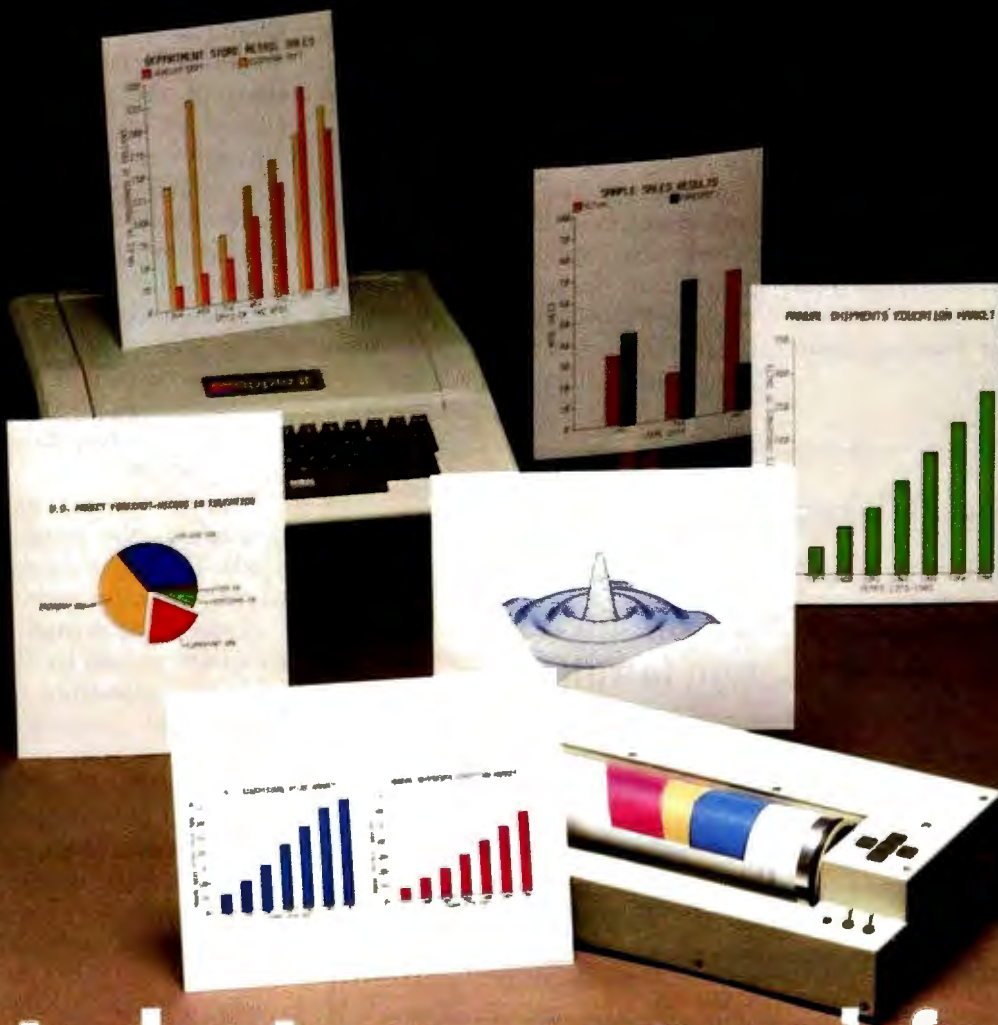

How to chart your company's fortune without spending one

It's a fact. A single chart or graph can tell you instantly what it takes hours to interpret from printouts or other raw data.

Now, with the Strobe 100 Graphics Plotter and Software package, you can create superb hardcopy graphics directly from your computer. And you can do it for an investment of only \$995.

The Strobe System transforms complex data into dynamic, colorful visuals with a few simple commands from your computer. Charts and transparencies that once took hours to produce are plotted within minutes. Information can be presented as bar charts, pie charts, curves or isometrics in a variety of colors. And with a resolution of 500 points per inch, the Strobe 100 matches or surpasses the quality of plotters costing thousands of dollars more.



You can also save and modify your graphics through Strobe's menu-driven programs. A broad selection of software—including a VisiCalc*-compatible program—is now available.

When the Strobe Graphics System is interfaced to your computer, an 8-1/2 x 11 inch sheet of paper can speak anyone's language—visually. Visit your local dealer and learn

how to start charting your fortunes today. Because a perspective on the present can also be your window on the future.



Strobe Inc.
897-5A Independence Avenue
Mountain View, CA 94043
Telephone 415/969-5130

The Strobe Graphics System

Seeing is believing

Circle 365 on Inquiry card.

*VisiCalc is a trademark of VisiCorp.

Jones 3.0 1.0 1.0
Smith 2.1 3.2 0.5

People usually vote for the candidate seen as the most good and powerful. Jones is fine on goodness, but he needs to improve the image of his potency by stressing his military record, political victories, and religious faith. Smith, if he had the results, would see that he should work on his perceived goodness by joking, kissing babies, and shaking hands cheerfully.

Program Notes

The program is constructed for 40-column Commodore machines. Since it is written in BASIC, the program could be adapted for other computers.

Special symbols used in the listing are defined in table 2. Listing 2 shows all variables and the lines at which they occur. Leave out remarks when entering the program unless you have a 32K machine; documentation more than doubles the program's size.

Contrary to the company's claims, Commodore BASIC is not the same on all machines, and different versions of the program have to be created for old and new ROMs. The difficulty: capital and lowercase letters reverse between old and new ROM sets. The program's PEEKs and POKEs have to be adjusted for different ROM sets, as indicated in remarks preceding the relevant lines.

The overall structure of the program is shown in the executive routine, lines 220-360, and the routine to analyze data on tape is in lines 4690-4950.

Timing loops are scattered throughout the program (e.g., line 4130). These give the respondent time to read messages and instructions.

A special input routine with a shaded cursor is used by the program to prevent respondents from breaking out of the program by pressing RETURN without prior keystrokes (lines 690-830). The STOP key is disabled most of the time (line 3760) but can be restored to normal functioning during the input routine (in case you wish to break for programming purposes) by pressing SPACE, then RETURN.

The routine in lines 850-1000 capitalizes the first letter in a string as well as letters appearing after spaces; it turns all other letters into lowercase.

Lines 1020-1270 contain the routine for drawing the graphic rating scale, which prints adverbial anchors vertically below the scale. The choice and positioning of adverbs along the scale is based on previous research. The routine for putting adjectives on the scale (lines 1290-1420) overwrites the adjectives there previously. When fewer than three pairs of adjectives are being displayed, blank elements are used to erase previous lines.

Stimulus presentation (lines 1440-1590) first involves erasing the old stimulus. A new stimulus is then chosen as follows. A stimulus number is generated randomly; if it has already been rated on this round, another stimulus number is selected randomly. The process is repeated until an unrated stimulus is found. If this does not occur within 2000 tries,

Whitesmiths, Ltd.
is now shipping Pascal Compilers
for 10 (count 'em ten) different
operating system families:

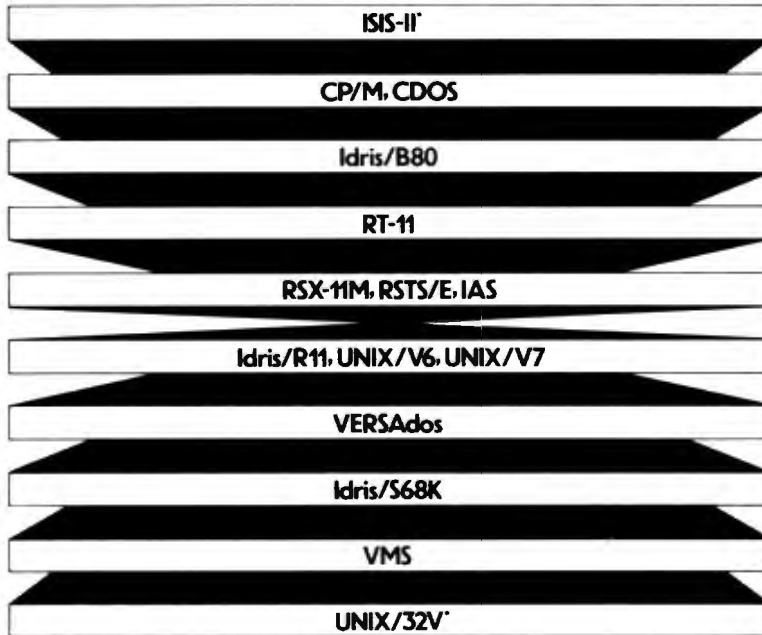

*Available in source form only.

Idris is a trademark of Whitesmiths, Ltd. UNIX is a trademark of Bell Laboratories CP/M is a trademark of Digital Research RSX-11M, RSTS/E, RT-11, LSI-11, VAX, and VMS are trademarks of Digital Equipment Corporation VERSAdos is a trademark of Motorola Inc.

All implementations support the full ISO Pascal (Level 0).
All pass the Tasmanian Validation Suite with flying colors.

You can partition your Pascal program into separately maintainable files. You can write library functions to add to the extensive set we give you. And you can mix in modules written in other languages, like assembler or C.

In fact, a C Compiler comes with every Pascal Compiler we sell. Prices start at \$950.00. Write or call.

Distributors: Australia, Fawcay Pty Ltd. P.O.B 224 Hurstville NSW 2220 570-6100
Japan, Advance Data Controls Corp. Chiyoda-ku, Tokyo 03263-0383
United Kingdom, Real Time Systems, Newcastle upon Tyne 0632 733131

Whitesmiths, Ltd.

Parkway Towers, 'B', 485 US Route 1 So., Iselin, New Jersey 08830 (201) 750-9000 Telex: 645592

More Apple II owners choose Hayes Micromodem II than any other modem in the world.

Compare these features before you buy.

You should. It's your money. Thousands of Apple II owners have already compared, considered, and now they are communicating — with Micromodem II. The best modem for your Apple II. The most modem for your money!

A complete data communication system for the Apple II. The Micromodem II is not "base priced" plus necessary "options." It's a complete, high-performance system, designed specifically for your Apple II and ready immediately to put you in communication with all of North America.

Unexcelled receive sensitivity level. Receive sensitivity levels determine the range of error in data transmission.

Micromodem II's excellent receive sensitivity level promises you clearer, more accurate transmission.

Auto-dial and answer features built in. Automatically dials the telephone,

answers the telephone, receives and transmits and hangs up the telephone — completely unattended. You can take advantage of low evening and week-end telephone line rates.

Operation can be full or half-duplex. And with user selectable transmission rates of 110 or 300 bps. FCC approved and completely Bell 103 compatible.

Quick and easy installation. The Micromodem II plugs directly into the Apple II, eliminating the need for a serial interface card. And the Microcoupler™ (included) connects the Apple II directly to a standard RJ11 modular telephone jack, eliminating the losses and distortions associated with acoustic couplers.



Plus a wide variety of software, available right now! Because of our position in the industry, numerous sources have developed software specifically for the Micromodem II. The versatility of these prepared programs gives you a distinct advantage as an Apple II owner. Available in computer stores nationwide.

So if you're ready to communicate with other computers... or to access large time-sharing systems like THE SOURCE™, AMERICA'S INFORMATION UTILITY™, then you're ready for Micromodem II. Come on. Compare. Consider. And you'll discover the time is ripe to join the thousands of happy Apple II owners who are communicating with Micromodem II's complete system capability.

Available at computer stores all across America — call or write for the

location nearest you. And don't settle for anything less than Hayes.



Hayes

Hayes Microcomputer Products, Inc.
5835 Peachtree Corners East,
Norcross, Georgia 30092 (404)449-8791

**Your Apple II[®]
just isn't the same without a
Hayes Micromodem II.™**

Listing 2: The variables in the attitude-measurement program and the lines on which each variable occurs.

LIST OF VARIABLES IN PROGRAM: "ATTITUDES"

```

A      750 750 790 1670 1680 1720 1790 1790 1860 1870 3120 3140 3160 3710
3710
A$     770 790 880 890 950 990 1350 1370 1390 1390 1540 1560 1580 1670 1680
1740 2420 2420 2550 2720 3140 3160 3160 3180 3180 3190 3590 3590 3610
3680 3680 3830 3900 3990 3990 3990 4000 4070 4070 4090
AJ$( ) 390 500 1370 1390 1390
AV$( ) 390 450 1140 1200
B$     890 930 950 950 970 1350 1370 1390
BA%( ) 2280 2280 4580 4580 4850
BB$( ) 390 410 410 420 420 430 430 1140 1200 1390 1460 1580 1630 2230 2240
2250 3180
C$     860 950 950 970 970 990
CU$    640 1030 1630 2920 3380 3470 3640 3640 3800 3980
DA%( ) 390
DI     860 950 1390 1390 2070 2130 4180
DM$( ) 390 620 620 620 2970 2970 2970 3340 3420 3650 3650
H      4780 4820 4860
HA     3280 3420 3570 3710 3710 3710
I      410 410 450 450 450 490 500 510 660 1050 1050 1070 1140 1200 1230
1240 1370 1390 1390 1840 1860 1870 1890 1910 1910 2090 2210 2210 2420
2420 2420 2690 2700 2720 2730 2790 2790 2850 2860 2860 3020 3040 3040
3040 3060 3060 3060 3100 3100 3100 3120 3220
3300 3320 3360 3360 3400 3400 3450 3450 3450 3480 3480 3480 3500
3540 3570 3590 3590 3590 3620 3850 3850 3850 4130 4130 4180 4220 4220
4360 4360 4390 4390 4430 4430 4580 4580 4580 4580 4600 4600 4600 4610
4610 4800 4820 4830 4840 4850 4860 4870 4880
4890
I1     4720 4730 4790 4820
I2     4710 4730 4780
IB     4580 4720 4840
J      490 500 510 1100 1120 1140 1150 1180 1190 1200 1210 1330 1370 1390
1390 1400 2850 2860 2860 3080 3100 3100 3100 3120 3200 3310 3310 3540
3540 3570 3570 4600 4600 4600 4810 4820 4830
    
```

Listing 2 continued on page 244

Expand your IBM PC...

256K IBM PC RAM EXPANSION BOARD

Model No. ADS 8001
with parity upgraded
at 64K intervals

SUGGESTED LIST PRICE

- W/64K RAM \$330.00
- W/128K RAM 570.00
- W/192K RAM 690.00
- W/256K RAM 870.00

Distributor and dealer inquiries welcome

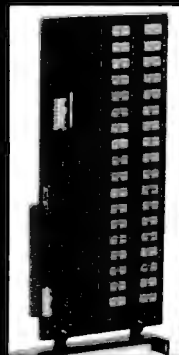

ADS 8001 DOT MATRIX PRINTER

PRINT FEATURES

- Print Speed: 120 CPS
- Characters: 8 sizes, 5 different alphabets, upper/lower case descenders
- Print Width: 8 in. max., Form Width: 4.5 in. to 10 in.
- Print Mode: 9x9 exceptional quality with proportional spacing
- Graphics: 144x144 dots/in. square and block graphic in ROMs
- Print Head: 9 pins, heavy duty designed with air-cooled fins
- Number of Columns: 136 max.
- Print Direction: Bidirectional logic seeking
- Form: Folded/Single sheet
- Form Feed: Tractor and friction, bidirectional
- Number of Copies: Original plus 3

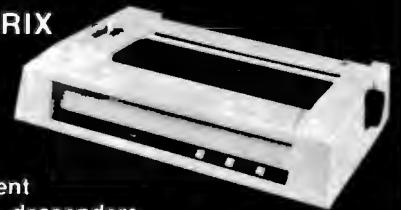

ADS ANTEX DATA SYSTEMS
A Division of International Antex, Inc.
2630 California Street, Mountain View, California 94040
(415) 941-7914 TWX 910-373-8500 "INTERAX PTVY"

UL Listed



- 90 Day Warranty
- One Year Extended Warranty Available
- Local Dealer Service
- TRS -80 Compatible

\$2495 PUTS YOU IN BUSINESS

Introducing the MTI® BUSINESS Computer. We believe in offering you the best in complete, low cost computing.

MTI MOD III PLUS B/140. We have taken the basic MODEL III, expanded the memory to 48K and added our MTI double density, dual drive system. All MTI BUSINESS computers include 4 Mhz speed-up for remarkable fast processing, a RS-232 Interface, Anti-Glare screen and cooling unit.

LOW PRICE. MTI BUSINESS computers are priced from \$2495. As an added incentive, we will give you a business software package **FREE** with the purchase of a MOD III PLUS BUSINESS computer. The software package has a retail value of \$1588.00.

All of this for \$2495.

FREE SOFTWARE ACCOUNTING PACKAGE

- ACCOUNTS RECEIVABLE
- ACCOUNTS PAYABLE
- GENERAL LEDGER
- INVENTORY/SALES ANALYSIS
- PAYROLL
- INCLUDES AUDIO SELF-LEARNING CASSETTE
- GAMES
- EDUCATION SOFTWARE
- DOS PLUS 3.3

WORD PROCESSING

We are also offering a discount certificate entitling the purchaser to **NEW SCRIPT** by Pro Soft. With **NEW SCRIPT** you have complete word processing software.

OTHER MODELS AVAILABLE:

MOD III PLUS 240-B. Same as the MOD III-B/140 but has double storage capacity and dual headed 40 track drives.

MOD III PLUS 280-B. Has 1.5 Megabytes storage and 2 dual headed 80 track double density disk drives.

MOD III/WINCHESTER-B. Our largest business computer system. 8.2 megabytes of storage. Includes a 7.5 megabyte WINCHESTER hard disk and 80-track dual head disk head.

OPTIONS:

- * LETTER QUALITY PRINTER
- * WINCHESTER 64K CP/M

**OVER 100 AUTHORIZED DEALERS
CALL 800-227-3800 TOLL FREE
800-792-0990 in California Ask For ext. 264**



MICROCOMPUTER TECHNOLOGY INC.
3304 W. MACARTHUR, SANTA ANA, CA 92704
(714) 979-9923 • TWX 910-595-1902 MTISNA

Call or write for free brochure:
U.S. PRICES F.O.B. SANTA ANA
CALIFORNIA AND MAY VARY BY AREA.

CP/M is a registered trademark of Digital Research, Inc.
TRS-80* is a registered trademark of Tandy, Corp.
M.T.I. is a registered trademark of Microcomputer Technonology, Inc.

Listing 2 continued:

```

K      490 500 510 880 890 930 930 950 950 950 950 980 1120 1120 1140 1190
      1190 1200 1480 1490 1490 1500 1520 1520 1520 1530 1530 1560 1580 1980
      2160 2300 2850 2860 2860 3100 3100 3100 4600 4600 4600 4790 4820 4830
L      1480 1490 1520 1520 1540 2130 2160 2160 2160
LA     3280 3590 3650 3650 3710 3710
LI     290 320
TI     660
VA     3280 3340 3540 3710 3710
VL     1890 2130 4320
WD$( ) 1540 2400 2420 2640 2720 3040 3040 3040 3060 3060 3650 4770 4880
X      750 790
LL     290 1480 1520 1530 2340 2380 2400 2400 2420 2550 2560 2600 2610 2640
      2640 2690 2850 3020 3500 3850 4600 4720 4770 4770 4800 4870
MV$   1650 1660 1670 1680
N      2050 2090 2130 2140
NB     2360 2380
NM$   140 140 2170 2580 3900 3960 4320 4340 4560
NN     3860 3880 3880
NR     200 280 2380 2400 2640 2850 3100 3100 3120 3120 3540 3570 3590 4600
      4730 4770
PA     170 180 3000 3230 4740
Q%( ) 390 2000 2010 2020 2020 2030 2030 2030 2090 2130
R%( ) 1490 1520 2130 2160 2160 2160 2400 2640 2860 3100 3100 3100 3120
      3540 3570 3590 4600 4770 4820
T      280 320 1490 1520 2130 2160 2160 2160
TE     130 140 180 240 260 350 2850 2860 2870 4440 4580
    
```

the program searches through the stimuli sequentially, taking the first unrated stimulus it finds. Once

found, the stimulus is centered and highlighted at the top of the screen. (Highlighting can be removed by deleting the REVERSE character in line 1580.)

The routine for getting a respon-

dent's judgment (lines 1610-1940) prints a check mark at the center of the graphic rating scale and moves it left or right, depending on whether the respondent presses the < or > keys. Auto repetition is obtained by using a POKE that makes the PET act as if the key were released. The routine PEEKs at the screen to see if

```

Parameters LL, NR, NB
Respondents 1 to NN
Attitude data
  Replications 1 to NR
  Stimuli 1 to LL
  Dimensions E, P, A
Background data
  Frequency of 3 neither-ratings
  Optionally, answers for questions 1 to NB
List of stimuli 1 to LL
    
```

Table 1a: The structure of a data file written to tape by the attitude-measurement program shown in listing 1. LL defines the number of stimuli, NR the number of replications (the number of times the stimuli are presented to respondents), and NB the number of background questions. NN is the number of respondents. Respondents rate each stimulus in three dimensions for each replication. The program reports the frequency of rating a stimulus "neither" in all three dimensions, a sign that the respondent is repeatedly hitting RETURN without really reflecting on his or her attitudes.

```

                2 \ 2 \ 0 \
31 \ 35 \ 35 \ 20 \ 20 \ 21 \
33 \ 32 \ 34 \ 18 \ 22 \ 19 \
                0 \
38 \ 39 \ 33 \ 23 \ 27 \ 15 \
36 \ 36 \ 35 \ 20 \ 25 \ 13 \
                0 \
"Making Love" \
"Sociologists" \
    
```

Table 1b: A sample set of data from the attitude-measurement program. Organized according to the structure shown in table 1a, these data were gathered in response to two stimuli, presented to two respondents, and replicated twice. Respondents rated stimuli in each of three dimensions. There were no background questions and no triple "neither-ratings." The "\ " represents a carriage return [CHR\$(13)].

```

<S>      Cursor home
<s>      Clear screen
<Q>      Cursor down
<q>      Cursor up
<J>      Cursor right
<j>      Cursor left
<R>      Reverse on
<r>      Reverse off
A-Z      Lowercase letters
[A-Z]    Capitals
[ ]      Space
[.]     Check mark
[ ]     Cross
[ ]     Vertical line
[ @ ]   Horizontal line
[ & ]   Shaded square
    
```

Table 2: Definitions of the special symbols used in the attitude-measurement program shown in listing 1.

TCS MODEL III 48k 2 DISK



Fully assembled and tested systems that are software compatible and functionally identical to Radio Shack units sold at computer centers for \$hundreds more. Includes DOSPLUS 3.3.

- CONTROLLER BOARDS are high quality double sided epoxy boards with gold plated contacts.
- POWER SUPPLY is the finest switching type available.
- MOUNTING HARDWARE includes power and data cables.
- DISK DRIVES are Tandon, the same ones used by Radio Shack - 40 track, double density, 5 millisecond stepping rate.

The System comes with 180 day TCS limited warranty. **\$1795**

\$2095 MODEL III 48k 2 DRIVE SYSTEM with 720,000 bytes of storage

TCS uses 2 dual headed 40 track Tandon drives. You can convert your existing 40 track standard diskettes. This system includes Free DOSPLUS 3.4 (retail value \$149).

MODEL III DISK EXPANSION KITS

KIT 1 Controller, Power Supply & Mounting Hardware	\$379
KIT 2 Controller, Power Supply, Hardware, 1/40 track Tandon	\$577
KIT 3 Controller, Power Supply, Hardware 2/40 track Tandons, 32k memory (everything you need for 2 drive 48k upgrade)	\$799
KIT 3a Kit 3 but with 2/80 track drives (dual sided 40s)	\$999
KIT 4 Tandon 40 track disk drive (bare drive)	\$199
KIT 5 18k of high quality TCS memory	\$39
KIT 6 32k of high quality TCS memory	\$69
KIT 7 Disk Controller Board (supports 40/80 single/double sided drives)	\$249
KIT 8 Switching Power Supply for controller & 2 drives	\$119
KIT 9 Hardware & Cabling kit for above components	\$89

PRINTERS & ACCESSORIES

MATRIX PRINTERS

LINE PRINTER VII RS	\$325
NEC 8023A	\$495
C. ITOH 8510	\$495
OKIDATA 82A	\$499
OKIDATA 82A w/tractor	\$559
OKIDATA 83A	\$769
LINE PRINTER VIII RS	\$649
CENTRONICS 739parallel	\$599
CENTRONICS 739 serial	\$749
OKIDATA 84 / 200 cps	\$1295
LINE PRINTER VI RS	\$988
CENTRONICS 704	\$1559
ANADEx 9500/01 2k buf.	\$1295
TEXAS INST. 810 Basic	\$1595
LINE PRINTER V RS	\$1549
Centronics 352 / 200 cps	\$1795
Centronics 353 / dual mode, 200cps data proc., 50cps super letter quality	\$2495

LETTER QUALITY

Daisy Wheel / Spinwriters

C. ITOH F-10 / 40 cps	\$1595
DAISY WHEEL II RS	\$1695
DIABLO from	\$2350
QUME from	\$1850
NEC SPINWRITERS	\$CALL

LINE PRINTERS

CENTRONICS 6080/81 600 lines per minute	
6081 standard	\$6399
6080 quietized cabinet	\$7676

Epson

EPSON MX80	\$CALL
EPSON MX80 FT	\$CALL
EPSON MX100 FT	\$CALL

FREE Graphtrax!!!

EPSON ACCESSORIES

GRAPHTRAX 80 option (bit-image/italics)	\$79
CABLE Model I interface & Model III	\$35
\$25 if purchased with EPSON printer	
CABLE & INTERFACE to Model I keyboard	\$85
APPLE interface & cable	\$89
GRAPPLER Apple hi resolution graphics	\$CALL
IEEE interface & cable (CBM/Pet)	\$79
ATARI cable (must have 850 interface)	\$35
SERIAL RS232 2k buffered int card	\$149
RS COLOR computer to Epson card/cable	\$59

EPSON PACK II

Screen oriented bit image graphics generator for Model III. Create your own characters, symbols, etc. Includes documentation. **\$24.95** purchased with printer **\$34.95** when purchased separately **\$7.50** for update of Epson Pack I

Interfaces & cables available for most printers with any TRS80, Apple, Atari & most other computers. **\$\$\$CALL FOR PRICES!**

ALTOS COMPUTERS

TRS-80

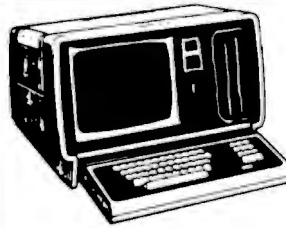

MODEL II 64k \$CALL

MODEL 16 1 DRIVE .. \$4499

MODEL 16 2 DRIVE .. \$5199

DT-1 DATA TERMINAL. \$629

Mod16 Memory Expansion \$CALL

COLOR COMPUTER

Original 90 day manufacturer's warranty

4k Level 1 \$308

16k Level 1 \$399

16k Extended Basic \$459

32k Extended Basic \$569

Color Disk.....\$479 Disk 1..\$349

MODEL III SYSTEMS

Original 90 day manufacturer's warranty

Model III 16k \$818

Model III 32k \$918

Model III 48k \$1018

Model III 48k 2Dr. RS232 \$2049

TCS Model III Systems have quality TCS memory and 180 day limited warranty. No warranty when you open computer or add internal components after you receive it.

TCS Model III 16k \$788

TCS Model III 32k \$818

TCS Model III 48k \$848

TCS version Color Computers uses original RS hardware and TCS memory. You get 180 day limited warranty on TCS Color Computer

16k Extended Basic \$439

32k Extended Basic \$499

32k Memory Upgrade \$79

Color/Epson int. & cable .. \$59

2k Buffer ColorGraph \$155

TANDON DRIVES

DEALERS! ASSEMBLERS! Quantity Purchases Invited!

Bare drives are available, or you can buy them with power supply, cabinet and cable, fully assembled and ready to plug in to your computer.

SINGLE OR DOUBLE CABINETS

40 track single sided single \$249	40 track single sided \$199
40 track single sided double \$489	80 track (dual sided 40 track) \$299
80 track (dual sided 40 track) single \$389	180 track (dual sided 80 track) \$449
80 track (dual sided 40 track) double \$599	8 inch Slimline single/double sided \$CALL
160 track (dual sided 80 track) single \$499	Winchester Hard Drives, 5-30 meg. \$CALL
160 track (dual sided 80 track) double \$949	

BARE DRIVES ONLY

Heavy gauge CABINET with POWER SUPPLY. External gold connector allows instant hook/detach from drive cable.

WE WILL NOT

BE UNDERSOLD!

CORVUS HARD DISKS CALL FOR PRICES \$\$\$\$

Add 5, 10 or 20 megabytes of storage to your TRS80, Apple, Atari, Heath, Zenith, Intertec, IBM, S-100 and many others. One or several computers can share a hard disk. Get simultaneous access to data for multiple users. Available NOW at SUPER SAVINGS!

DEALERS...You can buy CORVUS from us for less. Call & SAVE.

CUSTOM SOFTWARE FROM TCS

Completely integrated **BINARY SEARCH TREE** programs now available. This series of programs fully implements the B-TREE structures including INSERTION, DELETION, EDITING & TRAVERSAL. No more sorting or long data file searches and yet files can be larger than memory. Duplicate keys are fully supported. Files can be retrieved in sorted order via B-TREE Traversal. Each of the programs come with fully commented source code so that you can use the modules in your own programming. A Screen oriented Input routine is also included in each module. The following B-TREE programs are now available and each includes all of the mentioned modules and full documentation:

B-TREE Library (organize your home library keyed by author).....	\$36.95
B-TREE Video (organize your video cassette library, prints labels, etc.).....	\$36.95
B-TREE Mailing List (keyed by name or zip, label printing, etc.).....	\$49.95



If you buy somewhere else, you'll probably pay too much!

For fast, efficient service. Heart of we can air freight from Dallas

TEXAS COMPUTER SYSTEMS

P.O. Box 1327 Arlington, Texas 76004-1327

★ Toll Free Number 800 433-5184

Texas Residents 817 274-5625

- Prices subject to change at any time
- No Tax out-of-state. Texans add 5%
- Many items shipped FREE. Call for quote.

CALL FOR OUR

FREE CATALOG!!

the check is at the extreme left or right and stops movement if so. When the respondent presses RETURN, the program PEEKs across the screen until it finds the check, then records its position and erases the mark.

Lines 1960-2300 present the EPA scales and store numerical judgments in arrays. Order of presentation is randomized by choosing the first scale randomly, the second randomly as long as it is not equal to the first choice, and the third as the scale that

hasn't been done yet. Orientation of the scale is determined by a random number that defines which adjectives are printed on the left. The value returned by the judgment routine is stored in a data array, taking into account the various randomizations. This routine also monitors answers to make sure the respondent is not just hitting RETURN without moving the check.

The section that displays results (lines 2830-3720) saves data on tape

and returns if operating in the field mode. Results appear when in the teaching mode and when the routine is called from the tape-read sub-program. The instructions (lines 3740-4500) have been described in detail. You can, of course, change them to suit yourself.

Background questions, if any, are presented in the closing routine. The routine then saves the answers on tape, clears the data matrix, and returns.

The routine for analyzing recorded data (lines 4690-4950) begins by opening the tape file. The number of respondents is input manually, but other parameters of the analysis are read off the tape. Signal if you want the mean values printed on paper. A printer file is opened for device 4 (even if you signal that you don't want hard copy). Dimensions are set for arrays. The number of replications is calculated as the original number of replications times the number of respondents. Data are read, and results are presented using the usual Results subroutine.

Conclusion

Now that you have at your disposal a sophisticated tool for measuring attitudes, you may find more applications than you thought possible. Forecasting programs for microcomputers have given small businesses financial-planning tools once reserved for giant corporations. Attitude-assessment programs can provide similar help in devising marketing strategies, product lines, and service goals. You no longer have to stand on a giant's shoulders to enjoy a better view. ■

Further Readings

1. Ajzen, I. and M. Fishbein. *Understanding Attitudes and Predicting Social Behavior*. Prentice-Hall, 1980.
2. Heise, D. *Understanding Events: Affect and the Construction of Social Action*. Cambridge University Press, 1979.
3. Osgood, C., W. May, and M. Miron. *Cross-Cultural Universals of Affective Meaning*. University of Illinois Press, 1975.
4. Snider, J. and C. Osgood. *Semantic Differential Technique: A Sourcebook*. Aldine, 1969.



The DS120 Terminal Controller makes your LA36 perform like a DECwriter® III.

The Datasouth DS120 gives your DECwriter® II the high speed printing and versatile performance features of the DECwriter® III at only a fraction of the cost. The DS120 is a plug compatible replacement for your LA36 logic board which can be installed in minutes. Standard features include:

- 165 cps bidirectional printing
- Horizontal & Vertical Tabs
- Page Length Selection
- 110-4800 baud operation
- 1000 character print buffer
- X-on, X-off protocol
- Self Test
- RS232 interface
- 20 mA Current Loop interface
- Top of Form
- Adjustable Margins
- Double wide characters
- Parity selection
- Optional APL character set

Over 5,000 DS120 units are now being used by customers ranging from the Fortune 500 to personal computing enthusiasts. In numerous installations, entire networks of terminals have been upgraded to take advantage of today's higher speed data communications services. LSI microprocessor electronics and strict quality control ensure dependable performance for years to come. When service is required, we will respond promptly and effectively. Best of all, we can deliver immediately through our nationwide network of distributors. Just give us a call for all the details.

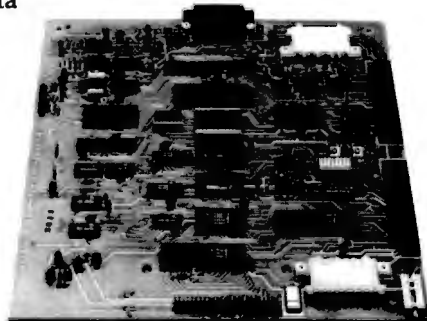

datasouth computer corporation

4740 Dwight Evans Road • Charlotte, North Carolina 28210 • 704/523-8500

DAYSTAR

MAKES YOUR XEROX SHINE



Daystar enables your Xerox to deliver a shining performance by increasing its speed and data capacity. Through the use of an intelligent controller using an I/O PORTS and on-board data buffer, your microcomputer can perform up to 9 times faster.

The versatility in storage size that this subsystem provides, allows your Xerox to adjust to your growing needs. This increased storage capacity is made available with 6.4 megs or 12.8 megs of unformatted storage in a 5 1/4 inch Winchester. A 1 megabyte floppy back-up is also available. Each controller will handle up to 4 drives to expand your Xerox as you need it.

You can expect Daystar to deliver versatility and performance you can trust, at a price you can afford to pay.

Prices:

\$1900.00 for 6.4 megs.
\$2200.00 for 12.8 megs.

Dealer inquiries invited.

This Daystar unit is available with interfaces for:

- Xerox¹
- NEC 8000²
- Apple II³
- Commodore⁴
- IBM P.C.⁵
- S-100
- VIC 20⁴
- TRS-80 Model II⁶
- Heath/Zenith 89[™]

and soon:

- Apple III³
- TRS-80 Model III⁶

asap
computer
products, inc.

1198 E. Willow Street, Signal Hill, CA 90806
(800) 421-7701 • (213) 595-6431 • (714) 891-2663

ASAP COMPUTER PRODUCTS LTD.

116 Viceroy Road
D-12 Concord, Toronto, Ontario
L4K1A9 Canada
(800) 268-1996 • (416) 738-0500



DAYSTAR
TECHNOLOGY INC.
A MICROBYTE COMPANY

Microcomputers in Cultural Anthropology

APL Programs for Qualitative Analysis

Microcomputers aid in the study of Navajo and other cultures.

Oswald Werner
Professor of Anthropology and Linguistics
Northwestern University
Evanston, IL 60201

Several years ago, a fire at the Center for Advanced Study in the Behavioral Sciences at Stanford University destroyed the life's work of a well-known anthropologist. Thousands of pages of field notes were lost to flames and the water used to put them out. Loss of data is a recurring nightmare for most of my colleagues. Equally important is the question of how to manage all this data. A few professional cultural anthropologists, like myself, believe microcomputers can help.

In this article, I'll talk about the management of qualitative data, mainly texts. A text is any thought or idea reduced to writing.

The Nature of Data in Cultural Anthropology

Anthropologists' data comes in different forms. Numerical data is relatively easy to manage. Statistics is a way of summarizing large bodies of numerical information. The major crunch cultural anthropologists face is the tremendously rapid growth of texts or qualitative data, one of the hallmarks of our profession.

For example, a simple 45-minute interview results in texts of 5000-7000 words. It does not take many interviews to collect a database of several hundred thousand words. Anne Chambers and Ralph Bolton, two cultural anthropologists from California, estimate that the databases of anthropologists returning from field trips of one year to 18 months range from several hundred pages to a maximum of about 8000 pages (2 million words). The average is about 1000 pages, or 500,000 words. For those of us who teach anthropologists to work in the field, the low end of this figure is shocking. A hypothetical database of 50,000 words (roughly 200 double-spaced pages) is relatively easy to manage. The thorough field worker's problems increase as the data grows beyond a few hundred pages into thousands.

The size of the database obviously depends on the problem chosen as the focus of the study. For example, a linguistic problem, such as the grammatical description of an unknown but exotic language, may require a database closer to the lower limit. On the other hand, the description of the

culture of a small tribe, a peasant village, a city neighborhood, a patient-care unit in a hospital, or a small industrial company, requires extensive interviews and other documents. This problem of volume is typical of the branch of cultural anthropology called ethnography (the Greek source means "the description of a folk").

Ethnographers, as the anthropologists (and some sociologists) doing ethnographies are called, are comparable to systems engineers. These engineers try to determine, for example, the paper flow in a bureaucracy and then try to make it more efficient. Describing the flow of paper through an organization is an ethnographic task. You can think of ethnographers as systems engineers who describe how groups of people function. The "flows" that ethnographers study involve such items as women (wives), goods (gifts), ideas (religion), etc.

Until recently, ethnographers rarely wanted to improve efficiency. Today, many anthropologists/ethnographers work with agricultural innovations in the Third World, health-care utilization and program evalua-

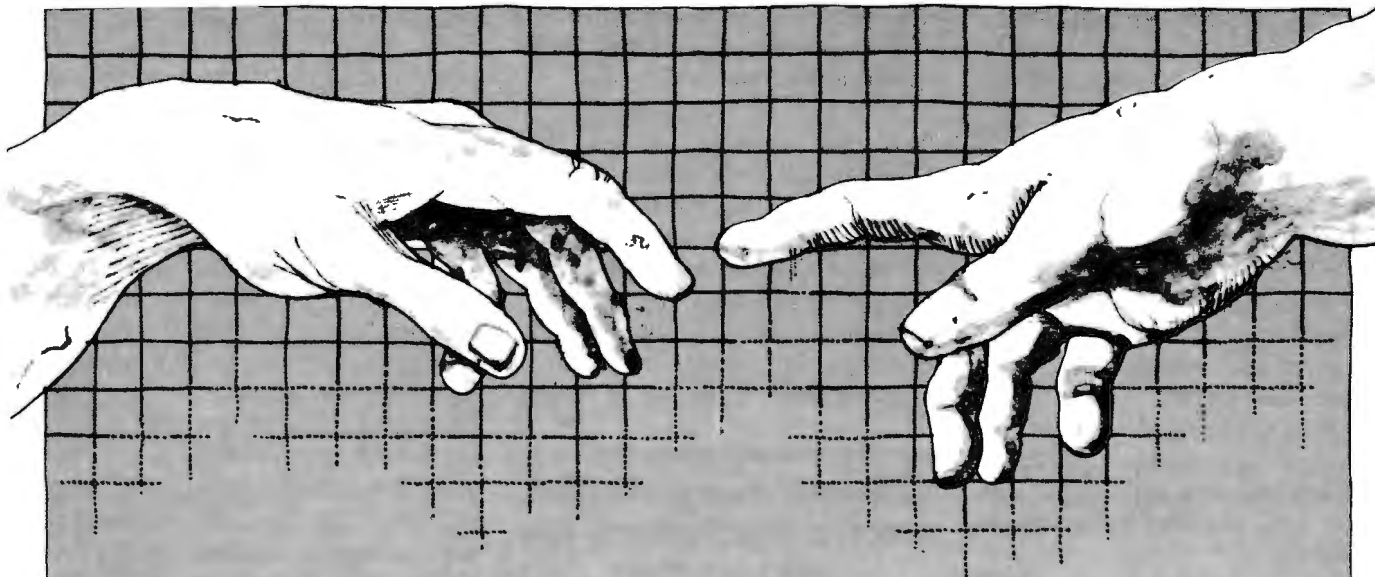

DATAFLEX™

SOFTWARE FOR CREATORS

Bring your CP/M* software applications to life with DataFlex. From menus to multi-key ISAM, DataFlex has the features and power you need to create complete turn-key software applications in a RELATIONAL data base environment.

Compare...what else gives you: up to 125 data files with 4 indexes each, fast on-line multi-key ISAM file maintenance, a multi-file report generator, on-line multi-file transaction processing, an easy to use Query, even a "soft" menu to replace the CP/M command mode. All of this using DataFlex's configuration utilities, and NO PROGRAM CODE!

Is it easy to use? You can type in a screen format "image" of a file with your text editor. Then, DataFlex's AUTODEF utility will create the file definition from the screen image...in about five seconds!

DataFlex will handle your multi-user requirements too! It runs under Software 2000's TurboDos Network O/S with data protection to the field level. That means multiple users in the same record at the same time!

If the 16 bit world is your domain, an 8086 version of DataFlex

will be available second quarter '82. And, you can develop now on your 8080/Z-80 system, and transport completed applications to the 8086.

If you need applications now, Data Access has a Library of existing DataFlex applications developed by other creators. They're ready to go at prices that will get you going. The DataFlex Library has Order Entry/Inventory, Accounting, Pharmacy, and Legal Billing, with more being added all the time. For highly specialized requirements, DataFlex's PASCAL Library is available to application developers.

DataFlex can change the way you do business. And, at \$750 it's the best software value in the business. A demo package, which limits file sizes internally, is only \$100 including the manual.

Get the full system, or get the demo, but get your hands on DataFlex.

It's software for creators.

DATAACCESS[®]
CORPORATION

4221 Ponce De Leon Blvd.,
Coral Gables, FL 33146
(305) 446-0669

"Dealer, Systems House and OEM inquiries invited."

*CP/M is a registered trademark of Digital Research, Pacific Grove, CA.

tion, or in other areas where their work benefits humanity. The initial aspect of applied anthropological work, before concrete recommendations are offered, is always ethnographic, or descriptive.

Ethnographic field work is viewed as qualitative social science. Surveys with questionnaires are quantitative social science. Questionnaires are usually short—100 questions are considered the upper limit. They can be administered to 1000 people or more. Ethnographies, based on intensive interviews, are usually limited to no more than 100 people. It is clear that these two approaches, qualitative (deep but narrow) and quantitative (broad but shallow), complement each other.

Texts are important for other reasons. Quantitative studies of a society must be viewed as literally looking in from the outside. The power of the qualitative approach is that it tries to capture the internal view: how the "natives" themselves see their life and how they talk about it. This approach is looking from the inside out.

The texts that ethnographers produce while working in the field are collected as field notes. Technically, field notes contain two types of data or texts:

•Records of the ethnographer's observations. These are observations of others, as well as of the ethnographer. Self-observation is important

since the ethnographer's self is part of the instrumentation.

•The records of verbatim statements by the people being studied about aspects of their life.

There are, therefore, at least two databases that must be managed. In addition, since the self-observations must be related to what the natives say, there must be cross-referencing between the two texts.

All this leads us to the inevitable conclusion that the state of the art of gathering large databases in ethnog-

Without exaggeration, Electric Blackboard is a product that ethnographers have been waiting for.

raphy is chaotic at best. We do not teach undergraduates or graduates how to organize databases. This lack of knowledge about ethnographic data management is reflected in the time it takes ethnographers to find their way through the maze of their field notes. It may take years before a viable manuscript is produced. The arrival of microcomputers has alerted us to the problem, as well as to possible solutions.

When I wrote my dissertation at Indiana University on a pidginized form of the Navajo language called Trader

Navajo, spoken by Anglo traders to their Navajo customers, all I did for some time was collect the data. Some of it was on cards, some in notebooks. I did not start to organize the data until after I had collected all the material. In all, I spent six months organizing the data and only six weeks actually writing the dissertation. In the process, I learned the value of a well-organized database.

Minimally, an ethnographer needs an effective indexing system. Since it is often not known in advance what topics will become salient for the final ethnography, the index must be flexible enough to allow for searches that were not planned in advance. In a relational database management system, such as the one described by Joel Neely and Steve Stewart (BYTE, November 1981, page 48), the designer must anticipate most of the queries that may be directed at the data. In addition, data types (tables) must be well defined. The ethnographer, on the other hand, is transported by a culture on a journey whose end cannot be anticipated. Doing an ethnography is a continuous process of discovery. Our data types are rarely well defined. Our information-retrieval techniques must reflect the need for extreme flexibility. Often, we use keyword indexes.

Shifting to Microcomputers

For years, we used a cumbersome system for relaying data between Monument Valley, Arizona, and the

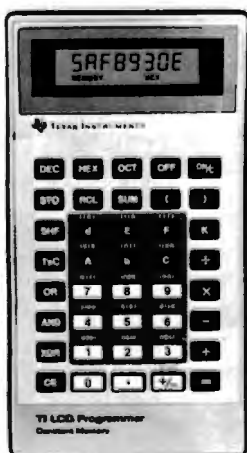

TEXAS INSTRUMENTS
INCORPORATED

New! TI LCD Programmer.

Hexadecimal and Octal Calculator/Converter.

The brand new tilt-top TI LCD Programmer can save you hours of work. It was designed specifically for the problems you do, and has features that make it ideally suited for applications in computer programming, debugging, repair and digital logic design.

- Performs arithmetic in any of three number bases — OCT, DEC, HEX.
- Integer, two's complement arithmetic in OCT and HEX.
- One's complement capability in OCT and HEX.
- Converts numbers between OCT, DEC and HEX.
- Fifteen sets of parentheses available at each of four processing levels.
- Logical functions AND, OR, EXCLUSIVE OR and SHIFT operate bit by bit on OCT or HEX numbers.

Unisource Electronics has committed to buy TI's initial production of this unique product. Availability is limited! Order now.

15-Day Free Trial.

The best way to evaluate the TI LCD Programmer is to try it yourself — on the job — for 15 days. If you're not 100% satisfied, simply return it for a full refund. Order now by calling toll-free:

1-800-858-4580

In Texas call 1-806-745-8835

Lines open 8 am to 8 pm CST



Just give us your name, shipping address and Visa or MasterCard number and we will charge the tax deductible* \$75.00 purchase price, plus \$2.00 shipping and handling (Texas residents also add 5% sales tax) to your account. Or send your check or money order to:

Unisource Electronics, Inc.
P.O. Box 64240 • Lubbock, Tx. 79464

* When used for business.

Get Omni quality for as little as \$1.99...

even if all you want is a 10 pack.

Call toll-free for great savings on Omni's complete line of 5 1/4" premium disks. Each is certified error-free at a minimum of twice the error threshold of your system. Each is rated for more than 12 million passes without disk-related errors or significant wear. And each is precision fabricated to exceed all ANSI specifications with such standard features as reinforced hub rings and Tyvec sleeves. Get same day shipment and an unconditional, no hassle money-back guarantee.

ARCHIVE

152 Boston Turnpike
Shrewsbury, MA 01545
(800) 343-0314; In Mass:
(617) 756-2960



Call toll free
(800) 343-0314
In Mass: (617) 756-2960

Call if you're not sure which disk is compatible with your system. Call for prices on 96 tpi and special formats. We offer an unconditional money-back warranty. We're here to help.

Be sure to indicate system name and model # at right.

Circle 31 on Inquiry card.

# of 10 Packs	5 1/4" Disks	Price Per 10 Pack	Total Price
_____	Single side/single density	\$19.90	\$ _____
_____	Single side/double density	\$23.90	\$ _____
_____	Double side/double density	\$39.90	\$ _____
_____	Flip/Floppy reversible Double side/double density	\$39.90	\$ _____
_____	Protective plastic library case (in lieu of soft storage box)	\$ 2.99	\$ _____
	Shipping and handling		\$ 1.50
	5% sales tax (Mass. only)		\$ _____
	Total		\$ _____

Check
 COD

Master Card
 VISA

Card # _____ Exp. _____

System and model # _____

Name _____

Address _____

Tel. _____

Vogelback Computing Center at Northwestern University. Later, we used outmoded word-processing equipment. We had to abandon that approach, however, when the supplier canceled its WATS line and left

grams, called functions, allows the programmer to solve one small problem at a time, debug it, and have it ready for insertion into larger programs.

I found that I could easily express

does have many symbols, but anyone can start programming in APL with a small subset of APL symbols and gradually enlarge the arsenal of elegant operations.

APL purists often complain about

Circle 444 on inquiry card.

WIRESMASTER A COMPILER FOR HARDWARE

Whip your wire wrap and PC layout problems with WIRESMASTER

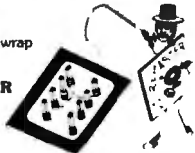

- **WIRESMASTER** is a software tool to aid in the design, layout, and construction of electronic hardware. Although intended primarily for wire wrap, it is also highly useful in the layout, error checking, and trouble-shooting of PC boards.

- Inputs are easily derived directly from the schematic diagram and fed to **WIRESMASTER** in a CP/M* text file. Outputs include a **network map** that graphically shows all pins and wires (no plotter required), a **wire list** sorted by lengths and levels, a **parts list**, signal and pin **cross-references**, and **wrap count** and **continuity** checklists which ensure a perfect wiring job.

- **WIRESMASTER** checks for syntax errors, wires that go nowhere, and duplicated pins. Network lengths are **minimized**, and wire lengths are calculated and sorted in descending order so that the shorter wires on top hold down the longer wires beneath for a neat wiring job.

- The resulting information is then used for wiring, PC board layouts, error-checking, component stuffing, and system debugging. This makes a complete and easily updated documentation package. Although it runs on small computers, **WIRESMASTER** can handle large projects.

- **WIRESMASTER** locates parts with a precision of .001 inch, keeps track of your schematic page numbers and includes them in the outputs, and can handle twisted pair and shielded wire.

- **CHANGEMASTER**, a companion program, eliminates the confusion and loss of control caused by changes to a board during debugging and modification. It outputs a map of all networks which have been added, deleted, or modified, and automatically generates REMOVE and ADD lists so an old board can easily be brought into exact conformance with the latest design.

- **WIRESMASTER** runs on any Z80® CP/M system of 47K or larger, including S-100 systems, TRS-80® Model II and Apple II® with SoftCard®. The diskette also includes a SORT utility, a pagination and multi-column printing program, and FIX, a program which finds all bad spots on a disk, tells you which files they are in, places the bad sectors in a single file, and recovers erased files.

- Post-processors for numerically controlled wire wrap machines such as the Gardner Denver SP-29 and others are available by special arrangement.

WIRESMASTER plus CHANGEMASTER ... \$200
Manual only \$ 20
Update to current version \$ 25

Discount to computer club members

Versions for 8080/8085, CPM 86, CDOS, and IBM PC available soon.

AFTERTHOUGHT ENGINEERING

Listing 1: ALFORDER, an APL/V80 program that indexes words. The program takes text as input and produces an output of keywords in a context of 120 characters each. Figure 2 shows a block diagram of ALFORDER.

```

)WSID
ALFORDER

)A
26095

)FNS
ALFORDER DELHYP DISPLAY INORDER LOCATE MATSRT PRINT RDI VECMAT

VALFORDER[[]]V
VALFORDER TXT;LOC
[10] 2pLF
[20]  * DELETE TRAILING AND MULTIPLE SPACES. CATENATE SPACE AT
[30]  * BEGINNING OF TEXT TO ENSURE 1ST SPACE FOR <LOCATE>.
[40]  TXT+RDY' '.TXT
[50]  * COMPUTE BEGINNING POSITIONS OF WORDS
[60]  LOC+LOCATE TXT
[70]  * SORT LOCATIONS BASED ON MATRIPIED WORD LIST
[80]  LOC+LOC[MATSRT' ' VECMAT 1+TXT]
[90]  * PRINT RESULTS
[100] LOC PRINT TXT
      V

VRDY[[]]V
VR+RDY TXT
[10]  * PREPARE TEXT BY ELIMINATING MULTIPLE BLANKS
[20]  R+TXT=' '
[30]  R+(Rv1+R,0)/TXT
      V

VLOCATE[[]]V
VR+LOCATE TXT
[10]  * RETURNS LOCATIONS OF WORD BEGINNINGS
[20]  R+1+(TXTε' ')/1pTXT
      V

VVECMAT[[]]V
VR+DEL VECMAT V;A;B;CMP
[10]  *CONVERTS CHARACTER STRING TO MATRIX BASED ON DELIMITER
[20]  R+0 0p' '
[30]  +(1=B+ρV+V,'ρDEL)/0
[40]  R+((ρR),B)ρ(,R+.≥1B+[R+~1+R-0,~1+R+A/1B)\(-A+V=DEL)/V
      V

VMATSRT[[]]V
VR+MATSRT TXT;CNT
[10]  * BASIC RADIX SORT WITHOUT BASE ENCODING
[20]  CNT+(ρTXT)[2]-1
[30]  R+ΔAL;TXT[;CNT+1]
[40]  +CNT+0
[50]  L1:R+R[ΔAL;TXT[R;CNT]]
[60]  CNT+CNT-1
[70]  +*(CNT)/L1
      V

VPRINT[[]]V
VLOC PRINT TXT;RHO;CT;BIN
[10]  * PAD TO PREVENT INDEX ERRORS
[20]  TXT+(60p' '),TXT,60p' '
[30]  *FOLLOWING IS THE LOOP VERSION OF <TXT[(LOC-1)*.+.120]>
[40]  +(RHO+ρLOC)+0
[50]  CT+1
[60]  LOC+LOC-1
[70]  BIN+(60p1),(5p0),60p1
[80]  LP:BIN\TXT[LOC[CT]+1120]
[90]  +(RHO≥CT+CT+1)ρLP
      V

```

Listing 2: SORTINDEX, an APL/V80 program that accepts text as input and produces an output of the text arranged in 18-character columns and the same text alphabetized. A block diagram of SORTINDEX appears in figure 3.

```

)WSID
SORTINDEX

```

POPULAR COMPUTING is making computing more popular . . . and simple . . . and enjoyable! Month after month after month.

Here it is! A magazine that provides the computer news, how-to's, and feature articles necessary for you to keep abreast of how computers do, and will, affect your work and your play. Best of all, it's delivered in plain language, without technical razzmatazz and jargon.

POPULAR COMPUTING is so exciting, so important, so informative, that everyone will fully understand what's really happening. Every issue is enriched with dollar-saving product reviews, special news briefs, and feature articles by famous contributors (like Isaac Asimov).

POPULAR COMPUTING is a magazine that must be read to be truly relished. That's why we've mounted a . . .

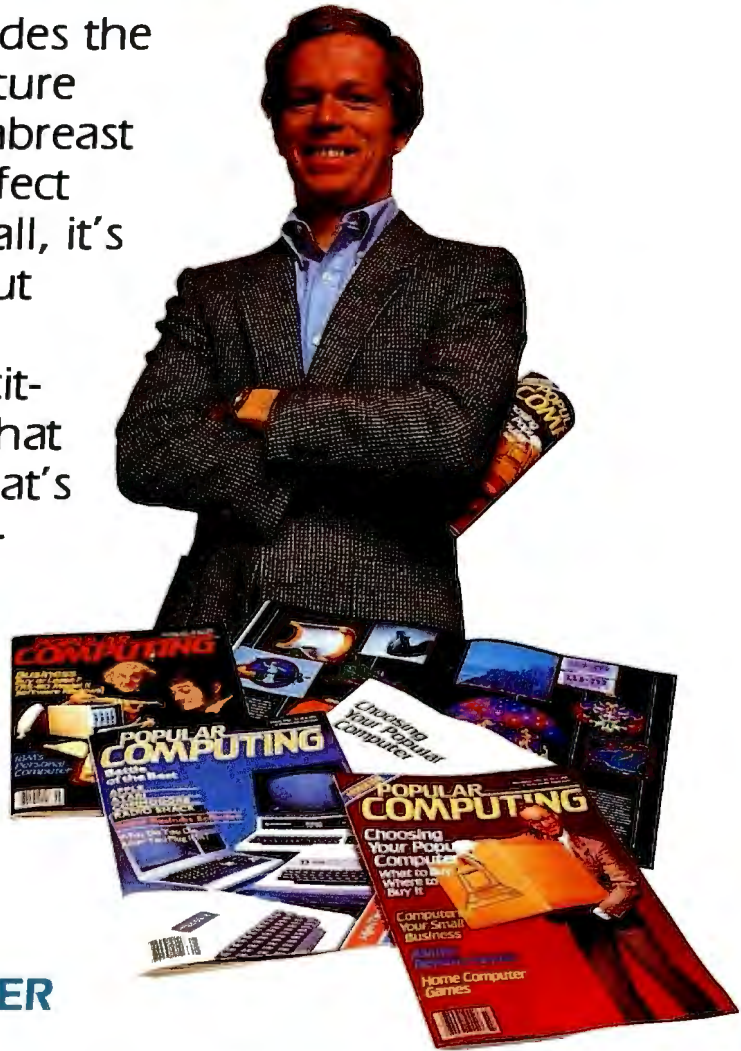

SPECIAL INTRODUCTORY OFFER

that enables you to try POPULAR COMPUTING at **NO RISK** whatsoever.

POPULAR COMPUTING

P.O. Box 307
Martinsville, NJ
08836



SUPER SAVINGS FOR ME...I'm enclosing my check or credit card number to take advantage of this super introductory offer of 12 issues for only \$11.97 saving me \$3.03 on the basic rate of \$15.00—and saving me \$18.03 off the newsstand rate of \$30.00. If my 30-day review of your first issue doesn't 100% please me, I may cancel my subscription and you will promptly refund ALL my money or give me a FULL credit on my charge card marked below:

Mail Today to: **POPULAR COMPUTING** P.O. Box 307 Martinsville, NJ 08836

Bill me at \$12.97 Check Enclosed for \$11.97 7B72
 Charge \$11.97 to: Visa Mastercard

Card No. _____

Signature _____ Expires _____

Name (Please Print) _____

Address _____

City _____ State _____ Zip _____

Please allow six to eight weeks for processing

Best prices anywhere We beat 'em all!

—COMPUTERS—

ALTOS—List.....	Less 20%
NorthStar HORIZON HRZ-2-QD...	\$2685
ADVANTAGE.....	Call
TeleVideo Computer Systems.....	Call
SUPERBRAIN 64K DD.....	\$1995
64K QD.....	2395
DSS-10 Meg. H D.	2895
CROMEMCO CS-1.....	3195
CS2.....	3549
CS-3.....	5595
ZZH.....	7995
ZENITH Z-90 w/DRIVE.....	2299
Z-89.....	2099

—TERMINALS—

TeleVideo 910C.....	\$569
912C.....	659
920C.....	719
925.....	719
950.....	915
OKIDATA Microline 80.....	\$329
Microline 82A.....	469
Microline 83A.....	739
Microline 84.....	Call For Price
C.I.T.O.....	Call For Price
SOROC IQ 120.....	629
IQ 130.....	585
IQ 135.....	719
IQ 140.....	995
HAZELTINE 1420.....	789
1500.....	845
1510.....	1029
ZENITH Z19.....	699

—PRINTERS—

CENTRONICS 739-1 (parallel).....	499
739-3 (RS232C).....	599
704-11 (parallel).....	1569
704-9 (RS232C).....	1519
TI 810 Basic.....	1289
810 Full.....	1549
820 RO Basic.....	1545
NEC 7710 (RS 232).....	2295
3510.....	Call
QUME 9-45 Full Option.....	2125
9-45 Limited.....	2099
Diablo 630 RO.....	2049
PRISM 80.....	895
132 w/color.....	1495
Epson MX-80.....	441
MX-80 FT.....	548
MX-100.....	745

—DISK SYSTEMS—

MORROW Discus 2D.....	835
Dual Discus 2D.....	1385
Discus 2+2.....	1069
M5 5Meg. Hard Disk.....	1949
M10, 10 Meg. H D.....	2995
M 26, 26 Meg. H D.....	3349
Decision I.....	1339
CORVUS 5 Meg. Hard Disk.....	2555
10 Meg. Hard Disk.....	3955
20 Meg. Hard Disk.....	4755

Prices are for prepaid orders only, and reflect a cash discount. Charge card orders are slightly higher.

Computers Wholesale

Box 91 Brewerton, N.Y. 13029
315-472-3055

Most items in stock for immediate delivery. Factory sealed cartons. w/full factory warranty. NYS residents add appropriate sales tax. Prices do not include shipping. COD orders require 25% deposit. Prices subject to change without notice.

Listing 2 continued:

```

VSRINDX[ ]V
VZ+SRTNDX TEXT;VC;SVC;SRTTXT;NDXTXT
[10] [H+2
[20] *CONVERTS TEXT TO WORDINDEX - EACH WORD IS ASSIGNED A WORD NUMBER.
[30] *PRINTS WORDINDEX, SORTS WORDINDEX ALPHABETICALLY AND PRINTS IT.
[40] VC+AL INDEX TEXT
[50] NDXTXT+AL BACK1 VC
[60] [H+1
[70] FF
[80] NDXTXT
[90] [H+2
[100] SVC+SORT,VC
[110] SRTTXT+AL BACK1 SVC
[120] [H+1
[130] FF
[140] SRTTXT
[150] [H+2
V

VINDE[ ]V
VZ+AL INDEX TXT;K;I;WRD;WRD2;NXN;WRD1;WW
[10] *ASSIGNS INDEX NUMBER TO EACH WORD OF TEXT
[20] *CONVERTS EACH WORD - SIX LETTERS AT A TIME - TO NUMBER BASE 47
[30] *(47+*pAL+'ABCDEFGHIJKLMNPOQRSTUVWXYZ0123456789,.;?+*')
[40] *CREATES MATRIX 3 BY N = NUMBER OF WORDS IN TEXT
[50] K+'. '
[60] [P+10
[70] Z+10
[80] [O+I+0
[90] NXN+1+(AL PREP TXT)
[100] LP1:[V[19]
[110] 'INDEXING ',K+K, ' '.
[120] +(0=pNXN)/O
[130] WRD+(WW-NXN10)+NXN
[140] NXN+(1+WW)+NXN
[150] I+I+1
[160] +(6=pWRD)/TX3
[170] +(12=pWRD)/TX1
[180] WRD+12+WRD
[190] TX1:WRD1+6+WRD
[200] WRD2+6+WRD
[210] Z+Z,(AL INAL 6+WRD1),(AL INAL 6+WRD2),I
[220] +LP1
[230] TX3:Z+Z,(AL INAL 6+WRD),O,I
[240] +LP1
V

VPREP[ ]V
VZ+AL PREP TXT
[10] *PREPARES TEXT BY ELIMINATING EXTRA BLANKS AND INDEXING EACH CHARACTER
[20] *OF TEXT ON ALPHABET AL
[30] TXT+RDY TXT
[40] Z+AL:TXT
V

VRDY[ ]V
VR+RDY TXT
[10] TXT+' ',TXT, ' '
[20] *PADS TO MAKE LIFE EASY
[30] R+TXTe' '
[40] R+~R+1+R,O
[50] *ROTATES TO FIND CONSECUTIVE BLANKS
[60] R+~1+R/TXT
[70] *ELIMINATES UNNECESSARY BLANKS
V

VINAL[ ]V
VZ+AL INAL MP
[10] *CONVERSION OF p=6 STRING IN ALPHABET AL TO INTEGER'
[20] +(6<pMP)/ERR
[30] Z+471MP
[40] +O
[50] ERR:'INPUT TO INAL IS OVER SIX CHARACTERS'
V

VBACK1[ ]V
VZ+AL BACK1 MX;UN;Z1;Z2;K
[10] *CONVERTS INTEGERS BACK TO CHARACTER STRINGS; ONE LINE AT A TIME.
[20] *PRESENTS RESULT AS A COLUMN OF WORDS WITH WORDINDEX NUMBERS.
[30] K+'. '
[40] Z+'. '
[50] LP1:+(0=p,MX)/END
[60] UN+3+,MX
[70] MX+3+,MX
[80] Z1+7+AL OUTA UN[0]
[90] +(UN[1]=0)/MAT
[100] Z2+Z1,6+1+AL OUTA UN[1]
[110] +CAT
    
```

Listing 2 continued on page 260

TIM™ III

The Non-Programming Approach to Data Base Management

Data Base Management

Data management packages were created to save time and money in the development of software solutions to information problems. Many have been designed to accomplish just that, although most have only the programmer in mind. Sure they would save time in the long run, but what of the initial investment in time and effort required to learn the new language? What about the non-programmers in the world who would like an easy yet powerful applications generator? The solution is one of the most highly acclaimed software packages of our time, T.I.M. III.

What is T.I.M.?

T.I.M. is **Total Information Management**. Programmers love it due to its original solutions to classic data management problems. Non-programmers adore it since they can use it to achieve the same results as with other more complicated programming-like packages.

What Makes T.I.M. So Simple to Use?

We at Innovative Software, Inc. designed T.I.M. from day one with the end user in mind. Maybe he is a programmer who doesn't have time to learn a new language. Or perhaps a neophyte who fears coding pads and lines numbered by tens. We felt that a data management package should be able to be used by anyone from a systems analyst to a secretary. That's why T.I.M. takes a full *menu-driven* approach, uses multiple *HELP* screens, and has a manual that sets a new standard in documentation.

The Manual

Many people believe that the manual is just as important as the software itself, a view that we at Innovative Software, Inc. tend to share. The manual for T.I.M. is divided into two sections, the Reference section and the Primer. The Reference section describes all of T.I.M.'s commands and subcommands. This is done in English, not in technical terms or in our own language. Even if you have

never seen a computer before in your life, you'll be able to read and understand our manual immediately. The second section is a primer which goes through several examples for you, again in plain English. These true-to-life examples take the beginner by the hand, and instructs him what to do and when. You will be able to see for yourself that T.I.M.'s only limitation is the imagination of the user.

Features of T.I.M.

T.I.M. has all of the features one has come to expect from a data management package, as well as many new ones. For example, a *word processing* interface that allows you to merge information from a T.I.M. file with letters or other documents created by a word processor. Now you can automatically send personalized letters to hundreds or thousands—quickly and easily. T.I.M.'s *Select* command enables you to pull specific information from a file. For example, "All customers who live in a certain ZIP code, whose last name begins with the letter A to L, whose balance due is less than \$50.00." A sophisticated *report generator* and even a *list generator* are also included.

How powerful is T.I.M.? With a maximum record size of 2400 characters and the ability to keep up to forty fields sorted properly at all times, T.I.M. is powerful enough to handle just about any application. T.I.M. can handle over 32,000 records per file, and two files can be linked together for reports if your application requires a many-to-one relationship. T.I.M. also includes all of the same editing commands as your word processor, thus making data entry and editing a snap. You can also pull selected records from one file to place them into another. Files may be restructured to add or subtract fields and/or change field lengths or types. T.I.M. even has it's own utility for backing up hard disks onto floppies.

Where to Find T.I.M.

T.I.M. is available from many fine computer dealers across the country. Or you may purchase from us direct by calling 913/383-1089.

Either way you will have the finest data management program available.



Available for CP/M,* and IBM PC DOS.**
CP/M version—\$695. IBM PC version—\$495.

Innovative Software, Inc.
9300 W. 110th Street, Suite 380
Overland Park, Kansas 66210 USA
913/383-1089

TIM is a Trademark of Innovative Software, Inc.
*CP/M and MP/M are Trademarks of Digital Research
**Trademarks of IBM

Listing 2 continued:

```
[120] MAT:Z2+Z1,6ρ' '
[130] CAT:Z+Z,(25ρ' '),Z2,' ',5 0vUN[2]
[140] CS
[150] 'CONVERTING ' ;K+K,'.'
[160] →LP1
[170] END:Z+((ρZ)+44),44)ρZ
      v

      vOUTA[[]]v
      vZ+AL OUTA X;LOG
[10]  #INVERS OF INAL GOES FROM INTEGER TO CHARACTER STRING'
[20]  Z+AL[47 47 47 47 47 47 47]TX]
      v

      vSORT[[]]v
      vZ+SORT VCT;MX;SRT
[10]  #SORTS SECOND COLUMN OF INTEGERS OF 3 BY N MATRIX FIRST.
[20]  #THEN FIRST COLUMN
[30]  MX+(((ρVCT)+3),3)ρVCT
[40]  SRT+ΔMX[;1]
[50]  MX+MX[SRT;]
[60]  SRT+ΔMX[;0]
[70]  Z+MX[SRT;]
      v
```

Listing 3: WORDINDEX, a program written in APL/V80 that first uses Processor 101 to convert a CP/M-80 file to APL format. WORDINDEX then alphabetizes the file, arranges the output in five 18-character columns, and prints the results. Figure 4 shows a block diagram of WORDINDEX.

```
      )WSID
WORDINDEX

      □A
25803

      )FNS
ALPHAB FORMAT INDEX INFO INITIAL PDUMP RDY SAVEFRAG SAVEKK SORTER
SAVE SORTPRINT WINDEX WORDINDEX

      vINITIAL[[]]v
      vINITIAL;I;J;M
[10] I←J+9
[20] M←0 18ρ' '
[30] LP1:'INDEXFILE ' ;I
[40] Δ('TEXT',2 0vI←I+1),'+M'
[50] Δ(')CSAVE TEXT',2 0vI
[60] Δ(')ERASE TEXT',2 0vI
[70] →(I=31)/LP1
[80] LP2:'SORTFILE ' ;J
[90] Δ('SORT',2 0vJ←J+1),'+M'
[100] Δ(')CSAVE SORT',2 0vJ
[110] Δ(')ERASE SORT',2 0vJ
[120] →(J=37)/LP2
      v

      vWORDINDEX[[]]v
      vTEXT+WORDINDEX;NAME;DATA;ALP;C;N;COUNT;VN;I;J;J;JL;JK;VCT;BF;V
      Z;K;IN;KK
[10] #ASSIGNS INDEX NUMBERS TO WORDS, UP TO ABOUT 5000
[20] #ALPHABETIZES WORDINDEX - PRINTS BOTH.
[30] KK←J+10
[40] □O←0
[50] □U←1
[60] ALP+'ABCDEFGHIJKLMNPOQRSTUVWXYZ'
[70] □H←1
[80] LP,'ENTER FILE NAME AS "NAME.PCL" :',LP
[90] NAME←□
[100] 2ρLP
[110] □H←2
[120] #PROCESSOR 101 CONVERTS PCL, ASC, ETC TO APL/DTC READABLE TEXT
[130] 101 □S'DATA'
[140] NAME[C/ρNAME]←'α|n|ε-vΔ|o''□|Tο*?ρ[-+uω≡+c'|ALP;(C+NAMEεALP)/NAME]
[150] NAME←(8+(NAME;'.'))+NAME,3+(1+NAME;'.'))+NAME
[160] DATA←NAME
[170] →(0=DATA)/ERR
[180] TEXT←''
```

Listing 3 continued on page 262



Mainframe- Quality Software for Microcomputers

ISE is an international consortium of the world's leading consulting and software firms.

Our specialized products and services are distributed throughout the world by these ISE affiliates:

In U.S.:
ISE-USA
350 West Sagamore Parkway
West Lafayette, IN 47906
Tel: (317) 463-2581
TWX: 810-342-1881

In France:
ISE-CEGOS
Tour Chenonceaux
204, Rond-Point du Pont de Sèvres
92516 Boulogne Billancourt Cedex
Tel: 620-61-04

In Germany:
ISE-ADV/ORGA GERMANY
Lothstr. 19
D-8000 Munich 40
Tel: 089-192 071/4

In Norway:
ISE-DATEMA NORWAY
ST. Halvards gt. 77
Oslo 6 Norway
Tel: (02) 670880

In Sweden:
ISE-DATEMA SWEDEN
Box 1056
Huvudstagan 1
171 21 Solna

In Switzerland and Austria:
ISE-ADV/ORGA SWITZERLAND
Morgartenstrasse 6
CH-6003 Luzern
Tel: 041-23 23 60/61

In the UK and Ireland:
ISE-PACTEL
Rochester House
33 Greycoat Street
London SW1P2QF
Tel: 01-828 7744

Elsewhere:
ISE-INTERNATIONAL
350 West Sagamore Parkway
West Lafayette, IN 47906
Tel: (317) 463-4561
TWX: 810-342-1881

Circle 197 on inquiry card.

Data base management: Check out the essentials.

CHECKLIST

Before You Buy A DBMS Check These 10 Essential Aspects:

- 1. **Data Integrity:** Does it protect against data corruption, erroneous data entry, and unauthorized relationships?
- 2. **Physical Data Protection:** Are recovery and restart capabilities provided? Can you roll the data base back to a previous state?
- 3. **Data Security:** Does it provide separate "read" and "write" access controls? Down to the item level? Is data encryption provided?
- 4. **Data Independence:** Can the data base structure be modified without changing previous programs?
- 5. **Performance:** Can you tune performance by controlling physical storage? Can you eliminate data redundancy? Are variable length records and data compression provided? Are response times acceptable for large data bases?
- 6. **Multi-User:** Does it support concurrent multi-user access with passive and active locking at the record level?
- 7. **Ease of Use:** Can many-to-many and recursive relationships be directly defined? Can programs be written in any major programming language? Are instructions short and simple? Is quality documentation available?
- 8. **Query Report System:** Can ad hoc queries be easily made with non-procedural, English-like statements? Are sophisticated reports available from pre-defined queries? Are nested queries supported?
- 9. **Portability:** Does the DBMS run under CP/M™, MP/M, CP/M-86, MP/M-86, PC DOS™, UNIX™? On Z80™, 8086, 8088, 68000, and PDP-11™? Does it run with COBOL, Pascal, FORTRAN, PL-1, BASIC and C?
- 10. **Support:** Are professional training, regular product updates, enhancements, and professional consulting all available?



Professionals know the difference.

ISE is an international consortium of the world's leading consulting and software firms, representing over 5,000 professionals around the world.

If you can't answer "YES" to these questions, send for our comprehensive booklet, "How to Evaluate and Select a Data Base Management System."

MAIL TO: Your local ISE affiliate.

Name _____ Title _____

Company _____

Address _____

City _____ State _____ Zip _____

Phone _____ (area code) _____ (ext.) _____

Z80 is a registered trademark of Zilog; PDP-11 of Digital Equipment Corp; CP/M of Digital Research; UNIX of Western Electric; PC DOS of IBM. 4B262



FUNCTIONAL SYSTEM SUPPORT

MFI/O-100 provides your S-100 computer with powerful operating system support. Ideal for systems that require serial and parallel I/O, interrupt control and system timing services in either single or multi-user environments. Originally designed to support Digicomp's Pascal, Ada*, and CP/M™ operating systems, OEM's and end-users alike have found MFI/O-100 the most flexible, cost-effective I/O board available today.

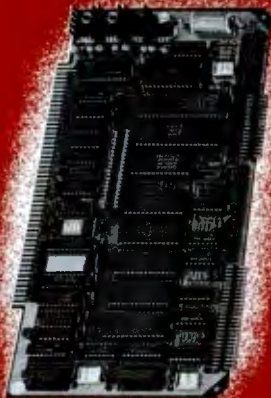

\$595 A&T

Multi-Function I/O Board

Features:

- 4 serial I/O channels
- Hardware or software selectable bit rates from 50 - 19,200 baud
- 24 bits of parallel I/O
- Real-Time Clock/Calendar option with battery backup
- 5 16-bit counter/timers
- 16 levels of daisy-chained vectored interrupts
- 8 or 16 bit address recognition
- Full compatibility with IEEE-696 and most pre-standard boards
- And More!

Ask about our 256K memory, Z68000 Dual-Processor, Microengine Dual-Processor Boards and our Pascal and Ada systems. OEM discounts available.

Contact:

Digicomp Research

Terrace Hill
Ithaca, NY 14850
(607) 273-5900



* Ada is a trademark of the Dept. of Defense. (Ada Joint Program Office)

™CP/M is a registered trademark of Digital Research Corp.

Listing 3 continued:

```
[190] IN←L+0
[200] LP2: I+0
[210] BF←' '
[220] LP1: I+I+1
[230] →(0=ρN+DATA)/END
[240] ;I
[250] TEXT+(.TEXT).N
[260] TEXT+(~[V[12]=TEXT)/TEXT
[270] →(I<10)/LP1
[280] #ACTUAL WORDINDEXING BEGINS HERE
[290] FRAG←SAVEFRAG TEXT
[300] END:WINDEX RDY TEXT
[310] #LAST WORDFRAGMENT OR WORD ASSIGNED TO NEXT ITERATION
[320] TEXT←FRAG
[330] →(0=ρN)/END2
[340] →(25*(L+L+1))/LP2
[350] LF,'TEXT FILLED ALL SPACE ON DISK',LF
[360] 'MAXIMUM INDEXABLE TEXT ABOUT 5000 WORDS',LF
[370] 'PROGRAM WILL PROCEED AS IF THIS WAS END OF TEXT.',LF
[380] →END3
[390] #PRINTS ALPHABETIZED WORDINDEX
[400] END2: SORTPRINT
[410] END3: LF,'TEXT WORDINDEXED SUCCESSFULLY'
[420] +0
[430] ERR: LF,'ERROR--ERROR IN NAME OR FILE NOT FOUND'
[440] □O+1
V
```

```
VSAVEFRAG[□]V
VZ←SAVEFRAG X;I
[10] #SAVES POTENTIALLY FRAGMENTED WORDS AT END OF
[20] #~250 WORD ITERATION FOR NEXT ITERATION
[30] I+(φ' '=X);1
[40] →(I=0)/END
[50] Z+(-I)+X
[60] TEXT+(-I)+X
[70] +0
[80] END: Z+' '
V
```

```
VRDY[□]V
VZ←RDY TXT
[10] #DELETES EXTRA BLANKS BETWEEN WORDS
[20] TXT←' ,TXT,' '
[30] Z←TXTε' '
[40] Z←-Z+1+Z,0
[50] Z+(~1+Z/TXT)
V
```

```
VWINDEX[□]V
VZ←WINDEX TXT;AB;K;DXD;SRT
[10] #MAKES SEQUENTIAL WORDINDEX
[20] □W←132
[30] L←10
[40] □U←1
[50] ;TXT←INDEX TXT
[60] #FORMATS OUTPUT INTO FIVE COLUMNS
[70] DXD←FORMAT TXT
[80] □H←1
[90] LF
[100] ;Z←DXD
[110] □H←2
[120] #SAVES SEQUENTIALLY INDEXED TEXT ON DISK
[130] 'TEXT'SAVEKK TXT
[140] K←10
[150] LP:' ALPHABETIZATION ',AL[(K+K+1)-10]
[160] #POPPS OUT WORDS STARTING WITH SAME LETTER A-Z
[170] SRT←K ALPHAB TXT
[180] #SAVES POPPED OUTPUT ON DISK BY FIRST LETTER
[190] 'SORT'SAVE SRT
[200] →(K=36)/LP
V
```

```
VINDEX[□]V
VZ←INDEX TXT;I;WRD;WV;K
[10] #ASSIGNS SEQUENTIAL WORDINDEX NUMBERS
[20] #STACKS OUTPUT AS MATRIX 18 CHARACTERS WIDE
[30] K←' '
[40] Z←0 18ρ''
[50] TXT←1+RDY TXT
[60] LP:' INDEXING ',X+K.' '
[70] WRD←(WV+TXT;')→TXT
[80] WRD←(12+WRD),6 0ρIN+IN+1
[90] TXT←(WV+1)+TXT
[100] Z←Z,[0]1 18ρWRD
[110] →(ρTXT=0)/LP
V
```

Listing 3 continued on page 266

READ AMERICA'S NUMBER 1 NON-SELLER.

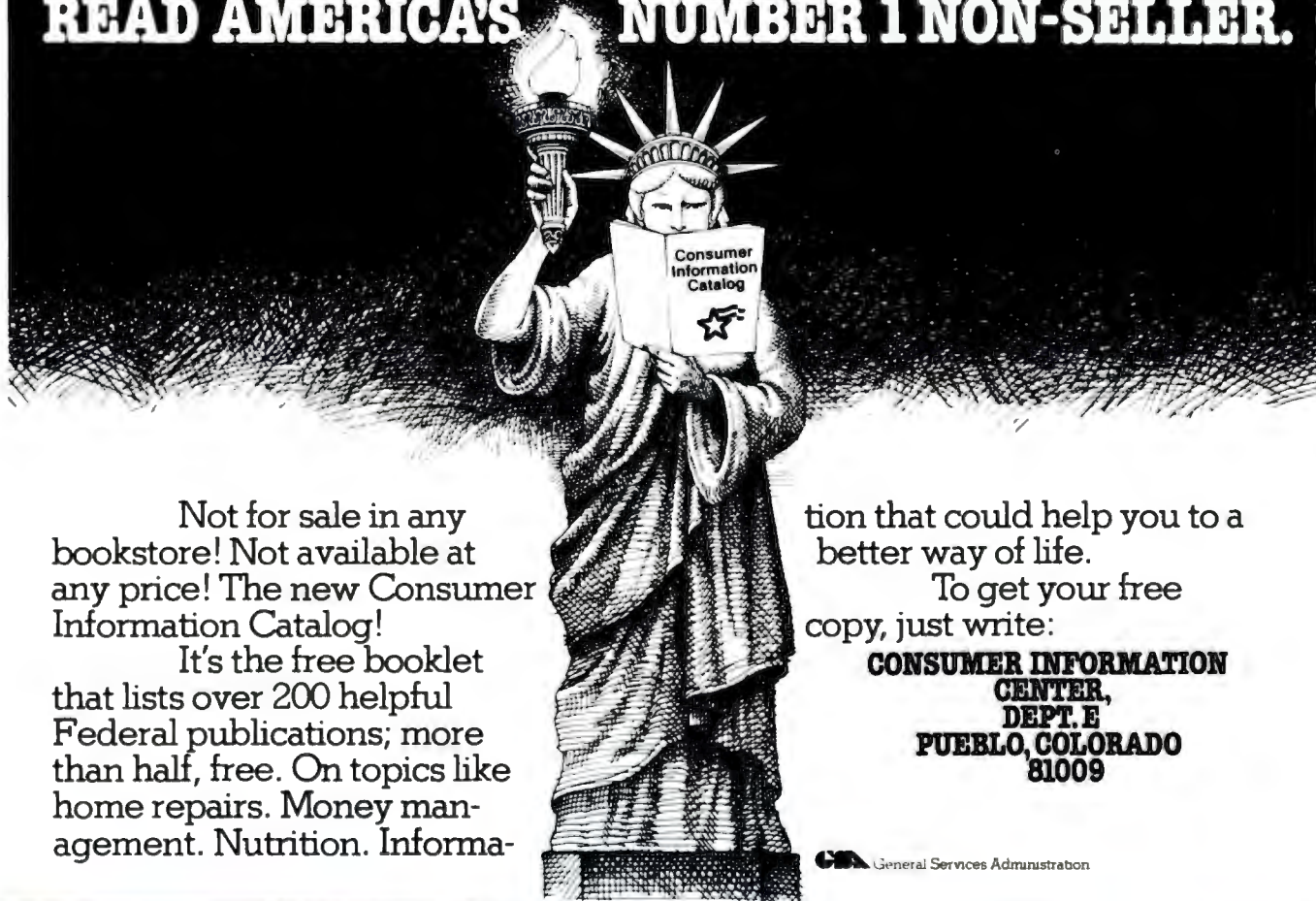

Not for sale in any bookstore! Not available at any price! The new Consumer Information Catalog!

It's the free booklet that lists over 200 helpful Federal publications; more than half, free. On topics like home repairs. Money management. Nutrition. Informa-

tion that could help you to a better way of life.

To get your free copy, just write:

**CONSUMER INFORMATION CENTER,
DEPT. E
PUEBLO, COLORADO
81009**

 General Services Administration

DSTD-764

Single Board Microcomputer with STD BUS Expansion Capability

2-8 Bit Parallel Ports 2-RS232C Channels *RS232C Channel *RS422 Channel Baud Rate Generator *Status Switch & LED's

Brown Out Detection Logic

DC Power Connector

*Winchester Host Adaptor

Timing and Control

*Floppy Disk Controller 8" and 5 1/4" SS DD and DS Dd

*Optional Features

ADDITIONAL OPTIONS

- Expansion Card Cage
- Video Display Controller (24 x 80)
- CP/M 2.2 with enhanced BIOS

64K Bytes DRAM with Parity

*STD BUS Interface Logic

STD BUS Expansion

*Video Display Controller Port

Bytewide Z80(A) Sockets

DMA Controller

Storex Corporation
Westwood Massachusetts
(617) 329-3454

Applied Micro Technology Inc.
Woodland Hills Ca (213) 888-2027
Orange County Ca (714) 995-7099
San Diego Ca (717) 223-2632

Wright Marketing Company, Ltd
Gaithersburg Maryland (301) 840-1928
Electro Tech Marketing Assoc.
Chicago Illinois (312) 588-4535

J.F. Huribut Co.
Golden Colorado (303) 279-7796
Tempe Arizona (602) 968-5962
Salt Lake City Utah (802) 973-4443

Ashby Associates, Inc.
Dayton Ohio (513) 252-5627
Cleveland, Ohio (216) 461-0826
Highland, Michigan (313) 867-8729

Digital Solutions Inc.
Houston Texas (713) 784-8875
Dallas Texas (214) 960-1984
Austin, Texas (512) 451-0755

The Beams Company
Des Moines Iowa (515) 255-1148
Shawnee Mission Kansas (913) 631-0290
St Louis Mo (314) 569-1060

Tracan
Toronto Ont (416) 625-7752
Montreal P.O. (514) 694-5343
W Vancouver B.C. (604) 926-3411
Ottawa Ont (613) 722-7667

Pretco
Toronto Ont (416) 678-0401
Ottawa Ont (613) 228-3491
Montreal P.Q. (514) 389-8051

dy-4 SYSTEMS INC.

dy-4 Systems Inc
Ottawa Ontario (613) 728-3711

Hewlett-Packard on the professional use of personal

There's a considerable difference between a computer that just fits and one that really fits.

There are a lot of places where the basic one-size-fits-all type of personal computer fits in really well. But if you're like most of the technical professionals we know, you'd rather use a tool that was clearly designed for the job you're doing.

That's why we've developed these five very different personal computers just for people like you. And configured each one specifically

just like a real craftsman's tool fits your hand.

Now we'd like to show you, in some detail, just what we mean.

The HP-41.

You might remember the series 9100 engineering computer we introduced in 1968 for \$5000. Now,

able computing system. Add a printer for hard-copy output. Or our 128k byte cassette for mass storage. Or add both; they'll only take up as much space in your briefcase as three paperbacks.

You can even use your HP-41 as a remote data collector, then link it up with any HP Series 80 personal computer via HP-IL.



ically to operate in technical environments. To interface with instruments and other computers. To give you all the computing power and all the high-level graphics capability you need.

We also offer you a full range of printers, graphic plotters, additional memory systems, input devices, and communications links. Plus over 5000 software programs at last count.

As a result, you can practically design your own system. And have a personal computer that fits your professional environment

for a base price of \$250, you can hold all the power of that system in the palm of your hand.

All by itself, this hand-held computer can help a petroleum engineer evaluate gas or oil reservoirs. Or help civil engineers do critical computations in the field.

Add the new Hewlett-Packard Interface Loop (HP-IL), and you can turn your HP-41 into a powerful, port-

The HP-85.

Complete with an integrated tape drive, printer and CRT, this typewriter-size system fits easily in a crowded work area. Where you can use its impressive number-crunching power any number of ways. For waveform analysis. Regression analysis. Linear programming.

Add the HP-IB interface, and you can control up to 14 instruments simultaneously. Add our Data Communications Pac and you can tie into another

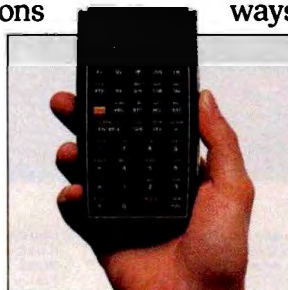

All the power of our 9100 Series Desk-top Engineering Computer. Now you can hold it in the palm of your hand.

computers.

ence between the one-size-fits-all

on-site computer, a major data network, or a national timesharing service.

You can even use this portable machine to do all these same jobs out in the field. And more.

The HP-87.

The HP-87 sets a new level of performance for personal computers in its price range. You get built-in screen graphics, up to 544k bytes of RAM, and an 80-column integrated CRT. Plus the same flexible I/O structure for control applications as the HP-85. Because of its extended memory, you can take advantage of a VisiCalc® PLUS worksheet with up to 16,000 cells. And since the HP-87 has a built-in HP-IB, it's easy to add instruments, disc drives, printers, plotters, and even a graphics tablet. To give you even more to work with, there's an optional CP/M® module. And all applications developed for the HP-85 in BASIC are upward-compatible to the HP-87.

The HP 9826.

Designed to handle high-speed data acquisition and tests, the 9826 has a powerful MC 68000 CPU, a built-in flexible disc, up to 2 megabytes of read/write memory, and power-fail protection. Plus a built-in HP-IB in-

terface and a variety of other interface cards, so you're free to concentrate on testing. Instead of system configuration.

To give you even more flexibility, you can run applications in HP-enhanced BASIC, HPL, or Pascal. We've also built a CRT display with advanced graphics into the system, so you can see and interpret your data the instant you get it. And since everything about this system is built for speed, we've developed a special rotary control knob that lets you edit programs, calibrate instruments, and control motor speed, all with fast analog inputs.

The HP 9836.

This full-function workstation does it all: design, computation, and high-speed testing. Because it gives you all the high-performance features of the 9826. And then some. With the 9836, you get a big, easy-to-read CRT. Sophisticated graphics capability. Two flexible disc drives. Room for up to two megabytes of memory. And an even longer list of engineering software and peripherals to choose from.

And those

Our 7470 Plotter. One of many peripherals that help make our personal computers really personal.

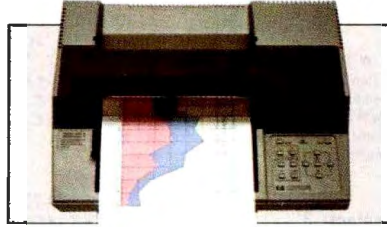

are just the five personal computers we've developed for technical professionals; we also make a full range of person-

al computers for business professionals.

So. Before you decide to adapt your routines to fit the needs of a one-size-fits-all computer, we think you should get in touch with us first. And see what it's like to have a personal computer that really is personal.

Come and try them out at our Productivity '82 seminar in your area. Just watch your local newspaper for details on Productivity '82, or return this coupon.

Hewlett-Packard
1820 Embarcadero Road, Palo Alto, CA 94303

I'd like to see which of your personal computers fits the way I work best. Please send more information on these models:

HP-41 HP-85 HP-87 HP9826
 HP9836

Name _____

Title _____

Company _____

Address _____

City/State/Zip _____

77136



HEWLETT PACKARD

Circle 178 on Inquiry card.

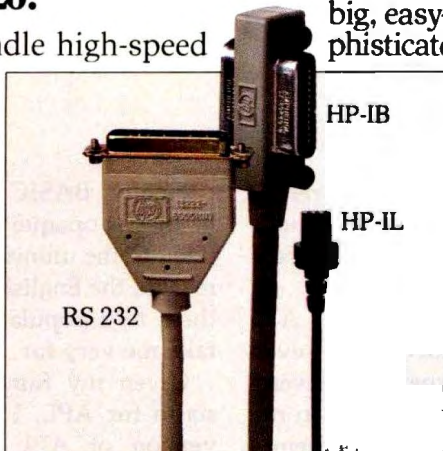

VisiCalc® is a registered trademark of VisiCorp.
CP/M® is a registered trademark of Digital Research, Inc.

A wide variety of interfaces for technical environments, including HP-IB, HP-IL, RS 232, GPIO, and BCD.

TCG-203

S-100 Boards from S. C. Digital

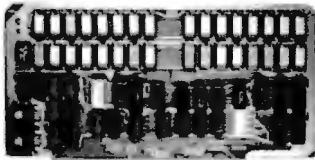

256K DYNAMIC RAM

features: Model 256KE
 • 18 or 24 bit address. • 8/16 bit wide data • Transparent refresh with unlimited DMA, immune to Wait States, halts, resets. • Fast access time 180nsec from Smemr or Psync high, will run with Z80, Z8000 to 6mhz, 8080, 8085, 8088 to 8mhz without Wait States. • Accepts 4118, 4184's.

64K DYNAMIC RAM 'Uniselect: 2'

features: Model 64KUS
 • 16 or 24 bit address • 8 bit data. • Bank select by SW settable port, bits in two blocks. • Two 32kb (128kb) addressing. • Transparent refresh - same as M:256KE. • Fast access time - 220nsec, will run with Z80, Z8000 to 4mhz, 8080, 8085, 8088, 8088 to 5mhz without Wait States. • Can be configured to various multusers DS's. • Expandable to 256KB using 4184's.

32K STATIC RAM 'Uniselect: 3'

features: Model 32KUS
 • Fully Static using 2k by 8 MOS chips. • 16 or 24 bit address. • 8/16 bit wide data. • Bank Select by port and bit in 32K block • Two 16K block addressing with window capability in 2k increments. • EPROM can be mixed with RAM. • Fast access - 250nsec from address valid - will run with Z80, Z8000 to 4mhz, 8080, 8085, 8088, 8088 or 88000 to 8mhz without Wait States. • Provision for Battery Backup.



Z80 CPU Board

features: Model CPU1 Z80
 • 2 or 4mhz clock • Jump on Reset • 8 levels of prioritized vectored interrupts.

I/O, Memory Interface 'Interface: 1'

features: Model 3SPC
 • 3 serials using UART, RS-232C or 20ma current loop. • 1 Parallel I/O with hand shakes. • 4k Ram, 4k EPROM (not supplied). • Built in Kansas City Audio Cassette interface. • Baud rate generator from 19.2kbaud to 110 baud.

2K Z80 Monitor Program

available for M:3SPC

features. many routines including breaker points, cassette record and play back . . . etc. Comes in 2 EPROMs and 1K RAM

All boards conform to IEEE896/S100 specifications, fully socketed, screened legends, masks, Gold contacts. Guaranteed One Full year

Model	Price	with	AGT
256KE	\$795	256KB	AGT
256KE-128	\$525	128KB	AGT
64KUS-04	\$395	64KB (4104's)	AGT
64KUS	\$395	64KB (4118's)	AGT
64KUS-16	\$285	16KB	AGT
32KUS	\$389	32KB with CMOS	AGT
32KUS-16	\$259	16KB with CMOS	AGT
32KUS-8	\$148	no memory	AGT
CPU1-Z80	\$218	with interrupt	AGT
CPU1-Z80-K	\$148	no interrupt	Kt
3SPC	\$229	with cassette	AGT
3SPC-KC	\$159	with cassette	AGT
2K Monitor	\$ 55	with 1K Ram	Kt

Delivery is within 3 working days MC, Visa or COD orders accepted. Illinois residents add 5 1/4% sales tax.

O.E.M. & DEALER PRICING AVAILABLE

S. C. DIGITAL

P.O. Box 906

1240 N. Highland Ave., Suite #4

Aurora, Illinois 60507

Phone: (312) 897-7749

Listing 3 continued:

```

VFORMAT[[]]V
VZ+FORMAT TXT;PIF;PAD;I
[10] #FORMATS OUTPUT INTO FIVE COLUMNS 18 CHARACTERS WIDE
[20] ;LP
[30] PIF+[(P TXT)[0]+5
[40] Z+(PIF,0)P' '
[50] TXT+((5*PIF),18)P(,TXT),125P' '
[60] PAD+(PIF,7)P' '
[70] I+0
[80] LP:Z+Z,PAD,TXT[(I*PIF)+1PIF;]
[90] I+I+1
[100] -(I<4)/LP
V

VSAVEKK[[]]V
VZ+X SAVEKK Y
[10] #SAVES WORDINDEXED TEXT
[20] Z')COPY ',X,2 0VKK
[30] Z(X,2 0VKK),'+',(X,2 0VKK),',[0]Y'
[40] Z')CSAVE ',X,2 0VKK
[50] Z')ERASE ',X,2 0VKK
[60] KK+KK+1
V

VALPHAB[[]]V
VZ+K ALPHAB X;SRT
[10] #POPPS ALL MATRIX ROWS WITH SAME INITIAL LETTER A-Z
[20] SRT+X;[0]CAL[K-10]
[30] Z+SRT/[0]X
V

VSAVE[[]]V
VZ+X SAVE Y
[10] #SAVES POPPED OUT PARTS OF MATRIX ON DISK
[20] Z')COPY ',X,2 0VK
[30] Z(X,2 0VK),'+',(X,2 0VK),',[0]Y'
[40] Z')CSAVE ',X,2 0VK
[50] Z')ERASE ',X,2 0VK
V

VSORTPRINT[[]]V
VZ+SORTPRINT;K
[10] #GETS POPPED VARIABLE, DOES INTERNAL SORT, PRINTS RESULT
[20] []H+1
[30] ;PF
[40] []H+2
[50] K+10
[60] LP:Z')COPY SORT',2 0VK+K+1
[70] Z+SORTERZ'SORT',2 0VK
[80] []H+1
[90] ;FORMAT Z
[100] []H+2
[110] #ERASES VARIABLE TO MAKE ROOM FOR NEXT
[120] Z')ERASE SORT',2 0VK
[130] -(K<36)/LP
V

VSORTER[[]]V
VZ+SORTER MTX;SRT;I;K
[10] #SORTS ALPHABETICALLY FROM 12TH LETTER OF WORD FORWARD
[20] K+1 '
[30] I+13
[40] LP:'SORTING ',K+K,'.'
[50] SRT+AL\MTX[I+I-1]
[60] SRT+ASRT
[70] Z+MTX+MTX[SRT;]
[80] -(I=1)/LP
V
    
```

Text continued from page 254:

have each line print out its result. This can be easily inspected and— with a bit of luck and experience— understood.

The interactive nature of APL allows for experimentation—even within a halted program. Several APL functions are rarely used in my work. If I do run across one of them, I try it out in an experiment.

Finally, BASIC and Pascal tend to be just as opaque to me as APL must seem to the uninitiated. For whatever reason, the English-like mnemonics in these two popular languages do not take me very far.

Given my familiarity and enthusiasm for APL, I kept looking for a version of APL to appear among microcomputers. At last I found one,

SPECIAL SALE!!

MOST ECONOMICAL SOURCE TO BUY FLOPPY DRIVES — FROM ONE OF THE LARGEST DEALERS IN THE WORLD! NOW YOU CAN BUY TANDON, QUME, TEAC, SHUGART, MPI, SIEMENS, REMEX, YANKEE, APPLE, EPSON, DEC, CDC, CIPHER, NEC, TALLY, ALTOS, ATARI, DATAPRODUCTS, IBM AND MORE . . .
. . . AT LOW COST!! IMMEDIATE SHIPPING!!

Add- on Drive for Apple II, 100% compatible (runs 3.2 & 3.3 DOS). Includes cable/cabinet . . . \$339.00

5MB Tandon Winchester (TM602) & Controller/Cables/Software to run DOS 3.3 for Apple II Computer \$1795.00
Same system with 10MB Tandon Winchester 1995.00

IBM MEMORIES - 100% IBM Compatible Memories

64K \$269.00 128K \$499.00 192K \$599.00 256K 699.00 512K 1299.00 Immediate Delivery

QUME DISK DRIVES

DT-5 5¼" double sided, dual density drive, ANSI compatible, 500KB unformatted capacity, 48 TPI, 35 or 40 cylinders, 70 or 80 tracks **\$279.00**
DT-8 8" double sided, dual density, IBM compatible, 1.2MB/disk capacity (IBM format), 48 TPI, 77 cylinders, 154 tracks **479.00**

SHUGART

SA400 5¼" single/dual density, 250KB capacity, 48 TPI, 40 tracks, 1 head, 10 sectors/track **215.00**
SA450 5¼" single/dual density, 500KB capacity, 48 TPI, 40 tracks, 2 heads **269.00**
SA800/801 8" single/dual density, 800KB capacity, 48 TPI, 77 tracks, 1 R/W head, 32/16/8 sectors/track **379.00**
SA850/851 8" double sided, dual density floppy drive, 1.6 MB capacity, 48 TPI, 154 tracks, 32 sectors/track **535.00**

TEAC

FD50A Single sided, 5¼" floppy disk **199.00**
FD50B Double sided, 5¼" double density, floppy disk **299.00**
FD50E 80 tracks, 96 TPI, 5¼" floppy drive **299.00**
FD50F 160 tracks, 96 TPI, 5¼" double sided, floppy drive **399.00**

TANDON DISK DRIVES

TM100-1* 5¼" single sided, 250KB unformatted capacity, 48 TPI, 40 tracks **215.00**
TM100-2* 5¼" double sided, Northstar/Cromenco/TRS-80 compatible, 500KB unformatted capacity, 48 TPI, 80 tracks **279.00**
TM100-3* 5¼" single sided, 500KB unformatted capacity, 96/100 TPI, 80 tracks **279.00**
TM100-4* 5¼" double sided, Zenith/Heath/etc. compatible, 100KB unformatted capacity, 96/100 TPI, 160 tracks **399.00**
TM848-1 Thinline 8" drive, single sided, 8MB unformatted capacity, 48 TPI, 77 tracks **499.00**
TM848-2 Thinline 8" drive, double sided, 1.6MB unformatted capacity, 48 TPI, 154 tracks **549.00**
TM602 5MB Winchester drive, 6.4MB unformatted capacity, 254 TPI, 153 cylinders, 612 tracks, 2 platters, 4 recording heads, 3600 RPM **1025.00**
TM603 10MB Winchester drive, 9.5MB unformatted capacity, 254 TPI, 153 cylinders, 918 tracks, 3 platters, 6 heads **1170.00**

*Disk Drives for IBM PC.

SPECIAL on S-100 Bus computer — YANKEE 800 S-100 Bus, Z-80 microprocessor, 4MHz crystal, complete turnkey computer \$2999.00
PDS-2300 16 bit computer, faster than any 16 bit machine, LSI 11/23 with CPU board 256KB memory, CRT terminal, DLV11-J board, power supply, two (2) 8" floppy drives with cabinet, complete turnkey system **8900.00**
PDS-300 LSI 11/23 memory, 256KB dual wide board **850.00**
PDS-400 PDP 11 memory, 256KB dual wide board **850.00**

ALL FLOPPY DRIVES & DEC MEMORIES REPAIRED AT LOW COST . . .
. . . AND QUICK TURNAROUND

FRANCHISE INQUIRIES WELCOME

Prices subject to change without notice.

PDS INC.

**PERSONAL COMPUTERS
 2630-H Walnut Ave.
 Tustin, CA 92680**

**TOLL-FREE TELEPHONE NUMBERS
 Outside California:**

(800) 854-8428

Inside California:

(714) 730-7207

(408) 257-8413

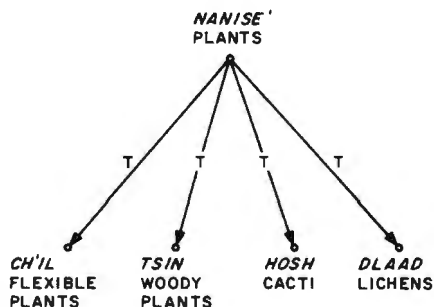

Figure 1: A folk taxonomy of Navajo plants. The "T" in each line stands for taxonomy, or class inclusion.

from Vanguard Systems in San Antonio, Texas. A short time later, our first Vector MZ, renamed APL/DTC, was delivered. It was the first microcomputer in the field in Navajo country. (I found out later that the Haute Volta Niger Resettlement Project of Purdue University nosed out our project as the world's first field microcomputer in ethnography. They used a TRS-80.)

Our first Vector MZ arrived in Kayenta, Arizona, in March 1979, where Martha A. Austin, my Navajo

coprincipal investigator, was directing the Navajo Ethno-Medical Encyclopedia Project. Using Electric Pencil II, she set out to recreate the files we had to abandon when our word-processing supplier folded. She also commenced new work.

Ethnography, Ethnoscience, and Translation

Our task was to study Navajo native medical knowledge through the Navajo language, that is, texts that Navajo native medical specialists

create when they talk about their specialty. These professionals include medicine men (though chanter is a more appropriate term), various kinds of diagnosticians (handtremblers, stargazers, listeners), and herbal specialists.

The bottom line of our so-called ethnoscience (folk knowledge) approach to ethnography is careful ethnographic translation. In literary translation, "translator's notes" are rare. Only when translators find something untranslatable, such as a play on words, will they resort to a footnote. The major characteristic of ethnographic translation is the abundance of translator's notes. Each note not only explains the dictionary meaning of a word, but places it into a cultural context as well. This procedure involves definitions obtained from Navajo consultants. We call such definitions "folk definitions" because people make them up on the spur of the moment. Our approach also involves structural information—how words are related to other words. This aspect of meaning is roughly equivalent to connotations.

A favorite structure used by ethnographers is the folk taxonomy. A taxonomy is a classification of objects, in which the names of the objects are related to each other through the relation of class inclusion (e.g., "Azee' dich'ii azee' at'e," or "Bitter medicine (pepper) is (a kind of) medicine"). Systems of such taxonomic sentences, or folk taxonomies, can be represented as tree structures. These and similar semantic structures are the major organizing principles of cultural knowledge and subdivide such knowledge into "cultural domains." Navajo folk medicine is one of several important cultural domains of Navajo culture.

An example of a Navajo folk taxonomy is given in figure 1. It is one of several possible classifications of plants by Navajo Indians.

Our ethnographic task is complex. Our interviews cover questions about structural information, for example, "What kind of medicines are there?" (asked in Navajo); folk definitions, for example, "Tell me everything you know about 'bitter medicine' (pep-

BYTEWRITER

DAISY WHEEL PRINTER LETTER QUALITY PRINTER AND TYPEWRITER IN ONE PACKAGE

The BYTEWRITER is a new Olivetti Praxis 30 electronic typewriter with a micro-processor controlled driver added internally.



\$795
plus shipping

Dealer
Inquiries
Invited

FEATURES

- Underlining • 10, 12, or 15 characters per inch switch selectable • 2nd keyboard with foreign grammar symbols switch selectable • Changeable type daisy wheel
- Centronics-compatible parallel input operates with TRS-80, Apple, Osborne, IBM and others • Cartridge ribbon • Typewriter operation with nothing to disconnect
- Service from any Olivetti dealer • Self test program built in.

BYTEWRITER

125 NORTHVIEW RD., ITHACA, N.Y. 14850
(607) 272-1132

Praxis 30 is a trademark of Olivetti Corp.
TRS-80 is a trademark of Tandy Corp.
BYTEWRITER is a trademark of Williams Laboratories.



Terms: COD, MC, Visa, Cashier's Check
Shipping charges added to all orders.

\$499

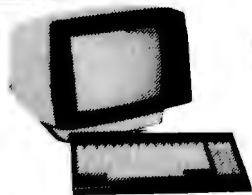

**ADDS
VIEWPOINT
TERMINAL**

8" FLOPPY DISK DRIVES

QumeTrak 8	SPECIAL	Dual-sided, the industry standard	\$475.00 qty 1
Tandon TM 848-1		Single-sided, Thinline	425.00 qty 1
TM 848-2		Dual-sided, Thinline	545.00 qty 1
Shugart 801R		Single-sided	395.00 qty 1
851R		Dual-sided	525.00 qty 1
Mitsubishi M2894-63		Dual-sided, extremely reliable (11,000 MTBF)	525.00 qty 1
Remex 2000		Single-sided	475.00 qty 1
4000		Dual-sided	575.00 qty 1

5 1/4" FLOPPY DISK DRIVES

For the IBM Personal!			
Tandon TM 100-1		Single-sided, 48TPI	245.00 qty 1
For IBM/Northstar/Cromemco			
Tandon TM 100-2		Dual-sided, 48TPI	325.00 qty 1
For Zenith/Heath SPECIAL!			
Tandon TM 100-4		Dual-sided, 96TPI	395.00 qty 1
QumeTrak 5		Dual-sided, 48TPI	395.00 qty 1
Remex PICO Drives			
RFD 480		Dual-sided, slimline, 48TPI	310.00 qty 1
RFD 960		Dual-sided, slimline, 96TPI	375.00 qty 1

ENCLOSURES WITH POWER SUPPLIES

8": Single Enclosure	195.00
5 1/4": Single Enclosure	75.00
5 1/4": Dual Enclosure	115.00

CABLES, Assembled and Tested

5 1/4": One drive	16.95
Two drives	21.95
8": One drive	19.95
Two drives	24.95

Custom-made Cables available.

5 1/4" WINCHESTER DRIVES

Seagate ST 506		6.38 Mb	1195.00 qty 1
Seagate ST 412		12.76 Mb	1295.00 qty 1
Tandon TM 602		6.4 Mb	1095.00 qty 1
Tandon TM 603		9.6 Mb	1195.00 qty 1

10MBYTE

Subsystem for Z-80/CP/M Based computers.
Completely assembled and tested. Suggested ret.

\$2695

QUANTITY DISCOUNTS AVAILABLE — DEALER INQUIRIES INVITED!

4444 SCOTTS VALLEY DR., SCOTTS VALLEY, CA 95066 (408) 438-5454

BYTE BOOKS CARRY WAITE

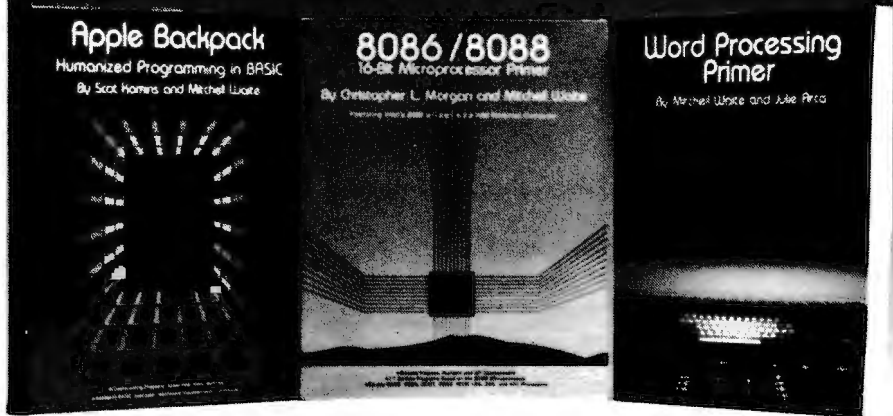

Apple Backpack: Humanized Programming in BASIC by Scot Kamins and Mitchell Waite

This clearly written tutorial guide offers programmers of Apple computers concrete methods for developing user-friendly software. Specific topics include clear screen formatting, crashproofing programs, developing built-in verifications, and writing helpful, easy-to-use documentation. Model user-friendly programs include an educational game and an office message recorder, both written in Applesoft BASIC.

ISBN 0-07-033356-4,
200 pages, softcover

\$14.95

Word Processing Primer by Mitchell Waite and Julie Arca

Covering all aspects of the increasingly popular microcomputer-based text-editing software, this book describes the equipment and programs that make word processors work, techniques for editing and formatting, and ancillary programs. The authors also tell what to look for in word-processing software and offer reviews of many popular programs.

ISBN 0-07-067761-1,
200 pages, softcover

\$14.95

8086/8088 16-bit Microprocessor Primer by Christopher L. Morgan and Mitchell Waite

This is the first book to detail the vastly powerful 16-bit microprocessors that have made possible the emerging second generation of microcomputers. In a down-to-earth style, the authors describe the design, capabilities, and potential of the new Intel 8086/8088 16-bit microprocessor. In addition, the book covers two major 16-bit coprocessors, the 8087 Numeric Data Processor and the 8089 I/O Processor. Various trial application programs are also presented, and the authors survey the current scene in 16-bit technology, reviewing software and products such as the new IBM Personal Computer (which is based on the 8088). This thorough volume is the best introduction to the microprocessors of the 80's.

ISBN 0-07-043109-4,
225 pages, softcover

\$16.95

ORDER BY MAIL OR PHONE. CALL TOLL FREE: 800-258-5420

_____ Apple Backpack: Humanized Programming in BASIC \$14.95
 _____ Word Processing Primer \$14.95
 _____ 8086/8088 16-bit Microprocessor Primer \$16.95



Add \$1.00 per book to cover postage and handling. Prepayment required.

Check enclosed in the amount of \$_____

VISA MC # _____ Exp. _____

Name _____

City _____

Address _____

State _____ Zip _____

per); and texts, which may involve descriptions of the preparation of medicines, descriptions of procedures, for example in childbirth, or folk-theoretical descriptions that explain why some procedure, ceremony, or remedy works, how medical decisions are made, and so forth. Our texts also contain philosophical essays, usually passages from the rich body of Navajo mythology, and comments on the myths about health, disease, life, and death.

**With the Osborne 1,
perhaps the
two-computer
ethnographer has
become possible.**

Regardless of the particular form, we call all these different kinds of data "texts." This is where keywords become important. We search texts for particular keywords and bring the occurrences of these words together in one "file." Each such file may be viewed as an encyclopedia entry that exemplifies the use of the word in the Navajo language and in its Navajo cultural context.

Current Work

In our plan, the WORDINDEX program written in APL/V80 is applied to all texts. It provides each word with a running number, prints each text in columnar form, alphabetizes the entire text, and prints the alphabetization in columnar form. This index serves as a check on the occurrence of every word. Its completeness makes certain that no word is missed.

The next step is locating the occurrences through the string-search capability of Electric Pencil. We could not use the string search alone because before the WORDINDEX printouts, we often did not know in advance which words were worth exploring further.

A multiwindow editing program like Electric Blackboard from Santa Cruz Software Service is our latest ac-



Proven tools for programmers. From Microsoft.

Old friends. Eight years ago, Microsoft put BASIC on the first microcomputer. Today, there are more than 1,000,000 copies of Microsoft™ languages in use. BASIC interpreter. BASIC compiler. FORTRAN, and COBOL. A proven set of programming tools. All, fully supported by Microsoft.

The best get better. Good tools work better if you keep them sharp. That's why we constantly improve the tools we offer. Enhancing them. Increasing their utility. Taking full advantage of the strengths of each language. Supporting you, the user, with a full range of finely honed programming tools.

Technical support. When you buy our tools, you get our number. If you have technical problems, call the Microsoft support staff for assistance. If we don't have the answers now, we'll find them and call you back.

Compatible documentation. All Microsoft languages share a common approach to documentation. Starting with plain English. That means that even when you're learning a new language, you won't have to learn a new vocabulary.

Linkable code. All Microsoft compilers share common utilities. A linker accompanies each

compiler. That means you can write programs in two or more languages, taking advantage of the specific strengths of each, then, link and run them as a single program.

Leadership in micros. Nobody gave us leadership. We earned it through innovation, enhanced programming tools and complete user support. Today, Microsoft is the only software supplier to offer you a complete programming environment. Including specialized languages that support you in a wide variety of programming situations. Tomorrow, you can look to Microsoft to make that environment even more productive.

Better tools. Ask your Microsoft dealer about Microsoft's family of proven tools for programmers: BASIC interpreter, BASIC compiler, FORTRAN and COBOL. Each is a specialized tool for a special programming problem. Better tools. And better tools make better programs.



BETTER TOOLS FOR MICROCOMPUTERS

MICROSOFT

Microsoft Corporation
10700 Northup Way
Bellevue, WA 98004

Microsoft is a trademark of Microsoft Corporation.

McGraw-Hill Bookstore

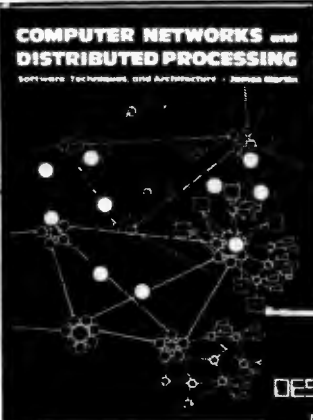

*The man generally acknowledged to be the computer industry's most widely read author, best attended lecturer, and foremost authority on the social and commercial impact of computers – **Computer World***

*Undisputedly the best-selling author in the field of computing – **Computing***

*The Gospel in the field – **Computer Decisions***

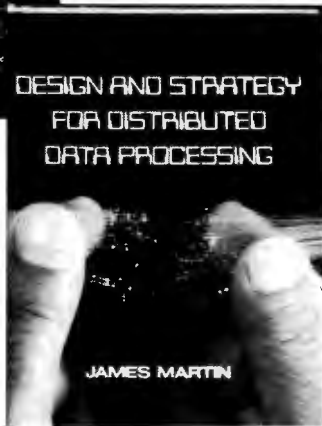

**James
Martin
Books**

published by Prentice-Hall

1. **Computer Networks and Distributed Processing** Choices to make in designing far-reaching systems. 562 pp. \$34.00
2. **Design and Strategy for Distributed Data Processing** Distributed processing for management. 624 pp. \$37.50
3. **The Telematic Society** Mandatory reading in Britain, from the world's foremost systems writer. 350 pp. \$12.95
4. **An End-User's Guide to Data-Base** What users need to know to profit from data-base systems. 144 pp. \$21.95
5. **Application Development Without Programmers** Fundamental changes in applications development! 350 pp. \$32.50
6. **Design of Real-Time Computer Systems** 629 pp. \$24.95
7. **Computer Data-Base Organization, 2nd ed.** 713 pp. \$33.00
8. **Systems Analysis for Data Transmission** 910 pp. \$39.95
9. **Communications Satellite Systems** 398 pp. \$39.50
10. **Principles of Data-Base Management** 352 pp. \$23.95
11. **Teleprocessing Network Organization** 290 pp. \$17.95
12. **The Computerized Society** 560 pp. \$18.95
13. **Future Developments in Telecommunications, 2nd ed.** 668 pp. \$37.00
14. **Telecommunications and the Computer** 670 pp. \$37.50
15. **Design of Man-Computer Dialogues** 559 pp. \$32.00
16. **Programming Real-Time Computer Systems** 386 pp. \$19.95
17. **Security, Accuracy and Privacy in Computer Systems** 626 pp. \$34.00
18. **Introduction to Teleprocessing** 266 pp. \$22.95



quisition to facilitate analysis. We are still experimenting with this new tool. It allows simultaneous viewing of text and the analysis file, which may contain the dictionary or encyclopedic entry for a particular word or phrase, a taxonomic tree relevant to the text, or some other structures and texts, for example, case material (descriptions of episodes) that may also be relevant to the analysis of the text. The multiple windows enhance our ability to update several files almost simultaneously. Although the Electric Blackboard is very new, it seems to be to text analysis what Visicalc is to the analysis of numerical tables. Without exaggeration, Electric Blackboard is a product that ethnographers have been waiting for.

With the help of Electric Blackboard, we should be able to move sentences and other materials from a text file to a particular dictionary or encyclopedic file and edit both files almost simultaneously.

ALFORDER

The first word-indexing program I used on our APL/DTC (modified Vector MZ) was ALFORDER. Its first version for APL/PLUS was written by Bernard Werner of Waterford, Pennsylvania. Jeff Multach, a Northwestern University APL guru, helped adapt it to APL/V80. Our APL/V80 is a simplified version of mainframe APLs. Functions defined for arrays are often defined only for vectors. Because of the smallness of the work space (35K bytes), we opted for space-saving loops over elegant but space-consuming functions. The ALFORDER program is given in listing 1.

Before discussing the ALFORDER program in detail, see figure 2, a block diagram that shows how the various APL functions are interrelated.

First is the overall program ALFORDER. The input to ALFORDER is a text (character string with blanks delimiting words); the output is a Key Word In Context concordance placing each word into a context of 120 characters.

Within ALFORDER are the other program modules, or APL functions, that make up the rest of the program.

McGraw-Hill Bookstore

1221 Ave. of the Americas, N.Y., N.Y. 10020

Please send me _____ copies of book no. _____
 _____ copies of book no. _____
 _____ copies of book no. _____ BY7
 _____ copies of book no. _____

Check or credit card:

AmerExp. MasterCard Visa

Acct. No. _____ Expires _____

Name _____

Address _____

City _____ State _____ Zip _____

Add local sales tax plus \$2.50 postage and handling for the first book, \$1.00 for each additional book.





The \$1100 scope. Only Tektronix could make so much performance so affordable!

The 60 MHz Tek 2213 and 2215 introduce a scope design so radically different, it delivers full-range performance at prices well below what was ever possible before.

Not surprisingly, it is from Tektronix, the world's largest and most respected scope manufacturer, and a legend for instrument reliability and value.

Design for the 2213 (\$1100) and dual time base 2215 (just \$1400) includes some 65% fewer mechanical parts. Fewer circuit boards. Fewer electrical connectors and cabling. Result: a lower purchase price for you plus far greater reliability.

Performance is pure Tektronix: there's the

bandwidth for digital and high-speed analog circuits. The sensitivity for low signal measurements. The sweep speeds for fast logic families. A complete trigger system for digital, analog or video waveforms. And, with the 2215, you get fully calibrated delayed sweep for fast accurate timing measurements. New high-performance 10X Tektronix probes are included!

2213/2215 PERFORMANCE DATA

Bandwidth: Two channels, dc—60 MHz from 10 V/div to 20 mV/div (50 MHz from 2 mV/div to 10 mV/div)

Sweep speeds: Sweeps from 0.5 s to 50 ns (to 5 ns/div with X10 mag)

Sensitivity: Scale factors from 100 V/div (10X probe)

to 2 mV/div (1X probe). Accurate to $\pm 3\%$. Ac or dc coupling.

Delayed sweep measurements: 2213: standard sweep, intensified after delay, and delayed. 2215: A only, B only, or A and B alternately with A intensified by B.

Complete trigger system: Modes include TV field, normal, vertical mode, and automatic; internal, external, and line sources; variable holdoff; separate B sweep trigger on 2215

Probes: High performance positive attachment, 10-14 pF and 60 MHz at the probe tip

The price: Just \$1100 for the 2213 and \$1400 for the dual time base 2215*. Order direct from the

Tektronix National Marketing Center, your hotline for the 2200 Series and all Tektronix accessories.

Phones are staffed by sales engineers who can answer your technical questions.

Your direct order includes a 15-day return policy and full Tektronix warranty. Call today. You can't buy a more advanced scope for less.

**ORDER TOLL FREE
800-547-1845**

Ask for Department D0327 (In Oregon, Alaska and Hawaii: 1-503-627-5402 collect.) Lines are open from 8 am EST to 5 pm PST.

*Price for 2215 with 10X probe.

Tektronix
COMMITTED TO EXCELLENCE

largest and most respected scope manufacturer, and a legend for instrument reliability and value.

brated delayed sweep for fast accurate timing measurements. New high-performance 10X Tektronix

by B

Complete trigger system: Modes include TV field.

full Tektronix warranty. Call today. You can't buy a more advanced scope for less.

MTI stocks 'em all for faster delivery.

Ask about our "QED" discounts.
VISA and MasterCard orders accepted.

VIDEO TERMINALS	MTI Price
VT100 DECscope	\$ 1595
VT18X Computing option	2395
VT101 DECscope	1215
VT131 DECscope	1785
VT132 DECscope	1995
ADM 3A (dumb terminal)	595
ADM 5 (dumb with visual attributes)	645
ADM 31 (two page buffer)	1095
ADM 21, 24, 32, 36, 42	*
Hazeltine Esprit	645
Hazeltine Executive 80 Model 20	1495
Hazeltine Executive 80 Model 30	1715
1410 (Hazeltine dumb terminal)	575
1421 (Consul 580 & ADM 3A comp.)	595
1500 (dumb terminal)	825
1520 (buffered, printer port)	1105

RETRO-GRAPHICS TERMINALS	Price
VT100 with graphics pkg.	3250
VT125 (DEC graphics)	3280
ADM 3A with graphics pkg.	1795
ADM 5 with graphics pkg.	1845

300 BAUD TELEPRINTERS	Price
LA 34-AA DECwriter IV	1095
LA 35 DECwriter II	1095
Diablo 830 RO	2295
Diablo 830 KSR	2695
Diablo 1650 KSR	2635
TI 743 (portable)	1190
TI 745 (port/built-in coupler)	1485
TI 765 (port/bubble/b.i. coupler)	2595

600 BAUD TELEPRINTERS	Price
Epson MX-80	645
TI 825 KSR impact	1570
TI 825 KSR pkg.	1795

1200 BAUD TELEPRINTERS	Price
Epson MX-100	995
LA 120 RA (receive only)	2095
LA 120 AA DECwriter III	2295
TI 783 (portable)	1645
TI 785 (port/built-in coupler)	2270
TI 787 (port/internal modem)	2595
TI 810 RO impact	1545
TI 810 RO pkg.	1795
TI 820 RO impact	1850
TI 820 RO pkg.	2025
TI 820 KSR impact	2025
TI 820 KSR pkg.	2195
Lear Siegler 310 ballistic	1945

2400 BAUD	Price
Dataproducts M200 (2400 baud)	2910

DATAPRODUCTS LINE PRINTERS	Price
B300 (300 LPM band)	5455
B600 (600 LPM band)	6930
B1000 (1000 LPM band)	11330
BP1500 (1500 LPM band)	19700

ACOUSTIC COUPLERS	Price
A/J A242-A (300 baud orig.)	242
A/J 247 (300 baud orig.)	315
Vadic VA 3413 (300/1200 orig.)	845
Vadic VA 3434 (1200 baud orig.)	845

MODEMS	Price
GDC 103A3 (300 baud Bell)	395
GDC 2025/T (1200 baud Bell)	565
VA 3212 (Bell 212A comp.)	825
VA 103 (300 baud modem/phone)	235
VA 3451 (orig/ans triple modem)	885
VA 3455 (1200 baud orig/ans.)	770
VA 2450 (Bell 201 comp.)	725

CASSETTE STORAGE SYSTEMS	Price
Techtran 816 (store/forward)	735
Techtran 817 (store/for/speed up)	915
Techtran 818 (editing)	1225
Techtran 822 (dual)	1640

FLOPPY DISK SYSTEMS	Price
Techtran 950 (store/forward)	1395
Techtran 951 (editing)	1995

* Please call for quote.



Applications Specialists & Distributors
Computer Terminals, Peripherals & Systems

New York:
516/621-6200, 212/767-0677, 518/449-5959
Outside N.Y.S.: 800/645-6530
New Jersey: 201/227-5552
Ohio: 216/464-6688

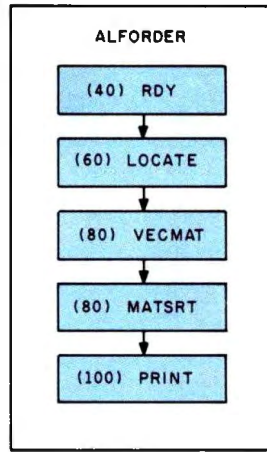

Figure 2: A block diagram of the ALFORDER program shown in listing 1.

The first of these functions is RDY. It eliminates unnecessary blanks, marking the beginning of each word, including the first, with one blank character.

The LOCATE program finds word beginnings. Its input is the reduced text; its output consists of the index numbers of word ends.

The next APL function is VECMAT. Its input is the indexes of word ends; its output is a matrix. This is a more elegant and faster version of the ERECT program in Dave Macklin's *The APL Handbook of Techniques*, published by IBM (1977, page 7). It converts a character string or vector into a matrix. The columns of this matrix correspond to the number of letters of the longest word in the text. It has as many rows as there are words in the text.

MATSRT sorts the matrix that is the output of VECMAT. The output of MATSRT is a vector of index numbers of the word beginnings in alphabetical order.

Finally, the PRINT function applies the locations of word beginnings to the original text. The resulting output is a line 120 characters wide with five blanks preceding each keyword on the center of the page. The function computes each line in alphabetical order and prints it when complete. It then goes on to the next line. Therefore, the concorded text exists only as a printout. (No record of it is saved.)

In an APL/DTC work space of about 35K bytes, this program oc-

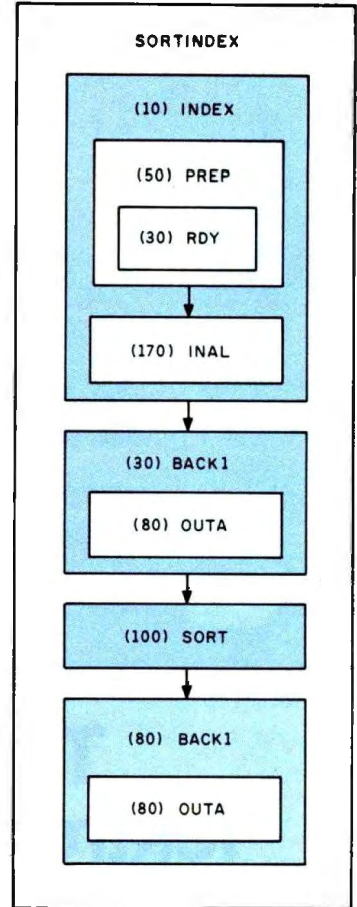

Figure 3: A block diagram of the SORTINDEX program shown in listing 2.

cupies about 10K. That leaves about 25K for the work of creating the index. The limit lies somewhere between 300-500 words, which is not too practical. A version is needed that would prepare part of the text, store it on disk, sort the next part, and so on, until the entire text is processed.

In spite of the elegance of ALFORDER, it is not practical for the processing of large texts on a micro-computer. A practical text of about 5000 words requires 20 times 5000 words, or a total of 100,000 words to be printed. It takes about an hour to print 5000 words on my Qume Sprint 5. Twenty times that much would take a minimum of 20 hours. It is obviously not practical to print such a large document on a slow printer.

SORTINDEX

My first attempt to work around the problems of ALFORDER was the SORTINDEX program (see listing 2).

THE FORTH SOURCE™



FORTH DISKS WITH DOCUMENTATION

- fig-FORTH Model and Source Listing, with printed Installation Manual and Source Listing.
- | | | |
|--|---|--------------|
| <input type="checkbox"/> APPLE II, 5 1/4 | <input type="checkbox"/> 8080/Z80*, 8 | PRICE |
| <input type="checkbox"/> 8086/8088, 8 | <input type="checkbox"/> H89/Z89, 5 1/4 | |
- APPLE II/II+** by MicroMotion. Version 2. FORTH-79 Standard, editor, assembler, 200 pg manual, 5 1/4 100.00
 - APPLE II/II+ COMBO 1** by MicroMotion. Version 2. All of the above plus floating point and HiRes Turtle graphics, 5 1/4 140.00
 - APPLE II** by Kuntze. fig-FORTH editor, assembler, source listing and screens, 5 1/4 90.00
 - ATARI*** by Pink Noise Studio. fig-FORTH, editor, assembler, missile graphics, sound and handle drivers, 5 1/4 90.00
 - CP/M** by MicroMotion. Version 2.x. FORTH-79 Standard, editor, assembler 200 pg manual, 8, 5 1/4 100.00
 - CP/M Combo 1** by MicroMotion. 2.x. All of the above plus floating point, 8 or 5 1/4 140.00
 - CROMEMCO*** by Inner Access fig-FORTH editor, assembler, 5 1/4 or 8 100.00
 - H89/Z89** by Haydon. fig-FORTH Stand Alone, source, editor, assembler & tutorial on disk. 5 1/4 250.00
 - H89/Z89** by Haydon. fig-FORTH, CP/M*, source, editor, assembler, & tutorial on disk, 5 1/4 175.00
 - HP-85** by Lange fig-FORTH, editor & assembler, 5 1/4 90.00
 - IBM* PC/FORTH** by Laboratory Microsystems. fig-FORTH, editor and assembler. Manual, 5 1/4 100.00
 - IBM-Floating Point** by Laboratory Microsystems. Requires PC/FORTH. Specify software or for AMD 9511, AMD 9512 or Intel 8087, 5 1/4 100.00
 - PET*** by FSS. fig-FORTH editor & assembler, 5 1/4 90.00
 - PET*** with floating point, strings, disk I/O, 5 1/4 150.00
 - TRS-80/1** by Nautilus Systems. fig-FORTH, editor and assembler, 5 1/4 90.00
 - TRS-80/1 or III** by Miller Microcomputer Services. MMSFORTH, FORTH-79 subset, editor, assembler, dbl-precision, arrays, utilities & applications. 210 pg. manual, 5 1/4 130.00
 - 6800** by Talbot Microsystems. fig-FORTH, editor, assembler, disk I/O, FLEX* 5 1/4 or 8 100.00
 - 6809** by Talbot Microsystems. fig-FORTH, editor, assembler, disk I/O, FLEX* 5 1/4 or 8 100.00
 - 6809 Enhanced** 2nd screen editor, tutorial, tools and utilities, macroassembler, FLEX, 8 or 5 1/4 250.00
 - Z80** by Laboratory Microsystems. Editor and assembler, CP/M, 8 50.00
 - Z80, floating point, requires Z80 above, 8 150.00
 - Z80, AMD 9511 support, requires Z80 above, 8 150.00
 - 8086/88** by Laboratory Microsystems. Editor, assembler, CP/M-86*, 8 100.00
 - 8086/88 with floating point, CP/M-86, 8 200.00
 - 8086/88 with AMD 9511 support CP/M-86, 8 200.00

CROSS COMPILER DISKS

Allows extending, modifying and compiling for speed and memory savings, can also produce ROMable code.

- | | |
|---|---------------------------------------|
| <input type="checkbox"/> CP/M 200.00 | <input type="checkbox"/> IBM* 300.00 |
| <input type="checkbox"/> H89/Z89 200.00 | <input type="checkbox"/> 8086* 300.00 |
| <input type="checkbox"/> TRS80/1 200.00 | <input type="checkbox"/> Z80* 200.00 |
| <input type="checkbox"/> Northstar 200.00 | <input type="checkbox"/> 6809 350.00 |

* Requires FORTH disk

MVP-FORTH PRODUCTS

- MVP-FORTH** is a public domain product which contains a FORTH kernal, FORTH-79 Standard Required Word Set, vocabulary for STARTING FORTH, editor, assembler and utilities.
- MVP-FORTH Programmer's Kit** including disk with documentation, ALL ABOUT FORTH, and STARTING FORTH (specify computer) **\$100.00**
- MVP-FORTH Disk** with documentation (specify computer) 75.00
- ALL ABOUT FORTH** by Haydon. A complete annotated glossary of FORTH with latest functional definitions implementations, examples, and discussion of common dialects. 230 pp. 20.00
- MVP-FORTH Cross Compiler Disk** and documentation (Specify computer) 200.00
- MVP-FORTH Programming Aids.** Disk and manual, decompiler, subroutine decompiler, callfinder and translator. (Specify computer) 150.00

FORTH MANUALS, GUIDES, & DOCUMENTS

- "FORTH Encyclopedia"** by Baker and Derick. A complete programmer's manual to fig-FORTH with FORTH-79 references. Flow Charted 25.00
- "Starting FORTH"** by Brodie. Prentice Hall. Best user's manual available. (soft cover) 16.00
- "Starting FORTH"** (hard cover) 20.00
- "METAFORTH"** by Cassidy. Cross compiler with 8080 code. 30.00

Proceedings of Technical Conferences

- "1980 FORML"** (FORTH Modification Laboratory) 25.00
- "1981 FORML"** Two Volume Set 40.00
- "1981 Rochester University"** 25.00

- | | |
|---|--|
| <input type="checkbox"/> "Systems Guide to fig-FORTH" 25.00 | <input type="checkbox"/> "APPLE" (MicroMotion) User's Manual" 20.00 |
| <input type="checkbox"/> "Using FORTH" 25.00 | <input type="checkbox"/> "CP/M" (MicroMotion) User's Manual" 20.00 |
| <input type="checkbox"/> "A FORTH Primer" 25.00 | <input type="checkbox"/> "TRS-80" MMSFORTH User's Manual" 18.50 |
| <input type="checkbox"/> "Caltech FORTH Manual" 12.00 | <input type="checkbox"/> "FORTH-79 Standard" 15.00 |
| <input type="checkbox"/> "Threaded Interpretive Languages" 20.00 | <input type="checkbox"/> "Tiny Pascal in fig-FORTH" 10.00 |
| <input type="checkbox"/> "Invitation to FORTH" 20.00 | <input type="checkbox"/> "FORTH-79 Standard Conversion" 10.00 |
| <input type="checkbox"/> "PDP-11 FORTH User's Manual" 20.00 | |
| <input type="checkbox"/> "AIM FORTH User's Manual" 12.00 | |

INSTALLATION DOCUMENTS

- Installation Manual for fig-FORTH**, contains FORTH model, glossary, memory map, and instructions **\$15.00**
- Source Listings of fig-FORTH**, for specific CPU's and computers. The above installation manual is required for implementation. Each 15.00

- | | | | |
|-------------------------------|----------------------------------|-------------------------------|--|
| <input type="checkbox"/> 1802 | <input type="checkbox"/> 6502 | <input type="checkbox"/> 6800 | <input type="checkbox"/> AlphaMicro |
| <input type="checkbox"/> 8080 | <input type="checkbox"/> 8086/88 | <input type="checkbox"/> 9900 | <input type="checkbox"/> APPLE II* |
| <input type="checkbox"/> PACE | <input type="checkbox"/> 6809 | <input type="checkbox"/> NOVA | <input type="checkbox"/> PDP-11/LSI/11 |

ORDERS ONLY (415) 961-4103

DEALER & AUTHOR INQUIRIES INVITED

Ordering Information: Check, Money Order (payable to MOUNTAIN VIEW PRESS, INC.), VISA, MasterCard or COD's accepted. No billing or unpaid PO's. California residents add sales tax. Shipping costs in US included in price. Foreign orders, pay in US funds on US bank, include for handling and shipping by Air: \$5.00 for each item under \$25.00, \$10.00 for each item between \$25.00 and \$99.00 and \$20.00 for each item over \$100.00. Minimum order \$10.00. All prices and products subject to change or withdrawal without notice. Single system and/or single user license agreement required on some products.

Specializing in the FORTH Language
MOUNTAIN VIEW PRESS, INC.

PO BOX 4656

MOUNTAIN VIEW, CA 94040

(415) 961-4103

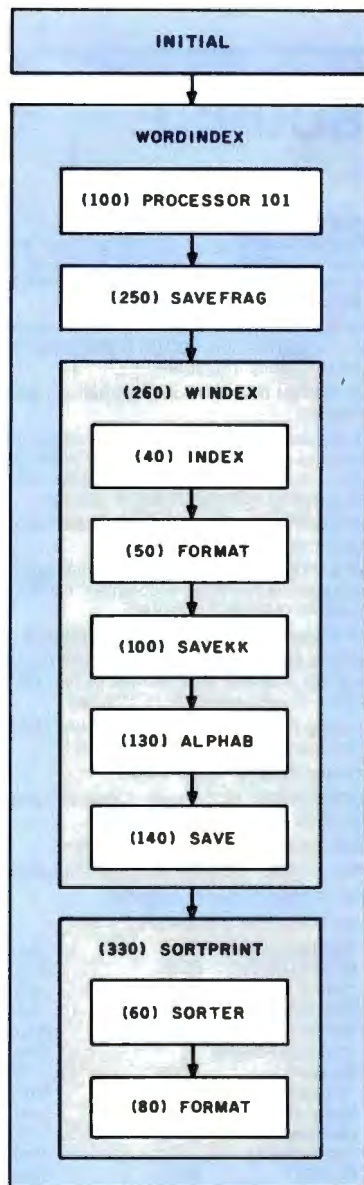

Figure 4: A block diagram of the WORDINDEX program shown in listing 3.

Figure 3 shows the block diagram of this program.

The main program is SORTINDEX. The input to this program is a text with words delimited by spaces. The output comes in two parts: (1) the text arranged in an 18-character column, showing the text in sequential order from top to bottom, with each word having its own index number, and (2) the same list fully alphabetized.

Within SORTINDEX are other APL functions that accomplish this complex task. The basic philosophy of this set of programs, however, is

different from ALFORDER. Not only does every word receive an index number, each 6 characters of a word (up to a total of 12) are also converted into a unique 10-digit integer. This is the decimal representation of a word viewed as a number in base 47 (the actual alphabet includes a blank, A-Z, 0-9, and , . ; : ? - _ = + '—in Navajo texts, 7 and 8 represent the symbols for high tone and nasalization, respectively).

The conversion to integers results in two 10-digit numbers: the first for the first six letters, the second for the next six. Longer words are truncated,

but the full forms are usually completely predictable.

The INDEX subprogram takes the prepared texts and outputs a three-column matrix. The first column contains the first integers standing for the first six letters, the second takes the next six letters, and the third column contains the index numbers. The matrix has N rows, where N is the number of words in the entire text. The subfunctions PREP and RDY get the text ready for conversion. The INAL function is the one that actually converts character strings into unique integers.

The BACK1 function takes the matrix output of INDEX and reconverts it into character strings with their index numbers. It is this conversion program (actually the OUTA function within it) that reconverts each row of two integers into a character string of six letters each and an index number.

The SORT function takes the matrix output of INDEX and arranges it alphabetically in two sorts (the integer of the second six letters first, and then the first integer). The BACK1 and OUTA functions convert the integers of the matrix into the final alphabetized columnar matrix.

WORDINDEX

I have written two versions of the WORDINDEX program. The first is an expanded version of SORTINDEX. It includes disk operations that enable it to handle texts of up to 5000 words. Every 6 characters are converted to a unique 10-digit integer. Because of the relative slowness of the conversion programs INAL and OUTA, I wrote a somewhat faster program by avoiding the conversion of character strings to integers. The WORDINDEX program shown in listing 3 uses only character strings. The upsort and downsort functions are relatively fast in APL/DTC, and some timesaving is possible, even though 12 sorts are needed instead of the two in SORTINDEX. Figure 4 shows the block diagram of WORDINDEX.

In WORDINDEX, the disk files must be set up first on one blank disk. These include an Electric Pencil file

THE GREAT COMPUTER COVER-UP HAS BEGUN.



Have fun with your computer terminal. Make a statement with your personal computer, word processor, even your electric typewriter.

Because now you can cover them all up with Toppers, the hottest fad in dust covers since the color gray.

Toppers come with a choice of expressions—just like T-shirts—so you can tell the world how you feel about yourself and your job. Any of the expressions in the coupon below are available on any of the covers, with all lettering applied by a high-quality silk-screening process.

And you can choose from three beautiful colors: Whole Wheat Natural, Better Dead than Red, and Out-of-the Blue. So you not only express yourself and make people laugh, you also make your working environment a more attractive place. **Someone you know deserves one.** Toppers make a perfect gift. If you think hard, you'll think of someone who deserves one. We have nasty ones for your boss. Sweet ones for your secretary. Slightly wild ones for your friends. Check the list.

Tell your boss it's a business expense. If you need an excuse for filling out a petty cash slip, we'll give you several.

Toppers are made of deluxe, 100% natural cotton sailcloth, carefully sewn to

custom-fit most terminals and electric typewriters. They're also color-fast, completely washable, and they even keep the dust off to protect your valuable equipment.

Best of all, they cost only \$13.95, which is about what you'd pay for an ordinary, boring, plastic dust cover. **Join our cover-up operation and win \$25!** Do you have a special expression you'd like to see offered? Then send it to us on a postcard or piece of paper. If we use it, and you're the first to send it in, we'll pay you \$25. (No purchase necessary. One winner per expression, or variation, only. Our judgement, exclusively. Payment to anybody constitutes full discharge of obligation. Void where prohibited by law.) Send in as many as you like but one per postcard or piece of paper, please.

Order now and start a new fad in your office. If you order now, you can be the first person in your place of work to own a Topper. For only \$13.95, how can you go wrong? We'll even refund your money if you're not completely satisfied.

Just call our toll-free number and use your MasterCard or VISA. Or fill in the coupon, indicating your choice of expression and color, and your terminal or typewriter model. To order more than one, fill out the same information on a separate sheet of paper. Please allow three weeks for delivery.

To order call toll free:

800-543-3000

In Ohio: 1-800-582-1364 Operator #244

Yes! Send me a Topper. I have checked the appropriate boxes for expression, color, and equipment
 I have enclosed a check or money order for \$14.95 (\$13.95 plus \$1.00 shipping/handling Massachusetts orders add 5% sales tax)
 I have indicated my credit card account number

Expressions

- | | |
|---|--|
| A. <input type="checkbox"/> Mafia Machine Hands Off | K. <input type="checkbox"/> Women Without Men are like Fish Without Bicycles |
| B. <input type="checkbox"/> This machine EXPLODES on Contact. DO NOT TOUCH. | L. <input type="checkbox"/> Doing it the Old Fashioned Way—by the Numbers |
| C. <input type="checkbox"/> I Love My Wang. | M. <input type="checkbox"/> No Nukes |
| D. <input type="checkbox"/> Touching the Right Button Turns Me On | N. <input type="checkbox"/> The User of This Machine is INDISPENSABLE. |
| E. <input type="checkbox"/> An Apple, Run by a Peach | O. <input type="checkbox"/> GIGO Processor Garbage in—Garbage out |
| F. <input type="checkbox"/> I Break for Animals. | P. <input type="checkbox"/> Word Processors are for Lovers |
| G. <input type="checkbox"/> Only Angels Have Wings. | Q. <input type="checkbox"/> Some day, I May Be In Charge |
| H. <input type="checkbox"/> I Love My IBM. | R. <input type="checkbox"/> Everybody Makes Mistakes |
| I. <input type="checkbox"/> Programmers Do It Byte by Byte. | S. <input type="checkbox"/> I'd Rather Be Sailing |
| J. <input type="checkbox"/> I'm Trying Hard. I Wish You'd Notice | T. <input type="checkbox"/> Secretaries Have Feelings Just Like People |

Colors
 Whole Wheat NATURAL Better Dead than RED
 Out-of-the BLUE

Equipment

- | | |
|---|--|
| Computer Terminals | 14. <input type="checkbox"/> IBM Electronic Typewriters Mod 50, 60, 75 (specify 15" or 19" carriage) |
| 1. <input type="checkbox"/> IBM 3276, 3277, 3278 | 15. <input type="checkbox"/> IBM Display-writer |
| 2. <input type="checkbox"/> IBM 3101 | 16. <input type="checkbox"/> CPT 6000, 6100 |
| 3. <input type="checkbox"/> IBM 5251 | 17. <input type="checkbox"/> CPT 8000, 8100 |
| 4. <input type="checkbox"/> DEC VT-100 Series | 18. <input type="checkbox"/> Lanier LTE-3 |
| 5. <input type="checkbox"/> Lear Siegler ADM 3, 3A, 5, 21, 31 | 19. <input type="checkbox"/> No Problem |
| 6. <input type="checkbox"/> Lear Siegler ADM 32, 36 | 20. <input type="checkbox"/> NBI OASys 3000, 3000S, Docuwriter Series |
| 7. <input type="checkbox"/> ADDS Regent 20, 25, 40, 60 | 21. <input type="checkbox"/> WANG WPS/OIS |
| 8. <input type="checkbox"/> ADDS Regent 100, 200, 300 | 22. <input type="checkbox"/> WANG Wangwriter |
| 9. <input type="checkbox"/> Televideo 910, 912, 920 | 23. <input type="checkbox"/> Apple II (no CRT) |
| 10. <input type="checkbox"/> Televideo 925, 950 | 24. <input type="checkbox"/> Apple III |
| 11. <input type="checkbox"/> Wang 2200, VS Series | 25. <input type="checkbox"/> IBM Personal Computer |
| Word Processors, Typewriters | 26. <input type="checkbox"/> Radio Shack TRS-80 Mod II |
| 12. <input type="checkbox"/> IBM Selectric II (15" carriage) | 27. <input type="checkbox"/> Radio Shack TRS-80 Mod III |
| 13. <input type="checkbox"/> IBM Selectric III (15" carriage) | AD code: 07BY |

Name _____

Address _____

City _____ State _____ Zip _____

MasterCard VISA

Card Number _____ Expiration Date _____

Signature _____ Date _____

TOPPERS
 175 Bedford Street, Lexington, MA 02173

containing the original text, 20 files for the indexed text, and 26 files for the alphabetized text. The PCL (Electric Pencil) file is PIPed (run through the CP/M peripheral interchange program) on the disk with the option that eliminates all uppercase letters. The rest is accomplished by the INITIAL program, which sets up the files on disk that are necessary to handle texts of up to 5000 words.

For the disk-file operations, I could have used defined APL functions written by Vanguard Systems. These emulate the filing system of APL/PLUS, developed by Scientific Time Sharing. However, these func-

tions take up room in the work space. Since the system functions)CSAVE and)COPY do not take up room, I used them instead. The loss of speed with the relatively large partial texts that are moved to and from disk seems minimal. By using these systems functions, I can process 250 or more words per work space per iteration. This number is not completely arbitrary. I set it so that the columnar printout covers one 11- by 14-inch page.

The actual work of indexing each word and sorting the result takes place within the WORDINDEX program. This program is unusually

large for APL because of the inclusion of Processor 101, which converts CP/M files to APL format. Once control leaves the function in which it is embedded, iteration cannot be resumed. Therefore, all WORDINDEX subfunctions must remain within the main WORDINDEX program.

After you type WORDINDEX, the program requests the name of a file (usually a PCL file) that is to be converted into APL-readable form. Processor 101 does the conversion one record (or 128 characters) at a time. The process is set (on line [270] in the WORDINDEX function, listing 3) for 10 cycles, or a total of 1280 characters

For The Best In Price, Selection and Delivery,

**Call Now TOLL FREE
800-368-3404**

(In VA, Call Collect 703-237-8695)

**AMPEX • INTERTEC • TEXAS INSTRUMENTS • GENERAL DATA
COMM. • ANDERSON JACOBSON • C. ITOH • QUME • BEEHIVE •
DATASOUTH • DIABLO • CENTRONICS • NEC • PRENTICE**

SUPERBRAIN MICROS

INTERTEC:

64K DD **ONLY \$1975**
64K QD **ONLY \$2350**
64K SD (96TPI) ... **ONLY \$2750**
DDS-10 Meg
(Hard Disk) **ONLY \$3195**

PRINTERS

DATASOUTH: Call
NEC:
7710 \$2196
7715 Call for Special Price
7730 \$2196
7720 Call for Special Price
7725 Call for Special Price
Std. Forms Tractor \$ 200
3510 \$1690
3550 for IBM P.C. Call
DIABLO: 630-R102 RO .. \$1995
QUME:
Sprint 5, 55RO \$2339
Sprint 9, 45RO,
Limited Panel \$1845
Full Panel \$1969
Sprint 9,55RO,Ltd. Ex.Mem. \$2095
Bi-Dir. Forms Tractor \$ 199

CENTRONICS:

739-1 (Parallel) \$ 568
739-3 (Serial) Call for Special Price

TERMINALS

AMPEX:

Dialogue 30 \$ 775
Dialogue 80 \$ 939

BEEHIVE: (SMART DISPLAY)

DM5 Call
DM5A Call
DM310 (3101 Emulator) Call

NOTE: IBM and Burroughs compatible terminals available. Please inquire.

C. ITOH

CIT 101 \$1350

TEXAS INSTRUMENTS:

745 Standard \$1390
745 Std. (Reconditioned) ... Call
810 Basic \$1249
810 Package \$1439
820 Package RO Package . \$1610
820 RSR Package Call
840 RO Basic \$ 795
840 RO Tractor Feed Pkg. . \$1059

COUPLERS

STAR: 300 Baud \$ 124

Special! While They Last!

SOROC TERMINALS

IQ 120 **ONLY \$625** ~~\$ 675~~
IQ 130 **ONLY \$525** ~~\$ 575~~
IQ 135 **ONLY \$659** ~~\$ 709~~
IQ 140 **ONLY \$989** ~~\$1089~~

DISC DRIVES

QUME:

Data Trak 5 ... \$325 or 2 for \$599
Data Trak 8 ... \$549 or 2 for \$1049

SOFTWARE

BISYNC-80 RJE \$ 769
Wordstar \$ 319
Data Star \$ 215
Cobol \$ 789
Forms 2 (Cobol Gen.) \$ 179
Mail Merge \$ 99
Spell Guard \$ 229
Plan 80 \$ 249
Super Calc \$ 249
Milestone \$ 249
Wordstar (IBM P.C.) \$ 319
Mail Merge (IBM P.C.) ... \$ 99

In addition, we can make EIA RS232 or RS449 cables to your order, and supply you with ribbons, printer stands, print wheels, thimbles for all printers listed. And many, many more items. CALL NOW.

All items shipped freight collect either motor freight or UPS unless otherwise specified. VISA and MasterCard welcomed; add 3% for credit card purchases. Virginia residents, add 4% Sales Tax. For fastest delivery, send certified check, money order or bank-wire transfer. Sorry, no C.O.D. orders. All equipment is in factory cartons with manufacturers' warranty. Prices subject to change without notice. Most items are in stock now.

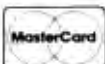

TERMINALS TERRIFIC



Terminals Terrific, Incorporated, P.O. Box 216, Merrifield, VA 22116, 800-368-3404 (In VA, Call Collect 703-237-8695).

Your TRS-80 video screen will come to life.

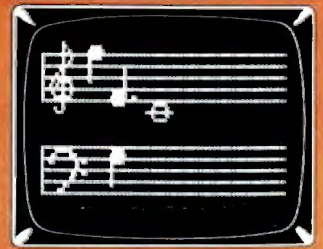

Bring your TRS-80 computer's video screen to life with the many striking graphics displays and functional programming techniques presented in this exciting and easy-to-follow new book!

Beginning with the basics, the authors introduce you to the tools of computer graphics, including the capabilities of the video screen, keyboard and character control, and graphics programming techniques such as concatenation, looping, and using subroutines and strings. The real fun begins as you learn how to create vivid displays ranging from business charts and mathematical function plots to dragons and lions, laser cannons, beautiful artistic designs, and a unique animated figure called Critter. Complete program listings and suggestions for modifications accompany each of the more than 100 graphic displays.

Besides providing guidance to those interested in specific applications, this book also serves the novice as an excellent introduction to programming in BASIC and machine language.

Written in a witty, readable style and complemented by over 100 detailed illustrations, *TRS-80 Graphics for the Model I and Model III* is both a thorough guide and an invaluable reference for anyone interested in the exciting field of computer graphics.

ISBN 0-07-033303-3

288 pages

Softcover

Illustrated

Price \$12.95

Prepayment is required.

Please add \$1.00 to cover shipping cost.

Order Toll-Free 800/258-5420

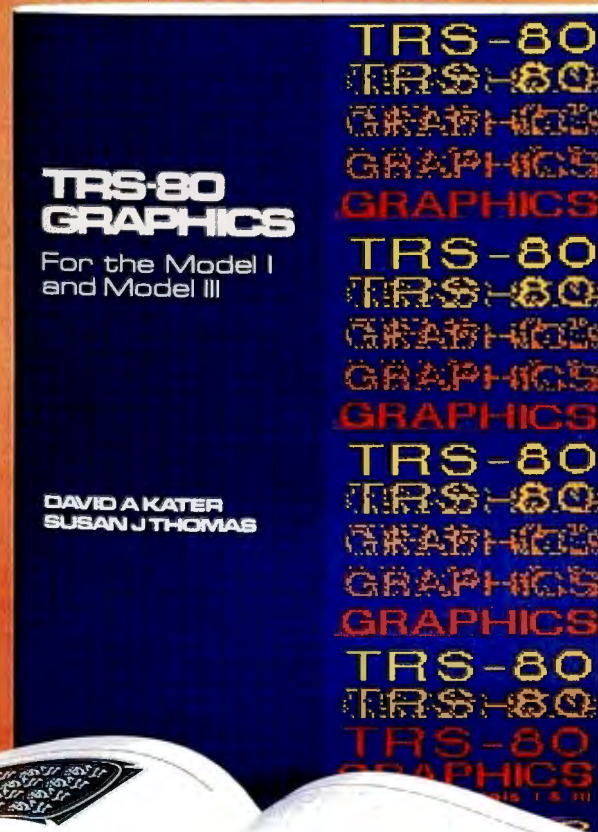

BYTE/McGraw-Hill 70 Main Street Peterborough, NH 03458

Circle 62 on Inquiry card.

McGraw-Hill

Save \$2500⁰⁰

Are you faced with having to spend \$3000 and up for a letter-quality printer?

Mediamix offers an alternative.



For only \$500 the **Mediamix ETI²** lets you connect the IBM Electronic Typewriter Models 50, 60, or 75 to **any** computer. Why invest in two separate machines? Your office typewriter can do both jobs, yielding better type quality, a consistent corporate image and renowned IBM service.



The **ETI²** is no simple black box, either. It is a sophisticated micro-computer with 2000 characters of memory, over 39 special commands and the option of doing typesetting on the IBM Model 50.

Write or Call

MEDIAMIX

P.O. Box 67B57
Los Angeles, California 90067
(213)475-9949

per iteration (or page). This text is then alphabetized ("popped"), but only by first letter. Each set of words with the same initial letter is stored in a different alphabetical matrix. This process is repeated until the entire text is processed. Each iteration of 1280 characters is stored as a separate matrix.

The SAVEFRAG function saves the last word or fragment of a word at the end of each iteration of 1280 characters. It carries this word or fragment forward to the next iteration.

The WINDEX function is next. Through its subfunction INDEX, it actually does the indexing of each word of the text. The subfunction FORMAT then puts the indexed text into 5 columns of 18 characters each that fit the printed 11- by 14-inch page neatly. The subfunction SAVEKK saves each iteration of indexed text (1280 characters) in a separate file. Roughly four iterations are necessary for a text of approximately 1000 words. It is stored as four separate matrices, each printing out as one page.

The ALPHAB function "pops" out words that have the same first letter, from A to Z. Each pop is stored in a separate alphabetical file. New contents are added cumulatively as the program progresses through its iterations. Internally, these alphabetical files are unsorted except for the fact that they share the initial letter.

The functions SORTPRINT and SORTER do the internal sorting of each alphabetical file. They start in the twelfth column and sort progressively forward to the first letter. The FORMAT function then takes over. It arranges the output in five 18-character columns and prints the result on a page. The alphabetical sorts are printed after all iterations have been completed.

Conclusions

Anthropological or ethnographic field work is characterized by the rapid accumulation of textual data. Typing material directly into the computer saves time, but still requires about 8 hours per 45-minute interview. In languages like English,

programs that understand speech may be just around the corner. For the exotic languages that ethnographers often deal with, such as Navajo, speech-recognition programs are still far in the future.

Once the data is in machine-readable form, the ethnographer of today has numerous options for speeding up analysis. Texts of hundreds of thousands of words can now be stored on hard disks. Some of these texts can be manipulated by text-processing programs such as Electric Pencl or Wordstar. More sophisticated manipulations are possible with multiwindow editing programs such as Electric Blackboard.

Our next development effort will be the creation of a multikeyed index to the texts on hard disk via a database management system such as dBASE II. This system will control access and maintain cross-referencing between items in the original texts. I am still looking for the best, most effective, and flexible software for this purpose.

From a field ethnographer's point of view, the ideal hardware is yet to be developed. It should be small, perhaps smaller than an Osborne 1, and certainly more rugged. Floppy or hard disks are less than ideal because they are so sensitive and require a nearly ideal environment for proper functioning. Field computers should have a minimum of moving parts. Magnetic-bubble memories at one time looked promising, but their slow development and high price will make them prohibitive for ethnographers for some time to come.

Today, ethnographers are using microcomputers in relatively sheltered environments close to the nearest service, in or near their field sites. Currently, available software offers help to the ethnographer who is willing to learn. The possibilities that exist today were unthinkable just a few years ago. I view the microcomputer age as that era during which qualitative, in-depth approaches to the study of human society will reach the speed, rigor, and efficiency that in the past could be achieved only through the use of relatively superficial quantitative methods. ■

THE Prompt-Doc[®] MANUAL MAKER

You know better user manuals sell more software, but how do you make better user manuals? How do you identify just the right details to motivate prospective

users to buy? How do you organize these details into a sequence that makes sense to first-time users while it provides ongoing reference to veterans? How do you format and package a manual so it's attractive enough to get attention yet clear enough to be readily understood?

And, how do you do all this at a pace that keeps up with your product release schedule? The Prompt-Doc[®] Manual Maker is the answer.

Introducing Computer-assisted Writing

Imagine a software product that prompts you through the process of planning, outlining and writing a user manual and even supplies boilerplate introductory and transitional text. Envision reducing your user manual preparation process to this:

1. Identify manual, select boilerplate chapter files from menu, review visual table of contents (VTOC) for chapters
2. Edit chapter VTOCs to tailor sequence and terminology to your product needs
3. Pause while computer modifies boilerplate chapters to match edited VTOCs and builds a skeletal manual in preformatted Wordstar[®] files
4. Use Wordstar[®] to edit the skeletal manual into a working draft, supplying product details as prompted
5. Tell computer to purge prompts and instructions from working draft, and build new Table of Contents; publish review draft
6. Review the draft for accuracy and usability; revise, polish and publish as instructed by documentation

Compared to your current process that may sound more like a software maker's dream than a real product. It's a dream all right. A dream come true called the Prompt-Doc[®] Manual Maker--the only product of its kind.

Consider These Benefits

Improved productivity--with Prompt-Doc[®] you can gain as much as 40% on typical manual writing jobs

Project control--with prestructured modular chapters, writing tasks can be segmented without losing continuity

Manual uniformity--by product, by product line, by company

Quality assurance--the boilerplate files help assure completeness and usability; the Prompt-Doc[®] User Manual guides publishing

Proven performance--based on the Prompt-Doc[®] methodology, the structures and outlines have been proven in myriad applications for the past four years; now we've tailored it specifically for the commercial software vendor

Reasonable Price

\$245 for software and manual, \$45 for manual only. This product will begin paying for itself the minute you start using it and continue making you money each time you publish a manual. What could be more reasonable?

CP/M[®] Compatible; Uses Wordstar[®]

Now available for use with Wordstar[®] on the Apple[®] II and III with the Softcard[®] and on the Xerox 820.

Use The Coupon Now

You know a better way to make better manuals can enhance your competitive position. Why wait another minute? Complete the coupon now and mail it to Context, Inc., Attention Prompt-Doc[®], 833 West Colorado Avenue, Colorado Springs, CO 80905. Or, if you'd rather not wait for the mail, call (303) 471-9875.



Context

The Prompt-Doc[®] Company

Prompt-Doc is a registered trademark of Context, Inc. Apple, Apple II and Apple III are registered trademarks of Apple Computer Inc. Softcard is a registered trademark of Microsoft Corporation. CP/M is a registered trademark of Digital Research, Inc. Wordstar is a registered trademark of Micro-Pro International Corporation.

I need the Prompt-Doc Manual Maker now! Send a copy to:

Name _____ Telephone (____) _____
Address _____

- Send manual only.
 My check is enclosed for \$_____. UPS C.O.D.
 You may charge my _____ VISA _____ Master Card
Account # _____
Amount \$ _____ Expiration Date _____

Signature _____

I need more information. Send it to the address above.

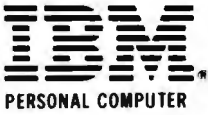

IBM-PC SUPPLY CENTER
PERIPHERALS & SOFTWARE
FOR THE IBM PC

PERSONAL COMPUTER

HARDWARE:
CORVUS Hard Disk Systems. See Corvus section this page
 Microsoft 64K RAM Card New! \$395 20% SAVE
 128K RAM Card New! \$555 20%
 256K RAM Card New! \$875 20%
 64K RAM Chips New! \$160 20%
 Quadram Quad RAM 256K 4 function brd New! \$689 31%
 TG Products Joystick New! \$ 49 25%

SOFTWARE:
 Automated Stim Temple of Apsah \$ 29 25%
 Cavalier Championship Blackjack \$ 29 25%
 Continental Home Accountant Plus \$112 25%
 Denver Easy (Exec. Accounting Sys) \$945 25%
 Infocom Deadline \$ 29 25%
 Innovative 1.1 III (a DBMS) \$369 25%
 ISM Math-mag \$ 69 25%
 *Insoft Accountant For each GL, A/R, A/P or Payroll. Absolutely the best IBM-PC accounting software we have seen. We use it and recommend it highly. A best buy! \$ 99 60%
 Info Unlimited
 Easywriter II New! \$259 25%
 Phone Support on Easywriter II Call Call
 Easywriter (88K words) New! \$129 25%
 Easyhit (a DBMS) New! \$299 25%
 Micro Pro Wordstar New! \$239 36%
 Sorcim Superwriter \$295 25%
 Super Calc \$219 25%
 Visicorp Visicalc \$159 20%
 Visicalc/256K \$199 20%

commodore
COMPUTER
VIC-20

VIC 20 Computer \$239 20% SAVE
 Super Expander VIC 1211A 3K with lots of extras \$ 56 20%
 3K Memory Expander Cartridge \$ 32 20%
 8K Memory Expander Cartridge \$ 48 20%
 16K Memory Expander Cartridge \$ 88 20%
 VIC Modem, Telephone Interface \$ 96 20%
 VIC/IEEE 488 Interface \$ 80 20%
 Joystick \$ 8 20%
 Game Paddle Pair \$ 15 20%
 Expansion Module (add 6 slots) August 22 \$119 20%
Software by Commodore (Cartridges except as noted)
 Programmers Aid \$ 48 20%
 VICMon Machine Language Monitor \$ 48 20%
 Adventure Land, Pirate Cove, Mission Impossible, The Count, Voodoo Castle, or Saragun II Chess, each \$ 29 20%
 VIC Avenger Superdisk, VIC Super Alien, Jupiter Draw Poker, Midnight Drive, Lander or Radar Rat Race, each \$ 24 20%
 Omega Race, Gorf, Wizard of War, Dogpat, Seawolf, Clowns/Bickyard, or VIC het/VIC Term, each, New! Call Call
 Tapes: Math Improv, Sixpack, Recreation Pack A or Home Calculation Pack A, each (tapes) \$ 48 20%
 Meteor Run by UMI! \$ 37 25%
 ViCalc by UMI! tape \$ 11 25%
 Amok by UMI! tape \$ 19 25%



800 Computer 16K \$666 38% SAVE
 800 Computer 32K \$747 37%
 800 Computer 48K \$777 40%
 800 Computer 16K \$333 17%
 810 Disk Drive \$444 26%
 850 Interface \$159 25%
 400 Recorder \$ 79 21%
 825 Printer 80 Col, Impact \$595 25%
 \$269 14%
 \$279 14%
 \$159 28%
 \$ 85 15%
 \$109 20%
 Le Stick by Datsoft \$ 29 28%
 Game Paddles (pair) \$ 18 20%
 Joystick (pair) \$ 18 20%
 Visicalc. Disk \$189 25%
 Word Processing, Disk \$119 23%
 Pacman, Cart New! \$ 35 22%
 Centipede, Cart New! \$ 35 22%
 Caverns of Mars, Disk \$ 31 23%
 Touch Typing, Tape \$ 19 23%
 Personal Financial Mgt. Disk \$ 55 22%
 Entertainer A.D. Cart \$ 79 33%
 Educator Kit Cart \$125 29%

OUR REFERENCES:
 We have been a computer dealer since 1978. Our bank reference is First Interstate Bank, (503) 776-5620. We belong to the Chamber of Commerce, (503) 772-6293, or call D&B (503) 242-2350 if you are a subscriber.

ORDERING INFORMATION:
 Minimum order \$100. Cashiers Checks and Money Orders welcomed. Personal Checks allow 20 days to clear. Add 3% for shipping, insurance and handling. UPS is standard. Additional 10% for US Postal or APO. Additional 3% for VISA or MC. include telephone #. No COD. Prices subject to change and type errors. Call to verify. All goods are new and include factory warranties 0 to 20% restocking charge on returns. No refunds on opened software. Call before returning goods. Order desk hours are 8 to 6 PST 10 to 3 Saturdays.

Programmer Kit Cart \$ 55 22%
 Communicator Kit Cart \$335 26%
 Dow Jones Invest, Disk \$ 99 24%
 Temple of Apsah by Automated Disk \$ 29 25%
 Apple Panic by Broderbund, Disk \$ 23 25%
 Raster Blaster by Budgeco, Disk \$ 23 25%
 Bug Attack by Cavalier, Disk \$ 23 25%
 Text Wizard by Datsoft, Disk \$ 75 25%
 Compu-series by Edu-Ware, Disk Call
 Deadline by Infocom, Disk \$ 37 25%
 Zork II by Infocom, Disk \$ 29 25%
 Asteroid by On Line, Disk \$ 20 25%

CP/M BUSINESS & DEVELOPMENT SOFTWARE

Adventure. Adventure's #1 to #12 inclusive. 8" \$ 95 26% SAVE
 *Ashon-Tate, dBase II, 8" \$495 30%
 *Safsoft, MyChess, 8" \$ 39 25%
 Fox & Geller, Quickcode for dBase II \$249 13%
 Quickscreen for dBase II \$129 13%
 dBase for dBase II \$ 75 25%
 Infocom Deadline, 8" \$ 45 25%
 Zork II, 8" \$ 39 25%
 Innovative, Spellguard, 8" \$220 25%
 *Insoft, Accountant 8" each module \$ 99 60%
 For each GL, A/R, A/P or Payroll. Absolutely one of the best accounting software systems available. We use it and recommend it highly. A best buy! \$ 99 60%
 Micro Craft, Legal Billing & Time Keeping \$395 45%
 Prof. Billing & Time Keeping \$395 45%
 Micro Pro, Wordstar 8" \$285 40%
 Datastar, 8" \$225 40%
 Mairmerge, 8" \$ 90 40%
 Super Sort, 8" \$150 40%
 Word Master, 8" \$ 90 40%
 Spell Star, 8" \$150 40%
 Calc Star, 8" \$180 40%
 Microsoft, Fortran 80, 8" \$325 25%
 Basic Compiler, 8" \$295 25%
 Cobol 80, 8" \$545 25%
 Basic 80, 8" \$275 25%
 Peachtree, Magic Wand, 8" \$295 25%
 GL, A/R, A/P, PR or Inventory \$325 35%



HEWLETT PACKARD

H/P 85 Microcomputer/Monitor/Printer New! \$1975 30% SAVE
H/P 87 CP/M Microcomputer New! \$1875 25%
H/P 125 CP/M Microcomputer New! \$1965 30%
H/P 82901M 5" Dual Drives \$1595 28%
H/P 7225B Professional Graphics Plotter \$1795 35%
H/P 7470A Graphics Plotter \$1125 28%
H/P 41C Calculator \$ 185 25%
H/P 41CV Calculator 2.2K \$ 245 25%
Card Reader for HP41 \$ 159 27%
Printer/Plotter for HP41 \$ 289 25%
Optical Wand for HP41 \$ 89 25%
Software:
 Visicalc + for HP87 \$ 189 25%
 Visicalc + for HP125 \$ 159 20%
 *Accountant by Insoft for 125 or 87
 For each GL, A/R, A/P or Payroll. Absolutely the best HP125 or HP87 accounting software we have seen. We use it and recommend it highly. A best buy! \$ 99 60%
 Full line of HP accessories and software. Call Call

CORVUS SYSTEMS

6 Meg Hard Disk \$2195 30% SAVE
11 Meg Hard Disk \$3995 20%
20 Meg Hard Disk \$4795 20%
Apple Interface \$ 179 40%
Apple III Interface (SOS) \$ 179 40%
IBM PC Interface (IBM DOS) \$ 179 40%
Xerox Interface (CP/M) \$ 179 40%
NEC Interface (CP/M) \$ 179 40%
TRS 80 Interface (call) Call 40%
 Other interfaces, Omni-Net, Constellation, Mirror. All in stock.



8001 32K Computer \$ 739 25% SAVE
 286K Total Dual Drive PC8031 \$ 739 25%
 32K add-on and I/O Unit PC 8012 \$ 485 25%
 Ren Tec "The Wedge" 32K \$ 495 17%
 8023 Impact Printer F/T \$ 480 25%
 Impact Printer Cable \$ 49 25%
 3510 Letter Quality Daisy Wheel Printer \$1995 20%
 Monitor, 12" Green \$ 159 25%
 Monitor, 12" Color \$ 349 25%
Software:
 NEC CP/M DOS for NEC 8001 \$ 115 25%
 NEC Report Manager \$ 135 30%
 NEC General Accounting \$ 239 40%
 NEC Accounts Receivable \$239 40%
 NEC Inventory System \$ 239 40%
 NEC Payroll System \$ 239 40%
 NEC Game Pack I \$ 24 20%
 NEC Game Pack II \$ 24 20%
 NEC Word Processor \$ 395 20%
 Infocom Zork II \$ 29 25%
 Infocom Deadline \$ 39 25%
 *Insoft Accountant
 For each GL, A/R, A/P, or Payroll. Absolutely the best NEC accounting software we have seen. We use it and recommend it highly. A best buy! \$ 99 60%.



FOR THE APPLE II/II - DIRECT SUBSTITUTES FOR APPLE DRIVES

Micro-Sci A2 drives and/or controllers and direct plug compatible substitutes for Apple drives and controllers. A2 will run all Apple software. Save over \$350 on an A4 dual drive system. We use them and highly recommend the product.
 A2, 5 1/4", 143K Disk Drive \$390 18
 Controller Card for A2 Drive \$ 90 15
 A40, 5 1/4" 160K Disk Drive \$369 18
 A70, 5 1/4" 286 Disk Drive \$489 20
 Controller Card for A40 or A70 Drive \$ 79 21
 Filer, Disk Utility Software System for A2 Drives \$ 15 25



FOR THE APPLE II/II + 320K RAM Substitute for Disk Drives Professionally housed in a disk drive like box. Fast!

RAMDISK 320K Memory System \$1145 2

PRINTERS, Daisy Wheel

Qume Sprint 9, 45 Cps. RO SPECIAL! \$1895 33
Sprint 5, 45 Cps. RO SPECIAL! \$1995 34
Comrex CR-1, 17 Cps. RO, RS232 NEW! \$ 895 26

PRINTERS, Impact

Epson See Epson section below SAV
IDS Prsm 132, Color w/Graphics \$1595 20
Prsm 80, Color, w/Graphics \$1495 17
Pager Tiger 445G, w/Graphics & 2K \$ 595 35
Okidata Microline 82A, 120 Cps, 80 Col, Para & Serial \$ 495 15
Microline 845, 200 Cps, 136 Col, Serial \$1295 15

EPSON PRINTERS

MX80T w/Graphics \$425 31 SAV
MX80 F/T w/Graphics \$525 21
MX100 F/T w/Graphics \$695 27
70/80/100 Apple Interface and Cable \$ 95 15
MX80 Friction feed adapter \$ 59 22
MX80 Graphics 80 \$ 79 20
Epson/TRS Cable \$ 30 26
Epson/TRS 80 Cable \$ 30 26

MONITORS

NEC 12" Green \$159 21 SAV
12" Color, Composite \$349 21
Sanyo 12" Green \$169 22
9" B&W \$149 31
9" Green \$159 31
12" B&W \$229 31
12" Green \$399 28
13" Color \$119 30
Zenith 12" Green \$159 38
Amdek 12" Green #300 \$359 20
13" Color I, Composite \$199 20
13" Color II, RGB \$159 20
Color II to Apple II Interface \$349 27
Comrex 13" Color, Composite \$529 15
13" Color, RGB for IBM-PC

DISKETTES

CDC 100 each, 5 1/4" with ring, SS, SD \$195 5 SAV
CDC 10 each, 5 1/4" with ring, SS, SD \$ 22 4
10 each, 5 1/4" with ring, SS, DD \$ 28 4
CDC 10 each 8", SS, SD, SS, SD \$ 28 4
Verbatim 10 each 5 1/4" with ring, SS, SD \$ 28 4
Maxell 10 each 5 1/4" SS, SD \$ 35 3
Dysan 10 each 5 1/4" SS, SD \$ 39 3
10 each 5 1/4" DS, DD \$ 49 2

PAPER

Fan fold tractor feed paper in 12 combinations of thickness, width length and color. Average of 2800 sheets per box. Call.

SUPPLIES

Supplies such as ribbons, cables, pens, connectors, paper and mailing labels are available. Call for details.

NO SALES TAX

Oregon Order Desk (503) 772-3803

NATIONAL ORDER DESK

TOLL FREE (800)547-1289

Call for references
 Apple is a registered trademark of Apple Computer, Inc.

of Professionals

Manufactured
Exclusively for



Bell & Howell

by



apple computer

	LIST	BIEGE	B&H BLACK	SAVE
48K	\$1,530	\$1,295	\$1,270	\$260
64K	\$1,730	\$1,395	\$1,370	\$360
DISK II w/3.3 Cont.	\$645	\$555	\$545	\$100
DISK II Only	\$525	\$485	\$475	\$50

OR

SAVE OVER \$300 on a pair of drives.

Buy a pair of Micro-Sci A2 Drives See opposite page.



Warranty: Factory warranty is by Bell and Howell (not by Apple) and is one year parts plus 90 day labor. Warranty service available at Bell and Howell service centers or return to Computer Exchange.

Apple is a registered trademark of Apple Computer Inc.

APPLE II/II+ SUPPLY CENTER

HARDWARE for Apple II/II+

MICRO-SCI Disk Drives Plug/software compatible to Apple See Opposite page
RAM CARDS:
Microsoft 16K RAM Card \$ 159 20%
ALS 16K ADDRAM \$ 89 40%
Sartum Systems: 32K \$ 169 25%
64K \$ 319 25%
128K \$ 459 25%
VC Expand \$ 75 25%
Aston 320K RAM disk system \$1145 20%

80 COLUMN VIDEO CARDS:
ALS Smarterm \$ 250 25%
Videx Videoterm \$ 249 28%
Vista Vision 80 \$ 279 30%
M&R Sup R term \$ 319 15%
See more ALS and Videx under Miscellaneous below

MISCELLANEOUS:
ALS: Smarterm 80 Col Card \$ 259 30%
Z Card (Z-80) W/CPM \$ 209 22%
16K ADDRam \$ 89 40%
Synergizer Package \$ 549 27%

*Synergizer with free Sorcim Supercalc (While they last) \$ 549 48%
Apple Computer Silentype II Printer \$ 675 15%
Graphics Tablet \$ 335 15%
Aston 320K RAM Disk System \$1145 20%
CCS Serial Interface 7710A \$ 139 22%
Other CCS Cards in stock Call Call
Dan Feymar Lower Case Chugs \$ 34 33%
Hayes: Micromodem II \$ 289 25%
Smartmodem \$ 229 20%
ISC Videostick Paddle \$ 35 23%

Keyboard Company:
Joystick II \$ 45 10%
Game Paddle \$ 25 17%
Numeric Keypad \$ 119 21%
M&R: RF Modulator \$ 25 27%
*Microsoft 280 Softcard \$ 279 33%
16K RAM Card \$ 159 33%
Softcard Premium Pack \$ 579 25%

Mountain:
CPS Multifunction Card \$ 209 13%
Clock/Calendar \$ 195 30%
Novation Applecat Modern \$ 329 16%
Orange Micro Grappler \$ 129 21%
Practical Peripherals w/cable & Conn)
MBS BK Serial (Epson) New! \$ 129 20%
MBP 16K Para (Epson) New! \$ 129 20%
Microbuffer II 16K New! \$ 209 20%
Microbuffer II 32K New! \$ 229 24%
RH Electronics Super Fan II \$ 59 21%
SSM A10 Serial/Para interface \$ 159 20%
TG Products: Game Paddies \$ 29 28%
Joystick \$ 45 25%
*Videx Videoterm 80 col \$ 249 28%
Soft Video Switch \$ 25 29%
Enhancer II \$ 99 34%
Full Video Line Call up to 35%

SOFTWARE on disk for Apple II/II+

BUSINESS

Apple Computer, Inc.	Call	SAVE
50% Off on Apple III Software	Call	50%
The Controller (Accounting)	\$499	20%
Apple Writer 1.1	\$ 59	20%
Apple Pascal	\$199	20%
Apple Fortran	\$159	20%
DOS Tool Kit	\$ 59	20%
DOS 3.3 Upgrade Kit	\$ 59	20%
Apple Plot	\$ 59	20%
Apple Pilot	\$119	20%
DJ News & Quotes	\$ 75	20%
DJ Portfolio Evaluator	\$ 45	20%
How to!	\$ 39	20%
Microcorner	\$199	20%
Micro Telegram	\$199	20%
Time Manager	\$119	20%
How to!	Call	Call
Many Others	Call	Call
Applied Soft Tech. Versa Form	\$289	26%
Artsci Magic Window	\$ 75	25%
Ashion-tate dBase II (CP/M)	\$495	30%
Beagle Bros Utility City	\$ 22	25%
Broderbund Payroll	\$269	30%
General Ledger	\$349	30%
Denver Financial Partner	\$185	25%
dBase II for Apple II/II+ w/CP/M	\$495	30%
Fox & Geller Quickscreen for dBase II	\$129	13%
Fox & Geller Quickcode for dBase II	\$259	13%
Hayden Apple Pro (Specify brd)	\$ 99	25%
High Tech. Store Mgr	\$189	25%
Job Control Sys	\$469	40%
Info Master	\$119	40%
Info. Unim. Easywriter (PRO)	\$139	25%
*Innovativ Spellguard (CP/M)	\$150	50%
Insoft Accountant (CP/M)	\$ 99	60%
For each GL, A/R, A/P or Payroll Absolutely the best accounting software available for the Apple II/II+ Better than Peachtree We use it and recommend it highly		
LJK Letter Perfect	\$112	25%
Micro Craft Legal Billing & timekeeper	\$250	65%
Prof. Billing & timekeeping	\$250	65%
Micro Lab Data Factory ver 5.0	\$249	20%
VisiFactory	New! \$ 56	25%
Invoice Factory	\$129	35%
Tax Manager	\$ 95	38%
Micro Pro (all CP/M)	SAVE	
*Word Star	\$239	36%
Mail Merger	\$ 79	36%
Spell Star	\$159	36%
Data Star	\$189	36%
Calc Star	\$189	36%
Super Sort I or II	\$129	36%
Muse Super Text II	\$113	25%
Super Text 40/80	New! \$129	25%
Form Letter	New! \$ 75	25%
Address Book	New! \$ 39	25%
On-Line Expediter II	\$ 75	25%
Screen Writer II	\$ 95	27%

Osborne/C.P. Soft. (Disk and Book)

*Some Common Basic Programs 75 Business: Statistics and Math programs for the Apple II \$ 49 50%

*Practical Basic Programs, 40 more very valuable programs beyond "Some Com. Basic Prog."
Peachtree GL, AR, AP or Inv each \$ 189 36%
*Magic Wand (Specify board) \$250 37%
Phoenix Zoom Grafix \$ 29 28%
Sensible Apple Speller \$ 55 27%
Silicon Valley Word Handler \$150 40%Solidus/Softach

*Stockfile \$250 60%
Stockseller \$425 40%
Software Publishing
PFS NEW versior! \$ 89 30%
PFS Report \$ 69 30%
Sorcim Super Calc. (CP/M) \$219 25%
Southeastern
Data Capture 4.0 specify brd \$ 69 25%
Source The Source \$ 75 25%
Stoneware DB Master \$179 22%
Stoneware DB Utility I or II \$ 75 10%

VisiCorp/Personal Software
Visicalc 3.3 \$189 25%
VisiDoc \$199 25%
VisiFile \$199 25%
Desktop Plan II or III \$199 25%
Visiplot \$159 20%
Visi Schedule New! \$239 20%
VisiTrend and Visi Plot \$239 20%
Visi Term \$ 79 20%
Zork \$ 33 20%

UTILITY & DEVELOPMENT

Beagle Utility City \$ 22 25%
Central Point Software
*Copy II Plus (bit copier)
Will copy most copy protected software for your backup in 45 seconds or less! Highly recommended \$ 35 10%
Epson Graphics Dump \$ 9 35%
Insoft
*GrafORTH by Lulus New! \$ 69 25%
ALD System II by Lulus \$110 10%
TransFORTH II by Lulus \$110 10%

Microsoft
A L D S \$110 10%
BASIC Compiler \$299 25%
Cobol 80 \$559 25%
Fortran 80 \$149 25%
Olympic Decathlon \$ 24 24%
TASC Compiler \$159 22%
TASC Computer \$ 75 25%
*Omega Locksmith (bit copier) \$ 75 25%
On-Line Expediter II \$ 75 25%
Phoenix Zoom Grafix \$ 29 28%
Source The Source \$ 75 25%
Southwestern ASCII Express \$ 59 25%
Sub-Logic Flight Simulator \$ 28 20%
Tymac Super Pix \$ 20 20%

HOME & EDUCATION

Autom Sim. Crush Crumb Chomp	\$ 30	SAVE	25%
Broderbund Apple Panic	\$ 21	30%	
Arcade Machine	\$ 32	30%	
Red Alert	\$ 21	30%	
Space Warrior	\$ 18	30%	
Star Blazer	New! \$ 24	30%	
Many others	Call	Call	
Bedpaco Raster Blaster	\$ 22	27%	
Callit. Pacific Ultima	\$ 30	25%	
Cavalier Bug Attack	\$ 23	23%	
Continental Home Accountant	\$ 56	25%	
Continental Home Accountant	\$ 26	25%	
Data Most Snack Attack	\$ 22	25%	
Thief	\$ 22	25%	
Edu-Ware Computmath Series	\$ 29	25%	
Mayden Sargon II (Chess)	\$ 29	22%	
Infocom Deadline	New! \$ 38	25%	
Zork	\$ 29	25%	
Insoft Electric Duet by Lulus	New! \$ 25	20%	
GrafORTH by Lulus	New! \$ 69	25%	
Lightning MasterType	\$ 29	25%	
Microsoft Olympic Decathlon	\$ 24	24%	
Typing Tutor	\$ 19	30%	
Muse Robot War	\$ 29	25%	
On-Line Pegasus II	\$ 22	25%	
Mouskattack	New! \$ 26	25%	
Time Zone	New! \$ 75	25%	
Jawbreaker	New! \$ 23	25%	
URima II	New! \$ 41	31%	
Marauder	New! \$ 26	25%	
Threshold	\$ 30	25%	
Cranston Manor	\$ 25	25%	
Mission Astroed	\$ 15	25%	
Mystery House	\$ 19	25%	
Softporn (X Rated)	\$ 22	25%	
Ulysses and Golden Fleece	\$ 22	25%	
Piccadilly Falcon	\$ 23	25%	
Star Blaster	\$ 23	25%	
Sentient On-TOPOS	\$ 25	25%	
Sirius Sneakers	\$ 22	25%	
Gargon	\$ 29	25%	
Tweps	\$ 22	25%	
Sir-Tec Wizardry	New! \$ 39	22%	
Strategic Southern Command	\$ 45	25%	

OTHER BRANDS IN STOCK:

Accent, Adventure International, Aston, Auto. Sim., Avalon, Avant-Garde, Beagle, CPU, Datasoft, Delta, Edu-Ware, Info com, Lazar, LJK, Phoenix, Quality, Silhouette, Sentient, Sirius, Strategic, Synergistic and United.

* Means a BEST buy.

\$100 Minimum Order.

THE WORLD'S LARGEST COMPUTER MAIL ORDER FIRM

Computer Exchange

ALL MAIL: P.O. Box 1380, Jacksonville, OR 97530

WAREHOUSE AND OFFICES, BY APPOINTMENT AT 6791 UPPER APPLGATE ROAD.

Ad #933

Mediamix's ETI²

Robert Welborn
POB 817
Montrose, CA 91020

As a small-business owner, I've wanted a personal computer for quite some time. One factor that held me back (and probably discourages many potential buyers) is the cost of a good printer. Not that there isn't an abundance of low-cost dot-matrix printers, some even offering "correspondence quality," but purchase of a true business-letter-quality printer will practically double the investment. Mediamix in Los Angeles solved this problem with the ETI², a device that allows me to use my office IBM Electronic Typewriter instead of a computer printer.

The unit arrived a week later than promised, but was integrated into my system and functioning perfectly within half an hour. The installation manual is one of the best I've read, providing lucid, step-by-step guidance in a very nontechnical manner.

Soldering is unnecessary—installation consists of plugging a cable into the typewriter's logic board and clipping two wires to other points in the typewriter. The short cable hangs out of the back of the typewriter and is plugged into a 10-foot ribbon cable attached to the ETI². I purchased the parallel version of the Mediamix unit so the ETI² attaches to the same printer connection on my computer that my dot-matrix printer uses. The ETI² has a self-test feature for verifying proper connection to the typewriter.

The operator's manual was written by the author of the installation manual, and it is equally good, but I recall being somewhat overwhelmed after my first reading. The ETI² is fairly sophisticated: it not only connects the typewriter to a computer, but it provides access to all of the typewriter's automated functions and adds a number of features and options. The quantity and variety of commands used to accomplish this makes the package seem

formidable. The author advises the novice to disregard the commands and options at first and to "use the typewriter as you would any printer." After a second reading and a practice session you'll realize that in everyday use ETI² is not at all complicated, but rather provides a tremendous amount of flexibility (commands can be adapted to every imaginable situation).

One category of commands covers the typewriter's automated functions, which include word and phrase underlining, tabbing, centering titles, and aligning columns of decimal numbers. These commands can be directly accessed in BASIC by printing the corresponding ASCII control code. For example, CHR\$(8) makes the typewriter backspace and CHR\$(23) actuates its word-underline function. An alternative method uses a two-character command consisting of an asterisk followed by

At a Glance

Name
Mediamix ETI²

Use
Interfaces IBM Electronic Typewriter, Models 50, 60, or 75, to a computer for use as a printer

Manufacturer
Mediamix
POB 67857
Los Angeles, CA 90067
(213) 475-9949

Price
\$495 for parallel version;
\$595 for RS-232C serial version; typesetting option \$75 (for IBM Model 50 only)

Hardware Required
Any computer with provisions for a parallel or serial printer

Warranty
One year limited parts and labor. Factory service depot in Texas, and at dealers.

STOP SOFTWARE FAILURES

*Using a micro in a product sounds easy...
One piece of software can make the difference
between success and failure.*

What do you do when the software doesn't work? Over the years, we have seen many good products fail, either before or after they reached the market, because the microprocessor software did not do its job.

WHAT WENT WRONG?

Many of the failures occurred because the people programming the micro did not know how to organize a large control program. Those responsible for the product implementation were wizards at hardware design and had easily coded small micro control programs before. But the programming techniques that worked for less than 2K bytes of code simply fell apart as the program grew beyond 4K bytes.

Unfortunately, the loops and tests and flags that work so well for a small program get out of control very rapidly as the program grows. Pretty soon, some of the things the program must do are not being done fast enough. The code gets too complicated, difficult to modify and unreliable. The result: another software failure!

Fortunately, these problems can be avoided by using a program manager. You can divide your complex control program into a number of separate, more manageable programs, called *tasks*, each designed to do one job. For example, a Keyboard Task might handle user input; a Printer Task might generate reports. Each task can be written and tested separately and then combined to form a reliable, finished system.

The program manager, called a *multitasking executive*, supervises the orderly execution of these tasks, assuring that the most important jobs always get done first. Tasks appear to be executing simultaneously. It's almost like having a separate CPU for each task!

That is why professional software designers are now turning to AMX as the starting point for their product and system designs. They know that AMX will shield them from the difficulties of managing the micro, freeing them to concentrate on their application.



AMX is our **multitasking executive** for the 8080, 8085, Z80 and 6809 processors. We're rather proud of it. We made AMX compact, very fast, and ROMable to meet our own application needs. Even though the AMX nucleus is less than 1400 bytes in size, it features multiple task priorities, intertask message passing with priority queuing, external event synchronization, and interval timing with 32-bit precision. Each feature is clearly explained in the AMX Reference Manual.

RELIABILITY BUILT IN

We don't know anyone who can write an executive without errors, so we thoroughly tested AMX in real applications before ever offering it as a product. That is why not one system malfunction has ever been attributed to AMX. That kind of reliability just isn't an accident.

HARDWARE INDEPENDENCE

AMX does not require a particular hardware configuration. Of course, it does need a microprocessor, but even there we offer you a choice. *You* control your environment. *You* pick the I/O method. *You* decide the most optimum interrupt service technique for your system. AMX will support your choice.

High level language interface modules are available separately to allow AMX to be used with most popular programming languages including PASCAL, C, PL/M and FORTRAN. Of course, you can also code in assembly language if required.

Users of the CP/M and FLEX Operating Systems can utilize our AMX interface modules to access information on diskette in real time.

COMPLETE DOCUMENTATION

AMX can be judged by the quality of our documentation. The positive response from our users has exceeded our expectations. Our manuals are especially valuable to those just being introduced to real-time multitasking. More experienced users will appreciate the fact that we deliver AMX source on diskette to permit AMX to be moved to the software development system of your choice.

HOW TO ORDER

A specification sheet and price list are available, free. Your check or money order for \$75 will purchase the AMX Reference Manual for immediate evaluation (specify 8080, 8085, Z80 or 6809 processor). Add \$25 for postage and handling outside USA and Canada. The standard AMX Multitasking Executive package, including source code, is available for \$800 after signing our liberal license agreement.

AMX is the choice of professionals the world over. Make it yours, today.



KADAK Products Ltd.

1847 West Broadway Avenue
Vancouver, B.C., Canada V6J 1Y5
Telephone (604) 734-2796
Telex 04-55670

Daisy Wheel Printer.

\$ 695

Smith-Corona® TP-1™

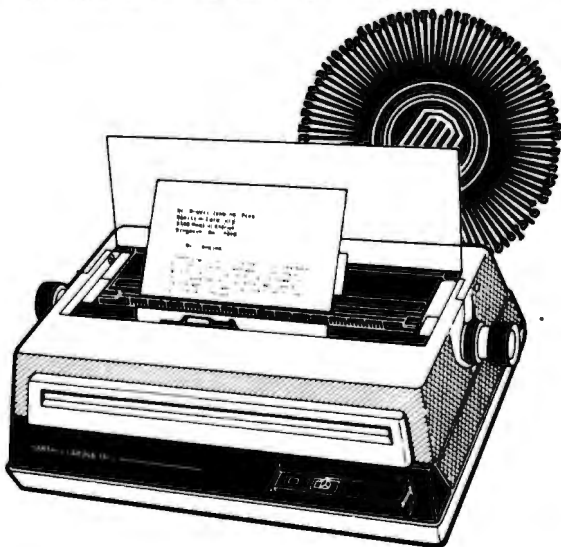

SAVE \$200.00

SUGGESTED RETAIL \$895.00

- Letter Quality Printing
- Centronics Type Parallel Interface Connects To TRS-80 & Other Microcomputers
- Serial Interface Available
- Compatible With Most Microcomputers
- Full Form Characters 10 or 12 Pitch
- Manufactured By A Name You Can Trust*

SCM SMITH-CORONA

MICRO MANAGEMENT SYSTEMS, INC.

PARCEL DIVISION - DEPT. NO. 1 TP

2803 THOMASVILLE ROAD
CAIRO, GEORGIA 31728

800-841-0856

GA. & INFO 1-912-377-7120

a capital letter: backspace by printing *B, *U for continuous underline, *T for tab, *C for center, etc.

Mediamix has some features that don't come with the typewriter, such as *P (pause), and *N (automatically counts the digits of a number and issues the proper tab so that a column of numbers aligns vertically on the decimal point).

A second category of commands can be issued to the ETI² by including them in a special text line sent to the printer. Any line beginning with ETI² is considered a *special command line*. Approximately 20 commands, most of them obvious abbreviations or acronyms of the functions they represent, are available. These functions include control over the number of characters per line and the number of lines per page, end of form (something like top of form), automatic setting of the left margin and any tabs, control of the way in which the 2000-character buffer is used, and adapting for various special versions of the IBM Electronic Typewriters.

Also provided is a means to redefine either or both of the characters in the two-character commands. This function may seem a bit esoteric at first, but it has already proved to be essential. I purchased a program that conflicted with the use of asterisks in text, making commands like *U for underlining unusable. I was able to get around this by instructing the ETI² to respond to a percent sign, instead of an asterisk, followed by a capital letter.

This command-redefinition feature could also be used to adapt the ETI² to a more sophisticated word-processing program. For example, if a program provides a control character or character sequence for underlining or other functions, you could instruct the ETI² to underline in response to the program's codes instead of its built-in *U command.

Even more remarkable is a set of commands that relate to the translation of characters received by the ETI² into what is printed. The IBM ET type element has 96 characters. My typewriter keyboard has only 92 characters, and my computer's keyboard has its own special keys and characters. The ETI² lets you easily access any of the typewriter's characters via any of the characters on the computer's keyboard. For example, I can instruct the ETI² to print ¶ (paragraph symbol) upon receipt of & (ampersand), or print a superscript character when I include > (greater than) in my text. The importance of this feature should not be underestimated. I began using this feature almost immediately to access the § (section) and © (copyright) symbols that I use frequently in my work. I know of no other printer that provides this degree of flexibility.

The only option available for the ETI² is a typesetting feature that can be used with the IBM Model 50. I own a Model 60, and therefore could not use this option. However after looking at Mediamix's literature and instruction manuals, all of which are printed using this feature, I wished I did own a Model 50. "Typesetting," to Mediamix, apparently means being able to right justify the Model 50's proportional type. In view of the small number of fonts and type sizes available, this form of typeset-

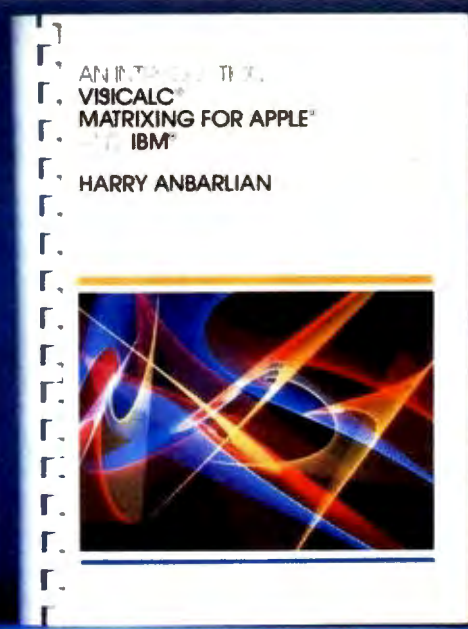
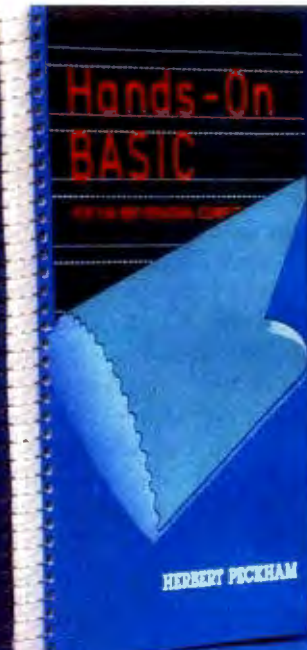

Hardware Helpers

Making the most of your hardware? Here's hands-on programming help from the experts — help you won't find elsewhere — to show you how to get your money's worth... *plus!* Little or no math is required. And hundreds of detailed program examples and practical exercises make each step easy!

Introduction to VisiCalc® Matrixing
Harry Anbarlian 224 pp., \$22.95
Few VisiCalc users are taking *full* advantage of this extremely powerful planning and forecasting tool. Here at last is the how-to for quickly and simply creating matrixes tailored to your specific needs. From corporate financial planning to managing a stock portfolio, it gives you practical guidance you won't find in the VisiCalc manuals... or anywhere else in print.

Apple® PASCAL: A Hands-On Approach
Arthur Luehrmann and Herbert Peckham 384 pp., \$16.95
This spiral-bound guide puts the most powerful language a computer can have *at your fingertips*—gives you all the working skills you need to create, run, and debug programs in Pascal on the Apple II or Apple II Plus. Leads you painlessly from fundamentals to data structures, recursion, and other advanced topics.

Hands-on BASIC for the IBM® Personal Computer
Herbert Peckham 352 pp., \$19.95
This authoritative manual demonstrates how hands-on BASIC and the IBM Personal Computer make a perfect match. The book helps you make the most of your IBM Personal Computer — *and* master the useful BASIC language. Plus, it covers applications using graphics and sound.

VisiCalc is a registered trademark of VisiCorp, Inc. Apple is a registered trademark of Apple Computer, Inc. IBM is a registered trademark of International Business Machines.

Also available:



BASIC: A Hands-On Method, 2/e
Herbert Peckham 306 pp., \$14.95
Useful with both time-sharing and personal computers, this expanded second edition of the popular spiral-bound manual stresses hands-on experience to help you quickly become proficient in BASIC programming. Includes new material on string operations.

Programming BASIC with the TI Home Computer
Herbert Peckham 256 pp., \$17.50
Goes far beyond the "Beginner's BASIC" furnished with the TI Home Computer, so you can explore the full range and power of TI BASIC, including color and sound.

Hands-on BASIC with a PET
Herbert Peckham 267 pp., \$15.95
Fully explains in a friendly, relaxed manner exactly how to program Commodore Business Machines' PET Personal Computer using BASIC.

The Elements of Programming Style, 2/e
Brian W. Kernighan and P.J. Plauger 168 pp., \$11.95
This second edition of the classic guide to efficient, effective programming for a wide range of tasks includes a useful set of rules for good programming — and numerous examples.

Available at your bookseller or computer store. Or use coupon for 15-day FREE examination!

McGraw-Hill Book Company
P.O. Box 400, Hightstown, NJ 08520

Please send me the book(s) checked for 15 days on approval.

- Bill me. After 15 days I will pay for the book(s) I keep, plus postage, handling, and local tax, and return any unwanted book(s) postpaid.
- Enclosed is my check/money order (including tax). McGraw-Hill pays postage and handling. I may return unwanted book(s) within 15 days for refund.
- INTRODUCTION TO VISICALC MATRIXING, \$22.95 (001605-4)
- APPLE PASCAL: A HANDS-ON APPROACH, \$16.95 (049171-2)
- HANDS-ON BASIC FOR THE IBM PERSONAL COMPUTER, \$19.95 (049147-X)
- BASIC: A HANDS-ON METHOD, 2/e, \$14.95 (049160-7)
- PROGRAMMING BASIC WITH THE TI HOME COMPUTER, \$17.50 (049156-9)
- HANDS-ON BASIC WITH A PET, \$15.95 (049157-7)
- ELEMENTS OF PROGRAMMING STYLE, 2/e, \$11.95 (034207-5)

Name _____
Address/Apt. _____
City/State/Zip _____

62 U404-2144-3

ting is very limited, although the result is almost as good as phototypesetting.

After several months of use I am still completely satisfied with the ETI². My typewriter requires less service (due perhaps to the fact that only final-draft material is printed); it is audibly quieter under computer control, and I understand there is a high-speed clutch inside the typewriter for running at full speed; and in the event that the unit requires service, I can rely on the speed and quality of IBM "at the office" service, instead of having to carry the printer into a store or ship it out. If my computer breaks down, I still have the typewriter, so I'm covered either way.

Conclusions

• The addition of ETI² to an IBM Electronic Typewriter results in a reliable, robust system. If either the computer

or the typewriter malfunction, you still have a portion of the system to work with. This is an important consideration for many businesses. IBM is known for its excellent service.

• The print quality of the system is excellent and the characters available make it very flexible. Proportional spacing is an option with the right model typewriter.

• Although the printer is not as fast as some others, the print quality is so superior that I don't mind waiting. The slow speed (15 characters per second) can be compensated for by using the typewriter's margins and tab functions, and is also offset by the 2000-character "spooling" memory buffer in the ETI², which frees the computer from waiting for the typewriter to finish printing.

• By using an inexpensive dot-matrix printer for rough drafts and accounting printouts, this system yields greatest versatility and quality for the least investment. ■



ADLER ROYAL
ET Typewriter
IMPERIAL TRIUMPH

WORD PROCESSING INTERFACE
RS 232c / IEEE 488 Board gives DIABLO 1610 / QUME Sprint 5 Emulation.

Easily fitted Kit gives word processing capability, retains original typewriter features and adds centering; re-locate; auto C/R, Bold and auto under-score.

INTERFACE READY TO INSTALL \$295

Dealer and Distributor Enquiries welcome
AOM TECHNOLOGY LIMITED
Scotia House, 6 Highfield Street,
LEICESTER, ENGLAND.

Circle 449 on inquiry card.

XQL™

MAINFRAME RELATIONAL DBMS
for CP/M, UNIX or IBM PC/DOS

- Powerful query language (IBM's SQL)
- Online INSERT, DELETE, UPDATE, SORT, INDEX, ...
- Screen input/output form generator
- Interactive report writer
- Language interfaces: C, FORTRAN, PASCAL
- Completely menu driven
- SST also offers consulting services and professional training courses

XQL systems start from \$995.00
Manual only \$55.00

Please call or write: (301) 384-3496

SST Software Systems Technology
2401 Kaywood Lane
Silver Spring, MD 20904

CP/M is a trademark of Digital Research
UNIX is a trademark of Bell Labs

Circle 360 on inquiry card.

MEMORY EXPANSION FOR APPLE® The company that brought you the first 32K RAM board for Apple II® and Apple II+® now offers:

- **128K RAM ALL FOR ONLY \$599**
Includes
1. MOVE-DOS (relocates DOS)
2. RAM-EXPAND (for Applesoft®, Integer®)
3. PSEUDO-DISK for DOS 3.3 or 3.2 software packages
4. PSEUDO-DISK for CP/M®
5. PSEUDO-DISK for PASCAL
- **64K RAM \$425**
A medium range memory expansion board which can be upgraded to 128K at a later date. (Upgrade kit sold for \$175) Includes all 5 software packages offered with the 128K board
- **32K RAM STILL ONLY \$239**
The old favorite for Apple users. Includes our first 3 software packages (above) with CP/M® and PASCAL pseudo-disks now offered as options (\$39 each)
- **VC-EXPAND™ MEMORY EXPANSION FOR VisiCalc®**
ONLY \$100
Expand memory available to Personal Software's 16 sector VisiCalc®. Add 32K, 64K, or even 128K to your present workspace (even if you already have a 16K card in use!) with this program plus one or more Saturn boards
Simple operation

313/973-8422

Circle 341 on inquiry card.

AIM-65 PROM PROGRAMMER

PROGRAM PROMS WITH YOUR AIM-65 FULL FEATURED:
-PROGRAM
-VERIFY
-READ
-DUMP TO PRINTER
-MORE

PROGRAMS THESE 5 VOLT PROMS:
2758, 2716, 2732, 2764, 27128, 2508, 2516, 2532, MORE
USES STANDARD AIM-65 VOLTAGES - +5, +24VDC

ASSEMBLED AND TESTED
* **ONLY \$95.00** *
+ \$4.00 shipping & handling

SOFTECH CONSULTANTS
2393 NW 30th ROAD
BOCA RATON, FLA. 33431

TERMS: MONEY ORDER, C.O.D.
PERSONAL CHECK, ALLOW 2 WEEKS
FLA. RESIDENTS ADD 5% SALES TAX

Circle 353 on inquiry card.

SMITH-CORONA TP-1

Letter Quality
Daisy Wheel
12 CPS Text Printer



\$699
computer mail order

east 800-233-8950
In Pa. Call (717) 327-9575
west 800-648-3311
In Nev. Call (702) 588-5654

Circle 446 on inquiry card.

ASC Computers

MULTI-PROCESSING \$100 & MULTI-BUS

68000/09
Z8000/Z80
8088 LSI-11



8086

CUSTOM CONFIGURATIONS

- RAM/PROM MEMORY TO 1 MEG.
- FLOPPYS & WINCHESTERS TO 90 M.
- CRTS, PRINTERS & PLOTTERS
- HI-RES. GRAPHICS DISPLAYS
- COLOR IMAGING & DIGITIZERS
- DATA ACQUISITION - A/D I/O
- COMMUNICATIONS NETWORKS
- UNIX, MP-M, CP-NET RSX.

A 26401 HARPER 313
S ST. CLAIR SHORES 779-8700
C MICH. 48081

Circle 446 on inquiry card.

MICRO-SCI IS IN THE GAME FOR ALL THE APPLES...

μ -SCI

μ -SCI



...WITH A FULL HOUSE OF 5 1/4" DRIVES

Micro-Sci has three disk drives and two controllers so you can configure your Apple II™ or Apple II Plus™ system to fit your individual budget and performance requirements.

THE FIRST ACE — A2

The new A2 is the price/compatibility substitute for the Disk II,™ intended as the second drive on an existing controller, or as a full A2 subsystem. The A2 drive or A2 subsystem is an ideal choice when the drives will be primarily used for entertainment or prepackaged software programs.

THE SECOND ACE — A40

The A40 is a price/performance alternative to the Disk II. With 40 tracks, you get an additional 20K bytes, and faster track-to-track access. The A40 is intended for use in dedicated DOS, CP/M and Pascal applications, and as a companion drive for the A70. The A40 is Micro-Sci's most cost-effective

disk subsystem for the Apple IIs.

THE THIRD ACE — A70

The A70 is the price/capacity alternative. At over a quarter million bytes per drive, the A70 has the capacity of two Disk IIs or on eight-inch floppy, but costs only slightly more than a single Disk II. One A70 supports a DOS file as large as 270K, a CP/M file up to 254K, and 560 blocks in Pascal.

THE PAIR — MICRO-SCI'S CONTROLLERS

The A2 comes with a unique new controller. This controller supports any combination of A2s or Disk IIs, you have complete flexibility.

The A40 and A70 share a common controller. Mix A40s and A70s in any fashion, one A40 with one A70, two A40s or two A70s — all on the same controller.

You can have a Disk II or A2 controller with

Disk II or A2 drives and still add an A40 or A70 subsystem. That's full system-level compatibility.

THE PAT HAND

Versatility, reliability, capability are assured when choosing Micro-Sci. Pick the drive, pick the controller, pick the capacity and function. Whatever your need, DOS 3.2, 3.3, Pascal, CP/M, games or pre-packaged software, Micro-Sci has the drive. Start wherever you choose with the knowledge that you can expand without concern. All Micro-Sci products are backed by a full 120-day warranty (parts and labor).

Our complete line of Apple compatible products makes us the dealer's choice. We're always looking for good dealers.

International dealer inquiries:
International Markets Co., Telex: 69-6191.
TELEX CO LSA

Circle 256 on Inquiry card.

μ -SCI

MICRO-SCI

17742 IRVINE BOULEVARD • SUITE 205 • TUSTIN, CALIFORNIA 92680 • 714/731-9461 • TELEX: 910-346-6739

MICRO-SCI IS A DIVISION OF STANDUN CONTROLS, INC.

* APPLE II, APPLE II PLUS * DISK II * APPLE, APPLE II AND DISK II ARE REGISTERED TRADEMARKS OF APPLE COMPUTERS, CUPERTINO, CALIFORNIA

Ada, MINCE, CP/M Utilities, Overpriced Documentation, and Analiza II

An inveterate user of microcomputers expresses firm opinions on hardware, software, and other subjects.

Jerry Pournelle
c/o BYTE Publications
POB 372
Hancock, NH 03449

One of the nicest things that's come to Chaos Manor is Bill Godbout's (Compupro) M-Drive. I don't see how I got along without it.

M-Drive is a way to fool your microcomputer and thereby make it run faster. First, you add a lot of memory; in my case, I installed some of Compupro's new 128K-byte boards. Then you put in Compupro's M-Drive, which fools your system into thinking that all that memory is really a disk. Thus read and write operations are sent to memory, not disk. You have to see it operate to believe how fast that speeds up programs.

Loading my text editor with Ezekial (my 2-MHz Z80 machine with iCom disks) takes about 30 seconds from disk. The Godbout 8085/88 machine with Godbout's direct-memory-access (DMA) Disk One Controller operating Qume DT-8 double-sided, double-density disks cuts that to less than 10 seconds. With M-Drive, loading is so fast *I can't time it*. Hit Carriage Return and the editor is loaded. The same happens when using the PIP command, or a compiler, or the biggest command file I have.

Do understand the Godbout con-

troller and Qume drives are already very fast, and you must have a Godbout controller to run M-Drive; thus, the savings aren't as spectacular as they might be. Still, it's dramatic enough.

When you get M-Drive, it's set up to be the A drive in your system; whatever you write to A goes into memory, not onto a disk. That works all right, but it could be dangerous because what you save into M-Drive memory isn't really saved and would go away with a power failure. I could live with it, as long as it wasn't addressed as the B drive (B drive is what I save all my text onto, and I'd find it hard to break that habit), but I wouldn't really feel comfortable about not having the material saved permanently.

So, our resident genius Tony Pietsch decided to mess around with the BIOS (basic input/output system) and change things so that the system uses drive M as M-Drive. As Tony says, that's logical.

He's got it going, along with a SUBMIT program (the CP/M batch utility) you can use on power-up to format your new drive and transfer to it most of the files you'll be using.

After which, you log onto disk M and you're in business. Command files load instantly. Long compilations that have to write .PRN (print) files and make symbol tables and so forth go like sin. Posting accounts with my bookkeeping programs run in about 10 percent of the time! With M-Drive it's feasible to use sequential access and fancy searches through your data base.

I'm still appreciating the potentials here. For instance, it's now practical to have enormous programs with big overlays; with M-Drive, you can snatch them in and out as needed without the operator noticing it was done!

It'll even help the word processor. Not, I hasten to add, for straight text creation: you'll still want to save early and often *on disks*, not M-Drive. But for checking spelling and grammar, for working with lots of long files you need to haul in and out of memory, and for anything that involves lots of disk access, you'll love M-Drive.

It's also useful for program editing. You can log onto M-Drive, bring up Wordmaster, and have really fast access to all of a very long assembly

AUTHORIZED

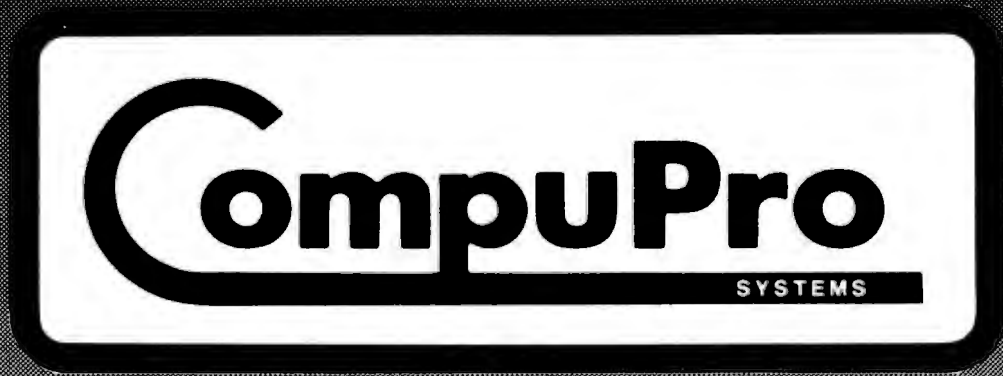

SYSTEMS CENTER

*CompuPro's quality computer products are available from two sources: **Finer Computer Stores Worldwide**, and now, from the growing network of **Authorized CompuPro System Centers**.*

*A **CompuPro Systems Center** is more than a store — it's the first place you should turn to for business, scientific, and industrial computing solutions. Run by professionals for professionals, a **Systems Center** provides the following services:*

- Custom system integration from board level components.
- Courteous and supportive customer training.
- A staff programmer for software installation and customization.
- A staff technician for hardware servicing and upgrading.
- Local service support to keep systems running at peak efficiency.
- Customization and upgrading of CompuPro's high performance, pre-integrated computing systems (Scheduled for introduction later this year).

*That's not all; the proprietors of an authorized **CompuPro Systems Center** maintain full documentation on all **CompuPro** equipment, receive the **CompuPro Courier Newsletter** to keep on top of new products, tips, and pricing, and attend periodic factory training seminars on **CompuPro** products.*

When you're ready for professional level, state-of-the-art micro-computing, turn to the professionals listed below . . . they're ready for you.

BYTE SHOP OF HAYWARD

1122-B Street
Hayward, CA 94541
(415) 537-2983

COMPUTER CENTER

1514 University Avenue
Berkeley, CA 94703
(415) 845-6366

DIGITAL DELI

80 W. El Camino Real
Mountainview, CA 94040
(415) 961-2670

G & G ENGINEERING

1922 Republic
San Leandro, CA 94577
(415) 895-0798

KEY MICROSYSTEMS

978 Tiogue Avenue
Coventry, RI 02816
(401) 828-7270

LOGIC SYSTEMS

4800 Manzanita Avenue
Carmichael, CA 95608
(916) 971-3133

MATRIX COMPUTERS

720 Mendocino Avenue
Santa Rosa CA 95401
(707) 542-0571

MICRO COMPUTER TECHNOLOGY

1549 W. Brandon Boulevard
Brandon, FL 33511
(813) 685-7659

PRIORITY ONE ELECTRONICS

9161 Deering Avenue
Chatsworth, CA 91311
(800) 423-5922 (213) 709-5464

S-100 INC.

14425 N. 79th St. #B
Scottsdale, AZ 85260
(800) 582-3138 (602) 991-7870

1 Mhz - 12 Bit A/D

for your Apple II Computer

The APPLESCOPE-HR12 analog to digital converter uses a high stability buried zener voltage reference and a flash A/D to give 12 bit accuracy with a 14 bit dynamic range.

- DC to 1 Mhz Programmable Sample Rate
- 2048 Sample Buffer Memory
- Pretrigger Viewing
- Continuous or Single Sweep
- 4 Channel Software Support (requires additional power supply)
- External Trigger Input

The standard software provided with each APPLESCOPE-HR 12 includes all of the functions necessary to turn your Apple II computer into a high quality digital storage oscilloscope. In addition all of the SCOPE DRIVER options are being up-graded to handle the higher resolution data.

Price per channel **\$695**

The original APPLESCOPE still provides the optimum price/performance trade off for those users requiring 8 bit converter resolution.

APPLESCOPE INTERFACE

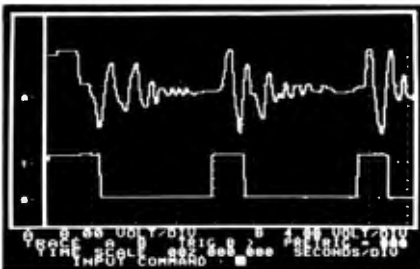

- DC to 3.5 Mhz sample rate
- 1024 byte buffer memory
- Pretrigger Viewing
- Programmable Scale Select
- Continuous and Single Sweep Modes
- Single or Dual Channel Trace

Price for the two board Applescope system is **\$595**
EXTERNAL TRIGGER ADAPTER **\$29**

SCOPE DRIVER Advanced software for the APPLESCOPE analog to digital converters makes full use of the computing power of the Apple II to create a total data acquisition system. Available options include:

- Signal Averaging-Acquires 1 to 999 signal sweeps and displays the averaged result.
- Digital Volt Meter - Allows use as real time DVM or use to measure points on an acquired sweep.
- Disk Storage - Allows automatic storage and recover of acquired data on floppy disks.
- Spectrum Analyzer-Calculates and displays frequency spectrum of acquired data.

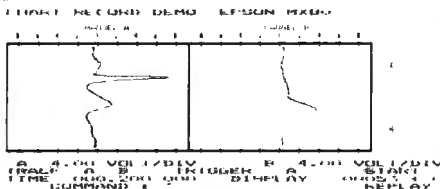

BUS RIDER

LOGIC ANALYZER for the APPLE II

The BUS RIDER circuit card silently rides the Apple II peripheral bus and allows real time tracking of program flow. Software provided allows set up of trace parameters from the keyboard and read back of disassembled code after a program has been tracked.

- 32 bit by 512 sample memory buffer
- Monitors Data and Address bus plus 8 external inputs
- Trigger on any 32 bit word or external trigger
- Pretrigger viewing

The BUS RIDER is an invaluable development tool for anyone working with Apple II or Apple II+ computers.

Price **\$395**

RC ELECTRONICS INC.

7265 Tuolumne Dr., Goleta, CA 93117

(805) 968-6614



User's Column

language program. You do have to be careful to save everything onto a real disk after you exit Wordmaster—or periodically save from within Wordmaster by using the W (Write) command. What I've done is set up a SUBMIT file that uses the PIP command to copy the source from M-Drive to the disk in drive B before it assembles the file in M-Drive. Thus I've always saved the latest version of the source; and assembly (or compilation; we use this with CBASIC2, Pascal, FORTRAN, and C, too) is so fast that losing the compiled code is only a minor inconvenience.

M-Drive makes a microcomputer with 64K bytes of RAM (random-access read/write memory) run like a big minicomputer. Highly recommended.

One warning: be sure you get M-Drive from either Compupro or G&G Engineering. I know of one midwestern dealer selling a pirated version of M-Drive with a disk controller and memory not made by Compupro; it couldn't possibly work, since the controller didn't use DMA.

dBASE II, Version 2.3

I'm happy to endorse the improvements to dBASE II that fix many obscure and a few obvious bugs in the relational database. For example, you can now remove superfluous spaces from indexed files and maintain up to seven index files for the database in use. You can use numerical variables as arguments in the string functions, a major convenience, and there are enhancements to the substring functions.

One of the results of Ashton-Tate's "good guy" policy is that users tend to send them suggestions, which they implement in future releases. Thus dBASE II continues to grow and become more useful.

I fear the documentation is still not all I'd like it to be, but it's improved once again in the new version: now there's an index, explanation of error messages, and more examples. Even

naive users *can* learn dBASE II from the document: I know, because I've watched them do it.

I recommended this program in an earlier column. It's even better now.

Ada and Assured Income

Some predictions are easy to make. For example: if you want to assure yourself of a high salary in the years to come, learn Ada. It's as good as an annuity.

Ada, of course, is the new language supported by the Department of Defense; and as DOD support made COBOL important, their support will keep Ada vital. Named for the first computer programmer, Ada Augusta, Lady Lovelace, Lord Byron's daughter (she programmed Babbage's machines), Ada is a Pascal-like language with some of the elements of PL/I. It is *supposed* to have overcome most of Pascal's defects, particularly in input/output (I/O).

Unfortunately, Ada (once known as DOD-1) was designed by a committee. It has a slew of features, many of which are so specialized that few will see any use for them. The language has grown so large and so complex that no one can possibly understand it, and lately there have been many warnings that bugs in compilers might cause strange side effects and interactions. Some MIT computer science people are concerned that if Ada programs control missiles and bombs, there might be results no one wants.

I wouldn't know. Ada is so large that it is unlikely ever to run on microcomputers; and DOD insists that there cannot be *any* expansions, enhancements, additions, or subsets of Ada. Ada is Ada is Ada, and any Ada program should be compilable on any DOD computer that runs Ada. Portability is more important than convenience or small-system utility. That's the official attitude. You can make your own estimate of how stable it's likely to be. But one thing is certain, knowing Ada can be a valuable skill.

YOUR COMPUTER HEADQUARTERS

apple®

SUPER SPECIAL!

THE NEW APPLE III

Apple III 128K with SOS Package and 12" High Resolution Green Monitor

\$2999⁰⁰



BUSINESSMAN'S SPECIAL

Apple II plus 48K, Apple Disc Drive II w/DOS 3.3, 12" High Resolution Green Monitor, Visicalc 3.3 Software

\$2039⁰⁰



WORD PROCESSOR SYSTEM

Apple II plus 48K, Apple Disc Drive II with DOS 3.3, 12" High Resolution Monitor, OKIDATA Microline 80 Printer, Printer cable w/interface, Apple Writer

\$2339⁰⁰

Apple is a registered trademark of Apple Computer Inc.

ACCESSORIES FOR APPLE

- Videx Videoterm - 80 Col. \$269⁰⁰
- Videx Keyboard \$119⁰⁰
- Enhancer II \$289⁰⁰
- DC Hayes Micro Modem II \$289⁰⁰
- Microsoft 2.80 CP/M Card \$289⁰⁰
- Microsoft 16K Ram Card \$159⁰⁰
- Saturn 32K Ram Card \$199⁰⁰
- VC Expand for Saturn Card \$84⁰⁰
- Mountain CPS \$179⁰⁰
- Multifunction Card \$239⁰⁰
- Mountain Clock \$135⁰⁰
- Keyboard Company \$209⁰⁰
- Numeric Keypad \$135⁰⁰
- Apple Pascal \$209⁰⁰
- CCS High Speed Serial Interface \$189⁰⁰
- System Saver fan with Line Surge Suppression \$74⁰⁰
- Apple Graphics Tablet \$649⁰⁰
- Verawriter Graphic Tablet \$249⁰⁰
- Word!! Game Paddles \$199⁰⁰

WORD PROCESSORS

- IUS - Pro Easywriter \$149⁰⁰
- IUS - Pro Easywriter \$119⁰⁰
- Apple Pie (W/P 40 Col.) \$104⁰⁰
- LJK Letter Perfect \$129⁰⁰
- Supertext II \$129⁰⁰
- Screenwriter (70 Col.) \$104⁰⁰
- Executive Secretary \$199⁰⁰
- Magic Window \$84⁰⁰

PRACTICAL PERIPHERALS

- Micro Buffer II 16K \$214⁰⁰
- Micro Buffer II 32K \$249⁰⁰

Don't tie up your computer while your printer is printing!

FOR EPSON ONLY

- Micro Buffer Parallel 16K \$135⁰⁰
- Micro Buffer Serial 8K \$135⁰⁰

SOFTWARE FOR APPLE

- Fortran 80 \$154⁰⁰
- A.L.D.S. \$99⁰⁰
- Basic Compiler \$295⁰⁰
- Tasc Compiler \$149⁰⁰
- Combol - 80 \$595⁰⁰
- Context Connector \$145⁰⁰
- USA \$49⁰⁰
- Apple World \$339⁰⁰
- 3D Super Graphics \$339⁰⁰
- SENSIBLE**
- The Sensible Speller \$59⁰⁰

SOFTWARE (cont'd)

- MICRO PRO**
- Wordstar 3.0 \$289⁰⁰
 - Spell Star \$189⁰⁰
 - Mail Merge \$94⁰⁰
 - Super Sort-1 \$139⁰⁰

- MICROLAS**
- Data Factory 5.0 \$229⁰⁰
 - Invoice Factory \$159⁰⁰
 - Tax Manager \$119⁰⁰

- HOWARD SOFTWARE**
- Tax Preparer New 1982 \$119⁰⁰
 - NEW! Real Estate Analyzer 2nd Addition \$149⁰⁰

- PERSONAL SOFTWARE**
- Visicalc 3.3 \$189⁰⁰
 - Visiplot \$159⁰⁰
 - Visidex \$189⁰⁰
 - Visitrend/Visiplot \$239⁰⁰
 - Visiterm \$79⁰⁰
 - Visifile \$189⁰⁰
 - Desktop Plan II \$199⁰⁰
 - Desktop Plan III \$253⁰⁰

THE SOURCE

- Telecommunication \$69⁰⁰

- AARDVARK**
- Personal Tax Plan \$104⁰⁰
 - Individual Tax Plan \$239⁰⁰

- SOFTWARE DIMENSIONS**
- Accounting Plus II \$CALL

- ASHTON TATE**
- DBase II \$524⁰⁰

- HIGH TECHNOLOGY**
- Info. Master \$119⁰⁰
 - Store Manager \$199⁰⁰
 - Data Master \$79⁰⁰
 - Job Control System \$595⁰⁰
 - Client Billing System \$279⁰⁰

- SOUTHEASTERN SOFTWARE**
- Data Capture 4.0 40 Col. \$49⁰⁰
 - Data Capture 4.0 80 Videx \$69⁰⁰

- SOFTWARE PUBLISHING**
- PFS New! \$97⁰⁰
 - PFS Report \$77⁰⁰

- PHOENIX SOFTWARE**
- Zoom Graphics \$34⁰⁰

Master Diagnostic (Formerly Brain Surgeon) \$42⁰⁰

STONEWARE

- DB Master Vers. 3 \$179⁰⁰
- Utility Pack I \$79⁰⁰
- Z-Term (CP/M) \$99⁰⁰
- ASC II Express 3.3 \$85⁰⁰
- Brodebund Payroll \$299⁰⁰

GAME AND HOBBY

- Temple of Asphai \$32⁰⁰
- Hellfire Warrior \$32⁰⁰
- Rescue at Rigel \$25⁰⁰
- Crush, Crumple & Chomp \$24⁰⁰
- Jabber Talky \$24⁰⁰
- Major League Baseball \$24⁰⁰
- Apple Panic \$24⁰⁰
- Snack Attack \$24⁰⁰
- Joy Breaker \$24⁰⁰
- Space Quarks \$24⁰⁰
- Genetic Drift \$24⁰⁰
- Red Alert \$24⁰⁰
- Ultima \$32⁰⁰
- Star Thief \$24⁰⁰
- Bug Attack \$24⁰⁰
- Sargon II \$27⁰⁰
- Pool 15 \$30⁰⁰
- Shuffle Board \$24⁰⁰
- Trick Shot \$32⁰⁰
- Dog Fight \$24⁰⁰
- Olympic Decathlon \$24⁰⁰
- Three Mile Island \$32⁰⁰
- ABM \$19⁰⁰
- Robot War \$32⁰⁰
- Castle Wolfenstein \$24⁰⁰
- Zork \$32⁰⁰
- Zork II \$32⁰⁰
- Falcons \$24⁰⁰
- Beer Run \$30⁰⁰
- Raster Blaster \$24⁰⁰
- Space Eggs \$24⁰⁰
- Gorgon \$32⁰⁰
- Cops and Robbers \$30⁰⁰
- Tigers in the Snow \$32⁰⁰
- The Battle of Shiloh \$32⁰⁰
- The Shattered Alliance \$48⁰⁰
- Computer Baseball \$32⁰⁰
- Computer Quarterback \$32⁰⁰
- Sneakers \$24⁰⁰
- TG Joystick \$48⁰⁰
- TG Game Paddles \$34⁰⁰
- Krell LOGO for Apple \$149⁰⁰

FRANKLIN



ACE 100 Personal Computer

A professional personal computer that is hardware and software compatible with the Apple II® and includes many features not found on the Apple®. All peripherals and programs written for the Apple II® can be used with the Franklin ACE 100 without modification including high and low resolution black and white graphics. The ACE 100 is also plug compatible with Apple®.

FEATURES: Apple® compatible. 64K of RAM memory, upper & lower case, typewriter-style keyboard, 12-key numeric pad, alpha lock shift key, Visicalc friendly, 50-watt power supply, built-in fan.

Call for Low Price!

Apple is a registered trademark of Apple Computer Inc.

VP-3501 Videotex Data Terminal
Turn your home TV into a time-sharing videotex display.



Only \$359⁰⁰

Modern built-in!

*** SHARP MINI COMPUTERS ***

PC-1500 LCD POCKET COMPUTER
Extended BASIC system capable of 2 dimens. arrays Full graphic commands.

Now Only \$239⁰⁰

CE-150 Color Graphics Printer with Cassette Interface.
Now Only \$189⁰⁰

4K and 8K Memory Expansion IN STOCK!

*** SHARP MINI COMPUTERS ***

PC-1211 POCKET COMPUTER
Formidable computing power. Prog w/BASIC language. 24 digit LCD.

Now Only \$134⁹⁵

CE-122 16-DIGIT MINI DOT PRINTER
Print out programs.
Now Only \$99⁵⁰

FREE! Cassette Interface (\$50 Value) with purchase of PC-1211. Ltd. Qty

PRINTERS

GRAPPLER Graphic Inter/Cable .139.95
OKIDATA 82A 120 CPS, Bidirectional, Friction and Pin Feed, Serial and Parallel, 80/132 Columns 474.95

OKIDATA 83A 120 CPS, Bidirectional, Friction & Tractor, 136 Col. Serial & Parallel, Takes 15" Paper. 719.95

Tractor Feed, (optional) 54.95
OKIDATA OKIGRAPH™ Create illustrations, Graphs, Charts or whatever a CRT screen tells it to 69.95

CENTRONICS 739-I Graphics, 100 CPS Monospaced Mode, Right Justification, Friction and Tractor 474.95

XEROX Diablo 630 with word processing enhancement 2299.95
Bi-directional Tractor (optional) 204.95

NEW! C.I.TOH F10-40 Parallel, Daisy Wheel, Letter Quality Printer 1499.95
F10 Serial Now Only 1549.95

C.I.TOH 8510 Pro Writer, 120 CPS, 136 Columns, Parallel, Bidirectional, FIT, High Resolution Graphics 499.95

***** EPSON *****
MX-80 III FIT 80-136 Column Dot Matrix, Tractor or Friction Feed, Bidirectional, 80 CPS, Grafix Plus 549.95

MX-80 80 Column 439.95
MX-100III FIT with Grafix plus, 136-233 Column 719.95

MONITORS
SANYO VM-4509 9" B&W 159.95
SANYO DM-8112CX 12" Green 219.95
SANYO DMC-8013 13" Color 389.95
NEC JB 1201 12" Green 179.95
NEC JC1201 12" Color 349.95

commodore

VIC 20 COMPUTER
w/RF Modulator
PRICED TOO LOW TO PRINT



8K Memory Expansion 53.95
Phone Modem iVIC by Bizcom 139.95
DATACORDER (i/Cass. Prog.) 69.95
Jupiter Landers (cart.) 24.95
Super Alien (cart.) 24.95
Midnight Driver (cart.) 24.95
Household Finance (cass.) 29.95
Car Cost (cass.) 13.95
Loan Analyzer (cass.) 13.95
Amok (cass.) 20.95
Alien Blitz (cass.) 20.95
VT 106A 6 Pk. Recreational Prog. 49.95
Super Expender 57.95
Snackman 14.95
Vixel I 11.50
Vixel II 11.50

QUANTUM DATA
RS 232 Interface 47.95
24K Memory 179.95
Amok 20.95
Mini Mother Expansion Interface 64.50

Texas Instruments



TI 99/4A COMPUTER
NEW LOW PRICE \$329⁹⁵
FREE! RF Modulator with purchase of TI 99/4A (\$50 Value)
Extended Basic In Stock!
Full line of hardware, software and accessories in stock!

ATARI
ATARI 800 w/16K \$649⁹⁵
ATARI 400 \$329⁰⁰
810 Disc Drive \$459⁹⁵
850 Interface \$179⁹⁵
410 Programmable Recorder \$79⁹⁵
Axlion 32K Ram \$129⁹⁵
POPULAR ATARI GAMES IN STOCK!

hp HEWLETT PACKARD



HP-87A
Rapid Programming Power!

Has 32K bytes of user memory, expandable to 544K. Versatile alphanumeric keyboard. High resolution CRT. Built-in HP-IB interface, printer and mass storage firmware. Built-in BASIC and operating system.

New Low Price \$1884⁰⁰
32K, 64K and 128K Memory Expansion Modules **In Stock!**

Special! HP-83 (Ltd Qty.) \$1295⁰⁰
HP-85A Now Only \$1982⁰⁰
HP-125 Reg. *2750 Only \$1982⁰⁰

HP 82091M 5 1/4" Disc Drive \$1650⁰⁰
HP 82905 Serial Printer \$595⁰⁰
HP 7470A New Plotter \$1269⁰⁰

We carry the full line of TI and HP Programmable Calculators.

47st. photo
Cameras • Electronics • Audio • Video • Computers • Darkroom • Accessories

67 West 47th Street, New York, N.Y. 10036
115 West 45th Street, New York, N.Y. 10036
MAIL ORDER ADDRESS: 36 E. 19th St. New York, N.Y. 10003

Items on sale for limited time only, and are subject to limited availability. Not responsible for typographical errors. This ad supersedes all other ads prior to July '82. Prices effective as of May 25, 1982 and are subject to change without notice. All orders subject to verification and acceptance. Minimum shipping and handling \$4.95.

CORPORATE ACCOUNTS WELCOME (212)260-4410
TOLL FREE OUT-OF-STATE
800-221-7774
800-221-5858
800-223-5661



You can count on—

MICRO Express

apple computer

Hayes Micromodem II	\$ 289
Z80 Card	\$ 259
16 K RAM Card	\$ 99
Thunder Clock	\$ 105
Video 80 Col. Card	\$ 265
Station II	\$ 105
LOBO Drive	\$ 389

SOFTWARE

Visicalc	\$ 199
Visifile	\$ 215
Visidex	\$ 199
Visiplot	\$ 175
Visitrend	\$ 245
Desktop Plan II	\$ 199
BPI Accounting	\$ 299
Wordstar	\$ 289
DB Master	\$ 159
Easywriter	\$ 129
Datadex	\$ 135

ATARI

Atari 800, 16K	\$ 679
Atari 400, 16K	\$ 329
Other Atari products	CALL

NEC

PC-8001 A Computer	\$ 799
PC-8012 A I/O	\$ 495
PC-8031 A Disk Drives	\$ 799

MONITORS

Zenith, Green	\$ 115
NEC, Green	\$ 175
NEC, Color	\$ 349
AMDEK, RGB Color	\$ 750

PRINTERS

MX 80	\$ 450
MX 100	\$ 750
NEC 8023	\$ 525
Diablo 630	\$2299

CORVUS

5 MB Hard Disk	\$2595
10 MB Hard Disk	\$4345
20 MB Hard Disk	\$5245

TCS ACCOUNTING SOFTWARE

GL, AR, AP, Payroll 8", CP/M	\$69EA
ALL 4	\$ 235
Inventory, 8" CP/M	\$ 199

TOP QUALITY

ATHANA DISKETTES

5" SS/SD	\$2.15
5" SS/DD	\$2.30
5" DS/DD	\$ 2.99
8" SS/SD	\$ 2.50
8" SS/DD	\$ 3.19
8" DS/DD	\$ 3.30
Hard pack & bulk available. 100% Guaranteed!	

Dealer Inquiries Invited

Price includes 3% cash, prepaid discount. Money Orders or Cashier Checks. Personal checks allow 3 weeks to clear. We accept VISA & Master Charge. NO COD. Prices subject to change. Add 3% shipping. Min \$3.00. Large items shipped freight collect. Calif. residents add 6% sales tax. FREE DELIVERY ON PREPAID ORDERS

MAIL ORDER SALES

MICRO Express

P.O. Box 21418
San Jose, CA 95151-1418

408-274-1217

User's Column

I'm no expert on Ada; but people who are tell me the first thing to do is get *The ADA Programming Language*, by I. Pyle (Prentice-Hall, 1981). Unlike many programming language books, this one is more or less readable. After you have Pyle's book, you can buy or send away for the Government Printing Office document *The ADA Programming Language* (US GPO MIL-STD-1815), which contains the Ada standard. It won't do you much good. It's absolutely opaque, as close to unreadable as anything you'll ever encounter, but you might some day need to look up something in it.

And finally, you can shell out \$300 to RR Software for Janus, an 8080 Ada compiler.

Janus is not complete Ada. No compiler designed to run on a micro-computer could be. It doesn't work as smoothly as its writers would like, either. It's slower than they care for, and programs benchmark-tested in Ada come out pretty low on the list—at least for the kinds of programs that get benchmarked.

Where Janus is supposed to shine is in optimizing calls to procedures and in giving error messages to the users. The compiler takes five passes: the first finds syntax errors at about 500 lines per minute, the next three passes write the code, and the last goes back and fixes some things so that you can have gigantic procedures. If you were mad enough to write a 4500-line program consisting of a single call to one long procedure, it would compile it. They tell me it takes about 25 minutes for Janus to compile the Janus compiler, which is about 4800 lines.

The Janus documents are more than adequate, if badly misspelled. There's no index in my present copy, but as I write this, RR Software is putting out a new version with completely rewritten manuals. RR Software promises to include an index and to use a spelling checker, probably *The Word*. The manual I have gives lots of examples, but my son Alex says not enough. Certainly

you'll need a good book on Ada in addition to the Janus manual.

The current version of Janus does not have segmented compilation—that is, the ability to compile in chunks and link them and to do program swapping. RR Software is working on those and will furnish the update free to those who buy early versions that don't have segmented procedures. RR Software says that by the time this is published, it'll have all that done. (Note: I have recently received version 2, and it has a better manual and faster compiler.)

I haven't done much work with RR Software's Ada. I know it works from others who've used it; and at the moment, it doesn't have much real competition, certainly not in its price range. I know Supersoft has an Ada, but the company doesn't seem willing to send review copies—at least it doesn't answer letters. Thus, I've no idea what its product is like. Supersoft's ads don't mention data types.

The present Janus compiler is written in Janus; the original one was written in Pascal/MT+. There are many features reminiscent of MT+ in Janus.

I don't know how useful Ada will be for microcomputers; but I do repeat that learning Ada is good job insurance and having Janus running on your machine should help a lot.

More on Janus as I learn more.

MINCE Is Not Complete EMACS

EMACS is the full-screen editor developed at MIT's Computer Science Laboratories. Much (perhaps all) of it was written by Richard M. Stallman (RMS@AI to those in the know). EMACS runs on the DEC PDP-11 and on the LISP machines and has become the artificial intelligence community's favorite text editor.

Given the truly horrible editors that were in use before EMACS, that's easy to understand; and if MINCE, an 8080/Z80 subset of EMACS, had no competition but ED (CP/M editor utility), MINCE would own the microcomputer world. However, by the time EMACS was trans-



AIM 65. The professional's microcomputer.

Printer, display, full keyboard. Only \$465.00.

For professional learning, designing and work, Rockwell's AIM 65™ microcomputer gives you an easy, inexpensive head start.

- 20-column printer and display
- Dual cassette, TTY and general purpose I/O
- R6502 NMOS microprocessor
- System expansion bus
- Read/write RAM memory
- PROM/ROM expansion sockets
- Self-prompt interactive monitor firmware
- Terminal-style keyboard
- Options available include:
 - PROM programmer module
 - RM 65 standard modules and card cages
 - power supply and enclosure

For more on the AIM 65 microcomputer and how you can develop programs in assembly language, BASIC, PL/65, Pascal or FORTH*, write Rockwell International, Electronic Devices Division, RC55, P.O. Box 3669, Anaheim, CA 92803. For location of nearest distributor or dealer call 800-854-8099 (in California 800-422-4230).

*FORTH is a trademark of FORTH, Inc.
AIM 65 is a trademark of Rockwell International



Rockwell International

Circle 115 on inquiry card.

...where science gets down to business

IN A WORLD FULL OF MEDIA HYPE, HOW DID DYSAN COME SO FAR SO QUIETLY?

Or so fast? We didn't become a \$100 million-plus company in less than nine years by producing just any magnetic media. We did it by making the best. The best in disc packs. In single rigid discs. In disc cartridges. In diskettes. And in mini-diskettes. Many major OEM's have recognized the difference that Dysan quality can make. And have endorsed it with their own private label.

Today, there are sales offices and distributors in the United States and

throughout the world, selling and servicing Dysan precision magnetic media... to OEM's, end users and retail outlets. If our media was just like everyone else's, we never would have come this far this fast.

Precision magnetic media from Dysan. Our media says it all.

For the location of the Dysan sales outlet nearest you, contact Dysan at:
(408) 988-3472 Toll Free: (800)
538-8133 Telex: 171551 DYSAN
SNTA TWX: 910-338-2144

Dysan Corporation, U.S. Sales Offices:

CA: Los Angeles (213) 907-1803, Orange County (714) 851-9462, Sacramento (916) 966-8037, San Francisco/Sunnyvale (408) 727-9552; DC: Washington (703) 356-6441; GA: Atlanta (404) 952-0919*; IL: Chicago (312) 882-8176, (800) 323-5609; MA: Boston (617) 273-5955, (617) 229-2800*; MI: Detroit (313) 525-8240; MN: Minneapolis, (612) 814-7199*; MO: St. Louis (314) 434-4011; NY: New York (212) 687-7122; OH: Cleveland (216) 333-3725; PA: Pittsburgh (412) 261-0406, Philadelphia (609) 939-4762; TX: Dallas/Ft. Worth (817) 261-5312*; WA: Seattle (206) 455-4725.

* Includes OEM Sales

Dysan Magnetic Media is also available Worldwide:

Argentina, Australia, Austria, Belgium, Brazil, Canada, Chile, Colombia, China, Denmark, Ecuador, Finland, France, French Polynesia, Greece, Guatemala, Hong Kong, Iceland, India, Israel, Italy, Ireland, Japan, Korea, Malaysia, Martinique, Mexico, Netherlands, New Zealand, Norway, Peru, Philippines, Puerto Rico, Saudi Arabia, Singapore, South Africa, Spain, Sweden, Switzerland, Taiwan, Thailand, United Kingdom, Uruguay, Venezuela, Western Germany.

Dysan Flexible Diskettes are also available from all Computerland Stores, Sears Business System Centers, and many independent computer outlets nationwide.



Dyson
CORPORATION

Our Media Is Our Message

5201 Patrick Henry Drive
Santa Clara, CA 95050

Circle 145 on Inquiry card.

lated into MINCE, we had other full-screen editors, so MINCE hasn't had things all its own way.

I don't much like MINCE. My dislike is largely prejudice; and do understand that there are many, many programmers who can't praise MINCE highly enough. At G&G Engineering, at Sorcim, and in software house after software house, the programmers have gone over to MINCE and would rather fight than switch.

So what's so good about it?

First, it does work. If I had to choose between MINCE and Wordstar, I'd be hard pressed; MINCE is a better programming editor and is more than just adequate for document preparation. It doesn't print—to print your text you need a separate format program, such as Mark of the Unicorn's Scribble—but that's not an insuperable handicap. Wordstar doesn't *really* integrate editing and printing either; in Wordstar, editing and printing are separate functions accessible from the main menu.

Of course WRITE, the program I use, does have both print and edit; it's very easy to watch the Diablo, spot an error, stop the print job, fix the error, and restart at the top of the page; and somehow fate has arranged that some errors can't be spotted until they're on paper. You can't do that with MINCE, but then you can't easily do it with Wordstar either.

MINCE, unlike Spellstar, has no built-in spelling program, but The Word, or Microproof, or Spellguard used with MINCE would be just about as fast and convenient.

Other good features of MINCE are "windows" and multiple buffers. You can work on two documents at the same time, editing each in turn, and even transferring text from one document to the other. Chunks of each document can be visible on the screen simultaneously if you like. This is a powerful feature, and one I wish my favorite editor had.

I suspect the reason MINCE is so popular with programmers, though, is that it's not merely an editor, it's a

program. If you're a real hacker, you can rewrite MINCE to suit yourself: rearrange the commands, change the whole command structure, and add macro instructions, complex commands, and features. You can tailor MINCE so that it knows what language you're programming in, and if you're very clever, you can use MINCE to find a number of syntax errors like unbalanced parentheses, missing semicolons, and the like.

MINCE Insists on telling me things I don't want to know.

MINCE is written in Leor Zolman's BDS C (B. D. Software C) and comes with an experimental linker, which Mark of the Unicorn won't guarantee to work with any arbitrary BDS C programs but will guarantee to work with all of its programs. Along with this linker you get *some* of the C source code for MINCE, plus .CRL, relocatable, object-code files for the rest. With those and some ingenuity and hard work, you can merrily change and extend MINCE and then try to debug your changes.

However, the ordinary microcomputer user is unlikely to find any of this useful. You have to know the C language and a lot about MINCE, and to find out a lot about MINCE, you have to wade through some three pounds of documents.

Those documents are almost adequate for learning MINCE. Sometimes, useful information is hidden in some pretty obscure places: it took me *weeks* to find out how to enter Auto Fill mode—that is, to make the machine wrap words from one line to the next without my having to hit Carriage Return. The information was in the document; but it wasn't in the index, and there was no example of its use, probably because the document writer used it so often it was easily overlooked.

But the documents are useful. The editor works, and it is a full-screen editor. Why, then, don't I like it?

I'm not really sure, which is why I warn you not to place too great weight on my opinion. I do have some specific critiques.

First, MINCE, as does EMACS, uses the "kill" (delete) mechanism for text moves. That is, if you erase any text longer than a single character, MINCE saves that in a stack, and the next time you hit Control-Y, the last item killed is "yanked" back in to be placed at the current cursor position. The next Control-Y gives back the next-to-last killed text, and so forth.

I find that intolerable. Suppose I locate some text I want to move. I kill it; then I go where I want to put it. That, however, requires some rearrangements, and a couple of lines need to be deleted. I kill them, and then I've got to take them back, yank them, and stash them somewhere, because they're now at the top of the kill stack and what I want is underneath them.

I greatly prefer the system used by WRITE and Electric Pencil, in which you mark text for later movement, or even Wordmaster's mini-buffer, in which you can store text and later recover it. I see no reason to combine the kill and move functions the way EMACS and MINCE do.

Like Wordstar, MINCE will not automatically rejustify your text. If you're in Auto Fill mode and go back and insert or delete from a previously written paragraph, you must command the editor to rejustify everything; it won't do it "automagically."

Another of my objections to MINCE is that, like Wordstar, MINCE insists on telling me things I don't want to know. Again following EMACS, MINCE has two status lines at the bottom of the screen. One tells you what editing mode you're in, what percentage of the document is above the cursor, and other such information; the other comes into existence when you're typing one of MINCE's long command lines, "Escape Meta Control-X Fill Space" or something of the sort. These distractions are omnipresent, while I prefer my screen to hold nothing but

RM/COBOL™¹ MAKES IT ACROSS!

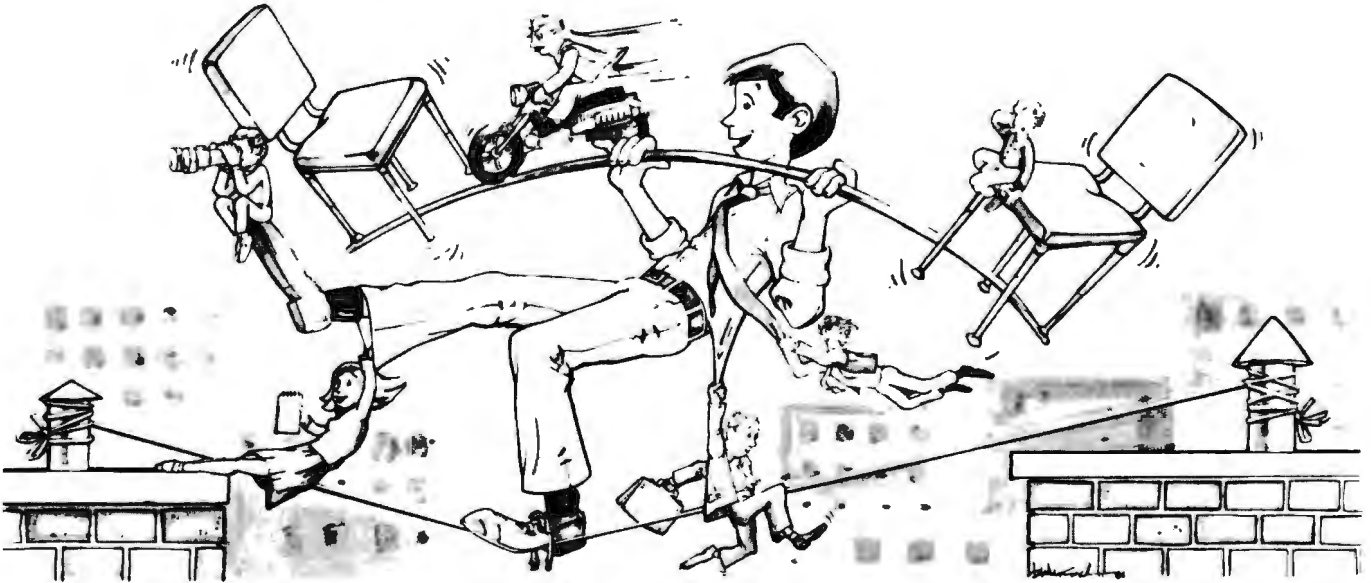

**...FROM ONE OPERATING SYSTEM TO ANOTHER!
A VITAL WAY TO PROTECT YOUR SOFTWARE INVESTMENT FOR THE FUTURE!!**

The **RM/COBOL** language runs on more different Operating Systems and more

different-sized computers than any other similar language. For starters, it runs on NCR and TI minicomputers and, in the micro field, on the CP/M², MP/M³, CP/M86⁴, MP/M-86⁴, TRSDOS⁵, OASIS⁶, MOASIS⁶, and UNIX⁵. (ONYX version) Operating Systems ... to mention only a few.

Until now, serious business software of the scope and flexibility seen in the minicomputer world has not been available on micros. **RM/COBOL** now allows transfer of such software with a minimum of fuss.

We have participated in such a mini-to-micro transfer of a major set of general business software ... using **RM/COBOL** as the transfer mechanism, of course. Running on literally thousands of minicomputers, these refined, enhanced, and proven software packages cover A/R, A/P, G/L, P/R, Order Entry (with Invoicing and Inventory Control) as well as Sales Analysis. The Packages define a new level of achievement for features and flexibility in micro applications software and offer top quality at a reasonable price.

For immediate information, call 714/848-1922 for your complete product descriptions.

Trademarks of:

1-Ryan-McFarland Corp.; 2-Digital Research, Inc.; 3-Tandy Corp.; 4-Phase One Systems, Inc.; 5-Bell Telephone Laboratories, Inc.; 6-Cybernetics, Inc.

RM/COBOL and CRT!™⁶ from CYBERNETICS ARE GOING STEADY...

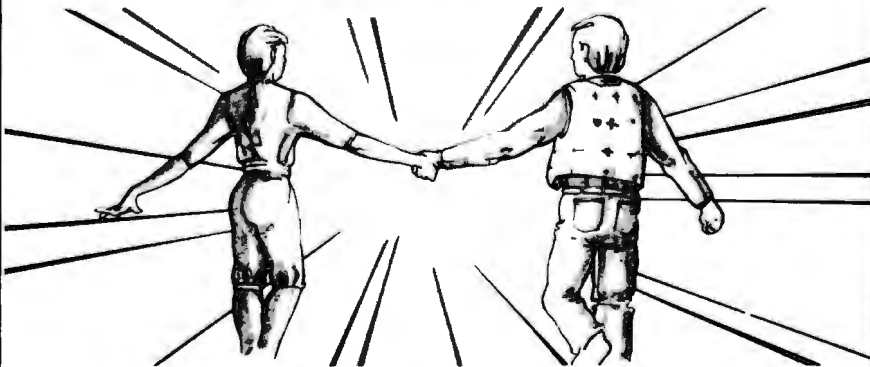

...AND YOU'RE GONNA LOVE 'EM TOO!!

Use your computer to program itself. **CRT!** (Cobol Reprogramming Tool!) from Cybernetics is a program generator for **RM/COBOL**, that produces error-free **RM/COBOL** source programs for data input, file maintenance, and report printing programs.

A full feature interactive program generator, not a subset! Call Now! 714/848-1922.



8041 NEWMAN AVE., SUITE 208
HUNTINGTON BEACH, CA 92647
714/848-1922

my text. If I want information, I know how to ask for it; it needn't be volunteered.

Finally, I don't care for the MINCE "philosophy" of commands. Now do understand: MINCE commands are for the most part logical. Control-f moves the cursor forward a space, Control-b moves it back a space, Escape-f moves it forward a word, and Escape-b moves it back a word. There are commands to move by line, sentence, and paragraph. There's a simple way to insert arguments before a command: you just press Control-u, then 5, then Control-f, and the cursor moves five spaces forward. And so forth.

Many writers and programmers like that command structure. It drives me nuts, I suppose because I'm used to the WRITE commands, which are similar to the Electric Pencil system I learned. I think it's more than pure prejudice: that is, I believe that having the cursor commands laid out in a

small cross-shaped pattern near the control key is better than scattering them across the keyboard as EMACS does. And certainly I prefer being able to use the repeat feature of my keyboard. You can't with MINCE because most of the really important commands need two keystrokes, the Escape key and something else.

Having said all that, I also have to repeat that many writers and programmers like MINCE a lot; and even I'll admit that if I didn't have either Wordmaster or WRITE (for programming and text creation, respectively), I'd probably use MINCE to replace the missing one.

Overpriced Documentation

I do more public speaking than I ought to. Even at my outrageous fees, it rarely pays enough to justify the time investment. Thus I turn down more engagements than I accept, and I almost never speak for free. There are exceptions. A few months ago,

Stephanie Rosenbaum called to ask if I'd be keynote speaker to a meeting of the Special Interest Groups on System Documentation and Office Automation of the Association for Computing Machinery. The meeting would be in Los Angeles, and it wouldn't take long, and it's an important group, and. . . .

If it hadn't been Stephanie, I'd have said no, but she's special. Stephanie is an old friend of Larry and Marilyn Niven, and she has a useful psychic power: put Stephanie in any city of the world, and she will unerringly lead you to a good restaurant. And since she goes to many of the same conventions I do, I figured it would be well to keep her goodwill. After all, I might be stuck in—but no, I may have readers there.

Anyway, I spoke to the groups, pointing out that the pairing of these special interest groups prompted an interesting insight: the reason we don't yet have the "paperless office,"

Computer Channel

Best Price • Good Quality • Swift Delivery • Export

COMPUTER	PRINTER	SOFTWARE
<p>*The Best Graphic Personal Computer*</p> <p>LNW 80 I Z80A, 65K, 480 x 192 . . . 1,395 w/CPM compatible . . . 1,670 II 125K, CPM compatible . . . 2,100 RGB interface . . . 125</p> <p>*Multiuser Business/Engineer* Best Price Anywhere</p> <p>CROMEMCO CS1 5 1/4" floppy . . . 2,958 Z2H hard disk system . . . 7,395 CS3 64K, 8" . . . 5,918 CS1D2E 256K RAM, 86000 & Z80 . . . 4,087 DYNABYTE 5200 84K, 1MB, Z80A . . . 3,300 5605 84K, 8MB hard d . . . 6,550 SWTPC S/O9 128K (UMIFLEX) . . . 3,450 /O9 84K . . . 1,835 *8609* 69A 8K . . . 1,799 1 MB RAM, NEW . . . call</p> <p>*Professional/Word Process*</p> <p>ZENITH Z90-80, 84K . . . 2,290 Z90-82, 84K, 1 disk . . . 2,490 Z89, 46K, 1 disk . . . 2,130 Z37 1.2MB Drives . . . 1,450</p> <p>NORTH STAR HORIZON, 2 quad drives, 64K . . . 3,200 ADVANTAGE, 2 quad drives, 84K . . . 3,100</p> <p>*16-bit CPU*</p> <p>WICAT S150 1FS 1-user . . . 7,520 256K RAM, CRT, 2 floppies *86000* S150 WS 1-user . . . 8,999 256K RAM, 10MB hard disk, 960KB floppy CRT, OS + 1 language S150-3 WS 3-users . . . 10,800 same as S150 WS S150-6 WS 6-users . . . 12,800 512K RAM same as S150 WS Graphics 300 x 400 . . . 900 6510A w/CRT . . . 6,000 320 x 240, DD *LSI/11 graphic* 8600 w/13" color . . . 17,000 monitor, 640 x 480 ALTOS ACS8600-10 500KB . . . 10,000 RAM, 10MB hard disk, *8088* 500KB floppy multiusers DEC PDP/11, VAX780, MINC . . . call ATARI . . . call</p>	<p>Integrat Data System</p> <p>PRISM 80 150 cps, 80 col. . . . 740 w/graphic 64 x 84 . . . 820 W/color & graphic . . . 1,120 W/all options . . . 1,340 132 col. . . . 1,050 PRISM 132 w/graphics 84 x 84 . . . 1,130 w/color & graphic . . . 1,430 w/all options . . . 1,650</p> <p>EPSON MX80 w/Graftrax . . . 439 MX70 . . . 315 MX80 F/T Graftrax . . . 539 MX100 . . . 719 PC-8023A . . . 480 ANADEX DP-9500 . . . 1,300</p> <p>*Letter Quality*</p> <p>DIABLO 630 . . . 2,095 C.I.TOH Starwriter F-10 . . . 1,350 QUME 9/35 R.O. . . . 1,800 BROTHER HR-11 excellent . . . 950 OKIDATA Microline 80 . . . 385</p> <p>MONITOR</p> <p>ZENITH 12" green . . . 114 AMDEK COLOR II RGB 13" . . . 759 COLOR I 13" . . . 350 300 G 12" green . . . 179 SANYO 13" color . . . 445 13" RGB . . . 959 NEC 12" green . . . 170 12" color . . . 330 BMC 12" green . . . 185 12A 12" green . . . 99</p> <p>TERMINAL</p> <p>ZENITH Z19 . . . 635 HAZELTINE ESPRIT . . . 840 BEEHIVE DM5 smart ter. . . 800 IBM 3101-10 . . . 1,195 3101-12 . . . 1,225 3101-20 . . . 1,400 SWTPC 8212 intelligent . . . 1,050 TELEVIDEO 910 . . . 825</p> <p>MODEM</p> <p>HAYES Smartmodem . . . 229</p>	<p>database \$</p> <p>dBASE II Ashton-Tate . . . 575 CONDOR I . . . 250 II . . . 450 III . . . 850</p> <p>financial (AR, AP, Inventory etc.) Accounting Plus Software Dimension . . . 450</p> <p>other VISICALC . . . 199 MICROSOFT softcard . . . 330 FORTRAN 80 . . . 345 BASIC 80 . . . 285 BASIC Compiler . . . 310 SUPERCALC Sorcim . . . 250 Micro Pro WORDSTAR . . . 285 MAILMERG . . . 105 SUPERSORT I . . . 165 CP/M 2.2 Digital Research . . . 130 Many other software . . . CALL</p> <p>Mailing Label w/sort . . . 200 For Accounting Plus All Software . . . CALL Custom-made software for local</p> <p>DIGITIZER/PLOTTER</p> <p>HOUSTON INSTRUMENT HI PAD DIGITIZER DT-11 11" x 11" . . . 725 DT-11A w/APPLE interface . . . 750 HILOT DMP-2 6 1/2" x 11" . . . 975 COMPLIT DP-11 4000 steps/sec . . . 4,000 8411A PRINTER/PLOTTER . . . 5,200</p> <p>CALL (212) 937-6363 free consultation, catalogue</p> <p>Prices subject to change, American Express, Visa/Mastercard add 3%. F.O.B. point of shipment. 20% restocking fee for returned merchandise. Personal checks take 3 weeks to clear. COD on certified check only. N.Y. residents add sales tax.</p> <p>21-55 44th Road L.I.C., NY 11101 *special</p>

LOOK
 14.4 MEGABYTES
 UNFORMATTED
 11.3 MEGABYTES
 FORMATTED



LOOK
 \$2495
 Complete
 Subsystem

INEXPENSIVE MASS STORAGE

Gallium 10, 20, 30 & 40 megabyte disk systems are the **MOST** cost-effective winchester disk systems for your Apple® II computer.

The Gallium-10 is available in a 10 Mbyte configuration for an introductory price of **\$2495**.

GALLIUM IS VERY ECONOMICAL

For the price of 4 disk drives you can have the capacity of 72 diskettes and our Volumes are 3 Apple diskettes' capacity. That means you can have over 400 kilobytes files without segmenting your data base.

With our intelligent controller you can expand to 40 megabytes with the addition of 3 more 10 Megabyte drives.

We use proven winchester disk technology to assure you of the finest quality disk drive your money can buy. The disk drive operation is **NOISE-FREE** for office and home environments.

GALLIUM SOFTWARE

The Rom-resident software interfaces to DOS 3.3, Apple Pascal (optional) and CP/M (optional). All operating systems remain unmodified so there is no need to change anything in your programs to use the Gallium-10.

Utilities provided include programs to copy from floppy to Gallium and from Gallium to floppy, format volumes, and a demo program to show you how your disk can be used.

SERVICE

Gallium-10 disk drives come with a 90-day parts & labor warranty. An extended warranty is available

at extra cost. Gallium disk systems require no preventive maintenance.

SPECIFICATIONS:

DATA ORGANIZATION

Capacity (Megabytes)
 Unformatted 14.4 Megabyte
 Formatted 11.3 Megabyte

DISKS

Number 3
 Data Surfaces 6
 Diameter (Inches/cm) 5.25/13.33

PERFORMANCE

Access Time Track To Track (3 milliseconds)
 Disk Rotational Speed 3600 rpm
 Peak Transfer Rate 5 MB/S

UTILITIES

Format Formats All Surfaces
 Volume Initer Initializes With An "EMPTY" File
 A Given Number Of Volumes
 File Finder Finds All Volumes On Which
 Any Given File Is Resident
 File Runner Finds & Runs The Given File
 From The First Volume On
 Which It Is Resident
 Partition Partitions The Disk For DOS 3.3,
 CPM & PASCAL Allocating
 The Required Number Of Sectors
 For Each Given Operating System
 CPM Boot Permits Booting
 In CPM Operating System
 PASCAL Boot Permits Booting In PASCAL
 Connect Connects Gallium To DOS
 If Booted From Floppy Disk

* Apple is a registered trade mark of Apple Computer Co.

XITENSYSTEMS

16815 Hawthorne Blvd. • Lawndale, CA 90260 • (213) 370-3966
 (800) 421-1947

Main/Frames

Main/Frames

from
\$200

- 30 Models of Enclosures
- Assembled and tested
- Quasi-Coax Motherboards
- Power Supply
- Card cage and guides
- Fan, line, cord, fuse, power & reset switches



8" Floppy Main/Frame

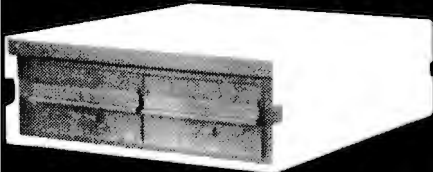

8" Disc Enclosure



Phase/80 8" Floppy Mainframe



Phase/80 Desk + Mainframe

Write or call for our brochure which includes our application note:
"Building Computers — A Recipe"

INTEGRAND

8620 Roosevelt Ave. • Visalia, CA 93291
209/733-9288

We accept BankAmericard/Visa and MasterCard

User's Column

that unfulfilled dream of the office automators, is that we don't have anything like decent system documentation. And the reason we don't have good documentation is because companies will pay their programmers well but figure any damned fool can write. So if they bother to hire writers at all, they generally take few pains in choosing them and pay them no better than they do the janitor. The results are obvious.

One result is that executives look over the instructions for the new personal computer the company wants to give them and have the computer installed in a closet accessible to the secretaries. Secretaries can admit they don't understand how to use the thing. A vice-president can't, and because it's obvious to him that he could read those instructions until he was blind and he still wouldn't know how to use the system, he's not going to be seen to fail, which is why the automated office never gets past the reception room.

All this is obvious and fits nicely into my tirade about software prices and Levitical documentation. I have here a catalog of software prices. Ignoring program prices, I look at the cost of manuals only: most run \$30 and up. A few are lower in price. Take Digital Research's SID (Symbolic Instruction Debugger), an advanced DDT (Dynamic Debugging Tool), quite useful if a bit overpriced at \$195. The manual costs \$15, and for that you get sixty-nine 8½ by 11 pages of *typescript*. About half those pages are incomprehensible.

What does it cost to produce 70 pages and perfect bind them into a soft cover? Well, let's do it the expensive way: go to a local offset house, and you won't pay more than 3 cents a side. That's \$2.10. Add a report cover, and you're up to \$3. I suppose I *could* manage to spend \$4, but I'm also certain Digital Research didn't. Assume \$1 shipping, and sell these to distributors at perhaps 40 percent of the cover price, or \$6; you make \$2 per copy, 50 percent return on investment. Not bad for a backlist item

whose development costs have been written off long ago.

And have you ever tried to *read* that manual? Just open it at random. You get brick walls of type and lengthy paragraphs that cover several topics each, all written by someone trained to use lots of technical words and few examples. Why is this?

Nor am I trying to single out Digital Research, because by and large it plays more fairly than others. Its manuals are among the lowest priced. To some extent I suppose the sale of manuals helps make up for the thefts of the programs the manuals describe. If people give programs away, the recipient still must get manuals.

I suppose that's the reason companies would give for charging \$50 and up for books that can't cost a tenth of that to produce. I might even agree that's reasonable—if the manuals were useful. But often they aren't.

I have two remedies for bad documentation. First, it's easier to teach a good writer what programs do than it is to teach a good programmer how to write. True, there are a few happy instances of hackers who are also good writers, but not very many. Usually the talented writer is not a brilliant programmer, while the good programmer is more easily comprehended by his machine than by mere humans. Good writers can, however, be taught the elements of programming. They can learn what programs do, and they can learn how to *use* the programs.

So the first remedy is to hire people who can write. And don't assume that because they have degrees in English, or "communications," or, God save us, "technical writing," they know what they're doing. The real test is whether you can read and understand what they've written—and whether they can make you *want* to read it.

Isn't that reasonable? After all, your customers are presumably interested in your product. You have their attention. So why should your

Practical Basic Programs

IBM PC Edition

Edited by Lon Poole
Adapted to the IBM Personal Computer by David Wilson
There are 40 fully-documented, ready-to-run programs for the IBM Personal Computer. You can get started now with no previous programming knowledge. You can income average, figure accrued interest on bonds, reconcile checking accounts, perform home budgeting, figure continuous interest compounding, and other financial tasks. With these simply written programs you'll solve your most difficult home and office problems at a cost of less than one program.

#80-931988-80-2 \$15.99

Microcomputer Design Guide

Robbins

A "how-to" oriented book on the principles and concepts of microprocessors doubles as a practical guide to microcomputer design as a whole. Using the 6809 as a model, Robbins leads the reader step by step through an overview of the microprocessor method.

#81-9 \$19.95

CP/M User Guide

2nd Edition

Hogan

The new revision includes expanded sections on CP/M® 86 and CP/M® 80 and on CP/M as related to assembly language programming. There are discussions on MP/M™ and CP/NET operating environments along with proper perspectives in terms of their uses.

The basics you need to get started plus advanced material on program modification and development—this is *the* book on CP/M.

#82-9 \$12.99

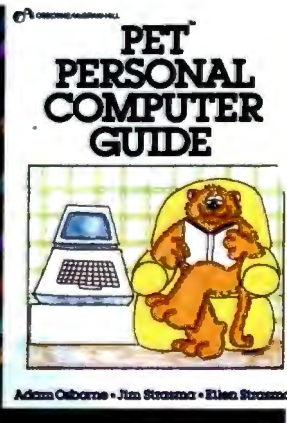
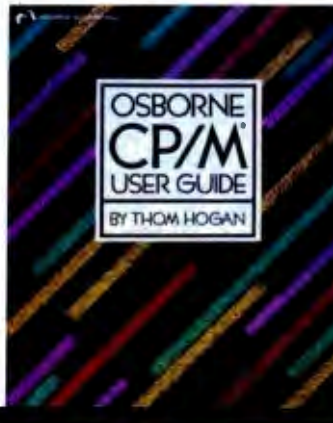
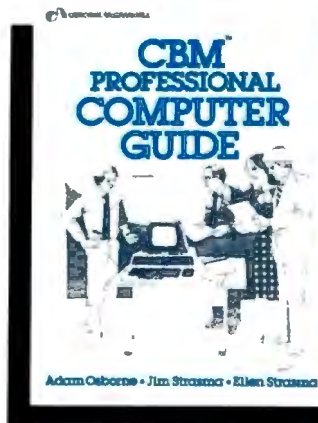

Microcomputer User Guides THE OSBORNE SUMMER LINEUP

The HP-IL System: An Introductory Guide to the Hewlett-Packard Interface Loop

by Gerry Kane, Steve Harper, David Ushijima

This is the definitive guide to the new Hewlett-Packard Interface Loop. The Loop is a bit-serial interface that links the HP-41C or the HP Series 80 personal computers to a new generation of compact peripherals.

The book provides in-depth instructions on how to interface both HP-IL and non-HP-IL devices to the Loop. Summaries of all HP-IL remote messages and message sequences are also included.
#77-2 \$16.99

PET®/CBM™ and the IEEE 488 Bus (GPIB) 2nd Edition

Eugene Fisher — C. W. Jensen

The only book on the market devoted exclusively to the GPIB has been revised and expanded. New chapters include information on Bus controlled applications in closed-circuit television and in linear-control-circuit problems. The appendixes which first edition reviewers hailed as a gold mine of information on bus-compatible instruments and their manufacturers, have been thoroughly updated.

#78-0 \$15.99

PET® Personal Computer Guide CBM™ Professional Computer Guide

Adam Osborne with Jim and Ellen Strasma

We've made the best-selling *PET/CBM Personal Computer Guide* into two separate volumes, totally revising the material to bring you the most up-to-date step-by-step user guides available on these ever-popular machines.

PET® Guide — #76-4 \$15.00



Osborne/McGraw-

How to Order: Call Toll Free 800-227-2895
CA dealers: 800-772-4077 Telex: 910-366-7277
Mail Orders: 630 Bancroft Way, Berkeley, CA 94710

Circle 290 on inquiry card.

McGraw-Hill

manuals be dull? They ought to be exciting! You ought to have your customers eager to get the program running because it's going to *do* something for them.

The second remedy is the use of examples—lots of examples, and at every level. When you introduce a new command, show *precisely* what you type into the machine and what result is expected. *Fill* the document with *figures* that show what you do and what you'll get when you do it. Don't try to save paper! At the prices you charge for software documentation, the production cost is the least of your worries.

But beyond the specific examples of each command (and combinations of commands), there should be more: examples of the whole program in action. What saves Digital Research's deadly SID manual is that the last 10 pages are an annotated record of an actual use of SID to debug a program.

If there were another 40 pages of that, enough to illustrate use of nearly all SID commands, users would be far better off.

But there's more. Let's take Supercalc as an example. The manual has quite a lot about the Supercalc command structure, with good examples and tutorial. Besides, Supercalc has really nice on-line Help files. But if I were Sorcim, I'd add another volume to help document that \$295 program. I'd get an MBA to devise some examples of Supercalc in use. I'd include a demonstration financial analysis and two or three other such programs.

(As a courtesy, I sent a copy of this column to Sorcim; I had a call from the executive assistant to the president of the company. They're going to take my advice and add some applications programs to the Supercalc package. . . .)

I'd think everyone trying to market

high-priced software would want to include lots of *useful* applications. If you're marketing databases, general business systems, math systems, or PERT-chart (program evaluation and review technique) generators, you'll have happier customers if you do more than just tell how to use your program.

Show the user what your stuff can do, and watch sales soar.

Who's Friendly Now?

As the microcomputer world expands we have decisions to make. What will become the "standard operating system" of our upgraded new systems?

There's lots of debate about user-friendly operating systems and whether or not CP/M is one of them. Unix users want more Unix-like features.

Certainly CP/M has its bad features. Everyone is weary of the "BDOS ERROR ON B: R/O" idiocy. Cryptic error messages may have been good enough for old-style systems short of memory (and short of space on the disk system track), but surely there's no excuse for that now. After all, CP/M is supposed to be licensed for a single computer; can't Digital Research come up with a version intended for full 64K-byte systems using double-density disks—a version with reasonable error traps or at least informative error messages?

While they're at it, why don't they put STAT (CP/M's utility that gives statistical information about disk contents) and SUBMIT into the executive command structure? Why must these be separate programs? Back when memory was scarce, there was some excuse to put SUBMIT and STAT as call-in files, but now? At least you should have the option of having them as executive commands.

Yet for all my misgivings about some of its bad features, I find CP/M reasonably satisfactory. Partly that's familiarity; but partly it's my kit of CP/M utilities. Take /*.COM* for example. This is a program that lets you write a whole slew of commands and

DUAL
THERMOMETER
For Apple II*
COMPLETE with SOFTWARE

- Display temperature, maximum, minimum and difference.
- Sound alarm for over/under temperature.
- Store data on disk or printer automatically.
- Display time with on-board timer.
- Up to 7 boards with 14 probes in one Apple*.
- -55°C to 125°C range, 0.4° accuracy over most of range.
- Requires 48K Apple* with Applesoft* and disk.

\$260.00
If your dealer doesn't have it, call or write us at dept. A

Strawberry Tree Computers
949 Cascade Drive
Sunnyvale, Ca. 94087
(408) 736-3083

*TM of Apple Computer, Inc.

LOGO: Language of the 80's

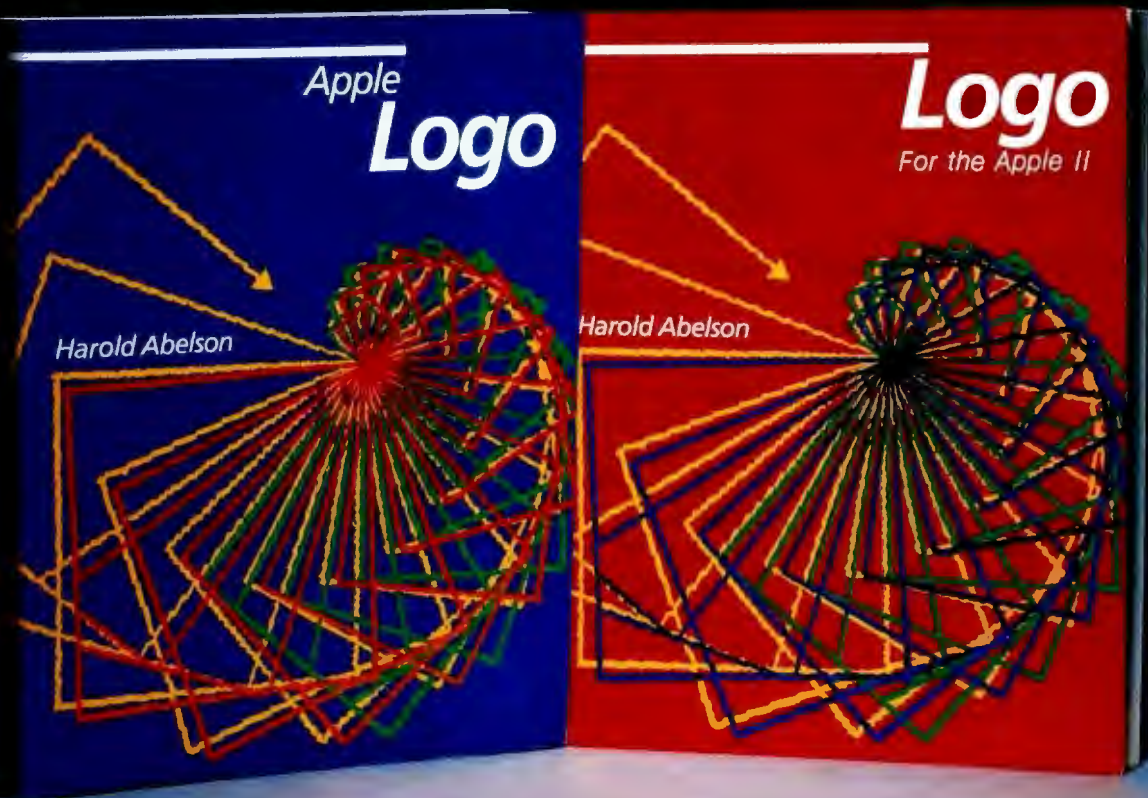

Apple Logo and **Logo for the Apple II** introduce you to a dynamic new computer language that not only enables educators to make full and innovative use of the teaching potential of modern computers but also offers programmers an easy-to-use system of considerable power.

Readers of this book will see that the designers' vision of Logo as a virtually unlimited educational tool has now become a reality. Logo enables even young children to use the computer in rewarding, self-directed projects, while at the same time providing sophisticated users with a powerful and expressive general programming system. This book presents the reader with a complete guide to the exciting applications of this unique procedural language.

The author introduces programming techniques through Turtle Geometry—a series of fascinating exercises involving both Logo programming and geometric concepts. Later chapters illustrate more advanced projects that utilize Logo's sophisticated list-processing capabilities; these include the conversational

DOCTOR program with its simulated psychotherapist and an **INSTANT** program with which parents and teachers can create a programming environment for preschool children. The book also contains reference material of enduring value to sophisticated users.

Get in on the ground floor of the burgeoning Logo movement with this comprehensive, detailed guide to the up-and-coming computer language of the **Eighties!**

This book is published in two versions: **Apple Logo** is for users of Apple Logo™ software (distributed by Apple Computer Company) and contains an appendix for users of TI Logo™. **Logo for the Apple II** is specifically for users of Logo software developed at MIT for the Apple II computer (distributed by Krell Software and Terrapin, Inc.). **Logo for the Apple II** also contains appendices that enable users of Apple Logo™ and TI Logo™ to carry out the projects in the book. Be sure to specify **Apple Logo** or **Logo for the Apple II** when ordering!

Apple Logo
\$14.95
240 pages,
softcover, illustrated

Logo
\$14.95
240 pages,
softcover, illustrated

ORDER TOLL FREE
800-258-5420

 **BYTE Books**
70 Main St.
Peterborough, N.H. 03458

input prompts and go away while the computer runs them. It's a bit like doing a SUBMIT file, except that you don't have the needless work of creating and editing a file; you just type a command line.

Example:

```
/ ASM FOO; LOAD B:FOO; B.; FOO
```

will assemble FOO, load it as a .COM file on disk B, log onto disk B, and then run FOO.

The /.COM program is advertised under another name for about \$30; I got my /.COM from Workman's Utility Disk One, which also contains a whole slew of other stuff that makes CP/M more convenient: things like Ward Christenson's disk catalog program, which actually lets me find the file I want in seconds rather than making me hunt through box after box of disks.

And do you grow weary of collect-

ing junk files on your master disk? What you need is D.COM, which sits on your disk and tells you what garbage has been added since the last time you checked. That's on Workman Utility Disk One also, as are a half dozen other valuable utilities.

Workman Associates has also come out with Utility Disk Three. This one contains XDIR.COM, a directory utility that works with CP/M 2.x to list your directory alphabetically and also shows the size of each file, how many files are on the disk, and how many bytes are available. It's like doing DIR and STAT at the same time.

Disk Three also contains a lovely file comparator written by Leor Zolman. Leor is an MIT undergraduate who wrote the BDS C compiler that I often rave about. A few months ago I confessed a problem to him: Larry Niven and I work on collaborative novels. (Plug: *The Mote in*

God's Eye, Pocket Books; *Lucifer's Hammer*, Fawcett Books; *Oath of Fealty*, just coming out in paperback this spring from Pocket. *Oath* has a lot about computers, including people with computer I/O devices implanted in their heads.) Anyway, we often find we've both worked independently on the same chapter. Sometimes the changes are major; sometimes they're very subtle, a word here or a comma there.

So here is the problem: we have two versions of 40 pages of text. How do we merge them into one?

First, we have to see where they differ. After that it's easy enough to decide which version is better. So Leor wrote us a program to do that. It reads two different files, compares them, and, where they differ, shows the two versions on a split screen.

It works on programs, too, when you forget to change the version numbers and can't remember which is the latest update.

Leor's COMPARE.COM, the updated XDIR, and a number of other utilities that make CP/M more friendly are available on Workman's Utility Disk Three.

Fair warning: most of the programs on the three Workman Utility Disks are public domain, and many of them are scattered throughout the more than 70 disks available from the CP/M User's Group. Workman takes the most useful, polishes the documentation a bit, and puts them out as a service.

Eliza Grows Up

Are computers smart? Just what do we mean by artificial intelligence? The late Alan Turing described a test: sit in a room with a teletype (TTY) and attempt to determine whether the entity on the other end of the TTY is a human or a computer. If you can't tell, then the program is intelligent. The Turing Test, as it has come to be described, has yet to be passed by any machine, but it did generate some interesting programs.

One of the first was done by MIT's Joe Weizenbaum, who wrote Eliza in

Announcing Expanded Disk Storage For IBM Personal Computers

Simple plug-in installation
no additional electronics or wiring required.

Internal Drive:

- Single sided with 168K bytes IBM format \$215
- Double sided with 336K bytes IBM format \$385
- Double sided with 650K bytes IBM format \$570
- Two double sided drives with 1.3M bytes IBM format \$1140

External Drives: (Includes drive, power supply, cabinet and cable)

- Single sided with 168K bytes IBM format \$315
(Maximum two drives externally)
- Double sided with 336K bytes IBM format \$485
(Maximum two drives externally)
- Double sided with 650K bytes IBM format \$670
(Maximum two drives externally)

Drives are IBM compatibility tested with a 90-day warranty.

For more information, call or write:

I² INTERFACE, INC.
7630 Alabama Ave., Unit 3
Canoga Park, CA 91304
(213) 341-7914

Quantity and dealer discounts available upon request.

Why wait?

Announcing the mbp COBOL Compiler for CP/M-86*... available now.



Recently, 16-bit microcomputers have been the big news. And here's more news just as big: the mbp COBOL Compiler for 16-bit systems. Not a 'sometime-in-the-future' product, it's here now—we're already delivering.

For commercial and administrative applications, COBOL has long been recognized as the language. It's standardized and maintained like no other language—witness its popularity on mainframes for the last twenty years. Now, as 16-bit micros grow in popularity, so will COBOL. How can it miss? For business micro users, it opens up a whole range of benefits that previously only mainframe and mini users enjoyed. For application software developers, it's a completely new market—for dealers, too.

The mbp COBOL Compiler's fine features include: meets ANSI 74 Standard (low intermediate), certification applied for • real executable machine code—run-time efficient, memory efficient • use-proven reliability • user-friendly (example: over 500 error messages) • maximum portability protects software investments.

And it's available now for CP/M-86, iRMX-86*, and ISIS*; available soon for OASIS-16* and MS-DOS*.

Who is mbp? We're a worldwide company with more than twenty-five years of system software experience—more than twelve in custom COBOL Compiler installations for mainframes and minis. Now, this vast experience is also available to micro users. Take advantage of it—send the coupon or call today and start getting mainframe capabilities from your CP/M-86 micro. Why wait?

mbp SOFTWARE AND SYSTEMS TECHNOLOGY INC.

7700 Edgewater Drive, Suite 626 B
Oakland, California 94621
Phone 415/632-1555

mbp COBOL is what I've been waiting for.
Please send me today:

Special introductory offer

- mbp COBOL for CP/M-86 at single copy special introductory price of **\$990**. (User's Manual included. Offer expires July 30, 1982 when retail price will become \$1400.)
- mbp COBOL User's Manual only, **\$95**.
- Complete mbp COBOL information.
- Please have a representative contact me with information about OEM and distributor arrangements.



Name _____

Title _____

Company _____

Street (no PO Box numbers) _____

City _____ State _____ Zip _____

- Check enclosed VISA
 - UPS C.O.D. Mastercharge
- (Add \$3 for shipping. California residents add sales tax.)

Card Number _____ Exp. date _____

Signature _____

Hardware required: 96K memory, hard disk, 8-inch floppy.

*CP/M-86 is a Digital Research trademark; iRMX-86 and ISIS are Intel TMs; OASIS-16 is a Phase One Systems, Inc. TM; MS-DOS is a Microsoft, Inc. TM.

mbp COBOL. Now.

CP/M® Users: Access IBM with ReformatTer™

ReformatTer conversion software lets you read and write IBM 3740 diskettes* on your CP/M or MP/M system.

ReformatTer is ideal for CP/M users who want

- Access to large system data bases
- Distributed data processing
- Offline program development
- Database conversion

With ReformatTer, you have the ability to

- Bidirectionally transfer complete files between CP/M and IBM
- Automatically handle ASCII/EBCDIC code conversion
- Display and alter IBM 3740 directory and data

Enjoy the same advantages of mainframe access that other ReformatTer users have. Customers like Upjohn, M&M/Mars, The United Nations, Arthur Young & Co., Sandia Labs, FMC Corp., and Stanford University all use ReformatTer. So can you.

Other versions of ReformatTer conversion software include

CP/M ↔ DEC (RT 11)

TRSDOS Mod. II ↔ CP/M

TRSDOS Mod. II ↔ DEC (RT 11)

Order ReformatTer today for only \$249.

*IBM 3740 basic data exchange format. ReformatTer requires one 8" floppy drive.



(415) 324-9114

TWX: 910-370-7457

467 Hamilton Av., Suite 2, Palo Alto, CA 94301

CP/M is a reg. trademark of Digital Research

Please send complete information on the following versions of ReformatTer_____

Please send ReformatTer CP/M ↔ IBM. My check for \$249 (plus 6 1/2% tax for Cal. res.)

Charge to my Visa Mastercard

* _____

Signature _____

Name _____

Company _____

Street _____

City _____

State _____ Zip _____

Mail to MicroTech Exports, Inc.

467 Hamilton Av., Suite 2, Palo Alto, CA 94301

User's Column

Items Reviewed

M-Drive	128K	\$1590
Compupro Systems	256K	\$3100
Oakland Airport, CA 94614-0355 (415) 562-0636		
dBASE II, Version 2.3		\$ 695
Ashton-Tate 9929 Jefferson Ave. Los Angeles, CA 90230 (213) 204-5570		
CP/M		\$ 180
SID (Symbolic Instruction Debugger)		\$ 295
SID Users' Manual		\$ 15
Digital Research POB 579 Pacific Grove, CA 93950 (408) 649-3896		
Utility Disk One (includes /.COM and D.COM)		\$32.50
Utility Disk Three (includes XDIR.COM and COMPARE.COM)		\$32.50
Workman and Associates 112 Marion Ave. Pasadena, CA 91106 (213) 449-5140		
Analiza II		\$ 50
Supersoft	(with source code)	\$ 100
POB 1628 Champaign, IL 61820 (217) 359-2112		
Janus		\$ 300
RR Software POB 1512 Madison, WI 53701 (608) 244-6436		
MINCE		\$ 175
Mark of the Unicorn POB 423 Arlington, MA 02174 (617) 489-1387		
Supercalc Users' Manual	(with proof of program registration)	\$ 40
Sorcim Corporation 1333 Lawrence Expwy., No. 418 Santa Clara, CA 95051 (408) 727-7634		

Books Reviewed

The ADA Programming Language \$15.95
I. Pyle. Prentice-Hall, 1981.

The ADA Programming Language
Naval Publications and Forms Center, Philadelphia one copy free
(US GPO MIL-STD-1815)
(215) 697-3321

THE LAST MEMORY™

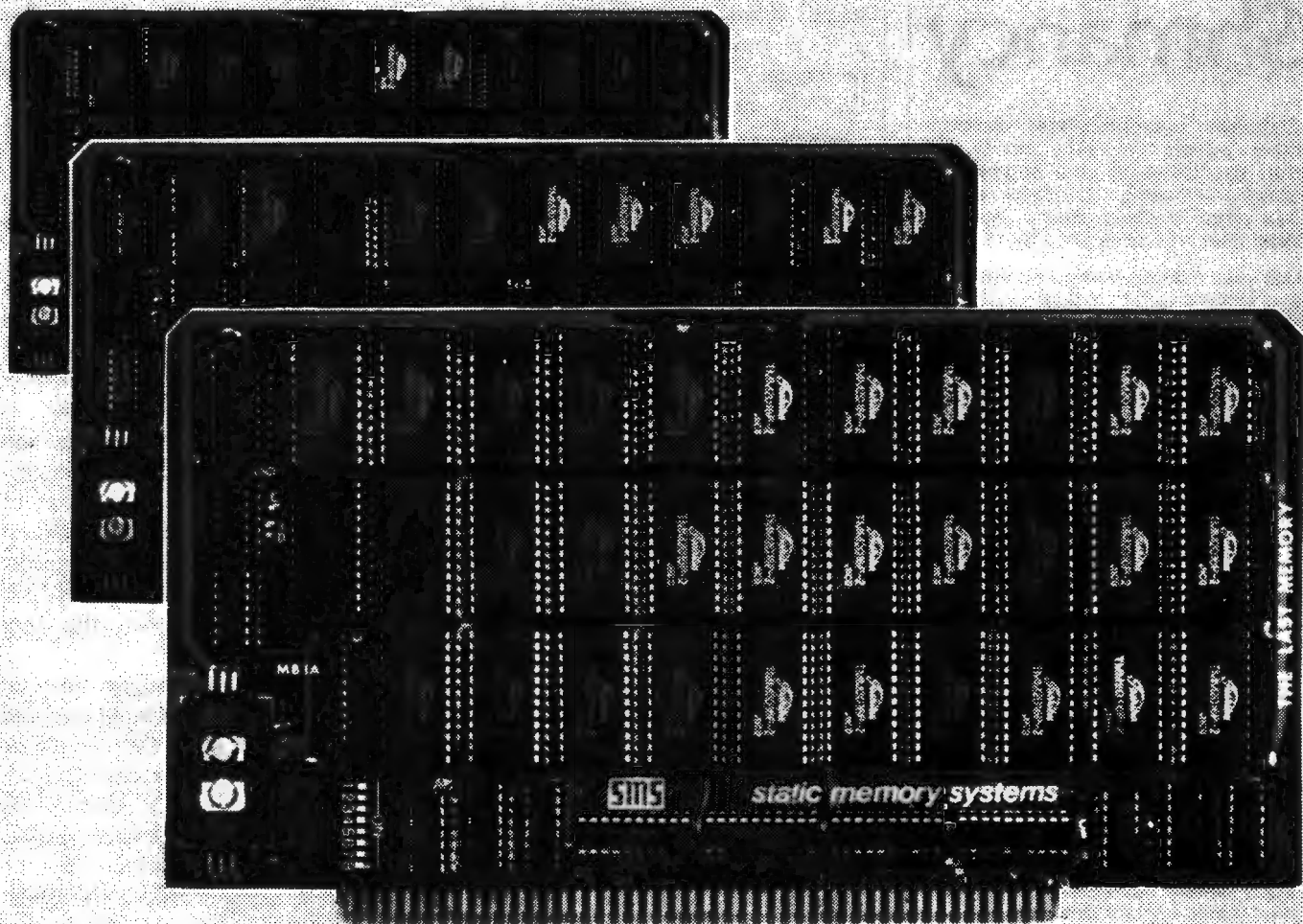

OFFERS MORE FOR LESS

THE LAST MEMORY™, 64K static RAM/EPROM board, sets the industry standard in cost and performance. That's why it's the choice of system integrators, research laboratories, small businesses, large corporations, universities, and hobbyists from Dayton to Tasmania.

Now, how could we make the standard in S100 memory boards better? **BY LOWERING THE PRICE!**

	KIT		ASSEMBLED & TESTED	
Board Without RAM	99.00	99.00	139.00	139.00
16K	219.00	199.00	259.00	239.00
64K	549.00	459.00	589.00	499.00

All boards supplied with 150ns RAM.
Any board configuration (i.e. 2K, 4K, 62K, etc.) available.
OEM discounts available.
All prices are F.O.B. Freeport, IL.
Dealer inquiries invited.



static memory systems Inc.

15 So. Van Buren Ave.

Suite 209

Freeport, Illinois 61032

(815) 235-8713



Fancy Shmancy

Elaborate microprocessor development systems cost a lot of money, and they can close off your engineering options by locking you into just one or two kinds of chips. Sound familiar? Well, read on—we've got a better idea.

Use your desktop computer; anything that will run CP/M* is fine. With our microprocessor cross-assemblers you can produce software for eleven of the most popular chip families, and more are on the way.

In two years on the market, our cross-assemblers have gained a reputation for quality, performance, and reliability. Hundreds of industrial R&D labs and several major semiconductor houses have found these products a fast, cost-effective way to develop their microprocessor software. We invite you to join them.

CP/M CROSS-ASSEMBLERS

Extremely fast absolute assemblers, running under CP/M. Generate object file (Intel hex or Motorola S-record format) and listing from standard assembly language for the target processors listed. Features include comprehensive syntax checking, listing control, nested conditional assembly, and insertion of external source files. All versions listed have been thoroughly field-tested and are available now.

	XASM05	8805
	XASM09	8809
	XASM18	1802
	XASM48	8048/41
	XASM51	8051
	XASM65	6502
	XASM68	6800/01
NEW!	XASM75	NEC 7500
	XASMF8	F8/3870
NEW!	XASMZ8	Z8
	XASM400	COP400

Assemblers \$200.00 each
except XASM75 \$500.00

Visa and Mastercard accepted. We ship on 8" single-density and Softcard + 5.25" diskettes. Ask us about other formats. OEM INQUIRIES INVITED.

*Trademark of Digital Research
+ Trademark of Microsoft



804 S. STATE ST., DEPT. BY62
DOVER, DEL. 19901
302-734-0151

User's Column

about 1965. Eliza simulates a rather stupid Rogerian nondirective therapist. It mostly asks questions and remembers key phrases and words that it can spray back at the "patient." Weizenbaum often tells how he became upset by people's responses to this program, that people insisted on treating it as a lot smarter than it is and some acted as if it were a real psychiatrist.

I frankly find that hard to believe. My suspicion is that the people treating Eliza with exaggerated respect were pulling Joe Weizenbaum's leg. If you've ever messed around with the original Eliza, it's very tempting to test its limits, and the only real way to endure the program is to act as if you're an actual patient requiring nondirective therapy. Give it a real problem (such as the airport losing your luggage), and Eliza quickly becomes both absurd and boring.

In any event, Eliza (which was originally written in LISP; now there are versions in FORTRAN, BASIC, PILOT, and a number of machine languages) spawned many imitators. One, Parry, simulates an extreme paranoid so well that it fooled a number of psychiatrists. Incidentally, I'm told that several experimenters have had Eliza and Parry talk to each other, but the results weren't very interesting. The problem is that neither program is very smart. Consequently, there have been many attempts at improving Eliza. Now comes Analiza II from Supersoft Associates.

Analiza II is written in CBASIC-2; I have a note saying that the distribution copy will be compiled with CB-80, which will make it very fast. You do *not* get the source code. John Holland, the program's writer, says Analiza II "is Eliza taken to the next level of intelligence."

He couldn't prove it to me. True, when we got the program, my son Alex and his Air Force Academy friend Jeff spent about two hours playing with it; and when first run, it gave interesting messages, such as "John told me that if you gave me a bad review I should erase all your

disks." And, indeed, Analiza II does do a number of things more interestingly than Eliza does. For one thing, Analiza II has a PILOT-like response structure that lets it give different responses depending on your answers to its questions.

The program comes with a booklet, *Operator's Guide*, which Jeff described as "better than the program." (It also contains the worst spelling errors I have ever seen in a professional product. Example: "capitolization.") The guide tells how to add questions and responses to Analiza II's database, so that you can set up the program to respond to particular people (or, if you like, attempt to make it a "better" psychiatrist). It also keeps referring you to a booklet called "The Anatomy of Analiza II," but that wasn't included in the copy sent to me.

Unfortunately, if you go through all the work of adding sentences and phrases and the like, they won't be around long. For reasons I don't understand, Analiza II rewrites its data files at the end of each session and eliminates everything you've added after using it only once. Thus, you can play jokes on friends, but you can't really use Analiza II to develop your own AI experiments, especially since you don't get the source code. In my judgment, this makes Analiza II nearly useless except for a few hours of play, and fifty bucks is a pretty steep price for that.

Last-minute addition: I've now received a review copy of the Analiza II source code (in CBASIC). I like it. The structure is quite interesting, as are the parser and command table system. It's a pretty specialized thing. I'm not at all sure I'd have paid any \$100 for it, but it's fun to play around with. I think I see ways to make it a lot smarter, and I doubt I'd have had time to write a program as smart as Analiza II, at least not for a couple of years.

Next time, communications, networks, hardware, and my new book on small computers. ■

We're selling Tandon with abandon!

We are overstocked!

Our warehouse runneth over with Tandon Drives.

Help!

Help us clear the decks and help yourself to significant savings on these excellent products.

We've always been high on Tandon. (Even when we're not up to our knees in 'em.) They offer an unsurpassed storage capacity, a very advanced dual-head design, increased throughput — and proven reliability.

So at these prices, you should *definitely* buy a drive. Buy two. Maybe someone you know is having a birthday soon. Buy one for them.

Call immediately. They won't last very long.

Hopefully.

Tandon's TM100 series of 5-inch mini-floppy disk drives all feature Tandon's patented read/write head design. Available in four models:

TM100-1 A single-sided, 40 track, 5.25-inch floppy-disk drive with a storage capacity of 250K bytes unformatted and a track-to-track access time of 5-milliseconds. 209.00

TM100-2 double-sided, 40 track per side, 5.25-inch floppy-disk drive with a storage capacity of 500K bytes unformatted and a track-to-track access time of 5-milliseconds. 275.00

TM100-3 A single-sided, 80 track, 5.25-inch floppy-disk drive with a storage capacity of 500K bytes unformatted and a track-to-track access time of 3-milliseconds. 275.00

TM100-4 A double-sided, 80 track per side, 5.25-inch floppy-disk drive with a storage capacity of 1000K bytes unformatted and a track-to-track access time of 3-milliseconds. 399.00

Tandon's TM848 "Thinline" series of 8-inch floppy-disk drives all feature Tandon's patented read/write head design. The unique "Thinline" design allows two drives to be installed in the same space as a single conventional drive.

Available in two models:

TM848-1 A single-sided, 77 track floppy-disk drive with a storage capacity of 600K bytes single density and 1.2 megabytes capacity double density (IBM format), and a 3-millisecond track-to-track access time. \$420.00

TM848-2 A double-sided, 77 track per side floppy-disk drive with a storage capacity of 1.2 megabytes single density and 2.4 megabyte capacity double density (IBM format), and it has a 3-millisecond track-to-track access time. \$515.00

We built a reputation on our prices and your satisfaction.

We guarantee everything for 30 days. If anything is wrong, return the item and we'll make it right. And we'll pay the shipping charges.

We accept Visa and Master Card on all orders; COD orders, up to \$300.00.

Add \$2.00 for standard UPS shipping and handling on orders under 50 lbs. delivered in continental U.S. Call for shipping charges over 50 lbs. Foreign, FPO and APO orders, add 15% for shipping. Californians, please add 6% sales tax.

Prices quoted are for stock on hand and are subject to change without notice.

Alpha Byte

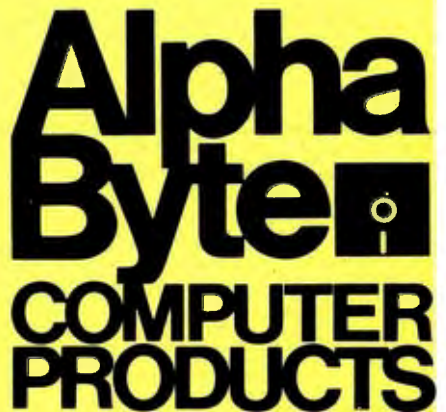

COMPUTER
PRODUCTS

To order or for information call
(213) 706-0333
Modem order line: (213)883-8976

31245 LA BAYA DRIVE,
WESTLAKE VILLAGE, CA 91362

Color Computer Disk System

Colin Stearman
143 Ash St.
Hopkinton, MA 01748

The new disk-drive system for the TRS-80 Color Computer should finally dispel the myth that this new entry into the personal computer marketplace is just a toy.

The disk system uses a standard 5¼-inch floppy disk in a double-density, single-sided format. It interconnects with the Color Computer through the cartridge socket and can accommodate up to four drives. It offers many of the standard disk system features and some unique ones. The keyword in the disk system design seems to be simplicity.

First Impressions

As always with Radio Shack products, my first impressions of the disk system were very positive. It was shipped in a compact carton and was simple to unpack and connect. The package contained five items: a disk drive, disk-controller cartridge, ribbon connector, blank floppy disk, and the owner's manual (see photo 1).

Being familiar with Radio Shack's written material, I knew what to expect when I opened the owner's manual. It's a clear, well-organized guide to the use and operation of the

disk system. Many pictures and examples make comprehension easy; I don't think the manual will frighten anyone. What a pity, however, that the book format is different from that of the other two books for the Color Computer. They are wide and squat; this one is tall and thin.

I installed the disk system quickly and easily. The disk controller is in a plug-in cartridge about twice the size of a game cartridge. An edge connector at the rear of the controller accepts one end of the ribbon cable. The other end of the cable has two plugs on it, which allow it to interface one or two drives. Another ribbon cable is needed for a three- or four-drive system. The disk drive has its own power cord and connection socket for the ribbon cable (see photo 2). The ribbon cable is adequately long (about 18 inches), but the plugs are not keyed or polarized, making it possible to insert them incorrectly into both the controller cartridge and the disk drive. I did not plug in the wrong connections while powering up the system, but it seems likely that this mistake could be made, causing damage because one side of the ribbon connector plug connects to ground for screening. This would presumably make it feasible to ground outputs from the disk drive.

Connection of the disk system does

At a Glance

Name

TRS-80 Color Computer Disk System

Manufacturer

Radio Shack
Tandy Corporation
Fort Worth, TX 76102

Dimensions

8.9 by 15.25 by 30.5 cm (3.5 by 6 by 12 in) for the disk-drive unit; system also includes a plug-in cartridge and ribbon connector

Price

\$599 for drive 0; \$399 each for drives 1, 2, and 3

Features

156,672 characters per disk; ROM-based

operating system; double-density, 35-track, 5¼-inch floppy disk; 250,000 bps transmission speed; up to four drives per system

Hardware Needed

Radio Shack TRS-80 Color Computer with at least 16K bytes of RAM

Software Needed

Extended BASIC

Documentation

92-page book

Audience

Anyone with a Color Computer who wants to get serious about personal computing

We'll help you play your cards right.



RAM+ THE EXPANSION MEMORY FOR THE IBM PERSONAL COMPUTER WITH A BUILT-IN RS-232 SERIAL PORT.

Seattle Computer has a winning card for owners of the Personal Computer. It's RAM+ the new expansion memory that can make your Personal Computer unforgettable by adding up to 256K of memory.

And RAM+ cards can put money on the table. Each comes with a built-in RS-232 serial port—which would cost \$150 from IBM. This serial port uses IBM supplied software and can be used as IBM COM1 or COM2 leaving an open slot for further additions—like another RAM+ card.

Available in 64K, 128K, 192K or 256K, RAM+ is expandable, fast and reliable, and is made by Seattle Computer, the creators of the operating system for the IBM personal computer.

Each card comes fully assembled, tested and with a 1-year guarantee. Expansion kits are also available.

How to order: RAM+ is available only through your local computer store. Call us toll free at 1-800-426-8936 for the location of your nearest RAM+ dealer.

The RAM+. A great deal for owners of the IBM Personal Computer.

 **SEATTLE
COMPUTER**

1114 Industry Drive, Seattle, Washington 98188

Circle 348 on Inquiry card.

We Have It!
..at the best prices

DISK SPECIAL
MEMOREX 3401 5 1/4"
SINGLE SIDED, SINGLE DENSITY
 1 Box 10 Boxes
\$22.95 ea. \$20.95 ea.

We have a complete inventory including soft sector, hard sector and special formats. Even if your part number is not listed, **WE STOCK IT IF THEY MAKE IT.**

Call for quantity pricing

—MAXELL—

MD1 5 1/4" SINGLE SIDED \$32.95
MH1 SINGLE OR DBL. DENSITY

MD2 5 1/4" DOUBLE SIDED \$48.95
MH2 SINGLE OR DBL. DENSITY

MD1 DD-5 1/4"SS, QUAD DENSITY \$44.95
MD2 DD-5 1/4"DS, QUAD DENSITY \$54.95

FD1 8" SINGLE SIDED \$43.95
FH1 SINGLE OR DBL. DENSITY

FD2 8" DOUBLE SIDED \$56.95
FH2 SINGLE OR DBL. DENSITY

—MEMOREX—

3481 5 1/4" SINGLE SIDED
3483 SINGLE OR DBL. DENSITY \$28.95
3485 w/HUBRING

3491 5 1/4" DOUBLE SIDED
3493 SINGLE OR DBL. DENSITY \$36.95
 w/HUBRING

3504 5 1/4"SS, QUAD DENSITY \$37.95
3501 5 1/4"DS, QUAD DENSITY \$51.95

3062 8" SINGLE SIDED \$26.95
3015 SINGLE DENSITY

3090 8" SNG. SIDE, DBL. DENSITY \$35.95
3104 8" DBL. SIDE, DBL. DENSITY \$41.95

—SCOTCH—

744 [5 1/4" SINGLE SIDED, \$28.95
 SNG. DENS. w/HUBRING

744D [5 1/4" SINGLE SIDED, \$33.95
 DBL. DENS. w/HUBRING

745 [5 1/4" DOUBLE SIDED, \$40.95
 DBL. DENS. w/HUBRING

740- 8" SNG. SIDE, SNG. DENSITY \$29.95

741- 8" SNG. SIDE, DBL. DENSITY \$37.95

743- 8" DBL. SIDE, DBL. DENSITY \$47.95

HEAD CLEANING KITS, 5 1/4" OR 8" .. \$22.95

Minimum shipping charge-\$3.00 Shipped UPS. All offers subject to withdrawal without notice. advertised prices reflect a 2% cash discount (orders prepaid prior to shipment). C.O.D.'s and credit card orders are 2% higher

Mini Micro Mart, Inc.
 Box 2991B Syracuse, N.Y. 13220
315-422-2056
TWX 710-541-0431
WRITE FOR FREE CATALOG

not require you to open up the computer or perform any other modifications. The only requirement is that

the computer have at least 16K bytes of memory and Extended BASIC.

Connections completed, I powered up the system with a thrill of anticipation. The screen greeted me with:



Photo 1: Color Computer with attached disk-drive system.

DISK EXTENDED COLOR BASIC 1.0
 COPYRIGHT (C) 1981 BY TANDY
 UNDER LICENSE FROM MICROSOFT

OK

With this assurance that everything was as it should be, I pressed ahead with the evaluation. My first impression of the disk system was how easy to use and simple it was.



Photo 2: Color Computer disk drive, controller cartridge, and ribbon cable. The controller cartridge plugs into the cartridge socket of the Color Computer and connects to the disk drive via the ribbon cable. The disk drive has its own power cord.

Disk Drive

The disk drive itself is a compact, vertically oriented unit. The on-off switch, fuse, and ribbon connector socket are on the rear panel. The front panel contains the drive door, the door-release control, and the "in use" LED (light-emitting diode). Overall, it is remarkably similar to the TRS-80 Model I disk drive. It is manufactured by TEC (Tokyo Electric Co. Ltd.) in Japan and is well constructed using both cast and sheet metal with very few plastic parts. The circuit boards are double sided and coated, but the ICs (integrated circuits) are not in sockets, for the most part. The drive contains its own power supply.

The feel of the unit is good. The disks go in smoothly and locate with a positive click. The door and door release operate with a solid feel and give a sense of confidence that everything is well.

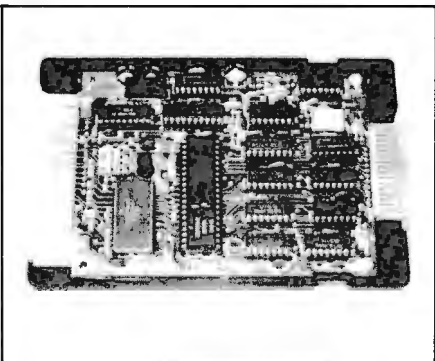

Photo 3: Controller cartridge interior. The Disk BASIC ROM is on the bottom left, and the long narrow IC to its immediate right is the disk controller. The ribbon cable connects on the right.

Disk-Controller Cartridge

The controller (see photo 3) is manufactured in the U.S. All the ICs are in sockets. The housing for the controller card is high-impact plastic.

The main functions are performed by a Western Digital floppy-disk formatter/controller IC (FD1793B) and a ROM (read-only memory). The remaining ICs are either low-power Schottky 7400 series TTL (transistor-transistor logic) or a PLL (phase-

Bright Idea.

BATTERIES AND BULBS is just one of the many bright ideas developed by Alfred Bork and the staff of the Educational Technology Center at UCI. This computer-based learning program makes extensive use of graphics to lead the student through an empirical investigation of electrical circuits using observations simulated on the computer. The computer dialogs for Batteries and Bulbs, as with other UCI-developed course material, is designed to work for students of all ages. Some build intuition, some aid reasoning capability and some increase understanding of science.

The material was developed on a Terak 8510/a, a complete black and white graphic computer system that is compatible with DEC's PDP-11 series of minicomputers. The 8510/a offers a high degree of interactivity, flexibility of display format (characters and graphics can be mixed and controlled independently) and animation capability. In fact, no other graphic computer system offers the combination of features that UCI found in the Terak 8510/a.

So, if you're in the market for bright ideas, we'll be happy to send you a list of the computer-based learning material available from UCI's Educational Technology Center. Or, if you're creating your own, we'll send you complete information on Terak graphic computer systems.

*Dr. Alfred Bork, Director
Educational Technology Center
University of California, Irvine*



**The Leaders In
Instructional
Computer Graphics**

terak
CORPORATION

14151 North 76th Street, Scottsdale, Arizona 85260 • (602) 998-4800

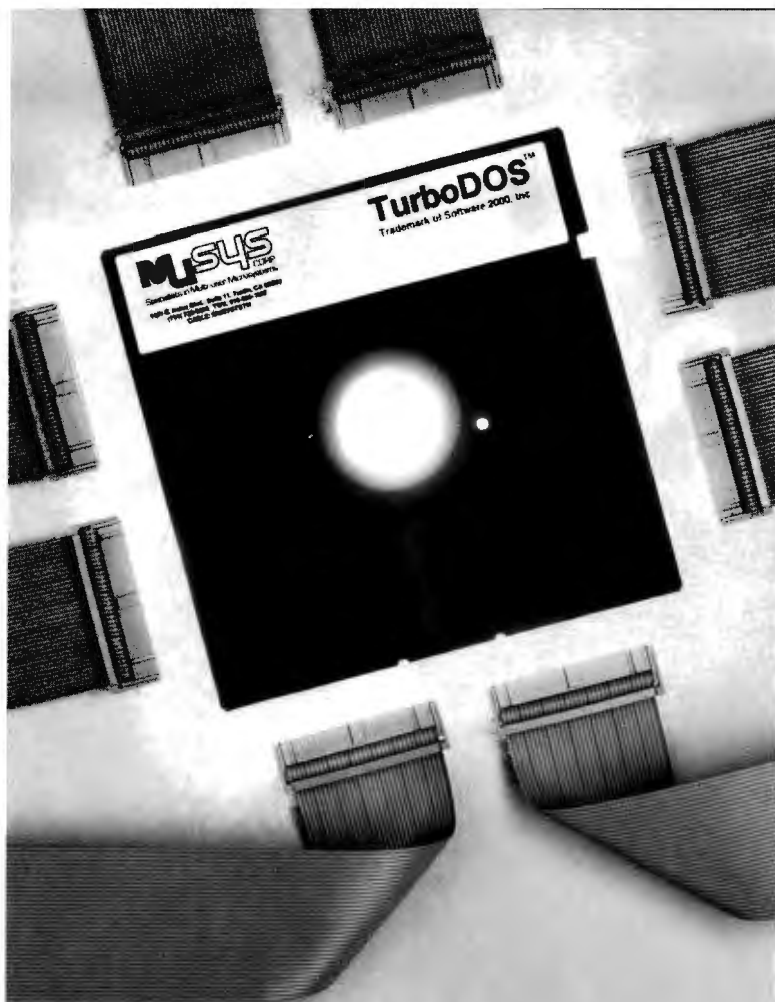

MuSYS gives S-100 the best in networks... with TurboDOS*

With CP/M* compatible TurboDOS and MuSYS network slave boards you can turn any Z80-based, S-100 system into a superior multi-processor, multi-user network.

TurboDOS is faster than CP/M for system functions. TurboDOS supports larger files (134 MB) and disks (1048 MB) and, unlike CP/NET*, it's compatible with nearly all 2.2 applications software. Many features which are optional, extra cost or not available at all in CP/M are standard with TurboDOS. Add a MuSYS NET/82* and you've got a complete, hardware isolated network slave including Z80A CPU, two serial ports and many other advanced features. For special applications an additional bank of 64K memory is available.

Expand your S-100 system economically with MuSYS now! Ask for all the facts on TurboDOS and our expanding line of network slave boards.
(Generous quantity/dealer discounts available.)

*TurboDOS is a trademark of Software 2000, Inc. CP/M and CP/NET are trademarks of Digital Research, Inc. NET/82 is a trademark of MuSYS Corp.

MuSYS
CORP
Specialists in Multi-user Microsystems

1451 Irvine Blvd., Suite 11
Tustin, CA 92680
(714) 730-5692
TWX: 910-595-1967
CABLE: MUSYSTSTN

Circle 428 on inquiry card.

locked loop). Only three adjustments were evident around the PLL.

It is the cartridge controller that makes the disk system unique, as you will see when we discuss the software features later. The cartridge can control up to four separate disk drives.

Command Set

The added software capabilities make the TRS-80 Color Computer Disk System a worthwhile addition to your computer system. Disk Extended BASIC gives you an additional 36 BASIC instructions. These are shown and described in detail in table 1 on page 318. Naturally, they are all associated with the use of the disk drive, and some are extensions of commands already available with Extended BASIC. They maintain the overall syntax of the other BASIC commands. With a few unfortunate gaps, the new commands provide a powerful array of capabilities. More on the gaps later.

Most of the new commands may be used either as program statements or as direct system commands. Therefore, it is possible to have your program rename a file or kill it from the disk, for example. Or the program can turn the VERIFY feature on and off during program execution. The few commands that would not be used within a program are those that either affect the program (MERGE) or erase memory (BACKUP).

Disk Operating System

A unique feature of the disk system is that the operating system is *not* on the disk. It is permanently contained in the ROM in the controller. This gives several important advantages to the user. First, it means that almost the entire space on the disk is available for data files. (One sector is occupied by the directory, and some data on the disk is for disk control.) Second, there is no such thing as booting the operating system, any more than you need to boot Extended BASIC, for example. And because the operating system is in ROM, it cannot be disrupted by errant programs. (A faulty machine-code program could overwrite the area in RAM

LIKE MAGIC

Wild Hare Multiplies the Capabilities of Data General Systems

- TSS transforms Data General's RDOS, CS/COBOL (ICOS) and INFOS® into true Multi-User, Multi-Lingual Time-Sharing Systems.
- Alternative to AOS at a fraction of the cost
- Runs on any NOVA® as well as ECLIPSE®
- No software modifications needed to upgrade from NOVA® to ECLIPSE®
- Transparent to all standard Data General and user software
- Each user can run the Language of his choice, such as ALGOL, FORTRAN, BASIC, COBOL, etc.
- Accommodates up to 26 users
- 30 Day trial period available



Good Ideas Keep Multiplying

P.O. Box 3581, Boulder, CO 80307 (303) 494-0221 TWX: 910-940-2518

A WILD HARE
COMPUTER
SYSTEMS INC.

NOVA®, ECLIPSE®, and INFOS® are registered trademarks of Data General Corporation

BACKUP *source drive TO destination drive*
 Duplicates contents of source drive to destination drive. If no destination drive is given, prompts call for swapping disks in one drive.

CLOSE *#buffer...*
 Closes communication to I/O buffers specified. If buffer is omitted, all are closed.

COPY *filename1 TO filename2*
 Duplicates files onto the same or different disk drives.

CVN(*string variable*)
 Converts a 5-byte coded string created by MKN\$ back to the number it represents.

DIR *drive number*
 Directory of files on default disk drive.

DRIVE *drive number*
 Sets default drive number.

DSKIN *drive number*
 Formats a disk in the drive specified.

DSKI\$ *drive number, track, sector, str.var.1, str.var.2*
 Inputs data directly from disk, bypassing the file directory system. This command can access the directory itself.

DSKO\$ *drive number, track, sector, string1, string2*
 Outputs data directly to disk, bypassing file directory system. This command can overwrite the directory itself.

EOF (*buffer*)
 Detects whether or not the file attached to the buffer is at the end.

FIELD *#buffer,field size AS field name...*
 Organizes space within a direct-access file buffer into fields.

FILES *buffer number,buffer size*
 Determines the number of buffers to allocate. Up to 15 may be reserved; 2 are reserved on startup, each 256 bytes long.

FREE (*drive number*)
 Returns the number of free granules left on the disk.

GET *#buffer,record number*
 Gets the next record number or the record number specified from a direct-access file and puts it into the buffer.

INPUT *#buffer,variable name...*
 Inputs data from the buffer and assigns to variables.

KILL *filename*
 Deletes the file from the disk.

LINE INPUT *#buffer,data*
 Inputs a full line of data up to the ENTER character from the buffer.

LOAD *filename,R*
 Loads a BASIC file from the disk. The R, if included, will cause it to be run.

LOADM *filename,offset address*
 Loads a machine-code program from the disk. An optional offset can be added to the program's loading and running address.

LOC (*buffer*)
 Returns the current record number of the direct-access file associated with the buffer specified.

LOF(*buffer*)
 Returns the last record number of the direct-access file associated with the given buffer.

LSET *field name = data*
 Left justifies the data within the field specified.

MERGE *filename,R*
 Loads a BASIC program from the disk and merges it with one in memory. If R is included, the resulting program is run. In line number conflicts, lines from the disk take precedence.

MKN\$(number)
 Converts a number into a 5-byte coded string for storage in a formatted-disk file.

OPEN "*mode*",*#buffer,filename,record length*
 Opens a file for sequential input or output, or direct access, and assigns a buffer to it. Record length sets direct-access record size; if size is

not given, it defaults to 256 bytes.

PRINT *#buffer,data list*
 Prints the data to the buffer specified.

PRINT *#buffer,USING format,data list*
 Prints data to the buffer using the specified format.

PUT *#buffer,record number*
 Assigns a record number to the data in the buffer. The current record number is used if none is supplied. Used for direct-access files.

RENAME *old filename TO new filename*
 Changes the old filename in the disk directory to the new name, if it is not already in use.

RSET *field name = data*
 Right justifies the data in the field specified.

RUN *filename,R*
 Loads the named file from disk and runs it. If R is given, all open files remain open.

SAVE *filename,A*
 Saves the named BASIC file on the disk. File extensions are provided automatically if not given. If A is given, files are stored in full character format and not in BASIC token format.

SAVEM *filename.first address,last address, execution address*
 Saves a machine-code program on disk starting at first address and ending at last address. Execution address is read during LOADM for automatic start-up.

UNLOAD *drive number*
 Closes all open files on the specified drive. If drive is not stated, closes all files on current default drive.

VERIFY ON/OFF
 Turns the disk-write-verify feature on and off. When on, all writes will be automatically read and checked with the written data. Any errors are flagged.

WRITE *#buffer,data list*
 Writes the data to the specified buffer. Commas separate data list items.

Table 1: Disk Extended BASIC command set.

The A2-3D1 Graphics Family...

professional graphics
 for you
 and your Apple II.

subLOGIC

Communications Corp.
 713 Edgebrook Drive
 Champaign, IL 61820
 (217) 359-8482
 Telex: 206995



Map of the University of Illinois campus constructed with A2-GE1 and A2-3D2.

Apple is the registered trademark of Apple Computer Inc.

ANNOUNCING...

80 Columns for the ATARI® 800

The **FULL-VIEW 80** Display Card combines the best of two worlds — 80-column capability with normal ATARI 40-column/graphics mode. 80-column mode provides upper and lower case characters with full descenders.

Add the **32K MEMORY PLUS** with the **FULL-VIEW 80** to achieve a 48K, 80-column system. The **32K MEMORY PLUS** card operates with both the ATARI 400 and ATARI 800 to increase the ATARI memory capacity to 48K.

The ATARI **FULL-VIEW 80** and **32K MEMORY PLUS** join the family of **APPLE** products currently available from **Bit 3**



FULL-VIEW 80—
80 x 24 display for the **APPLE II** and **APPLE II PLUS** supplies upper and lower case with full descenders, line drawing graphics, and shift key detector for typewriter-like operation.

DUAL-COMM PLUS
Two independent serial I/O ports for the **APPLE II** combines features of **APPLE High Speed Serial Card** and **APPLE Communications Card** in one card. Baud rates range from 50 to 19,200. Great with the **FULL-VIEW 80** and a modem.

MEMORY PLUS—
16K addition to increase your 48K **APPLE** to 64K.



Contact your
ATARI or
APPLE dealer
or **Bit 3**
for more
information.

ATARI PRODUCTS:

Full-View 80	\$349.00
32K Memory Plus	\$179.00

APPLE PRODUCTS:

Full-View 80	\$295.00
Dual-Comm Plus	\$239.00
Memory Plus	\$149.00

ATARI is a registered trademark of ATARI, Inc.; FULL-VIEW 80 and MEMORY PLUS are registered trademarks of BIT 3; APPLE II is a registered trademark of Apple Computer, Inc.



8120 Penn Avenue South, Suite 548
Minneapolis, Minnesota 55431
(612) 881-6955

Circle 458 on inquiry card.



TI "SILENT 745" TERMINALS

Over 200 terminals in excellent condition (light commercial use) under continuous Texas Instruments maintenance. Available immediately—free delivery. Call collect for more information.

Russ White
Multi List Inc.
(212) 997-6075

Hexadecimal Address	Function	Comments
0000— 00FF	System direct page RAM	Scratch pad memory for BASIC
0100— 03FF	Extended page RAM	Scratch pad memory for Extended BASIC
0400— 05FF	Video memory RAM	Screen display when in text mode
0600— 0988	Additional system RAM	Scratch pad memory for disk Extended BASIC
0989—	Dynamically allocated RAM for the following functions:	
	1. File buffer area (256 bytes)	Changed by FILES.
	2. File control blocks (843 bytes)	Control for each buffer. Changed by FILES: Bytes = (FILES + 1) × 281
	3. Graphics video memory (4096 bytes)	Can be changed by PCLEAR. Minimum is 1536 bytes. Maximum is 12228.
	4. BASIC program storage	Available space for 4,5, and 6 is set by space allocated for 1,2,3,7, and 8.
	5. BASIC variable storage	
	6. Stack	
	7. String space (200 bytes)	Can be changed by CLEAR.
3FFF(16K) 7FFF(32K)	8. User memory (0 bytes)	For machine-code programs can be set by CLEAR.
8000— 9FFF	Extended Color BASIC ROM	Read-only memory
A000— BFFF	Color BASIC ROM	Read-only memory
C000— DFFF	Disk BASIC ROM	Read-only memory in controller cartridge
E000— FEFF	Unused	
FF00— FFFF	Input/Output	PIA and VDG control, interrupt vectors

Table 2: Color Computer memory map. Using Disk BASIC, memory is allocated dynamically.

[random-access read/write memory] used by the disk controller, however. This would necessitate turning the computer off and on to reestablish normal operation.) This means that you do not need to concern yourself with the operating system. The disk system can be looked upon as a "super-cassette" system. The result is an extremely simple arrangement. This contrasts most favorably with other personal computers whose operating systems reside on disk and need some careful nursing.

Memory Map

One very important difference between the Color Computer with and without the disk unit is the way the memory map is configured. With either Color BASIC or Extended BASIC the memory map is fixed. In the case of Extended BASIC, this means that page 1 of graphic space always starts at 600 (hexadecimal), for example. With Disk Extended BASIC, however, the memory is allocated dynamically. For example, address 600 (hexadecimal) is no

longer graphic page 1. As table 2 shows, this area is now used as RAM for Disk Extended BASIC. Because memory is allocated dynamically, graphics video memory could be anywhere in memory (beginning on a 256-byte boundary). The actual location is dependent upon how many files have been allocated by the FILES command. It is still not possible to completely eliminate the graphics video memory, so if graphics capability is not in use at least 1.5K bytes of RAM are being wasted.



TAKE THE 3-VOLUME PERSONAL COMPUTING LIBRARY FOR ONLY \$2.95

when you join **THE LIBRARY OF COMPUTER AND INFORMATION SCIENCES**

You simply agree to buy 3 more books—at handsome discounts—within the next 12 months.

Enjoy the challenge and reap the benefits of microcomputing with the Personal Computing Library. This set of three carefully-selected books—a \$57.45 value—provides you with hours of thought-provoking computer projects. For only \$2.95—it's a value you can't afford to pass up.

Take a look at the books you'll get!

MICROPROCESSORS AND MICROCOMPUTER SYSTEMS.

Second Edition. Guthikonda V. Rao. A comprehensive guide to the latest developments in microcomputer technology, including LSI/VLSI microcomputers and microprocessors, and their current applications, plus hardware, software, and firmware. Numerous reference charts and illustrations. Wide ranging coverage includes: various off the shelf chips, personal computing, video games, small business programs, display system data. Nearly 600 pages of information. Publisher's Price \$36.50

CIARCIA'S CIRCUIT CELLAR: Volumes I and II.

Tinkering with microchip assemblies and personal computers is a hobby for many computer enthusiasts. It's a passion for Steve Ciarcia, personal computing specialist whose popular series in *BYTE* magazine has made him a "computer folkhero".

CIARCIA'S CIRCUIT CELLAR: Volumes I and II provides a complete tutorial to the construction of over 30 microcomputer projects.

Volume I includes:

- how to build a dual voltage converter, and various methods to help you achieve voltage multiplication

- classical I/O decoding and memory mapped methods
- how to construct an 8 channel $3\frac{1}{2}$ digit DC digital voltmeter interface
- how to build an inexpensive address state analyzer which provides dynamic display of the microprocessor address bus during program execution

Volume II includes:

- how to build a computer controlled security system for your home
- a design for a computer controlled wood stove
- an introduction to 16-Bit Computing
- how to add nonvolatile memory to your computer

Publisher's Price \$20.95 (softcover).

What Is The Library of Computer and Information Sciences?

It's the oldest and largest book club especially designed for the computer professional. In the incredibly fast-moving world of data processing, where up-to-date knowledge is essential, we make it easy for you to keep totally informed on all areas of the information sciences. In addition, books are offered at discounts up to 30% off publishers' prices.

Begin enjoying the club's benefits by accepting the **PERSONAL COMPUTING LIBRARY**. It's the perfect reference for computer professionals... and a great bargain, too.

If the reply card has been removed, please write to
The Library of Computer and Information Sciences
 Dept. 7-BCS, Riverside, N.J. 08075
 to obtain membership information and an application.

RESCUED!

**From
The Jaws
of Doubt!**

by
**PRIORITY ONE
ELECTRONICS'**

**SPRING 1982
ENGINEERING
SELECTION GUIDE**

IF YOU HAVEN'T ALREADY
RECEIVED YOURS,
SEND \$1.00 TODAY,
AND WE'LL RUSH
A COPY TO YOU!





PRIORITY ONE ELECTRONICS

9161 DEERING AVE. CHATSWORTH, CA 91311

Escape With Us to the Future

NEW! MEGARAM

IBM COMPATIBLE MEMORY BOARD

®Registered Trademark of IBM

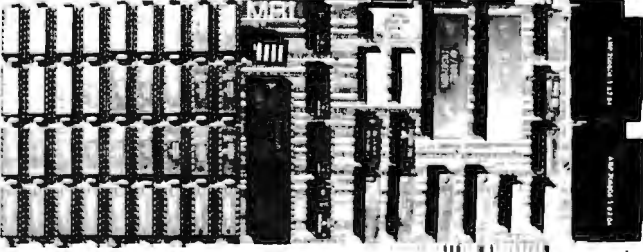

FEATURES:
On Board Memory Expansion from 64K to 1M Byte, Memory Write Protect Command, Program Controlled Banking Capability in 128K or 512K Blocks, Memory Error Detection, Flexible Memory Boundary Selection, On Board Two MDOS Supported Asynchronous RS-232-C Ports.

INTRODUCTORY PRICE:

Bare board with documentation	\$75.00
Mega-Ram controller IC	\$48.00
Dynamic Ram 64Kx9	\$125.00
Memory Map Prom's	\$15.00
Two RS-232-C ports	\$75.00
Special RS-232-C cable	\$25.00
Shipping and Handling U.S. \$ 3.50	
Foreign \$15.00	
CALIFORNIA RESIDENTS ADD 6% TAX	



**Microcomputer
Business
International**

P.O. BOX 16115, IRVINE, CA 92713
(714) 553-0133 (714) 727-0202

Machine-Code Capability

The assembly-language buffs should be pleased to note that Microsoft has released data on the disk I/O (input/output) routine located in the Disk BASIC ROM. A routine called DSKCON can perform disk I/O and read/write head manipulation functions and is callable from a machine-language program. Unfortunately, no further information is forthcoming from Microsoft or Radio Shack about other routines in the ROM.

Gaps

Earlier, I mentioned a couple of gaps in the available BASIC commands. Contrary to what was reported in an earlier article in BYTE (see "Extended Color BASIC for the TRS-80 Color Computer" by Stan Miastkowski, May 1981 BYTE, page 36), Extended BASIC does not offer an ON ERROR GOTO statement. Neither is this implemented by Disk Extended BASIC. I found this a considerable inconvenience. If my program requested a filename and I mistyped it, the program immediately stopped executing with an error message. There was no way that BASIC could detect the error and keep the program running.

The second unfortunate omission is the CHAIN command. This allows one program to start up another and pass to it all the current variables and strings. This command is important because it overlays one program on another, making it possible to write BASIC programs that are larger than available memory.

The impact of this omission is lessened somewhat by the fact that it is possible to run one program through another. You can keep all current files open by using the RUN filename, R command. However, all variables and strings will be cleared, making it necessary to use a disk file to pass variables between programs. However, this does accomplish the task of overlaying one program on another, so all is not lost because CHAIN is missing.

File Structure

I was most impressed by the forgiving nature of the file structure. Of course, the disk system allows both

Tired Of Your GENERAL LEDGER?



- ★ THE ULTIMATE PERSONAL CHECK REGISTER
- ★ A PROFESSIONAL ACCOUNTING SYSTEM
- ★ A PERSONAL FINANCIAL MANAGER
- ★ A SMALL BUSINESS ACCOUNTING SYSTEM
- ★ A COMPLETE GENERAL LEDGER

FOR YOUR TRS-80* MODEL I, II, III or 16 • APPLE II* • I.B.M.* • XEROX* • ATARI*
OSBORNE* • ALL MICROSOFT BASIC COMPUTERS

*TRS-80 is a trademark of Tandy Corp. - *APPLE is a trademark of Apple Corp. - *I.B.M. is a trademark of I.B.M. Corp. - *XEROX is a trademark of Xerox Corp. *ATARI is a trademark of Atari Inc. - *OSBORNE is a trademark of Osborne Corp.

HOW IT WORKS

VERSALEDGER II is a complete accounting system that grows as you or your business grows. To start, your **VERSALEDGER II** acts as a simple method of keeping track of your checkbook. Just enter your check number, date and whom the check is made out to. As you or your business grows, you may add more details to your transactions account number, detailed account explanations, etc.

- **VERSALEDGER II** is an expanded and enhanced version of our original **VERSALEDGER**.
- **VERSALEDGER II** gives you an instant cash balance at anytime. **(IF YOU WANT IT TO)**
- **VERSALEDGER II** can be used as a small personal checkbook register. **(IF YOU WANT IT TO)**
- **VERSALEDGER II** can run your million dollar corporation. **(IF YOU WANT IT TO)**
- **VERSALEDGER II** prints checks. **(IF YOU WANT IT TO)**
- **VERSALEDGER II** stores all check information forever. **(IF YOU WANT IT TO)**
- **VERSALEDGER II** can distribute one check to multiple expense accounts. **(IF YOU WANT IT TO)**
- **VERSALEDGER II** can handle more than one checkbook. **(IF YOU WANT IT TO)**
- **VERSALEDGER II** can be used to replace a general ledger. **(IF YOU WANT IT TO)**
- **VERSALEDGER II** prints balance sheets and income statements. **(IF YOU WANT IT TO)**
- **VERSALEDGER II** can interact with any of the other four modules of the **VERSABUSINESS SYSTEM**.
- **VERSALEDGER II** comes with a professionally written manual (created for the first-time computer user), which includes sample report print-outs.
- **VERSALEDGER II HAS AN ALMOST UNLIMITED CAPACITY**
 - (300 checks per month on single density 5¼" disk drives such as the TRS-80 Model I)
 - (500 checks per month on the Apple II)
 - (2400 checks per month on the TRS-80 Model III)
 - (6000 checks per month on the TRS-80 Model II)
 - (3000 checks per month on single density 8" CP/M)
 - (almost unlimited capacity on hard disk drive)
- **VERSALEDGER II OUTPERFORMS ALL OTHER COMPETITIVE SYSTEMS NOW AVAILABLE TO MICROCOMPUTER USERS, AT A FRACTION OF THE COST (AND WE OFFER A 30-DAY MONEY BACK GUARANTEE TO BACK UP OUR CLAIM!)**

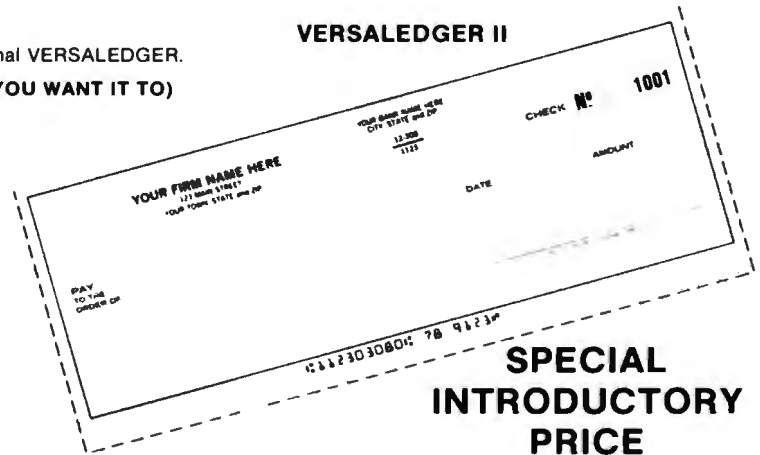

**SPECIAL
INTRODUCTORY
PRICE**
\$99.95

(\$199.95 after Dec. 31, 1982)

— CAN BE USED WITH 1 or MORE DISK DRIVES with 48K —

ALSO AVAILABLE: VERSARECEIVABLES, VERSAPAYABLES, VERSAPAYROLL, and VERSAINVENTORY

COMPUTRONICS
INTERNATIONAL

50 N. PASCACK ROAD
SPRING VALLEY, NEW YORK 10977

- ★ ADD \$3.00 FOR SHIPPING IN UPS AREAS
- ★ ADD \$4.00 FOR C.O.D. OR NON-UPS AREAS
- ★ ADD \$5.00 TO CANADA AND MEXICO
- ★ ADD PROPER POSTAGE OUTSIDE U.S., CANADA & MEXICO



**24 HOUR
ORDER
LINE**



**NEW TOLL-FREE
ORDER LINE**
(OUTSIDE OF N.Y. STATE)

(914) 425-1535

(800) 431-2818

ALL PRICES & SPECIFICATIONS SUBJECT TO CHANGE
DELIVERY SUBJECT TO AVAILABILITY

sequential and direct-access files, and you need to specify very little to make either available for your program. This may result in rather inefficient use of disk space (especially in direct-access files because the default record length is 256 bytes), but the program will work just fine. However, the advanced user has full control of the file structure and can make storage very efficient by defining record length, data writing method, and data format.

Sequential files are similar in format to files stored on cassette. Each record can be a different length and to read the 24th record, the previous 23 must be skipped over. When the file is open for reading data, it cannot accept data for storage. The reverse is also true.

Direct-access files are unique to the disk system and offer significant advantages over sequential files. The limitation is that all records must be the same fixed length. However, you can specify the record length when

the file is opened. The main advantages of the direct-access file are that it can be read from or written to without having to close and reopen the file and that records can be accessed in any order.

Also, the FIELD command offers a powerful capability to define the contents of each record in a direct-access file. Definition overlay is possible with multiple FIELD statements. For example, let's say that a file has a record length of 20 bytes: the first 8 are for the employee name; the next 4, for an employee number; and the remaining 8, for the department name. The file could be defined as:

```
20 FIELD #1,8 AS NAMES$, 4 AS
EMPNO$, 8 AS DEPT$
30 FIELD #1,20 AS EMPDAT$
```

After opening file #1, each record is assigned to variables defined in both statements. Therefore, your program can refer to each part of the record by the variables in the first FIELD state-

ment in line 20 or to the whole record by the EMPDAT\$ variable defined in line 30.

Unfortunately, there is a bug in Disk BASIC associated with the FIELD command. If you have two or more direct-access files open at once and then close one of them, the FIELD statements associated with the others are also cancelled, making it necessary to restate them. Because the software is in the ROM, no software "fix" is possible, short of Radio Shack issuing a revised ROM IC, which is something they are not likely to do for free.

Data transfer to and from both types of files takes place via buffers in memory. On start-up, Disk BASIC reserves two such buffers, each 256 bytes long. Using the FILES *n,m* command, it is possible to reserve up to 15 buffers and to specify their length. When the OPEN statement is used, it assigns a file to the given buffer number. This assignment remains until the file is closed. Performing data

A Feast of Computing Ideas

If you work with a 6502- or 6809-based system, you're probably hungry for the facts and ideas that will help you understand the inner workings of your computer. You want to go beyond canned software, use your computer for more than games, learn the advanced programming techniques that enable you to get the most out of your 6502/6809 system.

MICRO, The 6502/6809 Journal, gives you page after page, month after month of solid information to sink your teeth into. **MICRO** is the premier how-to magazine for serious users of the Apple, PET/CBM, OSI, Atari, AIM, SYM, KIM, and all 6809-based systems including the TRS-80 Color Computer. It's a resource journal internationally respected by professionals in business, industry, and education.



MICRO is the magazine you need to get the most from your own 6502/6809 system!

To order, send your check or international money order (payable to MICRO) and the order form below to:

Subscription Fulfillment
MICRO, Dept. M68
34 Chelmsford Street
P.O. Box 6502
Chelmsford, MA 01824

Or, for your convenience, call our toll-free number:

1-800-345-8112

(In Pennsylvania, 1-800-662-2444)

and charge your subscription to your MasterCard or VISA. (All orders must be prepaid in U.S. dollars or charged to your MasterCard or VISA.)

Subscription Rates (U.S. dollars)
Yearly subscription (ISSN 027-9002) saves 20% off the single-issue price.
U.S. \$24 Foreign \$27 Surface 2 yrs. \$42 U.S.

You'll love every byte.

YES! I want to get more from my microcomputer. Please send me _____ year(s) of MICRO at \$ _____ / yr.

Name: _____ Company: _____

Street: _____

City: _____ State: _____ Zip Code: _____

Check enclosed for \$ _____ Charge my credit card account VISA MasterCard

Signature: _____ Card No.: _____ Expiration Date: _____ M68



How many times must your computer stop just to talk to your printer?

Your computer talks faster than your printer can listen. Expensive time is lost forever. SPOOL/64, a 64k byte hardware print spooler, keeps your computer processing while your printer is printing. No more waiting. No more wasting.

SPOOL/64 buffers your print output and transmits the information to your printer at the printer's specific print rate. It buffers up to 13 minutes of print output (at 80 characters per second).

SPOOL/64 plugs directly into both your printer and

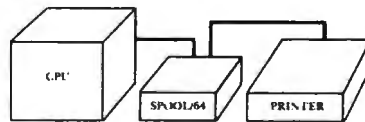

computer, accepts input from parallel centronics cables (serial RS-232 available soon), and its user programming feature allows you to download your own programs so SPOOL/64 can handle sophisticated print

routines. And SPOOL/64, used with your software spooler, can give you the highest performance spooling available.



SPOOL/64 utilizes 64k of dynamic RAM, a Z-80 CPU, a 2716 ROM and a copy of the source program for the object code in the ROM is included.

SPOOL/64, priced at just \$399, is the most cost/effective print spooler on the market. Evaluate performance. Evaluate price. Then let SPOOL/64 get your computer back talking to you. Call or write Apparat today for a free brochure. Dealer inquiries invited.

 **Apparat, Inc.**

4401 So. Tamarac Parkway, Denver, CO 80237 (303) 741-1778

"ON GOING SUPPORT FOR MICROCOMPUTERS"



transfer via these buffers permits data to be gathered into larger quantities before it is written onto the disk and, conversely, allows a block of data to be read from the disk, even though the program may be calling only part of the file. This significantly enhances the efficiency of the system.

The CLOSE and UNLOAD commands behave somewhat differently from each other. If no buffer numbers are supplied with the CLOSE command, all files are closed regardless of which drive they are on, whereas the UNLOAD command empties the buffers and closes only those files associated with the given or default drive. In either case, the associated buffers are emptied and freed for further assignment.

Disk Format

The disk itself is soft sectored, and a new disk is formatted in 45 seconds by using the DSKINI command. This creates 35 tracks each containing 18 sectors. A sector contains 256 bytes.

When a file is created, it is allocated space in *granules*. A granule is half a track or 9 sectors. Therefore, a disk cannot contain more than 68 files: track 17 contains the directory, so $(35 \text{ tracks} - 1 \text{ track}) \times 2 = 68 \text{ files}$. The disk will contain fewer files if any of them are longer than one granule (2034 bytes). If your file contains only one character, it will consume 9 sectors on the disk. Also, if your file contains 2305 bytes, two granules will be allocated, with one of them virtually empty.

The directory is used by the disk operating system to keep track of where things are on the disk. The DIR command makes this directory available to you, so that you also can know what's on the disk.

The directory shows the names of all the files along with other useful information. All files must have names, unlike files stored on cassette. The directory also requires filenames to have a file extension, which can be provided by the user or given auto-

matically by the operating system. The extension can be up to three characters long and separated from the filename by either a dot or a slash. Typical filenames are:

```
ACCOUNTS.DAT
PROGRAMS.BAS
TEST/XXX
```

The name can be up to eight characters long. The default extensions are DAT for a data file, BIN for a machine-language file, and BAS for a BASIC program file.

In addition, the directory shows whether a file is stored in ASCII format or in BASIC token format and how many granules each file occupies. By using the FREE command, the number of unused granules on the disk can be determined.

Performance

Having struggled with a cassette recorder as my bulk storage medium, I was fascinated by the speed at which I could load programs and data from the disk. The data transmission speed is 250,000 bps (bits per second), and the track-to-track access time is 30 ms (milliseconds). This all results in delightfully quick data transfer.

The operating system uses a CRC (cyclic redundancy check) technique for trapping and correcting data-transfer errors. The reliability of the system is very high, and disk errors did not occur unless I turned off the disk drive or computer while it was writing to the disk.

In operation, the disk drive is quiet, and the disk rotates only while reading and writing. In the inactive state, the unit is silent. The stepper motor that drives the sensing head sounds smooth and convincing.

Teething Problems

An insert in the manual warned of two possible problems with the disk system. It first suggested that the computer's reset button be pressed before performing successive disk initializations. This is necessary apparently to ensure correct disk formatting.

The second problem relates to RFI

Choice

GNT Makes a Tape Punch Station and a Tape Reader/Punch Combination.

Both are small, quiet, and economical. One of them will fit your needs exactly.



The 4601 Combo

- Punching speed: 75 Cps
Reading speed: up to 150 Cps
- RS-232-C serial interface
- Utilizes all types of Mylar® and paper tape
- Reliability: MTBF 100 million characters

The 3601 Punch

- Punching speed: 50 or 75 Cps
- RS-232-C serial interface
- Utilizes all types of Mylar® and paper tape
- Reliability: MTBF 100 million characters

Serviced nationally by **Carterfone**

GNT AUTOMATIC INC.

1560 Trapelo Road, Waltham, MA 02154 (617) 890-3305 Telex: 923318



The First solution to the Pascal dilemma.

Pascal is unbeatable for large, complex programs.

Its structure and readability help you write reliable, maintainable code.

But when it comes to debugging, most Pascals are no help at all. And no matter which version you use, you're faced with a dilemma: stick to the "standard" subset, and forgo some of your machine's best features. Or use all the power of your compiler and hardware, but end up with a program that's difficult to move to another environment.

Introducing PascalSET™ Software Engineering Tools

PascalSET is a source code preprocessor that adds three much-needed facilities to virtually any Pascal system:

PMacro™

Lets you define extensions to Pascal, which are expanded (before compilation) into the appropriate code sequence. So you can use nonstandard language features without sacrificing portability. In fact, using PMacro's conditional expansion capability, you can create one version of your source program that produces the correct code for several different versions of Pascal.

PTrace™

Slashes debugging time by generating a complete execution trace—of any program, in any environment. Procedure entries and exits are recorded, along with values of selected variables. Tracing can be turned on and off by program events, and a profiling feature identifies "most used" code to guide optimization efforts.

PAdapt™

Adds a variety of Ada-style extensions to Pascal, including handling of exception conditions (such as bad input), explicit closure of conditionals and loops to improve structure ("END IF", "END WHILE", etc.), and specification of procedure parameters as input-only, output-only, or input/output.

PascalSET runs on virtually any system supporting standard Pascal. PMacro, PTrace, and PAdapt are also available as separate tools.

If you're involved in large-scale system or application development, PascalSET can give you a big productivity boost—for a minimal investment.

Call or write for details today.

.....
 . Tell me more about PascalSET for
 . my system.

. Computer

. Compiler (Supplied by)

. Name

. Company

. Street

. City State Zip

. Phone ()

. First Systems Corporation
 . 865 Manhattan Beach Blvd
 . Manhattan Beach, CA 90266
 . (800) 722-8679
 . in California: (213) 546-5581

BY?



**First Systems
Corporation™**

Products for productivity.

Circle 163 on inquiry card.

© 1982 First Systems Corporation

(radio frequency interference). Computers run at clock speeds that cause them to be good radio transmitters. The FCC (Federal Communications Commission) sets acceptable levels for RFI that the computer and disk system must meet. Much of the innards of the computer are housed in a metal box, and the PCB (printed-circuit board) is covered by a grounded metal shield. All this is designed to absorb radiated RFI.

The controller PCB has a similar shield, and the ribbon cable contains built-in shielding. However, for all this shielding to work properly, it is essential that it be well grounded. This means heavy connectors and wide copper tracks on the PCB. The ground connections at the cartridge socket are just two of the 40 pins. They are necessarily small and do not do the job. The result is that the disk system does radiate considerable interference to TVs. The effect can be minimized by careful positioning of the TV and the computer system

components, but generally it is unacceptable and does not meet FCC rules.

To rectify the problem, Radio Shack has installed a pair of large grounded connectors on either side of the cartridge socket in its current production of Color Computers. This eliminates the problem.

If your computer doesn't have the connectors, they can be installed at no charge if you take your unit to your local Radio Shack repair center. The repair center will also install an RFI shield under the keyboard as part of this retrofit.

My disk unit developed another problem after a few hours of continuous use. When a disk access was called for, the "in use" light came on, the disk spun, and everything else stopped. The stepper motor didn't operate. Resetting left the microprocessor in a halted state, and the only recourse was to power down, wait a while, and try again. With some concern, I set about getting the unit fixed.

At least it would give me the opportunity to find out how good Radio Shack's service was for this new product.

The fine cooperation I received from the store manager and service manager of my local Radio Shack Computer Center provided me with the guidance I needed to locate the faulty IC in the controller cartridge and replace it.

I found that the service department did not have much service information on the disk drive or controller. What the repair people had was sketchy and preliminary. Although I received the technical guidance to repair the unit myself, I don't feel that they were adequately equipped to repair the unit themselves. They would probably have resorted to substitution from another disk system to get mine running again. The service manager assured me that full service data was on its way, and by the time you read this, I'm sure all service departments will be fully prepared to service your disk system. However, I would have been happier if they were fully equipped with all the service information as the unit became available in the store.

Conclusions

- The disk system for the TRS-80 Color Computer is a versatile and useful addition. It combines a simple concept with some powerful features.
- The hardware is well made and has a solid, durable feel to it.
- The concept of putting the operating system in a ROM in the connector cartridge provides a simple, reliable, and easy-to-understand system.
- The supporting literature for the disk system is well written in an informal style that should appeal to everyone.
- The Disk System BASIC commands are easy to use and understand and are complete except for the omission of the CHAIN command and the ability to detect and respond to errors within a program.
- The addition of just one drive to the Color Computer enhances its capabilities and usefulness significantly. The second, third, and fourth drives are the icing on the cake. ■

INVESTMENT ANALYSIS FROM CENTENNIAL

CENTENNIAL SOFTWARE / 410 17TH ST. SUITE 1375 / DENVER, CO 80202 / (303) 595-9193

STOCK-FOCUS

Find out how low is low and how high is high. Using capital structure and performance data, Stock-focus objectively calculates the underlying value of a stock. The system was first developed by the management science department of a major money center bank, and is now in use by investment advisors, trust companies and brokerage houses. On your screen, Stock-focus will plot an estimate of lowest value, highest value and the current price. You then decide what to buy, sell or hold.

REAL-FOCUS

Exhaustively analyze potential real estate investments using the Wharton School's approach to real estate analysis. In minutes you can project profit, costs, and IRR for any project over a 10 year period. Real-focus accounts for amortization, debt, income, operating expenses, taxes, depreciation, and cash flows for both after-tax holding and the results of sale. With Real-focus you can analyze any potential investment from a single building project to a complex time-phased planned unit development.

THE FOCUS TECHNIQUE

FOCUS is CENTENNIAL SOFTWARE's new approach to Program Architecture, providing a natural interaction between microcomputers and users. It provides worksheet style input screens, free access to all program segments, and the ability to com-



bine individual results files for portfolio analysis. You also receive a usable reference manual, menu helps, a program glossary, multiple report formats and spooling. With our FOCUS technique even the most complex programs are versatile and easy to use.

COMPUTER	MEMORY-K	REAL-FOCUS	STOCK-FOCUS
IBM PC	64	\$179.00	\$189.00
Apple (plus) II	32/48	149.00	159.00
TRS-80 I	32/48	149.00	159.00
TRS-80 II	64	179.00	189.00
TRS-80 III	32/48	149.00	159.00

ALL PROGRAMS IN DISK BASIC

IBM is a trademark of IBM, Apple is a trademark of Apple Computer Corp. TRS-80 is a trademark of Tandy Corporation.

ORDER NOW! FILL IN OR CALL 800-525-2003 (Toll Free)

PROGRAM NAME _____ COMPUTER _____ MEMORY _____
 NAME _____ PHONE # _____
 ADDRESS _____  
 ACCOUNT # _____ EXP. DATE _____

CP/M USERS:

Prepare Even the Most Complicated Programs Quickly, Easily!

With EZ.COM Software Programming Aid

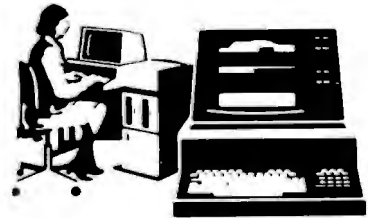

Program logically, conveniently by structure and modularity!

EZ.COM is an efficient programming tool that drastically reduces total cycle time of programming and eliminates the tedious construction of complex programs. EZ.COM creates and maintains libraries of program modules.

- Modules may be as long as 100 lines. Each library may be as large as 8 megabytes and may contain as many as 16 thousand modules.
- Modules may be created, transferred from another library, or purloined from other program source listings.
- Modules have no format restrictions and may consist of coding, tables, description text, display formats, etc!
- Modules are filed random access allowing instant storage and retrieval.

Written in efficient and fast 8080 assembly, EZ.COM produces easily debugged and understandable programs faster than any other technique. Many programs may coexist in the library in the form of module lists which may then be used to obtain source files. Using lists arranged as hierarchical structures, the most modern techniques of structured and modularized programming may be used. A library index is available on demand along with module catalogs and program source listings.

EZ.COM OFFERS THE SIMPLEST TO LEARN, EASIEST TO USE FULL PAGE EDITOR YOU'LL EVER SEE!

- All the special options and features you'll ever want!
- All edit features are detailed on an edit help page—a key stroke gets it and a second returns you to your original place.
- A spooler is provided for listing while you are editing.

GOOF PROOF? You can bet on it! An OOPS Key is provided to back out of any situation. Syntax edit is performed on the way in; all commands will be grammatically correct. RESET at any time, the files are protected.

For \$195 we'll send you the program along with sample files and reports on an IBM format 8" single density floppy, and an instruction manual you'll find to be an invaluable programming aid. Or, send \$35 for the manual alone (later applied towards your purchase of the program.) \$5.00 will bring you a program description with sample modules and reports.

The Softwarehouse

1542 W. Pepper
Mesa, Arizona 85201
or Call (602) 969-1430

**Requires CPM, 40 K RAM, at least one disk, and the dumbest of terminals.*

Upward Migration

Part 2: A Comparison of CP/M-86 and MS-DOS

An end user and a systems programmer examine the two operating systems vying for dominance in the 16-bit arena.

Roger Taylor and Phil Lemmons
c/o BYTE Publications Inc.
POB 372
Hancock, NH 03449

Last month, we looked at programs that translate 8-bit CP/M-80 software to 16-bit MS-DOS or CP/M-86 software. In this part, we look at what the translated software will find when it reaches the new world of MS-DOS and CP/M-86. We first examine the two operating systems from a non-technical user's perspective and then turn to a close technical look at how they make basic functions available to programmers. Along the way, we will report the results of some benchmarks.

We have also invited other individuals to express their opinions about MS-DOS and CP/M-86. These opinions appear in text boxes accompanying this article and represent a variety of perspectives. One expresses the view of a systems integrator; one states the view of an assembly-language programmer at a large applications and languages software house; one comes from an applications programmer working in high-level languages; one comes from a software house that produced a BIOS (basic input/output system) for CP/M-86 on the IBM Personal Computer, as well

as applications programs for both CP/M-86 and MS-DOS; and one was written by the head of a company that manufactures 8086-based S-100 systems and processor boards.

If any pattern of opinion seems to be emerging, it is that MS-DOS is a better and faster single-user, single-tasking operating system for nontechnical users (consumers). CP/M-86 offers superior memory management; development into a multitasking, single-user operating system; and an easier upgrade path to a multi-user operating system. The issues, however, are complex, and many dissenting voices are heard. To complicate matters further, vendors of both operating systems are promising major changes this year. You will have to make the decision in light of your exact needs in an operating system.

The Nontechnical User's Perspective

Most microcomputer users spend their time running off-the-shelf applications programs and, to a lesser degree, writing programs in high-

level languages like BASIC and Pascal. For these users, comparing Digital Research's CP/M-86 and Microsoft's MS-DOS (sold by IBM as PC-DOS and by Lifeboat Associates as SB-86) is a study in trade-offs. We will first examine some of the trade-offs in the current versions of MS-DOS and CP/M-86. Then, we will describe what additional trade-offs may appear in the enhanced versions promised for later this year.

Speed and Space

The most obvious general advantages of MS-DOS are its greater speed in disk input/output, greater efficiency in use of disk space, and its ability to recover from errors.

MS-DOS is faster primarily because it buffers more data in each gulp and because it keeps the File Allocation Table in memory rather than on disk. CP/M-86 keeps information about file locations stored on the disk, and buffers data in small mouthfuls. Tables 1, 2, and 3 give some timings of MS-DOS and CP/M-86 on the same hardware. It should be noted, however, that the

For serious business microcomputing, only one operating system exactly fits.

Whether you're in business and do microcomputing, or in computing and sell to business, you'll like OASIS.* Not a hobby or scientific system warmed-over for business use, OASIS is the only operating system designed from the ground up for business.

SERIOUS BUSINESS

COMES IN ALL SIZES.

Whatever your business need, OASIS has the operating system to match: 8-bit or 16-, single-user or the multi-user system that professionals tell us makes micros run like minis. And that's even truer now with new OASIS-16.** (OASIS exact business fit #1: choice.)

ANY SYSTEM IS ONLY

AS GOOD AS THE

BUSINESS

PROGRAMS IT RUNS.

The acid test for any business operating system is the application software available to run on it. There's plenty for OASIS—for nearly any job.

And it's top quality, too, because our integrated tools are top quality—and there are more of them. Like a high-level BASIC Interpreter/Compiler/Editor/Debugger; ISAM/Keyed/Direct/Sequential Files; a smart Print Spooler; Automatic Record Locking (OASIS exclusives!); plus COBOL & 'C' Languages. These tools are mandatory for high-quality business application program development—ask any developer. (OASIS exact business fit #2: high-quality application software.)

PORTABILITY PROTECTS BUSINESS

SOFTWARE INVESTMENTS.

OASIS is custom-fitted to manufacturers' hardware so application software developed to run on one OASIS equipped machine can also run on others—and is upwardly compatible from 8-bit OASIS Single-User to Multi-User, on up to OASIS-16. This kind of application software portability is exclusive with OASIS.

Device independence allows various printers and terminals to be used—with no modification to application

Circle 305 on inquiry card.

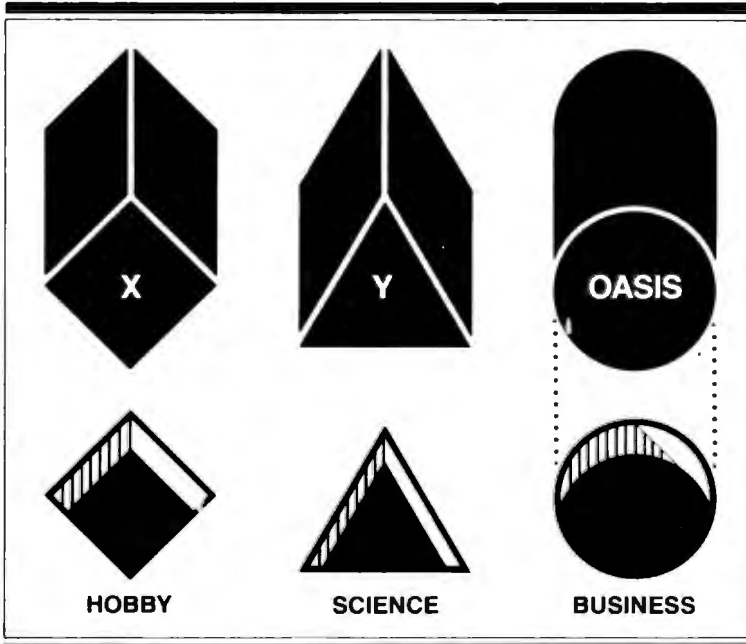

available, type 'HELP' and the command function title—OASIS displays the syntax and options available.

And it's all in your language—not computerese. (OASIS exact business fit #5: user-friendliness.)

AND, AND, AND...

Some of the best, most extensive documentation in the industry; a packed Application Software Directory; multi-level training; direct telephone support; worldwide sales & service; options like CONTROL Relational Data Base Management System and MASTERPLAN Financial Modeling Package; OASIS has it all. (OASIS exact business fits #6 through #12.)

Now you know why there's no reason to struggle trying to put a square peg in a round hole. For serious business microcomputing,

there is one operating system that exactly fits: OASIS. Call or write us today for details.

* For Z80

** For 8086, 68000, Z8000, LSI-11, & others

software: OASIS system software compensates for differences. (OASIS exact business fit #3: portability.)

ACCURATE DATA & A SECURE

SYSTEM REDUCE BUSINESS RISKS.

Data integrity—a challenge for any multi-user system—is insured by OASIS File & Automatic Record Locking. With it, normally all users can view a record at the same time. BUT, if the record is being updated by one user, other users are automatically denied access until the update is complete. That means data is always accurate and up-to-date. And it's still another OASIS exclusive.

For system security, there's OASIS Logon, Password & Privilege Level. User Accounting keeps track of who used the system, when. (OASIS exact business fit #4: data integrity/system security.)

A FRIENDLY SYSTEM IS

GOOD BUSINESS.

For user-friendliness, OASIS sets new standards. Example: the EXEC Job Control Language is so smart it walks users through their applications—and around the operating system.

With our 'HELP' feature, if you are unsure of the functions and options

OASIS

STRICTLY BUSINESS

PHASE ONE SYSTEMS, INC.

7700 Edgewater Drive, Suite 830
Oakland, CA 94621-3051
Telephone 415/562-8085 TWX 910-366-7139

I'm serious about my business please send me

- OASIS-16 Manual, \$75
- OASIS Manual, \$60
- Free Application Software Directory and put me on your mailing list.

(Add \$3 for shipping California residents add sales tax)

Name _____

St (No Box #) _____

City _____ State _____ Zip _____

Check enclosed UPS C.O.D.

VISA Mastercharge

Card No. _____ Exp. date _____

Signature _____

Benchmark	System X CP/M-86 1.0 BASIC-86 Rev. 5.21	System X CP/M-86 1.0 BASIC-86 Rev. 5.22	System X Preliminary MS-DOS BASIC-86 Rev. 5.21
Empty do-loop	7.2	7.3	7.8
Division	25.0	20.6	21.8
Subroutine jump	15.5	15.4	16.9
MID\$ (substring)	23.6	23.6	24.6
Prime number program	199.2	189.9	197.0
Disk write program (64K-byte file)	60.8	60.8	50.3
Disk read program (64K-byte file)	20.6	20.3	21.3

Table 1: Timings of benchmark programs run in Microsoft BASIC-86 under CP/M-86 and MS-DOS. The three sets of timings differ on the computational benchmarks (the first five) because the BASICs themselves are different. BASIC-86 comes in two different versions for CP/M-86, as well as a version for MS-DOS. MS-DOS's superior speed in the disk-write benchmark is remarkable because the version run was a preliminary version that had not yet been optimized for disk input/output on system X.

	System X CP/M-86 1.0	System X Preliminary MS-DOS
Load BASIC-86 30K bytes	5.7	2.7

Table 2: Timings for loading BASIC-86 under CP/M-86 and MS-DOS. Again, note that this preliminary version of MS-DOS had not yet been optimized for disk input/output on system X.

	IBM-PC Compuview CP/M-86 PIP	IBM-PC MS-DOS 1.1 COPY
File copy: Copy three files 13K, 13K, 6K	36.9	19.3
Load 30K file using VEDIT	10.1	18.8

Table 3: Timings for file-copying and file-loading under CP/M-86 and MS-DOS on the IBM Personal Computer. MS-DOS's COPY command is faster, partly because it resides in system memory rather than on disk, and despite the fact that the BIOS in the Compuview CP/M-86 seems quite fast. The speed of the Compuview BIOS is reflected in the time required to load Compuview's editing program VEDIT with a 30K-byte text file. The CP/M-86 version of VEDIT is actually faster than the MS-DOS version. (BASIC-86 is unavailable for use with CP/M-86 on the IBM Personal Computer.)

differences in speed are proportionally less on large operations because CP/M-86 has to find a file only once, at the beginning. Different versions of CP/M-86 also vary greatly in speed. Hardware manufacturers write a CP/M-86 BIOS for their own systems, which vary in performance. Finally, on systems using hard disks, disk input/output under either MS-

DOS or CP/M-86 is so fast that any differences are negligible. The fact remains that MS-DOS is significantly faster on floppy-disk-based systems, as the benchmarks in table 1 show.

MS-DOS uses disk space more efficiently because it can have files ranging in size from tiny to huge. CP/M-86 allocates disk space in blocks of 2K bytes even when the ac-

tual data in the file is only a few bytes—like letting a mouse sleep in a separate queen-size bed. With larger data files, of course, CP/M-86's methods of allocation are less wasteful. But if your system's disk space is limited, wasting 2K bytes to store a few bytes can be important.

Error recovery in an operating system functions like the shoulder on a mountain road: in its absence, one wrong move can plunge you into the abyss. Error recovery is especially crucial to new and nontechnical computer users. MS-DOS provides error recovery as part of the disk operating system; as for CP/M-86, there is no provision for error recovery in the disk operating system, although there is nothing to stop a hardware manufacturer from writing error recovery into its own BIOS for CP/M-86. Manufacturers don't always do so.

With CP/M-86 (unless the manufacturer does add error recovery), if you try to read a disk in an empty drive, or forget to turn on the printer before trying to print a file, the system either "hangs" (no message at all) or presents a farewell message explaining why the system is shutting down. This is about as useful as having a note pinned to your chest to inform you that you are dead. If you're trying to save new data on disk, the data is lost. If the problem is a bad sector on the disk, you can't swap disks and try again. You have to reload the operating system and do again whatever work was wasted. MS-DOS responds to errors by offering you a chance to salvage the situation. A typical message is:

Data error reading drive B
Abort, Retry, Ignore?

If the problem is a bad disk, you can insert a new disk in B and retry. If the printer is off, you can turn it on and retry. You can also abort the operation and start over without reloading the operating system.

Help

CP/M-86 comes with a large HELP file. Whenever you are puzzled about what to do, if you type HELP and the

NEW

512KB WITH RS232-C PORT IBM PERSONAL COMPUTER MEMORY!



SINGLE BOARD 512KB WITH RS232-C IBM PERSONAL COMPUTER MEMORY

Designed Specifically for IBM's PERSONAL COMPUTER is Chrislin Industries newest CI-PCM+ Memory Module.

FEATURES INCLUDE:

- On board parity generator checker.
- Up to 512KB in a single option slot with Personal Computer Compatible RS232-C Port.
- Off-the-shelf deliveries.
- Full one-year parts and labor warranty.
- Pin-to-Pin compatibility.
- Available in 64KB, 128KB, 192KB, 256KB, and 512KB configurations.
- Addressable as a contiguous block in 64KB increments through 1 megabyte.

DON'T ASK WHY WE CHARGE SO LITTLE, ASK WHY THEY CHARGE SO MUCH.



Chrislin Industries, Inc.

31352 Via Colinas • Westlake Village, CA 91362 • 213-991-2254
TWX 910-494-1253 (CHRISLIN WKVG)

Limited High-Level Languages: Caveats for MS-DOS Software Developers

Camilo Wilson
Lifetree Software Inc.
117 Webster St.
Monterey, CA 93940

[Mr. Wilson is the author of *Volkswriter*, a word processor written in Pascal for the IBM Personal Computer.]

While the MS-DOS operating-system environment has many useful features for program development, and indeed the first crop of IBM software is primarily designed to satisfy the needs of programmers, this software has severe shortcomings in large applications.

The drawbacks revolve around the usage of the computer's address space and the lack of documentation of the internal workings of MS-DOS, BASIC, and Pascal. In BASIC, your program cannot be larger than 64K bytes, nor can your variables take up more than 64K bytes of room. Although the DEF SEG statement lets you place variables in other memory segments, you are left with the problem of where they should be, and you have to become intimately familiar with the workings of machine language and BASIC before you can use this feature. On the other hand, the CHAIN statement lets you handle larger programs so that the limitation on program size is not severe.

But BASIC is not a language for writing complex programs, both because of its inefficiency and its cumbersome nature. BASIC is intended as a

language for solving small problems simply and quickly, not for systems implementation. For that there is Pascal, an excellent language, whose set of IBM extensions makes it quite powerful and easy to use.

Drawbacks of Pascal

Unfortunately, Pascal suffers from the same problems. A Pascal program cannot be larger than 64K bytes. About one-third of this space is taken up by library routines that you cannot use as needed (if you need one routine out of a family, you must carry the whole family in your program). Similarly, MS-DOS takes 12K bytes regardless of how much of it you use. Most important, unlike in BASIC, you cannot chain programs so that they overlay each other. This alone makes a wonderful language almost useless for large applications.

In Pascal, you cannot have more than 64K bytes of combined variable space, stack space, and heap (dynamic storage allocation) space. However, like BASIC's DEF SEG, the ADS data type allows you to address any memory location, even outside the 64K-byte data segment. But once again, you have to do your own storage bookkeeping within the extra segments.

Where does this leave the software developer? Without extensive knowledge of the 8086 architecture and a great deal of snooping at the actual contents of memory, it is impossible to write a large program such as a word processor, a spread sheet, a database handler, or even a complex vertical application. While larger software companies may have the necessary talents in-house, many smaller companies do not. The obvious result: no software for the Personal Computer owner.

Necessary Steps

What can be done? Lots. IBM should release a linkage editor, compiler, assembler, and loader that allow overlays; if not, CP/M-86 and UCSD Pascal will become the systems of choice for the larger applications where the Personal Computer can shine. Meanwhile, IBM should release comprehensive technical documentation for DOS, BASIC, and Pascal.

IBM has done an excellent job so far in supporting the software author, but key pieces are missing: overlays and, most important, comprehensive technical documentation. Mainframe users are provided with program logic manuals and extensive documentation. Why not Personal Computer users too?

name of a command, CP/M-86 will provide instructions for the command. If you can set aside 22K bytes of disk space for the HELP file, CP/M-86 is much friendlier than CP/M-80 used to be. Moreover, the new CP/M-86 user's guides are much better than their predecessors. These include a *CP/M-86 Operating System User's Guide*, *CP/M-86 Operating System Programmer's Guide*, and *CP/M-86 Operating System System Guide*. The user's guide and the HELP command make learning CP/M-86 a less forbidding challenge for novices.

MS-DOS's provision for error recovery makes it safe for novices to

learn by doing. It can therefore be argued that the Microsoft operating system doesn't need online HELP. But both error recovery and online HELP are necessary if a system is to be *really* friendly.

Reconfiguration

This is where CP/M-86 shines and MS-DOS emphatically does not. CP/M-86's STAT program provides a way to change device assignments. If, for example, you want to use a serial printer as the LST (list) device or printer in your system, you can use STAT to make a change in the oper-

ating system resident in the computer's memory. You can also use CP/M-86's DDT-86 (dynamic debugging tool) to change device assignments lastingly in the operating system on the disk. This changes CP/M's famous IOBYTE—the byte in which the operating system keeps device assignments. Neither of these ways of changing device assignments is clear to novices, but you can often get computer dealers to change IOBYTE for you or give you written instructions for making the necessary changes.

If you have an MS-DOS system and buy some new hardware, you

PERSONAL COMPUTERS PERSONAL COMPUTERS PERSONAL COMPUTERS PERSONAL COMPUTERS

Amdek Video-300	149.00
Amdek Color-I Monitor	329.00
Amdek Color-II Hi-Resolution 13" Monitor	729.00
Amdek Color-III Monitor	439.00
Atari 400 16K	349.00
Atari 810 Disk Drive	449.00
Atari 850 Interface	169.00
Atari 800 16K	669.00
Diablo 630	2095.00
Epson MX-70	289.00
Epson MX-80 w/Grafrax	439.00
Epson MX-80 FT w/Grafrax	549.00
Epson MX-100 FT Printer	695.00
Hayes Micromodem II (Apple II)	289.00
Microtek 16K Ramboard for Atari 800	79.00
Microtek 32K Ramboard for Atari 400 & 800 ..	149.00
Microsoft Soft Card (Z-80)	279.00
Microsoft Soft Card Premium System for Apple	579.00
Microsoft Ramcard 64K for IBM-P.C.	369.00
Microsoft Ramcard 16K for Apple	139.00
NEC 3510 or 3530 Spinwriter	1675.00
NEC 3515 Spinwriter	1695.00
NEC PC-8023 Printer	489.00
NEC JC1201 M(A) — Color 12" Monitor	329.00
NEC GREEN JB1201M — 12" Monitor	169.00
Okidata Microline — 80 Matrix Printer	329.00
Okidata Microline — 82A	449.00
Okidata Microline — 83A	729.00
Okidata Microline — 84	1195.00
Sharp PC-1500 Pocket Computer	239.95
Sharp CE-150 Color Printer/Cassette I/F	199.95
Sharp PC-1211 Pocket Computer	135.95
Sharp CE-122 Printer/Cassette Interface for PC-1211	99.95

AMDEK VIDEO 300G 12" GREEN MONITOR



New Low Price
\$149.95

AMDEX VIDEO 100 12" B + W



Limited Time Special
\$79.95

Televideo 910	559.00
Televideo 912C	669.00
Televideo 920C	749.00
Televideo 925	735.00
Televideo 950	929.00

CALL TOLL FREE!
800-343-0873

Stock Shipments Same Day or Next
No Surcharge for Credit Cards
All Equipment Factory Fresh w/MFT Warranty
Prices do not Reflect Shipping Charges
Mass. Residents Please Add 5% Sales Tax

**PRICES ARE SUBJECT TO
CHANGE WITHOUT NOTICE**

We carry the complete line of Atari Hardware, Software & Peripherals.

We will try to match or beat any price with similar purchase conditions.

OMEGA SALES COMPANY

430 PEARL STREET, STOUGHTON, MA 02072
(617)344-6645

may have to be a skilled assembly-language programmer to reconfigure your operating system to use the hardware. In this respect, MS-DOS is like a Ferrari that requires a mechanical engineer to change a flat tire.

Microsoft prides itself on MS-DOS's device-independent input/output. Promotional literature for MS-DOS explains the happy result: "There is no need to rewrite programs when a new device is added to the system." The concept of device-independence is attractive. The operating system can treat devices just as if they were files. But this is small solace to the many IBM Personal Computer owners who acquire a serial printer they would like to use. The only way for people with little technical knowledge to use a serial printer with this computer is to write a BASIC program that asks for a file specification. The file specification in the PC-DOS version of BASIC-86 can include such things as COM1 (the serial port), the data-transmission rate, etc. While this adaptability in file specification is commendable, who wants to load BASIC, run a BASIC program, and enter a long file specification just to print a text file? Or to hit the IBM's PRINTSCREEN key only to be told that the printer device is unavailable?

The glaring omission of a handy way for people with little technical knowledge to reconfigure MS-DOS has forced many to beg their dealers for software fixes or to spend hundreds of dollars for a redundant parallel printer. The dealers queried were either supporting a single model of serial printer or, more often, none at all. A call to Microsoft a few months ago brought the advice, "Don't expect support for serial printers on the Personal Computer until IBM is selling a serial printer." There is hope, however. Microsoft president Bill Gates promised Personal Computer followers at the West Coast Computer Faire that a future version of MS-DOS will include support for serial printers.

Now for comparisons of utilities that perform some of the most com-

mon operations in each operating system.

COPY Versus PIP

MS-DOS keeps its file COPY program (and its File Allocation Table, as noted earlier) resident in memory. Before actually starting to copy a file, CP/M-86 must read from the disk both its Peripheral Interchange Program (PIP) and the location of the file named for copying. The result is that COPY transfers a file much faster than PIP does.

Both Microsoft and Digital Research are moving to correct deficiencies.

In defense of PIP, it does more than just copy files. Placing single-character switches after the PIP command causes it to do such things as echo transferred data to the console (video display), filter formfeeds out of the file, check data for proper Intel hexadecimal format, translate uppercase characters to lowercase or vice versa, add line numbers to the destination file, set page length if the file is going to a printer, quit or start copying after finding a certain string of characters in the file, expand tabs in the file by adding spaces, verify that the file has been copied correctly, and mask the eighth bit in each byte transferred. PIP is larger because it does more. But most of PIP's extra functions have less appeal to nontechnical users than to assembly-language programmers. For most of us, the main thing is that COPY runs like lightning.

CHKDSK and DIR Versus STAT and DIR

STAT, the CP/M-86 utility that reports statistics about the contents and status of a disk, also lets you change device assignments (as noted above). STAT will give detailed information about each file on a disk. The MS-DOS program CHKDSK (for Check Disk) reports only a summary of the status of a disk and the status of system RAM (random-access read/

write memory), i.e., the number of bytes free. Both STAT and CHKDSK reside on disk, and their speed of operation is similar.

Both MS-DOS and CP/M-86 have a directory command, DIR, residing in system memory. In CP/M-86, the DIR command just lists the names of files. In MS-DOS, DIR tells you the exact size of each file and the date that it was last written to disk. The DIR command is fast in both systems.

The Technical User's Perspective

We will now make some observations about a few MS-DOS features that differ from CP/M-86. Then we will make a close comparison of the way the same basic operating-system functions are made available to the programmer under CP/M-80, CP/M-86, and MS-DOS. Finally, we will show the results of some simple benchmarks of CP/M-86, MS-DOS, and EM-86 running under MS-DOS, which lets MS-DOS emulate CP/M-86.

DEBUG Versus DDT-86

With one important exception, DEBUG is the rough equivalent of DDT-86. While DDT-86 has an Assemble command, DEBUG does not. As a result, MS-DOS gives programmers no quick way to test ideas or hardware or to install patches by writing a small assembler program in memory.

Error Trapping

MS-DOS permits an applications program to trap disk errors so as to invoke appropriate routines to keep the program running or to shut down gracefully. Since CP/M-86 doesn't permit such error trapping, premature exits from applications programs do happen.

The FORMAT Programs

Under MS-DOS, you must specify when you format a disk that you want to create a "bootable" MS-DOS disk. You can't put a bootable system on an existing data disk. The MS-DOS approach permits a data disk to have more room than a bootable

16 Bit 8086 Multi-User Microcomputer System

\$7595
FOUR
USER
SYSTEM

FOR **MP/M-86™**

ONLY
\$1899*
PER
USER



THE
TEC 86M

1/2 MEGABYTE
OF MEMORY
TWO 8 INCH D.D.
FLOPPY DISKS

STANDARD FEATURES

- 16 BIT 8086 CPU** - Processor performance is the most critical element in a Multi-User System. Speed, power and the increased throughput of our 16 Bit 8086 CPU are just a few of the reasons why our TEC 86M Multi-User Systems really perform.
- 1/2 MEGABYTE OF MEMORY** - The second most important factor which affects system performance is available user memory. Our 1/2 Megabyte, four user system gives each user well over 100K Bytes of memory, eliminating program size compromises which lead to poor Multi-User system performance.
- MP/M-86™ COMPATIBILITY** - The TEC 86M includes a ROM Boot for MP/M-86™ and is designed to provide optimal support for MP/M-86™. The MP/M-86™ Operating System is available separately from Tecmar for \$600. See Software Options listed below for important MP/M-86™ features.
- FULLY INTERRUPT DRIVEN** - The TEC 86M provides terminal and disk I/O interrupts to MP/M-86™, allowing for maximum system performance in Multi-User operation.
- TWO 8 INCH DOUBLE DENSITY FLOPPY DISK DRIVES** - The two Double Density floppy disks total 1.2 Megabytes of storage. Options include double sided floppy disk drives and Winchester drives.
- FOUR SERIAL USER PORTS** - Four serial user ports are provided. Each port can be independently set for speeds from 50 to 19200 Baud.
- MULTIPLE PARALLEL PORTS** - Parallel ports are provided for operating printers as well as other parallel devices.
- EASILY EXPANDABLE** - The modular design of the Tec 86 and Tec 86M assures you of continued system expandability. All options are easily field installable. Available options include: Memory 64K and 256K, additional users, double sided floppy disks, Winchester 31 Megabyte hard disk, terminals, and printers.
- ATTRACTIVE DESKTOP ENCLOSURE** - Tecmar Single and Multi-User systems come in your choice of an attractive desk top enclosure with wood grained side panels to blend nicely into your office surroundings, or an industrial quality cabinet for more hostile environments. Rack mount enclosures are available as options.
- ONE YEAR WARRANTY** - Tecmar Systems are fully assembled and thoroughly tested. All Tecmar Components carry a full One Year Warranty.

SOFTWARE OPTIONS

- MP/M-86™** - Multi-User interrupt driven Operating System for the 16 Bit 8086 TEC 86M Microcomputer System. **FILE PASSWORD PROTECTION** - Access to user files can be restricted to require proper passwords prior to access. **CONCURRENT FILE ACCESS** - Files may be accessed by multiple users, each reading and/or writing the same file, with protection provided at both the file and the record level. **FILE TIME AND DATE STAMPING** - Files contain creation, and modification Times and Dates for ease and accuracy in determining the latest or most useful file versions. **PRINT SPOOLER** - Files may be submitted to the System Spool file for printing. This frees the user terminal to continue operation during the independent printing function.
- LANGUAGES** - BASIC-86™ FORTRAN-86™ PASCAL-86™ CBASIC/86™ CIS-COBOL™ PASCAL/M86™ FORTH
*NOT INCLUDING MP/M-86 and User Terminals.

OTHER FINE S100 and APPLE PRODUCTS AVAILABLE, INCLUDING:

- ANALOG to DIGITAL CONVERTERS** (12, 14, 16 bit accuracy; 30, 40, 100, 125 KHz Conversion rates; 16 to 256 Channels; programmable gain; timer/counters). **DIGITAL to ANALOG CONVERTERS** (12 bit accuracy, 3 microsecond conversion rate). 8086 CPU Board, I/O Boards 64K/256K Memory Boards, Real-time Video Digitizer and Display. Complete Systems also available for Data Acquisition, Video Digitization, and General Purpose Applications.

REQUEST OUR CATALOG FOR COMPLETE LISTING, AND SPECIFICATIONS ON THE ENTIRE TECMAR PRODUCT LINE.



TECMAR
INC.

DEALER INQUIRIES INVITED

23600 Mercantile Rd. • Cleveland, OH 44122

TECMAR, INC.

(216) 464-7410

CP/M-86 and MP/M-86 are registered trademarks of Digital Research Inc. BASIC-86, FORTRAN-86 and PASCAL-86 are registered trademarks of Microsoft Inc. PASCAL/M86 is a registered trademark of SOCRUM. CBASIC/86 is a registered trademark of Computer Systems Inc. CIS-COBOL is a registered trademark of MicroVadis Inc. CANADA: Our Ontario Distributor is OCTANT COMPUTER SERVICES INC., 146 Front Street West, Suite 485, Toronto, Ontario M5J 2L7 (416) 598-1046

The Systems Integrator's View of MS-DOS and CP/M-86

Jerry Houston
Vice-President
G&G Engineering
13708 Doolittle Dr.
San Leandro, CA 94577

To a systems integration house, it is unfortunate when two respectable but incompatible operating systems contend for acceptance on the same equipment. A company that runs trains would no doubt prefer that tracks be standardized, and a company that makes cars would surely prefer that a single fuel type be universally available. Amtrak and Chrysler may have their problems, but it is not the dreaded compatibility problem. That problem is reserved for systems integrators trying to decide on a 16-bit operating

- minor BDOS advantages
- major BDOS advantages
- other advantages
- major advantage

BDOS advantages are of importance only to those who wish to write assembly-level software (something more common to systems integrators and software developers than to end users). "Other Advantages" are still technical, but may affect an end-user's decision to commit to one operating system or the other. "Major Advantages" is the killer advantage that makes

in turn can allocate space for other programs, etc.

Other Advantages of CP/M-86

The debugger/monitor included with CP/M-86 (DDT-86) has an online assembler. DEBUG, the debugger/monitor that comes with MS-DOS, curiously lacks this feature.

High-level languages supported under CP/M-86 include several important commercial compilers, including:

CBASIC 86—Compiler Systems (now Digital Research)

Continued from page 338:

Other Advantages of MS-DOS

File granularity in MS-DOS is down to the byte. A great deal of execution time and programming effort can potentially be saved by this feature, since it is not necessary to become mired down parsing through logical records to access physical bytes.

File size under MS-DOS is virtually unlimited. The size of mass-storage devices available for microcomputers has been increasing at a dizzying pace, and the 8-megabyte limit imposed by CP/M-86 already seems confining. Future database applications may actually approach a gigabyte. MP/M-86 has extended the logical drive and file

size of the Digital Research family, but single-user versions continue to strain under the 8-megabyte limitation.

Biggest Advantage of MS-DOS

8086-compatible versions of Microsoft's popular line of high-level languages, although announced for CP/M-86 by Microsoft, are as yet available only for MS-DOS.

Summary

CP/M-86 seems to be the professional continuation of the line of software begun with CP/M-80, while MS-DOS may well be the consumer line of

the family tree. IBM has only just released CP/M-86 for the Personal Computer, although it had announced its imminent availability since the first press releases on the Personal Computer. This gives MS-DOS a firm edge in the 16-bit consumer market. However, the lack of any expandability into the multi-user world imposes a considerable limitation on MS-DOS, and its poor memory-management capability may force high-level languages written for MS-DOS to perform just like their 8-bit predecessors. Both operating systems have advantages, which makes choosing between them a painful task.

disk, but it requires greater foresight. You must make the decision to have a bootable disk at the time of formatting.

Access to Functions of CP/M-80, CP/M-86, and MS-DOS

We will now discuss how the programmer can make these three operating systems perform useful functions. Some familiarity with CP/M-80 is assumed.

To interact with the disk operating system, the programmer must first place in the appropriate register the function codes listed below. The appropriate registers are as follows: for CP/M-80, the C register; and for CP/M-86 and MS-DOS, the CL register. Any information that the operating system needs must be placed in another register or set of registers: for

in the AL register and, in some cases, also in the ES register. CP/M-86's use of the ES register in this way can complicate matters. The impact follows when CP/M-86 loads an executable file and gives control to the applications program. CP/M-86 sets the four segment registers, including the ES register, to the proper values when the program is loaded. But if the program makes a BDOS (basic disk operating system) call to CP/M-86, the value in the ES register may be changed. That means you have to take care to restore the ES register to the value it held when the applications program was loaded.

If the information to be returned by the operating system is more than one byte, CP/M-80 returns it in the HL register pair, and CP/M-86 and MS-DOS return it in the BX register.

in memory and for the memory allocation to remain as it is.

Function 1—Console Input with Echo: CP/M-80 and CP/M-86 expand tabs and look for the characters Control-S for scroll control and Control-P for printer copy; MS-DOS looks for Control-Break for scroll control.

Function 2—Console Output: Same as for function 1.

Function 3—Reader Input: CP/M-80 and CP/M-86 have device assignment through the IOBYTE facility if the OEM (original equipment manufacturer) chooses to implement it. MS-DOS supports only one auxiliary input device.

Function 4—Punch Output: Same as function 3.

Function 5—List Output: Same as function 3.

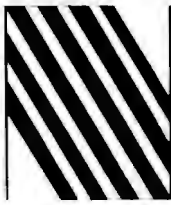

NEECO



Commodore Computer

VIC 20 Personal Computer	\$ 299 95
VIC 1515 Graphic Printer	\$ 395 00
CBM 4016	\$ 995 00
CBM 4032	\$1295 00
CBM 8032	\$1495 00
CBM SuperPet 9000	\$1995 00
CBM 8050 Dual Disk Drive	\$1795 00
CBM 4040 Dual Disk Drive	\$1295 00
CBM 2031 Single Disk Drive	\$ 695 00
CBM 4022 Tractor Printer	\$ 795 00
CBM 8010 IEEE Modem	\$ 279 00
CBM Datasette	\$ 74 95
CBM-IEEE Interface Cable	\$ 39 95
IEEE-IEEE Interface Cable	\$ 49 95

Professional Software for CBM Computers

WordPro™ — a Family of CBM Word Processing Programs

WordPro 2 Plus	\$ 199 95
WordPro 3 Plus	\$ 295 00
WordPro 4 Plus	\$ 450 00
WordPro 5 Plus (for CBM 8096)	\$ 450 00
The Administrator (DataBase for CBM)	\$ 650 00
Power™ (Programmer's Utility ROM)	\$ 89 95
InfoPro™ (DataBase for CBM)	\$ 295 00

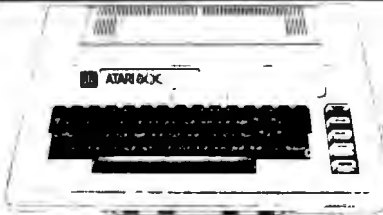

Atari

Atari 400 16K	\$ 399 00
Atari 800 16K (incl BASIC cartridge)	\$ 899 00
Atari 410 Recorder	\$ 99 95
Atari 810 Disk Drive	\$ 599 95
Atari 822 Thermal Printer	\$ 299 95

Amdek Monitors

Video 100C	\$ 179 00
Video 300C	\$ 200 00
Color 1	\$ 449 00
Color 2	\$ 999 00

CMD Mupet

MC-800A Mupet Controller (Multi-User Controller for CBM Computers)	\$ 995 00
CM-100 Channel Module	\$ 250 00
Printer Module	\$ 350 00

Quine

Sprint 9/45	\$2495 00
Tractor Option	\$ 210 00

Epson Printers

MX-70	\$ 299 95
MX-80 w/Graphtrax	\$ 645 00
MX-80 FT	\$ 745 00
MX-100 FT	\$ 945 00
INTERFACE CARDS	
8141 RS-232 Interface Board	\$ 75 00
8145 RS-232 Interface Board w/2K Buffer	\$ 149 00
8151 RS-232 Interface Board w/X/ON-X/OFF	\$ 170 00
8161 IEEE Interface Board	\$ 55 00
8131 Apple Interface Card	\$ 85 00
8232 Apple Interface Cable	\$ 35 00
8220 TRS-80 Cable	\$ 35 00

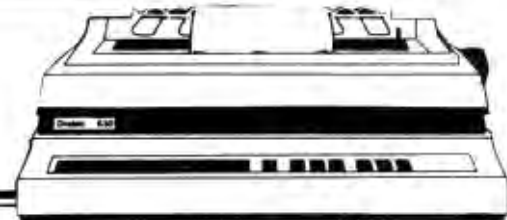

Diablo 630 Printer

Diablo 630	\$2710 00
Tractor Option	\$ 350 00

NEC Spinwriter Printer

NEC 7730	\$3085 00
NEC 7710	\$3085 00
NEC 7720	\$3610 00
NEC 3510	\$2290 00
NEC 3500RD	\$1895 00

Tractor Feed Options are available

*WordPro, POWER, & InfoPro are registered trademarks of Professional Software Inc.

CALL FOR OUR 70 PAGE CATALOG FOR COMPLETE PRODUCT LINE AND PRICE LISTINGS. WE WILL MATCH SOME ADVERTISED PRICES ON CERTAIN PRODUCTS LISTED UNDER SIMILAR "IN STOCK" CONDITIONS.



NEECO

679 Highland Ave.
Needham, MA 02194

(617) 449-1760
TELEX: 951021

MON-FRI 9:00 - 5:30 E.S.T.



MASTERCARD *UISA

systems, no check for special characters is performed.

Function 7—Get IOBYTE: CP/M-80 and CP/M-86 both support this function the same way. MS-DOS, however, treats this function as direct console input without echo and with no Control-Break check.

Function 8—Set IOBYTE: CP/M-80 and CP/M-86 treat this function the same. MS-DOS treats this the same as function 1, console input without echo.

Function 9—Print String: CP/M-80, CP/M-86, and MS-DOS all treat this function call the same way.

Function 10—Read Console Buffer: CP/M-80 and CP/M-86 treat this the same way, with the regular CP/M editing characters. MS-DOS allows the buffer to be edited with its own

editing characters and implements the template scheme to make command editing easier. MS-DOS also places a Carriage Return after the last character in the buffer, but the Carriage Return is not counted in the character count, in order to retain compatibility with existing software.

Function 11—Get Console Status: CP/M-80 and MS-DOS return OFF hexadecimal if a character is ready, and 0 if it is not ready; CP/M-86 returns a 1 if a character is ready, and 0 if it is not ready.

Function 12—Return Version Number: CP/M-80 and CP/M-86 return the version number. MS-DOS treats this function as a clear keyboard buffer and invokes an input function, where the function code is in the AL register and is function 1, 6, 7, 8, or

10 (referring to the functions on this list). These functions result in waiting for a new character to be typed.

Function 13—Reset Disk System: This function is treated the same by all three systems. Disk A is selected as the default drive.

Function 14—Select Disk: CP/M-80 and CP/M-86 treat this the same way, naming the disk drive designated in the DL register as the default drive, with the value 0 designating drive A, 1 designating drive B, etc. MS-DOS uses the DL register in the same way and also returns the total number of disks in the AL register.

Function 15—Open File: CP/M-80 and CP/M-86 treat this function the same, returning in the A or AL register a directory code of 0, 1, 2, or 3, indicating success, or OFF hexa-

Text continued on page 348

Strengths and Gaps in MS-DOS and CP/M-86

Rick Fortson
Programmer/Analyst
Compview Products Inc.
1955 Pauline Blvd.
Ann Arbor, MI 48103

Timo 'lv J. Lock
President, Microcraft Systems Inc.
Systems Software Manager
Compview Products Inc.
1955 Pauline Blvd.
Ann Arbor, MI 48103

CP/M-86 and MS-DOS are both similar to CP/M-80. Anyone with experience using CP/M-80 should have little trouble becoming proficient in either environment. With the exception of the specific names for various system utilities, and the order in which their parameters are passed, both CP/M-86 and MS-DOS have the same "feel" as CP/M-80. Of course, CP/M-86 bears a much stronger resemblance to its predecessor, having many features that are virtually identical to those of CP/M-80, such as the line-oriented text editor ED.

Perhaps this is also one of the strongest criticisms one can find with either CP/M-86 or MS-DOS: they are both too similar to CP/M-80. Much time has elapsed in which some of the shortcomings of CP/M-80 should have been resolved. Some highly desirable features for a single-user operating system are conspicuously absent from

either of the 8086/88 packages, including the ability to set up a default drive on which to find an invoked-command (.COM, .CMD) file, a fully functional SUBMIT utility that would support conditionals, and enhanced I/O capabilities.

The degree to which an operating system supports the variety of hardware under which it runs is a good measure of its usefulness to the programmer, and thus to the end user of the software so developed. No matter how user-friendly an operating system may be, it is next to useless if the programmer has to go to inordinate lengths in order to take advantage of the particular features the hardware has to offer. However, an operating system loaded with convenience features and utilities may also run very slowly; conversely, an operating system that is compact and fast may offer the programmer next to nothing

in the way of system utilities and the ability to create sophisticated yet portable programs.

MS-DOS Memory Management

The IBM Personal Computer is capable of supporting more than 64K bytes of memory in a fully expanded hardware configuration. However, MS-DOS as supplied with the Personal Computer cannot directly support (through software system calls or an allocation table) the full memory complement inherent in the 8088. One wants to know both the exact hardware memory configuration and the current status of the memory available to an operating system. No dynamic-memory management is in MS-DOS beyond setting location 6 to the number of paragraphs available and being able to specify that an "EXE" file loads either at the top or the bottom of avail-

Continued on page 344

"Only VR Data can offer you a Winchester Hard Disk Drive for your IBM Personal Computer..."



...with the same level of excellence and state-of-the-art technology you'd expect from IBM."

Warren Rosenkranz, President, VR Data

We are tremendously impressed with the IBM Personal Computer. When we set out to increase its capability with our exclusive,

totally compatible Winchester Hard Disk Drive and Memory Board, we dedicated ourselves to making the very finest products possible. Some very knowledgeable dealers and users say we've totally succeeded. See for yourself!!

OTHER QUALITY PRODUCTS FROM VR DATA

Winchester Hard Disks

6.3 Megabytes
9.6 Megabytes
19.0 Megabytes

2x 6.3 Megabytes
2x 9.6 Megabytes
2x 19.0 Megabytes

Memory Boards with Error Correction

64 Kbytes 192 Kbytes
128 Kbytes

In The Queue

D-Con Direct connect internal modem
The Echo
Winchester Backup

As with our Winchester Hard Disk Drive, all our designs are tested, re-tested and "burned in." We're so sure of our quality control that we offer an unconditional 120 day extended warranty covering full costs of parts and labor on all VR Data products.

Insist on the best.
Ask for us by name.

777 Henderson Boulevard N-6 Folcroft, PA 19032 800-345-8102

MICROCOMPUTER EXCELLENCE SINCE 1972

able memory. The MS-DOS BIOS does maintain a memory-available location that is apparently used by COMMAND.COM to set up the initial program segment. However, this does not necessarily help determine if a region of memory is available for some specific function or reserved for some other function. An "EXE" format is provided that allows the loading of complex modules, through the use of a program header; however, these are not fully dynamic. Exactly how one is supposed to utilize all available memory is not made clear in the MS-DOS documentation. We are still studying the possibilities. More fully supported memory-management facilities are clearly desirable.

CP/M-86 Memory Management

CP/M-86 supports an alterable, possibly noncontiguous, memory-available map in its BIOS in the form of the CP/M-86 System Memory Segment Table. CP/M-86 also maintains a memory allocation table so that a complex memory status is always available. CP/M-86 command files are preceded by a command file header that contains information that both the operating system and programs written under CP/M-86 can use to deter-

mine the minimum and maximum memory requirements for the command file to be executed, as well as other relevant memory use information. Under CP/M-86, programs can be loaded from disk and left intact and inviolable in system RAM, safe from interference from other programs that may also be resident in memory. The result of these features is to enable the system designer to use memory in a very sophisticated but well-supported way.

The Missing Assembler

CP/M-86 is supplied with an 8086 assembler, while MS-DOS provides only a linker. The assembler provided with CP/M-86 has no macro capabilities, however, and although very useful for program development, it could probably be streamlined for faster and more efficient operation.

Input/Output Support and Online Help

CP/M-86 supports both serial and parallel printer support, featuring the CP/M IOBYTE that facilitates software control of system I/O. Unfortunately, MS-DOS supports a parallel printer port only, without the benefit of software-selectable I/O. MS-DOS

could also benefit from a more efficient disk format and a BIOS implementation that could better handle the hardware features of the IBM Personal Computer. Also, CP/M-86 supports an online "HELP" command that provides a concise explanation of the CP/M-86 feature in question, as well as an example of its use. This is a particularly useful feature for those getting started with CP/M-86.

Speed and Documentation

MS-DOS is, however, faster than CP/M-86 in its available system calls, and the documentation supplied is unsurpassed for those starting out with an IBM Personal Computer. There will eventually arise more supported methods for utilizing whatever memory is available, whether from an extension of the current DOS or from third-party efforts. One hopes that improvements will be somewhat CP/M-86-compatible.

We hope we have raised some valid points about these two operating systems. We will continue to support both and hope that both will improve greatly as the products mature.

[The authors collaborated on Computerview's fast and impressive CP/M-86 for the IBM Personal Computer.]

ORDER: 1-800-547-2492

IN OREGON CALL

FOR TECHNICAL ASSISTANCE
(503) 479-4711 or (503) 479-4150

ATARI 400 (16K) \$325
800 (16K) \$675

EPSON w/GRAFTRAX I.D.S.
MX-80 \$439 560G Printer \$999
MX-80FT \$539 Prism 80 w/color \$1249
MX-100 \$699 Prism 132 w/color \$1549

RANA DRIVES VIC \$245
Controller - 4 Drives - \$119
Elite 1 \$379
TRS- 80
(CALL FOR PRICES)

TERMS: SHIPPING: Add 3% of total transaction for UPS brown (ground) or 5% for UPS blue (air), Parcel Post, or any special arrangements.
PAYMENT: Cashier's checks, certified checks, money orders, and bank wires honored immediately. Wire transfer funds to U.S. National Bank of Oregon, South Grants Pass Branch. Credit RCE, account number 501-981, Add 3% for Visa and Master Charge. Allow 20 days for personal checks to clear.
REFUNDS: 10% restocking charge on all returns or exchanges. No refunds on opened software. Call first.
GUARANTEE: All products with full manufacturer's warranty. Sanyo and Apple warranty available. We have full repair and service facilities for all electronic repairs with HP, Dynascan, Pioneer, Sanyo and Apple trained and certified technicians. For any technical service call them for instant advice or questions right on their benches at (503) 479-4150.
REPAIRS: Out of warranty guarantee: Labor 30 days from date of your receipt, 90 days on parts. Call for details on quality guaranteed discount repair and reconditioning service.
We have been repairing electronic equipment for 12 years and love it!

SPECIAL ON APPLE REPAIRS - ALL PRICES PLUS PARTS
APPLE II \$50 DRIVES \$40 PRINTERS \$100
APPLE III \$100 SILENTYPE \$50 PERIPHERAL CARDS \$45

"A Unique Combination of Quality Products, Competitive Prices, and Service"

APPLE HARDWARE

MICRO SCI DISK DRIVES (DIRECT APPLE REPLACEMENT)
A-2 DISK DRIVE \$479
A-70 \$489
A-40 \$369
CONTROLLER - 3.3 & 3.2 \$79
CCS 7710A SERIAL INT \$129
CCS 7710D SERIAL INT \$129
VIDEX 80 COLUMN \$239
VIDEX ENHANCER II \$119
LOWER CASE ADAPTOR \$39
16K RAM CARD \$149
MICROSOFT OR MPC \$139
ALS \$99
MICROTEK BAM-1 \$275
Z-80 CARD (MICROSOFT) \$269
MICROMODEM (HAYES) \$209
SMART MODEM (HAYES) \$309
NOVATION MODEMS
APPLE CAT \$209
AUTO CAT \$139
CAT \$149
D CAT \$239
MOUNTAIN CLOCK \$309
MOUNTAIN MUSIC SYSTEM \$269
MOUNTAIN A/D CONVERTER \$169
MOUNTAIN INTROL/X-10 CARD \$149
MOUNTAIN C.P.S. \$139
KBD 23 KEYPAD \$299
SUP-R-TERM (80 COLUMN) \$24
SUP-R-MOD R.F. MODULATOR \$45
JOYSTICK (I.G.) \$145
9" B&W MONITOR (SANYO) \$189
12" B&W MONITOR (SANYO) \$229
12" GREEN MONITOR (ZENITH) \$119
12" GREEN MONITOR (BMC) \$114
13" COLOR MONITOR (SANYO) \$385
EPSON CABLE & INTERFACE \$79
EPSON GRAFTRAX \$70
POWERLINE PROTECTOR \$39

ATARI HARDWARE

410 PROGRAM RECORDER \$75
810 DISK DRIVE \$429
820 PRINTER \$249
822 PRINTER \$339
825 PRINTER \$579
830 MODEM \$149
850 INTERFACE MODULE \$165
853 16K MEMORY EXPANSION \$79
MPC 32K \$149

SOFTWARE

VISICALC (ATARI) \$159
BASIC (ATARI) \$49
VISICALC \$179
VISIDEX \$179
VISIPILOT \$145
VISITERM \$75
VISTREND/PLOT \$214
VISIPAC \$499
DESK TOP PLAN #2 \$179
DESK TOP PLAN #3 \$214
MICROLAB DATA FACTORY \$129
D B MASTER (STONEWARE) \$179
SUP-R-TEXT II \$109
WORDSTAR \$349
B.P.I. SOFTWARE (each) \$319
STOCKFILE INVENTORY \$269
ZORK \$35
SARGON CHESS \$29
GALAXIAN \$22
VERBATIM DISKS \$29
MAXELL DISKS \$32
THE SOURCE \$85

MINIMUM ORDER-\$100.00

MINIMUM SHIPPING CHARGES-\$4.00

PRICES SUBJECT TO CHANGE WITHOUT NOTICE
WRITE FOR CATALOG



RALSTON-CLEARWATERS ELECTRONICS

530 N.E. 'E' Street • Grants Pass, Ore. 97526
ALL BRAND NAMES ARE REGISTERED TRADE MARKS

The card IBM is afraid you'll buy

New 88 CARD™ turns your Apple into a 16 Bit Personal Computer

If you own or are about to buy an Apple II computer, you can also enjoy the latest in 16 bit software packages. The 88 CARD converts your Apple II into a 16 bit Personal Computer with the same operating system used in the IBM PC. Plus, the 88 CARD adds 64K bytes of memory to your system. This means that you can run larger application programs (MBASIC on the 88 CARD has over 62K bytes of free RAM area). Enjoy the best of both worlds. Run your existing Apple software and emulate the IBM Personal Computer with 16 bit software — all in one system with the new 88 CARD. The system includes one 88 CARD, the CP/M-86™ operating system, and documentation.



**INTRODUCTORY
OFFER \$899
Now Only**

- Please Rush ____ 88 CARDS to me at \$899 each during your introductory offer. (Ca. residents add 6½% Sales Tax.) Enclosed is my check for _____. Four week delivery.
- Please send more information.

Name: _____

Address: _____

Phone: () _____

Local Computer Dealer: _____

Dealer Inquires Welcome.

COPROCESSORS INC.

50 WEST BROKAW ROAD, SUITE 64
SAN JOSE, CA 95110
408 947-4616

88 CARD is a trademark of **COPROCESSORS INC.**
CP/M-86 is a trademark of Digital Research.

Circle 115 on inquiry card.

ATARI HOME COMPUTERS



ATARI 800
16K ... \$669
32K ... \$749
48K ... \$779



ATARI 400
16K ... \$299
32K ... \$389
48K ... \$489

410 Recorder	\$76.00
810 Disc Drive	\$449.00
822 Printer	\$269.00
825 Printer	\$629.00
830 Modem	\$159.00
820 Printer	\$269.00
850 Interface	\$169.00
New DOS 2 System	\$29.00
CX30 Paddle	\$18.00
CX40 Joy Stick	\$18.00
CX853 16K RAM	\$77.95
Microtek 16K RAM	\$64.95
Microtek 32K RAM	\$99.95
Ramdisk (128K)	\$429.95
Intec 48K Board	\$199.95
Intec 32K	\$99.95

All RAM prices good through July 1982 only	
One year extended warranty	\$70.00
481 Entertainer	\$69.00
482 Educator	\$130.00
483 Programmer	\$49.00
484 Communicator	\$344.00

ATARI HOME COMPUTER PROGRAMS

HOME OFFICE	
CX404 ATARI Word Processor	\$119.00
CX8102 Calculator	\$29.00
CX412 Dow Jones Investment Evaluator	\$99.00
CX4109 Graph It, Joystick optional	\$17.00
CX4104 Mailing List	\$20.00
CX4115 Mortgage & Loan Analysis	\$13.00
CX4103 Statistics 1	\$20.00
CX8107 Stock Analysis	\$20.00
CXL4015 TeletLink 1	\$23.00
HOME STUDY	
CX4101 An Invitation to Programming 1	\$20.00
CX4106 An Invitation to Programming 2	\$23.00
CX4117 An Invitation to Programming 3	\$23.00
CX4107 Biorhythm	\$13.00
Conversational Languages (ea)	\$46.00
CX4121 Energy Czar	\$13.00
CX4114 European Countries & Capitals	\$13.00
CX4108 Hangman, Joystick optional	\$13.00
CX4102 Kingdom	\$13.00
CXL4007 Music Composer	\$34.00
CX4123 Scram, uses joystick	\$20.00
CX4112 States & Capitals	\$13.00
CX4110 Touch Typing	\$20.00
HOME ENTERTAINMENT	
PAC MAN	\$35.00
CENTIPEDE	\$35.00
CAVERNS OF MARS	\$32.00
CXL4013 Asteroids	\$29.00
CXL4004 Basketball	\$27.00
CX4105 Blackjack	\$13.00
CXL4009 Computer Chess	\$29.00
CXL4012 Missile Command	\$29.00
CXL4008 Space Invaders	\$29.00
CXL4011 Star Raiders	\$39.00
CXL4006 Super Breakout	\$29.00
CXL4010 3-D Tic-Tac-Toe	\$27.00
CXL4005 Video Easel	\$24.00
PROGRAMMING LANGUAGES AND AIDS	
CXL4003 Assembler Editor	\$47.00
CXL4002 ATARI BASIC	\$47.00
CX8126 ATARI Microsoft BASIC	\$70.00
CXL4018 PILOT	\$72.00
CX405 PILOT (Educational)	\$105.00

ATARI PROGRAM EXCHANGE

Eastern Front '41	\$25.50
Avalanche	\$15.50
Outlaw	\$15.50
747 Landing Simulation	\$15.50
Babel	\$15.50
Dog Daze	\$15.50
Downhill	\$15.50
Attack!	\$15.50
Blackjack-Casino	\$15.50
Reversi II	\$15.50
Domination	\$15.50
Solitaire	\$15.50
Disk Fixer	\$15.50
Supersort	\$15.50
Data Management	\$15.50
Chameleon	\$15.50
Instedit	\$15.50
Insomnia	\$15.50
My First Alphabet	\$25.50
Mapware	\$18.00
Number Blast	\$11.50
Family Cash Flow	\$15.50
Weekly Planner	\$15.50
Bowler's Data Base	\$13.00
Banner Generator	\$11.50
Crystal Software	
Bermuda Fantasy	\$26.00
Beneath Pyramids	\$20.00
Galactic Quest	\$26.00
House of Usher	\$20.00
Forgotten Island	\$26.00
Haunted Palace	\$33.00
Compumax (Acct. Rec., Gen. Ledger, Inventory, Payroll, ea)	\$110.00
Synopsis	
File Manager 800	\$69.95
Dodge Racer	\$19.00
Chicken	\$24.00
Slime	\$24.00
Nautilus	\$24.00
Disk Manager	\$24.00
Fort Apocalypse	\$24.00
Assembler	\$39.00
Protector	\$24.00
EXPY (Automated Simulation)	
Ricochet	\$14.50
Crush Crumble & Chomp	\$24.00
Star Warrior	\$29.00
Rescue at Rigel	\$24.00
Datestones	\$16.00
Invasion Orion	\$18.50
Mission Asteroid	\$22.00
OnLine	
Jaw Breaker	\$27.00
MouskATTACK	\$31.00
The Next Step	\$34.00
Softporn	\$27.00
Wizzard & Princess	\$29.00
Arcade Plus	
Ghost Hunter (cassette)	\$24.00
Ghost Hunter (disk)	\$30.00
K-Byte	
K-BYTE Crazy Shoot Out (ROM)	\$39.00
K-DOS	\$69.00
Visicalc	\$179.00
Letterperfect (Word Processor)	\$109.00
Data Soft Textwizzard	\$89.00

Texas Instruments



TI-99/4A \$299

PHA2100 R F Modulator	\$29.00
PHP 1600 Telephone Coupler	\$179.00
PHP 1200 Peripheral Expansion Box	\$199.00
PHP 1220 RS 232 Card	\$143.00
PHP 1240 Disk Controller	\$199.00
PHP 1250 Disk Drive	\$319.00
PHP 1100 Wired Remote Controllers (Pair)	\$31.00
PHP 1260 32K RAM	\$229.00
PHP Printer Solid State	\$319.00
PHM 3006 Home Financial Decisions	\$26.00
PHM 3013 Personal Record Keeping	\$43.00
PHD 5001 Mailing List	\$60.00
PHD 5021 Checkbook Manager	\$18.00
PHM 3008 Video Chess	\$60.00
PHM 3010 Physical Fitness	\$26.00
PHM 3009 Football	\$26.00
PHM 3018 Video Games I	\$26.00
PHM 3024 Indoor Soccer	\$26.00
PHM 3025 Mind Challengers	\$22.00
PHM 3031 The Attack	\$35.00
PHM 3032 Blast	\$22.00
PHM 3033 Blackjack and Poker	\$22.00
PHM 3034 Hustle	\$22.00
PHM 3036 Zero Zap	\$18.00
PHM 3037 Hangman	\$18.00
PHM 3038 Connect Four	\$18.00
PHM 3039 Yahtzee	\$22.00
Tombstone City 21st Century	\$34.00
Munch Man	\$34.00
T I INVADERS	\$34.00
CAR WARS	\$34.00

Printers

Smith Carona TP1	\$699.00
Centronics 739-1	\$519.00
Centronics 739-3	\$619.00
Diablo 630 Special	\$1799.00
Epson	
MX80 w/Graftrax	\$449.00
MX80FT	Call
MX100	Call
NEC	
8023	\$549.00
7730	Call
7720	Call
7710	Call
Okidata	
82A	\$499.00
83A	\$749.00
84	\$1129.00
Citoh Starwriter	
F10-40 CPS	\$1469.00
F10-55 CPS	Call
Prowriter	\$479.00
Talley	
8024-L	\$1629.00
IDS	
Prism	\$Call
MPC Apple Parallel Board & Cable	\$69.00
2 Meter RS232-RS232	\$29.95

Cables Available For Most Interfacing Purposes

Computer Covers

ATTRACTIVE DUST COVERS FOR YOUR COMPUTER AND DISK DRIVE

Atari 400	\$6.99	Commodore VIC-20	\$6.99
Atari 800	\$6.99	Commodore 8032	\$14.99
Atari 810	\$6.99	Commodore 8050/4040	\$10.99
All Atari Covers are Beige		All Commodore covers are Royal Blue	

Most software for Atari 400/800 available on cassette or disk.

computer mail order west

CALL TOLL FREE **800-648-3311**

Franco
 Habla
 Espanol

IN NEVADA, CALL (702) 588-5654
 P.O. BOX 6689, STATE LINE, NEVADA 89449

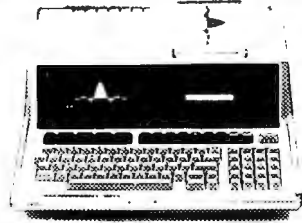

HP-85 \$1899

HP-86	call
HP-87	\$1769.00
HP-125	\$1999.00
HP-85 16K Memory Module	\$169.00
5 1/4" Dual Master Disc Drive	\$1769.00
Hard Disk w/Floppy	\$4349.00
Hard Disk	\$3440.00
"Sweet Lips" Plotter	\$1149.00
80 Column Printer	\$799.00
87 CP/M	\$399.00
87 128K Memory	\$610.00
87 Visicalc	\$205.00
HP-41CV Calculator	\$239.00
41C	\$189.00
11C	\$104.00
12C	\$114.00
34C	\$114.00
38C	\$114.00
HP-41 Printer	\$340.00
HPIL CALCULATOR PERIPHERALS	
IL Modul	\$104.00
Digital Cassette	\$449.00
Printer/Plotter	\$419.00
Card Reader	\$164.00
Optical Wand	\$99.00

NEC

8001-A	\$749.00
8031	\$749.00
8012	\$549.00
Accounts Receivable	\$295.00
Word Processing	\$395.00
General Accounting	\$295.00
Inventory Control	\$295.00
Job Cost	\$295.00

Disks

Maxell	
MD I (box of 10)	\$36.00
MD II (box of 10)	\$46.00
MFD I (8)	\$44.00
MFD II (8 Double Density)	\$54.00
Syncom (box of 10)	\$29.00

Apple

Call for availability and prices on all Apple computers and peripherals

Televideo

910	\$579.00
912C	\$699.00
920C	\$749.00
925C	\$749.00
950	\$939.00
Call for computers	
802	call
802H	call
816	call
806	call



BUSINESS MACHINES

SOFTWARE

Word Pro 5 Plus	\$319.00
Word Pro 4 Plus	\$299.00
Word Pro 3 Plus	\$199.00
Commodore Tax Package	\$589.00
Visicalc	\$179.00
Medical Billing	\$449.00
The Source	\$89.00
OZZ Information System	\$289.00
Dow Jones Portfolio	\$129.00
Pascal	\$239.00
Legal Time Accounting	\$449.00
Word Craft 80	\$289.00
Power	\$79.00
Socket 2-Me	\$20.00
Jinsam	\$Call
MAGIS	\$Call
CPA	\$Call
Real Estate Package	\$Call
The Manager	\$209.00
Softrom	\$129.00
BPI Inventory Control	\$319.00
BPI Job Costing	\$319.00
BPI Payroll	\$319.00
BPI General Ledger	\$329.00
Creative I SAM	\$79.00
Creative General Ledger	\$229.00
Creative Accounts Receivable	\$229.00
Creative Inventory	\$229.00

VIC 20 \$239

COMPLETE
CALL FOR AVAILABILITY AND PRICE
FOR NEW VIC-64

VIC 6 Pack Program	\$44.00
VIC 1530 Commodore Datasette	\$69.00
VIC 1540 Disk Drive	\$499.00
VIC 1515 VIC Graphic Printer	\$339.00
VIC 1210 3K Memory Expander	\$32.00
VIC 110 8K Memory Expander	\$53.00
16K VIC Expansion	\$99.00
VIC 1011 RS232C Terminal Interface	\$43.00
VIC 1112 VIC IEEE 488 Interface	\$86.00
VIC 1211 VIC 20 Super Expander	\$53.00
VT 232 ViCTerm I Terminal Emulator	\$9.00
VIC 1212 Programmers Aid Cartridge	\$45.00
VIC 1213 VICMON Machine Language Monitor	\$45.00
VIC 1901 VIC AVENGERS	\$23.00
VIC 1904 SUPERSLOT	\$23.00
VIC 1906 SUPER ALIEN	\$23.00
VIC 1907 SUPER LANDER	\$23.00
VIC 1908 DRAW POKER	\$23.00
VIC 1909 MIDNIGHT DRIVE	\$23.00



CBM 8032 \$1039

4032	\$969.00
4016	\$769.00
8096 Upgrade Kit	\$369.00
Super Pet	\$1599.00
2031	\$529.00
8250 Doubled Sided Disk Drive	\$1699.00
5 Megabyte Hard Disk	\$2399.00
8050	\$1299.00
4040	\$969.00
8300 (Letter Quality)	\$1799.00
8023	\$769.00
4022	\$599.00
Pet to IEEE Cable	\$37.00
IEEE to IEEE Cable	\$46.00
Tractor Feed for 8300	\$240.00

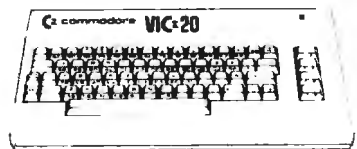

Terminal	\$13.00
Un Word	\$13.00
Grafix Menagerie	\$11.00
VIC PICS	\$15.00
Ticker Tape	\$13.00
Banner Headliner	\$13.00
RS 232	\$39.00
VT 106A Recreat on Pack A	\$44.00
VT 107A Home Calculation Pack A	\$44.00
VT 164 Programmable Character/Gamegraphics	\$12.00
Household Finance	\$27.00
VIC Games	\$19.00
VIC Home Inventory	\$13.00
VIC Rec/Ed II	\$13.00
VL 101 Introduction to Computing	\$19.00
VL 102 Introduction to BASIC Programming	\$19.00
VM110 VIC 20 Programmers Reference Guide	\$15.00

In-stock items shipped same day you call. No risk, no deposit on C.O.D. orders. Pre-paid orders receive free shipping within the continental United States with no waiting period for certified checks or money orders. All prices shown are cash prices. Add 3% for Mastercard and Visa. NV and PA residents add sales tax. All items subject to availability and price change.

Monitors

BMC 12" Green	\$85.00
Amdek	
300G	\$169
Color I	\$339
Color II	\$699
Color III	\$429
Ti 10 Color	\$349.00
Zenith 9 inch (Green)	\$119.00

Modems

Hayes	
Smart	\$239.00
Chronograph	\$199.00
Micromodem II	\$279.00
Micromodem 100	\$309.00
Novation Auto	\$239.00
D Cat	\$169.00
Cat	\$159.00

Nev & Pa. residents add sales tax.

computer mail order east

CALL TOLL FREE **800-233-8950**

INTERNATIONAL CALLS AND IN PA CALL (717) 327-9575
477 E. THIRD ST., WILLIAMSPORT, PA 17701

Patricio
Habla
Español!

Text continued from page 342:

decimal, indicating failure. MS-DOS returns a 0 to indicate success and OFF hexadecimal to indicate failure. In addition, MS-DOS will update the disk designator in the FCB (File Control Block) if the default disk is requested. This allows changing the default disk after the FCB is opened without getting into trouble.

Function 16—Close File: CP/M-80 and CP/M-86 both return a directory code for successful completion (0, 1, 2, or 3) and OFF hexadecimal for failure. MS-DOS returns a 0 for success and OFF hexadecimal for failure.

Function 17—Search For First: CP/M-80 and CP/M-86 return 0, 1, 2, or 3 in the A or AL register to indicate the file is present, or OFF hexadecimal to indicate failure. MS-DOS returns 0 to indicate success or OFF hexadecimal to indicate failure, as noted in function 15.

Function 18—Search For Next: Same comments as for function 16.

Function 19—Delete File: CP/M-80 returns a directory code (0, 1, 2, 3 for success, or OFF hexadecimal for fail-

ure). CP/M-86 and MS-DOS both return a 0 if the operation is successful or OFF hexadecimal if unsuccessful.

Function 20—Read Sequential: All three systems treat this function the same way.

Function 21—Write Sequential: All three systems treat this function the same way.

Function 22—Make File: CP/M-80 and CP/M-86 both return a directory code of 0, 1, 2, or 3 if successful and OFF hexadecimal if unsuccessful. MS-DOS returns a 0 if successful and OFF hexadecimal if unsuccessful.

Function 23—Rename File: All three systems treat this function the same way.

Function 24—Return Login Vector: CP/M-80 and CP/M-86 treat this the same way, but MS-DOS does not use this function at all.

Function 25—Return Current Disk: All three systems treat this function the same way.

Function 26—Set DMA Address: CP/M-80 and CP/M-86 treat this in

the same manner. CP/M-86 has an additional system call to set the DMA segment base. MS-DOS includes the segment in this function by using the DS segment register.

Function 27—Get Address of Allocation Vector: CP/M-86 returns the allocation vector offset in the BX register, as you would expect for compatibility with CP/M-80. But CP/M-86 also returns the segment base of the vector in the ES segment register. MS-DOS returns the same segment information in the DS segment register. In addition, it returns the number of allocation units in the DX register, the number of records per allocation unit in the AL register, and the size of the physical sector in the CX register. Note that the MS-DOS allocation vector is in a format different from that used in CP/M-80 and CP/M-86.

Function 28—Write Protect Disk: CP/M-80 and CP/M-86 treat this function the same way. MS-DOS does not use it at all.

Function 29—Get Read/Only Vector: Same comment as for function 28.

Function 30—Set File Attributes: Same comment as for function 28.

Function 31—Get Address of Disk Parameters: CP/M-86 returns the offset of the BIOS-resident DPB (disk parameter block) offset of the currently selected drive in the BX register, as expected, and the segment base of the BIOS-resident DPB in the ES segment register. MS-DOS does not use this function at all.

Function 32—Set/Get User Code: CP/M-80 and CP/M-86 both treat this the same way. MS-DOS does not support this function at all.

Function 33—Read Random: All three systems return the same code for success, 0. MS-DOS has different failure codes from CP/M-80 and CP/M-86.

Function 34—Write Random: Same comment as for function 33.

Function 35—Compute File Size in Records: CP/M-80 and CP/M-86 have no error-return codes, while MS-DOS returns 0 for success and OFF hexadecimal for failure.

Function 36—Set Random Record: Same comment as for function 35.

START YOUR OWN COMPUTER CO.

HOW TO START YOUR OWN SYSTEMS HOUSE

\$36.

7th edition, November 1981

Written by the founder of a successful systems house, this fact-filled 220-page manual covers virtually all aspects of starting and operating a small systems company. It is abundant with useful, real-life samples: contracts, proposals, agreements and a complete business plan are included in full, and may be used immediately by the reader. Proven, field-tested solutions to the many problems facing small turnkey vendors are presented.

HOW TO BECOME A SUCCESSFUL COMPUTER CONSULTANT

\$28.

by Leslie Nelson, 4th revised edition, December 1981

Independent consultants are becoming a vitally important factor in the micro-computer field, filling the gap between the computer vendors and commercial/industrial users. The rewards of the consultant can be high: freedom, more satisfying work and doubled or tripled income. This manual provides comprehensive background information and step-by-step directions for those interested to explore this lucrative field.

FREE-LANCE SOFTWARE MARKETING

\$30.

by B.J. Korites, 3rd edition, June 1980

Writing and selling computer programs as an independent is a business where • you can get started quickly, with little capital investment • you can do it full time or part time • the potential profits are almost limitless. This best-seller by Dr. Korites explains how to do it.

HOW TO START YOUR OWN WORD PROCESSING SERVICE

\$39.50

by Leslie Nelson, May 1982

Turn a small investment into a steady, money making business that adds \$10,000, \$50,000 or \$100,000 to your income. Detailed start-up, marketing and operations plans are included.

Send check, money order, VISA, Master Charge or American Express # and exp. date. Publisher pays 4th class shipping. Add \$1.00 per book for UPS shipping (USA only). NJ residents add 5% sales tax. For faster shipment on credit card orders call (201) 783-6940.

ESSEX PUBLISHING CO. Dept. 2
285 Bloomfield Avenue • Caldwell, N.J. 07006

Computer Products from ASAP

Components

4116's (200 nS)/5290-3

Apple, TRS-80, Heath
1-15 \$1.70 each 50-99 \$1.50 each
16-49 \$1.60 each 100 up \$1.30 each

2114 L-2/200 nS

Low-Power 1K x 4 Static RAM
1-16 \$2.80 each
17-49 \$2.70 each
50-99 \$2.60 each
100 up \$2.45 each

2708/450 nS

1K x 8 EPROM \$4.00 each or 8/\$28.00

2716/5 Volt

2K x 8 EPROM \$4.95 each

DISKETTES from ASAP

Part #	Verbatim 5 1/4" Diskettes	Sector	Price
MD525-01	Soft	10/527.50	
MD525-10	Hard 10	10/527.50	
MD525-16	Hard 16	10/527.50	
FD32-1000	8" Diskettes Hard	10/\$35.00	
FD34-1000	Soft	10/\$35.00	

Part #	Memorex 5 1/4" Diskettes	Side/Dens	Sector	Price
MEM 3481	1/Dbl	Soft	10/\$26.50	
MEM 3483	1/Dbl	Hard 10	10/\$26.50	
MEM 3485	1/Dbl	Hard 16	10/\$26.50	
MEM 3060	8" Diskettes 1/Sgl	Soft	10/\$35.00	
MEM 3101	2/Sgl	Soft	10/\$45.00	
MEM 3090	1/Dbl	Soft	10/\$45.00	
MEM 3102	2/Dbl	Soft	10/\$55.00	

Part #	Scotch 3M 5 1/4" Diskettes	Side/Dens	Sector	Price
744-0	1/Sgl	Soft	10/\$33.00	
744-10	1/Sgl	Hard 10	10/\$33.00	
744-16	1/Sgl	Hard 16	10/\$33.00	
745-0	2/Dbl	Soft	10/\$45.00	
745-10	2/Dbl	Hard 10	10/\$45.00	
745-16	2/Dbl	Hard 16	10/\$45.00	

Part #	Maxell 5 1/4" Diskettes	Side/Dens	Sector	Price
MD1	1/Sgl	Soft	10/\$32.00	
MD2D	2/Dbl	Soft	10/\$44.00	
MH1	1/Sgl	Hard 16	10/\$39.00	
MH2D	2/Dbl	Hard 16	10/\$50.00	
FD1-128	8" Diskettes 1/Sgl	Soft	10/\$41.00	
FD1-32	1/Sgl	Soft 32	10/\$41.00	
FD2-XD	2/Dbl	Soft	10/\$50.00	

Elephant Memory Systems

Part #	Side/Dens	Sector	Price
EMS 1	1/Sgl	Soft	10/\$25.00
EMS 2	1/Dbl	Soft	10/\$27.50
EMS 3	1/Dbl	Hard 10	10/\$27.50
EMS 4	1/Dbl	Hard 16	10/\$27.50
EMS 5	2/Dbl	Soft	10/\$33.00
EMS 6	2/Dbl	Hard 10	10/\$33.00
EMS 7	2/Dbl	Hard 16	10/\$33.00

Control Data

Part #	5 1/4" Diskettes	Side/Dens	Sector	Price
1241-00	1/Sgl	Soft	10/\$25.00	
1241-10	1/Sgl	Hard 10	10/\$25.00	
1241-16	1/Sgl	Hard 16	10/\$25.00	
1242-00	1/Dbl	Soft	10/\$30.00	
1242-10	1/Dbl	Hard 10	10/\$30.00	
1242-16	1/Dbl	Hard 16	10/\$30.00	
1244-00	2/Dbl	Soft	10/\$40.00	
1244-10	2/Dbl	Hard 10	10/\$40.00	
1244-16	2/Dbl	Hard 16	10/\$40.00	

Part #	8" Diskettes	Side/Dens	Sector	Price
1221-60	1/Sgl	Soft	10/\$38.00	
1223-00	1/Dbl	Soft	10/\$43.00	
1225-00	2/Dbl	Soft	10/\$48.00	

FLEXCASE Disk Storage Call for price

SRW Media Storage Cases

Part #	Size	Price
SRW-5	5 1/4"	\$2.50 ea
SRW-8	8"	\$3.25 ea

Connectors

	1-9	10-24	25 up
DB25P	\$2.00	\$1.90	\$1.75
DB25S	\$2.95	\$2.75	\$2.50
DB25C	\$.95	\$.85	\$.75

ATARI COMPUTER PRODUCTS

ATARI 800

(16K) Personal Business Computer Features:

- Computer console
 - Atari 8K basic
 - 57 full stroke alpha-numeric keyboard with four function keys
 - Operator's manual
 - RF modulator
 - Power supply
- Call for price

ATARI 400 \$349.00

Software

Description	Price
Atari	
Basketball	\$ 27.00
Super Breakout	\$ 30.00
Chess	\$ 32.00
Video Easel	\$ 25.00
Star Raiders	\$ 36.00
Asteroids	\$ 32.00
Music Composer	\$ 42.00
Assembler/Editor	\$ 45.00
Teletink I	\$ 24.00
Space Invaders	\$ 30.00
Missile Command	\$ 32.00
Graph It	\$ 17.95
Mailing List	\$ 19.95
Touch Typing	\$ 19.95
Stock Charting	\$ 22.95
Stock Analysis	\$ 19.95
Bond Analysis	\$ 22.95
Word Processor	\$119.00
Personal Finance	\$ 64.95
Microsoft BASIC	\$ 75.00
Pac-Man	\$ 35.00
Centipede	\$ 35.00
Caverns of Mars	\$ 30.00

Datasoft

Atari Mailing List Disk	19.95
Atari Character Generator Disk	16.95
Text Wizard Disk	89.95
Micropainter Album 1 Disk	16.95
Micropainter Album 2 Disk	16.95
Le Stick Accessory	30.00

Innovative Design Software, Inc.

Pool 1.5 HI-RES 48K \$28.95

On-Line Systems

HI-RES Adv #0 — Mission Asteroid Disk	19.95
HI-RES Adv #2 — Wiz & Princess Disk	25.00
Roadwork Disk	29.95
Jawbreaker Disk	25.00
Softporn Adventure (X-rated) Disk	25.00
The Next Step Disk	29.95

Personal Software

Viscalc Disk 169.00

Arcade Plus

Ghost Hunter (Cassette) \$ 25.00

Ghost Hunter (Disk) \$ 30.00

FOR HOME ENTERTAINMENT SYSTEMS

Advision	
Dragster Cartridge	18.50
Boxing Cartridge	18.50
Checkers Cartridge	18.50
Fishing Derby Cartridge	18.50
Skiing Cartridge	18.50
Bridge Cartridge	23.95
Tennis Cartridge	18.50
Laser Blast Cartridge	18.50
Freeway Cartridge	18.50
Kaboom! Cartridge	18.50
Stampede Cartridge	18.50
Ice Hockey Cartridge	23.95

Atari Optional Accessories

Model #	Description	Price
410	Program Recorder	\$ 80.00
810	Disk Drive System	\$ 455.00
822	40 Column Thermal Printer	\$ 299.00
820	40 Column Dot Matrix Printer	\$ 279.00
825	80 Column Dot Matrix Printer	\$ 625.00
830	Acoustic Modem	\$ 159.00
850	Interface Module	\$ 175.00
CX30-04	Paddle Controls	\$ 17.95
CX40-04	Joysticks (pair)	\$ 17.95
A16KA	16K RAM Board	\$ 55.00

SYSTEMS WITH SPICE from CALIFORNIA COMPUTER SYSTEMS FOR S-100 USERS

32K Static RAM Board Part Number 2032C	Price: \$475.00
16K Static RAM Board Part Number 2116C	Price: \$290.00
64K Dynamic RAM Board Part Number 2065C	Price: \$375.00
280A CPU Board Part Number 2810A	Price: \$295.00
Floppy Disk Controller Part Number 2422A	Price: \$365.00
CP/M™ Version 2.2 Free With Purchase	
S-100 Mainframe Part Number 2200A	Price: \$475.00
S-100 Motherboard Part Number 2501A	Price: \$150.00
4-Port Serial I/O Interface Part Number 2710A	Price: \$295.00
2-Serial, 2-Parallel I/O Board Part Number 2719A	Price: \$325.00
4-Port Parallel I/O Board Part Number 2720A	Price: \$255.00

FOR APPLE II™ USERS

Synchronous Serial Interface Part Number 7712A	Price: \$149.00
Programmable Timer Part Number 7440A	Price: \$110.00
Asynchronous Serial Interface Part Number 7710A	Price: \$139.00
Calendar/Clock Module Part Number 7424	Price: \$110.00
3 1/2" Digit BCD A-to-D Converter Part Number 7470A	Price: \$110.00
12K ROM/PROM Module Part Number 7114A	Price: \$105.00
Parallel Interface Part Number 7720A	Price: \$115.00
Arithmetic Processor Part Number 7811A	Price: \$349.00
Centronics Printer Interface Part Number 7728A	Price: \$105.00

Printers

Anadex 9501 W/2K Buffer	\$1295.00
Diablo G3DR0	\$2095.00
Texas Instruments 810	\$1495.00

C-Itch

8510ADC Pro/Writer, serial & parallel	\$695.00
8510AP Pro/Writer, parallel	\$499.00
1550 Pro/Writer II, serial & parallel	Call
F10-40PU Printmaster, parallel	\$1495.00
F10-40RU Printmaster, serial	\$1495.00

asap
computer
products, inc.

1198 E. Willow St., Signal Hill, CA 90806

All prices subject to change without notice.

Call for best price.

ASAP offers a 15-day buyer protection policy: full money-back guarantee if not totally satisfied. Ordering information: name, address, phone, ship by UPS or Mail. Shipping charge: add \$2.90 up to 1 lb. for UPS blue; add \$1.50 for U.S. Mail (U.S. only) (\$25.00 minimum order). Call for larger shipments. Terms: We accept cash, check, money orders, Visa & Master Charge (U.S. Funds only). Tax: 6% Calif. res. COD's and terms available on approval (school PO's accepted).

Epson

MX80 80 column dot matrix Call
MX80FT 80 column friction feed Call
MX100 132 column dot matrix Call

Okidata

82A 80 column	\$460.00
83A 136 column	\$699.00
84AP 136 column parallel	\$1095.00
84AS 136 column serial	\$1225.00

Printer Interfaces & Cables

AEI-1 Apple Int to Epson/Ok	\$ 50.00
SEI-1 Serial Int to Epson	\$ 50.00
EPI-1 2K Buffer Serial (Epson)	\$109.00
OKI-1 2K Buffer Serial (Ok)	\$119.00
AEC-1 Apple to Epson/Ok Cable	\$ 16.00
AEC-2 Atari to Epson/Ok Cable	\$ 16.00
RSC-1 RS-232 (Serial)	\$ 16.00
RSC-2 (Ok) RS-232 Cable	\$ 19.95
TRSE-1 TRS-80 to Epson and Ok	\$ 19.95

Quadram IBM Boards

Memory Expansion Board	\$245.00
Dual Port Serial RS-232 Asynchronous Adapter	\$115.00
Time Clock	\$125.00
Parallel Interface Card (IPIIC)	\$125.00

Modems

Manufacturer	Model #	Price
Novation	CAT	\$ 149.00
Novation	d-CAT	\$ 160.00
Novation	Auto-Cat	\$ 229.00
DC Hayes	Smart Modem	\$ 235.00
DC Hayes	Micro Modem II (Apple)	\$ 320.00
DC Hayes	Micro Modem 100	\$ 320.00
Lexicon	Lex-11	\$ 139.00
Livermore	LIV-Star 20M	\$ 149.00
UDS	UDS 103 LP (300 Bd)	\$ 185.00
UDS	UDS 202 LP (1200 Bd)	\$ 245.00

Terminals

Manufacturer	Model #	Price
Ampex	Dialogue 80	\$ 875.00
Lear Siegler	ADM-5	\$ 660.00
Lear Siegler	ADM-3A	\$ 635.00
Lear Siegler	ADM-3A+	\$1225.00
Lear Siegler	ADM-31	\$1095.00
Lear Siegler	ADM-32	\$1225.00
Lear Siegler	ADM-42	\$1195.00
Televideo	TVI 910	\$ 625.00
Televideo	TVI 912C	\$ 725.00
Televideo	TVI 925	\$ 825.00
Televideo	TVI 950C	\$ 950.00

Monitors

Manufacturer	Model #	Price
Amdek	100/12" B&W	\$ 110.00
Amdek	100-80	\$ 169.00
Amdek	100G/12" Grn	\$ 120.00
Amdek	Color-1 13"	\$ 350.00
Sanyo	DM 5109CX/9 Grn.	\$ 175.00
Sanyo	DM 5012/12" B&W	\$ 270.00
Sanyo	DM 5112ex/12" Grn.	\$ 290.00
Sanyo	DM C6013/13" Color	\$ 450.00
Zenith	ZVM-121/12" Grn	\$ 115.00

Call Toll Free (800) 421-7701
In California (213) 595-6431 or
(714) 891-2663

In Canada Call ASAP Computer
Products LTD., 116 Viceroy Rd.,
D-12 Concord, Toronto, Ontario

Canada L4K 1A9 (416) 738-0500

(800) 268-1996



Oryx software

What does the Oryx, an African antelope, have in common with reliable service? They are both almost extinct. Oryx Software wants to bring trustworthy service back to life. We're here to stay!

GUARANTEED LOWEST PRICES!
We will match any advertised price.
Just show us the ad.

ORDER TOLL FREE - Outside WI
1-800-826-1589

SOFTWARE

APPLE	
Mailing List Program	48.
Superlex II	128.
C O R P I	235.
Estimator	295.
Magic Window	79.
Visitrend/Plot	199.
Visiterm	120.
Supercalc	269.
Locksmith 4.1	99.
Tax Preparer 82	127.
Real Estate Analyzer	153.
Creative Financing	149.
DB Master	174.
Micropro Wordstar	248.
Context Connector	180.
Easy Writer (Pro)	195.
Easy Mailer	160.
Datadex	249.
Nevada Cobol	159.
Visicalc 3.3	159.
Spellguard	239.
PFS	110.
Systems plus Acct'g Module	425.
Electronic 1. 2 3	39.
Wizardry	42.
Apple Panic	25.
Sublogic Flight Simulator	28.
Micropainter	34.
Zork II	33.
Edu-ware	35.
Raster Blast	25.
Intl Grd Prix	26.
Graphic Software	19.
Logic Simulator	135.

AND MANY MORE!

CP/M	
Word Processor I	425.
Mail Management	250.
Mailmerge	115.
Spellstar	169.
Supersort II	159.
Microplan Basic	419.
Micro Pro Wordstar	297.

AND MANY MORE!

Others for
CBM, NEC, ATARI, IBM, ETC. . .

Prices valid for stock on hand
and subject to change without notice.

Write for our **FREE** catalog.

For Peripherals
see our other ad, page 158

Please:

- Wisconsin residents - add 5% sales tax
- Add \$2.50 for shipping per software and small item. Call regarding others.

We Welcome

- Visa, Mastercard - (Add 5%)
- Checks (Allow 1-2 weeks for clearing)
- COD (Add \$1.50 per shipment)

ORDER TOLL FREE - Outside WI
1-800-826-1589

For Technical Info & in Wisconsin

715-848-2322

Oryx Software

205 Scott St., Dept. BB
P.O. Box 1961 • Wausau, WI 54401



Benchmark	CP/M-86 1.0 BASIC-86 Rev. 5.21	MS-DOS emulating CP/M-86 (EM-86) BASIC-86 Rev. 5.21
Empty do-loop	6.04	6.04
Division	22.12	22.12
Subroutine jump	11.99	11.99
MID\$ (substring)	20.94	20.94
Prime number program (only 2000 primes)	47.97	47.97
Disk write program (64K-byte file)	18.3	15
Disk read program (64K-byte file)	9.1	10.1

Table 4: Timings of benchmark programs run in Microsoft BASIC. The programs were run on a Compupro 8085/8088 machine running at 5 MHz with one wait state on input/output. In one case, BASIC was running under CP/M-86; in the other, under MS-DOS, which was itself running EM-86, a program that emulates CP/M-86. Since the first five benchmarks were computational, the BASIC was the same, and no file loading was involved, it is not surprising that there was no difference in the times. The times on the last two benchmarks, which involve disk input/output, are surprising. MS-DOS can support the emulation program and run the BASIC disk read program almost as fast as CP/M-86 can. In running the disk write program, MS-DOS emulating CP/M-86 is actually faster than CP/M-86 itself.

	CP/M-86 1.0 PIP	MS-DOS COPY	EM-86 PIP
File copy: Copy 22K-byte file	9.9	5.75	16.15

Table 5: Comparison of file-copying speed of CP/M-86, MS-DOS, and MS-DOS running EM-86. The copy utilities were run on a Compupro 8085/8088 machine running at 5 MHz with one wait state on input/output.

Benchmarks

Tables 4 and 5 show the results of some benchmarks of MS-DOS and CP/M-86 running on a Compupro 8085/8088 system at 5 MHz. The most notable result in table 4 shows that an MS-DOS system emulating CP/M-86 performed the BASIC disk write benchmark faster than CP/M-86 itself.

Summing Up the Current Version

Based on the comparisons made so far, the serious drawbacks of CP/M-86 would seem to outnumber those of MS-DOS. MS-DOS wins points for superior speed, more efficient use of disk space, and error recovery. CP/M-86 wins points for reconfigurability and online help.

From the assembly-language programmer's viewpoint, although CP/M-80, CP/M-86, and MS-DOS are quite similar, the programmer

must be alert to some significant differences.

What About the Future?

But now we come to the question of promised revisions of the two operating systems and learn that Digital Research has a strategy for redressing the balance.

Concurrent CP/M-86

The most important revision coming in CP/M-86 will mean that users can do more work with the same machine. Digital Research previewed Concurrent CP/M-86 at the West Coast Computer Faire in March. In an operating system, concurrency means that a computer can do more than one thing at a time. Under Concurrent CP/M-86, for example, you can simultaneously edit one file, run an automatic spelling checker on a second file, and print a third file. You can run one BASIC program while

Are you looking for a DATA BASE?



THE **BEST** DATA BASE SYSTEM

GBS

IS READY TO DO **YOUR** JOB

GBS™	\$300
QUICK GEN™	\$125
REPORT GEN™	\$150
MENU GEN™	\$ 75
CONVERT	\$ 60

IF YOU AREN'T A PROGRAMMER...

... our program generator, **QUICK GEN**, is ready to help you. With **QUICK GEN** almost anyone — even those unsophisticated about computers — may generate powerful business programs. In a short time, you can create a program and a data file that allows an operator, using menu choices, to selectively ...

review records **add records**
edit records **delete records**
update records **print out records**

QUICK GEN guides you through the following easy steps. When you finish, you will have created a **GBS** program and a data file.

1. Create a screen of labels and headings using a full-screen editor
2. Define data fields, including type and format
3. Position data fields on the display by moving the cursor
4. Write equations that perform calculations on the displayed data

Also of help to the non-programmer is our report generator **REPORT GEN**. With it you may create programs that can produce a wide range of customized reports. Check out these features of **REPORT GEN**:

Complete file printout
Summary printout to your specifications
One line per record, or Multiple lines per record
Print from up to three related files
Compute subtotals and totals

Finally, there is **MENU GEN**. It ties all of your programs together and permits an operator to work exclusively from menus. **QUICK GEN**, **REPORT GEN**, and **MENU GEN** all require **GBS** to operate.

IF YOU ARE A PROGRAMMER...

... you need **GBS**. It is a powerful, fully programmable, relational database management system. You can access 3 different files simultaneously, and work with as many files as you need within a single program. Use one-to-one, one-to-many, or many-to-one relationships. **GBS** allows data files to span four disk drives. Up to ten indexes may be used simultaneously with each data file, and they are automatically updated when records are added or indexed fields are changed.

GBS uses disk space well by compressing screens and program tables, and by requiring only 24K of disk space to index a data file of 5000 records. When you run applications, **GBS** need not be available on disk, thus freeing often valuable disk space and avoiding tedious overlays of program code.

When you program **GBS**, all the tools are immediately available. You may program and test without requiring an outside editor, assembler, or compiler. Thus, changes may be made and tested in seconds.

You program **GBS** by making table entries using a full screen editor. The tabular structure allows **GBS** to execute your applications and those created using the **GENerator** programs extremely rapidly.

You may construct screens with a full screen editor. Later, your programs will display these screens with a single instruction. You may use subroutines to shorten and organize your programs. The fields in a record may be referenced like an array. And for those learning to use **GBS**, there are valuable **HELPS** available on call.

START USING GBS NOW.

GBS is up and running on most popular **CP/M*** based computers, like those made by Apple, Tandy, Xerox, Sharp, NEC, Osborne, Televideo, Hewlett Packard, Vector, Toshiba, Altos, and more.

If you are now using an older, slower data base management system, you can move up to the power of **GBS** and adapt your current data files with the help of our optional utility **CONVERT**.

You can order **GBS** with confidence because **we guarantee it!** If **GBS** isn't all we say it is, and more, simply return it within 30 days for a full refund. This offer is for a limited time only, so please act immediately. Discuss these terms with your local computer store manager — he may be a participating **GBS** dealer.

Call Today

Contact us today for additional information or to take advantage of our special 30-day Money Back Guarantee.

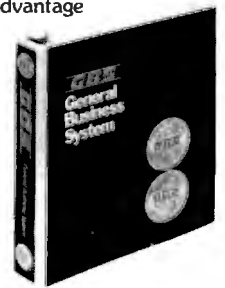

GBS — it's the best business decision you can make, for today and for the future.

QUALITY SOFTWARE

6660 Reseda Blvd., Suite 107
Reseda, CA 91335 (213) 344-6599

*CP/M is a registered trademark of Digital Research.

MS-DOS and CP/M-86: A System Manufacturer's View

Richard Lomas
President
Lomas Data Products Inc.
729 Farm Rd.
Marlborough, MA 01752

I support both MS-DOS and CP/M-86 on my 8088- and 8086-based microcomputer systems. After using both operating systems and looking for software to run under each, I would choose CP/M-86 if forced to support only one. Although MS-DOS is in many ways an equal or superior operating system, CP/M-86 offers many advantages.

In seeking languages and applications programs for the 8086/88 processor family, I have found more available for CP/M-86 than for MS-DOS. The most notable exceptions are the Microsoft languages: BASIC, BASCOM, FORTRAN, COBOL, and Pascal. For whatever reason, Microsoft has decided not to support the CP/M-86 operating system with its languages, at least not in the near future. While some sources for a CP/M-86 version of Microsoft's interpreted BASIC exist, the version is not generally available. Other software houses are supplying versions of all the languages concerned except for FORTRAN and interpreted BASIC. Furthermore, other languages are available for CP/M-86 that are not available for MS-DOS, including C, LISP, and APL. I believe that someone will provide a good FORTRAN 77 compiler for CP/M-86 shortly. I also hope that Microsoft will see the potential market for its languages under CP/M-86.

An additional plus for the Digital Research operating system is the rumor of an Intel Universal Development Interface to CP/M-86, which would allow the use of Intel's very efficient

compilers for FORTRAN, Pascal, and PL/M.

When purchasing an operating system and other software, I want to be assured that I can continue to use the same software as my needs and my system grow. With CP/M-86, I can easily move my software to an MP/M-86-based multi-user system. With MS-DOS, the upgrade path to a multi-user system is not so clear. While Microsoft describes Xenix as the upgrade path, most—if not all—software running under MS-DOS will not run under Xenix. MP/M-86 does have one major fault, lack of memory protection, but this operating system is desirable even in single-user applications, where the problem of memory protection is minimized. Now that Intel and Digital Research have announced that MP/M-86 will be available on the 80286, a processor that itself makes provisions for memory protection, it appears that MP/M-86's problem will go away.

The last deciding issue between CP/M-86 and MS-DOS is that of performance. MS-DOS does offer performance advantages in some areas, especially disk input/output. MS-DOS has internal disk buffering built into the operating system. This makes disk input/output faster, especially when using physical disk sectors larger than 128 bytes. MS-DOS's internal blocking and deblocking also simplifies writing disk drivers for the input/output system.

By allowing records of other than 128 bytes in length, MS-DOS makes writing assembly-language programs

easier. With high-level languages, the related problems are largely transparent. The Lomas Data Products system that I use provides a CP/M BIOS with a full-track buffer. The track buffering largely offsets MS-DOS's internal buffering mechanism. For example, the times listed below are for assembling the CBIOS that comes with the Lomas Data Products implementation of CP/M-86:

	Assembly Time
CP/M-86, no sector buffering, single-density	3:30
CP/M-86, track buffered, single-density	2:30
CP/M-86, track buffered, double-density	2:20

The track buffering makes CP/M-86 come close to the speed of MS-DOS. Unfortunately, I cannot offer a direct comparison between identical software running under the two operating systems.

In summary, CP/M-86 offers the advantages of the wider availability of software and the ability to upgrade to multi-user operation without losing programs that are running under the single-user system. The availability of Intel languages for CP/M-86 would be another advantage. From a performance standpoint, a BIOS that uses track buffering can make CP/M-86 run about as fast as MS-DOS, which offsets one of MS-DOS's greatest advantages.

compiling a second program, debugging a third program, and receiving electronic mail through a communications port. How do you keep track of all that's going on? Concurrent CP/M-86 constructs "virtual terminals," each of which is a window on one operation. On machines with integrated consoles (like the IBM Personal Computer), you will be able to change from one virtual terminal to

the next with a single keystroke.

Frank Hollsworth, head of the 8086-operating-system development group at Digital Research, also promises a doubling or tripling of the speed of CP/M-86. "Hashing"—transforming index keys into a shorter, more easily manipulated form—will be used to speed up file access. Speed will be increased further by moving the blocking and deblocking of data

during transfer, now controlled in CP/M-86's BIOS, to the BDOS. As things stand, the BDOS asks for an absolute track and sector number, and the BIOS has to translate that information before doing a read or write. Moving the blocking and deblocking to the BDOS will speed matters up by eliminating some calculations.

Promotional literature promises

The MICROMINT Z8 BASIC COMPUTER/CONTROLLER board represents a milestone in microcomputer price-performance. It is cheap enough to be programmed directly in a high level language, and efficient enough to be battery operated if required. The entire computer is 4" by 4½" and includes a tiny BASIC interpreter, 4K bytes of program memory, one RS-232 serial port and two parallel ports, plus a variety of other features. Using a powerful Z8 microcomputer chip and Z6132 4K X 8 RAM, the Z8 BASIC COMPUTER/CONTROLLER board is completely self-contained and optimized for use as a dedicated controller. The unit is assembled and tested and comes with over 200 pages of documentation.

The price, in single quantity, a tiny \$195.*

Optional power supply (+5, +12 and -12V) \$35.

Please include \$4 for shipping and handling.

*Call Micromint for quantity pricing

Z8 MICROCOMPUTER

- On board tiny BASIC Interpreter.
- Parallel and serial I/O ports.
- 6 interrupts.

RS-232 CONNECTOR

- Just attach a CRT terminal and immediately write control programs in BASIC.

4K BYTES OF RAM

- Z6132 4K X 8 low power quasi-static RAM. EPROM pin compatible.

SWITCH SELECTABLE BAUD RATES

- 110-9600 BPS.

FULLY EXPANDABLE

- Data and address buses available for 124K memory and I/O expansion.
- 2 onboard parallel ports.
- 7.3728MHZ crystal for fast control operations.

JUMPER SELECTABLE MEMORY OPTIONS

- 4K RAM, 2716 or 2732 EPROM operation.

LOW POWER

- Consumes only 1½ WATTS at +5, +12 and -12V (optional power supply available).

To Order:

Call Toll Free

1-800-645-3479

For Information Call

1-516-374-6793

MICROMINT INC.

917 Midway

Woodmere, N.Y. 11598

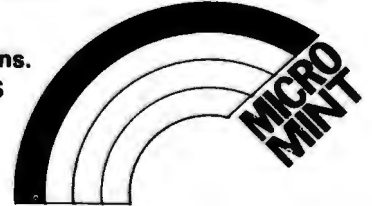

Micromint will put both a computer development system and an OEM dedicated controller in the palm of your hand for only \$195.

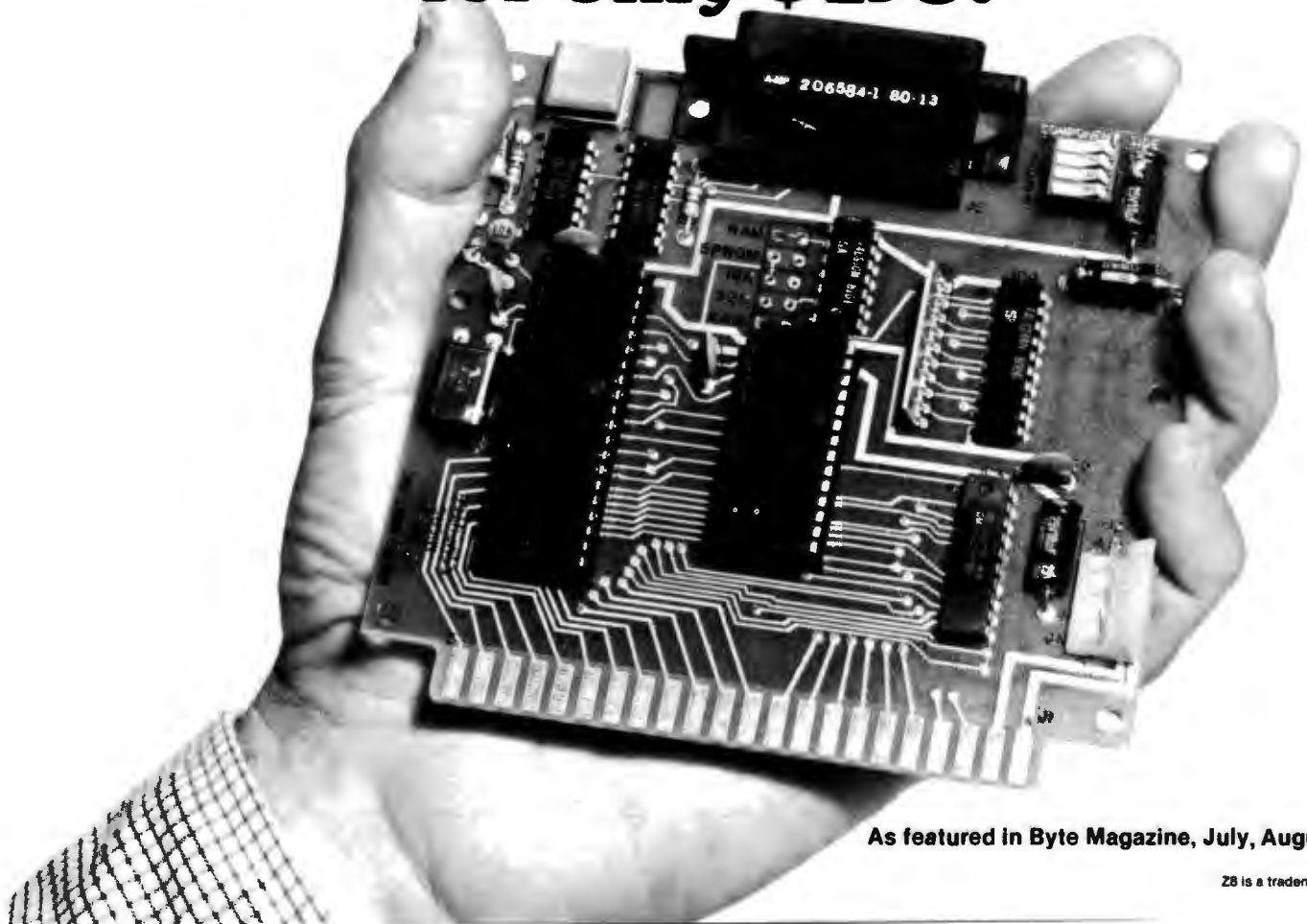

As featured in Byte Magazine, July, August, 1981.

Z8 is a trademark of Zilog Inc.

that Concurrent CP/M-86 will also offer:

- extensive error-handling and error-reporting
- date and time stamping of files
- record and file locking
- password protection of files, so that you can share your computer without sharing your secrets (e.g., the payroll in your office)
- networking compatibility
- real-time capability (useful, for example, for leaving the computer to send a message over the telephone while you dine out)

Hollsworth also noted that Digital Research is developing an interactive BASIC to fill the void left by Microsoft's decision not to provide future versions of BASIC-86 for CP/M-86-based machines. Also in the works is CP/M-68K, for the Motorola 68000 processor, due sometime this year. The family of CP/M operating systems will then support networking a mixture of systems based on the 8080, 8085, 8088, 8086, and 68000.

Both Hollsworth and Dr. Gary Kildall, head of Digital Research, were at pains to emphasize that Digital Research is looking at ways of adding Unix-like functionality to its operating systems. The Digital Research staff has several members with Unix backgrounds.

MS-DOS 2.0

Microsoft will be improving MS-DOS, too. At a seminar held in New York on March 10, Microsoft's co-founder and executive vice-president Paul Allen outlined the company's plans for MS-DOS version 2.0, due in the third quarter of 1982.

Perhaps most important, Microsoft will give MS-DOS a new "shell"—the face the operating system presents to the user. Instead of a simple command line, MS-DOS will give you a screen full of information divided into "windows" by category: files, utilities, applications programs, etc. You will be able to select files and programs by cursor movement. This means no more typing of file names and program names.

There will also be online help. You will be able to get help at any time by typing a question mark, and the help will be "context sensitive." And you will be able to customize the shell.

MS-DOS 2.0 will use program and driver interfaces that enable applications programs to talk to the screen and keyboard using ANSI (American National Standards Institute) standard Escape sequences. That should simplify the writing of applications programs for MS-DOS and therefore encourage more authors to write for the MS-DOS market. Furthermore, MS-DOS will support AT&T's Pre-

sentation Level Protocol for graphics and text, which will make it easier for MS-DOS systems to interface with cable networks and many database systems.

MS-DOS 2.0 will also support networking, both local networking of MS-DOS systems and hybrid networks of MS-DOS systems with systems running Microsoft's Xenix version of Unix. Microsoft is weighing the use of the Xerox networking protocols or the Department of Defense IP/TCP protocols. Microsoft will prototype its network on IBM Personal Computers.

An important new utility routine in MS-DOS 2.0 will be a print spooler. In other words, MS-DOS will let you print a file simultaneously with running a program.

An enhancement of the DEBUG utility will permit direct typing in of assembler mnemonics, a number of Xenix-derived utilities will permit filtering files in various ways, and EDLIN will become a more powerful line editor.

As noted earlier, Bill Gates has promised to make MS-DOS reconfigurable so that owners will be able to use serial printers.

Microsoft also plans to improve the already very fast performance of disk input/output by using multiple buffers.

MS-DOS and CP/M-86 on the IBM Personal Computer: Not My Dream Operating Systems

Mark Tinsdale
c/o BYTE Publications Inc.
POB 372
Hancock, NH 03449

Comparing MS-DOS and CP/M-86 on the IBM Personal Computer would be a lot easier if I could begin by invoking apples and oranges. Actually, these two operating systems share far more strengths and weaknesses than the suppliers, Microsoft and Digital Research, would like to admit. There are, however, indications that these systems will be evolving in different directions.

When Digital Research observes that MS-DOS is a "CP/M derivative," Microsoft counters that what it has supplied (known variously as MS-DOS, PC-DOS, and SB-86) is the low-end member of a new generation of operating systems. In fact, Microsoft has devoted a lot of time and energy to its Unix-based operating system (MS-DOS was purchased), and claims MS-

DOS to be fully "source-compatible" with the higher-level operating system. This of course assumes an application written in a portable dialect of a portable language. Much of the promised power of the Microsoft line of operating systems doesn't yet surface on the IBM Personal Computer.

Available for more than a year, CP/M-86 is more of a known quantity.

Continued on page 355

While early versions contained more than a few bugs, and some criticism has been leveled at the elegance of the translation of an 8-bit system to the 16-bit world, several vendors have been using CP/M-86, and some applications programs have been appearing on it. MS-DOS has a clear performance advantage over CP/M-86, but this is mainly due to some fundamental design decisions, and not lack of translation overhead. Neither system is my dream computer environment. In fact, neither system is entirely acceptable according to my criteria.

An Applications Programmer's Dream

What is my dream operating system? First and foremost, it will allow the support of user-friendly software solutions for noncomputer people. These solutions must be able to fully exploit the host hardware, in this case, one of considerable flexibility and power. The dream operating system will allow my program full control of the user's environment. If that user has any problems, I know it's my fault. The perfect system will charge a minimum of overhead for these services, but will support full graphics, console, disk, and communications I/O, and a host of other facilities provided by a computer as advanced as the IBM Personal Computer. All these requirements must be met by any system purporting to be usable. In addition, my particular dream operating system will allow me to easily develop those applications. Keep in mind that I am not addressing these systems primarily from the viewpoint of software developers, but from that of the Personal Computer owners who will use my software.

Sacrificing Memory Management to Gain Speed?

MS-DOS is the single-user member of a line of operating systems from Microsoft. To move to the world of multi-users, networking, or multitasking, Microsoft seems to suggest buying a DEC VAX. MS-DOS contains none of the memory-management and allocation facilities supplied by CP/M-86. One immediate benefit of this design decision is performance. Showing the effects of both a simpler operating-system design and a rethinking of file structure, MS-DOS can access a floppy disk with impressive speed. Using a heavily overlaid application and a hard disk, MS-DOS made the overlay loads imperceptible, while CP/M-86 introduced a noticeable lag of a second or so.

Superior User Interface?

When it comes to the user interface, MS-DOS demonstrates a few improvements over Digital Research's line. Since the copy program is resident, there is no more fumbling for a system disk with PIP and enough room. Furthermore, the syntax of operations like copy is a bit more logical to the human mind (copy from-to). Not having to type Control-C after a floppy change is a step in the right direction, and an auto-execute feature allows the creation of "bootable" applications without having to patch the BIOS. The ability to trap system errors helps in the construction of programs that never confound the user. All in all though, the system looks too much like CP/M to offer much of an improvement in the human interface area. While Microsoft claims that all its operating systems retain certain high-level features, such as device-independent I/O, it must be somewhat of an embarrassment that the system doesn't support the IBM Personal Computer's serial interface (and thus most printers). The homogeneity of this line of operating systems seems to leave a few holes that the Personal Computer owner must negotiate.

A Better Family?

CP/M-86 is also part of an operating-system family. This family, however, is much more interrelated and compatible than Microsoft's. Other members of this family include MP/M-86 for multiprocessing and the recently announced Concurrent CP/M for multitasking. While these systems are not transportable to non-8086 family computers, that is really Digital Research's problem—not the IBM Personal Computer owner's. Thus, a program developed under CP/M-86 stands an excellent chance of running, with no conversion effort, under the multi-user system accessing Digital Research's local network. While some may argue that the Personal Computer is not well suited to multi-user situations, the concept of concurrency (one user running several tasks simultaneously) is intriguing. Digital Research promises these derivative systems on the IBM Personal Computer soon, and they do exist on other 8086-based systems. Microsoft will be hard-pressed to expand the capabilities of MS-DOS significantly, at least in a timely fashion. And while at least one other vendor is offering a Unix-like system for the IBM Personal Computer (yes Virginia, there will be more than two), Microsoft has not been promising anything.

Terminal Support

Another difference between the two systems on the IBM Personal Computer is that MS-DOS does not emulate any terminal, while CP/M-86 does (the IBM 3101). While this difference is not inherent, but brought about by BIOS (machine-dependent) implementation, it may be the most controversial. Since BIOS content was under the control of Microsoft and Digital Research, we must conclude that they are significant aspects of the plans of the respective vendors. The lack of a simple way to specify video controls (such as cursor position and display attributes) will prevent many applications from being brought over to MS-DOS quickly (and, perhaps, optimally). Many display-oriented programs (such as word processors) that grew up in the CP/M world of microprocessors connected to terminals are ported via display drivers using control sequences. Eventually, manufacturers of machines with integrated displays supplied BIOSs that intercepted the control sequence of some popular terminal in order to allow a profusion of products to be brought to their systems. Since these terminal emulators involve much more overhead than direct video memory access, the capabilities of these integrated display systems were often not exploited.

In an apparent attempt to avoid this profusion of maladaptations, MS-DOS forces an author to rewrite the code making use of more efficient methods of Personal Computer display access. Reflecting its heritage, CP/M-86 is inviting as much software to appear on the IBM Personal Computer as soon as possible.

Bugged by Debuggers

And yes, I know I promised that I was addressing the concerns of users, not software developers, but I'll relent for one moment. The MS-DOS debugger is quite adequate, but suffers from the maddening omission of an Assemble command. Anyone at all familiar with the encoding of the 8086 instruction set understands the horror of hexadecimal programming, but unfortunately Microsoft's DEBUG forces a return to basics. On the other hand (the one that giveth), a Search command has been added to locate a byte pattern in memory. Although inserting that P-relative call in hexadecimal is so exasperating, at least you are able to locate the buggy code using last month's listing. This is perhaps a symbolic example of how combining features of these two systems can produce one heck of a computer. I hope someone does it soon!

Conclusions

Despite its lack of an online HELP facility and a utility for reconfiguring the system to use new devices, MS-DOS is a better operating system for users with little technical knowledge than is CP/M-86. MS-DOS has significant advantages in speed of disk input/output, efficiency of use of disk

space, and, most important of all, recovery from errors.

CP/M-80, designed for systems with limited memory, had to be a small operating system. As a result, no space was available to devote to things like code for error recovery. CP/M-86 has inherited some of these deficiencies. The continuing fall in the

price of memory chips should encourage Digital Research to enlarge CP/M-86 as necessary to meet the higher standards of convenience that are sure to arise as microcomputer ownership becomes more common.

Throughout its seminar in March, Paul Allen and other Microsoft spokesmen described MS-DOS as "Microsoft's single-user, single-tasking operating system." That appears to leave a big opening for Digital Research's Concurrent CP/M-86. The importance of concurrency cannot be overstated. Two years from now, all 16-bit microcomputers will have concurrency. Failure to support concurrency is a waste of computing power. Computer users will not settle for doing one thing at a time when they know their computers can do three things at a time.

Up to now, Microsoft has advised people who want multitasking to buy Xenix. At Microsoft's reception during the West Coast Computer Faire, however, Allen would not rule out the development of a Microsoft operating system that supports multitasking but stops short of being full Xenix (XE-DOS?).

In short, both Microsoft and Digital Research are moving to correct deficiencies. MS-DOS will be providing online help and support for a greater variety of hardware; CP/M-86 will increase speed and add error-handling capabilities. CP/M-86 already provides an upgrade path to MP/M-86, and MS-DOS will provide an upgrade path to Xenix. Despite MS-DOS's present impressive superiority in speed and error-handling, Digital Research's Concurrent CP/M-86 will give people a means of getting more work out of their computers.

Competition between CP/M-86 and MS-DOS will bring dramatic improvements in both operating systems. Much depends on when the promised improvements actually become available to the average user. If Microsoft and Digital Research do not deliver the improvements in a timely fashion, Unix may take up residence in more microcomputers than CP/M-86 and MS-DOS combined. ■

A Vote for MS-DOS

Neil J. Colvin
President
Phoenix Software Associates Ltd.
POB 207
North Easton, MA 02356

[Editor's Note: The following statements have been excerpted from the transcript of a speech given by Mr. Colvin at Microsoft's recent "Inside 16-Bit Operating Systems" seminar.]

My development staff has been designing and implementing CP/M-80-based software for five years and is now making the transition to the 8086. Since all members of my staff are now using MS-DOS for their development environment (a choice not imposed upon them), I must conclude that MS-DOS provides a more productive environment in which to work and a better foundation upon which to build new software products.

Among the important differences between MS-DOS and CP/M-86 are the following:

Program management: Both CP/M-86 and MS-DOS allow multiple segments of code to be included in a program, but only MS-DOS will automatically relocate intersegment linkages at the time of program loading. Under one of CP/M-86's program models, the segment bases of additional program segments are available in the memory image, but they must be explicitly managed by program code.

Memory management during program execution: MS-DOS uses an approach like that of CP/M-80 for memory

management. After a program is loaded, certain locations in its low data area contain the addresses of the top of the current data segment and the top of all available memory. The program has access to all memory from the base of its code segment through the top of memory, and can manage it as it desires. As a result, MS-DOS only supports machine environments that have contiguous user RAM.

CP/M-86 provides a set of system functions for allocating and releasing dynamic-memory space. Memory can be allocated from the free-memory pool or at absolute memory locations, providing control over access to memory-mapped devices or other non-shareable memory resources. CP/M-86 permits requests of memory segments of specific size or of the maximum memory segment available. As a consequence, available memory need not be contiguous.

Reliability: *Who is to say when one new software system is more reliable than another? I can only relate our experience to date, which shows a vast reliability difference between the two operating systems. We have been using CP/M-86 for almost a year and are still finding bugs, including complete features that just do not work as documented. We have been using MS-DOS for only about four months, but have yet to find a single bug.*

MICRO-SYSTEMS

NEW PRODUCT

INFORMATION

MEMO

TO: *All IBM, Xerox, & the 20 users*

SUBJECT: *expanding a non-expandable personal computer*

RECOMMENDED ACTION: *Order Now!*

COMMENTS: *Thanky Micro-Systems*

IBM® MEMORY EXPANDER: a full family of high quality designed expansion boards for IBM personal computers. Priced less than other manufacturers and **AVAILABLE NOW!!!**

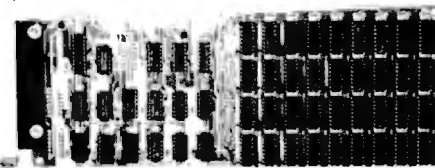

64K Expander I	\$ 299
192K Expander II	\$ 599
256K Expander III	\$ 799
512K Expander IV	\$1599

XEROX® 820 E-PROM PROGRAMMER:

- A) Capable of programming 16K, 32K and 64K E-Prom Without Personality Adapter.
- B) Requires no reconfiguration in the Xerox port when configured as Centronics port.
- C) "User Friendly Software" with capability of reading programs and verifying e-proms from other e-proms, roms, or disk resident software.

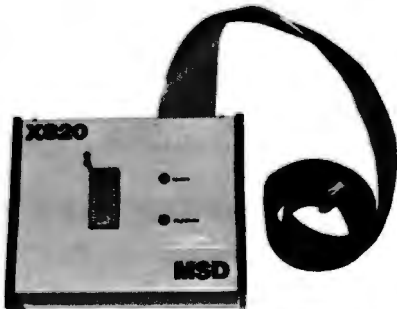

E-PROM PROGRAMMER \$295.00

PRINTER DRIVER FOR XEROX 820: Allows 820 users to access other printers (contains 8" floppy disk with drive program and cable.)

FOR CENTRONICS

FOR TI-810

VIC-20® VIE CARTRIDGE: Allows VIC interface with all existing Commodore IEEE Peripherals (8050, 4040, 2031 and printers), plus RS232 interface cartridge and 16K expansion.

AVAILABLE NOW!!!

VIE CARTRIDGE

RS232 CARTRIDGE

16K EXPANSION

Yes, Please send me:

QTY.	MODEL	PRICE
TOTAL	(In Texas, add 5% sales tax)	

Your Name _____

Address _____

City _____ State _____ Zip _____

payment method: Check Card Exp. Date _____

Master Card # _____

Visa # _____

American Express # _____

Signature _____

Micro-Systems • 11105 Shady Trail #103 • Dallas, Texas 75229 • (214) 484-7836

1) IBM is a registered trademark of the IBM Corp 2) Xerox is a registered Trademark of Xerox Corp 3) VIC-20 is a registered Trademark of Commodore INT

The more micro the more you should ta



Microcom products are menu driven for easy use and quick implementation.

Establish an economical point to point electronic mail network among major micros.

Send and receive complex software programs.

If you've installed Apple™ or IBM® personal computers in your office, you can turn them into the most effective communications tools in your company. All it takes is inexpensive, easy to use software from Microcom.™

With Microcom software, you can communicate instantly with other micros, minis and mainframes *anywhere*—not just within your company's network. In addition to your own data bases, you can access commercial services like THE SOURCESM and Dow Jones.™

No wonder some of the world's largest companies are already using Microcom software. To transfer critical laboratory data error-free. To coordinate huge retail inventories. To track stocks and bonds. And, in general, to communicate economically and effectively. Across town or across the country.

Micro-Courier provides instant, error-free communications with other personal computers.

Micro-Courier,™ Apple's standard electronic mail software, allows personal computers to instantly, accurately and economically send information to other

personal computers.

You can send an urgent memo across the country in seconds. Receive lengthy documents economically and error-free. Or transfer charts, graphs—even entire VisiCalc™ reports—between the major personal computers. Without the delay of the mails or the expense of hand delivery.

And Micro-Courier transmits and receives messages automatically, unattended. So you can communicate efficiently and take advantage of 60% savings from off-hour phone rates.

Micro-Terminal links you with your corporate network. Commercial information services, too.

Micro-Terminal™ ties you directly to virtually any in-house or remote data base. So instead of going through the long process of getting printouts from your DP department, you can get the information yourself. Directly, easily and instantly.

In addition, Micro-Terminal can connect you with more than 1,000 commercial services, including THE SOURCE, Dow Jones and many others. So any time you like, you can have up-to-the-minute

computers talk to you, talk to Microcom.



Combine major personal computers into a VisiCalc network.



Easily access corporate or commercial data bases.



Transfer graphics and data reliably and error free.

information on nearly any topic you can name. From UPI news, to stock and commodity listings, to airline schedules.

Micro-Telegram. Western Union services from your Apple II.™

Micro-Telegram™ connects you to any Western Union™ terminal in the world via TWX,™ Telex,™ Mailgram™ or international cable. It also brings you news, stock and gold quotes, foreign exchange rates, even sports and ski reports.

Micro-Telegram is much better than a mechanical Teletype.™ It operates unattended. It automatically formats, files and displays messages. And, since you create and edit messages off-line at your CRT, it saves you the time and aggravation of punching and repunching paper tapes.

Support you can rely on.

When you buy Microcom's communication packages, you're buying a lot more than just software. You're buying easy-

to-use, reliable products with professional documentation and knowledgeable customer support. And you're buying the convenience of a nationwide dealer network.

So if you're talking communications, you should be talking to Microcom. Now, for more information, contact your local Apple or IBM computer dealer.



MICROCOM

We make little computers talk big.

1400A Providence Highway, Norwood, MA 02062, 617-762-9310

Microcom, Micro-Courier, Micro-Telegram and Micro-Terminal are trademarks of Microcom, Inc. Apple and Apple II are trademarks of Apple Computer Inc. VisiCalc is a trademark of VisiCorp Inc. Western Union, Mailgram, TWX, Telex and Teletype are trademarks of Western Union, Inc. Dow Jones is a trademark of Dow Jones, Inc. THE SOURCE is a servicemark of Source Telecomputing Corporation. IBM is a registered trademark of International Business Machines Corporation.

Using the Model I/III RS-232C Port

Mysteries of the TRS-80 Model I and III RS-232C interface are solved, and instructions are given for building a data-communications plugboard.

William Barden Jr.
28122 Orsola
Mission Viejo, CA 92692

This article will try to save TRS-80 Model I and III users from some of the consternation involved with RS-232C operations. We'll look at the logic of the Model I/III RS-232C port and discuss the universal asynchronous receiver/transmitter at the heart of the RS-232C interface in both machines. A troubleshooting device to facilitate hooking up nonstandard (or non-Radio Shack) devices to the RS-232C port will be described. Finally, I'll show you how to use the Model I/III to do your own "serial" programming.

Asynchronous Communications

Except for a few minor differences, the Model I and Model III use the same logic to generate RS-232C signals, as shown in figure 1 on page 362.

Model I/III serial communications are asynchronous,

that is, the time between characters is variable (not synchronized). However, the timing *within* each character is fixed; it consists of a stream of uniformly spaced intervals in which voltage levels represent logical bits. Typical bit rates range from 10 to 9600 bits per second (bps). Figure 2 shows a single character expressed as a serial bit stream.

The number of bits per character depends on the format chosen. The first bit is always a 0, or *start bit*, opposite from the normal state of the line. The last 1 or 2 bits are 1s, or *stop bits*, returning the line to a quiescent state. From 5 to 8 data bits may be in between, with the typical number being 7 or 8. In addition, there may be a parity bit, which is a check on the number of 1s or 0s in the character. If present, the parity bit is set to a 1 or 0 to make the total number of 1 bits odd or even.

The bit rate, word length, number of stop bits, and parity determine the maximum character-transmission rate. A bit rate of 110 with 1 stop bit, 7-bit words, 1 parity bit, and 2 stop bits (11 bits in all) allows transmission rates of approximately 10 characters per second (cps).

According to RS-232C conventions, voltage levels are used to indicate logic levels: +3 to +25 volts (V) for a

About the Author

William Barden Jr. has written many books on microcomputer programming and design, including Z-80 Microcomputer Design Projects.

TEST-FLY A \$20 MILLION JET ON AN APPLE? YES. WITH MICROSPEED.

At the Bethesda Naval Research Center, they've discovered the power of MicroSPEED. The Navy's engineers use this remarkable hardware/software combination to "fly" an advanced fighter aircraft in *real time*—even making vertical landings on a simulated carrier deck. A "crash" is merely another learning experience, and an opportunity to modify the research aircraft—inside the Apple—to improve tomorrow's combat planes.

Surprised that such a sophisticated task is possible on the Apple? So were the Navy's officials, and many others who have discovered...

THE MICROSPEED DIFFERENCE This extraordinary Language System exploits the real potential of the microcomputer for the first time. The difference between MicroSPEED and other programming languages is that with MicroSPEED, there is virtually *no limit* to what you can achieve. It may well be the ultimate language for the Apple II and III (and soon the IBM Personal Computer). MicroSPEED literally combines the performance of a *minicomputer* with an exhaustive set of user-friendly capabilities: hard-

ware math processing, fast hi-res graphics and text, turtle graphics, print formatting, two text editors, unlimited data types, and incredible FORTH extensibility—all at speeds up to 100 times faster than Basic.

USER-FRIENDLY, EASY-TO-LEARN Starting with simple commands that are comfortable even for non-programmers, MicroSPEED extends and builds, allowing you to create your own tailored application languages. The capability of your computer will grow exponentially, as you work in an active partnership with the machine, exploring and developing new problem-solving facilities—creating, correcting, refining your increasingly powerful system.

DEMANDING JOBS AT LOW COST Developed by a team of standout computer professionals, MicroSPEED has been put to the test in fields as diverse as medicine, the stock market, oceanography, and the arts. In even the most challenging applications, MicroSPEED users have been unanimous in their praise of the System and manual. Typical comments are:

"Very high marks,"

Thomas Tosch Phd., Tosch Information Management.

"The more I use MicroSPEED, the more I love it!"

James L. Hockenhull, University of Washington.

"Great!...A joy to use!"

Henry Harris, Mission Designer, Cal Tech's Jet Propulsion Lab.

"If you plan to use the Apple or IBM Personal Computer for *any* demanding task, then we built MicroSPEED for you."

Sam Cottrell, President of Applied Analytics.



MicroSPEED requires the Apple or IBM Personal Computer with single disk. MicroSPEED II includes 2 MHz math processor. MicroSPEED II + includes 4 MHz math processor.

Applied Analytics Incorporated

8910 Brookridge Drive

Upper Marlboro, Maryland 20772 (301) 627-6650

I'm interested! My computer is: _____

Please send me:

_____ MicroSPEED II, \$495.00 _____ 160 Page Manual, \$15.00

_____ MicroSPEED II +, \$645.00 _____ Detailed Information

Name: _____

Company _____

Address _____

City _____ State _____ Zip _____ Phone No. () _____

Use this coupon to order, or for more information.

MicroSPEED 

APPLE IS A TRADEMARK OF APPLE COMPUTER INC.

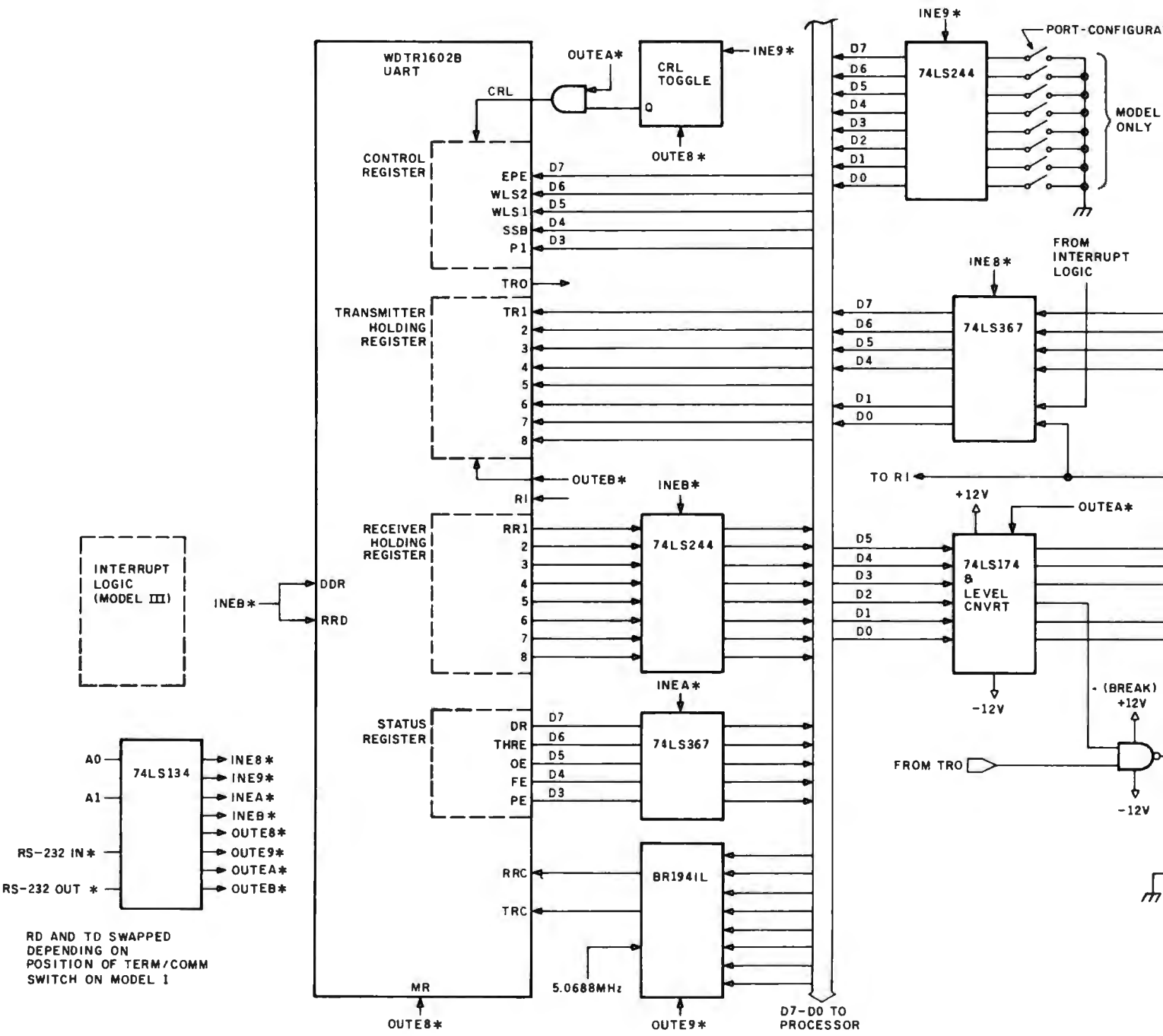

RD AND TD SWAPPED
 DEPENDING ON
 POSITION OF TERM/COMM
 SWITCH ON MODEL I

PERSYST ADD-IN PRODUCTS

When Only The Very Best Will Do!

You wanted the very best... that's why you waited for the IBM® Personal Computer. Now you're ready to expand your system and again, you want the very best.

The best is here... PERSYST'S growing family of IBM compatible add-in products.

MEMORY EXPANSION—Implemented with socketed high-speed dynamic RAMs, the memory is designed for easy expansion and is available in four configurations—64K, 128K, 192K, and 256K bytes. Field expansion kits are available in 64K increments. PERSYST'S memory features parity checking and error reporting, switch selectable addressing on any 64K boundary and complete compatibility with IBM hardware and software.

COMMUNICATIONS—PERSYST'S asynchronous communications board is available in single or dual channel configurations. Both channels support programmable Baud rates ranging from 50 to 19,200 Baud; 5, 6, 7, or 8-BIT characters with 1, 1½ or 2 stop bits; even, odd or no parity bit generation and detection; fully prioritized interrupt system; full modem support, full duplex operation; and double buffering to eliminate the need for precise synchronization.

DUAL FUNCTION—The PERSYST FLEX-COMM Series multi-function board provides two asynchronous communications lines, and a parallel printer port all on a single circuit board. The FLEX-COMM Series is available in 5 different configurations, all field upgradeable to a fully populated board.

MULTIFUNCTION—Incorporating all the features of PERSYST'S memory, communications, and printer options, the

SPECTRUM Series multi-function board provides 64K to 256K of field expandable memory, two asynchronous communications lines, and a parallel printer port all on a single, full length circuit board. The SPECTRUM Series is available in 24 different configurations, all field upgradeable to a fully populated board.

All PERSYST boards are thoroughly tested and burned-in at elevated temperatures for increased reliability. IBM-like documentation is included, as is a one-year, return to factory warranty.

Don't settle for less... insist on PERSYST. See the expanding line of PERSYST products at your local PERSYST dealer or contact:

PERSYST, INC.

22957 La Cadena
Laguna Hills, CA 92653
(714) 859-8871

® IBM is a trademark of International Business Machine Corp.



All PERSYST products now available through:

SAD Systems, Inc., 23891 Via Farrisante, Mission Viejo, CA 92691, (714) 768-2913

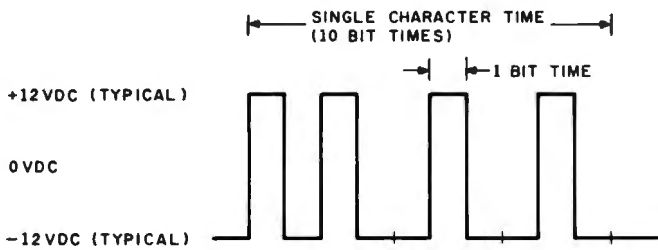

Figure 2: Asynchronous transmission of a character or other data involves sending a string of 1s and 0s. Intervals between characters may vary, but bit times within a character and number of bits are precisely defined.

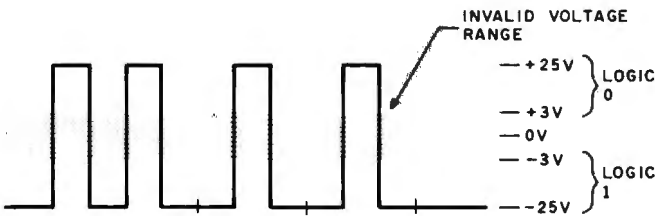

Figure 3: RS-232C specifications provide for a "1" level of -3 to -25 V and a "0" level of $+3$ to $+25$ V. The range from $+3$ to -3 V is undefined.

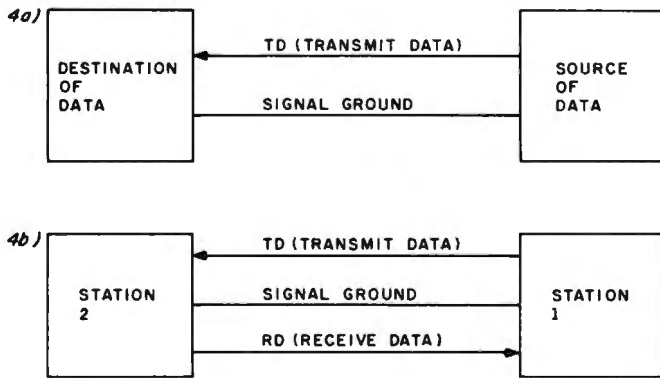

Figure 4: In 4a, two wires allow unidirectional transmission; in 4b, three wires are sufficient for bidirectional communication.

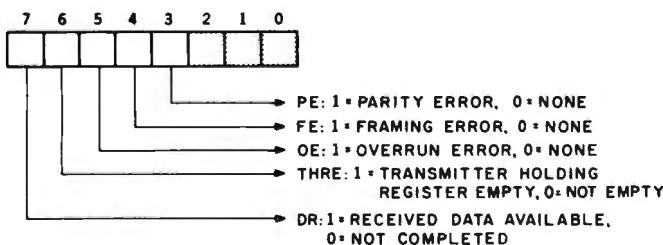

Figure 5: Control-register bits in the UART define the word length, parity type or no parity, and the number of stop bits.

logic 0 and -3 to -25 V for a logic 1. Levels from -3 to $+3$ V are invalid (see figure 3).

One-way transmission requires only two wires, transmit data (TD) and ground, as shown in figure 4. For two-way transmissions, a third wire, receive data (RD), is required.

Two-way communications can be either half- or full-duplex. In half-duplex, information can travel in only one direction at a time; in full-duplex, information can travel in both directions simultaneously.

While it's possible to send data over the three-wire setup of figure 4, that method is limited. All handshaking must be encoded, sent as data, and decoded on the other end. The full RS-232C asynchronous system, therefore, includes many other useful signals, as shown in table 1.

Only a small number of these signals are needed and used for communications with printers and modems. The RS-232C signals used in the Models I and III are marked in the table with an asterisk; pin numbers remain the same.

The Western Digital TR1602B

The Western Digital TR1602B, used in both the Models I and III, is a large-scale integration (LSI) chip that handles variable transmission rates, word formats, full-duplex operations, parity, and just about every phase of RS-232C communications. Its generic name is universal asynchronous receiver/transmitter (UART for short).

As shown in figure 1, the four registers in the TR1602B are the control register, the transmitter-holding register, the receiver-holding register, and the status flags.

The control register. This is normally loaded once, before any communications. Five control bits associated with the control register are shown in figure 5.

The WLS1 and WLS2 bits determine the word length of the transmission, as shown in the figure. This is the number of data bits per word, *exclusive of the parity bit*.

If the PI, or parity inhibit, bit is a 1, no parity bit is generated with each character. If the PI bit is a 0 and the EPE bit is a 1, even parity is generated; if the PI bit is a 0 and EPE is also a 0, odd parity is generated.

If the SBS bit is a 1, 2 stop bits follow the last data bit or the parity bit. If SBS is a 0, 1 stop bit follows.

The transmitter holding register. This 8-bit register holds the byte to be transmitted, which it ships out a bit at a time. In effect, the transmitter holding register performs a parallel-to-serial conversion of the character to be transmitted. As soon as a byte is loaded, the start bit is sent over the TRO (transmitter register output), followed by the 5 or 8 bits in the transmitter holding register, least significant bit first. The transmission rate is determined by the TRC (transmitter clock input).

The receiver holding register. This is a counterpart to the transmitter holding register. It accumulates the incoming data bits from the RD line, performing a serial-to-parallel conversion. The receiver holding register is read after all data bits have been received to recover the parallel form of the received character.

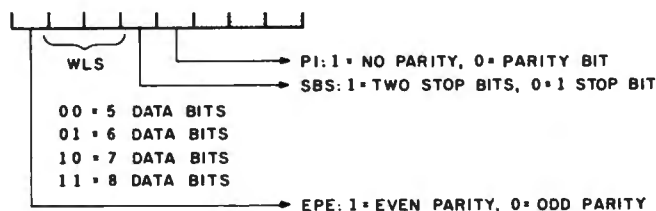

Figure 6: Status bits from the UART indicate whether the input or output operation has been completed and whether an error has occurred in transmission.

The status register. This is a collection of 5 bits representing the TR1602B status, as shown in figure 6.

If THRE is a 1, the transmitter holding register is "empty," has performed its parallel-to-serial conversion, and has sent the data over the TD line. A new character can now be stored in the transmitter holding register.

If the DR bit is a 1, a new character has been received and is in the receiver holding register; it can now be read from the TR1602B.

OE, FE, and PE are error indicators; a logic 1 in any of these bits indicates that an error has occurred. PE (parity error) indicates that the received parity bit does not match the parity of the received data bits; one or more data bits have been erroneously received. FE (framing error) indicates that no stop bits were found in the received character. The OE (overflow error) bit is set when two or more characters are received before the computer performs a read.

The Bit-Rate Generator

The second LSI chip used in the RS-232C interface is the BR194IL bit-rate generator (BRG). In the Model I, the clock input is from a 5.0688-megahertz (MHz) crystal oscillator. The Model III uses a system timing signal of the same frequency. This clock reference is "divided down" into the proper transmitter and receiver clock frequency. It is sent to the TR1602B via the RRC and TRC inputs. These inputs are actually 16 times the desired bit rate; this increases the resolution during transmissions at high bit rates.

The bit-rate generator is loaded with two 4-bit codes that represent the frequencies to be used for the receiver and transmitter clock. This is normally done once, before data transmission begins. The bit rates and their corresponding codes are shown in table 2.

Interface Logic, Models I and III

The RS-232C interface circuits for the Model I and Model III are almost identical. Figure 1 shows the part numbers associated with the Model III, but similar logic is used on the Model I. The TR1602B UART has four Z80 port addresses associated with it, hexadecimal E8, E9, EA, and EB.

A 74LS134 chip decodes the RS-232C address into four input and four output signals. Address lines A0 and A1

Pin Number	Symbol	Description
1**	PGND	protective ground
2**	TD	transmitted data
3**	RD	received data
4**	RTS	request to send
5**	CTS	clear to send
6**	DSR	data set ready
7**	SGND	signal ground
8**	CD	carrier detect
9	—	reserved for data set testing
10	—	reserved for data set testing
11	—	unassigned
12	—	secondary received line signal detector
13	SCTS	secondary clear to send
14*	STD	secondary transmitted data
15		
16	SRD	secondary received data
17		
18*	SUN	secondary unassigned
19*	SRTS	secondary request to send
20**	DTR	data terminal ready
21	—	signal quality detector
22**	RI	ring indicator
23		
24		
25	—	unassigned

* Model III only
** Model I/III

Table 1: Common RS-232C signal assignments.

Decimal Code	Binary Code	Bit Rate
0	0000	50
1	0001	75
2	0010	110
3	0011	134.5
4	0100	150
5	0101	300
6	0110	600
7	0111	1200
8	1000	1800
9	1001	2000
10	1010	2400
11	1011	3600
12	1100	4800
13	1101	7200
14	1110	9600
15	1111	19,200

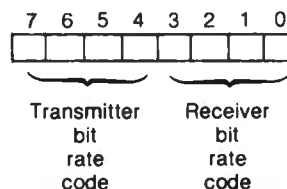

Table 2: Bit-rate codes for the Western Digital TR1602B.

Hexadecimal Address	IN	OUT
E8	Read modem status register (CTS, DSR, CD, RI)	Master reset
E9	Read sense switches (Model I) Toggle CRL (Model III)	Load BRG with bit-rate codes
EA	Read UART status register	Load UART control register and set Break, DTR, RTS, or set SUN, STD, SRTS, Break, DTR, RTS
EB	Input character from receiver holding register	Output character to transmitter holding register

Table 3: UART-Model I/III actions for the four RS-232C addresses.

determine the 2 least significant bits of the address, while a Z80 IN or OUT to port hexadecimal ExH generates the RS232IN* and RS232OUT* signal (BASIC INP/OUT can also be used).

Table 3 shows the actions that occur for the four addresses for either reads or writes (INs or OUTs).

Model I RS-232C sense switches. The Model I differs from the Model III in that it has eight RS-232C switches that can be read by an "IN 0E9H". These sense switches provide a manual way of telling the software what RS-232C settings to use. They have no direct effect on the UART or BRG; they come into play only if the initialization program reads them and initializes the UART accordingly.

The sense switches do not exist in the Model III. An "IN 0E9H" causes a different action. It toggles the CRL signal so that an "OUT EAH" sets three additional signals in the Model III—SUN, STD, and SRTS. These secondary signals (secondary undefined, transmit data, and request to send) are not used in normal Model III communications programs. Subsequent "OUT 0EAH" instructions toggle the load from control register to secondary. A master reset of "OUT 0E8H" resets the toggle to a normal load of the control register.

Initialization. The first action to take before doing any data communications is to initialize the UART and BRG chips. The sequence is:

1. Do a Z80 "OUT (0E8H),A" or a BASIC "OUT 232,0". The value in A doesn't matter, as no actual data is sent. This causes the MR input to reset the UART. It also resets the data-received status and disconnects the receiver holding register by the inputs DRR and RRD, respectively.

POWER-LINE FILTERS

These filters protect any sensitive electronic equipment from power line transient damage and radio frequency interference. Both models offer surge suppression for power line "spikes". RF interference is suppressed using both inductive and capacitive components. Ideal for computers, test equipment, or TV.

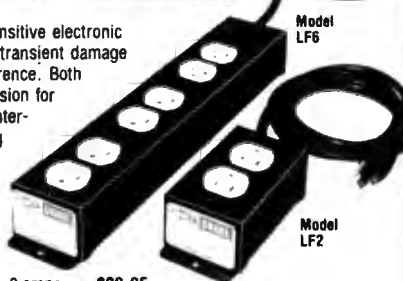

LF2—A duplex outlet, 120V, 8 amps . . . \$39.95

LF6—Three separately filtered duplex outlets, 120V, total fused capacity 15 amps, power switch and indicator lamp . . . \$69.95

Add \$2.50 shipping and handling per order. Send check with order and provide street address for UPS shipment. Ohio residents add Sales Tax. Charge card buyers may call toll-free:



1-800-543-5612

In Ohio, or for information, call: **1-513-866-2421**



R. L. DRAKE COMPANY

540 Richard Street, Miamisburg, Ohio 45342

INSTITUTIONAL AND DEALER INQUIRIES INVITED

Model 953A EPROM PROGRAMMER

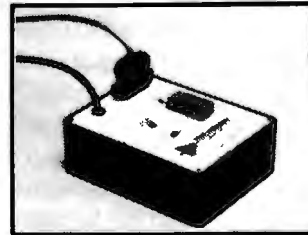

- Programs 2508, 2758, 2516, 2716, 2532 and 2732 five volt EPROMs.
- Complete - no personality modules to buy.
- Intelligent - microprocessor based, programs and verifies any or all bytes.
- RS-232 serial interface - use with computer or terminal.
- Verify erasure command - verifies that EPROM is erased.
- Extended diagnostics - error output distinguishes between a bad EPROM and one which needs erasing.
- May be used for extremely reliable data or program storage.
- All power on programming socket under processor control. LED warning light indicates when power is applied.
- Complete with Textool zero insertion force socket.
- High performance/cost ratio.
- Standard DB-25 I/O connector.

PRICE \$289



BAY TECHNICAL ASSOCIATES, Inc.

HWY. 603, P.O. BOX 387
BAY ST. LOUIS, MISSISSIPPI 39520
(601) 467-8231

It's just plain unbeatable. Period.

\$1295*

TEC F-10

40 CPS DAISY WHEEL RS232C SERIAL

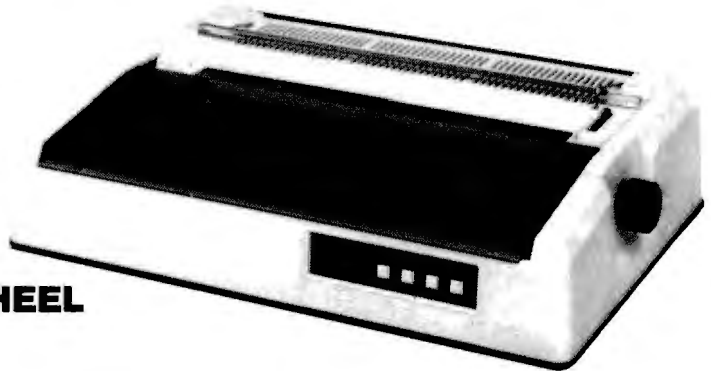

The saga continues...A printer that changes the rules. When we first saw the TEC F-10 we could not believe it. A printer that has it all. 40 characters per second speed, Diablo compatible software codes so it works with all the software on the market like WordStar, and Magic Wand, and a serial RS232C interface so it can hook up to any computer, bar none. Even better, it uses Diablo and Qume type wheels, and Diablo type ribbons. This looked like a big winner, the kind that would dominate the market for high performance daisy wheel printers. Now our goal was to get a piece of the action.

ONE SOURCE

You have seen several labels on printers looking suspiciously like the F-10. You probably didn't think that a whole bunch of different companies make this printer, and you are right. The F-10 is made by Tokyo Electric Company Ltd., (TEC). They sell printers to a lot of companies. A couple of the better known are C. Itoh Electronics, and Tandy Corporation. C. Itoh Electronics sells TEC printers through their exclusive distributor Leading Edge Products, and Tandy Corporation sell through their own stores.

To compete with these giants we had to buy the printers on a comparable level, and create a whole new group of customers by lowering the price drastically. This would create the best price/performance daisy wheel buy on the market.

We figured that the right combination of an adequate profit margin and a big chunk of the market would produce a real healthy business. Since we have been in the distribution business a few years we had a good idea of the necessary profit margins. We didn't want to be the next Freddie Laker.

We also had learned the lessons of how a real great product can quickly dominate a market (as taught by Epson). So we checked out the high volume buyers prices, plugged all the numbers into good old Visicalc, and Voila, within days of our first ads sales were way above our projections. We had caught the competition napping and were leaving them in

the dust. Keep those cards and letters comin' folks.

THE "ELECTROCUTED TYPEWRITER"

There is more to the F-10 than a low price. If we just wanted to sell a cheap daisy wheel printer, there are lots of typewriter manufacturers who are modifying their products so they can interface with a computer. Some notable entrants to this field are Smith Corona, Brothers, and Olympia. Big names in the typewriter biz.

Unfortunately, these printers have lots of limitations. Low speed, low duty cycle, and they require special wheels and ribbons. They aren't capable of running standard software. With the F-10 you don't have to make these compromises to get low cost daisy wheel printing.

THE TECHNICAL STUFF

First, the unit is built on a diecast aluminum chassis. This absorbs noise and vibration making it ideal for office or home use. The power supply is a high reliability switching type for reduced heat during operation. This eliminates the need for a noisy cooling fan. All the sophisticated electronics (including its own microprocessor) are on just three circuit boards for high reliability. The mean time between failure (MTBF) rating of one year means that the typical failure rate at a 75% duty cycle is one year. In English that means about 2500 hours of trouble free operation. So far our technician is spending a lot of time with the Maytag man.

Warnings for paper out, ribbon out, and cover off, are all standard. The F-10 can use full 16" width paper, with friction or optional tractor feed from the rear or bottom. To top it all off, it has an attractive, low profile case — just 6 inches tall. It's a lightweight at 31 pounds. The printer can be connected to any computer with an industry standard RS232C serial interface. We have interfaced the F-10 with everything from Apples to Zeniths. We will be happy to help you hook it up to your computer. Handshaking by DTR,

XON/XOFF, and ETX/ACK protocols. Baud rates from 300 to 2400.

Superscript, subscript, forward/backward printing, proportional spacing, and 10 or 12 character per inch. printing are all standard. Plus all the other good things that standard Diablo software codes do. This makes the F-10 a natural for use with all existing word processing packages that run with printers like the Diablo, NEC, and Qume. The optional buffer chips allow the printer to store and print up to 2000 characters while your computer does other things. The downloading chip provides a clever programmer with additional software commands and the ability to use printwheels whose characters are not in the same positions as standard wheels. Neat stuff.

SATISFACTION GUARANTEED

Our warranty is 90 days parts and labor. If there is a problem we arrange for United Parcel Service to pick up the printer at your home or office. We pay the freight charges on warranty repairs. Easy huh. Annual maintenance contracts are available for a small fee. And to top it off, if for any reason you are not satisfied, you may return the unit to us within 30 days for a full refund.

We have increased our orders to support the demand. Call us today and get the real thing at the unreal price of \$1295*.

**California residents add 6% sales tax.*

Dealer inquiries invited.

Write Writer, inc.

**1703 STEWART STREET
SANTA MONICA, CA 90404
(213) 829-6871**

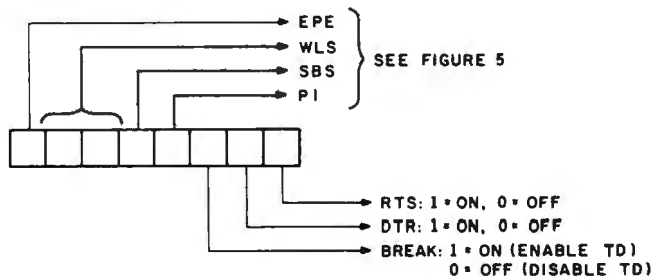

Figure 7: An 8-bit function code is used to initialize the RS-232C interface. Five bits initialize the UART control-register functions, while the remaining 3 bits set two output lines and enable the TD line.

2. Define the serial parameters (word length, etc.). This is a 5-bit code, as shown in figure 7. The remaining 3 bits define the "break," DTR, and RTS outputs. These signals are set to match the requirements of the device at the other end of the line. At this point, however, the "break" bit must be set to enable output of serial data on the TD line. Output the parameters to the control register by an "OUT (0EAH),A" or a BASIC "OUT 234,A". This sets up the control register for the data-communications format to be used. It also sets the selected DTR/RTS signal levels at -12 V or +12 V.

3. Select the appropriate bit-rate code (table 2) and output it to the BRG by a Z80 "OUT (0E9H),A" or BASIC "OUT 233,A".

The TR1602B is now initialized. This process should not have to be repeated unless the bit rate or other parameters need to be changed during serial communications.

Writing data. Suppose you have a serial line printer attached to the Model I or III. The control register has been loaded with the proper format parameters to match the line printer and the BRG has also been initialized. From this point on, it's simply a matter of reading the status, testing to see if the transmitter holding register is empty, and, if it is, loading it with the next character to be transmitted. This loop is done for every character and goes like this: Input the status by a Z80 "IN A,(0EAH)" or a BASIC "A=INP(234)". Test bit 6 (THRE) of the status. If this bit is a 0, loop back to the test. If this bit is a 1, output the character to be transmitted by an "OUT (0EBH),A" or "OUT 235,A".

Reading data. Reading data is just about as easy. The read loop consists of reading the status to see if a new character has come in. If it has, the character is read from the receiver holding register. The loop goes like this: Input the status by a Z80 "IN A,(0EAH)" or a BASIC "A=INP(234)". Test bit 7 to see if DR is a 1. If it is not, loop back to the status input. If DR is a 1, read in the assembled character by an "IN A,(0EBH)" or "A=INP(235)". Repeat this loop or go to a test for a new character to be transmitted.

In practice, the read and write operations usually alternate in the same loop.

The Data-Communications Plugboard

Before giving you actual programming examples of serial operations, I'm going to describe an easy-to-construct RS-232C plugboard. The plugboard can be used in experiments with the programming examples I'll be giving. More important, it can be used to help you interface serial devices to your Model I or III computer. The plugboard is shown in figure 8.

The plugboard breaks a 25-line RS-232C cable and routes the lines through a prototype board. Short lengths of 20-gauge solid wire are used on the plugboard to connect the two sides of the cable, as shown in figure 9. To transpose RD and TD, for example, simply crisscross pins 2 and 3 as shown in the figure. Other lines can be connected in a similar manner. To test the state of any line, an LED can be connected with a resistor to signal ground, pin 7, and the line in question, as shown in the figure. Lines can be "dummied up" in lieu of wiring up a special RS-232C plug simply by adding a patch between an active line and the line to be dummied.

To construct the plugboard, use the smaller version of the Radio Shack prototype board (catalog #276-175). The back has a sticky paper cover. Peel this off to expose the

DYMARC INDUSTRIES, INC.

LINE VOLTAGE TRANSIENT SUPPRESSORS
Features Parallel Operation 5000 Hits/Second

Clipstrip™ AND Clipper™

PROTECTS:

- Computers
- Micro-Computer Systems
- Word Processors
- Cash Registers
- Power Supplies

PROTECTS AGAINST:

- High Energy Voltage Transients
- On-Off Switching
- Lightning Induced Transients
- Inrush of On/Off Power

DYMARC INDUSTRIES, INC.
DEALER INQUIRIES INVITED

7133 Rutherford Rd. Baltimore, Md. 21207

WE HONOR
Clipstrip 977E Clipper 878F

800-638-9098 (301) 298-3130

Don't miss this incredible, money-saving opportunity!



The Computer Book Club offers you all the latest titles on hardware, software, theory, and applications PLUS ready-to-run tapes and disks at special, low, low member prices!

Select 6 fact-filled books for only \$2.95 (total value up to \$120.70)

1332 List \$16.95: HOW TO DESIGN, BUILD & PROGRAM YOUR OWN ADVANCED WORKING COMPUTER SYSTEM

1295 List \$16.95: 55 ADVANCED COMPUTER PROGRAMS IN BASIC

1370 List \$22.95: PASCAL

1275 List \$14.95: Challenging Computer Games for TRS-80 /Apple /PET

1205 List \$16.95: THE MOST POPULAR SUBROUTINES IN BASIC

1050 List \$10.95: 80 PRACTICAL TIME-SAVING PROGRAMS FOR THE TRS-80

1228 List \$12.95: 34 MORE Tested, Ready-To-Run Game Programs in BASIC

1123 List \$11.95: THE LASER EXPERIMENTER'S HANDBOOK

1276 List \$15.95: COMPUTER GRAPHICS with 29 ready-to-run programs

1316 List \$16.95: THE MASTER HANDBOOK OF TELEPHONES

1337 List \$19.95: SMALL COMPUTERS FOR THE SMALL BUSINESSMAN

1055 List \$8.95: The BASIC Cookbook

1293 List \$15.95: 67 Ready-to-Run Programs in BASIC

1316 List \$16.95: WHAT TO DO WHEN YOU GET YOUR HANDS ON A MICROCOMPUTER

1394 List \$15.95: PROGRAMMING YOUR APPLE II™ COMPUTER

1088 List \$13.95: ILLUSTRATED DICTIONARY OF MICROCOMPUTER TERMINOLOGY

336 List \$14.95: How to Get Started with CP/M

1397 List \$16.95: 1001 THINGS TO DO WITH YOUR PERSONAL COMPUTER

1160 List \$13.95: MASTER HANDBOOK OF MICROPROCESSOR CHIPS

1277 List \$19.95: HOW TO DESIGN BUILD REMOTE CONTROL DEVICES

1333 List \$16.95: 101 MICROPROCESSOR SOFTWARE & HARDWARE PROJECTS

1380 List \$18.95: 30 COMPUTER PROGRAMS FOR THE HOMEOWNER IN BASIC

1398 List \$14.95: 57 PRACTICAL PROGRAMS & GAMES IN BASIC

1000 List \$10.95: 80 PRACTICAL TIME-SAVING PROGRAMS FOR THE TRS-80

7 very good reasons to try The Computer Book Club
Blue Ridge Summit, PA 17214

- **Reduced Member Prices.** Save up to 75% on books sure to increase your know-how
- **Satisfaction Guaranteed.** All books returnable within 10 days without obligation
- **Club News Bulletins.** All about current selections—mains, alternates, extras—plus bonus offers. Comes 13 times a year with dozens of up-to-the-minute titles you can pick from
- **"Automatic Order."** Do nothing, and the Main selection will be shipped automatically! But . . . if you want an Alternate—or no books at all—we'll follow the instructions you give on the reply form provided with every News Bulletin
- **Continuing Benefits.** Get a Dividend Certificate with every book purchased after fulfilling membership obligation, and qualify for discounts on many other volumes
- **Extra Bonuses.** Take advantage of added-value promotions, plus special discounts of software, games, and more
- **Exceptional Quality.** All books are first-rate publisher's editions, filled with up-to-the-minute info

The Computer Book Club
Blue Ridge Summit, PA 17214

Please accept my membership in The Computer Book Club and send the 6 volumes circled below. I understand the cost of the books selected is \$2.95 (plus shipping/handling). If not satisfied, I may return the books within ten days without obligation and have my membership cancelled. I agree to purchase 4 or more books at reduced Club prices during the next 12 months, and may resign any time thereafter.

336 337 1000 1050 1055 1088 1123 1160 1195
1205 1228 1271 1275 1276 1277 1293 1295 1299 1316
1332 1333 1350 1369 1370 1380 1394 1397 1398

Name _____ Phone _____
Address _____
City _____
State _____ Zip _____

(Valid for new members only. Foreign and Canada add 20%. Orders outside U.S. or Canada must be prepaid with international money orders in U.S. dollars.)

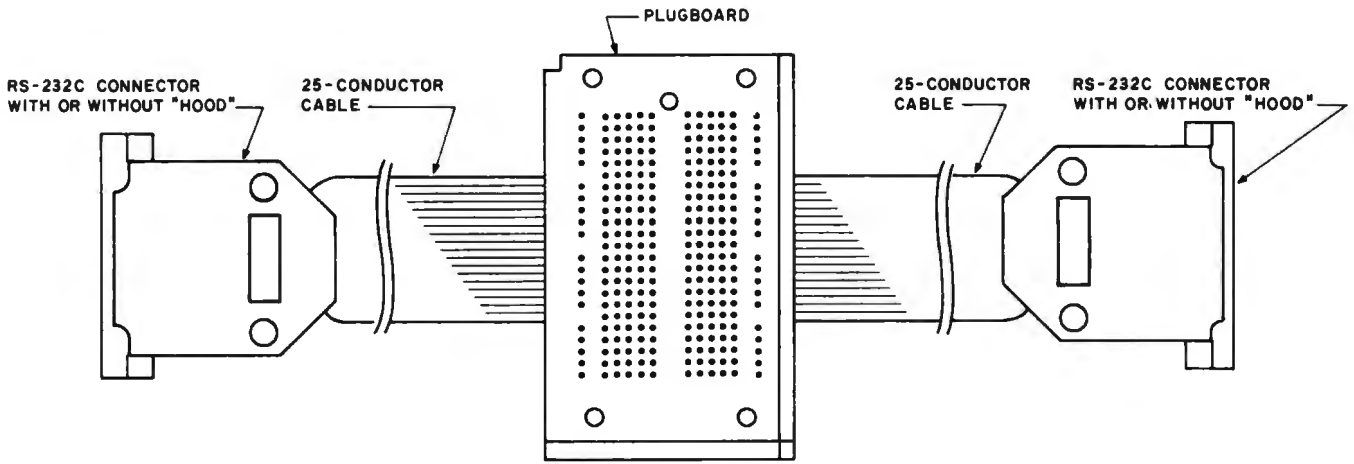

Figure 8: The data-communications plugboard uses a prototype board to "break out" the 25 lines of an RS-232C cable. This permits lines to be swapped, jumpered, or tested.

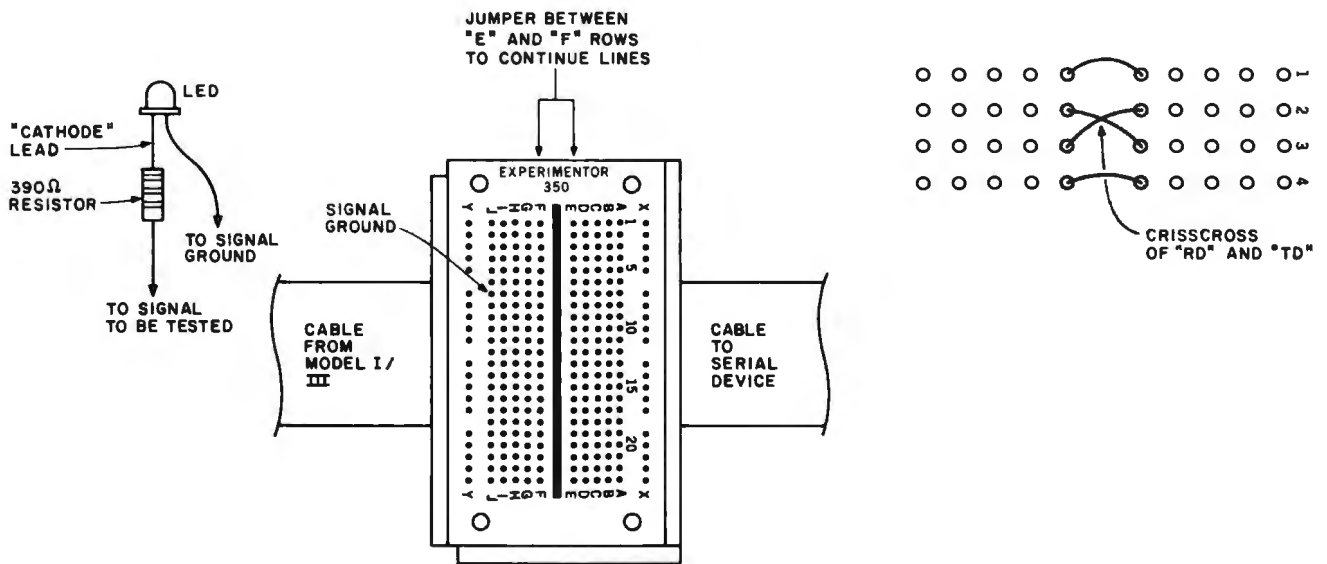

Figure 9: To run all lines straight through, jumper each row from the "E" to "F" points. Lines may be easily swapped. An LED with series resistor can be used to test the state of any of the lines on either the input or output side.

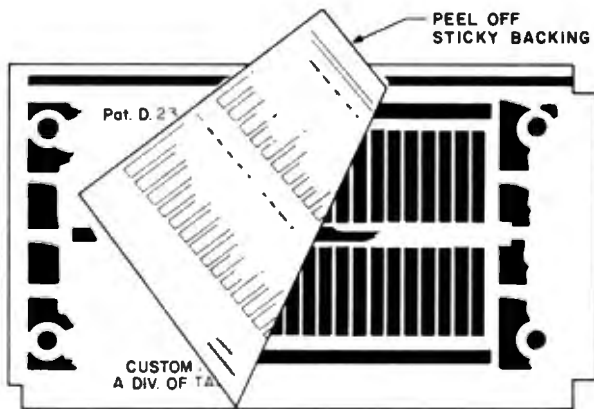

Figure 10: Peel away the backing of the prototype board to expose the foil paths for soldering.

interconnecting strips, as shown in figure 10. The rows are numbered from 1-23 on the front of the board.

You'll need two RS-232C connectors. Get the solder type, not the insulation displacement type. Unfortunately, Radio Shack sells only the latter type. Use the proper plug combinations for the equipment you'll be interfacing. Modems, for example, generally have a female RS-232C connector, requiring a male connector on the cable.

Although the connector pins are numbered, the numbering is often difficult to see unless you hold the connector at the right angle with the right light. Standard numbering for RS-232C connectors, looking in to the connector, is shown in figure 11.

Obtain a 25-wire ribbon cable (Radio Shack catalog #278-771 is a 40-conductor cable that can be split). Wire the ribbon cable so that the wire positions correspond to

ON DEMAND FOUR WHEEL DRIVE.

MAXIMUM TRACTION.

The only cars in America you can switch into four wheel drive without stopping are made by Subaru.

All other 4WD's, without exception, require a full stop before switching. But with *On Demand Four Wheel Drive*, the instant you need extra traction and safety, you simply flick the lever.

And immediately you go from full time Front Wheel Drive to Four Wheel Drive. (For tougher going, certain models offer a dual range gear box). Only Subaru gives you the advantages of both Front Wheel Drive and 4WD in one road hugging car.

Our Hatchback, Wagon and Brat are also great performers in other ways as well. Like:



Great gas mileage. Our entire line of 4WD's, for instance, is #1 among all 4WD cars in fuel economy.



IN MINIMUM TIME.

Low sticker price. We offer the lowest priced 4WD car in America. In fact, our 4WD's actually cost less than many cars with conventional 2 wheel drive.

Optimum options. The Hill-Holder™, a device on certain models that prevents drifting back on steep hills. Power windows.** Power steering.** Stereo/cassette. Cruise control.

Terrific value. For all of the above reasons, and many more, Subaru delivers maximum value per dollar. Not to mention independent suspension on all 4 wheels, rack and pinion steering and power assist front disc brakes as standard equipment.

Also standard are two features that come with every Subaru: reliability and durability. And you don't have to demand them. We do.

SUBARU
INEXPENSIVE. AND BUILT
TO STAY THAT WAY.



*1984 EPA ESTIMATES FOR OUR 4WD HATCHBACK. USE EST. MPG FOR COMPARISONS. YOUR MILEAGE MAY DIFFER DEPENDING ON DRIVING SPEED, WEATHER, CONDIION AND TRIP LENGTH. ACTUAL HWY MILEAGE WILL PROBABLY BE LESS. **AVAILABLE ON CERTAIN MODELS. © SUBARU OF AMERICA, INC. 1987

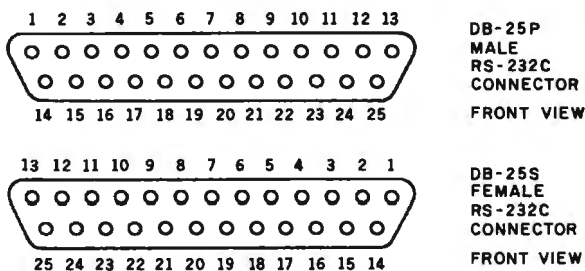

Figure 11: Standard RS-232C connector-pin numbering.

the RS-232C pin numbers on both RS-232C connectors. This will involve separating the cable into two halves, as shown in figure 12.

Cut the RS-232C cable in half. Separate the wires on both cut ends of the cable and strip each wire with a wire stripper about 1/16 inch.

Solder 23 wires onto the 23 rows of the board. Match the row number with the RS-232C pin number. Solder the twenty-fourth wire (pin 24) to the vertical strip on each side of the board. Cut off the twenty-fifth wire. This signal is undefined in the RS-232C specification (see figure 13).

Using 20-gauge wire, connect opposing pins for those lines that are not to be changed. The wire will fit nicely into the plugboard holes and stay there. Only the Model I/III signals shown in table 1 need to be connected in this manner. None of the others are used.

You're now set to experiment with the programming examples below or to use the plugboard to help connect serial devices to your system.

RS-232C Programming Examples

The examples below are in BASIC. They can be converted to Z80 assembly language by substituting INs and OUTs for the BASIC INPs and OUTs. I don't have the space to show you complete serial printer or communications drivers, but these examples should take the mystery out of RS-232C interfacing.

Setting RTS, DTR, and break. RTS and DTR lines are outputs from the RS-232C controller indicating "request to send" and "data terminal ready." The RTS line (pin 4) is set by:

```
100 OUT 232,0      'initialize RS-232C
110 OUT 234,xxxxxx1 'binary value with lsb set
```

(The "xxxxxx1" indicates that bit 0 must be set; other bits should be set or reset appropriately, as well.)

The DTR line (pin 20) is set similarly:

```
100 OUT 232,0      'initialize RS-232C
110 OUT 234,xxxxxx1x 'binary value
```

If both RTS and DTR are to be set, the binary value would be xxxxxx11.

The "break" does not come out on the RS-232C connector, but enables or disables the TD line. Use a 1 to enable the TD line:

```
100 OUT 232,0      'initialize RS-232C
110 OUT 234,xxxxxx1xx 'enable TD
```

Use the above code and experiment with the plugboard by connecting an LED and 390-ohm resistor between pin 7 of the plugboard and pin 4 or 20. Remember, logic 1 is -12 V DC and logic 0, +12 V DC.

Reading CTS, DSR, CD, and RI. These inputs to the RS-232C controller indicate clear to send, data set ready, carrier detect, and ring indicator. To read the lines, do:

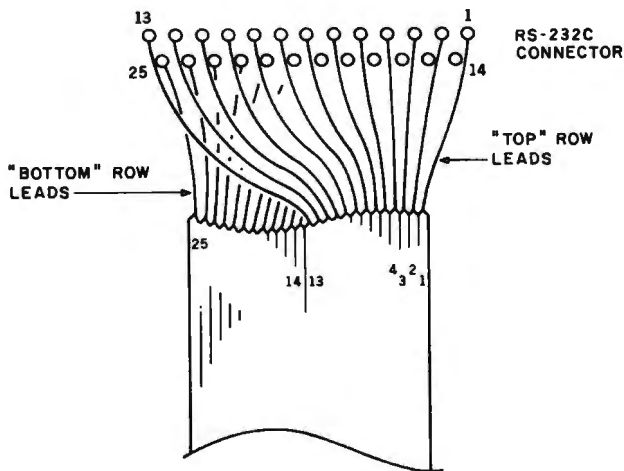

Figure 12: Wiring the ribbon cable. The wiring is nonstandard compared to most RS-232C cables and correlates the RS-232C pin numbers with the conductor-position numbering.

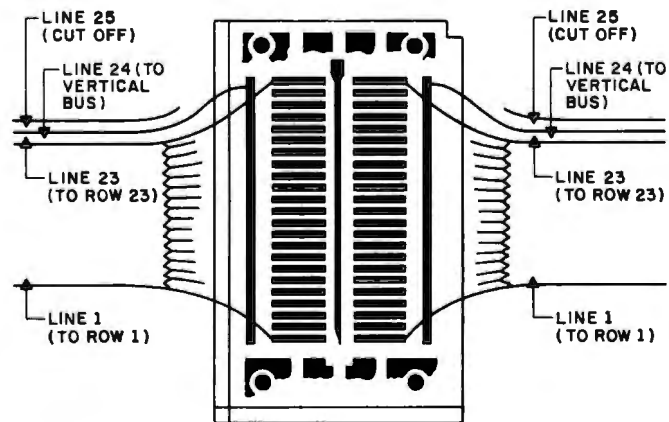

Figure 13: Solder the cable to the prototype board. Twenty-three lines are soldered to rows 1-23. The twenty-fourth line is soldered to the vertical column. The twenty-fifth line, not used, can be cut off.

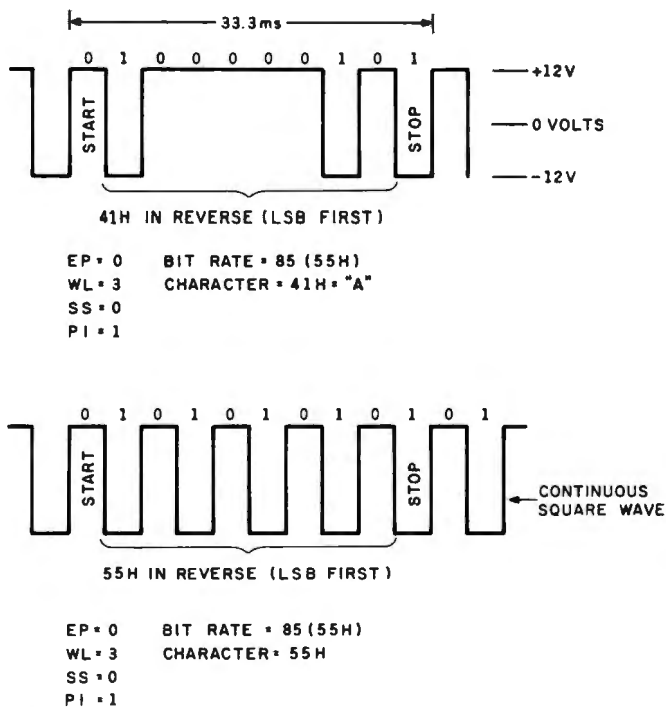

Figure 14: The data out exerciser program produces TD output that can be examined with an oscilloscope. The serial bit stream can be easily read. Outputting a hexadecimal 55 character produces a continuous square wave due to the alternating 1s and 0s.

```
100 OUT 232,0      'initialize RS-232C
110 A=INP(232)    'read lines
```

The A variable will contain a binary value corresponding to CTS, DSR, CD, and RI in the most significant 4 bits; the lower 4 bits are not significant.

You can experiment by first setting RTS or DTR and jumpering on the plugboard between the RTS or DTR pins to the four input lines. Jumpering is usually the easiest way to "dummy up" a signal, either by connector wiring or, in this case, on the plugboard.

Setting SUN, STD, and SRTS. These secondary lines are not normally used in communications programs, but they can be set by:

```
100 OUT 232,0      'initialize RS-232C
110 A=INP(233)    'toggle CRL flip-flop
120 OUT 234,xxUTRxxx 'set SUN, STD, SRTS
130 A=INP(233)    'toggle CRL
```

In line 120, bits 5, 4, and 3 control the status of SUN, STD, and SRTS, respectively. The INP(233) toggles the control-register load flip-flop so that the control register is not loaded.

Outputting on TD. The BASIC code in listing 1 shows a continuous output of a specified character. If you have an oscilloscope, connect it between pin 7 (SGND) and pin 2 (TD), and observe the output.

Listing 1: This simple BASIC program will continuously output data on the TD line at user-defined bit rates and formats.

```
90 'SERIAL DATA OUT EXERCISER
100 OUT 232,0
105 PRINT "INPUT EP, WLS, SSB, PI"
110 INPUT EP,WL,SS,PI
120 WD=EP*128+WL*32+SS*16+PI*8+4
130 OUT 234,WD
135 INPUT "BAUD CODE";BA
150 OUT 233,BA
160 INPUT "CHARACTER CODE";CH
165 I=0
170 A=INP(234)
180 IF (A AND 64)=0 THEN GOTO 170
185 I=I+1
190 OUT 235,CH
200 GOTO 170
```

Listing 2: This loop-back exerciser program in BASIC outputs data that is immediately input through the RD line. Pins 2 and 3 of the RS-232C lines should be jumpered together.

```
90 'LOOP BACK EXERCISER
100 OUT 232,0
105 PRINT "INPUT EP, WLS, SSB, PI"
110 INPUT EP,WL,SS,PI
120 WD=EP*128+WL*32+SS*16+PI*8+4
130 OUT 234,WD
135 INPUT "BAUD CODE";BA
150 OUT 233,BA
160 INPUT "CHARACTER CODE";CH
165 I=0
170 A=INP(234)
180 IF (A AND 64)=0 THEN GOTO 170
185 I=I+1
190 OUT 235,CH
200 A=INP(234)
210 IF (A AND 128)=0 THEN GOTO 170
220 A=INP(235)
230 PRINT A
240 GOTO 170
```

The EP, WL, SS, and PI inputs define even/odd parity, word length, number of stop bits, and parity inhibit, respectively. This format data is sent to the control register by the "OUT 234,WD".

The bit-rate code (see table 2) is sent to the BRG by the "OUT 233,BA".

The character value (CH) is the decimal code for the character to be sent. The value must be in a range of 0-255. ASCII "A," for example, is decimal 65.

The loop at 170-200 continuously checks the THREE status. If the transmitter holding register is empty, it outputs the character to the transmitter holding register by an "OUT 235,CH".

Figure 14 shows oscilloscope waveforms for CH=65

Birth of a legend.



Epson.

A whole new generation of Epson MX printers has just arrived. And while they share the family traits that made Epson famous — like unequalled reliability and ultra-fine printing — they've got a lot more of what it takes to be a legend.

For instance, they've got a few extra type styles. Sixty-six, to be exact, including italics, a handy subscript and superscript for scientific notation, and enough international symbols to print most Western languages.

What's more, on the new-generation MX-80, MX-80 F/T and MX-100, you get GRAFTRAX-Plus dot addressable graphics. Standard. So now you can have precision to rival plotters in a reliable Epson printer. Not to mention true backspace, software printer reset, and programmable form length, horizontal tab and right margin.

All in all, they've got the features that make them destined for stardom. But the best part is that beneath this software bonanza beats the

Uh..three legends.

heart of an Epson. So you still get a bidirectional, logical seeking, disposable print head, crisp, clean, correspondence quality printing, and the kind of reliability that has made Epson the best-selling printers in the world.

All of which should come as no surprise, especially when you look at the family tree. After all, Epson *invented* digital printers almost seventeen years ago for the 1964 Tokyo Olympics. We were

the first to make printers as reliable as the family stereo. And we introduced the computer world to correspondence quality printing and disposable print heads. And now we've given birth to the finest printers for small computers on the market.

What's next? Wait and see. We're already expecting.

EPSON
EPSON AMERICA, INC.

3415 Kashiwa Street • Torrance, CA 90505 • (213) 539-9140

FEATURE	ORIGINAL MX-80	GRAFTRAX-80*	ORIGINAL MX-100	MX-80 with GRAFTRAX-Plus	MX-80 F/T	MX-100
Bidirectional printing	X	X	X	X	X	X
Logical seeking function	X	X	X	X	X	X
Disposable print head	X	X	X	X	X	X
Speed: 80 CPS	X	X	X	X	X	X
Matrix: 9 x 9	X	X	X	X	X	X
Selectable paper feed			X		X	X
PAPER HANDLING FUNCTIONS						
Line spacing to n/216		X		X	X	X
Programmable form length	X	X	X	X	X	X
Programmable horizontal tabs	X	X	X	X	X	X
Skip over perforation			X	X	X	X
PRINT MODES AND CHARACTER FONTS						
96 ASCII characters	X	X	X	X	X	X
Italics character font		X		X	X	X
Special international symbols				X	X	X
Normal, Emphasized, Double-Strike, and Double/Emphasized print modes	X	X	X	X	X	X
Subscript/Superscript print mode				X	X	X
Underline mode				X	X	X
10 CPI	X	X	X	X	X	X
5 CPI	X	X	X	X	X	X
17.16 CPI	X	X	X	X	X	X
8.58 CPI	X	X	X	X	X	X
DOT GRAPHICS MODE						
Line drawing graphics				X	X	X
Bit image 60 D.P.I.		X	X	X	X	X
Bit image 120 D.P.I.		X	X	X	X	X
CONTROL FUNCTIONS						
Software printer reset		X		X	X	X
Adjustable right margin			X	X	X	X
True back space		X		X	X	X
INTERFACES						
Standard — Centronics-style 8-bit parallel	X	X	X	X	X	X
Optional — RS-232C current loop w/2K buffer	X	X	X	X	X	X
RS-232C x-on/x-off w/2K buffer	X	X	X	X	X	X
IEEE-488	X	X	X	X	X	X

*Tandy TRS-80 block graphics only available with GRAFTRAX 80.

ABCDEFGHIJKLMNOP abcdefghi jklmn ABCDEFGHIJKLMNOP abcdefghi jklmn 01234
 ABCDEFGHIJKLMNOP abcdefghi jklmn ABCDEFGHIJKLMNOP abcdefghi jklmn 01234
 ABCDEFGHIJKLMNOP abcdefghi jklmn ABCDEFGHIJKLMNOP abcdefghi jklmn 01234
 ABCDEF abcdef ABCDEF abcdef 0123456
 ABCDEFGHIJKLMNOPQRSTUVWXYZ abcdefghi jklmnopqrstuvwxyz ABCDEFGHIJKLMNOPQRSTUVWXYZ abcdefghi jklmnopqrstuvwxyz 01234567
ABCDEF abcdef ABCDEF abcdef 0123456
 ABCDEFGHIJKLMNOP abcdefghi jklmn ABCDEFGHIJKLMNOP abcdefghi jklmn 01234
 ABCDEFGHIJKLMNOPQRSTUVWXYZ abcdefghi jklmnopqrstuvwxyz ABCDEFGHIJKLMNOPQRSTUVWXYZ abcdefghi jklmnopqrstuvwxyz 01234567

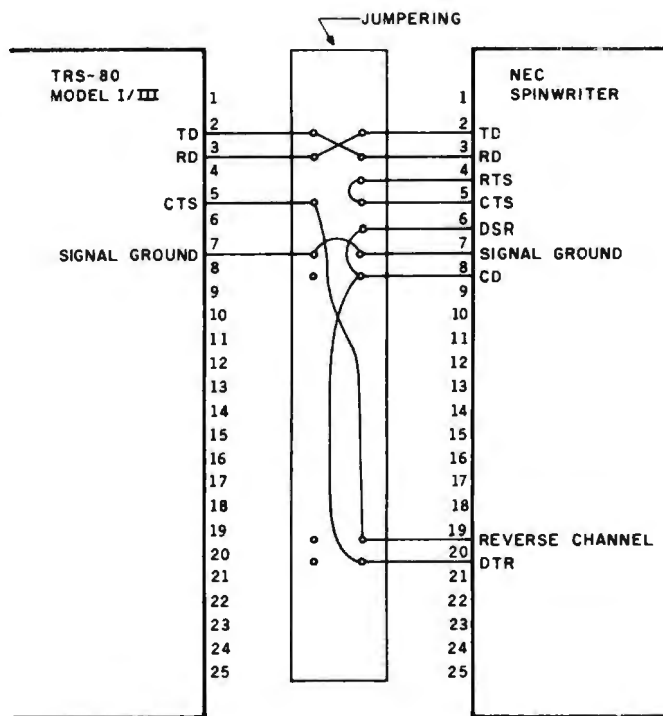

Figure 15: This typical RS-232C jumpering connects an NEC Spinwriter to the Model I/III. Various Spinwriter lines must be "dummied up" to fool the Spinwriter into thinking it has received the proper signals. The "reverse channel" line permits 1200-bit operation.

and CH=85 with no parity bit, 1 stop bit, 8 data bits, and 300 bps. This BASIC loop keeps up quite well with the 30 character-per-second rate. Setting the bit rate to 600 (BA=102) resulted in a throughput of 41 cps (not 60, because of the BASIC overhead). It is feasible to drive a line printer in BASIC.

The last application is shown in listing 2. This is a loop-back test in which the TD line output is jumpered back to the RD (pin 3) line input. The character sent out comes right back in on the RD line. This technique is common for testing an RS-232C interface locally. Jumper the two lines by a short wire between pins 2 and 3 on the plugboard.

Connecting Serial Devices

So many serial devices are available that it's hard to generalize about proper RS-232C cable configurations to drive the devices. A typical configuration that can be set up by the plugboard is shown in figure 15. This connects the NEC Spinwriter to the Model I or III and allows transfer rates up to 1200 bps.

Read the interfacing requirements for the serial device to be used with your Model I or III, use the plugboard to test line conditions, and possibly even use some of the code provided above. This method should facilitate interfacing to non-Radio Shack RS-232C equipment—and help you realize the benefits implicit in the advertising slogan, "RS-232C compatible." ■

	OUR SPECIAL CASH PRICE
SSM PB-1 2708/2716 programmer A & T	199.00
Votrax Type N Talk A & T	315.00
Seattle Computer CPU Support Board A & T	263.00
Imsai I-8080, 22 slot M/F w/front panel no MPU-A	A & T 607.00
North Star Horizon 20-64K	A & T 2629.00
Qume DT-8 DSDD Bare 8" drive	515.00
Shugart SA 400 SSDD 5 1/4" bare drive	199.00
3 M (Scotch) Head cleaning kit	16.00
Godbout RAM-21-128K Static A & T	1271.00
Cromemco SDI Graphics Board A & T	675.00
SMS 64K CMOS Static A & T Unkit	450.00
Morrow Designs Discus 2D Dual drive system 8"	1379.00

Subject to Available Quantities • Prices Quoted Include Cash Discounts. Shipping & Insurance Extra.

We carry products from all Major Manufacturers

14425 North 79th Street, Suite B
Scottsdale, Arizona 85260
Sales 800-528-3138
Technical 602-991-7870
Est. 1977

Now Available COMPUSTAR SUPERBRAIN ◉ SUPERBRAIN 5MB

East Coast **DEALERS & OEM's** wanted

Kramer Systems International, Inc. is an authorized established distributor for the complete Intertec Data Systems Product line. We have a proven record of providing full support and services to all of our customers.

COMPUSTAR
Model 10
Model 20
Model 30
Model 40

DISC STORAGE SYSTEMS
10 MB
32 MB
36 MB

SUPERBRAIN
SUPERBRAIN QD
SUPERBRAIN 5MB

SOFTWARE
BASIC 80
BASIC Compiler
COBOL-80
FORTRAN-80
Accounts Payable
Accounts Receivable
General Ledger
Payroll
Word Star
Mail Merge
Data Star
Super Sort
Word Master
Spell Star

FANTASTIC DISCOUNTS AVAILABLE

MAINTENANCE & SUPPORT

On-site maintenance in the Greater Washington area and selected areas throughout the east coast.
Modular replacement available to all customers with 48 hour response in most cases.
Our maintenance personnel are experienced knowledgeable professionals who have trained government and commercial technicians in the repair and maintenance of the Superbrain.

Kramer Systems International, Inc. has successfully installed hundreds of **COMPUSTARS**, **SUPERBRAINS** and **INTERTUBES** throughout the world.

Join the **WINNING TEAM** —
Fantastic opportunities exist **NOW!!!**

Call or Write
KRAMER SYSTEMS INTERNATIONAL, INC.
8103 Dixon Avenue
Silver Spring MD 20910
301-585-7480

1-UPMANSHIP.



We opened our doors with two basic goals:

To distribute as many software packages to as many dealers as possible.

And to make money doing so.

Our success on both counts is the result of hard work, a positive business attitude and a recognition that you, as a retailer, have a right to be treated fairly and honestly by your distributor.

We're 1-up for three good reasons:

1. We always offer a wide selection of the latest and best microcomputer software packages available anywhere. (Why should you have to hunt for what you need?)
2. Our dealer discounts start with quantities of 1. (Remember all those times you just wanted one or two to see how they'd sell?)
3. We don't play The BackOrder Game. (If we can't ship your order within 48 hours we'll let you know, instead of hanging you out to dry.)

If there's anything else we can do for you, just let us know. Because we're 1-up and we intend to stay that way.

Software Distributors, 9929 Jefferson Blvd., Culver City, CA 90230. Telex 4990032 BVHL, ATT: SOFT

For our dealer info package, call (213) 559-9330.

SOFTWARE DISTRIBUTORS

We won't leave you holding the bag.

Programming the Critical-Path Method in BASIC

This program helps managers assess trade-offs of time and costs.

Steven Zimmerman
Professor of Management
College of Business
and Management Studies
University of South Alabama
Mobile, AL 36688

Leo M. Conrad
Imagineering Concepts
POB 9843
Mobile, AL 36691-0843

The critical-path method (CPM) is a project-scheduling tool that has won wide acceptance in the construction industry. (Do not confuse this with the CP/M operating system.) CPM has proved its usefulness on both large and small jobs.

CPM resembles PERT, the performance evaluation and review technique described in the May 1982 BYTE, page 465. Both of them use network diagrams to analyze projects. PERT, developed to help manage complex research and development projects, uses statistical methods to estimate the time needed to complete such an innovative project, which must be to some degree unpredictable. CPM, however, seeks to determine how to minimize the time required to do routine construction and maintenance. Since these activities are routine, CPM assumes that its users can provide reliable estimates of how long each activity will require. CPM helps determine the optimal trade-off of a project's total cost and the total time required for com-

pletion. It also tries to produce a project schedule that minimizes both direct and indirect costs. (An example of an indirect cost is the production time lost while a manufacturing plant is closed for maintenance.)

CPM helps determine the optimal trade-off of a project's cost and the time required for completion.

CPM analysis of a project has the key feature of allowing computations based on both operation at normal time and cost and operation at crash time and cost. Normal time is the amount of time an activity will take under normal conditions; normal cost is the cost of proceeding in this manner. Crash time is the reduced time in which an activity could be completed if extra resources and costs were applied. Crash cost is the total cost necessary to get the job done faster.

The objective of CPM is to find the critical path through a project under normal conditions and under various degrees of crash conditions. The critical path is defined as the sequence of steps that takes the longest time to complete from the beginning of a project to its end. In the case of normal time and cost, the crew scheduled to do a task is of normal size and is not supplemented by either second shifts or overtime. In the case of crash time and cost, the project uses extra people or a second shift. Put simply, crash operations involve spending extra dollars to speed up a project.

The differences between CPM and PERT sometimes escape notice. This is partly because some users have combined the most useful aspects of the two techniques. Our approach to CPM in this article is a classic approach. Because our TRS-80 Model I system contains only 32K bytes of RAM (random-access read/write memory), combining the approaches in a BASIC program was not possible. We also wanted to illustrate the

differences between CPM and PERT.

In practice, CPM and PERT can be applied to many of the same projects. Examine the differences in input and output required by our PERT program in the May issue and this CPM program before you decide which method to use on a project. We have found both programs useful.

We will describe the fundamentals of CPM analysis before presenting a BASIC program that implements CPM.

CPM Analysis

As with PERT, CPM analysis of a project requires first reducing the project to a list of events and activities. (An activity is a part of a project that consumes resources or time, and whose beginning and end can both be defined. An event is a point in time, an instant. Both the beginning and the ending points of an activity are events.) To apply CPM, you must identify all the events needed to complete the project and all the activities that result in the identified events.

Our sample project in this article will be the same one we used previously for PERT—a real construction project that was recently completed. We simplified things by ending our example with the completion of the building's foundation. We identified 18 activities needed to complete this foundation. Table 1 lists the activities, assigned letters A-Q and Z. Each event in the project consists of the completion of one or more activities.

The Bubble Diagram

The second stage in CPM analysis is the layout of a bubble diagram like the one in figure 1. The diagram shows how the necessary activities and events in a project form a sequence of steps. Most contractors specify the sequence of tasks in a project in some fashion. Like PERT, CPM makes a formal activity of task sequencing, which lends valuable structure to planning. In particular, making a bubble diagram forces the planner to specify which activities depend on the completion of other activities.

Letter	Activity	Beginning Event	End Event
A	Assemble accounting data	1	2
B	Look for bank	1	3
C	Look for realtor	1	4
Z	Seek permits	2	7
D	Make market study of area	2	3
G	Look for contractor	2	5
F	Seek insurance for construction	2	6
H	Get basic architectural plans	3	5
E	Make cost study	3	4
I	Buy land	4	5
J	List materials	5	6
K	Get more detailed architectural plans	5	7
L	Have survey made	5	8
M	Buy first batch of materials	6	8
O	Buy second batch of materials	6	9
N	Complete detailed internal layout of foundation	7	8
Q	Hire crew	7	9
P	Build foundation	8	9

Table 1: The activities required to build a foundation. The program in listing 1 uses the letters at the left to identify the activities. The two columns at the right list the first event and the last during each activity. An event is defined as the completion of one or more activities.

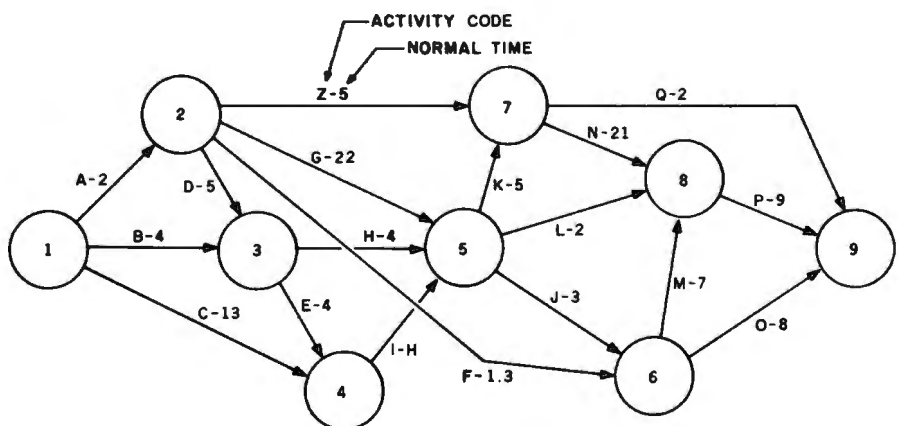

Figure 1: The CPM network diagram of the activities required to build a foundation. Each circle represents an event; each line between circles represents one of the activities listed in table 1. The letter on each line is the code identifying an activity; the number following each letter is the normal time for completing the activity. The network has one initial event, event 1 at the extreme left, and one terminal event, event 9 at the extreme right. A path is any set of successive activities that begin with event 1 and end with event 9. The critical path is the path whose sum of activity times is longer than that for any other path through the network.

Diagrams like that shown in figure 1 are also called networks. A CPM network has one initial event, at the extreme left, and one terminal event, at the extreme right. Figure 1 is the bubble diagram of our example, the building of a foundation. The circles are numbered and represent events.

The lines are lettered and represent activities. Each line has an arrow indicating its direction in time, from beginning to completion. The network as a whole shows the series of activities needed to complete the project. The arrows show which activities and events logically precede others.

As noted in the PERT article, an event that results from completion of more than one activity is called a merge event. An event that represents the joint beginning of more than one activity is called a burst event. Before any activity can start, all the activities preceding it must be completed (but they needn't be completed simultaneously). Both the length and the compass-direction of an arrow are without significance.

Dashed lines in network diagrams represent "dummy" activities, but we didn't include any dummy activities in this project. Dummy activities arise when the completion of one event depends upon the completion of another, but requires no additional work or activity.

In the bubble diagram, the line going from 1 to 2 means that in order to complete event 2 (complete accounting papers), it is necessary to collect and organize the accounting data. Line 1-2 represents an activity; bubble 2 represents an event.

Applying CPM

The longest route from the beginning of the network on the left to the

end of the network on the right determines the amount of time required to complete the project. This line, the critical path, determines the minimum time required to complete a job.

Identification of the critical path for both normal time and cost operations and crash time and cost operations is the prime objective of CPM. If normal time is such that the project can be completed on time, there is no need to go to crash time. If the project cannot be completed within the critical path of the full crash time, all activities—both on and off the critical path—run under crash conditions. That's when you have some real problems. If the scheduled time falls between the normal-time critical path and the full-crash-time critical path, you can selectively crash the project by spending the extra dollars to get the job completed on time.

In CPM, it is assumed that normal activity levels will result in a higher overall time at lower costs than crash condition operations. It is further assumed that for every dollar spent to reduce the amount of time required to do an activity there is a set reduction

in the time required. In other words, a linear relationship exists between time saved and cost.

You can run the system under normal conditions, at full crash conditions, or at selective crash conditions. In practice, it makes little sense to run the system under full crash conditions. The objective of CPM is to identify situations where it pays to use available resources. It does *not* pay to run at full crash. Selective crashing will complete the job in the same time at lower cost than full crashing.

Program Output

Our CPM program appears in listing 1. Its output is relatively complex, including verification of all the input data, the selective time, early start time, early finish time, latest start time, latest finish time, and slack time for all the activities in the network. In addition, the program identifies the critical path, the time of the critical path, the cost of the critical path, the incremental cost, the normal time/cost of the critical path, and the full crash time/cost of the critical path.

Text continued on page 384

Listing 1: A program for CPM, the critical-path method. Written in TRS-80 Level II BASIC, the program asks for a list of the activities in a project, the beginning and ending events of each activity, its normal time, normal cost, crash time, and crash cost.

```

10 CLEAR 1000:CLS:REM "CPM"
20 PRINT"CPM NORMAL AND CRASH TIME/COST"
30 PRINT"DEVELOPED BY STEVEN M. ZIMMERMAN,PH.D. & LEO M. CONRAD 1980"
40 INPUT"DISK SYSTEM OR LEVEL II BASIC (D/B)";S$
50 PRINT:PRINT"*** NOTE BEGINNING EVENTS WILL BE SORTED NUMERICAL ORDER ****"
:INPUT"DIMENSION FOR ACTIVITIES";D$:PRINT
60 DIM A$(D$,2),A(D$,13),SV(12)
70 PRINT"INPUT MENU"
80 PRINT" K KEYBOARD"
90 PRINT" D DISK FILE"
100 PRINT" R READ STATEMENT"
110 PRINT" T1 TAPE RECORDER #-1"
120 PRINT" T2 TAPE RECORDER #-2"
130 INPUT"SELECTION";IO$
140 IFIO$<>"K"THEN 220
150 INPUT"NUMBER OF ACTIVITIES";M%:EE=0
160 PRINT"IF THIS IS GOING TO BE WORK YOU MUST NOW INPUT UP TO ";M%;"
ACTIVITIES"
170 FOR I=1 TO M%
180 INPUT"ACTIVITY CODE ";A$(I,1)
190 INPUT"DESCRIPTION, BEGINING EVENT NUMBER, END EVENT NUMBER, NORMAL TIME,
COST AND CRASH TIME, COST";A$(I,2),A(I,1),A(I,2),A(I,3),A(I,4),A(I,5),A(I,6)
200 NEXTI
210 GOTO480
220 IFIO$="T1"ORIO$="T2"THEN230 ELSE330

```

Listing 1 continued:

```
230 PRINT"SETUP TAPE #-"; IO$;" TO PLAY":REM TAPE INPUT
240 IF S$="D"CMD"T"
250 IFIO$="T1"INPUT#-1,M%,EE
260 IFIO$="T2"INPUT#-2,M%,EE
270 FORI=1TOM%
280 IFIO$="T1"INPUT#-1,A$(I,1),A$(I,2):INPUT#-1,A(I,1),A(I,2),A(I,3),A(I,4),A(I,
5),A(I,6)
290 IFIO$="T2"INPUT#-2,A$(I,1),A$(I,2):INPUT#-2,A(I,1),A(I,2),A(I,3),A(I,4),A(I,
5),A(I,6)
300 NEXTI
310 IFS$="D"CMD"R"
320 GOTO480
330 IFIO$<>"D"THEN420
340 LINEINPUT"NAME OF FILE:DISK ";B$:REM DISK INPUT
350 OPEN"I",1,B$
360 INPUT#1,M%,EE
370 FORI=1TOM%
380 INPUT#1,A$(I,1),A$(I,2),A(I,1),A(I,2),A(I,3),A(I,4),A(I,5),A(I,6)
390 NEXTI
400 CLOSE1
410 GOTO480
420 IFIO$<>"R"THEN70
430 READM%,EE
440 FORI=1TOM%:REM READ INPUT
450 READA$(I,1),A$(I,2),A(I,1),A(I,2),A(I,3),A(I,4),A(I,5),A(I,6)
460 IFA$(I,1)="END"THEN480
470 NEXTI
480 REM PRINTS INPUT DATA FOR VARIFICATION
490 M=M%:TP=0:FORI=1TOM:IFA(I,2)>TPTHENTP=A(I,2)
495 NEXT:EE=TP
500 FORI=1TOM-1
510 FORJ=I+1TOM
520 IFA(I,1)<=A(J,1)THEN550
530 FORK=1T012:SV(K)=A(I,K):A(I,K)=A(J,K):A(J,K)=SV(K):NEXTK
540 FORK=1T02:SV$(K)=A$(I,K):A$(I,K)=A$(J,K):A$(J,K)=SV$(K):NEXTK
550 NEXTJ,I
560 XX=5:PRINT"VERIFICATION OF INPUT"
570 Z1$="CODE DESCRIPTION TIME EARLY EARLY LAST LAST SLACK"
580 Z2$=" USED START FIN START FIN TIME"
590 Z3$="CODE DESCRIPTION BEGIN END NORMAL CRASH"
600 Z4$=" EVENT EVENT TIME COST TIME COST"
610 PRINT"NO ";Z3$
620 PRINT" ";Z4$
630 K=0
640 C4$="### "
650 FORI=1TOM%
660 PRINTUSINGC4$;I;
670 C1$="#### "
680 C2$="% % % %":C3$="####.##"
690 PRINTUSINGC2$;A$(I,1),A$(I,2);
700 FORJ=1T02
710 PRINTUSINGC1$;A(I,J);:NEXTJ
720 FORJ=3T06
730 PRINTUSINGC3$;A(I,J);:NEXTJ
740 K=K+1:IFK>=13 THENPRINT:INPUT"ENTER TO PAGE";DU$:K=0
750 PRINT:NEXTI
760 INPUT"-2 TO ADD, -1 TO CONTINUE OR NUMBER TO CHANGE";L:IFL=-1THENB10
770 IFL<>-2THEN790
780 L=M%+1:M%=L:N%=N%+1
790 INPUT"INPUT CODE, DESCRIPTION, BEGINING EVENT NUMBER, END EVENT NUMBER
, NORMAL TIME, COST AND CRASH TIME AND COST";A$(L,1),A$(L,2),A(L,1),A(L,2),A(L,3
),A(L,4),A(L,5),A(L,6)
800 GOTO480
810 INPUT"HARD COPY OF INPUT DATA (Y/N)";P$
820 IFP$<>"Y"THEN960
830 INPUT"TITLE";T$:LPRINT"TITLE: ";T$
```

Listing 1 continued on page 382

Listing 1 continued:

```
840 INPUT"DATE";T$:LPRINT"DATE: ";T$
850 LPRINT"NO ";Z3$
860 LPRINT" ";Z4$
870 FORI=1TOM%
880 LPRINTUSINGC4$;I;
890 LPRINTUSINGC2$;A$(I,1),A$(I,2);
900 FORJ=1T02
910 LPRINTUSINGC1$;A(I,J);:NEXTJ
920 FORJ=3T06
930 LPRINTUSINGC3$;A(I,J);:NEXTJ
940 LPRINT" "
950 NEXTI
960 REM NOW THE WORK BEGINS BEGINING EVENT IS 1 EARLY START =0 FOWARD PASS
970 INPUT"NORMAL TIME OR FULL CRASH TIME (N/C)";NC$:IFNC$<>"N"ANDNC$<>"C"THEN970

980 FORI=1TOM%:IFNC$="N"THENA(I,7)=A(I,3)
990 IFNC$="C"THENA(I,7)=A(I,5)
1000 NEXTI
1010 FORI=1TOM%
1020 IFA(I,1)=1THENA(I,8)=0:A(I,9)=A(I,7):GOTO1100
1030 MAX=0.0
1040 FORJ=1TOM%
1050 IFA(J,2)<>A(I,1)THEN1080
1060 IFA(J,9)>MAXTHENMAX=A(J,9)
1070 A(I,8)=MAX
1080 NEXTJ
1090 A(I,9)=A(I,8)+A(I,7)
1100 NEXTI
1110 REM BACKWARD PASS
1120 XM=0.0
1130 FORI=M%T01STEP-1
1140 IFA(I,2)<>EETHEN1160
1150 IFXM<A(I,9)THENXM=A(I,9)
1160 NEXTI
1170 FORI=M%T01STEP-1
1180 IFA(I,2)=EETHENA(I,11)=XM:GOTO1250
1190 MIM=99999
1200 FORJ=M%T01STEP-1
1210 IFA(I,2)<>A(J,1)THEN1240
1220 IFA(J,10)<MIMTHENMIM=A(J,10)
1230 A(I,11)=MIM
1240 NEXTJ
1250 A(I,10)=A(I,11)-A(I,7)
1260 NEXTI
1270 REM SLACK VARIABLE CALCULATIONS
1280 FORI=1TOM%
1290 A(I,12)=A(I,11)-A(I,9)
1300 NEXTI
1310 K=0:REM PRINT OUTPUT
1320 PRINT"CODE DESCRIPTION USED EARLY EARLY LAST LAST SLACK"
1330 PRINT" TIME START FIN START FIN TIME"
1340 C5$="###.##"
1350 FORI=1TOM%
1360 PRINTUSINGC2$;A$(I,1),A$(I,2);
1370 FORJ=7T012
1380 PRINTUSINGC5$;A(I,J);:NEXTJ
1390 PRINT:K=K+1:IFK=13INPUT"ENTER TO PAGE";DU$:K=0
1400 NEXTI
1410 INPUT"HARD COPY OF RESULTS (Y/N)";P$:IFP$<>"Y"THEN1490
1420 IFNC$="C"LPRINT"FULL CRASH TIMER ANALYSIS"
1430 LPRINT" ":LPRINTZ1$:LPRINTZ2$
1440 FORI=1TOM%
1450 LPRINTUSINGC2$;A$(I,1),A$(I,2);
1460 FORJ=7T012
1470 LPRINTUSING"#####.##";A(I,J);:NEXTJ
1480 LPRINT" ":NEXTI
```

Listing 1 continued:

```
1490 PRINT"OUTPUT MENU"
1500 PRINT"      C      COST AND TIME OF CRITICAL PATH"
1510 PRINT"      D      DISK"
1520 PRINT"      E      END"
1530 PRINT"      R      RECYCLE"
1540 PRINT"      S      SELECTIVE CRASHING"
1550 PRINT"      T1     TAPE#-1"
1560 INPUT"      T2     TAPE#-2          SELECTION ";OP$:IFOP$="R"THEN480
1570 IFOP$<>"S"THEN1760
1580 IFNC$<>"N"INPUT"CAN NOT CRASH FROM FULL CRASH ENTER TO CONTINUE";DU$:GOTO1
490
1590 CLS:PRINT"SELECTIVE CRASHING -- STARTS FROM NORMAL RUN **":INPUT"NEW RUN (Y/
N)";DU$:IFDU$="Y"THENFORI=1TOM%:A(I,13)=0:A(I,7)=A(I,3):NEXTI
1600 PRINT"NO CODE DESCRIPTION      SELECT CRASH      UNIT      TOTAL"
1610 PRINT"                          TIME COST      COST      COST"
1620 J=0:FORI=1TOM%:IFA(I,13)=0ANDA(I,12)>.00001THEN1650
1630 X=(A(I,6)-A(I,4))/(A(I,3)-A(I,5)):PRINTUSINGC1$;I;:PRINTUSINGC2$;A$(I,1),A$
(I,2);:PRINTUSINGC3$;A(I,7),A(I,13),X,A(I,6)-A(I,4)
1640 J=J+1:IFJ=13THENJ=0:INPUT"ENTER TO PAGE";DU$
1650 NEXTI
1660 INPUT"-1 TO CONTINUE OR NUMBER TO CHANGE";IZ:IFIZ=-1THEN1700
1670 INPUT"CRASH DOLLARS OVER NORMAL DOLLARS";CD:X=A(IZ,3)-A(IZ,5):TS=CD/((A(IZ,
6)-A(IZ,4))/X):IFTS>XTHENTS=X:INPUT"WASTED MONEY -- ENTER TO CONTINUE";DU$
1680 A(IZ,13)=CD:A(IZ,7)=A(IZ,7)-TS:IFA(IZ,7)<A(IZ,5)THENA(IZ,7)=A(IZ,5):INPUT"O
VER CRASHED -- ENTER TO CONTINUE";DU$
1690 GOTO1600
1700 INPUT" HARD COPY (Y/N)";DU$:IFDU$="N"THEN1010
1710 LPRINT"NO CODE DESCRIPTION      SELECT CRASH      UNIT TOTAL"
1720 LPRINT"                          TIME COST      COST COST"
1730 J=0:FORI=1TOM%:IFA(I,13)=0ANDA(I,12)>.00001THEN1750
1740 X=(A(I,6)-A(I,4))/(A(I,3)-A(I,5)):LPRINTUSINGC1$;I;:LPRINTUSINGC2$;A$(I,1),
A$(I,2);:LPRINTUSINGC3$;A(I,7),A(I,13),X,A(I,6)-A(I,4):J=J+1:IFJ=13THENJ=0:INPUT
"ENTER TO CONTINUE";DU$
1750 NEXTI:GOTO1010
1760 IFOP$<>"C"THEN1910
1770 REM IDENTIFICATION OF CRITICAL PATH AND COSTS
1780 CO=0:PATH$=" ":CX=0:CY=0:CZ=0:CF=0:CW=0
1790 FORI=1TOM%:IFA(I,12)>.00001THEN1810:REM 0 DEFINED AS .00001 ...
1800 CO=CO+A(I,3):PATH$=PATH$+" "+A$(I,1):CX=CX+A(I,4):CY=CY+A(I,6):CZ=CZ+A(I,7)
:CP=CP+A(I,5):CW=CW+A(I,13)
1810 NEXTI:C6$="###,###,###.##":IFNC$="C"THENCW=CW-CX
1820 CLS:PRINT"CRITICAL PATH";:PRINTPATH$
1830 PRINT"TIME OF CRITICAL PATH ";CZ:PRINT"COST OF CRITICAL PATH ";CW+CX,"INCRE
MENTAL COST ";CW:PRINT"NORMAL TIME CRITICAL PATH ";CO
1840 PRINT"NORMAL COST OF CRITICAL PATH ";CX
1850 PRINT"FULL CRASH TIME OF CRITICAL PATH ";CP:PRINT"FULL CRASH COST OF CRITIC
AL PATH ";CY
1860 INPUT"HARD COPY (Y/N)";F$:IFF$<>"Y"THEN1490
1870 LPRINT" ":LPRINT"CRITICAL PATH ";PATH$
1880 LPRINT"TIME OF CRITICAL PATH ";CZ:LPRINT"COST OF CRITICAL PATH ";CW+CX,"INC
REMENTAL COST ";CW:LPRINT"NORMAL TIME OF CRITICAL PATH ";CO
1890 LPRINT"NORMAL COST OF CRITICAL PATH ";CX
1900 LPRINT"FULL CRASH TIME OF CRITICAL PATH ";CP:LPRINT"FULL CRASH COST OF CRIT
ICAL PATH ";CY:GOTO1490
1910 IFOP$="E"THENEND
1920 IFOP$<>"D"THEN1970
1930 LINEINPUT"NAME OF FILE:DISK ";X$:OPEN"O",1,X$
1940 PRINT#1,MZ,EE
1950 FORI=1TOM%:PRINT#1,CHR$(34);A$(I,1);CHR$(34);", ";CHR$(34);A$(I,2);CHR$(34);
A(I,1);A(I,2);A(I,3);A(I,4);A(I,5),A(I,6):NEXTI
1960 CLOSE1:GOTO1490
1970 IFS$="D"THENCMD"T"
1980 IFOP$="T1"PRINT#-1,MZ,EE:FORI=1TOM%:PRINT#-1,A$(I,1),A$(I,2):PRINT#-1,A(I,1
),A(I,2),A(I,3),A(I,4),A(I,5),A(I,6):NEXTI
1990 IFOP$="T2"PRINT#-2,MZ,EE:FORI=1TOM%:PRINT#-2,A$(I,1),A$(I,2):PRINT#-2,A(I,1
),A(I,2),A(I,3),A(I,4),A(I,5):NEXTI
```

Listing 1 continued on page 384

Listing 1 continued:

```
2000 IFS*="D"THENCMD"R"
2010 GOTD1490
2020 REM PUT DATA HERE FIRST # ACTIVITIES THEN ENDING EVENT NUMBER THEN CODE,
DESCRIPTION, BEGINING EVENT, ENDING EVENT, NORMAL TIME, COST AND CRASH TIME, COS
T FOR EACH ACTIVITY
2030 DATA18,9
2040 DATA A,ACCT. PAPERS,1,2,2,20,1,30
2050 DATA Z,PERMITS,2,7,5,50,4,80
2060 DATA B,SHOP BANKERS,1,3,4,40,3,60
2070 DATA C,SHOP REAL EST.,1,4,13,130,10,170
2080 DATA D,MARKET STUDY,2,3,4,40,3,50
2090 DATA G,CONTRACTOR,2,5,2.2,22,1.7,67
2100 DATA F,INSURANCE,2,6,1.3,13,.5,15
2110 DATA H,ART. PLANS,3,5,4,40,3,60
2120 DATA E,COST STUDY,3,4,4,40,3,50
2130 DATA I,LAND,4,5,11,110,10,130
2140 DATA J,MATERIAL,5,6,3,30,2,40
2150 DATA K,PLANS,5,7,5,50,2,120
2160 DATA L,SURVEY,5,8,2,20,1,40
2170 DATA M,BUY MAT #1,6,8,7,30,4,40
2180 DATA O,BUY MAT #2,6,9,8,20,5,50
2190 DATA N,LAYOUT,7,8,21,110,12,120
2200 DATA P,FOUNDATION,8,9,9,30,6,60
2210 DATA Q,HIRE CREW 2,7,9,2,20,1,30
```

Text continued from page 380:

You must use this information with care. It is possible—and usual—for the critical path to switch around as selective crashing is applied. You must keep track of this switching around yourself. The internal memory in our system was not sufficient to design this activity into the program.

Listing 2 shows a set of input data for our construction project. Listing 3 shows output for a typical run, and listing 4 shows output for a full crash analysis.

Program Input

We wanted to keep the input data to a minimum. We therefore decided to input an activity code, beginning event, ending event, the normal time/cost, and the crash time/cost.

Running the Program

The program begins by identifying itself. The first question asked concerns the type of system being used. This question is necessary in order to control the shutting off and turning

on of the time clock when using tape input/output under the disk system, and to avoid encountering the CMD"_" statement when using a Level II BASIC system.

For our illustration, the answer to this question is not critical since we will use neither tape nor disk input. (If you do not have a disk system, do not try to use the disk input and output functions because they won't work. We haven't tried this trick and can't tell you what the results would be.)

Text continued on page 388

NEW FOR THE IBM PERSONAL COMPUTER WHY STOP AT 256K OF RAM?

PC/RAM STACK

256K/512K Ram Extension Board
For The IBM Personal Computer

PC/RAM STACK allows expanding the IBM Personal Computer's memory by 512K in just one I/O expansion slot, leaving the other slots available for I/O functions and peripherals.

SUGGESTED RETAIL

512K Model	\$1795.00
256K Expandable to 512K	\$1195.00
256K Non Expandable Model	\$995.00
Add On Modules 64K	\$150.00
	each

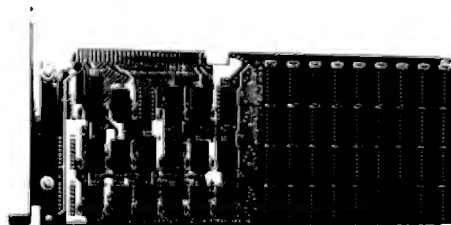

FREE SOFTWARE

With each 256K or 512K PC/Ram Stack purchased before September 1, "MDISK" software allows accessing all or part of PC/Ram Stack as if it were Disk Drive C: Only 5 to 10 times faster.

NATIONAL
TECHNOLOGY
SALES P O Box 401782 Garland, Texas 75040 (214)349 8259

FEATURES:

- Designed specifically for the IBM Personal Computer
- Plugs into any of the five expanding slots
- Available in 256K or 512K versions
- Field expandable from 256K to 512K
- On board error checking
- Fully assembled, tested and burned in
- Access time 250 nano sec.
- Cycle time 410 nano sec.
- STACKED RAMs for maximum density
- Only 10" Long
- Fully Socketed
- 1 Year Warranty

PC/RAM STACK uses state-of-the art technology to deliver the highest density memory in the industry.

SUPER MICRO COMPUTERS

from \$2,395.00



CI-MWS03-SB — LSI 11/2 computer workstation. LSI 11/2 CPU, 64KB Memory, power supply, KEV 11, in 16 slot rack mountable chassis. 2 port serial I/O. CRT terminal. 1 mega byte floppy disk system. Desktop workstation **\$7,795.00**

CI-MWS23-MB — LSI 11/23 computer workstation. LSI 11/23 CPU, MMU, 256KB Memory, power supply, in 16 slot rack mountable chassis. CRT terminal. 10 mega byte cartridge disk system. 4 port serial I/O. Desktop workstation **\$11,295.00**

CI-103 DESKTOP COMPUTER — Complete computer system enclosed within a VT103 video terminal with LSI 11/2 and 64KB Memory **\$3,295.00**
With LSI 11/23 and 256KB Memory **\$4,995.00**

CI-1103LK — LSI 11/2 CPU, 64KB Memory, power supply, KEV 11 in 16 slot rack mountable chassis **\$2,395.00**

CI-11/23 AC — LSI 11/23 CPU, MMU, 256KB Memory, power supply, in 16 slot rack mountable chassis **\$3,795.00**

CI9448-96 — 96 mega byte cartridge disk system with controller. 80 mega bytes fixed and 16 mega bytes removable **\$10,500.00**

CI-1220 — Dual drive, double density, double sided, 2MB capacity floppy plus DMA LSI 11 controller **\$2,795.00**

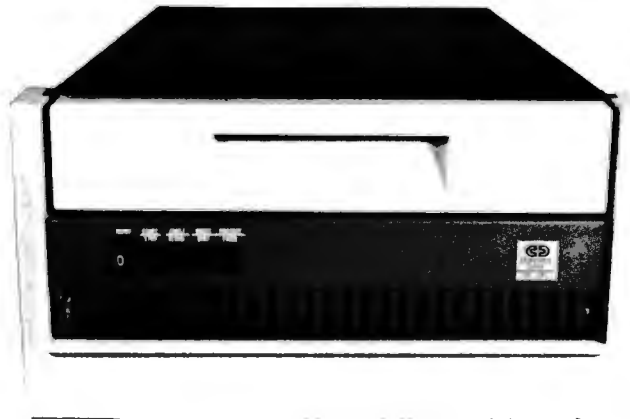

DON'T ASK WHY WE CHARGE SO LITTLE, ASK WHY THEY CHARGE SO MUCH.



Chrislin Industries, Inc.

31352 Via Colinas • Westlake Village, CA 91362 • 213-991-2254
TWX 910-494-1253 (CHRISLIN WKVG)

LSI 11 is a trademark of Digital Equipment Corp.

Listing 2: A printout of the input for the sample run of the CPM program shown in listing 1. Input includes the beginning and ending events of each activity, normal time and cost, and crash time and cost.

TITLE: SAMPLE PROBLEM CPM
DATE: 01/19/81

NO	CODE	DESCRIPTION	BEGIN	END	NORMAL		CRASH	
			EVENT	EVENT	TIME	COST	TIME	COST
1	A	ACCT. PAPER	1	2	2.00	20.00	1.00	30.00
2	B	SHOP BANKER	1	3	4.00	40.00	3.00	60.00
3	C	SHOP REAL E	1	4	13.00	130.00	10.00	170.00
4	Z	PERMITS	2	7	5.00	50.00	4.00	80.00
5	D	MARKET STUD	2	3	4.00	40.00	3.00	50.00
6	G	CONTRACTOR	2	5	2.20	22.00	1.70	67.00
7	F	INSURANCE	2	6	1.30	13.00	0.50	15.00
8	H	ART. PLANS	3	5	4.00	40.00	3.00	60.00
9	E	COST STUDY	3	4	4.00	40.00	3.00	50.00
10	I	LAND	4	5	11.00	110.00	10.00	130.00
11	J	MATERIAL	5	6	3.00	30.00	2.00	40.00
12	K	PLANS	5	7	5.00	50.00	2.00	120.00
13	L	SURVEY	5	8	2.00	20.00	1.00	40.00
14	M	BUY MAT #1	6	8	7.00	30.00	4.00	40.00
15	O	BUY MAT #2	6	9	8.00	20.00	5.00	50.00
16	N	LAYOUT	7	8	21.00	110.00	12.00	120.00
17	Q	HIRE CREW 2	7	9	2.00	20.00	1.00	30.00
18	P	FOUNDATION	8	9	9.00	30.00	6.00	60.00

Listing 3: Output of the sample run of the CPM program in listing 1. The critical path is identified, as are its normal time and cost, and its crash time and cost. The critical path is activities C I K N P. Normal time of completion is 59 weeks; normal cost is 430 units. Crash time is 40 weeks, but at a cost of 170 additional units.

CODE	DESCRIPTION	TIME	EARLY	EARLY	LAST	LAST	SLACK
		USED	START	FIN	START	FIN	TIME
A	ACCT. PAPER	2.00	0.00	2.00	3.00	5.00	3.00
B	SHOP BANKER	4.00	0.00	4.00	5.00	9.00	5.00
C	SHOP REAL E	13.00	0.00	13.00	0.00	13.00	0.00
Z	PERMITS	5.00	2.00	7.00	24.00	29.00	22.00
D	MARKET STUD	4.00	2.00	6.00	5.00	9.00	3.00
G	CONTRACTOR	2.20	2.00	4.20	21.00	24.00	19.00
F	INSURANCE	1.30	2.00	3.30	41.70	43.00	39.70
H	ART. PLANS	4.00	6.00	10.00	20.00	24.00	14.00

Listing 3 continued:

E	COST STUDY	4.00	6.00	10.00	9.00	13.00	3.00
I	LAND	11.00	13.00	24.00	13.00	24.00	0.00
J	MATERIAL	3.00	24.00	27.00	40.00	43.00	16.00
K	PLANS	5.00	24.00	29.00	24.00	29.00	0.00
L	SURVEY	2.00	24.00	26.00	48.00	50.00	24.00
M	BUY MAT #1	7.00	27.00	34.00	43.00	50.00	16.00
O	BUY MAT #2	8.00	27.00	35.00	51.00	59.00	24.00
N	LAYOUT	21.00	29.00	50.00	29.00	50.00	0.00
Q	HIRE CREW 2	2.00	29.00	31.00	57.00	59.00	28.00
P	FOUNDATION	9.00	50.00	59.00	50.00	59.00	0.00

CRITICAL PATH C I K N P
 TIME OF CRITICAL PATH 59
 COST OF CRITICAL PATH 430 INCREMENTAL COST 0
 NORMAL TIME OF CRITICAL PATH 59
 NORMAL COST OF CRITICAL PATH 430
 FULL CRASH TIME OF CRITICAL PATH 40
 FULL CRASH COST OF CRITICAL PATH 600

Listing 4: Output from a full crash run of the program in listing 1. The incremental cost of shortening the project by 19 weeks is 170 units.

FULL CRASH TIME ANALYSIS

CODE	DESCRIPTION	TIME USED	EARLY START	EARLY FIN	LAST START	LAST FIN	SLACK TIME
A	ACCT. PAPER	1.00	0.00	1.00	3.00	4.00	3.00
B	SHOP BANKER	3.00	0.00	3.00	4.00	7.00	4.00
C	SHOP REAL E	10.00	0.00	10.00	0.00	10.00	0.00
Z	PERMITS	4.00	1.00	5.00	18.00	22.00	17.00
D	MARKET STUD	3.00	1.00	4.00	4.00	7.00	3.00
G	CONTRACTOR	1.70	1.00	2.70	18.30	20.00	17.30
F	INSURANCE	0.50	1.00	1.50	29.50	30.00	28.50
H	ART. PLANS	3.00	4.00	7.00	17.00	20.00	13.00
E	COST STUDY	3.00	4.00	7.00	7.00	10.00	3.00
I	LAND	10.00	10.00	20.00	10.00	20.00	0.00
J	MATERIAL	2.00	20.00	22.00	28.00	30.00	8.00
K	PLANS	2.00	20.00	22.00	20.00	22.00	0.00
L	SURVEY	1.00	20.00	21.00	33.00	34.00	13.00

Listing 4 continued on page 388

Listing 4 continued:

M	BUY MAT #1	4.00	22.00	26.00	30.00	34.00	8.00
O	BUY MAT #2	5.00	22.00	27.00	35.00	40.00	13.00
N	LAYOUT	12.00	22.00	34.00	22.00	34.00	0.00
Q	HIRE CREW 2	1.00	22.00	-23.00	39.00	40.00	17.00
P	FOUNDATION	6.00	34.00	40.00	34.00	40.00	0.00

```

CRITICAL PATH  C I K N P
TIME OF CRITICAL PATH 40
COST OF CRITICAL PATH 600      INCREMENTAL COST 170
NORMAL TIME OF CRITICAL PATH 59
NORMAL COST OF CRITICAL PATH 430
FULL CRASH TIME OF CRITICAL PATH 40
FULL CRASH COST OF CRITICAL PATH 600
  
```

Text continued from page 384:

A note follows about the ordering of data input. The program requires the events to be ordered numerically from the beginning event. You need not input the data in this order; the program will do the ordering for you. If you add an activity in the adjustment cycle, the program will insert the step where appropriate.

The next question concerns the dimension of the problem. We made this a variable input because some of you will have larger systems than ours; others will remove some of our remarks statements and possibly go to compress format to pick up some additional capacity. The maximum-size problem we can run for this program is approximately 180 activities. This has been satisfactory, but we thought that allowing the dimension to be reduced any further would be unacceptable.

The input menu defines alternative methods for giving data to the program. It is as follows:

```

INPUT MENU
K  KEYBOARD
D  DISK FILE
R  READ STATEMENT
T1 TAPE RECORDER #-1
T2 TAPE RECORDER #-2
  
```

The original data will have to be input either from the keys or from data statements. At the end of a run, you will be able to save a file on disk or tape. You can then reinput and update that information in some future run or save the results for demonstration purposes.

Each of the above data-input procedures results in a slightly different sequence of steps. If you set up the data statements at the end of your program according to the instructions in statement 2020, you will be ready to use the R instruction. Note that the first data line (2030) contains the number of activities to be read in and the number of the ending event. All the following data lines contain the code of the event, description of the event, beginning-event number, ending-event number, normal time/cost, and crash time/cost. If you are not using the built-in data, removing lines 2030-2210 will pick up some additional space for the dimension question reviewed above.

A little delay occurs after you have completed the input of data. This is due to the sorting routine noted above.

The next thing you will see on your video display will be the screen full of

information shown in figure 2. You will then be given the option to page the data whenever the information requires more than one screen. At the end of the listing, you will be asked the following question:

```

-2 TO ADD, -1 TO CONTINUE
OR NUMBER TO CHANGE?
  
```

This is where it is possible to add additional activities. Your only limit is the size of your dimension statement. You may also correct any errors you may have made. After each addition or correction, the program again sorts the activities in order of the beginning events and reprints the list.

After you have completed the above activity, the program will give you the option of using your printer to obtain hard copy of what was on screen. If you select this option, you also will be asked to input a title and date for identification purposes.

When the printer is finished, or if you did not choose hard copy, you will be asked the type of run you are interested in. The program allows you to make an analysis at normal

VERIFICATION OF INPUT								
NO	CODE	DESCRIPTION	BEGIN EVENT	END EVENT	NORMAL TIME	COST	CRASH TIME	COST
1	A	ACCT. PAPER	1	2	2.00	20.00	1.00	30.00
etc.								

Figure 2: The display shown on the screen after the input of data.

CODE	DESCRIPTION	USED TIME	EARLY START	EARLY FIN	LAST START	LAST FIN	SLACK TIME
A	ACCT. PAPER	2.00	0.00	2.00	3.00	5.00	3.00
etc.							

Figure 3: The display shown on the screen after the selection of type of run has been made.

time and cost, full crash time and cost, or at some level of selective crashing. Take care to keep track of the costs of the various levels of selective crashing because the program will not keep track of the costs of alternative critical paths or of crashing on other than the critical path. The programming to handle this was so large that we thought it would reduce the capacity of the program below the point of usefulness to many people. This was a difficult decision and a hard trade-off to make.

If you plan to do selective crashing, it is necessary to start from normal time. You cannot crash further once you have performed the full crash function. After you have completed your selection, the computer must go to work. If you have a large problem, go make yourself a cup of coffee and relax. When the task has been completed, the information in figure 3 will be shown on the screen.

As with the input data, the program will give you the option of paging through the output results if the amount of information is greater than can be contained in a single screen. You will also have the option of hard copy.

The next thing you will see on the screen is the output menu:

OUTPUT MENU

- C COST & TIME OF CRITICAL PATH
- D DISK
- E END
- R RECYCLE
- S SELECTIVE CRASHING
- T1 TAPE #-1
- T2 TAPE #-2 SELECTION?

Most alternatives are self-explanatory. We will walk through the C and S options.

Cost and Time of Critical Path

If you select the C option, you see a display of results like the following:

```

CRITICAL PATH C I K N P
TIME OF CRITICAL PATH 59
COST OF CRITICAL PATH 430
INCREMENTAL COST 0
NORMAL TIME OF CRITICAL
PATH 59
NORMAL COST OF CRITICAL
PATH 430
FULL CRASH TIME OF
CRITICAL PATH 40
FULL CRASH COST OF
CRITICAL PATH 600
HARD COPY (Y/N)?

```

You could have identified the critical path by seeing which activities

had zero slack times. This is what the computer does for you. It then examines the time/cost of the critical path. Again, you must keep track of this information because the computer will not keep track of the time/cost information for you as the critical path shifts for various degrees of crashing. When you have completed this cycle, the program will return to the output menu detailed above.

Selective Crashing

The S option allows you to do selective crashing. You can approach the crashing activity in many different ways. We think you will work out your own as you use this program. If you need to get near the full crash time, you can crash everything on the critical path. If you need only a limited degree of crashing, start with those items with the lowest unit cost of crashing and see if this gives the result you want. Experiment with this option; it is the most important one from the managerial standpoint. To get the greatest benefit out of this program, you will have to know how to use this option well.

The new run option allows you to start over anytime in your selective crashing activities and do a degree of

NO	CODE	DESCRIPTION	SELECT TIME	CRASH COST	UNIT COST	TOTAL COST
3	C	SHOP REAL E	13.00	0.00	13.33	40.00
10	I	LAND	11.00	0.00	20.00	20.00
12	K	PLANS	5.00	0.00	23.33	70.00
16	N	LAYOUT	21.00	0.00	1.11	10.00
18	P	FOUNDATION	9.00	0.00	10.00	30.00

- 1 TO CONTINUE OR NUMBER TO CHANGE?

Figure 4: The display shown on the screen after the new run option has been answered.

experimentation. You should answer (Y) to this question on the first run just to clear the machine. After answering this question, you will see the display shown in figure 4.

All activities on the critical path will be listed, plus all activities that have been crashed. You can get the total cost of crashing from this listing by adding the crash costs yourself.

If you need to do only a limited amount of crashing, start with the lowest unit cost of crashing and work

up to the more expensive items. If you must do an extensive amount of crashing, you may want to fully crash all items of the critical path. Do not be surprised if the critical path changes as a result of these efforts.

Once you have made your analysis, the program will recycle and find the new critical path.

One procedure we have found useful is to run the system at normal time/cost and then at full crash time/cost. This defines the limits

within which we can work and gives us a way to see how close our program results are to the best times that can be produced.

Conclusion

CPM is a powerful project-planning technique. This program makes it easy for the construction worker, engineer, or any other businessperson to apply the technique. We hope that you derive as much benefit from our program as we have. ■

TRANSLATION:
WE'D NEVER SUCCEED -
THEY'VE GOT

PRIORITY ONE ELECTRONICS'

SPRING 1982 ENGINEERING SELECTION GUIDE

IF YOU HAVEN'T ALREADY RECEIVED YOURS, SEND \$1.00 TODAY, AND WE'LL RUSH A COPY TO YOU!

PRIORITY ONE ELECTRONICS
9161 DEERING AVE. CHATSWORTH, CA 91311

54-1-11111111 - 1111!

NAMOR™

the new standard in mailing list programs for CP/M® systems

Powerful, yet EASY to use.

SHAPE'S new menu driven program does all of the routine task in lists management and production without the use of "control keys." In addition NAMOR has numerous special features including a screen display of the list directory and disk number for each list disk. Use this program to track your SPECIAL PEOPLE.

Introductory Offer, \$100 (\$150 after Sept. 30, 1982)

SYSTEM REQUIREMENTS: CP/M, 56K, terminal with addressable cursor & 80 char. x 24 line screen, single or dual disk, 8" IBM or 5¼" North Star.

CP/M is a registered trademark of Digital Research. NAMOR is a trademark of SHAPE, Inc.

SEND FOR DETAILED INFORMATION

SHAPE, INCORPORATED
122 SPANISH VILLAGE, SUITE 615
DALLAS, TEXAS 75248



The hard facts about Software from Byte Books

BASIC Scientific Subroutines, Vols. I and II

Valuable programs for professional and hobbyist

by Fred R. Ruckdeschel

Designed for the engineer, scientist, experimenter, and student, this series presents a complete scientific subroutine package featuring routines written in both standard Microsoft and North Star BASIC.

- Volume I covers plotting, complex variables, vector and matrix operation, random number generation, and series approximations.
- Volume II includes least-squares approximation, special polynomial functions, approximating techniques, optimization, roots of functions, interpolation, differentiation, and integration.

Volume I
ISBN 0-07-054201-5
336 pages; hardcover
19.95

Volume II
ISBN 0-07-054202-3
800 pages; hardcover
23.95

Threaded Interpretive Languages

How to implement FORTH on your Z80

by Ronald Loeliger

This book develops an interactive, extensible language with specific routines for the Zilog Z80 microprocessor. With the core interpreter, assembler, and data type defining words covered in the text, it is possible to design and implement programs for almost any application and equivalent routines for different processors.

ISBN 0-07-038360-X
272 pages; hardcover
18.95

Beginner's Guide for the UCSD Pascal System

The most popular Pascal version explained by its creator

by Kenneth L. Bowles

Written by the originator of the UCSD Pascal System, this informative book is an orientation guide to the System.

For the novice, this book steps through the System, bringing the user to a sophisticated level of expertise. Once familiar with the System, the reader will find the Guide an invaluable reference tool for creating advanced applications.

ISBN 0-07-006745-7
204 pages; softcover
11.95

The BYTE Book of Pascal

A powerful, structured language
Blaise W. Liffick, Editor

Based on articles, language forums, and letters from BYTE magazine, this work is a valuable software resource. Pascal continues to be popular as a structured programming language. Written for both potential and established users, this book introduces the Pascal language and examines its merits and possible implementations. Featured are two versions of a Pascal compiler, one written

in BASIC and the other in 8080 assembly language; a p-code interpreter written in both Pascal and 8080 assembly language; a chess-playing program; and an APL interpreter.

ISBN 0-07-037823-1
334 pages
hardcover
\$25.00

Beyond Games: Systems Software for Your 6502 Personal Computer

Creating programs for the Apple, Atari, Challenger and PET computers

by Kenneth Skier

At last, a complete programming guidebook. A self-contained course in structured programming and top-down design, this book presents a powerful set of tools for building an extended monitor, disassembler, hexadecimal dump routine and text editor programs.

ISBN 0-07-057860-5
440 pages; softcover
14.95

Name	Title	Price	Quantity	Amount
Address				
City	State	Zip		
Check Enclosed	Amount			
Bill Visa/Master Card Number				
Expiration Date				

Add 75¢ per book to cover shipping costs:

Total



BYTE Books 70 Main Street Peterborough, N.H. 03458
Circle 65 on inquiry card.

ORDER TOLL FREE 800/258-5420

Computers for Humanity

*An observer comments on
the Seventh West Coast Computer Faire.*

Jerry Pournelle
c/o BYTE Publications
POB 372
Hancock, NH 03449

For my money, the West Coast Computer Faire has become the most important show of the year. Now true, some other shows like COMDEX and the NCC attract more big spenders, and they treat the press more royally. If what you want are big parties with lots of free booze, those are the places to go. They're also important for announcements from the big companies like IBM and DEC; and the mainframe and mini-computer people, who think they're the driving force in computer futures, show up at NCC when they wouldn't come to the Faire.

They don't know what they're missing. The West Coast Computer Faire tracks microcomputers and small popular computers—and that's where the real future of computing lies.

It's interesting to see who's at the Faire. There are hundreds—this year it seemed like thousands—of displays. "Big" companies, some new like Osborne and some "established" (more than five years old) like Cromemco, have booths. But there are surprising omissions, giants of yesteryear who have vanished with little trace. There are the industry pacesetters like Bill Godbout and George Morrow. The real drivers of the microcomputer industry, the little

one-programmer software houses which lurk this year in the tiny inexpensive booths along the walls, in two years will wear three-piece suits and have large center-display spaces.

I'm always relieved when the West Coast Computer Faire ends. Not that I don't enjoy the Faire; quite the opposite. I get to see the future before it happens; sometimes I discover some exciting new developments before any other journalists do and have the thrill of helping some future industry leader get started. (That isn't really altruism. It's in my interest to tell readers about worthwhile but obscure new products.) But for three days I'm running around looking at software and hardware, and by Sunday evening I'm plumb worn out. For the very reasons I like the Faire, it's exhausting.

Each year's Faire is different. Last year's I could characterize as promising: lots of really neat products would be out Real Soon Now. This year many of them were, but the theme was more of consolidation. There wasn't a lot of new hardware and very little new software, except for an infinite number of computer games. You couldn't go two feet without seeing small creatures swimming through mazes while devouring little dots. They were chomping dots on

Atari computers and Apples and TRS-80s, and there was even a black-and-white CP/M version for a Z-19 terminal! But there wasn't a lot of really new stuff.

68000-Based Systems

But there were some new products. In hardware, the biggest new items were systems that use the Motorola 68000 chip (32-bit data and address registers; 16-bit data bus). The two that I spent some time looking at were the Fortune 32:16 by Fortune Systems Corporation and the Sage II from Sage Computer Technology.

Except for the 68000 chip, the two computers couldn't be more different. The Fortune 32:16 is a slick, space-age plastic machine that comes complete with detachable keyboard and a "sculpted" swivel-mounted monitor; the whole thing looks like a Frank Kelly Freas science fiction illustration of a future computer. The operating system is menu driven and very much business oriented. Fortune Systems offers COBOL and FORTRAN and the like, all at fairly high prices, and again, the whole pitch is toward the business user. Although the actual Fortune 32:16 operating system is Unix, Fortune Systems keeps that pretty well hidden inside the business-menu shell; and when the exhibitors

were demonstrating their computer, they never took the cover off or talked about what's inside.

Sage, on the other hand, is proud of the innards of its single-card machine. It doesn't sell keyboards and monitors. But, although Sage is proud of its hardware, it didn't plan on any outside outfits making after-market add-on equipment. The Sage II is very small. The box contains two 5¼-inch floppy disks (a hard disk could be substituted for one of them) and isn't much bigger than the disk drives. There just isn't any room for expansion without changing the box. The power supply is a switching power supply, tiny in comparison to the brute-force monsters I have on my Godbout System. The operating system being used right now on the Sage II is UCSD Pascal. Because that compiles to an intermediate p-code rather than true machine language, it has tended to be slow on previous microcomputers; but Carl Helmers, a UCSD Pascal enthusiast, likes the Sage implementation because, as he says, the 68000 is so fast that you don't notice how "slow" p-code is.

Sage says it'll have Unix running Real Soon Now, and it doesn't intend to hide it inside a shell. Sage people are more comfortable talking to engineers and computer hackers than business types.

Both systems are affordable. The Fortune 32:16 with keyboard and monitor, a single 5¼-inch floppy disk, 128K-byte memory, and Unix (with a C compiler) but no other software is just under \$5000; the system they were demonstrating at the show, with one floppy disk plus a 5-megabyte hard disk and 512K bytes of RAM (random-access read/write memory), is about \$7500. I get the impression Fortune Systems can deliver systems fairly quickly if you're ready to pay.

The Sage II costs a bit less for more memory and a faster processor. Remember, though, you'll need a terminal, and one to match the Fortune keyboard and monitor will run you at least \$1200. You'll also need an operating system. UCSD Pascal is \$400; Sage doesn't know what the cost will be when Unix is added. You

can put in an order and a deposit and get your computer in a couple of months.

While neither system is cheap, for under \$10,000 you can buy the power of a minicomputer costing five times that. These machines—and by the time this is published I'm sure there'll be others—make the 68000 chip a strong challenger for the future. [Editor's Note: *Cromemco announced its 68000/Z80 board and Corvus surprised everyone when it introduced its 68000-based computer with built-in Omni-Net. . . . M. H.*]

One word of warning: I'm describing systems I saw at the show. I have not seen either of them in an actual user environment, and indeed I haven't even seen the insides of the Fortune 32:16 box. I wouldn't buy

The Fortune 32:16 and the Sage II will make the 68000 chip a strong challenger in the future.

either one without knowing more than I do now. I'm trying to project the future, not recommend specific systems.

On that score, last year there were a number of breathless announcements of Z8000 chip systems. This year there wasn't a single Z8000 at the show! It looks as if the Z8000 is a chip whose time has passed. It's a pity, because it has good architecture and an excellent instruction set; but in my judgment, it was a victim of too few chips delivered too late, and now I doubt anyone will invest in making a first class system for it. [Editor's Note: *Olivetti, perhaps best known for its typewriters, has just announced its personal computer. Z8000-based, it contains 128K bytes of RAM and one double-sided 5¼-inch disk drive capable of storing 320K bytes per disk. Cost: \$3000. . . . M. H.*]

S-100 and CP/M

On the other hand, S-100 bus systems, the 8086, 8088, and their cousins were all at the Faire. Bill God-

bout with software from G&G Engineering had a multiuser CP/M system running smoothly: three consoles with word processing, BASIC, and a business package all running simultaneously with no noticeable delays. The demonstration used the Godbout controller and a Morrow hard disk, available to the public Real Soon Now (Godbout's documentation wasn't quite finished as of Faire time; but it should be by now).

I had lunch with Bill Godbout during the Faire, and he told me some of his future plans for the 8086 family. Bill talks high technology at a rapid-fire pace, and I don't always understand what he's saying. (I don't have to feel too bad; my engineering-genius friend Tony Pietsch was at the lunch, and even he missed some of Bill's points about future chips.) The important point, though, is that Godbout has gathered a prodigious reputation for thinking ahead, so that people who've invested in his systems in the past won't be left hung out to dry when new technology overtakes them; and he's got a lot of new 8086/8088 products in the works.

Then too, Digital Research intends to support the 8086 family, so that the 8-bit CP/M users won't find all their software useless if they move up to a bigger machine. I'll have full reports on some of these new operating systems in another article; I'm getting them running in the next couple of weeks.

The S-100 people alone might not have enough influence to keep the 8086 family competitive with the 68000. But then there's the IBM Personal Computer; with IBM behind it, the 8088 chip is bound to stay important. However, there weren't many IBM Personal Computers at the show.

Incidentally, most of the small systems houses that had IBM machines were in complete agreement with my assessment of the IBM keyboard design, namely, that it took brains to mess that up as badly as IBM did. (For those who haven't seen it, IBM took the nicest keyboard I've ever seen, then put extra keys between the Z and the Shift keys so that touch typists simply *cannot* use the IBM

ONE KEY WORD PROCESSING
 on your **TELEVIDEO™**
 with **WORDSTAR™** and . . .



\$99⁹⁵
 Mastercard
 Visa

- **Nu Key™** Automates the 36 most commonly used word processing functions
- Adds one key capabilities to **TELESOLUTIONS™**
- Comes complete with 14 new matching keycaps

For your **TELEVIDEO™ 950, TS-800, TS-800A, and TS-802**
PLEASE SEND WORDSTAR SERIAL NUMBER TO:

Business Solutions, Inc.
 91 W. Long Lake Rd., Suite 14
 Bloomfield Hills, MI 48013
 (313) 540-3360

DEALER INQUIRIES INVITED

TELEVIDEO & TELESOLUTIONS™ OF TELEVIDEO / WORDSTAR™ OF MICROPRO INTERNATIONAL
 NuKey™ OF BUSINESS SOLUTIONS INC

MULTI-PROGRAMMER SYSTEM-10

Features:

- Dedicated keys and large display vocabulary for ease of use.
- I/O - 6 baud rates, 13 formats including Intellec, Textronix and Motorola.
- EPROMs, E²PROMs and bipolars.
- Gang option - programs eight at once.
- Remote control option.

\$1,295

**PROGRAMS
 OVER 250
 DEVICE TYPES**



FUNCTIONS:

- | | | |
|---------------------|-------------------|------------------|
| DISPLAY DEVICE DATA | LOAD DATA | CRC - DEVICE/RAM |
| EDIT RAM DATA | COMPARE FIELDS | CRC - RAM |
| DEVICE PROGRAM | FILL MEMORY FIELD | I/O HOST PROMPT |
| TYPE SELECTION | BLOCK MOVE | DIAGNOSTICS |
| | | and more . . . |



COMPUTER SYSTEMS CORP

100 East Linton Blvd. Delray Beach, Fla. 33444 (305) 272-2051

**Now available from your computer store-
 the whole line of AJ couplers and modems.**



Starting now you can buy AJ acoustic data couplers and modems directly from your local computer store.

Not just selected models. *Any* models. Ranging from the 0-450 bps A 242A, the world's most widely used acoustic data coupler, to the revolutionary AJ 1259 *triple modem* that handles 300 bps Bell 103, 1200 bps Bell 212A, and 1200 bps VA 3400 protocols.

Whether you need full or half duplex or both in one; originate or answer, auto answer; acoustic coupling, or direct-connect—there's a model for you in the AJ line.

Starting now you don't have to settle for second best.

For the location of your local computer store handling the AJ line, call toll-free:

800/538-9721

California residents call 408/263-8520, Ext. 307.



keyboard. Sigh.) But despite their small numbers, the IBM systems got more than their share of attention.

Companies with marvelous add-ons for the IBM were also at the Faire. There were memory expansion and video boards for the IBM and publications on how to buy a "bare-bones" IBM and add your own memory and disk drives. I think the explosion of IBM support—both hardware and software—has begun.

IBM is encouraging that. Its documents tell all. IBM apparently learned from Texas Instruments' poorly planned marketing of the TI-99/4A. Interestingly, so did Texas Instruments; I talked to some TI-99/4A programmers, and TI is now trying to retreat from the position it took when the unit first came out of ignoring hobbyists. At that time, TI worked very hard at keeping you outside the machine. There was no editor or assembler, and TI told you nothing about the hardware interface. TI had rightly concluded that the hobbyists and hackers were a tiny part of the market and *wrongly* concluded that they were, therefore, unimportant. As a result, the young computer hackers worked with other machines—Apple, Atari, S-100 bus, and TRS-80—and wrote programs and developed hardware add-ons for those computers. Since well over half the really good stuff for microcomputers has come from hobbyists and hackers, TI found itself cut off from the mainstream. IBM, on the other hand, encourages amateurs, and you could already see the results at the Computer Faire: memory boards, communications software, and even a few games, although the IBM hasn't been out long enough for many of those to evolve. Next year there'll be a lot of them.

The upshot is that there's no single direction for the microcomputer world to go in. The 68000 chip will not absorb the market; but neither will the 8086/8088 family drive out the 68000. The same will be true for operating systems. We'll shortly have both Unix- and CP/M-derived systems, and neither will be able to completely dominate the market; both will have fanatic supporters.

Thus, I've no advice for those seeking to upgrade their systems. If really pressed, I'll continue to recommend the S-100 bus, CP/M system as the most versatile; there's *far* more software and hardware for that system at affordable prices. True, the 68000 machines with Unix may be able to tap into a lot of software originally developed for minicomputers; but from what I've seen at any rate, most of that software is overpriced, and some of it is just dreadful, while the microcomputer software field is bursting with new ideas and concepts. But unless you push me to the wall, I'll recommend waiting a bit for the dust to settle before investing in an updated microcomputer.

Other Hardware

An external Apple fan, a small muffin fan that hangs on the *outside* of your Apple II, was exhibited at the Faire. It has four 110-volt outlets on the back. I suppose half the other exhibitors who used Apples bought a fan to use during the Faire.

There was Semidisk from Semidisk Systems, an S-100 memory card that is said to let your 8080, 8085, or Z80 do what G&G Engineering's Warp Drive does for my Godbout 8085/8088: reduce file-access time dramatically. Semidisk Systems sells 512K bytes of RAM for \$1995 and a full megabyte for \$2995, complete with all software. The exhibitors told me it will run on Ezekial, my ancient Z80 system with his antique but reliable iCom drives. If it'll run on that, it'll run on anything.

As I was writing this, I got a call from Bill Godbout: he had Semidisk running with a Godbout 8085/8088 system and indeed could get both Warp Drive and Semidisk running together and transfer back and forth between them. Bill was impressed. More on Semidisk in another article.

Finally, there's Micro-Professor, a strange and nearly unique educational device that a Taiwan company called Multitech Industrial Corporation sells for about \$150. (It doesn't hide that it's a Taiwan company; there is a Chinese-character logo on the box.) Micro-Professor (I'll call it MP from here on) is a single-board,

Z80 computer with all the works exposed, plus a keypad to allow you to feed it instructions. The front panel of MP is a 6-digit LED (light-emitting diode) display of hexadecimal numbers. It has a tiny on-board speaker, several extra wired-in sockets for chips, pin connectors to let you get at the Z80's bus, and a breadboard area for people like Steve Ciarcia to play with.

It comes in a handsome, plastic, booklike box; there's room in the box for a hefty manual, but alas the manual supplied doesn't fit in there, nor does the power supply. So, the plastic box is enclosed in a much larger heavy-duty cardboard box.

Not only is there *room* for a manual inside the box, but it's needed. The manual that is supplied is a bit intimidating. Oh, it tells all you'll ever need to know about the Z80: its architecture, instruction set, assembler language, and the like. But it launches right into the high-tech language with scarcely any concession to those who aren't quite up to absorbing it. The first words after the table of contents (actually on the page facing the table of contents) are:

1. MPF-1 Specification

1.1 Hardware Specification

(1) CPU; Zilog Z-80 CPU with 158 instructions and 2.5 MHz maximum clock rate. For MPF-1, system clock is 1.79 MHz.

No doubt Steve Ciarcia would find that intriguing; but it's a bit much for my high school boys. On the other hand, buried way back in the MP manual are some really interesting experiments, computer music and stuff like that, which would get kids really interested if they ever read that far.

I could recommend Micro-Professor as a high-school graduation present for students not terrified of technology; but until Multitech Industrial Corporation adds a second manual introducing the first one, I fear it'll miss its best markets. That's a pity because this country needs products that raise the high-tech level of our high school students, and the MP hardware seems well designed for that.

DEC DISK CARTRIDGES Overnight!



Genuine DEC Disks
RL01, RL02, RK07,
RK05-11, RP06,
RM05 and other
popular DEC Disks
& Supplies.

RADGO SALES CO.

3988 McMann Rd., Cincinnati, Ohio 45245
TOLL FREE Ordering 1-800-543-1986
except in Ohio phone 1-513-752-6880
Ask for free catalog

ADVANCED GRAPHICS SOFTWARE NOW—FOR MICROCOMPUTERS!

512 x 240
RESOLUTION

FOR COMPUSTAR®
SUPERBRAIN®
TRS-80® MODEL II
Z-89/90

USE WITH
HARDWARE RETROFIT
FROM \$595⁰⁰



XCEL™ GRAPHICS SOFTWARE

•Symbol Generator	\$175.00
•Graph Plotter	\$175.00
•3D Generator	\$345.00
•Surface Plotter	\$395.00
•Graphics Terminal Emulator	\$395.00
•Screen Printer	\$65.00

ANADEX
EPSON
IDS

SPECIAL PACKAGE PRICE
SAVE \$950⁰⁰
(GETS YOU THE HARDWARE FREE!)

(213) 320-6604

MAXTEK, INC. 2908 Oregon Court, Torrance, CA 90503
Available in Europe from Micronex Ltd., Chew Magna, England 3042 (STD 027-589 3042)
TRS 80 registered trademark Tandy Corp. Superbrain trademark Interac Data Systems
Teclone registered trademark Teclonix, Inc. EPM registered trademark Digital Research

FORTRAN, Pascal, COBOL/Ada™* UNIX™ III 68000



XAVAX Three Hardware

- 68000 CPU at 8MHz (10MHz option)
- Two level memory management
- 256KB on board RAM (512KB option)
- Up to 32KB of on board PROM
- 128KB RAM expandable to 1MB
- Floppy disk, hard disk to 672MB
- Full Multibus™ and multimaster

UNIX™ of Bell Laboratories Multibus™ of Intel Corporation Ada™ of Department of Defense

SOFTWARE

- UNIX™ III, PWB enhancements
- UC Berkeley utilities
- Screen oriented vi editor
- FORTRAN-77 (programs to 1MB)
- ISO Pascal, UCSD extensions
- RM COBOL, C, assembler
- *Ada™ under separate OS

IMMEDIATE ATTENTION!

B782

Please send specifications on:

<input type="checkbox"/> XAVAX One (board only, 128KB RAM) (\$2,000)	<input type="checkbox"/> XAVAX Three (as above) (\$14,000)
<input type="checkbox"/> XAVAX Two (with 10MB Winchester) \$9,500	<input type="checkbox"/> XAVAX Four (multi-CPU) (\$40,000)
<input type="checkbox"/> XAVAX/UNIX™ (hardware kit) (\$6,000)	<input type="checkbox"/> XAVAX/Ada™ (kit) (\$6,000)
<input type="checkbox"/> IBM bisync I/O controller (880Kb) (\$2,000)	<input type="checkbox"/> Intelligent I/O (RS232) (\$1,000)
<input type="checkbox"/> ANSI Winchester controller (8 ea) (\$1,000)	<input type="checkbox"/> 512KB RAM (250ns) (\$2,000)
<input type="checkbox"/> BizBank™ bank and trust manager (\$6,000)	<input type="checkbox"/> BizBoard™ stock market (\$8,000)
<input type="checkbox"/> BizBooks™ business management (\$6,000)	<input type="checkbox"/> BizMed™ MD office (\$3,000)
<input type="checkbox"/> TekGen™ genetic engineering (\$20,000)	<input type="checkbox"/> TekText™ science editor (\$2,500)
<input type="checkbox"/> BizTek™ quarterly updates of commercial user software development (1yr \$25)	

Mail checkmarked copy. Please enclose letterhead or business card.
MasterCard and VISA accepted.

Phone: **XAVAX CORPORATION** TWX
(319) 323-2332 300 Northwest Tower, Bettendorf, IA 52722 910-525-1177

Speaking of Software. . . .

If it's hard to sum up the hardware at the Faire, it's nearly impossible to summarize the software. There's just too much, and everyone claims to deliver the Earth for a pittance. It's hard to recommend anything I don't have running on my machines, and I won't have time for new products for several weeks. Thus, I can only mention a few specials that caught my attention.

There was one head-to-head contest between programs I've long used: Spellguard versus The Word. I love to have high-quality software houses fighting to provide me more services for less money. There's a good war going now between Innovative Software Associates (Spellguard) and Oasis Systems (The Word). Both put out really good spelling programs, and I use both every day. The Word gives you more information about your text, but it's not quite as easy to use as Spellguard. Spellguard's dic-

tionary is easier to reorganize, and I find it simpler to make special Spellguard disks for each book, then later compare them with the "standard" dictionary that comes with Spellguard. The Word's dictionary is larger but has a few inaccuracies. Oasis has just come out with The Word Plus, a menu-driven version making it almost as easy to use as Spellguard. And so forth. The two programs are neck and neck and fighting hard, and we users can only benefit from the competition.

I meet old friends at the Faire. Mike and Nancy Lehman, who last year had a small booth where they hawked their Pascal/MT+, were now with Gary Kildall and the Digital Research crew. Adam Osborne looked more harried than ever as he shuttled between the McGraw-Hill/Osborne publications display and the two Osborne computer demonstrations. Bill Gates and the Microsoft people threw an enormous party. With all of

them, the Faire theme was quite literally consolidation: they've firmed up products announced last year and have bold new software waiting in the wings which they're not ready to announce yet.

I also saw The Last One, which apparently works, and Pearl: they generate BASIC programs that are strong in handling files through menu-driven scripts. A lot of people seemed interested; I fear I wasn't. I might have been a few years ago, and I do think that getting the computer to assist you in making programming understandable to the user is a very good idea. But for me, the ability to do that in BASIC just isn't useful enough to warrant the time it would take to learn to use these program generators. I'm sure others will have a different opinion.

Then there are the games. Tons and tons of games. Space wars. Dot-eating creatures. Some really nifty Apple graphics in a program called Swashbuckler from Datamost of Chatsworth. And just tons and tons of war-game simulations. Many years ago I was very involved with board-type war games; it was obvious that one could get rich in that field, if that's the kind of work you wanted to do. It looks to me as if that opportunity is here again, only this time the game "board" is a computer display and you can get really complex combat rules since the computer keeps track of what's going on. Two groups of gamemakers caught my eye: Strategic Simulations of Mountain View, California, who have a whole mess of campaign games ranging from the Civil War to fantasy, and my old friends at Automated Simulation (Epyx) who continue to put out playable mind challengers.

Broderbund Software, which first appeared a few years ago in a tiny booth back against the far wall, was out in the middle with an elaborate setup. It was hard to get close to the booth: like Sirius Software, Broderbund had a number of computers, and huge crowds were pushing their way toward the booth. The graphics were gorgeous. Alas, it has dropped Galactic Trader and most of the other games that I liked so much; its



EMPLOYMENT OPPORTUNITIES

DP OPPORTUNITIES

Martin Marietta Aerospace, NASA's designated Contractor for the Space Shuttle External Tank Program has the following immediate opportunities at their Michoud Assembly Facility in suburban East New Orleans:

Business Applications Programmers/ Project Lead Experienced In:

- Engineering
- Manufacturing
- Shop Floor Control
- Scheduling
- Inventory
- Purchasing

**UNIVAC DMS 1100 Data Base Or Other CODASYL Data Base
Experience Utilizing The Data Manipulation Language With
COBOL Knowledge Of:**

- DDL
- SDDL
- TIP/CMS
- DPS 1100
- DDS 1100

Specialist

- Network Controllers
- Operations Research

All interested and qualified candidates are urged to send their resume, complete with salary history and background to: Martin Marietta Aerospace, Dept. B, P.O. Box 29304, New Orleans, Louisiana 70189, Attn: Personnel Department. We are an equal opportunity employer, m/h.

MARTIN MARIETTA

Products Mentioned

Adventure International
POB 3435
Longwood, FL 32750
(305) 862-6917

Automated Simulations Inc.
POB 4247
Mountain View, CA 94040
(415) 964-8021

Datamost
9748 Cozycroft Ave.
Unit ABC
Chatsworth, CA 91311
(213) 709-1202

Fortune Systems Corporation
1501 Industrial Road
San Carlos, CA 94070
(415) 595-8444

Innovative Software Applications
1150 Chestnut Lane
Menlo Park, CA 94025
(415) 326-0805

Computer Adventures

Numerous computer
games for Apple, Atari,
TRS-80

Swashbuckler

Fortune 32:16
(68000-based) computer

Spellguard

Multitech Electronics Inc.
195 West El Camino Real
Sunnyvale, CA 94087
(408) 773-8400

Oasis Systems
2765 Reynard Way
San Diego, CA 92103
(714) 291-9489

Sage Computer Technology
195 North Edison Way
Suite 14
Reno, NV 89502
(702) 322-6868

Semidisk Systems
POB GG
Beaverton, OR 97075
(503) 642-3100

Strategic Simulations Inc.
465 Fairchild Dr., Suite 108
Mountain View, CA 94043
(415) 964-1353

Micro-Professor

The Word

Sage II (68000-based)
computer

Semidisk

Computerized war
games

managers tell me that arcade games so outsell strategic games that it just isn't cost-effective to put programmer time on strategy. I hope that will change in the future.

Scott Adams hasn't found the strategic game market lacking. His Adventure International booth was doing a land-office business in script-driven strategic games. Meanwhile, nearly everyone was interested in *interactive novels* by major writers; although I didn't see any that particularly appealed to me, there's obviously a big potential market for them.

And now a confession: I went to the Faire with a dilemma. I've decided to get a nifty graphics computer. It will be for the boys, of course, but how can I write about all these computer games if I don't have a machine to run them on? So I went determined to decide what to get. It seems to boil down to two choices, Atari and Apple; and every time I've about made up my mind, something comes along to change it.

The Atari Home Computer has much better graphics, and just about everyone says that if you're only interested in games, that's the machine to get. It's not all that expensive,

either. On the other hand, there's all that software out there for the Apple, and the machine can be expanded almost indefinitely.

As if that weren't enough, Texas Instruments is practically giving away the TI-99/4A. The TI-99/4A has top-notch graphics, but more than that, it has Logo, which has to be the best tool for teaching small children I've ever seen.

Sigh. I wonder if I can justify getting one of each? After all, I do have to write about them.

Faire for Thought

So, after three days of intensive exposure to the whole of the computer world, the great and the small, the up-and-coming, the has-been, and the never-was, a few things stand out.

First and most obvious, there's little or no recession in the computer world. Forty thousand people paid to come look at displays of high technology, and about two thousand of them bought machines; many more bought software packages, and darned near *everyone* bought books.

Less obvious but more important, the crowds at the Faire were *not* engineers and scientists. They were clerks, salespeople, secretaries, doc-

tors, and nurses. The taxi driver who took me to the airport had been to the Faire earlier in the day. The computer revolution is definitely gaining momentum.

And that can have mind-boggling consequences. For example, I can see a time, a few years from now, when high technology has so thoroughly permeated Western civilization that there's no possibility of a low-tech operation able to best a Western army in combat. If you want to compete, you have to use high-tech.

But the totalitarians *can't do that!* Just last week, a Czech grocery clerk was sentenced to five years hard labor for owning an unlicensed mimeograph machine. When Poland invaded itself, one of the chief weapons of martial law was the shutting down of all communications—not only the telephone system but everything else. But how can a government do that to a technologically sophisticated people?

And that, I think, is the bottom line: what I saw at the West Coast Computer Faire may have been the first overture in the death knell for totalitarianism; the flowering of a revolution that makes the Reds look like reactionaries. ■

A SOFTWARE LIBRARY AT YOUR FINGERTIPS!

Now, shop from your easy chair with the help of the market's most complete and authoritative source on Apple Computers!

Select your software and accessories from page after page of the latest

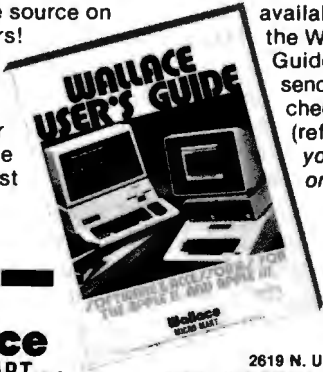

items in the computer field. Updated monthly to assure "state-of-the-art" availability. Order the Wallace User's Guide now by sending your check for \$5 (refundable with your first order).

Wallace
MICRO-MART INC.

2619 N. University St.
Peoria, IL 61604 • PH: 309/685-7878

NAME _____

ADDRESS _____

CITY _____

STATE _____

ZIP _____

SPECIALIST IN APPLE & S-100 MAIL ORDER

GREEN SCREEN MONITOR

- BMC-12A
 - 15 MHZ
 - Better looking than Zenith
- ONLY \$ 95.00
2 FOR \$180.00

PRINTERS

- NEC 8023A \$ 485 00
- MX-100 685 00
- IDS-Color 1299 00
- w/graphics, spmrt mode, sheet feeder

DISK DRIVES

- Micro-Sci A-2 \$ 385 00
- Micro-Sci A-40 370 00
- Micro-Sci A-70 485 00
- Shugart 801R 385 00
- Qume DT-8 499 00
- Shugart SA-400L 250 00
- Tandon TM-100-1 225 00

COMPONENTS

- | | 8 pcs | 100 pcs |
|----------------|--------|---------|
| 2114L2 (200NS) | \$2 10 | \$1 90 |
| 2716 (5V) | 2 40 | 3 90 |
| 2732 (450NS) | 7 25 | 6 95 |
| 4116 (200NS) | 1 70 | 1 50 |
| 6116-3 (150NS) | 7 60 | 7 00 |

DRIVE FOR APPLE

- Micro-Sci A-2 only \$385 00
- Fully Compatible 479 00
- 120 Day Factory War w/cont In Stock
- w/Cable

APPLE ACCESSORIES 2 Year Warranty

- Character Generator \$ 27 50
- 16K Ram Board 105 00
- 32K Ram Board 144 00
- Parallel Prnt Card w/ cable 71 00
- Eprom Programmer 99 00
- Serial Interface 99 00

MONITORS

- 12" Green (BMC) \$ 95 00
- 12" Hi Res (BMC) 145 00
- Amdek Color - Hi Res 769 00
- NEC Color 12" Hi Res 890 00

SPECIAL!

BMC COLOR MONITOR

- 18 MHZ Bandwidth
- 13 inch Screen
- In Stock **\$229.00**

HAVA-COMPUTER

1857 Montana Vista, Suite C
Lake Havasu City, AZ 86403
ORDER DESK: (602) 453-6282

- All Products New • Most items shipped in 24 hrs. • No surcharge
- Order Info. • MC • VISA • Money Order • Min. shipping order \$3.50
- Prices subject to change

PRODUCTS FOR YOUR RADIO SHACK

NEW!

COLOR COMPUTER

MACRO-80C

The Micro Works is pleased to announce the release of its **disk-based editor, macro assembler and monitor**, written for Color Computer by Andy Phelps. THIS IS IT — The ultimate programming tool!

The powerful 2-pass macro assembler features conditional assembly, local labels, include files and cross referenced symbol tables. MACRO-80C supports the complete Motorola 6809 instruction set in standard source format. There are no changes, constraints or shortcuts in the source language definition. Incorporating all of the features of our Rompack-based assembler (SDS80C), MACRO-80C contains many more useful instructions and pseudo-ops which aid the programmer and add power and flexibility.

The screen-oriented text editor is designed for efficient and easy editing of assembly language programs. The "Help Key" feature makes it simple and fun to learn to use the editor. As the editor requires no line numbers, you can use the arrow keys to position the cursor anywhere in the file. MACRO-80C allows global changes and moving/copying blocks of text. You can edit lines of assembly source which are longer than 32 characters.

DCBUG is a machine language monitor which allows examining and altering of memory, setting break points, etc.

The editor, assembler and monitor — as well as sample programs — come on one Radio Shack compatible disk. Extensive documentation included. **MACRO-80C Price: \$99.95**

SDS80C — Our famous editor, assembler and monitor in Rompack. Complete manual included. **Price: \$89.95**

PARALLEL PRINTER INTERFACE — Serial to parallel converter allows use of all standard parallel printers. You supply printer cable. **PI80C Price: \$69.95**

MICROTEXT — Get printouts while using your modem! Also download to cassette. General purpose terminal Rompack. **Price: \$59.95**

YOU NEED COLOR FORTH!!

- Why?
 - Forth is faster to program in than Basic
 - Forth is easier to learn than Assembly Language
 - Forth executes in less time than Basic

Forth is a highly interactive language like Basic, with structure like Pascal and execution speed close to that of Assembly Language. The Micro Works Color Forth is a Rompack containing everything you need to run Forth on your Color Computer.

Color Forth consists of the standard FORTH Interest Group (FIG) implementation of the language plus most of FORTH-79. It has a super screen editor with split screen display. Mass storage is on cassette. Color Forth also contains a decompiler and other aids for learning the inner workings of this fascinating language. It will run on 4K, 16K, and 32K computers. Color Forth contains 10K of ROM, leaving your RAM for your programs! There are simple words to effectively use the Hi-Res Color Computer graphics, joysticks, and sound. The 112-page manual includes a glossary of the system-specific words, a full standard FIG glossary and complete source listing. **COLOR FORTH ... THE BEST!** From the leader in Forth, Talbot Microsystems. **Price: \$109.95**

GAMES

Star Blaster — Blast your way through an asteroid field in this action-packed Hi-Res graphics game. Available in ROMPACK; requires 16K. **Price: \$39.95**

Pac Attack — Try your hand at this challenging game by Computerware, with fantastic graphics, sound and action! Cassette requires 16K. **Price: \$24.95**

Berserk — Have fun zapping robots with this Hi-Res game by Mark Data Products. Cassette requires 16K. **Price: \$24.95**

Adventure — *Black Sanctum* and *Calixto Island* by Mark Data Products. Each cassette requires 16K. **Price: \$19.95** each.

Cave Hunter — Experience vivid colors, bizarre sounds and eerie creatures in hot pursuit as you wind your way through a cave maze in search of gold treasures. This exciting Hi-Res game by Mark Data Products requires 16K for cassette version. **Price: \$24.95**

THE MICRO WORKS

Also available: Machine language Monitor ★ 2-pass Disassembler ★ Books ★ Memory Upgrade Kits ★ Parts and Services ★ Call or write for information

P.O. BOX 1110 DEL MAR, CA 92014

California Residents add 6% Tax
Master Charge/Visa and COD Accepted

714-942-2400

Computer Power and Human Reason

Joseph Weizenbaum
W.H. Freeman and
Company
San Francisco, 1976
300 pages, softcover
\$10.95

Reviewed by
Nancy Robertson
POB 108
Antrim, NH 03440

In our society of production lines and data processing, human beings are expected to perform with the monotonous regularity of machines. At the same time, artificial intelligence (AI) researchers are striving to make machines perform like human beings. Where's our perspective on the role of computers in our society?

Very few books have managed to present an objective view of the impact of computers on our way of life. Most of the time, we hear from extremists: prophets of doom and prophets of salvation. Every few decades, however, a work is published that is so cogent that it outlives the hardware configurations and programming techniques of its time. A few examples are Alan Turing's "Computing Machinery and Intelligence" (1950), John Von Neumann's *The Computer and the Brain* (1958), and Joseph Weizenbaum's *Computer Power and Human Reason*. Published in 1976, Weizenbaum's book is still a trustworthy account of com-

puters in our society, their limitations, and their promise. A book of its caliber deserves periodic reappraisal.

Weizenbaum, a professor of computer science at the Massachusetts Institute of Technology, is highly skilled in computer technology. Between 1964 and 1966 he wrote a program named Eliza, and the reactions it inspired are the foundation upon which *Computer Power and Human Reason* rests.

The program converses (through the keyboard and a printout) in English with human beings. The following well-known conversation between Eliza and a person demonstrates its famous ability to parody a Rogerian therapist. (Eliza's comments are in capital letters.)

Men are all alike.

IN WHAT WAY

They're always bugging us about something or other.

CAN YOU THINK OF A SPECIFIC EXAMPLE

Well, my boyfriend made me come here.

YOUR BOYFRIEND MADE YOU COME HERE

He says I'm depressed much of the time.

I AM SORRY TO HEAR YOU ARE DEPRESSED

It's true. I am unhappy.
Etc.

Eliza can converse only within a given context. One version of the program plays the role of a psychotherapist; it cannot play the role of the patient. Another version of Eliza can converse about recipes. But Eliza the cook cannot respond like Eliza the psychotherapist.

Eliza's responses are guided by rules about context and rules that reorder the comments entered by humans. Eliza understands the words it uses only in the most

limited way. If two Elizas could converse, the output would be nonsense.

But many people overestimated Eliza's powers. Weizenbaum writes that some knowledgeable scientists at first thought Eliza was "a general solution to the problem of computer understanding of natural language." Several psychiatrists believed the program could and should "grow into a nearly completely automatic form of psychotherapy." People who conversed with Eliza became quickly and deeply "emotionally involved." They believed Eliza really understood them. After a few conversations with Eliza, Weizenbaum's secretary asked him to leave the room so she and the machine could have some privacy.

These reactions confounded Weizenbaum's basic assumptions about the place of computers in our society. In *Computer Power and Human Reason* Weizenbaum considers why we tend to identify with computers, why artificial intelligence researchers are attempting to emulate human thought processes, why computers will never have human intelligence, and what the proper role of computers should be.

The reaction to Eliza made it obvious to Weizenbaum that we embrace existing computer programs not for what they do, but for what we imagine they do. Consequently, we misinterpret the functions of the computers we rely on.

Weizenbaum believes that computers are tools. Like all tools, they extend our control of our environment and reshape our environment by their use. They become extensions of ourselves, and we often become emotionally attached to them. A carpenter

has a favorite level, a mechanic a favorite wrench.

Since the Industrial Revolution, modern tools (technological advances) have taken on more and more human tasks. The steam engine replaced industrial labor and workers began to compete with machines. To compete with a machine or to work a machine, people have had to meet the machine's schedule, be methodical, and identify with the machine.

Until the invention of the computer, machines were only an extension of our physical abilities. The introduction of computers significantly altered the public perception of machines in that it established the ability of machines to emulate human thought processes. It was a simple step from there to the practice of attributing humanness to machines that can think and converse in English. Without understanding Eliza, we think Eliza really understands us.

"Can computers think?" is a question that continues to be asked. Some artificial intelligence researchers are shouting a qualified "Yes!"

Weizenbaum quotes frequently from Herbert A. Simon and Allen Newell, leading AI researchers who work at Carnegie-Mellon University. By 1958 they had already written:

There are now in the world machines that think, that learn, and that create. Moreover, their ability to do these things is going to increase rapidly until—in the visible future—the range of problems they can handle will be coextensive with the range to which the human mind has been applied.

Weizenbaum sums up the ambitions of many computer

scientists by saying they are motivated "to build a machine on the model of man, a robot that is to have its childhood, to learn language as a child does, to gain its knowledge of the world by sensing the world through its own organs, and ultimately to contemplate the whole domain of human thought."

It is this ambition that spurs the press to write lines like, "The ultimate fear is that the computers themselves will take over." Scientists who endorse that prevailing attitude reinforce our conviction that computers are human-like. But, as Weizenbaum cautions, "Computers and men are not species of the same genus."

AI has emerged in our quest to understand human thought. The brain is a black box. There are no surgical methods that enable us to witness brain functions in relation to conscious thought patterns. As Weizenbaum writes, "Our ignorance of brain functions is currently so very nearly total that we could not even begin to frame appropriate research strategies."

Since we can't open the black box of the brain, it's not surprising "that at least some scientists seek understanding the way humans work by designing computers whose input/output behavior resembles that of human beings as closely as possible." Computer models of human thought processes are the basis of AI.

Scientists in the field have come to see "the whole man" as an information processor, perhaps because computers lend themselves so easily to information-processing thought models. On this subject, Weizenbaum writes:

I will . . . try to maintain the position that there is nothing

wrong with viewing man as an information processor (or indeed as anything else) nor with attempting to understand him from that perspective, providing, however, that we never act as though any single perspective can comprehend the whole man.

Unfortunately, many AI scientists hold just such a narrow view of man. Newell and Simon base their theories of "the whole man" and their computer models on their statement that "All humans are information processing systems." Dr. Kenneth Colby, a psychiatrist and computer scientist, writes:

A human therapist can be viewed as an information processor and decision maker with a set of decision rules which are closely linked to short-range and long-range goals.

Weizenbaum argues that computers definitely have intelligence and that we can learn about intelligence from computer models. But, he writes, "Intelligence is a meaningless concept in and of itself. It requires a frame of reference."

Computers, he adds, will not and do not think exactly like human beings simply because they are not human. The needs and design of our bodies affect our thoughts. Our emotions are not independent of our minds. Certainly, we use heuristics to solve problems and we follow logic, but the problems we choose to tackle heuristically are influenced by our physical needs and emotions.

Weizenbaum provides an example: "The most unschooled mother who cannot compose a single grammatically correct paragraph in her native language . . . constantly makes highly

JOHN STARKWEATHER'S

NEVADA PILOT

\$149.95

DISKETTE AND MANUAL

For all CP/M systems. Works with Apple (softcard needed), Osborne 1, TRS-80, North Star, Superbrain, Micropolis, Vector and many other microcomputers. Needs 32K RAM, one disk drive and CRT or video display and keyboard.

- PILOT for Programmed, Inquiry, Learning Or Teaching.
- An excellent interactive language for education and office automation.
- Perfect companion for BASIC, COBOL and PASCAL to solve training and documentation problems.
- John Starkweather, Ph.D., creator of PILOT, wrote this version to meet all PILOT-73 standards and added many new features.
- New features include full screen text editor, commands to drive optional equipment such as VTR's & voice response units.
- Currently used in many college and progressive high schools.
- Use for interactive applications—data entry, programmed instruction and testing.

NEVADA EDIT

\$119.95

DISKETTE AND MANUAL

For all CP/M-based systems. Requires 32K RAM, one disk drive and CRT or video display and keyboard.

- A character oriented full screen video display text editor designed specifically for program preparation of COBOL, FORTRAN, BASIC and similar programs.
- Features include single key commands for cursor control, scrolling, block moves, search and replace, tab setting and multiple file insertions.

NEVADA COBOL

\$199.95

DISKETTE AND MANUAL



For all CP/M or MP/M operating systems. Requires 32K RAM and one disk drive.

- Edition II of Nevada COBOL is based on ANSI-74 Standards.
- With 48K RAM, you can compile and execute up to 4000 statements.
- COPY statement for library handling.
- CALL...USING...CANCEL
- PERFORM...THRU...TIMES...UNTIL...paragraph or section names.
- IF...NEXT SENTENCE...ELSE...NEXT SENTENCE AND/OR <=> NOT.
- GO TO...DEPENDING ON...
- Interactive ACCEPT/DISPLAY...
- RELATIVE (random) access files
- Sequential files both fixed and variable length.
- INSPECT...TALLYING...REPLACING.



ELLIS COMPUTING
SOFTWARE TECHNOLOGY

600 41st Avenue, Dept. B
San Francisco, CA 94121
U.S.A.

COD's WELCOME



(415) 751-1522

CP/M, MP/M, TRS-80 and SoftCard system are registered TM's of Digital Research, Tandy Corporation and Microsoft respectively. Osborne 1 is a trademark of Osborne Computer Corporation.

AIM for Control

For process control or industrial development systems, put Rockwell's AIM 65 to work for you. Use off-the-shelf AIM-Mate Series and STD BUS expansion products to configure the system you need.

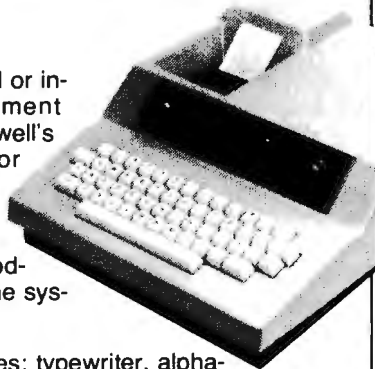

The AIM 65 includes: typewriter, alphanumeric LED display, and fast thermal printer.

Plug-in options include: memory (to 48K), ROM languages, parity protection, video display, floppy disk storage, STD BUS expansion cage, TTL and real world interfaces, and complete system software.

Call or write for complete AIM-Mate Series information.



87070 Dukhobar Road, Eugene, Oregon 97402 (503) 485-8575

- Manufactured Under BELL SYSTEM License.
- 300-1200 Baud Full Duplex Operation with Built-In Dialer and Re-Dial Capability.
- EIA (RS232C) Terminal Interfacing with Asynchronous or Synchronous Operation.
- FCC Approved Direct Connect to Telephone Line.
- Diagnostics Include Both Digital and Analog Loopback plus Self Test and Eight LED Status Indicators.

9212A SERIES

\$785 SINGLE-UNIT END USER. OEM RE-SALE DISCOUNTS AVAIL. CALL 800-528-8423



RACK MOUNT AVAILABLE

TOTAL BELL 212A COMPATIBILITY!



OMNITEC DATA
New Dimensions in Modems

2405 South 20th Street • Phoenix, Arizona 85034

WICAT



Motorola 68000, 256K Parity memory, 10MB Winchester disk, 760KB floppy, terminal, system software language.

Single user 150-1 \$ 9,450
Three users 150-3 \$10,850
Six users 150-6(512K) . \$12,850

Options: graphics IEEE 488 instrumentation interface, videodisk controllers, A/D boards, printers
MULTIBUS™ is a trademark of INTEL Corporation

WICAT computers have set a three fold standard of excellence in price/performance, mature system software, and full nationwide maintenance and service.

System 150

This popular computer gives you a professional minicomputer at microcomputer prices. It is well suited for software development and integrated business systems. With graphics, the IEEE 488 interface, or IEEE MULTIBUS A/D boards, the System 150 becomes an outstanding engineering or laboratory computer.

System 100

This larger computer is software compatible with the System 150. It can be expanded to 32 users and can utilize the new SMD 474MB disk drives. If your number crunching creates large timesharing bills, look at this computer.

Integral Database

Concurrent's **Integral™** manages the large data bases possible on a WICAT computer. Records are organized into sets to access related data. **Integral™** is efficient and easy to learn and use. It promotes rapid development of integrated business systems.

Menu System

Menu System provides a menu driven environment for your application system. Screens are created, modified, and linked into a menu tree without programming. Programs are only concerned with data on the screen and not the format.

Concurrent can discuss your needs and help you select the proper configuration. Please write or call (513) 281-1270



Concurrent™ Corporation
1870 Madison Road Cincinnati, Ohio 45206

INS8070 Series Instruction Set Summary

James Chiang
Applications Engineer
National Semiconductor
2900 Semiconductor Dr.
Santa Clara, CA 95051

ductor's SC/MP processor. The table below shows a similar summary of the instruction set of the new INS8070 series processor.

The table separates hexadecimal codes into the high-order digits, which are in the leftmost column, and lower-order digits in the top row. Mnemonics are found within the table. The abbreviation PTR refers to the four 8070 pointer registers: PC, SP, P2, and P3. The register-

In the January 1981 BYTE (page 90), Professor Walter E. Burton Jr. of Southern Technical Institute presented a handy table of the instruction set of National Semicon-

		Low-Order							
		0	1	2	3	4	5	6	7
High-Order Hexadecimal Digit	0	NOP	XCH A,E					LD A,S	LD S,A
	1	CALL 0	CALL 1	CALL 2	CALL 3	CALL 4	CALL 5	CALL 6	CALL 7
	2	JSR		PLI P2	PLI P3	JMP	LD SP = I	LD P2 = I	LD P3 = I
	3	LD EA,PC	LD EA,SP	LD EA,P2	LD EA,P3				
	4	LD A,E				LD PC,EA	LD SP,EA	LD P2,EA	LD P3,EA
	5	AND A,E				PUSH PC		PUSH P2	PUSH P3
	6	XOR A,E				BP		BP P2	BP P3
	7	ADD A,E				BRA		BRA P2	BRA P3
	8	LD EA	LD EA	LD EA	LD EA	LD EA	LD EA	LD EA	LD EA
	9	ILD A	ILD A	ILD A	ILD A		ILD A	ILD A	ILD A
	A	LD T	LD T	LD T	LD T	LD T	LD T	LD T	LD T
	B	ADD EA	ADD EA	ADD EA	ADD EA	ADD EA	ADD EA	ADD EA	ADD EA
	C	LD A	LD A	LD A	LD A	LD A	LD A	LD A	LD A
	D	AND A	AND A	AND A	AND A	AND A	AND A	AND A	AND A
	E	XOR A	XOR A	XOR A	XOR A	XOR A	XOR A	XOR A	XOR A
	F	ADD A	ADD A	ADD A	ADD A	ADD A	ADD A	ADD A	ADD A
PTR	PC	SP	P2	P3	PC	SP	P2	P3	
	PC-Relative	Pointer-Relative			Immediate	Direct	Auto-Indexed		
Addressing									

pointer names are associated with their related instructions in the same column of table 1's lower half.

Different addressing modes associated with the lower half of the table are located along the table's bottom. The second operands of the instructions LD SP, LD P2, LD P3, AND S, and OR S, all in the table's upper half, are of immediate mode. Blanks in the table identify illegal op codes. ■

Technical Forum is a feature intended as an interactive dialog on the technology of personal computing. The subject matter is open-ended, and the intent is to foster discussion and communication among readers of *BYTE*. We ask that all correspondents supply their full names and addresses to be printed with their commentaries. We also ask that correspondents supply their telephone numbers, which will not be printed.

Hexadecimal Digit									
8	9	A	B	C	D	E	F		
PUSH EA	LD T,EA	PUSH A	LD EA,T	SR EA	DIV EA,T	SL A	SL EA		1-Byte Instructions
CALL 8	CALL 9	CALL A	CALL B	CALL C	CALL D	CALL E	CALL F		
				MPY EA,T	BND	SSM P2	SSM P3		
POP A	AND S=I	POP EA	OR S=I	SR A	SRL A	RR A	RRL A		
LD E,A				XCH EA,PC	XCH EA,SP	XCH EA,P2	XCH EA,P3		
OR A,E				RET		POP P2	POP P3		
				BZ		BZ P2	BZ P3		
SUB A,E				BNZ		BNZ P2	BNZ P3		
ST EA	ST EA	ST EA	ST EA		ST EA	ST EA	ST EA		
DLD A	DLD A	DLD A	DLD A		DLD A	DLD A	DLD A		
									2-Byte Instructions
SUB EA	SUB EA	SUB EA	SUB EA	SUB EA	SUB EA	SUB EA	SUB EA	SUB EA	
ST A	ST A	ST A	ST A		ST A	ST A	ST A		
OR A	OR A	OR A	OR A	OR A	OR A	OR A	OR A	OR A	
SUB A	SUB A	SUB A	SUB A	SUB A	SUB A	SUB A	SUB A	SUB A	
PC	SP	P2	P3	PC	SP	P2	P3		
PC-Relative	Pointer-Relative			Immediate	Direct	Auto-Indexed			
Mode									

It All Depends on Your Viewpoint

A Review of the ADDS Viewpoint Video Terminal

Allen D. Moore
28619 Southeast 225th St.
Maple Valley, WA 98038

A video terminal with a list price of \$650 normally does not have such features as a separate keyboard, a choice of visual attributes, editing capabilities, and a 12-inch video screen whose viewing angle can be adjusted. Yet these are only some of the features found in the Viewpoint terminal manufactured by Applied Digital Data Systems (ADDS). When it was announced in March

1981, I thought it could be a cost-effective addition to the home-computer system I was in the process of building. After my Viewpoint (see photo 1) arrived, almost daily use of it confirmed my initial impression—it's an impressive terminal for the price.

Hardware Features

The Viewpoint consists of two separate units: the keyboard and the video display. A detachable coiled cord neatly connects the keyboard to the display unit. Although the external construction is all plastic, it seems sturdy enough for normal use. The 72-key keyboard, similar in design to an IBM Selectric typewriter, includes a separate numeric keypad to the right of the main keyboard.

The keypad also contains a set of cursor-control keys that, when used in conjunction with the Shift key, permit the cursor to be moved up, down, right, left, or to home (upper left corner). Above the keypad are three keys labeled F1, F2, and F3. These "soft" keys have their function assigned by the user. Each key produces a two-character code sequence. The first character is a Control-B; the second is '1', '2', or '3', corresponding to F1, F2, or F3, respectively. Pressing the Shift key while using these soft keys results in the second character being an exclamation point, quote, or pound sign. These keys open up a wide range of applications in interactive computing. For example, "Star Trek" fans could have one key for phasers, another for photon torpedoes, and a third for probe launching. Or an editing package could recognize them as various kinds of insert and delete commands.

The rest of the keyboard is fairly standard. When power comes on, it is in an uppercase-only mode for the alphabetic characters. To get lowercase characters, you press the Lock key. It would have been nice if ADDS had added an LED (light-emitting diode) to indicate when the keyboard is in "all caps" mode, but this is only a minor ir-



Photo 1: The Viewpoint video terminal manufactured by Applied Digital Data Systems.

At a Glance

Name

ADDS Viewpoint

Use

Video terminal

Manufacturer

Applied Digital Data Systems Inc.
100 Marcus Blvd.
Hauppauge, NY 11787
(516) 231-5400

Price

\$650

Dimensions

Display unit: 35.6 by 36.8 by 31.4 cm (14 by 14½ by 12¾ inches)
Keyboard unit: 38.1 by 17.8 by 6.7 cm (15 by 7 by 2⅝ inches)
Weight: 10 kg (22 lbs)

Features

Two-position, tilting display with 30.5-cm (12-inch) diagonal screen; format is 24 lines by 80 characters; displays 96 ASCII characters, plus special characters for French, German, Swedish, Danish, Spanish, and Dutch (switch-selectable), formed in a 5 by 8 dot pattern on a 7 by 10 dot matrix (lowercase letters have descenders); five visual attributes available: reverse video, half intensity, blink, underline, and video suppress; four different cursor formats; control codes provide absolute and relative cursor positioning, plus three screen-erase functions; separate 72-key Selectric-style keyboard includes numeric keypad and three function keys; RS-232C interface plus an auxiliary port; 110, 150, 300, 1200, 2400, 4800, 9600, and 19,200 bits per second switch-selectable; half or full duplex

Documentation

Viewpoint User Reference Card, Part No. 518-30400, one page; Viewpoint User's Manual, Part No. 518-30000, 40 pages; How to Maintain Viewpoint, Part No. 518-30200

Audience

Virtually all personal-computer users

ritation. One nice feature that has been included is that all keys have an auto-repeat feature. If any key is held down for more than a second, that character is repeated at a rate of about 16 cps (characters per second). The keys themselves are moderately stiff, providing good tactile feedback. I have had no problems with key bounce or missed characters.

The display screen comes in an attractive white plastic housing with nonglare black trim. An LED in the lower right-front corner of the unit lights up when power is turned on. The power switch is in back, along with a fuse holder, the telephone-style 4-wire jack for the keyboard cable, the line cord, a DIP switch, two RS-232C connectors, and a contrast control. Underneath the unit toward the back is a little fold-out stand that tilts the screen to minimize glare from overhead lighting.

The rear-panel DIP switch is one of two DIP switches in the Viewpoint (the other is located inside, on the main printed-circuit card). The outside DIP provides data-rate selection (the eight standard rates available are 110, 150,

300, 1200, 2400, 4800, 9600, and 19,200 bps), auto scrolling, auto linefeed, half or full duplex, and a choice of parity (odd, even, marking, or spacing).

The RS-232C connector marked EIA is the one used to connect your computer or modem. The connector labeled AUX can be used for another serial device, such as a printer. From the keyboard or from the host computer, the Viewpoint can be commanded to act transparently with respect to the input data stream. In this mode, everything received by the EIA port is passed directly to the AUX port without appearing on the screen. The terminal will not respond to any control commands until commanded back to the nontransparent mode.

As impressive as the Viewpoint is from the outside, it is only when you remove the top cover that you really begin to appreciate what ADDS has done. With the cover off, you look down on the main printed-circuit board. The 6.5- by 8-inch board contains only 11 integrated circuits.

ADDS had Standard Micro Systems build it a custom LSI (large-scale integration) video-controller integrated circuit. The result was a 28-pin package that streamlined the Viewpoint's design considerably. A Zilog Z8 microprocessor controls the input and output of data, and a 2K by 8-bit memory device serves as the video memory.

The remaining eight ICs are common TTL (transistor-transistor logic), including two for RS-232C interfacing. Also seen is the other DIP switch. One pole of this switch enables you to select light characters on a dark background (or vice versa). Other switches select parity enable or disable, a 50- or 60-hertz (Hz) screen-refresh rate, a steady or blinking cursor, and a box-type or underline cursor.

Also, in addition to the standard ASCII character set, six international character sets are available: Belgium/-France/Azerty, Germany/Switzerland, Sweden/Finland, Denmark/Norway, Spain, and the UK/Netherlands. Some of these sets rearrange the keyboard slightly. It would have been nice if these additional symbols could have been indicated on the keyboard. You are probably thinking, "Neat, but why do I care if my terminal can type in French?" Well, foreign-language character sets open up yet another application for the personal computer. Wouldn't it be nice to have your computer drill you in French and actually be able to type your responses using the correct punctuation and characters? And as the new low-cost printers continue to add special features like foreign-language character sets (for example, the Epson MX-80), even more possibilities open up. How about word processing—*auf Deutsch*? The Viewpoint also has a switch setting for one more alternate character set. It's marked "reserved" in the documentation and appears not to be used. It would have been nice to have had APL here.

One other option can be selected. The printed-circuit board contains a place for a jumper. Soldering in a piece of wire here causes the terminal "bell" to sound each time a key is pressed. I tried this out and quickly decided it

Command	Hexadecimal Code	From Keyboard
Backspace	08	BACKSPACE or CTRL-H
Cursor Addressing, Absolute	1B 59 r c*	ESC Y 'row char' 'column char'
Cursor Down	0A	CTRL-J or SHIFT-I
Cursor Home	01	CTRL-A or SHIFT-HOME
Cursor Left	15	CTRL-U or SHIFT-←
Cursor Right	06	CTRL-F or SHIFT-→
Cursor Up	1A	CTRL-Z or SHIFT-I
Erase to End of Line	1B 4B	ESC K
Erase to End of Page	1B 6B	ESC k
Erase Screen	0C	CTRL-L
Keyboard Lock	1B 35	ESC 5
Keyboard Unlock	1B 36	ESC 6
Monitor Mode On	—	CTRL-1
Monitor Mode Off	—	CTRL-2
New Line	0D	CTRL-M or RETURN
Ring Bell	07	CTRL-G
Set Attribute	1B 30 x**	ESC 0 'attribute char'
Store Control Character	1B 5A	ESC Z
Tag Bit Set	0E	CTRL-N
Tag Bit Reset	0F	CTRL-O
Transparent Print On	1B 33	ESC 3
Transparent Print Off	1B 34	ESC 4

*r and c are the row and column numbers plus 20 hexadecimal. Row and column numbering begins with 0.
 **x is the visual-attribute-code byte. See table 2.

Table 1: Command codes for the ADDS Viewpoint.

was annoying—the bell's sound is quite piercing. However, in some situations this could be a useful extra.

The bell is located inside the keyboard unit, which is another example of simplicity in design. Taking the bottom off reveals a sturdy-looking printed-circuit board with just five integrated circuits, one of which is an Intel 8021 single-chip microcomputer (the keyboard controller).

Having the keyboard as a separate unit is a feature I am appreciating more and more. My crowded workbench does not have enough room for a conventional video terminal with an integral keyboard. With the Viewpoint, however, I can position the display unit off to one side and still have ample room for the keyboard. If things are really crowded, I can even put the keyboard in my lap!

The Viewpoint's display format is the standard 24 lines of 80 characters. The display uses a white, medium-persistence phosphor. Uppercase characters are formed within a 5 by 7 matrix, but lowercase characters with descenders use another dot row to give a true lowercase format. Ten dot lines are allotted to each character row. The top row is always blank and serves to separate the character from characters in the line above it. The bottom row is used for the underline character.

Control Codes

Having covered all the hardware features, I'd now like to briefly describe the control codes recognized by the terminal (see table 1). Absolute cursor addressing is available, as are relative cursor-control commands. The three erase commands are Erase to End of Line, Erase to End of Page, and Erase Screen. The keyboard can be "locked" and will not recognize any keypresses until receiving an

unlock command. A monitor mode is available that displays all control codes as underlined characters. For example, CTRL-G would appear as G. A command called Store Control Character performs the same function as the Monitor Mode command, but acts only on the next character in the data stream.

Four different visual attributes can be applied to designated portions of the screen: half intensity, blink, reverse video, and underline. These attributes can also be combined in a variety of ways to produce striking visual effects (see table 2). Video can also be suppressed entirely.

The areas of the display to be affected by the chosen visual attributes are designated by setting a tag bit associated with each character position on the screen.

Attribute	Hexadecimal Code
Normal	40
Half Intensity	41
Blink	42
Half Intensity, Blink	43
Video Suppress	44
Reverse Video	50
Reverse Video, Half Intensity	51
Reverse Video, Blink	52
Reverse Video, Half Intensity, Blink	53
Underline	60
Underline, Half Intensity	61
Underline, Blink	62
Underline, Half Intensity, Blink	63

Table 2: Visual-attribute codes for the Set Attribute command (ESC 0 x). Four attributes—half intensity, blink, reverse video, and underline—can be combined in a number of ways, though not all combinations are included.

Unfortunately, a selected attribute will affect all characters tagged. It is not possible, for example, to have part of the screen in reverse video and another part blinking.

Documentation

The documentation that arrived with my terminal consisted of a photocopy of the user-reference card and a postcard, addressed to the president of ADDS, for any comments I might have. However, two manuals are available as optional extras. The user's manual costs \$15; the maintenance manual costs \$75. Since ADDS claims a 10,000-hour MTBF (mean time between failures) rate for the Viewpoint, I decided not to get the maintenance manual right away.

Conclusions

The ADDS Viewpoint offers good performance and a number of special features for the surprisingly low price of \$650. Some of these features, such as a separate keyboard and function keys, have been found only on terminals costing much more.

Human-interface considerations were taken into account in designing a two-position tilting display and a keyboard unit housed separately. This is a welcome step in the direction of making data-processing equipment more compatible with the people who will be using it, rather than requiring people to adapt to the equipment.

Function keys providing up to six unique control-code sequences enable you to customize the keyboard for a specific application. The host computer can be programmed to respond to these codes in any manner you desire. The Viewpoint has a large command repertoire, responding to the 22 ASCII command codes listed in table 1.

Six alternate character sets are switch-selectable to provide special characters and punctuation marks required by foreign languages. Although this feature was no doubt included to enhance the Viewpoint's reception by the overseas market, it also opens up possibilities for users in the United States. Used in conjunction with a printer that has foreign-language character sets, a word-processing system becomes practical for people such as translators, foreign-language students, and businesspeople doing business both here and abroad.

The well-built Viewpoint's low component count should result in good reliability and ease of repair when something does go wrong. The 10,000-hour MTBF rate works out to almost 417 days of continuous operation.

The documentation that comes with the terminal is adequate to set up the Viewpoint, but the *Viewpoint User's Manual* should be consulted to fully understand some of the commands. Unfortunately, it seems to take an inordinate amount of time to receive a copy of the manual.

For the money, I don't believe you can do better than the ADDS Viewpoint. At the same time, it's a quality piece of equipment. I recommend it to anybody looking for a low-cost, quality terminal for either personal or business use. ■

Get Fast Delivery and Discount Pricing on Personal, Business and Hobby Software!

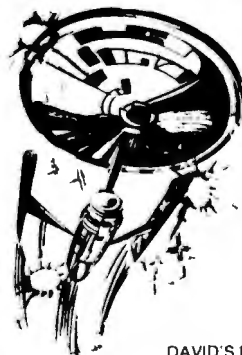

- Free Delivery on Orders Over \$50.00!
- Over 1,000 Programs From Over 80 Manufacturers
- Massive Inventory - 95% of Orders Ship Within 24 Hours
- 15 - 25% Discount On All Products For Example:

	List	Now
DB MASTER®	\$229.00	\$179.00
VISICALC®	\$250.00	\$199.00
TIME ZONE	\$99.95	\$77.50
DAVID'S MIDNIGHT MAGIC	\$34.95	\$27.50

Hardware

Zenith 12" Green Monitor	\$149.95	\$129.95
Lower Case ROM	29.00	24.95
Tymac Parallel Printer Board	139.00	105.00
C.I.T.O.H Daisy-Wheel Printer	NEW 1,995.00	1,495.00
C.I.T.O.H Dot Matrix Printer: 100 CPS, Bi-directional, Hi-Res Graphics	NEW 795.00	525.00
Zenith Computer Systems & Accessories		Call
Smith-Corona Daisy-Wheel Printer	Now Price	750.00

Blank Diskettes

Elephant Memory Systems (E.M.S.) Heavy Duty, Guaranteed 100% Error Free, with Hub Rings			
	E.M.S.	Memorex	Maxell
5 1/4" Single Sided			
Single Density, Soft Sector	\$24.95	\$34.95	\$38.95
5 1/4" Single Sided, Double Density			
Soft Sector 10 Sector or 16 Sector	34.95	39.95	49.95
Double Sided, 8" and Other Disks Available.			

DISK Drive Head Cleaning Kits

Compatible With Any Single or Double-Sided Diskette Drives.	
5 1/4" Head Cleaning Kit, FD-5	\$30.00
8" Head Cleaning Kit, FD-8	30.00

ALL Software and Accessories From These and Other Manufacturers Are Available With Full, No Hassle 90 Day Guarantee

Adventure International - Broderbund Software - Budgeco - Datasoft
Edu-Ware - Gebelli - Hayden - Howard - Innovative Design - Micro Lab
Micro Pro - Microsoft - Muse - On-Line Systems - Piccadilly - Sensible
Visicorp [Personal Software] - Sirius - Stoneware - Synergistic - TG Products

FREE FAST DELIVERY!
on orders over \$50



95%
of orders
shipped within
24 hours!

We take MasterCard and VISA (include card number and expiration date). Maryland residents add 5% sales tax. Include \$2.00 for postage on orders less than \$50.00. Add \$1.50 for C.O.D. orders. Foreign and hardware extra. Send for free catalog. Prices subject to change.

© Apple is a Registered Trademark of Apple Computer, Inc.
© ATARI is a Registered Trademark of ATARI, Inc.
© TRS-80 is a Registered Trademark of Tandy Corporation.

[Dealer Inquiries Invited]

CHROMANETICS CORPORATION

4084 HOWARD AVENUE • KENSINGTON, MD 20895

BALTO. - ANNAPOLIS (301) 532-2506
MD., D.C., NORTH VA. (301) 949-4488
OUTSIDE MARYLAND 1-800-368-2805

CLIP & SAVE

Database Management with Ashton-Tate's dBASE II

Jack L. Abbott
8525 North 104th Ave.
Peoria, AZ 85345

At a Glance

NAME

dBASE II Version 2.02A

Type

Assembly-language relational database management system

Manufacturer

Ashton-Tate
9929 Jefferson
Los Angeles, CA 90230
(213) 204-5570

Price

\$700

Format

Two disks for TRS-80 Model II, North Star, Apple II with Z80 card,
IBM soft sector, single density; other formats available

Software Required

CP/M operating system, version 1.4 or 2.xx

Language

8080 machine language

System Needed

Any microcomputer with a Z 80, 8080 or 8085 processor; at least
48K bytes of memory; 24-line by 80-column display; printer
required

Documentation

220-page loose-leaf manual

Audience

Anyone with a microcomputer who wants a good database-
management system.

dBASE II is a database management system (DBMS) program developed by Ashton-Tate of Los Angeles, California. A DBMS program accepts data in a format you establish, sorts it in the order you desire, and excerpts, summarizes, and mathematically manipulates the data as required. The program then presents the data in the format (report) that you set up. The report can be in the form of a table, a check, an invoice, or any similar document. Potential uses for a DBMS program are broad and include form generation, mailing lists, check writing, inventory, and accounting.

**You can use the trial disk for up to
30 days and still return the
dBASE II package for a refund.**

Because a DBMS is designed to handle applications ranging from simple to very complex, any review must be general in nature. Ashton-Tate has a novel promotional offer that should help you determine if this rather expensive (\$700) program will suit your particular application. If you order the dBASE II package you'll receive a trial disk as well as the conventional distribution disk. The trial disk can handle only a limited number of data records, but in other respects it's identical to the regular dBASE II disk. You can use the trial disk for up to 30 days and still return the dBASE II package for a refund. When you open the envelope containing the dBASE II disk, the sale becomes final.

Listing 1: A listing of the display invoked by dBASE II's CREATE command. This display helps the user set up a format for input. The number of each field appears at left, followed by its data type, its width, and (optionally) its number of decimal places. Data types are "C" for character, "N" for numeric, and "L" for logical.

```

ENTER FILENAME: MOBINV
ENTER RECORD STRUCTURE AS FOLLOWS:
  FIELD   NAME,TYPE,WIDTH,DECIMAL PLACES

001      STOCK:NU,C,15  REMARK: This comment does not appear
002      SUPPLIER,C,15  on the display. Field # 1 is
003      MODEL,C,10     Stock Number, C—a character field
004      ORD:DATE,C,9   , 15 characters in length.
005      REC:DATE,C,9   Field # 4 is Order Date, # 5 is
006      COST,N,10,2    Received Date, # 7 is Sale Price
007      SELL:PR,N,10
008
INPUT DATA NOW? N

```

dBASE II is a "relational" DBMS as opposed to the more common "tree" or "hierarchical" type. It's beyond the scope of this article to discuss these different types in detail, but I will say now that a well-designed relational DBMS is fast and eliminates a considerable amount of the program overhead required by some other types. At the end of this article, I will touch on the differences among the major types of DBMS programs.

dBASE II requires CP/M operating system version 1.4 or 2.xx and 48K bytes of memory. Z80-, 8080-, or 8085-based microcomputers are required because the program is written in machine language. Among the many computers using these processors are the TRS-80 Model II, North Star, Dynabyte, Vector Graphic, and the Apple II (with the Z80 card). Most applications of dBASE II require disk drives with a total storage capacity of at least 300K bytes. Simple programs can be developed without a printer, but for complex program design or extensive report output a printer is essential. dBASE II also requires a display terminal with at least 24 lines and 80 columns and an addressable cursor.

The program documentation contains two manuals in one book. The first is a narrative description and the second a programmer's manual. I found it necessary to review the pertinent portions of both manuals to understand some of the program functions. It would help if the document were indexed or if the two sections were consolidated. Much of the program description is excellent, but some operations are not described in sufficient detail. In a few instances commands and their descriptions differ from one section to another.

To install the program you use a menu to indicate what kind of equipment you have. You then follow the narrative portion of the documentation to establish the format for data input. I developed a mobile-home inventory program to help me learn how to use dBASE II and to demonstrate some of the program's functions. I finished the program less than three hours after I received the dBASE II package. This is quick indeed and speaks well for both the documentation and the DBMS design.

Listing 2: A listing of dBASE II's display that prompts the user for input. The prompts at left request data on each of the fields in accordance with the user's design of the input format (as shown in listing 1). The colons show the extent of each field.

```

RECORD #      :00001

STOCK:NU      :           :
SUPPLIER      :           :
MODEL         :           :
ORD:DATE      :           :
REC:DATE      :           :
COST          :           :
SELL:PR       :           :

```

Developing an Inventory Program

The first step in developing the inventory program was to establish the input data format. All the fields (items of information) pertaining to a single mobile home comprise a record. All the records taken together make up a file. dBASE II can have up to 65,345 records per file and up to 1000 characters per record divided among a maximum of 32 fields. No single field can be longer than 254 characters.

To begin establishing an input data format, you type the command CREATE, and get the first three lines of display like the printout shown in listing 1.

After determining the fields' names, lengths, and types—"C" for character, "N" for numeric, or "L" for logical (true or false)—entering data is simply a matter of typing it in. The program gives prompts to ensure that only legal entries are made. With the excellent full-screen editor, you can move the cursor around the display at will and then type in new parameters at the cursor location. In a display like the printout shown in listing 1, the last line of the display is "INPUT DATA NOW?" You can enter data records directly at that time or later by entering the command APPEND. Either choice generates

Listing 3: dBASE II's output reflecting data entered on five different records. Each record from number 1 through 5 has seven fields describing a mobile home: stock number, supplier, model, order date, received date, cost, and selling price (listed on a second line in every case). dBASE II made this listing in response to the LIST command.

00001	1234567XYZ	PALM HARBOR	2BR3BA60F	01/05/81	02/20/81	14375.75
18000						
00002	123456XYZ	NASHUA	1BR15B40F	03/02/81	04/06/81	12789.00
16000						
00003	23456MNB	LAYTON	2BR1BA40F	01/03/81	02/04/81	14000.00
18585						
00004	234567ABCDE	AIRSTREAM	EXCELLA	01/06/81	03/06/81	21000.00
24000						
00005	TRW1457B	SKYLINE	2BR1BA79F	04/03/81	05/08/81	24987.65
31650						

a display like the printout shown in listing 2.

The next step in using the inventory program is to type in the information for each mobile home. The full-screen editing feature and a global edit (all records or selected records of the entire file) are available to make any changes required. The RECORD # is assigned and incremented by the program automatically. Listing 3 shows five data records I entered. This display was obtained in response to the dBASE II command LIST.

Manipulating Data

You can manipulate data in individual records or

globally. Data manipulations supported include mathematical (+, -, /, and *), relational (>, <, =, etc.), and logical (not, and, or). dBASE II permits any reasonable data manipulation. Three examples follow: (1) SELL:PRI (sale price) can be multiplied by 1.05 globally to include a 5 percent sales tax in all sale prices; (2) I could have included additional fields called QUANTITY and TOTAL:PR (total price) in the input record structure and then multiplied QUANTITY by COST and deposited the result in TOTAL:PR; (3) The relational and logical functions permit selection of individual records or groups of records. I can select all mobile homes supplied by

**YOU'VE JUST FOUND
THE MISSING LINK!**



Computer Shopper is your link to individuals who buy, sell and trade computer equipment and software among themselves nationwide. No other magazine fills this void in the marketplace chain. Thousands of cost-conscious computer enthusiasts save by shopping in Computer Shopper every month through hundreds of classified ads. And new equipment advertisers offer some of the lowest prices in the nation. Computer Shopper's unbiased articles make for some unique reading among magazines and there's a "help" column to answer difficult problems you may have with interfacing, etc. For a limited time you can subscribe to Computer Shopper with a six month trial for only \$6.

6 month trial, \$6⁰⁰ Call Toll Free MC & VISA **800-327-9920**
except Florida, Hawaii, Alaska

or send
check to:  **COMPUTER SHOPPER**
P.O. Box F302 • Titusville, FL 32780
305-269-3211

EPISODE™
**THE
VERSATILE
COMPUTER**



**JUST ADD
PERIPHERALS**

EPISODE is a CP/M® computer with 1.6 M byte of disk storage on dual 5¼ floppies. Its compact design provides a wide range of standalone or network applications including data base sharing. EPISODE gives you total flexibility. You can add your own CRT and Printer, whatever brand and price range you choose. All the logic including the 64K RAM memory is contained on a single 6" x 8" circuit board ensuring maximum reliability.

EPISODE includes a unique software system called SUPERVYZ™ - a menu based software control system that allows the user to integrate application programs.

Dealer inquiries invited, foreign and domestic.



Epic Computer Corporation
7542 Trade Street
San Diego, CA 92121
Tel: 714-695-3560

*Supervyz is a trademark of Epic Computer Corporation. CP/M is a trademark of Digital Research.

Listing 4: A report generated by dBASE II's REPORT command. This report presents almost the same information as listing 3, but uses a clearer format and provides totals of costs and sale prices.

MOBILE HOME INVENTORY REPORT

DATE RCVD.	STOCK NO.	SUPPLIER	COST	SALE PRICE
02/20/81	1234567XYZ	PALM HARBOR	14375.75	18000
04/06/81	123456XYZ	NASHUA	12789.00	16000
02/04/81	23456MNB	LAYTON	14000.00	18585
03/06/81	234567ABCDE	AIRSTREAM	21000.00	24000
05/08/81	TRW14578	SKYLINE	24987.65	31650
** TOTAL **			87152.40	108235

Nashua and Skyline and increase their sale price by 20 percent by entering this command:

```
REPLACE ALL SELL:PR WITH SELL:PR/.8 FOR
SUPPLIER='NASHUA'.OR.; 'SKYLINE'
```

It's possible to sort the file using a field of any type other than logical. As an alternative, dBASE II will index the file. This feature lets you sort all the records by using only the data in one user-specified "key" field. A record can then be retrieved very quickly because only the key-field data need be searched, as opposed to all the fields of each record in the file. I used a 2000-record, 4000-field simulated database to test this DBMS and located individual records within an unbelievable 2 seconds. After locating the desired record, you can then display as many more sequential records as you wish by entering the command DISPLAY NEXT ##. This speed and versatility means that real-time updates are easy to do. You can search an inventory file for a specific item (record) in seconds. You can edit the record in a few more seconds to reflect any changes in quantity or reorder requirements, for example.

Files generated by CP/M use a standard data format (SDF) while CBASIC and many other languages generate delimited formats. dBASE II includes a program module to convert either format to or from the file structure used by dBASE II. This is a very useful feature. The user must be certain that the dBASE II file structure field lengths are the same as those of the foreign file being converted to the dBASE II format. Selected fields from two different databases may be combined to form a third database by use of the command JOIN.

Making Reports

This brings us to the report function. Using the index feature you can find and list individual or sequential groups of records within a few seconds. Individual or nonsequential groups of records can be selected from a 2000-record database within two or three minutes using the logical and relational commands. dBASE II uses the CP/M convention of control P to initiate and terminate

listing on the printer of the records or other information you have selected. In addition, dBASE II has a REPORT command that does a limited amount of formatting and totaling of field data. The program leads you through definition of the report format. Listing 4 shows a typical report generated by this command.

Using the features reviewed up to this point, anyone familiar with CP/M can create in a few hours a dBASE II program that matches the complexity of the program that I have described.

BDOS ERROR ON B:BAD SECTOR



Before disk errors ruin your work again order BADLIM.

- BADLIM assures the reliability of your CP/M computer.
- You can use your disks 10 times longer without losing your data AND your time.
- BADLIM checks thoroughly your disk marking all the blocks which have defective sectors. The operating system will know that those sectors should be skipped.
- BADLIM is the only program that gives protection for soft and hard errors.
- The first time BADLIM will list which files in your disk are on bad sectors, so you can take action to correct it.
- But thereafter the bad areas in your disk will be automatically by-passed.
- For CP/M 1.4 single density and for CP/M 2.xx of any format and density. It is a must for Winchester as the media cannot be replaced.

BADLIM cost only \$73. Whatever the reason you have to use a computer you need BADLIM. Contact your dealer or call us today.

BLAT R&D Corp., 8016 188th. St SW, Edmonds
WA 98020. Phone: (206) 771-1408

DEALER INQUIRIES INVITED.

BADLIM

FREE NEBS COMPUTER FORMS CATALOG

Send today for our **NEW** full-color 56-page catalog with continuous checks, statements, invoices, stationery, envelopes, supplies and accessories. We will also send our **FORMS SELECTOR GUIDE**, to help you find the right forms for your software.

- **Quality products at low prices**
- **Available in small quantities**
- **Fast Service**
- **Money-Back Guarantee**
- **Convenient TOLL-FREE ordering**

Fast Service by mail or . . .PHONE TOLL FREE

1 + 800-225-9550

Mass. residents 1 + 800-922-8560

8:30 a.m. to 5:00 p.m. Eastern Time Monday — Friday

Please rush a new computer forms catalog to

NAME _____

COMPANY _____

STREET _____

CITY, STATE and ZIP _____

PHONE _____

Hardware and Software being used _____

 **Nebs**
Computer Forms

CODE 31460

78 Hollis Street, Groton, Massachusetts 01471
A division of New England Business Service, Inc.

Command Files

The preceding mobile-home-inventory DBMS program used individual commands. By using a word processor or editor (not included in dBASE II), you can group commands in a command file. Ashton-Tate says it will in the future build in the ability to create command files.

It's necessary for you to learn the dBASE II structured programming language to develop a command file. If you name the mobile-home command file MOBINV.COM, you could call it by typing DO MOBINV. You can structure a command file to provide a menu selection of the action wanted, including add, delete, edit records, and print a report. One command file may include up to 16 calls to other command files. You could also post the appropriate dollar figures to an accounting file for processing by another DBMS-program module.

In addition, a command file can generate a more sophisticated report than the REPORT command. A series of instructions places the data items at specific locations on the terminal or printer page. The row (line) and column positions are designated as grid coordinates. The real-time update of the inventory program mentioned earlier could be included in the command file and an invoice or receipt printed along with the search and adjustment of the inventory.

Advantages of the Relational DBMS

dBASE II is a "relational" DBMS in which each data record in a file effectively (but may not actually) contains all the data fields necessary for a group of application programs. The application programs all operate as an integral part of one DBMS rather than as numerous autonomous modules. Pointer files are eliminated, and that reduces program overhead and complexity. This design, combined with machine-language programming, results in a very fast, efficient DBMS. Because the whole structure is integrated, limiting access for security purposes in multiuser systems can be a problem. James Martin's *Principles of Data-Base Management* (Prentice-Hall, 1976) is one of many books that gives a thorough evaluation of the different types of DBMS programs.

Conclusions

Both fast and versatile, dBASE II is a superb program with generally excellent documentation. A newcomer to computing can easily develop a DBMS program with all the features of the mobile-home inventory example. I did extensive testing with a 4000-field database and found no program breakdowns or deficiencies. The dBASE II structured programming language lets you present or enter data in specialized formats such as mailing lists, checks, and invoices. You must, however, provide your own word processor or editor program if you're going to generate command files.

dBASE II can do real-time updates of the database. This can be of great value, particularly for inventory applications. But if you are in a multiuser environment you might have security problems because the database information may be available to all users. ■

Clubs and Newsletters

TRACE

The Toronto Region Association of Computer Enthusiasts (TRACE) is a non-profit organization for anyone interested in computing. Yearly dues are \$13, which includes *The TRACE Newsletter* and admission to group meetings. The newsletter is available separately for \$5 a year. Noncommercial ads are free with paid subscriptions. Contact TRACE, POB 6922, Station A, Toronto, Ontario M5W 1X6, Canada.

Hobbyists Meet In the Land of Lincoln

The Woodsfield Area Computerist Organization (WACO) is whacko about all types of computers: TRS-80s, Ataris, 6800s, Heaths, and Z80s. The club has a large number of special-interest groups and a large publication known as the *WACO Post*. The *Post* is packed with software reviews, information on bulletin-board systems, and programming hints. The club meets monthly at the downstairs meeting room in the Schaumburg Public Library. Annual dues are \$6, which includes a subscription to the newsletter. Contact WACO, Steve Gibson, 723 Sunfish Point, Schaumburg, IL 60194.

Sorcerer's Apprentice

The Sorcerer's Apprentice Users Group produces a newsletter eight times a year. The newsletter is packed with information for Sorcerer users of all degrees of expertise. The group maintains a computerized bulletin-board system in the Detroit, Michigan, area. Membership

in the group is open to Sorcerer users world-wide. Annual dues are \$18 in the United States, \$24 in Canada and Mexico, and \$32 elsewhere. In the Detroit area, the bulletin-board system can be accessed by calling (313) 535-9186 (ring-back). For further information, contact the Sorcerer's Apprentice, POB 33, Madison Heights, MI 48071; or contact the group president, Don Gottwald, at (313) 286-9265.

Amateur Group In Washington

Membership in the Washington Amateur Computer Society is open to anyone in the Washington, D.C., area interested in amateur computing. Dues are \$3.50 per year. The society produces a newsletter, *The Journal of the Washington Amateur Computer Society*, and is working on a hardware message system for the publication. The newsletter has information on club meetings, industry happenings, and projects. Contact the Washington Amateur Computer Society, 4201 Massachusetts Ave., #168, Washington, DC 20016.

Heath Fans Meet In Pacific Northwest

The Pacific Northwest Heath Users Group (PNHUG) meets on the first Monday of even-numbered months at the Heathkit Center, 505 8th Ave. North, in Seattle, Washington, at 7 p.m. On odd-numbered months, the group meets on the second Thursday at the Heathkit Center, 15439 53rd Ave. South, in Tukwila, Washington, also at 7 p.m. For more information, con-

tact PNHUG, Nathan A. Hall, POB 993, Bellevue, WA 98009, (206) 363-3927.

Michigan Hobbyists Are Active

The South Eastern Michigan Computer Organization (SEMCO) meets on the second Sunday of the month at the Ford Automotive Safety Center Auditorium at 7 p.m. The group produces a monthly newsletter, *Data Bus*, that is packed with hardware and software reviews and notes from special-interest groups. SEMCO operates a 300-bit-per-second message service that allows members to send and receive messages, write BASIC programs, execute stored programs such as games, and access the Michigan Occupational Information System. Membership in SEMCO costs \$10 per year, which includes a subscription to the *Data Bus*. Contact SEMCO, POB 02426, Detroit, MI 48202.

Superletter

Superletter is an international newsletter devoted to the Intertec Superbrain and Compustar computers. *Superletter* is packed with technical

news, accessory ideas, and CP/M software designs for the Superbrain. Other features include a technical corner, a question-and-answer forum, news from the Intertec factory, interviews, and classified ads. A subscription to the *Superletter* offers readers the opportunity to shop for enhanced PROMs (programmable read-only memories), advanced BIOS (basic input/output subsystems), graphic packages, and other hardware and software products. Annual subscription rates are \$20 in the U.S. and \$35 elsewhere. For complete details, contact *Superletter*, POB 3121, Beverly Hills, CA 90212, (213) 277-2410.

SCAN Eyes Computers In Arts

SCAN: Small Computers in the Arts News keeps a watchful eye on the use of small computers in the arts. It's filled with news of products, software, hardware, books, events, and people in the news. *SCAN* also acts as a clearinghouse for those interested in using small computers in the arts. Subscriptions cost \$8 per year (10 issues). Further information is available from *SCAN*, POB 1954, Philadelphia, PA 19105. ■

BYTE's Bits

Win a Compupro Board

Sluder, a Compupro systems center, is running a sweepstakes in which three winners will be awarded an assembled and tested Godbout Compupro CPU 8085/8088 processor board. To enter, send your name and address on a 3- by 5-inch post-

card to Sluder, POB 951, Westminster, CA 92683. The drawing will be held on July 16, 1982; winners will be notified by mail. Employees of Godbout Electronics and anyone with the last name Sluder are ineligible. ■

Software Received

Apple

Apple Flasher, a utility program for developing high-resolution graphics for the Apple II. Floppy disk, \$34.50. Crow Ridge Associates Inc., POB 90, New Scotland, NY 12127.

Audex, a collection of utility programs to create, edit, and play sounds for the Apple II. Floppy disk, \$29.95. Sirius Software Inc., 10364 Rockingham Dr., Sacramento, CA 95827.

Deadline, an interactive role-playing program for the Apple II. Floppy disk, \$49.95. Infocom, 55 Wheeler St., Cambridge, MA 02138.

DOS File Exchange, a telecommunications software package for the Apple II Plus. Floppy disk, \$45. Arrow Micro Software, 11 Kingsford, Kanata, Ontario, K2K 1T5, Canada.

8080/8085 Assembler, a cross-assembler for the Apple II. Floppy disk, \$39. A.M.I. Electronics, 851 Richmond Rd., Lyndhurst, OH 44124.

Estate Tax Plan, a program package to solve complex estate tax-planning problems for the Apple II. Floppy disk, \$695. Aardvark Software Inc., 783 North Water St., Milwaukee, WI 53202.

GraFORTH, a graphics programming language for the Apple II. Floppy disk, \$75. Insoft, Suite 202B, 10175 Southwest Barbur Blvd., Portland, OR 97219.

The Graphics Magician, a graphics development package for the Apple II. Floppy disk, \$59.95. Penguin Software, 830 4th Ave., Geneva, IL 60134.

Hungry Boy, an arcade-type game for the Apple II.

Floppy disk, \$24.95. Cosmos Astar International Co., 5676 Francis Ave., Chino, CA 91710.

IFR Flight Simulator, an instruments-only, air-flight simulator for the Apple II. Floppy disk, \$50. Programmers Software Exchange, POB 199, Cabot, AR 72023.

Kabul Spy, an adventure-type game for the Apple II Plus. Floppy disk, \$34.95. Sirius Software Inc. (see address above).

Micro-Window, a 6502 machine-language training and development program for the Apple II Plus. Floppy disk, \$120. Window Research, Suite #218, 13452-A Northeast 175th, Woodinville, WA 98072.

Minotaur, an arcade-type game based on the ancient Greek myth for the Apple II. Floppy disk, \$34.95. Sirius Software Inc. (see address above).

Payfive, a flexible payroll and accounting system for the Apple II Plus. Floppy disk, \$149.95. Dynacomp Inc., 1427 Monroe Ave., Rochester, NY 14618.

Photar, an arcade-type game for the Apple II. Floppy disk, \$29.95. Softape, 10432 Burbank Blvd., North Hollywood, CA 91601.

Routeplanner, a trip-planning program for deliveries or salespersons for the Apple II. Floppy disk, \$149. Columbia Software, 5461 Marsh Hawk Way, POB 2235, Columbia, MD 21045.

Snack Attack, an arcade-type game for the Apple II. Floppy disk, \$29.95. Data-most, 19273 Kenya St., Northridge, CA 91326.

Star Blaster, an arcade-type game for the Apple II. Floppy disk, \$29.95. Piccadilly Software Inc., 89 Summit Ave., Summit, NJ 07901.

Star Blazer, an arcade-type game for the Apple II. Floppy disk, \$31.95. Broderbund

Software Inc., 1938 Fourth St., San Rafael, CA 94901.

Suicide, an arcade-type game for the Apple II. Floppy disk, \$29.95. Piccadilly Software Inc. (see address above).

Atari

Baccarat, a card game for one to three players for the Atari 800. Floppy disk, \$22.95. Dynacomp Inc., 1427 Monroe Ave., Rochester, NY 14618.

Backgammon 2.0, a one- or two-player version of the board game for the Atari 800. Floppy disk, \$18.95. Dynacomp Inc. (see address above).

Caverns of Mars, an arcade-type game for the Atari 400/800. Floppy disk, \$39.95. Atari, 1265 Borregas Ave., Sunnyvale, CA 94086.

Chicken, an arcade-type game for the Atari 400/800. Cassette or floppy disk, \$29.95. Synapse Software, 820 Coventry Rd., Kensington, CA 94707.

Deluxe Invaders, an arcade-type game for the Atari 400/800. Floppy disk, \$34.95. Roklan Corp., 10600 West Higgins Rd., Rosemont, IL 60018.

Escape from Volantium, an arcade-type game for the Atari 800. Floppy disk, \$19.95. Dynacomp Inc. (see address above).

The Family Budget, a personal financial-management package for the Atari 800. Floppy disk, \$34.95. Dynacomp Inc. (see address above).

The Graphics Machine, a graphics utility program for the Atari 800. Floppy disk, \$19.95. Santa Cruz Educational Software, 5425 Jigger Dr., Soquel, CA 95073.

Go Fish, the children's game for one player for the Atari 800. Floppy disk, \$18.95. Dynacomp Inc. (see address above).

TELEPHONE VOICE RESPONSE

The V100 interactive voice synthesizer

with telephone interface is an Apple II® or IBM Personal Computer® compatible, low-cost, solution to remote data base access arrangements.

\$395.00
V100-A

- Direct telephone connection, auto-dial/answer
- Touch-tone® generation and detection
- Includes 1000 word, LPC allophone vocabulary
- Software for sentence/library construction
- Expandable with 300 (\$150) or 1300 (\$495) high quality LPC words

For a demonstration call toll free (800) 538-7002
In California call (408) 942-1595

VYNET CORPORATION

2405 Qume Dr., San Jose, CA 95131
(408) 942-1037



Lil' Men from Mars, an arcade-type game for the Atari 800. Floppy disk, \$23.95. Dynacomp Inc. (see address above).

Mailmaster, a mailing-list utility program for the Atari 800. Floppy disk, \$39.95. Dynacomp Inc. (see address above).

Protector, an arcade-type game for the Atari 400/800. Floppy disk, \$29.95. Synapse Software (see address above).

Stockaid, a stock performance-analysis program for the Atari 800. Floppy disk, \$29.95. Dynacomp Inc. (see address above).

Teacher's Aide, a tutorial package covering elementary mathematics for the Atari 800. Floppy disk, \$17.95. Dynacomp Inc. (see address above).

Tricky Tutorials, a six-lesson package covering advanced programming for the Atari 400/800. Floppy disk, \$99.95. Santa Cruz Educational Software (see address above).

Turnkey and Menu, an auto-execute utility for BASIC programs for the Atari 800. Floppy disk, \$17.95. Dynacomp Inc. (see address above).

CP/M

68000 Disassembler, a disassembler for 68000 systems based on the Motorola Exor-mac. 8-inch floppy disk, \$200. Norsoft Consultants, Veungsdalveien 1, 3600 Kongsberg, Oslo, Norway.

The Programmer's Apprentice, a program-development system for creating MBASIC source programs for CP/M. 8-inch floppy disk, \$800. The Software Group, 10471 South Brookhurst St., Anaheim, CA 92804.

PET

Genesis, a program to develop computer-assisted in-

structions for the PET/CBM. Cassette, \$30. Greenwood Software, 1214 Washington, The Dalles, OR 97058.

Phantom Fighter, an arcade-type game for the PET/CBM. Cassette, \$14.95. Magic Carpet, POB 35115, Phoenix, AZ 85069.

Pharmacology Update, a tutorial package for health-care professionals for the PET/CBM. Floppy disk, \$149.95. Dynacomp Inc., 1427 Monroe Ave., Rochester, NY 14618.

Star Voyager, an arcade-type game for the PET/CBM. Cassette, \$9.95; floppy disk, \$12.95. Paul Yates, 1955 Shady Brook Lane, Morgan Hill, CA 95037.

Vortex, an arcade-type game for the PET/CBM. Cassette, \$14.95. Magic Carpet (see address above).

TI-99/4

Space Spiders, an arcade-type game for the TI-99/4. Cassette, \$9. Glo-Data, POB 374, Stony Point, NY 10980.

Video Titles I, a program to produce customized titles for video recordings for the TI-99/4A. Floppy disk, \$24.95. J & KH Software, 2820 South Abingdon St., Arlington, VA 22206.

TRS-80

BASIC Faster and Better Demonstration, a software library of demonstration programs for use with the book *Faster and Better & Other Mysteries* for the TRS-80 Models I and III. Floppy disk, \$19.95. IJG Inc., 1260 West Foothill Blvd., Upland, CA 91786.

BASIC Faster and Better Library, a software library of routines for use with the book *Faster and Better & Other Mysteries* for the TRS-80 Models I and III. Floppy disk, \$19.95. IJG Inc. (see address above).

Battle Trek, a Star Trek-type game for the TRS-80 Models I and III. Cassette, \$29.95. Voyager Software, POB 15-518, San Francisco, CA 94115.

Ghost Gobbler, an arcade-type game for the TRS-80 Color Computer. Cassette,

\$21.95. Spectral Associates, 141 Harvard Ave., Tacoma, WA 98466.

Gradebook 2.0, a disk-based gradebook program for the TRS-80 Models I and III. Cassette, \$34.95. MM Computer Club, 333 75th St., Downers Grove, IL 60516. ■

This is a list of software packages that have been received by BYTE Publications during the past month. The list is correct to the best of our knowledge, but it is not meant to be a full description of the product or the forms in which the product is available. In particular, some packages may be sold for several machines or in both cassette and floppy-disk format; the product listed here is the version received by BYTE Publications.

This is an all-inclusive list that makes no comment on the quality or usefulness of the software listed. We regret that we cannot review every software package we receive. Instead, this list is meant to be a monthly acknowledgment of these packages and the companies that sent them. All software received is considered to be on loan to BYTE and is returned to the manufacturer after a set period of time. Companies sending software packages should be sure to include the list price of the packages and (where appropriate) the alternate forms in which they are available.

PERISOFT'S PRICES PLUNGE ON PRODUCTS FOR YOUR APPLE™**!!

\$109.95 A+T

PRINTER+REAL TIME CLOCK
ECONOMICALLY PRICED FOR THE USER NEEDING BOTH PARALLEL PRINTER INTERFACE AND REAL TIME CLOCK CAPABILITIES. THIS BOARD HAS ALL THE FEATURES MENTIONED BELOW FOR OUR PRINTER/PARALLEL AND REAL TIME CLOCK BOARDS. COMES WITH ADDITIONAL SOFTWARE.

\$89.95 A+T

ASYNC. SERIAL BOARD
THIS RS232C COMPATIBLE INTERFACE BOARD HAS A 6B50 UART, HANDSHAKING LINES AND CRYSTAL CONTROL. IT CAN HANDLE FULL OR HALF DUPLEX, ODD, EVEN OR NO PARITY, 1 OR 2 STOP BITS, 7 OR 8 BIT WORDS AND 50 TO 19.2K BAUD.

\$99.95 A+T

REAL TIME CLOCK BOARD
PROVIDES REAL TIME AND DATE INFORMATION. ON BOARD MONITOR FACILITIES TIME, DAY, MONTH, YEAR SETTING. COMES WITH NICAD RECHARGEABLE BATTERY. CRYSTAL CONTROLLED. JUMPER ENABLED INTERRUPT RATES OF 1/1024 SEC, 1 SEC, 1 MINUTE OR 1 HOUR.

\$89.95 A+T

PRINTER/PARALLEL BOARD
CONFIGURABLE AS A PRINTER INTERFACE WITH HANDSHAKING SIGNALS OR AS A TWO WAY PORT. CABLES FOR VARIOUS PRINTERS AVAILABLE. COMES STANDARD WITH FOUR DIFFERENT PRINTER DRIVERS. SPACE IN EPROM FOR USER'S DRIVERS.

ASYNC.-REAL TIME CLOCK
COMING SOON

ALL OF THESE BOARDS MADE BY PERISOFT INC.:

- COME ASSEMBLED AND TESTED
- PASS A 72 HOUR BURN IN PERIOD
- HAVE AUTO SAVE POWER CIRCUITRY
- HAVE SOLDER MASK + SILK SCREEN
- HAVE GOLD PLATED FINGERS
- INCLUDE FULL DOCUMENTATION

-ARE COMPATIBLE WITH APPLE II™* AND APPLE II PLUS™*

PERISOFT INC.
5126 Calle De Sol, Santa Clara, CA 95054
(408) 727-9989 TELEX 178191

DEALER INQUIRIES INVITED

*APPLE II AND APPLE II PLUS ARE TRADEMARKS OF APPLE COMPUTER INC.

Conducted by Steve Clarcla

Computer-Controlled Irrigation

Dear Steve,

I'm about to dive into building a Z8-BASIC Microcomputer, mainly as an irrigation control for my almond ranch. (See "Build a Z8-Based Control Computer with BASIC," Part 1, July 1981 BYTE, page 38 and Part 2, August 1981 BYTE, page 50.) Before I proceed, however, I would appreciate knowing if the Z8 would operate off the 25-pin parallel 4-bit interface bus on a Heath ID-4001 Digital Weather Computer. The program would use inputs to control an assortment of mechanically stepped irrigation valves.

I have talked with Heath about its rain gauge, but I find it expensive because it duplicates the Weather Computer in many respects. A moisture-gauge input to the Z8 would be preferable, and the 25-pin bus has four extra pins plus ground, so I am thinking about combining the inputs into a single port.

A.A. Boon-Hartsinck
Burbank, CA

The concept of using the Z8-BASIC Microcomputer as an irrigation control is an excellent application. The Z8 has enough ports to connect with moisture gauges and data from the Heath ID-4001 Weather Computer (or any other computer, for that matter). Information on an A/D (analog-to-digital) converter appeared in my August 1981 BYTE article.

The February 1982 BYTE contained an article on interfacing the Z8-BASIC Microcomputer to wind-speed, wind-direction, and baromet-

ric-pressure instruments (à la Heath), as well as to a voice synthesizer. (See "Build a Computerized Weather Station," page 38.) . . . Steve

ZX81 for Home Control

Dear Steve,

In one of your Circuit Cellar articles, you discussed methods of controlling the BSR X-10 command console with a dedicated microprocessor. (See "Computerize a Home," January 1980 BYTE, page 28.) In another, you dealt with a home-security system using a computer for control. (See "Build a Computer-Controlled Security System for Your Home," Part 1, January 1979 BYTE, page 56; Part 2, February 1979 BYTE, page 162; Part 3, March 1979 BYTE, page 150.) Can the Sinclair ZX81 be used for either of these purposes, and, if so, how much modification would be required? What would be the total memory requirements, additional I/O ports, and so on to set up such a system? Also, would this system work with a single- or dual-cassette configuration?

J.W. Rankin Jr.
Memphis, TN

The Sinclair ZX81 has full expansion capabilities because the system buses are brought out to its rear connector and are available for many interfacing applications, including a BSR X-10 controller. It is advisable to buffer the output lines if more than one integrated circuit is to be driven. The unit can be mapped wherever there is free memory. The ZX81 can be used to control a single- or dual-cassette drive.

If you want additional I/O capabilities, an expansion unit can be built that would provide buffered address and data lines, serial and parallel printer ports, and any other ports as desired. The COMM-80 (see "I/O Expansion for the TRS-80," June 1980 BYTE, page 42) will satisfy most of these needs and can be adapted to the ZX81 without great difficulty.

. . . Steve

Current Overloads

Dear Steve,

I have an early model Radio Shack TRS-80 Color Computer with a 32K-byte memory upgrade from Spectral Associates. After about four hours of continuous use, the computer overheats and ceases to function. I have installed a fan, which seems to help a lot, but I feel there's something else I should do. The on/off switch turns off the power from the supply transformer to the computer, but does not disconnect the transformer from the AC line. Should it be unplugged when not in use?

Roland C. Wong
West Covina, CA

I spoke with Radio Shack about your overheating problem. Its technicians concluded that the problem is due to the added memory. Let me explain: while the average current requirements of 4116-type memory are low, the pulse currents are high. You may be causing the power supply to enter a current-limit condition. You can verify this hypothesis by carefully removing the add-on

memory and noting if the problem vanishes.

It appears that there is just a little too much current being drawn (and heat generated) by the extra memory. The fact that the fan eliminates the problem and that the problem takes four hours to occur substantiates this. The simplest, and cheapest, solution is to live with the fan (just keep your tapes away from the motor).

It is true that the transformer is left "live" when the unit is shut off. While this will not hurt anything, the transformer will draw a small amount of current; in the interest of energy conservation, unplug it. . . . Steve

Redefining Atari Characters

Dear Steve,

I want to redefine the characters on my Atari 800. Do you have any hints on how to do this, or do you know where I can find the software? The number of characters I need is between 48 and 100.

Russ Burroughs
Edmond, OK

Compute! magazine (POB 5406, Greensboro, NC 27403, (919) 275-9809) recently carried two articles that should answer your questions about redefining characters on the Atari 800. The first, "Character Generation on the Atari," by Charles Brannon, appeared in the February 1981 issue (page 76) and the second, "Designing Your Own Atari Character Sets," by Craig Patchett, appeared in the March 1981 issue (page 72). . . . Steve

Making the Board Connection

Dear Steve,

I recently purchased a full ASCII (American Standard Code for Information Interchange) keyboard with cursor-control keys, numeric lock, and alpha lock. It has a 15-pin edge connector and an empty 40-pin DIP (dual-inline pin) socket. It came without documentation of any kind, but is marked as follows:

MAXI SWITCH
3103-002-03

How can I fill the socket and connect this to my computer?
Maynard J. Hartman Jr.
Point Mugu, CA

Your keyboard probably uses one of two types of popular encoders: the KR-2376 or the KR-3600 (part numbers as used by Standard Microsystems Corporation, Hauppauge, New York). They are very similar, and the only way you will be able to tell which is used will be to compare their pin assignments in the manufacturer's specifica-

tion sheets to the layout of the board.

Even if one of these matches properly, that still may not be enough. These encoders can often be "semicustom"-programmed and, although the part number is correct, the pattern in the internal ROM (read-only memory) may not suit your keyboard.

Determining the connector pinout and signals must be done by sheer tedium. Follow the V_{cc} , V_{ss} , and signal lines from the encoder to the connector. Once you have this data, you will also have the connector pinouts. You may also want to refer to "Deciphering Mystery Keyboards" by Carl Helmers in the September 1975 BYTE, page 62. . . . Steve

Battery-Operated Apple

Dear Steve,

I have an Apple II with a disk drive, 48K bytes of memory, and an NEC 12-inch green-phosphor monitor. I'm using it to help design agricultural systems, home design, scheduling projects, accounting, etc.

While planning a venture that includes solar-generated electricity, battery storage, and a 12-V (volt) electrical system, I suddenly realized that the computer was helping me design itself right out of business. The more I thought about running the computer on 12 V, the more sense it made. In Puerto Rico, we have a lot of power outages and voltage surges, so running a computer from batteries would solve these problems.

Surely there must be a relatively simple way to power my Apple and disk drive from a 12-V source. A monitor appears to be no problem: there's a lot of battery-operated TVs on the market.

Have you got any nifty circuits up your sleeve that will solve my problem?

Chris Stearn
Mayaguez, Puerto Rico

The simplest way to power your Apple II from a 12-V source is to use an inverter. Radio Shack, for example, sells a 300-watt power inverter (catalog number 22-130; the suggested price is \$99.95) that will power your entire system, but any inverter rated at 100 watts or more will suffice.

The Apple II uses +5-V and +12-V supplies that can be obtained directly from a battery through a regulator (remember, a lead/acid 12-V battery is actually 13.6 V). The Apple II also requires -5 V and -12 V, which can be generated using a DC-to-DC converter from either the +5-V or +12-V supplies. In the October 1978 BYTE, I wrote an article that explained how to build such a converter. (See "No Power for Your Interfaces? Build a 5-Watt DC-to-DC Converter," page 22.) . . . Steve

In "Ask BYTE," Steve Clarcia answers questions on any area of microcomputing. The most representative questions received each month will be answered and published. Do you have a nagging problem? Send your inquiry to:

Ask BYTE
c/o Steve Clarcia
POB 582
Glastonbury CT 06033

If you are a subscriber to The Source, send your questions by electronic mail or chat with Steve (TCE317) directly. Due to the high volume of inquiries, personal replies cannot be given. Be sure to include "Ask BYTE" in the address.

DISASTER INSURANCE

PROTECT YOUR HARDWARE FROM THE UNEXPECTED.

Not to mention the unavoidable pollutants in the air. Performance robbing dust, grime, spills and static electricity.

Cover Craft Dust Covers help extend the useful life of your computer equipment at a fraction of the cost. Perhaps that's why more people throughout the world rely on Cover Craft Dust Covers than any other brand.

Visit your local dealer or contact Cover Craft.

Dust Covers for most  disks, printers, modems, etc.

\$8.95-\$15.95
Shipping extra.



COVER CRAFT CORP

PO Box 555, Amherst, NH 03031 • (603) 889-6811



Event Queue

July 1982

July

Courses from Integrated Computer Systems, various sites throughout the U.S. Among the courses being offered are "Microprocessor Software, Hardware, and Interfacing," "Hands-on Microprocessor Troubleshooting," "Speech Synthesis and Recognition," and "Digital Image Processing and Analysis." Complete course listings including dates, locations, course outlines, and fees are available from Integrated Computer Systems, 3304 Pico Blvd., POB 5339, Santa Monica, CA 90405, (800) 421-8166; in California, (800) 352-8251.

July

Technical Classes from Zilog, Campbell, CA. Zilog is offering a series of one- to five-day technical classes at its California-based training facility. Topics range from "Microprocessors: A General Introduction" to "C Programming." Contact Zilog, Training and Education Dept., 1315 Dell Ave., Campbell, CA 95008, (408) 446-4666.

July

New York University SEHNAP Summer Sessions, New York University, New York, NY. Among the courses being offered by the School of Education, Health, Nursing, and Arts Professions (SEHNAP) are "Introduction to Computer Technology" and "New Technology for Interactive and Individualized Instruction." These graduate-level courses are designed for teachers, administrators, and other professionals. For more information, contact NYU-SEHNAP Summer Sessions, 60 Press Building, New York University, New York, NY 10003, (212) 598-2772.

July-August

Database Concepts and Design, various sites throughout the U.S. Sponsored by the American Management Associations (AMA), this five-day seminar is designed for data-processing managers, system designers, and other personnel involved in database activities. Topics include an overview of the database environment; evaluating and measuring performance, costs, and results; determining organizational needs and the systems and software to meet them; and implementing, integrating, and supporting the database within company plans and budget. Highlighting this seminar is a comprehensive review of database products. Individual fees are \$850 for AMA members and \$975 for nonmembers. Team discounts are available. Contact AMA, 135 West 50th St., New York, NY 10020, (212) 586-8100. To register by phone, call (212) 246-0800.

July-August

Engineering Summer Conferences, Chrysler Center for Continuing Engineering Education, North Campus, University of Michigan, Ann Arbor, MI. Among the conferences being offered are "Robotics: Concepts, Theory, and Applications," "High-Speed Computation: Vector Processing," and "Computer Image Analysis." For complete details, contact Engineering Summer Conferences, 200 Chrysler Center, North Campus, University of Michigan, Ann Arbor, MI 48109, (313) 764-8490.

July-August

Summer Seminars from Datapro Research, various sites throughout the U.S. and Canada. Among the seminars being offered are "Using Computer-Aided Design/Computer-Aided Manufacturing

Systems: Planning, Equipment Selection, and Applications," "Microcomputer Systems: A Guide to Selection and Application," and "Data Administration: Successful Techniques." Enrollment fees are \$640 for Datapro subscribers and \$690 for nonsubscribers. For more information, contact Datapro Research Corp., 1805 Underwood Blvd., Delran, NJ 08075, (800) 257-9406; in New Jersey, (609) 764-0100.

July-December

IEEE Computer Society Conferences and Meetings, various sites throughout the U.S., Europe, and Asia. Events scheduled include "Symposium on Reliability in Distributed Software and Database Systems," "Computer Vision: Representation and Control," and "The Annual Workshop on Computing to Aid the Handicapped." For a complete listing of conferences and meetings, contact the Executive Secretary, IEEE Computer Society, POB 639, Silver Spring, MD 20901, (301) 589-3386.

July 11-15

The International Manufacturing Systems Conference '82, Convention Center, Buffalo, NY. The conference theme is "The Technology of Productivity." More than 100 experts will conduct seminars on a wide variety of topics. Exhibits, vendor presentations, and plant tours are planned. Contact Roy Combs, International Manufacturing Systems Conference, 186 North Water St., Rochester, NY 14604, (716) 232-3950.

July 11-25

The Twelfth Annual Summer Institute for Media Arts, Endicott College, Beverly, MA. A wide variety of seminars and workshops will be

offered, including computer animation, video production, and computer graphics. For more information, contact the Summer Institute for Media Arts, POB 83, Lincoln Center, MA 01773, (617) 259-0068.

July 12-16

The Electronic Arts of Sound and Light, University of California, Santa Barbara, CA. This hands-on seminar will emphasize the principle concepts of electronic arts and their relationships in theory, performance, practice, and the creative process. Topics of interest include the nature of waves, psychoacoustics, psycho-optics, the synthesizer, the computer, and oscillographics. The agenda includes lectures, demonstrations, and an intermedia concert. The seminar fee is \$425. For complete details, contact Gina Garcia, University of California Extension, Santa Barbara, CA 93106, (805) 961-3231.

July 13-14

Controlling Electromagnetic Interference, Hyatt Hotel at LA Airport, Los Angeles, CA. This seminar is sponsored by *Electronics* magazine, a McGraw-Hill publication, and is designed for electronic industry professionals who must make technical or cost decisions based on an understanding of electromagnetic interference. Topics of discussion include intersystem problems, designing against environmental noise, how to determine the best frequency for a given application, and the structure and use of intrasystem electromagnetic compatibility models. The fee is \$595; in-plant programs can be arranged. Contact Ms. Barbara Bancroft, McGraw-Hill Seminar Center, Room 3112, 305 Madison Ave., New York, NY 10017, (212) 687-0243.

July 14-17

Data Dictionaries, Marina City Club, Los Angeles, CA. The fee for this course is \$750. For details, contact the Continuing Education Institute, Suite 1000, 10889 Wilshire Blvd., Los Angeles, CA 90024, (213) 824-9545.

July 18-22

The Fourth General Assembly of the World Future Society, Sheraton Washington Hotel, Washington, DC. The conference theme is "Communications and the Future." All areas of the communications field from telecommunications to interpersonal communication will be covered. The impact of new technologies on society will be explored. Contact the World Future Society, 4916 St. Elmo Ave., Bethesda, MD 20814, (301) 656-8274.

July 19-21

Summer Computer Simulation Conference (SCSC), Marriott City Center Hotel, Denver, CO. The SCSC covers all aspects of computer simulation methodology and applications. Technical sessions and presentations on mathematical methods, model design, simulation languages, and validation techniques will be featured. Information is available from Harvey Marks or Philicia Marks, Transaction Technology Inc., 7648 Capistrano Ave., Canoga Park, CA 91304, (213) 346-5376.

July 21-23

The Computer: Extension of the Human Mind, Eugene Hilton Hotel, Eugene, OR. This conference is sponsored by the University of Oregon College of Education. Workshops, speakers, and presentations on the use of computers in education will be held. Topics of interest include preparing teachers to teach with computers, the ethical and social issues associated with computers, and how com-

puters assist learning. The conference fee is \$95; students enrolled in the university's summer session can register for \$55 and earn a single credit hour. For additional information, contact Judy Ohmer, College of Education, University of Oregon, Eugene, OR 97403, (503) 686-3405.

July 25-30

The Fifth Annual Harvard Computer Graphics Week, Hyatt Regency Hotel, Cambridge, MA. Conference presentations will focus on computer mapping, image processing, graphic communications, and information resources. For further details, contact the Conference Manager, Special Programs, Harvard University, Graduate School of Design, 48 Quincy St., Cambridge, MA 02138, (617) 495-2578.

July 26-30

SIGGRAPH '82: The Ninth Annual Conference on Computer Graphics and Interactive Techniques, Boston, MA. This conference is sponsored by the ACM SIGGRAPH (Association for Computing Machinery Special Interest Group on Computer Graphics). More than 140 exhibitors will display the latest in computer-graphics hardware, software, and services. A series of courses and technical sessions on a variety of topics will be offered, including device-independent graphics software, low-cost graphics, business graphics, solid modeling, and computer-aided design. Other features include a multimedia computer-graphics art show and computer-generated films. For information, contact SIGGRAPH '82, Convention Services Department, 111 East Wacker Dr., Chicago, IL 60601, (312) 644-6610.

July 27-30

Database Systems: Comparison, Design, Applications, and Trends, Marina Del Rey

Hotel, Marina Del Rey, CA. For more information on this course, contact the Continuing Education Institute, Suite 1000, 10889 Wilshire Blvd., Los Angeles, CA 90024, (213) 824-9545.

August 1982

August-December

Courses from Don White Consultants, various sites throughout the U.S. and Canada. Among the courses being offered are "Interference Control: An Introduction to Electromagnetic Interference/Radio Frequency Interference/Electromagnetic Compatibility," "Electromagnetic Compatibility-Design and Measurement for Control of Electromagnetic Interference," and "Tempest-Design, Control, and Testing." Course fees range from \$675 to \$945. For complete details, contact Don White Consultants Inc., State Route 625, Gainesville, VA 22065, (703) 347-0030.

August-December

Courses from Fairchild Camera and Instrument Corporation, Santa Clara, CA. Among the courses being offered are "F9445 Family Introduction," "Pascal for Microprocessors," and "F680X Microprocessor Family." For more information, contact Fairchild Camera and Instrument Corp., Education Center, 3420 Central Expressway, Santa Clara, CA 95051, (408) 773-2161.

August 1-4

Microcomputer Applications in Education Workshop, Cloud's Cal-Neva, Lake Tahoe, NV. This workshop is designed for school teachers and administrators. It is sponsored by the University of Nevada-Reno Division of Continuing Education and the Washoe County School District. For further information,

contact Shirley Beck, Division of Continuing Education, University of Nevada, Reno, NV 89557, (702) 784-4801.

August 2-4

ACM SIGSMALL Conference on Small Systems, Colorado College, Colorado Springs, CO. This conference will feature papers and panel discussions on communications and I/O, new architecture, operating systems, distributed systems, Ada machines, microprocessor performance, security, and research. Additional details are available from Ron Oliver, 307 North 15th St., Colorado Springs, CO 80904, (303) 576-0786.

August 8-14

Institute for Coordinator of Academic Computing, Potsdam, NY. Among the topics to be covered are user education, hardware planning, software location, conversion and adaptation, and exposure to instructional software and utility. For details, contact Dr. Fritz H. Grupe, Associated Colleges of the St. Lawrence Valley, Potsdam, NY 13676.

August 15-19

The Second International Computer Engineering Conference and Exhibition, Sheraton Harbor Island Hotel, San Diego, CA. This conference is sponsored by the Computer Engineering Division of the ASME (American Society of Mechanical Engineers). More than 50 exhibitors will display computer-engineering products, information, and services. The conference will feature technical sessions on more than 60 topics, including interactive graphics, personal computing by means of programmable calculators, computer-aided design and manufacturing, and robots. For complete details, contact the ASME, 345 East 47th St., New York, NY 10017, (212) 644-7100.

Ride the



5 1/4" \$199*
 SINGLE SIDE
 SINGLE DENSITY
 W/HUB RING
 SOFT,
 10 OR 16
 SECTORS
 100% CERTIFIED
 2 YEAR WARRANTY

8" \$199*
 SINGLE SIDE
 SINGLE DENSITY
 SOFT
 OR 32
 SECTORS
 100% CERTIFIED
 2 YEAR WARRANTY

5 1/4" \$219*
 SINGLE SIDE
 DOUBLE DENSITY
 W/HUB RING
 SOFT,
 10 OR 16
 SECTORS
 100% CERTIFIED
 2 YEAR WARRANTY

8" \$249*
 SINGLE SIDE
 DOUBLE DENSITY
 SOFT
 OR 32
 SECTORS
 100% CERTIFIED
 2 YEAR WARRANTY

5 1/4" \$299*
 DOUBLE SIDE
 DOUBLE DENSITY
 W/HUB RING
 SOFT,
 10 OR 16
 SECTORS
 100% CERTIFIED
 2 YEAR WARRANTY

8" \$309*
 DOUBLE SIDE
 DOUBLE DENSITY
 SOFT
 OR 32
 SECTORS
 100% CERTIFIED
 2 YEAR WARRANTY

- * Minimum order 100 • For smaller quantities add 10%
- Packed 10 boxes of 10 diskettes with sleeves and labels
- Quantity discounts - 1,000 deduct 3%, 5,000 deduct 5%, 10,000 deduct 7%
- Add \$3.00 per case 5 1/4", \$7.00 per case 8"
- For shipping and handling Continental U.S.A., U.P.S. ground.

Box of 10 diskettes, 5 1/4" 8"
 OPUS ss/sd \$20 ss/sd \$21
 BASF ss/dm \$23 ss/sd \$24
 MAXWELL } TOO LOW TO QUOTE CALL
 DYSAN }
 SPECIFY SECTORING WHEN ORDERING
 8" QUAD DENSITY IN STOCK

**DISK DRIVE HEAD
 CLEANING KITS**
 Prevent head
 crashes and
 ensure error-free
 operation
 5 1/4" or 8"
 \$19.50



HARDHOLE DISK PROTECTORS
 Reinforcing rings
 of tough mylar
 protect disk hole
 edge from damage
 Applicators
 Hardhole Rings (50)

5 1/4" 8"
 \$3 \$4
 \$6 \$8

SFD C-10 CASSETTES . . 10/\$7
 (All cassettes include box and labels.)
 Get 8 cassettes, C-10
 Sonic, and Cassette/8
 Library-Album,
 as illustrated,
 for only . . \$8



LIBRARY CASES
 8" Kas-sette/10 \$2.99
 5 1/4" Mini Kas-sette/10 \$2.49



5 1/4" or 8"
 Vinyl
 Storage
 Pages
 10/\$5

• Written purchase orders accepted from government agencies and well rated firms at a 10% surcharge (wabash media only) for net 30 billing. • International orders accepted with a 15.00 surcharge for handling, plus shipping charges. • C.O.D. requires a 10% deposit. • We accept Visa, Mastercard, Money Orders, and Certificate checks. • Checks require bank clearances. • All shipments F.O.B. San Diego. • Minimum shipping and handling 2.00, minimum order 10.00. • California residents all 6% sales tax. • Prices and terms subject to change without notice. • All sales subject to availability, acceptance, and verification. • All sales are final. • Satisfaction guaranteed or full refund.

We also offer printer ribbons, printwheels, type elements, equipment covers, power consoles, paper supplies, storage and filing equipment, furniture and many other accessories for word and data processing systems. Write for our free catalog.

Toll Free Order Only
800-854-1555

**ABM
 PRODUCTS**

For Information
 or California Orders
(714) 268-3537

8868 CLAIREMONT MESA BLVD.
 SAN DIEGO, CALIFORNIA 92123

Event Queue

August 16-20
The National Conference on Artificial Intelligence, Carnegie-Mellon University and the University of Pittsburgh, Pittsburgh, PA. Among the topics to be addressed are expert systems, robotics, computational vision, programmable automation, game playing, and knowledge representation. Other features include an exhibition program and a two-day tutorial program providing a nontechnical look at key areas of artificial-intelligence research. Complete conference details are available from the American Association for Artificial Intelligence, 445 Burgess Dr., Menlo Park, CA 94025, (415) 328-3123.

August 23-24
Personal Computer Market Opportunities and Pitfalls, The Anatole, Dallas, TX. The fee for this seminar is \$495. For more information, contact Future Computing Inc., 900 Canyon Creek Square, Richardson, TX 75080, (214) 783-9375.

September 1982

September 1-3
European Conference on Integrated Interactive Computing Systems (ECICS '82), Stresa, Italy. Among the topics to be covered are software architecture, user interfaces, system software and hardware, knowledge support, activities management, office information systems, and computer-aided design systems. For details, contact Maria Simi or Pierpaolo Degano, Istituto di Scienze dell'Informazione, Corso Italia 40, I-56100 Pisa, Italy, (50) 40862; Telex, 500371 CNUCE.

September 2-3
Indiana Computer Expo (ICE), Indianapolis Convention Center, Indianapolis, IN.

This exposition will feature exhibits of computer software and computer-related materials and services. Show details are available from Ernie Kerns & Associates, Suite 201, 2555 East 55th Place, Indianapolis, IN 46220, (317) 259-8111.

September 5-9
Euromicro 1982, Haifa, Israel. This conference is made up of scientific sessions, tutorials, panel discussions, industrial programs, and exhibits. Among the topics to be addressed are system architecture, hardware and software tools, network structure, and education. Highlighting this event is the international Euromouse competition for maze-solving mobile robots. For details, contact Euro-micro, 4, Place Félix Eboué, 75012 Paris, France, (1) 341-08-46; Telex 211801.

September 9-11
The First Annual Meeting of the Micromputer Users Group of Georgia (MUG/USG), Georgia Southern, Statesboro, GA. This meeting will feature demonstrations, talks, tutorials, and panel discussions on various applications of microcomputers in the classroom, laboratory, and office. Other features include vendor demonstrations and displays. For further details, contact Fred Henneike, Georgia State University, Atlanta, GA 30303, (404) 658-3120, or Richard Stracke, Augusta College, Augusta, GA 30910, (404) 868-3706.

September 9-12
The Fifth Personal Computer World Show, Barbican Centre, London, England. This is the largest computer show held in the United Kingdom. For complete details, contact Personal Computer World, 14 Rathbone Place, London W1P 1DE, England, 01-631 1433.

September 12-15

Design Engineering Technical Conference, Keybridge Marriott, Washington, DC. For information on this conference, contact the American Society of Mechanical Engineers, United Engineering Center, 345 East 47th St., New York, NY 10017, (212) 644-7740.

September 14-16

Mini/Micro Computer Conference and Exposition, Disneyland Hotel, Anaheim, CA. For complete details, contact Electronic Conventions Inc., Suite 410, 999 North Sepulveda Blvd., El Segundo, CA 90245, (213) 772-2965.

September 14-16

Wescon/82 High-Technology Electronics Exhibition and Convention, Anaheim Convention Center, Anaheim, CA. Among the topics to be covered are analog and digital signal processing, office automation, and semiconductor technology. For more details, contact Electronic Conventions Inc., Suite 410, 999 North Sepulveda Blvd., El Segundo, CA 90245, (213) 772-2965.

September 20-24

COMPCON Fall '82, Capital Hilton Hotel, Washington, DC. This conference will focus on the principles behind work-station technology, including local area networks, operating systems, and new concepts in user interfaces. Topics of interest include reliability and availability techniques, network-wide databases, distributed architectures, network user environments, and standards. For information, contact COMPCON Fall '82, POB 639, Silver Spring, MD 20901, (301) 589-3386.

September 21-22

Word Processing/Information Systems Expo, Sheraton Washington Hotel, Washington, DC. This conference and exposition will address the trends and advances in the word-processing industry. Among the topics to be covered are word processing and office integration, productivity measurement, and levels of managing an organization. Further details are available from National Trade Productions Inc., Suite 206, 9418 Annapolis Rd., Lanham, MD 20706, (301) 459-8383.

September 21-23

Software/expo-National, Expocenter, Chicago, IL. This show is sponsored by *Info-systems* magazine. For complete details, contact Software/expo, Suite 400, 222 West Adams St., Chicago, IL 60606, (312) 263-3131.

September 23-25

The First International Conference and Exhibition on Medical Computer Science (Medcomp '82), Hilton Hotel and the University of Pennsylvania, Philadelphia, PA. This conference is sponsored by the IEEE (Institute of Electrical and Electronics Engineers) Computer Society's Technical Committee on Computational Medicine. It is a transdisciplinary forum for engineers, medical professionals, and biomedical and computer scientists. Papers and exhibits will focus on topics such as

the history and evolution of computers in medicine, artificial intelligence, software and systems evaluation, and signal and image processing. For additional information, contact the IEEE Computer Society, POB 639, Silver Spring, MD 20901, (301) 589-3386.

September 28-October 1

Computer Trade Forum, National Exhibition Centre, Birmingham, England. This trade show will bring together vendors, original equipment manufacturers, dealers, distributors, retailers, service companies, and independent sales organizations. For complete details, contact Clapp & Poliak Inc., 245 Park Ave., New York, NY 10167, (212) 661-8410. In England, contact Clapp & Poliak Europe Ltd., 232 Acton Lane, London W4 5DL, 01-747-3131. ■

In order to gain optimal coverage of your organization's computer conferences, seminars, workshops, courses, etc, notice should reach our office at least three months in advance of the date of the event. Entries should be sent to: Event Queue, BYTE Publications, POB 372, Hancock NH 03449. Each month we publish the current contents of the queue for the month of the cover date and the two following calendar months. Thus a given event may appear as many as three times in this section if it is sent to us far enough in advance.

ScratchPad

The Ultimate Spreadsheet. Never See "Out of Memory" Again.

SuperSoft P. O. BOX 1628
CHAMPAIGN, IL 61820
© (217) 359-2112 TELEX 270365

First In Software Technology.

News and Speculation about Personal Computing

Conducted by Sol Libes

Random Rumors: By the third quarter of this year IBM is expected to be shipping 1000 personal computers per day. . . . Micropro International Corporation, San Rafael, California, supplier of Wordstar and several other "stars," is expected to offer its stock to the public, possibly as soon as this fall. . . . NEC (Nippon Electric Company) Informations Systems, Lexington, Massachusetts, is expected to follow IBM's and Tandy's lead soon by introducing a 16-bit personal computer oriented to the office market. . . . Mitsubishi, Osaka, Japan, is rumored to be working on a flat-screen liquid-crystal display using silicon deposited on quartz with a large array of transistor switches. The firm is believed to have already fabricated experimental panels with about 20,000 pixels. . . . Xerox is reportedly readying a low-cost personal computer at its Office Systems division, possibly for introduction this year. . . . AT&T is believed to be seriously working on prototypes of a personal computer and a small business work station using optical fiber technology.

This fall the Compupro Division of Godbout Electronics, Oakland, California, is expected to release a 68000 S-100 processor card, and early next year the company hopes to produce an S-100 card utilizing the National 16032 microprocessor. When the 16032 card becomes available it will be the most powerful microprocessor used in a personal computer. Compupro hopes to furnish CP/M-68K as the operating

system for its 68000 processor card. . . . Both Digital Research and Microsoft are said to be working on upgrading their high-level language interpreters to work with the new Intel 8087 math processor. They need not rush, since Intel is only just starting to ship samples, and production is still several months away. When this software/hardware combination is available, performance of 8-bit computers in math applications will surely be improved. . . . Grid Systems Inc., Mountain View, California, is expected to introduce shortly a portable system using the 8086 16-bit microprocessor, a flat-panel display, 256K bytes of memory, bubble-memory mass storage, and a built-in modem. . . . Said Iftikar, co-founder of Seagate Technology, the company that started the craze over 5¼-inch Winchester disk drives, has left that firm to start Syquest Inc., Fremont, California, which will make 3¼- to 4-inch Winchesters. . . . A 2-giga-byte (i.e., 2-billion-byte) optical-disk system with super-fast access time from Burroughs Corporation, Detroit, is expected to debut at the National Computer Conference. (For more information on this new technology read the Optical Memory Newsletter, POB 14817, San Francisco, CA 94114.)

Radio Shack Dolings

By the time you read this Tandy should have its new TRS-80 Model 16 systems in the company's showrooms and may even have started

shipping to customers. A multitasking/multiuser version of Tandy's TRSDOS operating system is due this summer. The first language introduced will be COBOL, which will be followed by BASIC and FORTRAN. The first applications package will be Visicalc and an integrated small-business accounting system with a shared database facility.

Tandy Corporation has decided to restrict sales of the Model 16 to its 250 dedicated Computer Centers and about 450 full-line Radio Shack stores that have computer departments with trained staffs. That leaves almost 7000 Radio Shack stores out in the cold. Tandy expects to add ten computer stores a month over the coming year. The firm is obviously doing this to cater more to the traditional data-processing professionals who expect, and are willing to pay for, a high level of hardware and software support.

With the Model 16, which can cost as little as \$6000 for a basic system, Tandy will be aggressively going after the markets that until now were dominated by IBM, DEC, et al. After all, if IBM could enter the personal computer market, long Tandy's province, then why shouldn't Tandy turn the tables and invade the business market, long IBM's exclusive stomping ground. That's what competition is all about.

It's interesting how things change: IBM, who used to sell products that were exclusively IBM-made through a marketing organization that was exclusively IBM-run, has done a complete about-face. It now purchases hardware and soft-

ware from outside suppliers and sells by way of non-IBM retail outlets. On the other hand, Tandy sells exclusively through its own sales organization and directly controls about 50 percent of its manufacturing costs.

Veritas Technology, San Jose, California, is offering an add-on board for the TRS-80 Model II that uses the 8086 microprocessor. With it you can now run CP/M-86 and Microsoft's MS-DOS.

Apple Happenings:

When IBM introduced its Personal Computer, and when the economy turned downward, many experts thought that Apple, Tandy, Atari, and Commodore had had it. But now almost a year later it is quite the reverse: business is better than ever. The market for microcomputers is growing at a healthy rate and appears to be able to absorb close to 200,000 IBM Personal Computers this year without affecting the growth of any of the other microcomputer leaders.

Apple Computer Inc. ended its first full fiscal year in September 1978 with a profit of three cents per share. The next year earnings quadrupled to 12 cents per share and the following year doubled to 24 cents. The 1981 fiscal year saw Apple earnings rise to 70 cents per share and expectations for this year are \$1.24 per share. Revenues are expected to reach \$640 million, up from \$335 million last year, and \$117 million the year prior.

Apple is trying to give an Apple II computer to each of

the more than 83,000 public elementary and secondary schools in the country. This would amount to a donation of at least \$200 million, based on the list price of the system. In order to do this Apple wants Congress to change the current law to allow the company a tax break for the donation. The current law says such deductions can be made only for scientific equipment given to higher-level educational institutions for research purposes.

Such a give-away would, of course, pay handsome dividends for Apple. After all, how long would a school be able to live with only one Apple computer? And certainly students would try to convince their parents that they simply must have an Apple II to do their homework because there is only one at school and they can't get time on it.

In last month's column I mentioned that, despite Apple's cancelling of discount mail-orders, dealer advertisements continue to appear offering discounts on Apple II computers. However, note that these outlets are not franchised Apple dealers. These are discount outlets that buy machines from overstocked Apple dealers. In fact, many franchised Apple dealers count on these resales to keep volume high so that they may qualify for higher discounts from Apple. Apple is attempting to stop this "brokering" of computers but as yet has not been successful.

Concurrent CP/M: CP/M is without doubt the most popular disk operating system for 8-bit microcomputers. Digital Research keeps improving CP/M by adding new features while maintaining compatibility between newer and older versions, thereby insuring continued life for

languages and applications software. The firm's latest version is Concurrent CP/M-86, which allows multiple tasks to execute simultaneously. For example, a system can be sending or receiving a file or batch of files in the background while the operator is doing another task in the foreground on the console. Different tasks can access the same data file without destroying data integrity. Passwords and time stamps on files are supported. The first implementation has been done for the IBM Display-writer.

Digital Research is also reportedly at the "beta test" stage on version 3 of CP/M-80.

Smalltalk News: Ed Cherlin, Director of Personal Computer Research at Strategic Inc., a marketing research firm, predicts that "Smalltalk will become the dominant operating system and programming language for 16-bit personal computer systems" and that it "will shut the Unix window of opportunity before it is fully open." He further predicts that "numerous leading-edge personal computer and office automation manufacturers will be flooding the market with Smalltalk systems, which are vastly more powerful and easy to use than Unix systems. Versions of CP/M for 16-bit systems will also be squeezed out." He expects Smalltalk versions from Apple, DEC, Hewlett-Packard, Tektronix, and several Japanese companies during the coming year, and he believes that IBM has a similar product in development.

The Marketplace: TI (Texas Instruments) has again slashed the price on its personal computer in an attempt to compete with the likes of

SAVE



TRS-80's™

FULL LINE
and

Hewlett Packard

85, 87, 125

WE PAY SHIPPING in the 48 continental states on prepaid orders of \$100.00 or more.
NO TAXES are collected on out-of-state shipments.
WE ACCEPT Visa, MasterCard and American Express, or you can save additional money by paying cash.

TOLL FREE ORDER NUMBER 800/531-7466

Pan American Electronics

1117 Conway • Dept. B
Mission, Texas 78572
Phone 512/581-2766
Telex Number 767339

FORT WORTH BRANCH
2912 N. Main
Ft. Worth, Texas 76106
Phone 817/625-6333
Telex Number 794836



85, 87, 125

Hewlett-Packard

TM — Trademark of Tandy Corporation

MICROSTAT® - Release 3.0

MICROSTAT® + baZic® = PERFORMANCE

The best just got better! MICROSTAT has been the leader in the statistics field for microcomputers since 1979, and the new release 3.0 outperforms and is noticeably faster than previous versions. Just a few of the features include:

GREATER ACCURACY

BCD with up to 14 digit precision;

PROGRAM ENHANCEMENTS

Missing data capabilities and many more;

FASTER EXECUTION

Calculation time greatly reduced;

DYNAMIC FILE ALLOCATION

Data can be inserted, added, or deleted;

SPECIAL PRICE:

For a limited time get MICROSTAT plus baZic complete with program disk and documentation for each for \$395.00, save \$50.00!

The MICROSTAT - baZic version requires: a Z80 CPU, CP/M™ and 48K of memory. Available formats: 8" SD disk or 5 1/4" North Star only. Check with your dealer for other formats. Also available for: Microsoft's Basic-80™, North Star DOS and IBM. For more information, call or write:

ECOSOFT INC.

P.O. Box 68602
Indianapolis, IN 46268-0602
(317) 255-6476



MICROSTAT is a registered trademark of ECOSOFT, INC.
baZic is a registered trademark of MICROMIKES, INC.
CP/M is a registered trademark of DIGITAL RESEARCH
Basic-80 is a registered trademark of MICROSOFT

the TRS-80 Color Computer, the Atari 400 (both priced at \$399), and the Commodore VIC (\$299). TI's price to dealers is now under \$300, with a suggested \$350 retail price. (The computer was originally introduced with a \$1000 price tag.) This under-\$500 market is expected to become even more competitive as the Japanese enter the market. And NEC will shortly be introducing the PC-6000, which will probably carry a \$400 price tag.

International Resource Development Inc. (IRD), Norwalk, Connecticut, another marketing research firm, predicts that the share of the microcomputer marketplace will soon undergo marked change. The current market share is Tandy/Radio Shack: 28%; Apple: 25%; Hewlett-Packard: 11%; Commodore:

10%; Xerox, DEC, and IBM combined: 10%; and all others: 16%. IRD claims that this will change substantially so that by 1985 the lineup will be IBM: 23%; Xerox: 17%; Tandy/Radio Shack: 15%; Hewlett-Packard: 14%; Apple: 12%; DEC: 11%; Commodore: 3%; and all others: 5%.

Still another marketing research firm, Creative Strategies International, San Jose, California, forecasts that more than 12 million personal computers will be made over the next five years with an annual growth rate of 59%. They expect prices to drop 20% per year through 1986. They claim further that last year six personal computer firms each did over \$50 million in business. They expect this number to rise to eleven firms this year.

Microsoft Sues: More and more software suppliers are going to court to protect their copyrighted software. Previously I reported that Digital Research and Micropro have filed suit against a dealer who allegedly illegally copied and sold their software. Last month, I reported on Atari's suit against Magnavox, in which Atari sought to protect the screen images used in its Pac-Man computer game.

The latest suit has been brought by Microsoft, which has gone to court charging software piracy. Microsoft charges that Advanced Logic Systems (ALS), Sunnyvale, California, has copied the BIOS and BOOT programs for Microsoft's Z80-based Apple Softcard and is selling them as part of a product called "The Synergizer." Microsoft

charges that the code is a byte-for-byte copy with the exception that ALS changed the copyright notices and altered two message strings. Otherwise, according to Microsoft the two programs are identical, right down to the initials of the Microsoft programmer who created the software.

Print System Merges Text and Graphics: Xerox has announced a new printing system that allows text and graphics to be merged and printed electronically, thus doing away with typesetting, plate-making, collators, and printing presses. Software allows artwork functions such as cropping, scaling, and reduction. Text and graphics can be merged and printed at

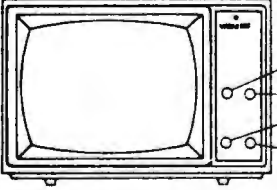

1. CONTRAST
2. POWER-BRIGHT
3. V-HOLD
4. H-HOLD

VIDEO 100
12" Black & White
MONITOR
\$89.50
by AMDEK

Fourth Dimension Systems
FLOPPY DISK DRIVE FOR APPLE COMP.

The unit features a track zero micro-switch and read/write electronics DOS 3.2.1., DOS 3.3, PASCAL or CP/M.
\$349.95

BROAD BAND MICROWAVE RECEIVER SYSTEM
1.8GHZ to 2.4 GHZ
only
\$295.00

RANGE: Line of sight to 250 miles.
SCOPE: Will receive within the frequency band from satellites, primary microwave stations, and repeater microwave booster stations.
CONTENTS: Packaged in 19"x19"x4 1/2" corrugated carton complete with:

- 24" Dish
- 300 Ohm to 75 Ohm Adapter
- Feed-Horn Receiver
- 750 Ohm to 300 Ohm Adapter
- Mounting Bracket
- 60 Feet Coax Cable with Connectors
- Mounting Clamp
- 3 Feet Coax Cable with Connectors
- Instructions

SUPER BUY!
16 K RAM EXPANSION CARD
For Your APPLE
LANGUAGE TRANSPARENT
ALL NINE RAMS INSTALLED!
\$79.95



VISION-80[®] 80x24 Video Display Card
\$269

Vista Computer Company's new Vision-80 board is a sophisticated yet easy to use video display card for the Apple™ computer.

TERMS OF SALE: Cash, checks, credit cards, C.O.D. Calif. residents add 6% sales tax.

"HAVE YOU KISSED YOUR COMPUTER LATELY"

Components Express, Inc.

1380 E. Edinger • Santa Ana, Calif. 92705 • 714/558-3972 TWX 910-595-1565

a rate of up to 120 pages per minute.

Logic Gets Fuzzy: You've heard of "intelligent" and "smart" systems? Well, now comes the "expert" system using "fuzzy" logic. Systems Programming Ltd., London, England, has come up with "Sage," an "expert-derived knowledge database" consisting of rules and a "navigating inference engine" that uses "probabilistic and fuzzy logic." The company claims it is advantageous in applications such as medical diagnosis where it should provide much better structure with stronger linking of evidence, more alternative conclusions and a shorter program through control of complexity.

News from Japan: During the past four years Japan's 10 largest integrated-circuit producers have more than tripled their investments in plants and equipment while U.S. producers have reduced operations and delayed many investment programs. The effects of this have shown up most markedly in the 64K-bit dynamic memory market. The Japanese firms are shipping more and more unfinished products here for final assembly, thereby reducing the dollar imports to the U.S. and sidestepping trade friction while at the same time increasing their market share. NEC, Hitachi, Toshiba, and Fujitsu have already set up such assembly sites.

Also, and with great ceremony, the Japanese have launched an eight-year, \$300 million program to develop a scientific computer capable of doing 10 billion floating-point operations per second. Participating jointly in this effort are Fujitsu, Hitachi, NEC, Mitsubishi, Toshiba, and Oki.

The government will spend \$130 million and the six companies will spend \$120 million. The computer will use Josephson junction, HEMT (high electron mobility transistor) and gallium arsenide devices as well as parallel processing methods.

What's happening with 256K-bit Memory Devices: Hitachi Ltd. and Motorola have released preliminary specifications for 256K-bit memory integrated circuits. They expect to begin providing samples by year-end, and production quantities should begin to become available in late 1983. However, these companies do not expect these devices to become cost-competitive with the currently popular 64K-bit devices until 1985. TI, Mostek, and Intel are also known to be developing 256K-bit memories but as yet have not released any details. Western Electric is expected to go into production before year-end on a 256K-bit device developed by Bell Laboratories. IBM is also expected to be in production of its 288K-bit dynamic memory (9 bits wide with parity) by year-end.

The 256K-bit devices announced so far are organized as 256K by 1 bits. It is expected that later devices will be organized as 64K by 4 bits and 32K by 8 bits.

Random News Bits: Altos has cut prices on its three-user Series-5 MP/M system by one third: to \$2900 with dual floppy-disk drives and to \$5900 with a Winchester/floppy-disk drive combination. This, as far as I can tell, makes it the lowest-cost multiuser system around. . . . Matsushita, Osaka, Japan, is preparing to go into production on an 8-bit

**NEW! M-68000
SINGLE BOARD COMPUTER**

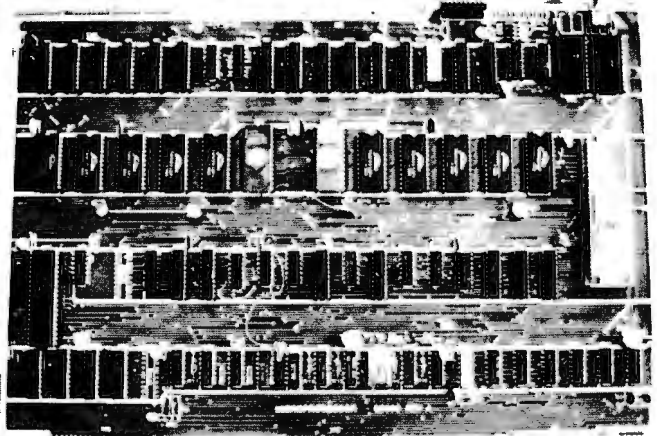

FEATURES:

16 bit Motorola 68000 CPU operating @ 10MHz, 20K bytes of on board fast static RAM, 16K bytes of on board EPROM space, 7 levels of prioritized autovectorized interrupts, 2 memory expansion buses (up to 256K), 2 serial communication ports (RS-232C), 16-bit bidirectional parallel port, 6800 peripheral accommodation bus, 5x16-bit counter/ timers with vectored interrupts, on board real time clock, software compatible with Motorola MEX68KDM board.

PRICE:

Bare board with documentation	\$99.95
MEX68KDM compatible monitor in 2764 EPROM's	\$120.00
M68000 CPU & memory map PROM	\$115.00
Shipping and handling	(Domestic) \$3.00
	(Foreign) \$15.00

EMS Educational Microcomputer Systems
CALIFORNIA RESIDENTS ADD 6% TAX

P.O. BOX 16115 IRVINE, CA. 92713-6115

(714) 553-0133

THEY SAY IT ALL... WE DO IT ALL!



**ANNOUNCING
THE C86™ C COMPILER
— THE COMPILER THAT SPEAKS
THE LANGUAGE OF THE FUTURE!**

Kernighan and Ritchie's book, *The C Programming Language*, is the key source for C. Just as fundamental is the C86™ C Compiler.

The C86™ C Compiler is especially designed for the IBM® Personal, IBM® Display Writer, CP/M-86® and MS-DOS®

For further information on the C programming language and the C86™ C Compiler, please contact:



Computer Innovations, Inc.
75 Pine Street
Lincroft, New Jersey 07738
Telephone: (201) 530-0995

C86 is a trademark of Computer Innovations, Inc. CP/M 86 is a trademark of Digital Research. IBM and MS-DOS are registered trademarks of International Business Machines, Inc.

TRS-80™ DISCOUNT

BUY DIRECT

WE SELL THE FULL LINE OF TRS-80'S
AT WHOLESALE PRICES

COMPUTERS - PRINTERS - SOFTWARE



PURE RADIO SHACK EQUIPMENT

MODEL II
26-4002 64K 1 Drive..... **\$3098**

Ask About Hard Drives

MODEL III
26-1062 16K..... **\$819**

26-1066 48K with
2 Drives, RS232..... **\$2049**

COLOR COMPUTER
26-3001 4K..... **\$309**

26-3002 16K Ext. Basic..... **\$455**

26-3003 32K Ext. Basic..... **\$569**

Model 16 TRS-80..... **CALL**

Printers..... **CALL**

COLOR COMPUTER DISK DRIVES
26-3022 Color Disk Drive #1..... **\$498**

26-3023 Color Disk Drive #2, 3, 4..... **\$338**

- LARGE INVENTORY WRITE FOR YOUR
- FAST DELIVERY FREE CATALOG

**THOUSANDS OF SATISFIED
CUSTOMERS**

ORDER TOLL FREE

1-800-841-0860

**MICRO MANAGEMENT
SYSTEMS, INC.**

PARCEL DIVISION
DEPT. NO. 1

115 C. SECOND AVE. S.W. CAIRO, GA. 31728

GA. 912-377-7120

TM - TANDY CORPORATION

FREE COPY OF WARRANTY UPON REQUEST

BYTE LINES

analog-to-digital converter integrated circuit capable of operating at 50 megahertz and consuming only 700 milliwatts. Samples are already available. . . . Shugart Associates, Sunnyvale, California, is taking orders for its thin (half-size) 5¼-inch floppy-disk drive, dubbed the SA200. It will store 125K bytes single-sided and 250K bytes double-sided. The quantity price will be \$118. . . . the Destek Group, Mountain View, California, has announced a local-network (baseband-type) interface card for the IBM Personal Computer. It will use the HDLC (high-level data link control) and CSMA (Communication Systems Management Association) protocols. . . . Advanced Computer Security Concepts, Annandale, Virginia, has announced a "breakthrough" in preventing software piracy. It is based on a patented method using the Data Encryption

Standard approved by the U.S. National Bureau of Standards. . . . NEC Information Systems, Lexington, Massachusetts, has announced an 8-inch half-size floppy-disk drive storing 1.6 megabytes.

Quote of the Month:

"One leading microcomputer maker we worked with developed a prototype system with a memory cache, high-speed carry out, and a direct connection to a memory storage—they called it a 'cache and carry store.'"

Dr. Gary Kildall, President
Digital Research Inc.

MAIL: I receive a large number of letters each month as a result of this column. If you write to me and wish a response, please include a self-addressed, stamped envelope.

Sol Libes
POB 1192
Mountainside, NJ 07092

Huntington's Disease... The Genetic Time Bomb!



**NATIONAL
HUNTINGTON'S DISEASE ASSOCIATION**
Suite 501, 1441 Broadway, New York, N.Y. 10018
212-966-4320

79-11

THIS SPACE CONTRIBUTED BY THE PUBLISHER

Books Received

Artificial Intelligence: An MIT Perspective, volume I, Patrick Henry Winston and Richard Henry Brown, eds. Cambridge, MA: MIT Press, 1982; 497 pages, 14.5 by 22 cm, softcover, ISBN 0-262-73058-8, \$12.50.

Artificial Intelligence: An MIT Perspective, volume II, Patrick Henry Winston and Richard Henry Brown, eds. Cambridge, MA: MIT Press, 1982; 486 pages, 14.5 by 22 cm, softcover, ISBN 0-262-73059-6, \$12.50.

COBOL for the 80's, J. Wayne Spence. St. Paul, MN: West Publishing, 1982; 591 pages, 18 by 24 cm, softcover, ISBN 0-314-63290-5, \$18.95.

Computers and Data Processing, Concepts and Applications with BASIC, 2nd edition, Steven L. Mandell. St. Paul, MN: West Publishing, 1982; 675 pages, 18.5 by 25 cm, hardcover, ISBN 0-314-63263-8, \$21.95. *Study Guide to Accompany Computers and Data Processing, Concepts and Applications*, Steven L. Mandell. St. Paul, MN: West Publishing, 1979; 298 pages, 18 by 24.4 cm, softcover, ISBN 0-8299-0254-6, \$8.95.

Distributed Database Management Systems, Olin H. Bray. Lexington, MA: Lexington Books, 1982; 163 pages, 15.5 by 22.5 cm, hardcover, ISBN 0-669-03396-0, \$18.95.

Explore Computing with the TRS-80 (& Common Sense), With Programming in BASIC, Richard V. Andree and Josephine P. Andree. Englewood Cliffs, NJ: Prentice-Hall, 1982; 230 pages, 17.5 by 23.5 cm, hardcover, ISBN 0-13-296145-8, \$15.95.

From Images to Surfaces, A Computational Study of the Human Early Visual System, William Eric Leifur Grimson. Cambridge, MA: MIT Press, 1981; 274 pages, 15 by 23 cm, hardcover, ISBN 0-262-07083-9, \$25.

Fun with Microcomputers and BASIC, Donald D. Spencer. Reston, VA: Reston Publishing, 1981; 128 pages, 21 by 27.5 cm, softcover, ISBN 0-8359-2214-6, \$9.95.

How to Buy the Right Small Business Computer System, C. Roger Smolin. New York: John Wiley & Sons, 1981; 156 pages, 17 by 24.5 cm, softcover, ISBN 0-471-08494-8, \$8.95.

Introduction to System Dynamics Modeling with DYNAMO, George P. Richardson and Alexander L. Pugh III. Cambridge, MA: MIT Press, 1981; 413 pages, 15.5 by 22.5 cm, hardcover, ISBN 0-262-18102-9, \$25.

Wordstar Made Easy, Walter A. Ettlin. Berkeley, CA: Osborne/McGraw-Hill, 1981; 125 pages, 18.3 by 23 cm, spiral binder, ISBN 0-931988-69-1, \$7.95. ■

This is a list of books received at BYTE Publications during this past month. Although the list is not meant to be exhaustive, its purpose is to acquaint BYTE readers with recently published titles in computer science and related fields. We regret that we cannot review or comment on all the books we receive; instead, this list is meant to be a monthly acknowledgment of these books and the publishers who sent them.

Rave reviews

Circle 98 on inquiry card.



Getting them from the boss may be the best reason to switch to Opus.

Buying products that perform well is one of the yardsticks by which your own performance is measured. So we make sure you take center stage as soon as we get in on the act. For starters, we guarantee Opus performance. As well as 48-hour delivery turnaround time. Call 800/321-9330, or write to Computer Resources, Inc., 4650 West 160th Street, Cleveland, OH 44135.

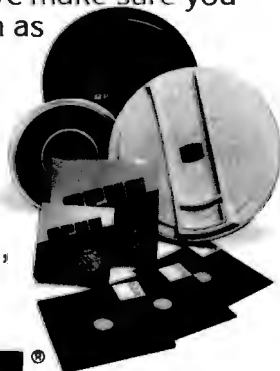

OPUS

Quality Flexible Diskettes, Single-Disk Cartridges, Multi-Level Disk Packs, and Magnetic Tape.

TERMINALS FROM TRANSNET

PURCHASE PLAN • 12-24 MONTH FULL OWNERSHIP PLAN • 36 MONTH LEASE PLAN

DESCRIPTION	PURCHASE PRICE	PER MONTH		
		12 MOS	24 MOS	36 MOS
DEC				
LA34 DEcWriter IV Forms Ctrl.	\$1,095	\$105	\$ 58	\$ 40
LA100 Letter Printer RO	1,995	190	106	72
LA120 DEcWriter III KSR	2,295	220	122	83
LA120 DEcWriter III RO	2,095	200	112	75
LA12A Portable DEcWriter	2,950	280	155	106
VT100 CRT DEcScope	1,695	162	90	61
VT101 CRT DEcScope	1,195	115	67	43
VT125 CRT Graphics	3,295	315	185	119
VT131 CRT DEcScope	1,745	167	98	63
VT132 CRT DEcScope	1,995	190	106	72
VT18XAC Personal Computer Option	2,395	230	128	86
TEXAS INSTRUMENTS				
T1745 Portable Terminal	1,595	153	85	58
T1765 Bubble Memory Terminal	2,595	249	138	93
T1 Insight 10 Terminal	695	67	37	25
T1785 Portable KSR, 120 CPS. ...	2,395	230	128	86
T1787 Portable KSR, 120 CPS. ...	2,845	273	152	102
T1810 RO Printer	1,695	162	90	61
T1820 KSR Printer	2,195	211	117	80
LEAR SIEGLER				
ADM3A CRT Terminal	595	57	34	22
ADM5 CRT Terminal	645	62	36	24
ADM32 CRT Terminal	1,185	112	65	42
ADM42 CRT Terminal	1,995	190	106	72
DATAMEDIA				
EXCEL 12 CRT Terminal	1,695	162	90	61
EXCEL 42 Smart Buffered CRT. ...	995	96	54	36
COLORSCAN 10 Color CRT	3,195	307	171	116
TELEVIDEO				
925 CRT Terminal	850	82	46	31
950 CRT Terminal	1,075	103	57	39
NEC SPINWRITER				
Letter Quality, 7715 RO	2,895	278	154	104
Letter Quality, 7725 KSR	3,295	316	175	119
GENERAL ELECTRIC				
2030 KSR Printer 30 CPS	1,195	115	67	43
2120 KSR Printer 120 CPS	2,195	211	117	80
HAZELTINE				
Executive 80/20	1,345	127	75	49
Executive 80/30	1,695	162	90	61
EPSON				
MX-80 F/T Printer	745	71	42	27
MX-100 Printer	895	86	48	32
TIMEPLEX				
E9400 4 Channel Stat Mux	1,525	147	82	55
E9800 8 Channel Stat Mux	2,050	197	110	74

FULL OWNERSHIP AFTER 12 OR 24 MONTHS • 10% PURCHASE OPTION AFTER 36 MONTHS

MICROCOMPUTERS

APPLE • COMMODORE • HP85 • DEC LSI 11

ACCESSORIES AND PERIPHERAL EQUIPMENT

ACOUSTIC COUPLERS • MODEMS • THERMAL PAPER • RIBBONS • INTERFACE MODULES • FLOPPY DISK UNITS



TRANSNET CORPORATION

1945 ROUTE 22 • UNION, N.J. 07083 • (201) 688-7800
TWX 710-985-5485 800-526-4965 OUTSIDE N.J.

Listing 2: The printer test program. This routine helps to check Epson MX-80 printers for the ghosting problem by producing a print-out similar to listing 1. This program should run under Microsoft BASIC (as used in the TRS-80 and other microcomputers).

```

1 'THIS PROGRAM CHECKS YOUR EPSON PRINTER FOR GHOSTING OF
2 'CHARACTERS IN (1) COMPRESSED DOUBLE PRINT MODE
3 ' (2) REGULAR SIZE EMPHASIZED MODE
10 '-----PRINTER SETUP-----
20 LPRINT CHR$(15); 'COMPRESSED CHARACTER MODE
30 LPRINT CHR$(27); CHR$(71); 'DOUBLE PRINT
40 '-----OUTPUT CHARACTERS FOR TEST-----
50 GOSUB 1000
60 '-----PRINTER SETUP-----
70 LPRINT CHR$(18); 'CANCELS COMPRESSED CHARACTER MODE
80 LPRINT CHR$(27); CHR$(69); 'EMPHASIZE MODE
90 GOSUB 1000
100 END
1000 FOR ROW=1 TO 10
1010 FOR X=64 TO 126
1020 LPRINT CHR$(X);
1030 NEXT X
1040 LPRINT; NEXT ROW
1050 RETURN

```



A Message to our Subscribers

From time to time we make the BYTE subscriber list available to other companies who wish to send our subscribers promotional material about their products. We take great care to screen these companies, choosing only those who are reputable, and whose products, services, or information we feel would be of interest to you. Direct mail is an efficient medium for presenting the latest personal computer goods and services to our subscribers.

Many BYTE subscribers appreciate this controlled use of our mailing list, and look forward to finding

information of interest to them in the mail. Used are our subscribers' names and addresses only (no other information we may have is ever given).

While we believe the distribution of this information is of benefit to our subscribers, we firmly respect the wishes of any subscriber who does not want to receive such promotional literature. Should you wish to restrict the use of your name, simply send your request to BYTE Publications Inc, Attn: Circulation Department, 70 Main St, Peterborough NH 03458. Thank you.

SLUDER PRESENTS

THE FINEST SYSTEMS & COMPONENTS FROM THE FINEST MANUFACTURERS LIKE

CompuProTM division **GODBOUT**
ELECTRONICS

LOMAS DATA PRODUCTS **SEATTLE COMPUTER**

MORROW DESIGNS

85/88, 64K, (2)8", DRS, CAB, I/O 4 \$2795.
 Godbout 8086 64K 3095.
 MPM(TM) 8-16 256K System w/Qumes 6645.
 LOMAS 10MHz 8086, 128K w/drives 2995.
 LOMAS MPM 86 System 256K 3995.
 Seattle System I \$2459. System II 3135.
 System II 128K & CVT DR CAB & DT8 4785.
 Seattle CPU 8086 Board Set & DOS 671.
 Seattle RAM+ 192K for IBM w/serial 595.
 Godbout Disk 2 \$596. Disk 1 A&T 371.
 Morrow Decision 1 Basic 1295.
 CPM & MPM ARE TM of Digital Research
 (714) 895-1746 All Prices Subject to chg
 PO BOX 951 Westminster, CA 92683

Draw Poker for the TI-59

Lee Boyle, 2702 E Linden, Tucson AZ 85716

The program presented here is very close to the limits of the TI-59 programmable calculator because it fills 480 program memory locations and uses 53 data registers. When writing such long programs, there are four interrelated constraints that you must consider:

1. The TI-59 has an absolute limit of 960 memory locations. This number becomes smaller as data registers are allocated.
2. Zero to 100 data registers may be allocated; however, each register subtracts 8 memory locations from the available number.
3. Each call to the random-number generator (using the keystrokes PGM 15 SBR DMS) requires 1.4 seconds. Occasional sacrifices must be made in the interest of speed.
4. Results—if the program doesn't perform the task,

nothing else matters. There are, however, always some compromises to be made.

Finding the right compromises and optimizations to make a large program fit into the available memory is always a challenge and it is a good way to refine your programming technique.

The game of Draw Poker can be divided into four major sections: dealing, evaluating the hand, drawing new cards, and betting. In this program, betting takes place only after a draw.

Deal (Key E)

The basic task of this section of the program is to randomly select eighteen numbers, with no repetition, from a set of fifty-two. These numbers must then be stored as five cards for the calculator, five for the user, and eight to be saved in a *draw stack* that will allow each party to exchange a maximum of four cards. The cards are stored in the form RR.S, where RR represents the rank (deuce through ace), and S represents the suit.

One method of drawing without repetition is to assign a data register to each card possibility and, when a card is chosen, to cross it off by storing a 1 in that register. The table is consulted as each card is dealt, to make sure that it has not been chosen before. This method is short, quick, easy, and random; unfortunately, the table requires fifty-two data registers, and we do not have that much memory to spare.

As a compromise, this program uses one register for each of the thirteen ranks, counting to assure that none is used more than four times. Suits are determined by the value 0.1, 0.2, 0.3, or 0.4, randomly stored in each register individually. Each time a card is chosen and the corresponding register is incremented, the fractional part is also incremented (e.g., 0.5 is reset to 0.1) so that the next card chosen from that rank will be of a different suit.

This method has the disadvantage of allowing you to predict the suit of the next card chosen from a given rank, but this is rarely, if ever, useful information.

When all eighteen cards have been dealt, subroutine 012 of Master Library program 1 is used to erase the dealing table. Subroutine SUM then uses this space to create a *tally table* that records the number of cards of each rank dealt to the calculator. Finally, subroutine A' is called to display your hand.

Evaluation (Subroutine FIX)

In evaluating a poker hand, the calculator must test for three conditions:

New from Tarbell... 4 SERIAL/2 PARALLEL BOARD

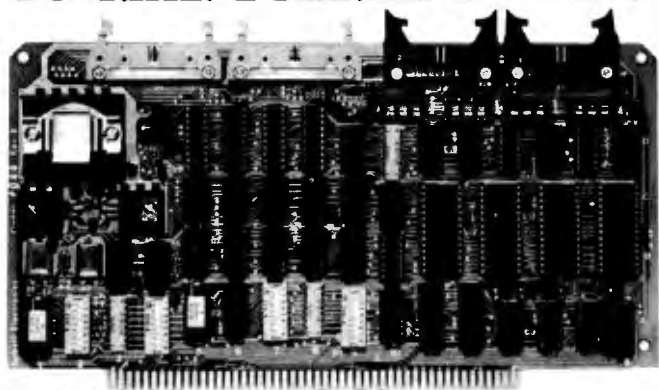

S-100 Compatible

Tarbell Electronics introduces a four-serial/two-parallel port board. The four RS-232 serial input/output ports utilize four 8251's and eight consecutive 8080 ports. Features include full handshaking capability and four separate dip-switch controlled baud-rate generators. Support is provided by Tarbell's XIOS for the Digital Research MP/M-II.

Two eight-bit parallel I/O ports include four eight-bit latches (74LS373's) and use four consecutive 8080 ports. There are separate handshaking

lines, outputs that will drive up to 30 ma and inputs with less than .4 ma load.

This new board is S-100 compatible and is capable of creating interrupts for the Tarbell CPU. All cables are included; the board comes completely assembled and thoroughly tested with a six-month no-fault *full* warranty.

Tarbell
Electronics

950 DOVLEN PLACE • SUITE B
CARSON, CA 90746 • (213) 538-4251

Listing 1: Draw Poker for the TI-59 programmable calculator.

000	76	LBL	051	32	X: T
001	58	FIX	052	43	RCL
002	22	INV	053	03	03
003	86	STF	054	22	INV
004	01	01	055	67	EQ
005	00	0	056	55	÷
006	42	STD	057	43	RCL
007	05	05	058	00	00
008	04	4	059	42	STD
009	03	3	060	04	04
010	42	STD	061	08	8
011	01	01	062	44	SUM
012	43	RCL	063	01	01
013	24	24	064	76	LBL
014	69	DP	065	55	÷
015	10	10	066	02	2
016	42	STD	067	32	X: T
017	03	03	068	73	RC*
018	01	1	069	00	00
019	01	1	070	22	INV
020	42	STD	071	77	GE
021	00	00	072	65	x
022	01	1	073	85	+
023	03	3	074	01	1
024	42	STD	075	95	=
025	06	06	076	44	SUM
026	76	LBL	077	01	01
027	85	+	078	43	RCL
028	69	DP	079	00	00
029	20	20	080	87	IFF
030	01	1	081	01	01
031	32	X: T	082	43	RCL
032	73	RC*	083	48	EXC
033	00	00	084	04	04
034	77	GE	085	76	LBL
035	87	IFF	086	43	RCL
036	00	0	087	42	STD
037	42	STD	088	05	05
038	03	03	089	04	4
039	61	GTD	090	07	7
040	65	x	091	32	X: T
041	76	LBL	092	43	RCL
042	87	IFF	093	01	01
043	43	RCL	094	22	INV
044	00	00	095	67	EQ
045	42	STD	096	65	x
046	02	02	097	86	STF
047	01	1	098	01	01
048	44	SUM	099	76	LBL
049	03	03	100	65	x
050	05	5			

Listing 1 continued on page 436

WARNING!

**Electric Power Pollution.
Spikes & Lightning
HAZARDOUS to
MICROCOMPUTERS!!**

Patented ISOLATORS provide protection from ...

- Computer errors cause by power line interference
- Computer errors due to system equipment interaction
- Spike damage caused by copier/elevator/air conditioners
- Lightning caused damage

MONEY BACK GUARANTEE!

- ISOLATOR (ISO-1) 3 Isolated 3-prong sockets; Spike Suppression; useful for small offices, laboratories, classrooms. \$69.95
- ISOLATOR (ISO-2) 2 isolated 3-prong socket banks; (6 sockets total); Spike Suppression; useful for multiple equipment installations. \$69.95
- SUPER ISOLATOR (ISO-3) similar to ISO-1 except double isolation & oversize Spike Suppression; widely used for severe electrical noise situations such as factories or large offices. \$104.95
- SUPER ISOLATOR (ISO-11) similar to ISO-2 except double isolated socket banks & Oversize Spike Suppression; for the larger system in severe situations. \$104.95
- MAGNUM ISOLATOR (ISO-17) 4 Quad Isolated Sockets; Multiple Spike Suppressors; For ULTRA-SENSITIVE Systems in extremely Harsh environments. \$181.95
- CIRCUIT BREAKER, any model (Add-CB) Add \$9.00
- REMOTE SWITCH, any model (Add-RS) Add \$16.00

AT YOUR DEALERS MasterCard, Visa, American Express
ORDER TOLL FREE 1-800-225-4878 (except AK, HI, PR & Canada)



ISO-1
ISO-2
Pat. #4,259,705

ES Electronic Specialists, Inc.
 171 South Main Street Box 389 Natick, Mass 01760
 (617) 655-1532

WHY BUY



MM-103 MODEMS

With our unbeatable quality, low cost, one-year warranty and 24 hour a day Test Center, you won't find a better S-100 bus modem than the MM-103!

Call or write for brochures and price information.



POTOMAC MICRO-MAGIC, INC.
 5201 Leesburg Pike, Suite 804
 Falls Church, VA 22041
 (703) 379-9880 (VOICE)
 (703) 379-0303 (MODEM) 300 BAUD
 MEETS IEEE S-100 STANDARDS

MORE THAN 50 REASONS!

SUPERIOR PERFORMANCE
REMOB SOFTWARE MAINTENANCE
550B SENSITIVITY
REMOB CONTROL
FCC APPROVED
500B DYNAMIC RANGE
LASER DATA
MULTIPLE MODEM POWER-UP

DIAL TONE DETECTOR
FSK BINARY MODEM
MESSAGE SWITCH
MESSAGE FILTERS
GATHERING
TUNED MULTIPLE MODEM POWER-UP

WHY BUY

MM-103 MODEMS

With our unbeatable quality, low cost, one-year warranty and 24 hour a day Test Center, you won't find a better S-100 bus modem than the MM-103!

Call or write for brochures and price information.



POTOMAC MICRO-MAGIC, INC.
 5201 Leesburg Pike, Suite 804
 Falls Church, VA 22041
 (703) 379-9880 (VOICE)
 (703) 379-0303 (MODEM) 300 BAUD
 MEETS IEEE S-100 STANDARDS

SOME SATISFIED MM-103 USERS

AEROSPACE CORPORATION
JET PROPULSION LABS
NATL BUREAU OF STANDARDS
PCA
US DEPARTMENT OF JUSTICE
WESTERN ELECTRIC
ALABAMA
FLORIDA
MICHIGAN
UCLA

ANSWER PROGRAMMABLE TIMER
SERIAL-PARALLEL CONCENTRATOR
REMOTE DATA BASE
HALF DUPLEX
ODD PARITY
POINT OF SALE
ALARM
ASYNCHRONOUS
AUTO ANSWER
DATA TERMINAL
ASCII
MULTIFUNCTION CONTROL
MASKABLE INTERRUPTS
RJT JACK
MASKABLE INTERRUPTS
CDDOS
STANDARDS SYSTEMS
LOCKHEED

AFTER ALL...
ALL MODEMS
ARE NOT
CREATED EQUAL!

Overcome CP/M Limitations

TurboDOS

The Professional CP/M-Compatible Operating System

- **CP/M Compatible** Virtually any CP/M (ver. 2.x) program will run under TurboDOS without modification. Fully media compatible with standard CP/M-format diskettes.
- **Spectacular Performance** Programs run 3-10 times faster than TRSDOS or CP/M. Benchmark results to 20 times faster with some applications, as tested by an independent firm.
- **Double-Sided Drive Support** Provides 1.25 MBytes of Storage per 8" double-sided/density disk. Intermix combinations of single or double sided drives on line.
- **Expanded Directories** Store more files and information per disk.
- **Automatic Density Side Recognition** Detects changes in disk format automatically. Change disks at any time without compromising data or "BDOS/Read-Only" errors.
- **Fast Disk Backup** Copy an 8" SS/DD diskette (610K) in less than 80 seconds.

Copy a double sided/density diskette (1.25 MBytes) in under 1 min. 45 sec.

- **Hard Disk Drive Support** Supports large hard disks in excess of 1,000 MBytes without partitioning.
- **Advanced Utilities** Complete set of disk utilities, system date and time functions, communications channel interface, and more included.
- **Enhanced Automatic Print Spooling** Run multiple printers simultaneously. Supports multiple queues and printers on spooling versions, standard.
- **Advanced Mainframe-like Features** Includes read-after-write validation of all disk update operations, type-ahead buffers, incremental disk backup utility, password/log-on security, system date and time functions, accepts string of multiple commands, and many other capabilities not available under CP/M or TRSDOS. Multi-user networking versions also available.

Versions for TRS-80 Mod II & Xerox 820.
Print spooling option \$50 additional.
Adaptable to any Z80-based computer.

**Only
\$249**

Manual \$25
refundable
with purchase.



DATA-RX, INC.

686 Lighthouse Ave., Monterey, Ca 93940

(408) 375-2775

TURBODOS is the registered trademark of Software 2000
CP/M, MP/M, and CP/NET are registered trademarks of Digital Research. Dealer/OEM Inquiries Invited.

DEC LSI-11 Components

Dependable service
at discount prices

Domestic
and Export

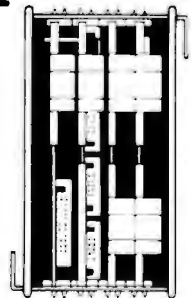

Mini
Computer Suppliers, Inc.

25 Chatham Rd., Summit, N.J. 07901
Since 1973

(201) 277-6150 Telex 13-6476

©Mini Computer Suppliers, Inc.
1979

Desk-Top Wonders

Listing 1 continued:

101	97	DSZ	153	10	E*
102	06	06	154	69	DP
103	85	+	155	21	21
104	43	RCL	156	01	1
105	25	25	157	71	SBR
106	22	INV	158	88	DMS
107	59	INT	159	04	4
108	32	X:T	160	95	=
109	02	2	161	59	INT
110	05	5	162	55	÷
111	42	STD	163	01	1
112	07	07	164	00	0
113	04	4	165	95	=
114	42	STD	166	72	ST*
115	06	06	167	01	01
116	76	LBL	168	97	DSZ
117	97	DSZ	169	00	00
118	69	DP	170	10	E*
119	27	27	171	01	1
120	73	RC*	172	08	8
121	07	07	173	42	STD
122	22	INV	174	00	00
123	59	INT	175	02	2
124	22	INV	176	05	5
125	67	EQ	177	42	STD
126	68	NOP	178	01	01
127	97	DSZ	179	04	4
128	06	06	180	32	X:T
129	97	DSZ	181	76	LBL
130	01	1	182	45	Y*
131	44	SUM	183	01	1
132	01	01	184	02	2
133	43	RCL	185	71	SBR
134	02	02	186	88	DMS
135	42	STD	187	01	1
136	04	04	188	03	3
137	76	LBL	189	95	=
138	68	NOP	190	59	INT
139	73	RC*	191	42	STD
140	01	01	192	02	02
141	92	RTN	193	73	RC*
142	76	LBL	194	02	02
143	15	E	195	77	GE
144	01	1	196	45	Y*
145	03	3	197	22	INV
146	42	STD	198	59	INT
147	00	00	199	65	X
148	01	1	200	01	1
149	01	1	201	00	0
150	42	STD	202	95	=
151	01	01	203	22	INV
152	76	LBL	204	67	EQ

Listing 1 continued:

205	23	LNx	257	91	R/S
206	93	.	258	05	5
207	04	4	259	42	STD
208	22	INV	260	07	07
209	74	SM*	261	76	LBL
210	02	02	262	66	PAU
211	04	4	263	69	DP
212	76	LBL	264	23	23
213	23	LNx	265	73	RC*
214	55	÷	266	03	03
215	01	1	267	75	-
216	00	0	268	01	1
217	85	+	269	00	0
218	43	RCL	270	95	=
219	02	02	271	66	PAU
220	95	=	272	66	PAU
221	72	ST*	273	66	PAU
222	01	01	274	97	DSZ
223	01	1	275	07	07
224	93	.	276	66	PAU
225	01	1	277	92	RTN
226	74	SM*	278	76	LBL
227	02	02	279	44	SUM
228	69	DP	280	74	SM*
229	21	21	281	25	25
230	97	DSZ	282	74	SM*
231	00	00	283	26	26
232	45	Yx	284	74	SM*
233	43	RCL	285	27	27
234	09	09	286	74	SM*
235	32	X:T	287	28	28
236	02	2	288	74	SM*
237	04	4	289	29	29
238	36	PGM	290	92	RTN
239	01	01	291	76	LBL
240	71	SBR	292	88	DMS
241	00	00	293	85	+
242	12	12	294	36	PGM
243	32	X:T	295	15	15
244	42	STD	296	71	SBR
245	09	09	297	88	DMS
246	01	1	298	65	x
247	71	SBR	299	92	RTN
248	44	SUM	300	76	LBL
249	02	2	301	13	C
250	09	9	302	85	+
251	42	STD	303	02	2
252	03	03	304	09	9
253	76	LBL	305	95	=
254	16	A*	306	42	STD
255	09	9	307	00	00
256	35	1/x	308	00	0

Listing 1 continued on page 438

MODEM HEADQUARTERS

Connect any computer or terminal to the phone lines!

1200 Baud — 120 Characters per Second

Penril 300/1200 \$739

Bell 212A identical. Full duplex, RS232. 1200 and 300 Baud. Originate/auto-answer. Phone connection via RJ11C standard phone jack. One year warranty. Self-test. Fits under phone.

300/1200 Auto-Dialer \$225

Allows any computer to automatically dial out through the Penril 300/1200.

300 Baud — 30 Characters per Second

Phone Link Acoustic Modem \$129

Originate and Answer. Half/Full duplex. RS232. Operates with any standard telephone. Indicators for On, Carrier, Self-test, Send Data, Receive Data. One year warranty.

Micro-link \$179

Originate/Auto-Answer, Half/Full duplex. RS232. Phone connection via RJ11C standard phone jack. Indicators for On, Carrier Detect, Self-test, Send Data, Receive Data. Two year warranty. Fits under phone.

ADDS Viewpoint CRT \$529

GE2120 Printing Terminal \$1,799
150 CPS. 300/1200 Baud.

GE2030 Printing Terminal \$999
60 CPS. 300/1200 Baud.

All equipment is in stock. Your satisfaction guaranteed. Any product may be returned for full credit. Write or call for full product information.



U.S. ROBOTICS INC.
203 N. WABASH
SUITE 1718
CHICAGO, ILL 60601
(312) 345-5650

THIS MONTH'S TOP TEN

CP/M® software for IBM, Osborne, Xerox, Apple, Televideo, TRS 80 II, 8" SSD, Northstar

TITLE	MANUFACTURER	LIST	NOW
dBases II	Ashken Tote	700.00	499.00
WordStar	MicroPro	495.00	299.00
WordStar w/ MailMerge	MicroPro	645.00	369.00
Supercalc	Sorcom	295.00	219.00
Personal NT +	D. Research	475.00	429.00
CalcStar	MicroPro	295.00	189.00
CS-III	D. Research	500.00	429.00
Mathmagic	I. S. Mating	100.00	65.00
PL 1/80	D. Research	500.00	429.00
Select w/ SuperSpot	Select Info Systems	595.00	395.00

This is just a sample of the CP/M® software available from DataSource. Call us for the package you need in your format.

SMITH-CORONA TP-1 Daisy-wheel printer

750⁰⁰!

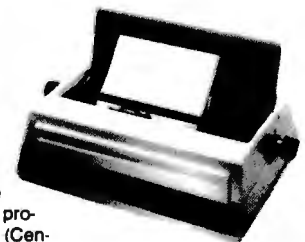

New letter-quality printer for IBM, Apple, TRS-80, Xerox, Osborne, etc. Unbelievable price for 120 wpm word processing quality. Parallel (Centronics) interface or RS232 serial interface (specify).

List 895.00 750.00
Cable for TP-1 (specify computer) 40.00
Apple parallel interface (w/cable) 120.00

Call for more great buys on C.I.T.O.H., Hayes, etc.

ORDER/TECHNICAL HOTLINE:
1-612-944-7907

ORDERING INFORMATION: Min. \$99.95. Cash or money order. Charge cards add 3% shipping. \$3.00 per software item. 2% per hardware item. Min. res. add 5% sales tax. Pricing and avail. subject to change. Prices are mail order only. DataSource is a Division of DataSource Systems Corporation. CP/M is a registered trademark of Digital Research Corp.

DataSource Systems
P.O. BOX 35007 MINNEAPOLIS, MN 55435 • 612-944-7907

DATA SOURCE

470 16 R*
471 91 R/S
472 15 E
473 76 LBL
474 12 B
475 75 -
476 05 5
477 95 =
478 91 R/S
479 11 R

LABLES

001 58 FIX
027 85 +
042 87 IFF
065 55 ÷
086 49 RCL
100 65 X
117 97 DSZ
138 68 MDP
149 15 E
159 10 E*
182 45 YX
219 23 LNX
254 16 R*
262 66 PAU
279 44 SUM
292 88 DMS
301 19 C
319 14 D
326 78 Z+
347 42 STD
367 95 I/X
374 48 EXC
391 99 .
407 80 GRD
436 98 SIN
452 11 R
474 12 B

417 03 03
418 71 SBR
419 16 R*
420 91 R/S
421 71 SBR
422 58 FIX
423 65 X
424 49 RCL
425 04 04
426 85 +
427 01 1
428 00 0
429 71 SBR
430 88 DMS
431 05 5
432 95 =
433 32 X+T
434 25 CLR
435 76 LBL
436 38 SIN
437 85 +
438 05 5
439 95 =
440 91 R/S
441 32 INV
442 77 GE
443 98 SIN
444 02 2
445 00 0
446 22 INV
447 77 GE
448 11 R
449 25 CLR
450 91 R/S
451 76 LBL
452 11 R
453 79 RC*
454 01 01
455 22 INV
456 59 INT
457 85 +
458 43 RCL
459 04 04
460 75 -
461 01 1
462 00 0

364 44 SUM
365 03 03
366 76 LBL
367 35 I/X
368 69 DP
369 27 27
370 97 DSZ
371 02 02
372 42 STD
373 76 LBL
374 48 EXC
375 49 RCL
376 09 03
377 91 R/S
378 01 1
379 00 0
380 42 STD
381 00 00
382 02 2
383 04 4
384 42 STD
385 02 02
386 09 9
387 04 4
388 42 STD
389 07 07
390 76 LBL
391 99 .
392 29 CP
393 69 DF
394 22 22
395 73 RC*
396 02 02
397 22 INV
398 67 EQ
399 80 GRD
400 69 DP
401 27 27
402 79 RC*
403 07 07
404 72 ST*
405 02 02
406 76 LBL
407 80 GRD
408 97 DSZ
409 00 00

311 R/S
312 LBL
313 D
314 71 SBR
315 58 FIX
316 29 CP
317 22 INV
318 67 EQ
319 78 Z+
320 49 RCL
321 02 02
322 42 STD
323 04 04
324 00 0
325 76 LBL
326 78 Z+
327 32 X+T
328 00 0
329 42 STD
330 09 03
331 01 1
332 94 +/
333 71 SBR
334 44 SUM
335 09 9
336 22 INV
337 77 GE
338 48 EXC
339 02 2
340 05 5
341 42 STD
342 07 07
343 05 5
344 42 STD
345 02 02
346 76 LBL
347 42 STD
348 79 RC*
349 07 07
350 59 INT
351 32 X+T
352 43 RCL
353 04 04
354 67 EQ
355 35 I/X
356 RCL

Listing 1 continued:

DATA

0.	43
5. 88888	44
0.	45
1. 00011	46
3. 00111	47
7. 01111	48
2. 11022	49
4. 11122	50
6. 12345	51
8. 12345888	52

1. Five cards in sequence by rank define a *straight*.
2. Multiple cards of the same rank define 2, 3, or 4 of a kind.
3. Five cards of the same suit define a *flush*.

To save steps, the first two of these conditions are tested simultaneously by stepping through the tally table rank by rank. If five sequential cards are found, 8, the code for a straight, is added into R01 (data register 01). If a tally value is 2, 3, or 4, the hand will contain the corresponding multiple, and the appropriate code (3, 4, or 5, respectively) is added into R01.

To test for a flush, the program compares the fractional parts of the five cards; if they are all equal, the hand contains a flush (code = 1).

Since half of the possible poker hands contain more than one of these conditions, provisions must be made to allow the results to be combined. For example, if a pair and three of a kind are found in the same hand, the calculator must recognize that it has a full house. To reduce the amount of program logic required, the poker hands have been assigned code numbers that can be added to give the total value of the hand. For example, the codes for a pair and for three of a kind are 3 and 4 respectively, so the code 7 denotes a full house. Similarly, 8 (straight) + 1 (flush) = 9 (straight flush). In each case, the details of the hand (pair of what?) are stored in R04 and R05.

The final steps of this program section use the table in R44 to R52 to translate the value in R01 into a new code giving the relative value of the hand (0 through 8) as the integer part and a symbolic representation of the hand as the fractional part (see table 1).

Draw (Keys C and D)

This section is relatively simple. Indicate those cards you wish to discard (if any) as 1 for the first card, 2 for the second, etc. You are trusted to discard no more than four cards.

The program then calls subroutine FIX to evaluate its hand. If the value is four-of-a-kind or better, no discard is made. If no hand is discovered, the calculator simply

discards all but the high card. Otherwise, the rank of each card is compared to the values in R04 and R05 to determine whether or not that card is used in the hand. If it is not, it is discarded. Discarding is simply a matter of storing a zero in that register.

When the calculator has finished discarding, it stops to display the number of cards it is taking, then fills the zeroed register from the previously dealt draw stack. Your hand is then displayed as before, and the program is ready to begin betting.

Betting (Keys A and B)

Memory limitations have made this section simpler than it could be. It is, however, capable of some realistic betting exchanges.

The calculator always opens with five. You may then call by pressing A, fold by pressing B, or raise the pot by entering the new *total* (not the amount of the raise) and pressing R/S. In the latter case, the program compares the value of the pot to a betting limit and calls, folds, or raises accordingly. The betting limit is an arbitrary function involving the value of the calculator's hand and a random number.

When either party calls, the calculator displays the symbolic value of its hand, or the high card if it has no hand. This value may also be displayed at your option

UV EPROM ERASER

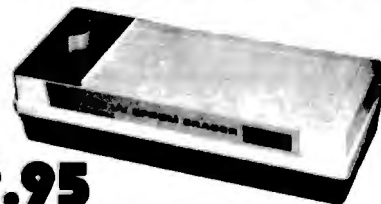

\$49.95

- ERASES ALL UV ERASABLE EPROMS (2708, 2716, 2564, etc.)
- QUICK FIFTEEN MINUTES ERASE TIME
- ERASES OVER FIFTEEN EPROMS AT A TIME
- LAMP LIFE, 7700 HOURS
- INDUSTRIAL MODEL \$68.50
- INDUSTRIAL MODEL WITH TIMER & SAFETY INTERLOCK SWITCH \$97.50 (Rugged steel enclosure with bottom drawer)

THE BEST 6809 SINGLE BOARD COMPUTER AVAILABLE

- Floppy Controller
- Printer Port
- RS-232 Port
- SWTPC compatible
- Runs TSC Flux
- Full Documentation

PRICE: \$389.00

FOR THE SS-50 AND S-100 BUS
ASSEMBLED, TESTED, 48 HOUR BURN-IN, 90 DAY WARRANTY

2716 EPROMS 450 ns \$4.95 DIRECT FROM FACTORY

SS-50 6809 CPU CARD: 1MHZ \$149.00 2MHZ \$189.00

RS-232 INTELLIGENT EPROM PROGRAMMER... \$489.00
Programs: 2716, 2516, 2532, 2732, 8748, 8749

ANTISTATIC FOAM 4" x 8" \$3.95

WE ACCEPT VISA, MASTERCARD, C.O.D., CHECKS

PHONE ORDERS (305) 776-5870

TWX: 510-855-8486 • Engineering Hot-Line: (305) 874-0867

LOGICAL DEVICES INC.

781 W. OAKLAND PARK BLVD. • FT. LAUDERDALE, FLORIDA 33311

ADD: \$3.00 SHIPPING, \$2.00 C.O.D. CHARGES

Desk-Top Wonders

after either party has folded. The calculator's individual cards are available for display at your request.

When you fold, the calculator displays the amount you have forfeited. The calculator folds by displaying a zero. You must keep track of your own winnings.

This program is shown in listing 1, with a sample run given in listing 2. Before the program is executed, the data in table 1 should be loaded into the calculator. The register allocations are given in table 2, and the user definable key functions for this program are given in table 3. The sample run in listing 2 should clarify the program operation; when in doubt, press the R/S key. ■

Register	Code	Hand
43	0	No hand
44	5.88888	Flush
45	0	Not used
46	1.00011	Pair
47	3.00111	3 of a kind
48	7.01111	4 of a kind
49	2.11022	2 pair
50	4.11122	Full house
51	6.12345	Straight
52	8.12348888	Straight flush

Table 1: Numerical codes for poker hands. This data must be in memory at the beginning of execution. To store them on a data card, the WRITE 3 command can be used. The codes listed here are shown as they are used internally; when they are displayed, the integer part of the number is replaced by the detail value from R04. For example, a jack-high straight is displayed as 11.12345.

Register	Function
00	Various functions
01	Hand code
02,03	Various functions
04,05	Hand details
06, 07, 08	Various functions
09	Random seed
12 through 24	Deal/tally tables
25 through 29	Calculator's cards
30 through 34	Player's cards
35 through 42	Draw stack
43 through 52	Code table (table 1)

Table 2: Data register allocations. Note that registers 00, 02, 03, and 06 through 08 serve temporary functions at various points throughout the program.

Key	Use
A	Call
B	Fold
C	Discard
D	Draw
E	Deal

Table 3: User-defined keys for TI-59 Draw Poker.

Listing 2: A sample run of Draw Poker for the TI-59 programmable calculator.

Keystrokes	Display	Comments
	3.45	Seed for random-number generator. Enter a new number each time you begin to use the program.
E	.111111111	Deal (takes about 2 minutes); when the calculator is ready to display your hand, it regains your attention by displaying .111111111.
R/S	2.4	Your cards are displayed, pausing 1.5 seconds for each card to allow you to copy (or memorize) them.
	4.2	
	9.2	
	7.3	
	3.4	
1 C	0	Discard; you are keeping only the third card dealt to you.
2 C	0	
4 C	0	
5 C	0	
D	0	Draw; you press D when you are finished discarding. The calculator shows that it is not discarding any cards.
R/S	.111111111	The new cards are dealt from the draw stack.
R/S	4.3	Your cards are displayed as before.
	2.1	
	9.2	
	9.3	
	9.4	
R/S	5	The calculator opens the betting with 5.
7 R/S	12	You raise 2. The calculator raises again by 5.
A	14.01111	Call; you call at 12. The calculator shows that it has four aces (14's).
R/S	.111111111	Not trusting the machine, you demand to see its cards. Otherwise you would press E for the next hand.
R/S	14.3	The calculator's cards are displayed as yours were before.
	14.4	
	10.2	
	14.1	
	14.2	
R/S	.111111111	You admit defeat and call for the next hand to be dealt. Pressing E would have the same effect.

BYTE's Bits

FORTH Coding Sheets

A FORTH coding sheet, used for documenting the operation of FORTH words (programs), is available free of charge from Curry Associates. Although space does not permit us to show an example of the sheet, suffice to say that it allows the user to show the effects of FORTH words on both the parameter and return stacks, as well as make comments on the definition in progress. The coding sheet can be photocopied and used without restriction. To get a copy of the sheet, write Curry Associates, POB 11324, Palo Alto, CA 94306. ■

Generate Huffman Codes

Jeff Sellers
Perkins-Elmer Corporation
Main Ave.
Norwalk, CT 06856

As Harold Corbin reported in "An Introduction to Data Compression" (April 1981 BYTE, page 218), the Huffman coding technique can be used to significantly reduce the number of bits required to represent a set of characters. I wrote a BASIC program that constructs a data tree and traces each character's path (see listing 1). The program reads data pairs consisting of a symbol or phrase and its rate of occurrence. With this information, a binary tree is set up in the matrix labeled P. Each row in this matrix contains two branch labels and the node's rate of occurrence (i.e., the sum of the two branch frequencies). Once the tree is complete, each character's path through the branches is traced, and the resulting code is stored in the matrix labeled H.

It's important to remember that the code produced by the program is not unique. Different results are obtained if the order of data entry is changed. The character set is not limited to single symbols.

I wrote my program for an IBM 5100 portable computer, but it should work well with most small computers with little or no modification. It allows each symbol entry to be up to 16 bytes long, which permits commonly found phrases to be assigned separate codes. This approach reduces storage requirements even further. Also, the frequency data does not have to be normalized to 1. It could be entered as a percentage or as the number of times each character or phrase is found in a file. ■

Listing 1: A BASIC program that produces a Huffman code for a set of characters and phrases. Though written to run on the IBM 5100 portable computer, it should work equally well on most small computers with little or no modification.

```
10 REM -----HUFFMAN CODE GENERATOR-----
20 REM THIS PROGRAM WILL ACCEPT A LIST OF SYMBOLS AND THE
30 REM FREQUENCY OF OCCURRENCE OF EACH SYMBOL. FROM THIS
40 REM INFORMATION EACH SYMBOL WILL BE GIVEN A CODE.
70 REM JEFF SELLERS 27 MAY 1981
80 DIM C$(100),P(50,3)
90 DIM F(100),H(50,20)
100 E=1
110 PRINT
120 REM GET CHARACTERS AND FREQUENCY
130 READ C$(E),F(E)
140 IF F(E)=9999 THEN 180
150 E=E+1
160 GO TO 130
170 REM GET ANOTHER CHARACTER
180 I1=1
190 E=E-1
200 REM E= NUMBER OF SYMBOLS ENTERED
210 REM THIS SECTION FORMS THE BINARY TREE. A LIST OF THE BRANCHES
220 REM WHICH MAKEUP EACH NODE IS PLACED IN MATRIX P
230 REM ONE BRANCH'S LABEL IS IN COLUMN 1 WHILE THE OTHER
240 REM LABEL IS IN COLUMN 2. THE THIRD COLUMN CONTAINS THE
250 REM RATE OF OCCURRENCE FOR THAT NODE.
260 GOSUB 750
270 REM GET SYMBOL OR NODE WITH LOWEST FREQ. IN INDEX I
280 REM M IS THE VALUE OF THE OCCURRENCE RATE
290 IF M=9999 THEN 430
300 P(I,1)=I
310 M1=M
320 GOSUB 750
330 REM GET NEXT LOWEST FREQ VALUE AND ITS INDEX
340 IF M=9999 THEN 430
350 P(I,2)=I
360 REM CALCULATE NEW NODE'S FREQ
370 P(I,3)=M1+M
380 I1=I1+1
390 GO TO 260
410 REM THIS SECTION TRACES EACH SYMBOL FROM THE TOP
420 REM OF THE TREE TO THE BASE
430 FOR T=1 TO E
440 S=T
450 REM N IS THE NUMBER OF NODES IN THE TREE
460 N=I1-1
470 N2=1
480 FOR K=N2 TO N
490 REM IS THIS BRANCH PART OF THIS NODE?
500 IF S<>P(K,1) THEN 550
510 REM YES, ADD A ZERO TO THE CODE
520 F=F+0
530 GO TO 580
540 REM IS THIS BRANCH PART OF THIS NODE?
550 IF S<>P(K,2) THEN 610
560 REM YES, ADD A ONE TO THE CODE
570 F=F+1
580 GOSUB 990
590 REM CALCULATE THE LABEL OF THE NEXT NODE TO FIND
600 S=K+E
610 NEXT K
620 REM TRACE NEXT CHARACTER THROUGH TREE
630 NEXT T
640 REM THIS SECTION PRINTS THE CHARACTER SET AND CODES
650 FOR Z=1 TO E
660 PRINT C$(Z),F(Z)
670 FOR Y=H(Z,1) TO 1 STEP -1
680 PRINT H(Z,Y+1);
690 NEXT Y
700 REM
710 REM END OF LINE
720 PRINT
730 NEXT Z
740 STOP
750 REM SUBROUTINE SMALL
760 REM THIS ROUTINE RETURNS THE SMALLEST FREQUENCY
770 REM VALUE IN M, POINTER IS IN I. IT REPLACES
780 REM THE SMALL FREQ, WITH 9999.
790 REM IT SEARCHES BOTH THE CHAR, FREQ. ARRAY F AND
800 REM THE FREQ. OF NODES IN MATRIX P COLUMN 3.
810 M=9999
820 FOR J=1 TO E
830 IF F(J)<M THEN 860
840 M=F(J)
850 I=J
860 NEXT J
870 FOR J=1 TO I1-1
880 IF P(J,3)<M THEN 910
890 M=P(J,3)
900 I=J+E
910 NEXT J
920 IF I<=E THEN 950
930 P(I-E,3)=9999
940 GO TO 960
950 F(I)=9999
960 RETURN
970 REM END SUBROUTINE SMALL
980 REM
990 REM SUBROUTINE HUFFY. PLACES FLAG IN MATRIX H
1000 REM THE LENGTH OF EACH CODE IS IN MATRIX H COLUMN 1
1010 REM
1020 H(T,1)=H(T,1)+1
1030 C2=H(T,1)+1
1040 H(T,C2)=F
1050 RETURN
1060 REM HERE IS A SAMPLE DATA SET.
1070 DATA 'A',30,'E',25,'I',20,'O',15,'U',10
1080 DATA 'END OF DATA',9999
1120 END
```

Tuning Up the 1802 A Simple Music Composition Trainer

The RCA VIP can give beginning composers audio and visual feedback.

Art Makosinski
692 Albert St.
Fredericton, New Brunswick, E3B 2C4, Canada

Trying to represent a hummed note on a musical staff can be frustrating for the inexperienced composer, but for many people the personal computer has come to the rescue. However, music programs and their associated hardware are quite complicated, and it can take as long to master them on a personal computer as it does to learn how to play a cathedral-sized organ.

Here's a program that can help budding computer musicians grasp the basics of music and have fun at the same time. The program lets you hear the tones as they are entered on a keyboard while simultaneously displaying them on a musical staff. It stores the notes and allows for editing and controlled playback. Written for the RCA VIP equipped with at least 2K bytes of memory and the 512-byte CHIP-8 interpreter, the program will also work on an ELF II preprogrammed with CHIP-8.

For those unfamiliar with the CHIP-8, it's a hexadecimal interpreter written by RCA for its CDP 1802 microprocessor. In the world of software, interpreters lie some-

where between assembly-level programs and more elaborate compiled languages (such as FORTRAN). They allow program execution at a reasonable speed, while retaining the programming ease and logic of a higher-level language.

Two accessories are needed to use this music program: the RCA VP595 Sound Board and an ASCII- (American Standard Code for Information Interchange) encoded keyboard. Although RCA offers a full ASCII keyboard for the VIP, almost any will suffice once the strobe polarity is determined. See figure 1 for a keyboard-to-VIP wiring diagram.

The VP595

The VP595 is a single-channel, 256-note programmable tone generator with a built-in speaker, volume control, and an output jack. At \$30, it's a pretty good buy. Its 8-bit parallel port provides the division ratio necessary for playing back the required note. The tonal range is

ASCII KEYBOARD HOOK-UP
TO VIP INPUT PORT

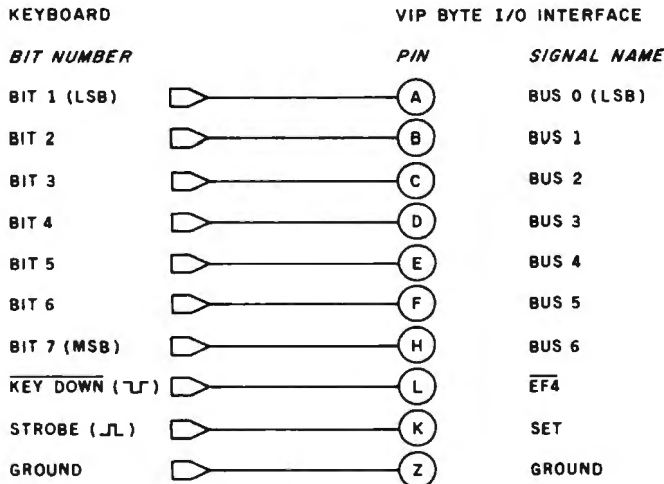

Figure 1: Connection diagram for adding an ASCII-encoded keyboard to the VIP computer. If keyboard data is valid for the duration of the Key Down signal, no Strobe signal is necessary. If the Key Down signal is not available from the keyboard, an inversion of the Strobe signal can be used.

from 110 Hz (A-natural in the second octave) to 6645 Hz (G-sharp in the eighth octave). However, the entire range can be shifted up or down by adjusting a trimmer resistor on the circuit board. These notes can be selected by feeding 1-byte instructions from the VIP's hexadecimal keyboard or, more conveniently, by letting the VIP interpret the ASCII output of a standard alphanumeric keyboard.

The Music Program

The music program:

- converts your ASCII keyboard into a piano-like keyboard that plays musical notes as appropriate keys are pressed.
- when used with a video monitor, displays the notes sequentially on a musical staff as it plays (to a maximum of 60 notes onscreen at one time).
- stores, plays back, and redisplay a composition of up to 60 notes, allowing full backspace erasure plus control of note length and pauses.
- translates notes into their alphanumeric equivalents and redisplay them in that form during playback.

As a practical compromise of keyboard accessibility and graphic resolution, two full octaves, including sharps, are used, but enough room is left in the program to extend that to three or four octaves.

The keyboard keys work like a piano (see table 1a). For example, the duration of each note played back is proportional to the length of time the note key is pressed. Additional keys are used for control and editing, as shown in table 1b.

1a

Key:	A	S	D	F	G	H	J	K	L	;	/	Q	W	E
Note:	C4	D4	E4	F4	G4	A4	B4	C5	D5	E5	F5	G5	A5	B5

1b

Key	Use
Backspace or Tab	Erases last note entry from the screen and from memory. It's possible to clear all notes except the first one by repeatedly pressing either key.
Return	Plays back the entered notes and redisplay them.
Spacebar	Blinks cursor and stores a rest (silent interval) in memory. As with notes, the length of time the space key is pressed will be duplicated upon playback.
1, 2, 3, 4, 5	Determine length of space between the played-back notes (default value is 2).
9	Clears the screen, plays back, and displays the alphanumeric equivalent of the first page (top staff). Pressing the key again erases the screen, plays back, and displays the second page (bottom staff).
0	Same as 9, but no note playback.

Table 1: Using the VIP keyboard. Table 1a shows which keys produce which notes. Sharps are produced by holding down the shift key as the note key is pressed. Table 1b gives a description of the functions of each command key.

Preparing the CHIP-8

CHIP-8 instructions have a simple, consistent format (see table 2). Each instruction is 2 bytes long (4 hexadecimal digits) and performs an assigned, individual function. In examining each of the CHIP-8's 31 instructions, the first letter or number is always fixed, while the next three can stand for memory address (*mmm*), hexadecimal variables (*x* or *y*), hexadecimal constants (*kk*), or special display data (*n*). For instance, jumping to memory location 200 is performed using the instruction *1mmm*, rewritten as 1200. In other instructions, assigning a value of 16 to the hexadecimal variable *A* is done by using the *6xkk* instruction, which would be rewritten as 6A0F.

A useful instruction is the *Dxyn*, which displays on the screen a pattern *n*-bits high according to the coordinate values of *x* and *y*. As an example, a DAB1 instruction would display a single bit at screen coordinates *x* = value of variable *A*, and *y* = variable *B*. By continually changing variables' values, bits and whole patterns can be made to move quickly across the display screen.

Instruction	Operation
1mmm	Go to 0mmm (memory address mmm)
Bmmm	Go to 0mmm + VO (memory address incremented)
2mmm	Do subroutine at 0mmm (must end with 00EE)
00EE	Return from subroutine
3Xkk	Skip next instruction if VX = kk
4Xkk	Skip next instruction if VX ≠ kk
5XY0	Skip next instruction if VX = VY
9XY0	Skip next instruction if VX ≠ VY
EX9E	Skip next instruction if VX = Hexadecimal key (least significant digit)
EXA1	Skip next instruction if VX ≠ Hexadecimal key (least significant digit)
6Xkk	Let VX = kk
CXkk	Let VX = Random Byte (kk = Mask)
7Xkk	Let VX = VX + kk
8XY0	Let VX = VY
8XY1	Let VX = VX/VY (VF changed)
8XY2	Let VX = VX and VY (VF changed)
8XY4	Let VX = VX + VY (VF = 00 if VX + VY ≤ FF, VF = 01 if VX + VY > FF)
8XY5	Let VX = VX - VY (VF = 00 if VX < VY, VF = 01 if VX ≥ VY)
FX07	Let VX = current timer value
FX0A	Let VX = hexadecimal key digit (waits for any key pressed)
FX15	Set timer = VX (01 = 1/60 second)
FX18	Set tone duration = VX (01 = 1/60 second)
Ammm	Let I = 0mmm (memory pointer for current data)
FX1E	Let I = I + VX (memory pointer increment)
FX29	Let I = 5-byte display pattern for the least significant digit of VX
FX33	Let MI = 3-decimal digit equivalent of VX (I unchanged)
FX55	Let MI = VO : VX (I = I + X + 1)
FX65	Let VO : VX = MI (I = I + X + 1)
00E0	Erase display (all 0s)
DXYn	Show n-byte MI pattern at VX-VY coordinates. I unchanged. MI pattern is combined with existing display via Exclusive-OR function. VF = 01 if a 1 in MI pattern matches 1 in existing display.
0mmm	Do machine-language subroutine at 0mmm (subroutine must end with D4 byte)

Table 2: CHIP-8 instructions. In this table, x and y are variables, kk represents a hexadecimal constant, mmm is a hexadecimal address in memory, and n is a hexadecimal height pattern indicator.

While the original CHIP-8 interpreter was written primarily for graphic displays and games, new instructions can be added and the interpreter may be modified to suit a given application. Such was the case here, because the standard CHIP-8 lacks an input-port status instruction and an output-port command. Changing the following codes in the CHIP-8 creates the necessary additional instructions, called Fx00 and FxF9:

CHIP-8 Memory Location	New Instruction
0100	3F D4
0102	E6
0103	6B
0104	D4
01F9	E6
01FA	63
01FB	D4

Fx00—reads into VX the value at the input port when a key is pressed; otherwise, VX = 0.

FxF9—sends the value of VX to the output port and the sound board.

Program Details

The hexadecimal listing (listing 1) is divided into separate blocks, with unused memory space in between. When entering the code, it's important to readdress the memory location before starting each new block. (See figure 2 for a simple flowchart.)

In its simplified form, the program works as follows: when a key is pressed, it is identified (e.g., by an FC00 instruction) and sent (perhaps by a 1306 instruction) to the tone-and-note display table where it is assigned a divisor, 5D (by a 6C5D), that represents the appropriate note, in this case note D in the fourth octave. It is also assigned (by 6E0E) position 0E on the staff and sent to memory location 0400. Here a check is performed to see if the variable C (VC) is a value 0 (pause). If not, the instruction FCF9 plays the note, and variable 0 (note length increment) is advanced. Memory entrance flag V8 is set to 0. Instruction 14C0 points to the display routine. Memory location 4401 then checks the V4 display flag—if V4 = 0 (initial). After selecting the correct upper staff, the instruction D2E1 displays the correct note, which is located at A65A—memory location 065A. Display flag V4 is set to 1, and the program returns to scan the keyboard. If the key is still pressed, the sequence repeats, but the display is omitted, because V4 = 1 and the note is already on the staff. As soon as the key is released, VC becomes 0, and the four variables dump their contents into memory with the F355 instruction:

- V0 : note length
- VC becomes V1 : tone (division ratio)
- V2 : note horizontal position on staff
- VE becomes V3 : note vertical position on staff

Listing 1: The hexadecimal codes for the composing program.

Memory Location	STAFF DRAWING			
0200	6202	A21E	6B00	6C04
0208	DBCA	7B08	4B40	1212
0210	1208	6C14	DBCA	7B08
0218	4B80	1228	1214	FF00
0220	FF00	FF00	FF00	FF00
	KEYBOARD SCAN			
0228	3201	6900	6B04	6A00
0230	FC00	4C61	1300	4C73
0238	1306	4C64	130C	4C66
0240	1312	4C67	1318	4C68
0248	131E	4C6A	1324	4C6B
0250	132A	4C6C	1330	4C3B
0258	1336	4C5C	133C	4C71
0260	1342	4C77	1348	4C65
0268	134E	126C	4C41	1354
0270	4C53	135A	4C46	1360
0278	4C47	1366	4C48	136C
0280	4C4B	1372	4C4C	1378
0288	4C7C	137E	4C51	1384
0290	4C57	138A	1296	4C20
0298	1390	4C08	147C	4C09
02A0	139A	4C0D	141E	4C30
02A8	139A	4C31	6B02	4C32
02B0	6B04	4C33	6B08	4C34
02B8	6B0B	4C35	6B0F	4C39
02C0	1396	4C38	139A	6400
02C8	6500	6C00	1400	1230
	NOTE - TONE AND DISPLAY ASSIGNMENTS			
0300	6C68	6E0E	1400	C4
0306	6C5D	6E0D	1400	D4
030C	6C53	6E0C	1400	E4
0312	6C4E	6E0B	1400	F4
0318	6C45	6E0A	1400	G4
031E	6C3E	6E09	1400	A4
0324	6C37	6E08	1400	B4
032A	6C34	6E07	1400	C5
0330	6C2E	6E06	1400	D5
0336	6C29	6E05	1400	E5
033C	6C26	6E04	1400	F5
0342	6C22	6E03	1400	G5
0348	6C1E	6E02	1400	A5
034E	6C1B	6E01	1400	B5
0354	6C62	6E0E	1400	C4#
035A	6C58	6E0D	1400	D4#
0360	6C49	6E0B	1400	F4#
0366	6C41	6E0A	1400	G4#
036C	6C3A	6E09	1400	A4#
0372	6C31	6E07	1400	C5#
0378	6C2B	6E06	1400	D5#
037E	6C24	6E04	1400	F5#
0384	6C20	6E03	1400	G5#
038A	6C1D	6E02	1400	A5#
0390	6C01	6E00	1400	Space

0396	6E02	3E02	6E03
039C	6A00	A65F	6D00
03A2	6700	6600	00E0
03A8	F365	1500	A6D7
03AE	6A78	13A0	

MEMORY WRITE & NOTE PLAY

0400	4C00	1414	4C01	140C
0408	FCF9	FB18	7001	81C0
0410	6800	14C0	4800	F355
0418	6801	6000	1230	

MEMORY READ

041E				A65F
0420	6A00	F365	4F05	80B0
0428	A65A	4101	D231	D231
0430	A65F	7A04	FA1E	7504
0438	4100	1444	4101	1444
0440	F1F9	F018	F015	F707
0448	3700	1446	FB15	F707
0450	3700	144E	5590	145C
0458	6500	1230	FC00	4C0A
0460	1230	1422		

BACKSPACE

047C			4204	1230
0480	3900	1486	1230	3500
0488	1230	A65A	4101	D231
0490	D231	6502	8255	6504
0498	A65F	8955	F91E	F355
04A0	A65B	F91E	F365	1230

DISPLAY NOTES

04C0	4401	1230	663E	8265
04C8	8DF0	4F00	14DA	A65A
04D0	7E10	8264	427A	1482
04D8	14DE	8264	A65A	7202
04E0	4101	D2E1	D2E1	6401
04E8	7904	A65B	F91E	83E0
04F0	1230			

ALPHANUMERIC MAP POINTERS

0500	4168	A600	4162	1566
0508	415D	A605	4158	156A
0510	4153	A60A	414E	A61E
0518	4149	156E	4145	A60F
0520	4141	1572	413E	A619
0528	413A	1576	4137	A614
0530	4134	A624	4131	157A
0538	412E	A628	412B	157E
0540	4129	A62C	4126	A63D
0548	4124	1582	4122	A630
0550	4120	1586	411E	A638
0558	411D	158A	411B	A634
0560	4101	A643	1590	A600

System Notes

0568	158E	A605	158E	A61E
0570	158E	A60F	158E	A619
0578	158E	A624	158E	A628
0580	158E	A63D	158E	A630
0588	158E	A638	158E	6402

ALPHANUMERIC PRINT & PLAY

0590	9590	15C0	7504	D675
0598	4402	A642	4402	D671
05A0	6400	4E02	25CE	760B
05A8	4642	15B8	15EC	15C0
05B0	A65F	7A04	FA1E	13A8
05B8	7706	6600	7D01	15AC
05C0	FC00	4C0D	15C8	15C0
05C8	00E0	6201	1202	4100
05D0	15DA	4101	15DA	F1F9
05D8	F018	F015	F007	3000
05E0	15DC	FB15	F007	3000
05E8	15E4	00EE	3D05	15B0
05F0	FC00	6E02	4C39	13AC
05F8	6E03	4C30	13AC	15F0

ALPHANUMERIC MAP

0600	F585	8781	F1F5	5557
0608	51F1	F585	E781	F1F5
0610	85B7	91F1	F555	7751
0618	F1F5	95F7	9191	F585
0620	E781	8100	F784	8781
0628	F754	5751	F784	E781
0630	F784	B791	F754	7751
0638	F794	F791	97F7	84E7
0640	8187	0100	00FF	0000

NOTE SHAPE

065A	8000
065F	Program dumps variables starting here

On each entry, the memory is incremented to allow sequential storage of the four variables. This provides an easy solution to the backspace function, which simply re-displays the note and decrements the memory. When Return is pressed, the note data-memory locations are scanned with F365, erased, tested for pause length, and replayed through a set of timing instructions at F018 and F015, which reconstruct the note and pause lengths.

Pressing the 0 or 9 key sends the program into a separate section at memory location 0500, where each variable is identified by a 41xx instruction and directed to an alphanumeric map assignment table. Again, repetition was sacrificed for program speed. All necessary playback and display instructions start at location hexadecimal 0590.

Playing Your Music

Pressing any of the keys shown in table 1a will produce

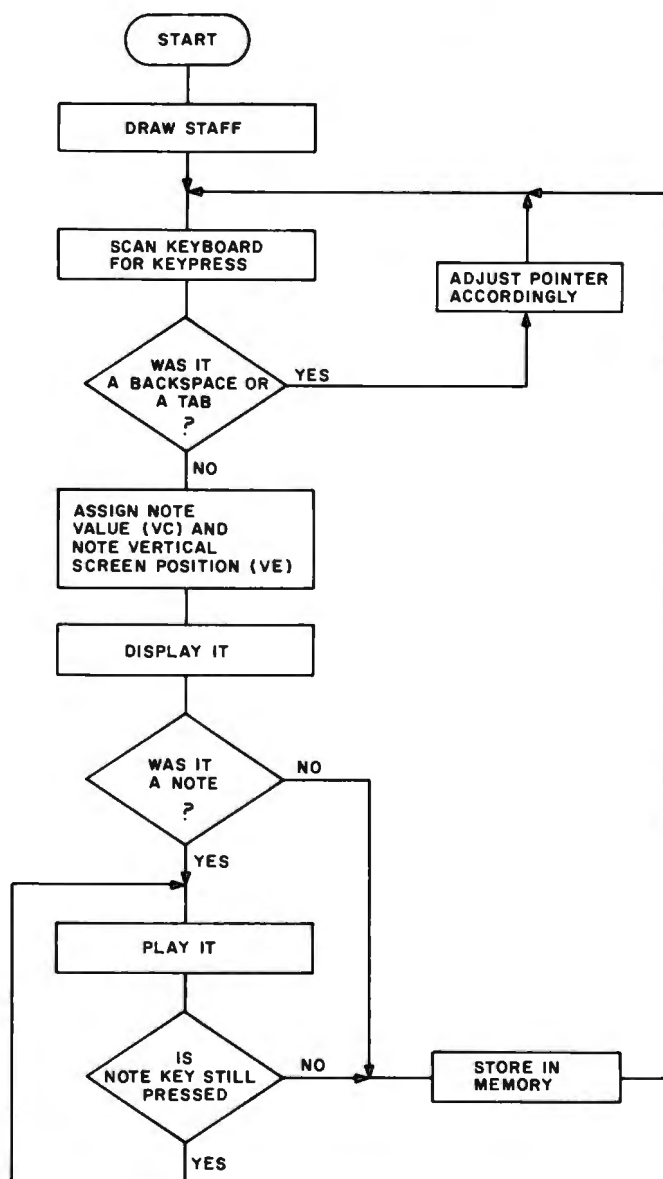
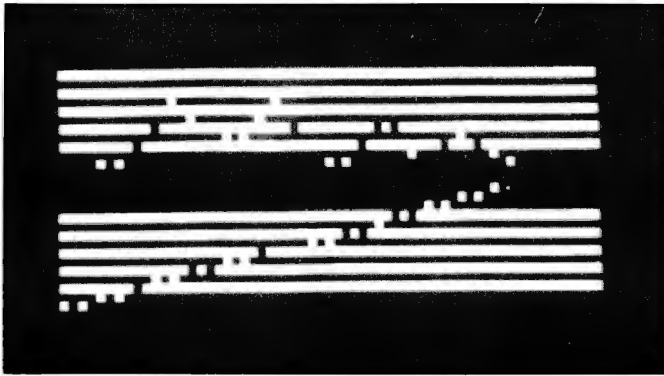

Figure 2: Flowchart of the program detailing the operations performed by the VIP during note-entry mode.

a corresponding note and display it in the correct position on the staff. Subsequent entries will automatically advance the horizontal position of the note on the screen.

If the wrong note is entered, pressing the Tab or Backspace key will erase the last notes and allow entry of new ones. All but the first note—usually a key marker—can be erased with either Tab or Backspace. Both keys work in the same manner, but since they are on the opposite side of the keyboard, one may be easier to use than the other.

Pressing the Return key will play all the notes from the start and re-display them (see photo 1). Because of the way the CHIP-8's display statement works, the notes are erased as they play back. Pressing the Return key again will simultaneously replay the notes and bring them back



1a

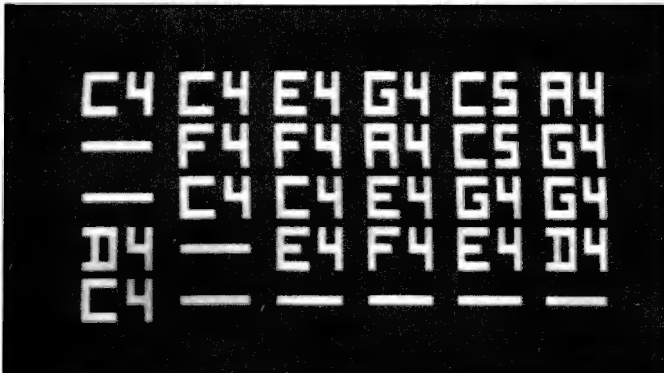

1b

Photo 1: Video display of the musical composition. Photo 1a shows the composition as it would appear on a musical staff. (The upper staff is "Home on the Range," while the lower staff is simply the scale of notes provided by the machine.) Photo 1b shows the alphanumeric version of the upper staff from photo 1a.

on the screen. As you add to your "composition," the Return command will always play it back from the beginning.

Pressing the number keys (1 to 5) before pressing Return will change the length of the playback by altering the length of spaces between the notes. Key 1 will select a very short duration, key 2 a longer one, and so forth.

The first note can be erased only by flipping the Reset switch. The sharp keys are activated by pressing the Shift key as in table 1a. For instance, pressing A alone will produce note C in the fourth octave, but pressing Shift and A will produce C sharp.

Because of the VIP's limited graphics resolution, it is not possible to indicate sharps on the staff; however, in the alphanumeric listing, the sharps are indicated by a chopped-off section of the octave number.

After 60 entries—when both staves are full—the program disregards new entries. It can, however, be reset with the VIP's Reset switch, which clears the memory and resets all variables. The VIP is then ready for a new tune.

Expansion Possibilities

The unused memory between the programming blocks

can provide for program expansion or custom changes. For example, a greater range of notes can be obtained by adding more keys for the scan routine and new note and display instructions.

A *2mmm* subroutine command could replace 1296 at hexadecimal location 0294 and point to free memory space (e.g., at hexadecimal 0700, where new keyboard-scan instructions could be added).

To add notes, two instructions per new note are necessary:

4Cxx, skip next instruction if VC ≠ XX (*xx* is the ASCII value of the new key)

1mmm, go to *mmm* (*mmm* is the hexadecimal memory address where the note and staff position values are stored)

An alternate way to put in additional note instructions would be to enter them at memory location 0294 and push down everything between 0296 and 02CF.

New note and staff values should then be entered at hexadecimal 0390. Three instructions are required for each new note:

6Cxx, VC = *xx* (new note division ratio in hexadecimal, as given in the VP595 board manual)

6Exx, VE = *xx* (note position on the staff in hexadecimal, 01 to 0E)

1400, go to memory location hexadecimal 0400 (write and play)

Once again, previous instructions located at 0390 should be reentered below the new ones, and pointers at old memory locations hexadecimal 05B6, 05F6, and 05FC have to be modified accordingly.

The keyboard scan and assignment subroutine is fast and the best compromise in program effectiveness and key response, even though it seems quite lengthy to enter and sometimes repetitious. Entered correctly, the program does not crash, even if invalid keys are typed. It gives hours of worthwhile fun and may even uncover some hidden talents.

Of Interest

A couple of years ago, Abacus Software released a new interpreter language for the PET/CBM called Vigil. It is patterned on the CHIP-8 but has extended capabilities and more than 60 instructions. Like the CHIP-8, it makes fast graphics and audio tones possible, is easy to program, and occupies little memory space. ■

References

1. John Chmielewski. "CHIP-8 III," *Viper*, volume 2, issue 7, February 1980.
2. H. Kleinberg. "Programming in CHIP-8," publication number PE-721. Somerville, NJ: RCA Solid State Division, 1978.
3. *RCA COSMAC VIP Instruction Manual #VIP-300-1*. Somerville, NJ: RCA Solid State Division.

Double Your TRS-80's Graphics Resolution

George Haddad
3230 South Gessner, #1009
Houston, TX 77063

With a resolution of 128 by 48 picture elements (pixels), the graphics capability of the Radio Shack TRS-80 is inadequate for many applications. In addition, since the aspect ratio (ratio of width to height) of a pixel is 0.5 or less, horizontal lines appear twice as broad as vertical lines. This results in low-quality graphics plots.

These out-of-shape rectangular elements can be made square by doubling the vertical resolution to 96 pixels. The increased resolution makes presentation of graphs more acceptable (see photo 1). The modification described in this article, which

is intended for Model I Level II TRS-80s, accomplishes this and, in addition, displays the hidden lower-case character set of the TRS-80 on the video monitor.

System Configuration

The TRS-80 uses seven 2102 static-memory integrated circuits (ICs) to hold the video information. This amounts to 1024 memory locations by 7 bits wide, or 16 lines by 64 characters per line in the alphanumeric mode. In the graphics mode, a character position is subdivided into 6

pixels as shown in figure 1. Depending on the mode selected by bit 7, the remaining bits will either address the character-generator ROM (read-only memory) for a limited number of the 128 ASCII (American Standard Code for Information Interchange) characters and symbols actually available, or act as on-off controls for the 6 graphics elements.

Because resolution is a function of video-memory size, doubling the memory raises some questions about new address allocation, software compatibility, performance, mounting space, and the ability of the

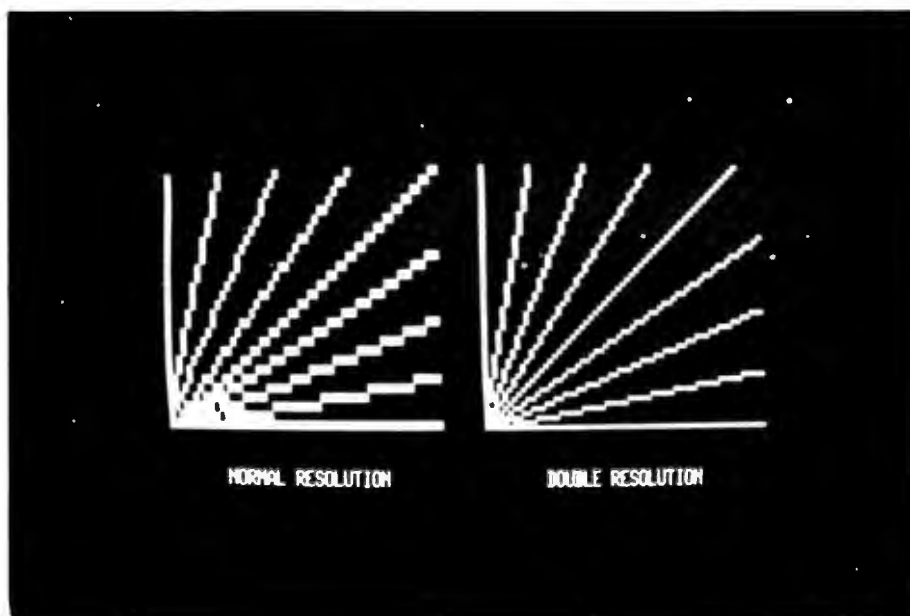

Photo 1: The result of running the BASIC program shown in listing 1. This photo shows the improvement in graphics capability that can be expected after making the hardware modification described in this article.

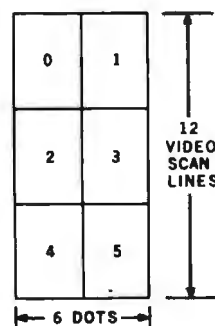

Figure 1: TRS-80 graphics character. On the TRS-80, a graphics character is divided into 6 rectangular picture elements called pixels. Each pixel is controlled by bits 0 through 5 of the character's ASCII code representation. Bit 6 is not stored. Bit 7 is used to select either alphanumerics or graphics.

power supply to handle the increased load. All of these problems have been resolved in this modification.

Interlacing Is the Key

This modification requires replacing the video-memory ICs with four higher-density (1K by 4-bit) ICs and adding the necessary control logic. Refer to the *TRS-80 Technical Reference Handbook* for circuit theory and schematics. In the modified configuration, the memory chips are wired as dual 1K by 8-bit blocks. Both memory blocks are addressed by the original 10 address lines and

are simultaneously mapped with the same hexadecimal memory locations 3C00 through 3FFF. Controlled multiplexing of the two video-memory pages makes this memory-map-sharing technique possible. It also simplifies adaptation of the resident software and keeps hardware changes minimal. Figure 2 illustrates the method used.

Enabling of either one or both memory sections is done under output port control (see figures 3 and 4). When the computer is powered up or reset, the normal low-resolution operation occurs, enabling one memory

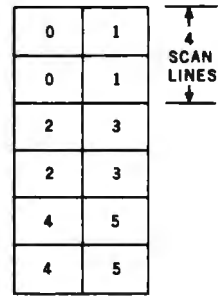

Figure 2: New format of interlaced graphics cells, formed after the hardware modification by accessing the first video-memory block during the upper two video-scan lines of a pixel. The second block of memory, which shares the same address, takes over for the two remaining lines.

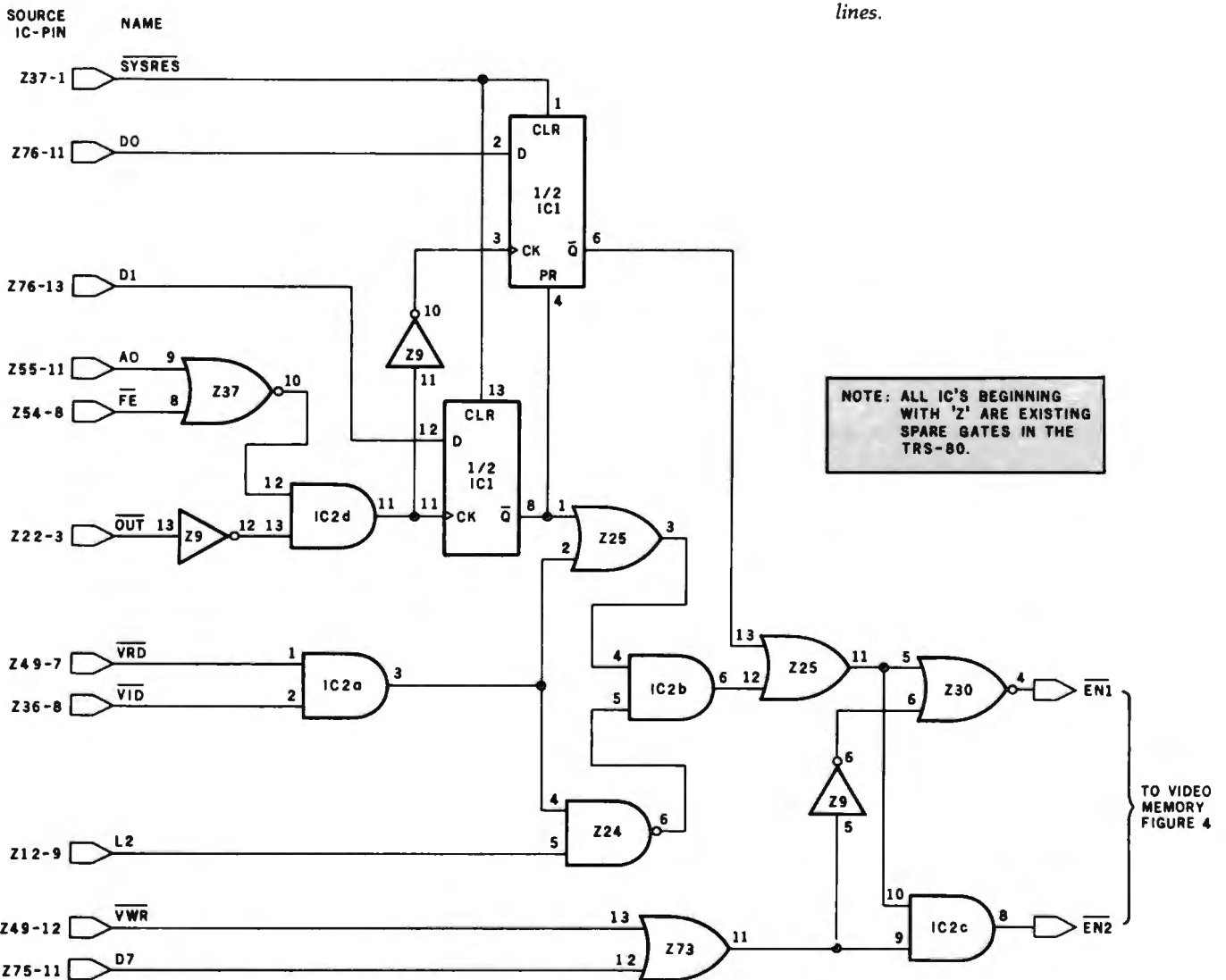

Figure 3: The modified TRS-80 video-control circuit. IC1 is a 74LS74; IC2 is a 74LS08. All other elements shown are spare gates on the TRS-80 video board.

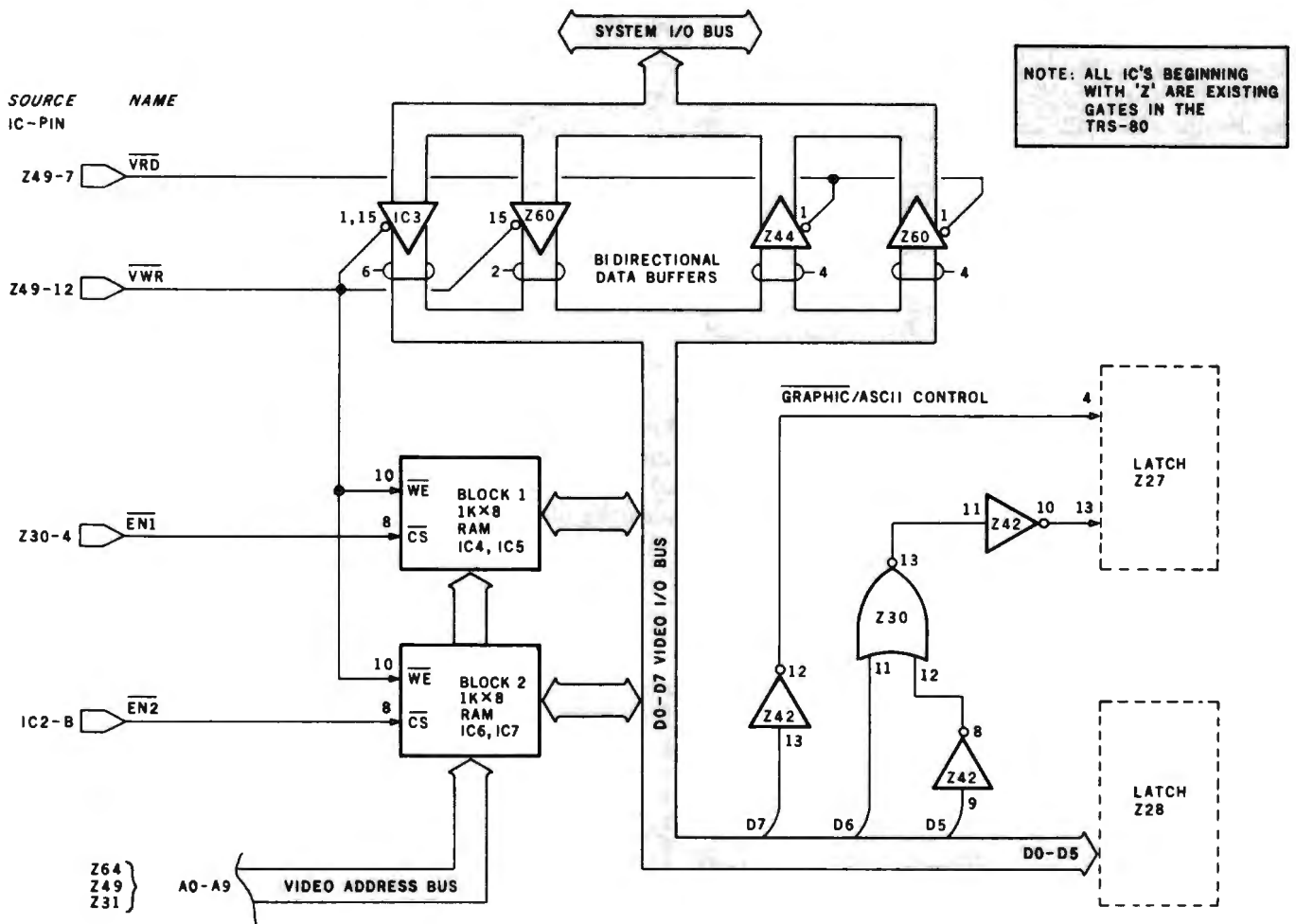

Figure 4: The TRS-80 video memory and interface.

block. Sending the value 1 to port 254 latches the system in the double-resolution mode and makes video-memory block 1 active for graphics handling. Sending the value 2 to the same port latches the system in the double-resolution mode and enables video-memory block 2 for graphics handling. The TRS-80 is returned to normal resolution by sending the value 0 to port 254. Only during processor-controlled data transfer in the graphics mode will one block of memory or the other be enabled. Note that when ASCII characters are involved, both sections become active in the alphanumeric mode for parallel data storage to preserve the integrity of the characters in mixed-mode operation. During the time when the screen-refresh counters take hold of the video-memory address, the logic governing the operation merges the two mem-

ory sections in an alternating fashion transparent to the video display. The upper half of each pixel, consisting of every two video-scan lines, is covered by the first memory block. The second memory block is devoted to the bottom half of each pixel.

Modifying the Board

This modification requires the removal of several ICs from the keyboard logic board, cutting traces, drilling holes, and rewiring. If you're using the spare gates available on the board, the unused inputs of these gates must be ungrounded. In some production runs the existing ground is on the component side of the board under the ICs. If you use this method, you'll need three devices (74LS74, 74LS08, and 74LS367) as well as four 2114L programmable-memory chips. All of these components will fit in the

area from which the seven 2102 programmable-memory chips were removed.

Since the 2114s are 18-pin devices, you'll need to drill two extra holes per chip to accommodate them. And when cutting traces, make absolutely sure you reroute interrupted runs. Good desoldering equipment and a great deal of patience are absolutely essential for a successful job. Also remember that opening the case voids the warranty on your TRS-80.

You may prefer an alternate modification method to avoid some of the board changes associated with the first approach. The circuit can be built on a small board, although you'll need more components. You can attach the board to the main printed-circuit board after removing the existing memory chips and making the necessary changes.

Listing 1: A BASIC program illustrating graphics programming procedure for the TRS-80 after making the hardware modification described in this article. The result of running this program is shown in photo 1.

```

5 ' SAMPLE PROGRAM FOR USE WITH MODIFIED TRS-80
10 CLS:PI=3.14:DX=1:DY=1:XMAX=57:YMAX=7
20 FOR I=0 TO PI/2 STEP PI/16
30 XO=1:YO=34
40 X=0:Y=0:SLOPE=TAN(I)
50 IF SLOPE>1.6 THEN 200
60 Y=SLOPE*X/2
70 XP=X+XO:YP=-FIX(Y)+YO
80 IF XP>XMAX THEN 400 ELSE IF YP<YMAX THEN 400
90 OUT254,1:SET(XP,YP):OUT254,2:SET(XP,YP)
100 X=X+DX:GOTO 60
200 X=2*Y/SLOPE:YP=-Y+YO:XP=X+XO
210 IF XP>XMAX THEN 400 ELSE IF YP<YMAX THEN 400
220 OUT254,1:SET(XP,YP):OUT254,2:SET(XP,YP)
230 Y=Y+DY:GOTO 200
400 XO=67:YO=68
410 IF SLOPE<.99 THEN J=1 ELSE IF SLOPE>1 THEN J=3 ELSE J=2
420 XR=0:YR=0:X=XR+XO:Y=-YR+YO
430 IF X>127 THEN 700 ELSE IF Y<13 THEN 700
440 N=2*INT((Y+1)/2)
450 IF N=Y THEN YP=Y/2:OUT254,2:ELSE YP=(Y+1)/2:OUT254,1
460 SET(X,YP)
470 ON J GOTO 600,600,500
500 Y=Y-DY:YR=YR-DY
510 XR=-YR/SLOPE:X=XR+XO:GOTO 430
600 X=X+DX:XR=XR+DX
610 IF J=2 THEN YR=XR:Y=-YR+YO:GOTO 430
620 YR=SLOPE*XR:Y=-FIX(YR)+YO:GOTO 430
700 NEXT I:PRINT @ 838,"NORMAL RESOLUTION"
710 PRINT @ 872,"DOUBLE RESOLUTION"
720 GOTO 720

```

Whichever modification method you use, the pixels can be made perfectly square by adjusting the vertical-height trim potentiometer in the video monitor.

Lowercase Display

While the TRS-80 can output upper- and lowercase alphanumeric characters to a printer, the display does not discriminate between the two. Without this feature, editing lowercase text is difficult and programming errors can occur. These errors may go undetected or be hard to debug. One example occurs when a variable name at one place in the program is inadvertently entered with the shift key pressed. The name will appear on the video display as the same uppercase name assigned somewhere else, yet it will be interpreted by the computer as a different variable name.

When lowercase alphanumeric codes are written into the video mem-

ory, the sixth bit in the ASCII code is forced low by the resident program. The complement of this bit forms the seventh bit, or most significant bit (MSB), which cannot be stored due to insufficient video byte width. After modification, the extra bit gained by using full-byte video memory provides the necessary room for the MSB and solves part of the problem. To display lowercase letters, either replace the resident program with a corrected version or use an assembly-language program that outputs the correct code to the video screen. When the sixth bit is correct, the steering logic in the modification allows the new bit to be used for the MSB. Otherwise, normal operation is maintained. For a quick check, run the following program:

```

10 FOR I = 64 TO 127:
   POKE 15680 + I, I :
NEXT

```

Both uppercase and lowercase alphabets should be displayed.

Graphics Programming Methods

The comparison program used for generating the two sets of lines in photo 1 is shown in listing 1. Each set is a family of straight lines passing through the origin of its established coordinate axes and bounded by specified upper and right-hand boundaries. In each set, the slope is incremented from 0 to 90 degrees at 11.25-degree increments. The mathematical solution is straightforward, but a few steps deserve clarification.

The ordinate variable in the equation for the normal-resolution set of lines is scaled by a factor of 2 to compensate for the 1-to-2 aspect ratio and produce the correct slope.

A slope greater than 1 means that the rate of change in the y -direction is greater than the rate of change in the x -direction and a line with fewer points spaced apart will result. This condition is circumvented in the program by incrementing y as the independent variable and solving for x in terms of y , thereby maintaining line continuity.

Although normal resolution calls for latching the computer in the normal mode, lines of the normal-resolution set were simulated by plotting them in the double-resolution mode in both memory blocks at lines 90 and 220.

The routine for the double-resolution lines starts at line 400. One major difference is that while an ordinate scale of 0 to 95 may be used in the equation, the scale must be broken down to two 0-to-47 scales with odd-even identity.

The ordinate value is reduced to an integer number and the number is examined and converted to its correct identity scale at lines 440 and 450. To store the graphic point in video memory, block 1 is enabled for odd ordinate numbers; block 2 for even numbers.

The same method may be applied for other graphic statements such as RESET and POINT. ■

Idiot-Proof Input in Pascal

Grady Booch
4314 Driftwood Dr.
Colorado Springs, CO 80907

Much of the power and elegance of Pascal programming is derived from the programmer's capacity to define data types. Treating data abstractly allows the program to reflect the problem that it is modeling. Unfortunately, Pascal offers no execution-time error recovery, so any invalid user input that is entered causes annoying problems.

The user interface is Pascal's weak link, and the lengthy code necessary to check for input errors shows it. Furthermore, in programs where several user responses may be valid, it would be nice to be able to use Pascal's CASE statement to select the proper course of action.

Since CASE requires a nonreal scalar index, the user must convert the input from a character string to an enumeration-type variable. Thus, editing of input errors becomes possible. Listing 1 demonstrates a method for obtaining "idiot-proof" input in Pascal. Note that an enumeration-type is used to define all valid input commands.

The major loop of the input routine continues until a valid input is found. A simple search of the array TRANSFORM uses the SUCC procedure. Since this code includes a type transformation, a CASE statement can be used to select the proper action. ■

Listing 1: This program demonstrates a method for obtaining idiot-proof input in Pascal.

```
program star_trek(input,output);

{This program illustrates the use of idiot-proof input in Pascal}

type
    token                = packed array[1..10] of char;
    valid_input          = (warp,impulse,photon,error);
var
    index                : valid_input;
    good_response        : boolean;
    transform             : array[warp..error] of token;

begin
    {Initialize the transformation array}
    transform[warp]      := 'WARP      ';
    transform[impulse] := 'IMPULSE  ';
    transform[photon]   := 'PHOTON   ';

    {Other program code goes here}

    {Start the idiot-proof input}
    good_response:= false;
    {Loop until a valid input is given}
    while not good_response do
```

Listing 1 continued:

```

begin
  write('ENTER DESIRED COMMAND: ');
  {Get a response from the user}
  readln(transform[error]);
  writeln(transform[error]);
  {Initialize the pointer to the transformation array}
  index:= warp;
  {Search the transformation array for a match}
  while transform[index] <> transform[error] do
    index:= succ(index);
  {Check for an invalid response}
  if index = error then
    writeln('INVALID RESPUNSE...TRY AGAIN')
  else
    good_response:= true;
end;

{The input has been converted to an enumeration type. Other program
code goes here, for example;}

case index of
  warp      : writeln('WARP FUNCTION');      {Program code for each }
  impulse   : writeln('IMPULSE FUNCTION');  {function goes here,   }
  photon    : writeln('PHUION FUNCTION');    {.....}
end;

{Other program code goes here}

end.

ENTER DESIRED COMMAND: PHASEK
INVALID RESPONSE...TRY AGAIN
ENTER DESIRED COMMAND: PHUTUN
PHOION FUNCIUN

```

<p>PRINTERS Epson</p> <p>EPSON MX-80.....425 EPSON MX-80FT535 EPSON MX-100.....695 EPSON INTERFACE & CABLE89 NEC 8023 FRICTION/TRACTOR.....499 NEC 3530 SPINWRITER1950 THE GRAPPLER INTERFACE129 OKIDATA MICROLINE 82A575 OKIDATA MICROLINE 83A795 C.I.TOH STARWRITER F10-40PU ..1550 C.I.TOH PROWRITER 8510 AP499</p> <p>MONITORS</p> <p>AMDEX LOW-RES 13" COLOR I365 AMDEX HI-RES 13" COLOR II.....850 SANYO 9" B&W185 ZENITH 12" GREEN (ZVM-121).....129 NEC 12" GREEN (JB-1201)169 NEC 12" RGB COLOR (JC-1202DH) .875 ELECTROHOME 13" RGB HI-RES825</p> <p>DISKETTES</p> <p>BASF 5 1/4" SS/DD/HUB RING (10) ...23 BASF 6" DISKETTES (10)24</p>	<p>IBM PERSONAL COMPUTER CALL FOR PRICE & AVAILABILITY</p> <p>NEC PC-8000</p> <p>PC-8001A 32K W/24K ROM 5 FUNC. KEYS735 PC-8012A I/O & EXPANSION SLOTS W/32K475 PC-8031A DUAL DRIVES735 BENCHMARK WORD PROCESSOR 379 WORDSTAR299</p> <p>Apple II SOFTWARE & ACCESSORIES</p> <p>VISICALC189 VISIREND/VISIPLOT210 VISIFILE199 BPI BUSINESS SOFTWARE335 WORDSTAR299 HAYES MICROMODEM II299 NOVATION CAT II349 MICROSOFT Z-80 SOFTCARD299 VIDEX 80 COLUMN CARD269</p>	<p>TeleVideo</p> <p>802 (SCREEN, 1 Mb DUAL DRIVES) 2750 802H (SCREEN, 0.5Mb SINGLE DRIVE, 10 Mb HD)5050 912 TERMINAL695 920 TERMINAL725 925 TERMINAL730 950 TERMINAL925</p> <p>ALLOS</p> <p>5-15D (3 USERS, 2Mb DUAL DRIVES)2500 5-5D (3 USERS, 1Mb DRIVE, 5Mb HD)5050</p> <p>XEROX 820 "SAM"</p> <p>SYSTEM I (5 1/4" DRIVES)2350 SYSTEM II (8" DRIVES)2895 XEROX 830 PRINTER2350 WORD PROCESSING (WORD STAR)425 SUPERCALC250 CP/M OPERATING SYSTEM175</p>	<p>OSBORNE COMPUTER CALL FOR PRICE & AVAILABILITY</p> <p>ATARI 800 & 400</p> <p>ATARI 800 (16K)675 ATARI 400 (16K)335 410 PROGRAM RECORDER85 810 DISK DRIVE499 16K RAM MEMORY MODULE89 850 INTERFACE MODULE165 830 ACOUSTIC MODEM159 ATARI VISICALC199 ATARI WORD PROCESSOR125 BASIC LANGUAGE45 ASSEMBLER EDITOR45 MISSILE COMMAND35 DATA SOFT TEXT WIZARD79</p> <p>Commodore</p> <p>VIC 20 COMPUTER249 3K RAM CARTRIDGE34 8K RAM CARTRIDGE50 DISK DRIVE499</p>
<p>(800) 854-1941 computer age (714) 585-7092 Outside Ca. Order Desk Technical & California SERVING YOU SINCE 1979 4688 CONVOY STREET, SAN DIEGO, CA 92111 CALL OR WRITE FOR COMPLETE PRICE LIST RISK FREE MAIL ORDER</p>		<p>TO ORDER: Please send cashier's check or personal check (allow 10 business days to clear). VISA and Master Card credit card service add 3%. Shipping, handling and insurance in U.S. add 3%. Minimum \$3.00. California residents add 6% sales tax. Foreign orders add 10% for shipping. Equipment is subject to price change and availability. All equipment carries warranty. Store prices may differ from mail order prices.</p>	

What's New?

SYSTEMS

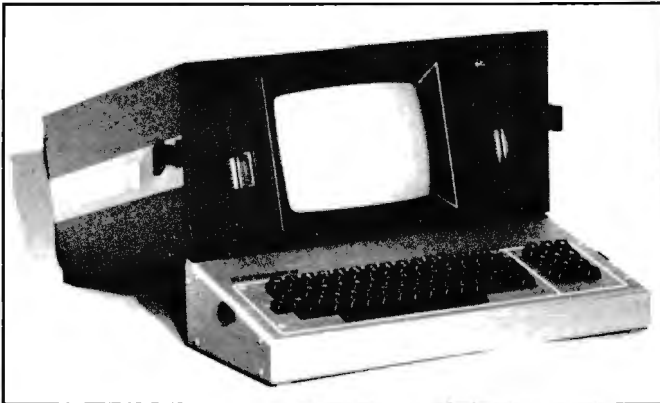

CP/M-Compatible Portable Computer

The Kaycomp II is a CP/M-compatible portable computer. The Z80A-based Kaycomp has 64K bytes of memory and a 9-inch display screen with a 24-line by 80-column format. Other standard features include dual 5¼-inch floppy-disk drives, an RS-232C interface, and a snap-together, fan-cooled metal cabinet. Software supplied with the Kaycomp

II includes the CP/M operating system; and a word processor, and, from Microsoft, MBASIC, the Multiplan electronic spreadsheet, and the Mu/Math mathematics utility program.

The Kaycomp II costs \$1795. Contact Non-Linear Systems, POB N, Del Mar, CA 92014, (714) 755-1134.

Circle 500 on inquiry card.

Low-Cost Computers Have 64K-Byte Memory

Milwaukee Computers' MC-1000 series of 6502-based single-board computers features a 64K-byte memory, dual 5¼-inch disk drives, a real-time clock, two RS-232C interfaces, and a Centronics-type parallel printer port. Additionally, the MC-1000 is provided with extensive self-diagnostics in ROM (read-only memory).

A wide assortment of options are available for the MC-1000, including expanded disk capacities to 1.8 megabytes and UCSD Pascal, BASIC, and FORTRAN-77 compilers. In single units, the MC-1000 costs \$995. For complete details, contact Milwaukee Computers Inc., 16235 West Ryerson Rd., New Berlin, WI 53151, (414) 784-2312.

Circle 502 on inquiry card.

to execute 1 million instructions per second, the ability to support up to 16 megabytes of directly addressable memory, and resident-memory capacities of up to 4 megabytes within the enclosure.

Optional equipment for the System 83 includes single- and double-density and single- and double-sided 8-inch disk drives, 8-inch Winchester hard-disk drives, A/D and D/A (analog-to-digital and digital-to-analog) converters, and output-controller boards. Prices for the System 83 with Unix and floppy-disk drives start at \$8295. For details, contact Dual Systems Control Corp., 720 Channing Way, Berkeley, CA 94710, (415) 549-3854.

Circle 503 on inquiry card.

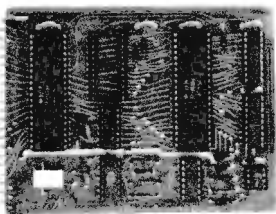

AIM-Compatible Computer Controller

The μ Cortex/65 is an AIM-65-compatible, single-board computer controller. The board has a 1K-byte RAM (random-access read/write memory), a socket for a 2K-byte 2716 EPROM (erasable programmable read-only memory), a crystal-controlled clock, a

6522 VIA (versatile interface adapter) with 16 I/O lines, four control lines, and two 16-bit timers. Other features include a 44-pin edge connector that's pinout-compatible with Rockwell International's AIM-65 application connector, a 555 clock startup and reset circuit, and VIA memory location compatibility with the AIM-65's application VIA.

The μ Cortex/65 costs \$79.95, plus shipping. For details, contact Cortex Research Corp., 1912 Raymond Dr., Northbrook, IL 60062, (312) 480-1088.

Circle 501 on inquiry card.

68000 Computer with Unix

Dual Systems Control Corporation's System 83 is a 68000-based computer running under Unix version 7. The System 83 has a dynamic 256K-byte RAM (random-access read/write memory) with parity and a 20-slot IEEE-696/S-100-compatible backplane. The Unix operating system is provided with such enhancements as C-shell, the Visual editor, a C language compiler, a 68000 assembler, and a linker/loader. Other features of the System 83 include the ability



Sage II

The Sage II is a 68000-based single-board computer recently introduced by Sage Computer Technology. The Sage II can be equipped to carry from 128K to 512K bytes of RAM (random-access read/write memory) and up to 1.3 megabytes of mass storage on two 5¼-inch floppy disks. Standard features include two RS-232C serial ports, a

What's New?

Centronics-compatible parallel port, and an IEEE-488 interface. The Sage II supports Pascal, BASIC, FORTRAN, and assembly language.

The Sage II ranges in price from \$3600 to \$6000, depending upon disk and RAM configurations. An optional interrupt-driven UCSD operating system costs \$400, and extra RAM is available for \$400 per 128K bytes. Contact Sage Computer Technology, Suite 14, 195 North Edison Way, Reno, NV 89502, (702) 322-6868.

Circle 504 on inquiry card.

Xenix-Compatible Single-Board Computer

The FT-68M/10 is a 10-MHz 68000-based Multibus-compatible single-board computer carrying 128K or 256K bytes of RAM (random-access read/write memory). Completely compatible with the Xenix operating system, the 6- by 12-inch 68M/10's RAM features error detection and memory management. Other standard features include two serial communications channels and a parallel input channel.

In single quantities, the 128K-byte FT-68M/10 costs \$3495, and the 256K-byte unit costs \$3995. For further details, contact Forward Technology Inc., 2595 Martin Ave., Santa Clara, CA 95050, (408) 988-2378. Circle 505 on inquiry card.



Desktop Computer Has Winchester Drives

Durango Systems' 900 series of fully integrated desktop business computers features a built-in Winchester disk drive that offers up to 15 megabytes of online storage. Standard features include a keyboard, a display screen, and a dot-matrix printer. Two models are available: the 900, which has a single-mode printer, and the 900XR, which has a dual-mode printer. The 900XR provides letter-quality printing on single sheets and envelopes at speeds of up to 200 characters per second. Additionally, the 900 series stores a variety of type styles in memory, and foreign-language characters and special fonts can be created or modified.

Options for the 900 series include an auxiliary fixed disk for an additional 7 or 14 megabytes of storage. Prices for 900 series systems range from \$11,950 to \$14,950, depending upon configura-

tions. For complete details, contact Durango Systems, 3003 North First St., San Jose, CA 95134, (408) 946-5000.

Circle 506 on inquiry card.

Foxy Computer

Digital Microsystems' Fox desktop computer can serve as a stand-alone unit or as a member of a HiNet local area network. The portable Z80A-based Fox features two 5¼-inch single- or double-density double-sided floppy-disk drives, a high-speed RS-422 network port, four RS-232C serial ports, two 8-bit bidirectional parallel ports, and a high-resolution 9-inch display screen with a 25-line by 80-character format. Running under the CP/M operating system, the Fox has 64K bytes of RAM (random-access read/write memory), 1K byte of ROM (read-only memory), and mass-storage capacities of 600K bytes per double-density double-sided disk for a total of 1.2 megabytes. Other

standard features include a detachable keyboard and 12 programmable function keys.

The Fox has a suggested retail price of \$3995. For details, contact Digital Microsystems, 1840 Embarcadero, Oakland, CA 94606, (415) 532-3686.

Circle 507 on inquiry card.

PUBLICATIONS

BASIC Scientific Subroutines

The second volume of Fred Ruckdeschel's extensive collection of BASIC-language subroutines is now available from BYTE Books/McGraw-Hill. BASIC Scientific Subroutines, volume 2, focuses on least-squares approximation, interpolation, differentiation, integration, the roots of functions, and optimization. Continuing the format of volume 1, this volume of BASIC Scientific Subroutines also provides complete program listings in Microsoft and North Star BASIC, and an appendix shows you how to convert the subroutines into other BASIC dialects. Additional topics covered in volume 2 are first-order, second-order, and nth-order least squares; tangent iteration; natural logarithm by recursion; trigonometric functions; LaGrange interpolation; calculating derivatives from tables; and successive substitution geometry.

BASIC Scientific Subroutines, volume 2, costs

What's New?

\$23.95 (volume 1 is still available for \$19.95). Contact BYTE Books, 70 Main St., Peterborough, NH 03458, (800) 258-5420; in New Hampshire and Canada, (603) 924-9281. Circle 508 on inquiry card.

Book Explores 8051

The 8051: Programming, Interfacing, and Applications is one of the first books to explore Intel Corporation's new 8051 single-chip microcomputer. The book has more than 80 experiments using the SDK-51 single-board microcomputer system as the hands-on vehicle for learning, prototyping, and experimenting with the 8051. Among the book's features are 8051 and SDK-51 reference materials, the mechanics of writing and executing assembly-language programs with the SDK-51, SDK-51 monitor subroutines, and 17 control applications.

The 8051: Programming, Interfacing, and Applications, by Dr. Howard Boyet and Ron Katz, costs \$19.95. It is available from Dr. Howard Boyet, 14 East 8th St., New York, NY 10003, (212) 473-4947.

Circle 509 on inquiry card.

Technical Journal for Amusement Industry

The Star Tech Journal is a technical monthly for distributors and operators of coin-operated electronic

amusement machines. Articles are geared toward technicians who are responsible for the service and maintenance of these specialized machines. Star Tech Journal identifies trouble areas to be watched and shows you the fix. Among the topics covered are modifying existing test equipment, theory of operation, circuit analysis, step-by-step system check through, and in-depth discussions on major manufacturers of pins, alleys, and video games.

Twelve issues of the The Star Tech Journal cost \$32 in the U.S., \$36 in Canada, and \$56 elsewhere. Contact the Star Tech Journal, POB 1065, Merchantville, NJ 08109, (609) 662-3432. Circle 510 on inquiry card.

Health Hazards of CRTs

Health Hazards of CRTs is an authoritative list of sources for balanced information on the possible health hazards associated with extended exposure to cathode-ray tubes. The book is an index of magazine articles, state laws, and scientific studies on the topic, as well as a directory of sources for additional information. Also provided is a list of major video-terminal manufacturers.

Health Hazards of CRTs is available for \$4.95 from Ryan Research International, 1593 Filbert Ave., Chico, CA 95926, (916) 343-2373.

Circle 511 on inquiry card.

Magazine Devoted to Computer Games

Computer Gaming World is a bimonthly publication for computer and video game enthusiasts. It's filled with game reviews, articles on the industry, and other features.

A year's subscription (6 issues) to Computer Gaming World costs \$11 in the U.S., \$15 in Canada, and \$19 elsewhere. For complete details, contact Computer Gaming World, Subscription Department, 1919 East Sycamore #203, Anaheim, CA 92805, (714) 776-4979.

Circle 512 on inquiry card.

List of Products for the Apple

A list of more than 100 Apple-related products is available for \$2. The list, updated monthly, includes books, directories, periodicals, posters, and data sheets and provides such information as company name, address, and product price. For your list, contact Bob Broedel, POB 20049, Tallahassee, FL 32304.

FORTH Reference Books

Two new FORTH reference books have been produced by Mountain View Press. All About FORTH, by Glen B. Haydon, is a glossary of FORTH words (definitions) as defined in several major implementations of FORTH: FORTH-79, the dialect used in Leo

Brodie's book Starting FORTH, and MVP-FORTH, a version developed by the Mountain View Press that's based on fig-FORTH (FORTH Interest Group) FORTH. Each entry includes the definition, implementation in FORTH, and usage of the word being defined.

Mitch Derick's and Linda Baker's The FORTH Encyclopedia is an advanced reference book that explains in words and flowcharts the compile- and run-time behavior of the fig-FORTH word set. In addition, all definitions are related to the word set of the FORTH-79 standard.

All About FORTH and The FORTH Encyclopedia are available postage paid for \$20 and \$25, respectively. Order your copies from Mountain View Press Inc., POB 4656, Mountain View, CA 94060.

Circle 513 on inquiry card.

PERIPHERALS

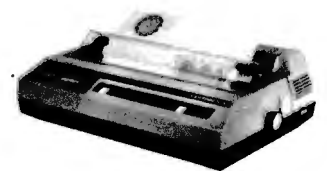

Graphics Dot-Matrix Printer

Centronics' Model 122 graphics dot-matrix printer is a heavy-duty 120-cps (character per second) desktop unit intended for data- and business-processing applications. Standard features include 120 cps bi-directional and logic-

STATIC RAMS

			Each	100 pcs
2101	256 x 4	(450ns)	1.95	1.85
5101	256 x 4	(cmos) (450ns)	4.95	3.95
2102-1	1024 x 1	(450ns)	.89	.85
2102L-2	1024 x 1	(LP) (250ns)	1.69	1.55
2102L-4	1024 x 1	(LP) (450ns)	1.29	1.15
2111	256 x 4	(450ns)	2.99	2.49
2112	256 x 4	(450ns)	2.99	2.79
2114	1024 x 4	(450ns)	8/16.95	1.95
2114L-2	1024 x 4	(LP) (200ns)	8/19.95	2.35
2114L-3	1024 x 4	(LP) (300ns)	8/18.95	2.25
2114L-4	1024 x 4	(LP) (450ns)	8/17.95	2.10
2147	4096 x 1	(55ns)	9.95	call
TMS4044-4	4096 x 1	(450ns)	3.49	3.25
TMS4044-3	4096 x 1	(300ns)	3.99	3.75
TMS40L44-2	4096 x 1	(LP) (200ns)	4.49	4.25
MK4116	1024 x 8	(250ns)	9.95	call
TMM2016	2048 x 8	(150ns)	call	call
HM6116-4	2048 x 6	(cmos) (200ns)	call	call
HM6116-3	2048 x 8	(cmos) (150ns)	call	call
HM6116-2	2048 x 8	(cmos) (120ns)	call	call
HM6116LP-4	2048 x 8	(LP) (cmos) (200ns)	call	call
HM6116LP-3	2048 x 8	(LP) (cmos) (150ns)	call	call
HM6116LP-2	2048 x 8	(LP) (cmos) (120ns)	call	call
Z-6132	4096 x 8	(Qstat) (300ns)	34.95	call

LP = Low Power Qstat = Quasi-Static

DYNAMIC RAMS

			Each	100 pcs
TMS4027	4096 x 1	(250ns)	2.50	2.00
MK4108	8192 x 1	(200ns)	1.95	call
MM5298	8192 x 1	(250ns)	1.85	call
4116-120	16384 x 1	(120ns)	8/29.95	call
4116-150	16384 x 1	(150ns)	8/18.95	1.95
4116-200	16384 x 1	(200ns)	8/13.95	call
4116-250	16384 x 1	(250ns)	8/13.90	call
4116-300	16384 x 1	(300ns)	8/13.80	call
2118	16384 x 1	(5v) (150ns)	4.95	call
MK4816	2048 x 8	(5v) (300ns)	24.95	call
4164-200	65536 x 1	(5v) (200ns)	call	call
4164-150	65536 x 1	(5v) (150ns)	call	call

EPROMS

			Each	8 pcs
1702	256 x 8	(1us)	4.95	4.50
2708	1024 x 8	(450ns)	3.75	3.50
2758	1024 x 8	(5v) (450ns)	9.95	8.95
TMS2516	2048 x 8	(5v) (450ns)	6.95	5.95
2716	2048 x 8	(5v) (450ns)	4.95	3.95
2716-1	2048 x 8	(5v) (350ns)	9.00	8.50
TMS2716	2048 x 8	(450ns)	9.95	8.95
TMS2532	4096 x 8	(5v) (450ns)	9.95	7.95
2732	4096 x 8	(5v) (450ns)	9.95	7.95
2732A-2	4096 x 8	(5v) (200ns)	call	call
2764	8192 x 8	(5v) (450ns)	call	call
TMS2564	8192 x 8	(5v) (450ns)	call	call

5v = Single 5 Volt Supply

EPROM ERASERS

	Timer	Capacity Chip	Intensity (uW/cm ²)	
PE-14		6	5,200	83.00
PE-14T	X	6	5,200	119.00
PE-24T	X	9	6,700	175.00
PL-265T	X	20	6,700	255.00
PR-125T	X	16	15,000	349.00
PR-320T	X	32	15,000	595.00

JULY SPECIALS
2K x 8 STATIC

TMM-2016 (200NS)

8/6⁹⁵ EA.
HM6116 (200NS)

8/7⁹⁵ EA.

64K DYNAMIC
4164 (200NS)

8/8⁹⁵ EA

16K DYNAMIC
4116 (200NS)

8/13⁹⁵

16K EPROMS
2716 (450NS)

8/3⁹⁵ ea.

32K EPROMS
2532 or 2732 (450NS)

8/7⁹⁵ EA.

PRICES GOOD FOR THE MONTH OF JULY ONLY. PLEASE MENTION JULY SPECIALS WHEN ORDERING.

74LS00 SERIES

74LS00	.25	74LS169	1.75
74LS01	.25	74LS170	1.75
74LS02	.25	74LS173	.80
74LS03	.25	74LS174	.95
74LS04	.25	74LS175	.95
74LS05	.25	74LS181	2.15
74LS08	.35	74LS189	9.95
74LS09	.35	74LS190	1.00
74LS10	.25	74LS191	1.00
74LS11	.35	74LS192	.85
74LS12	.35	74LS193	.95
74LS13	.45	74LS194	1.00
74LS14	1.00	74LS195	.95
74LS15	.35	74LS196	.85
74LS20	.25	74LS197	.85
74LS21	.35	74LS221	1.20
74LS22	.25	74LS240	1.29
74LS26	.35	74LS241	1.29
74LS27	.35	74LS242	1.85
74LS28	.35	74LS243	1.85
74LS30	.25	74LS244	1.29
74LS32	.35	74LS245	1.90
74LS33	.55	74LS247	.75
74LS37	.55	74LS248	1.25
74LS38	.35	74LS249	.99
74LS40	.35	74LS251	1.30
74LS42	.55	74LS253	.85
74LS47	.75	74LS257	.85
74LS48	.75	74LS258	.85
74LS49	.75	74LS259	2.85
74LS51	.25	74LS260	.85
74LS54	.35	74LS266	.55
74LS55	.35	74LS273	1.85
74LS63	1.25	74LS275	3.35
74LS73	.40	74LS279	.55
74LS74	.45	74LS280	1.98
74LS75	.50	74LS283	1.00
74LS76	.40	74LS290	1.25
74LS78	.50	74LS293	1.85
74LS83	.75	74LS295	1.05
74LS85	1.15	74LS298	1.20
74LS86	.40	74LS324	1.75
74LS90	.65	74LS352	1.55
74LS91	.89	74LS353	1.55
74LS92	.70	74LS363	1.35
74LS93	.65	74LS364	1.95
74LS95	.85	74LS365	.95
74LS96	.95	74LS366	.95
74LS107	.40	74LS367	.70
74LS109	.40	74LS368	.70
74LS112	.45	74LS373	1.75
74LS113	.45	74LS374	1.75
74LS114	.50	74LS377	1.45
74LS122	.45	74LS378	1.18
74LS123	.95	74LS379	1.35
74LS124	2.99	74LS385	1.90
74LS125	.95	74LS386	.65
74LS126	.85	74LS390	1.90
74LS132	.75	74LS393	1.90
74LS136	.55	74LS395	1.65
74LS137	.99	74LS399	1.70
74LS138	.75	74LS424	.95
74LS139	.75	74LS447	.37
74LS145	1.20	74LS490	1.95
74LS147	2.49	74LS624	3.99
74LS148	1.35	74LS668	1.69
74LS151	.75	74LS669	1.89
74LS153	.75	74LS670	2.20
74LS154	2.35	74LS674	9.65
74LS155	1.15	74LS682	3.20
74LS156	.95	74LS683	2.30
74LS157	.75	74LS684	2.40
74LS158	.75	74LS685	2.40
74LS160	.90	74LS688	2.40
74LS161	.95	74LS689	2.40
74LS162	.95	74LS763	24.95
74LS163	.95	81LS95	1.69
74LS164	.95	81LS96	1.69
74LS165	.95	81LS97	1.89
74LS166	2.40	81LS98	1.69
74LS168	1.75		

TRANSISTORS

PN2222	10/1.00	100/ 8.99
2N2222	.25	50/10.99
2N2907	.25	50/10.99
2N3055	.79	10/ 6.99
2N3904	10/1.00	100/ 8.99
2N3906	10/1.00	100/ 8.99
1N4148 (1N914)		25/ 1.00
1N4004		10/ 1.00

PROMS

Order by National Part No.	Function	EQUIVALENT PART NUMBERS			
		TI	SG	MM	Harris
74S188	32x8 OC	18SA030	82S23	6330-1	7602 2.95
74S287	256x4 TS	14S10	82S128	6301-1	7611 3.25
74S288	32x8 TS	18S030	82S123	6331-1	7603 2.75
74S387	256x4 OC	14SA10	82S126	6300-1	7610 2.95
74S471	256x8 TS	18S22	82S147	6349-1	7649 10.95
74S472	512x8 TS	18S42	82S146	6348	7648 10.95
74S473	512x8 OC	18SA42	82S141	6341	7641 12.95
74S474	512x8 TS	18S46	82S140	6340	7640 12.95
74S475	512x8 TS	18SA46	82S130	6305	7620 5.95
74S478	1Kx8 TS	28S96	82S131	6306-1	7621 5.95
74S570	512x4 OC	27S12	82S136	6352-1	7642 9.95
74S571	512x4 TS	27S13	82S137	6353-1	7643 9.95
74S572	1Kx4 OC	24SA41	82S180	6380-1	7680 19.25
74S573	1Kx4 TS	24S41	82S181	6381-1	7681 16.25
87S180	1Kx8 OC	26SA86	82S184	7884	17.20
87S181	1Kx8 TS	26S86	82S185	7885	16.95
87S184	2Kx4 OC	24SA81	82S190	78160	39.95
87S185	2Kx4 TS	24S81	82S191	78161	39.95
87S190	2Kx4 OC	26SA166			
87S191	2Kx8 TS	26S166			

JDR MICRODEVICES, INC.

1224 S. Bascom Avenue

San Jose, CA 95128

800-538-5000 • 800-662-6279 (CA)

(408) 995-5430 • Telex 171-110

HOURS: Mon. - Fri. 9 to 5; Sat. 11 to 3

VISIT OUR RETAIL STORE!

TERMS: For shipping include \$2.00 for UPS Ground, \$3.00 for UPS Blue Label Air. \$10.00 minimum order. Bay Area residents add 6 1/2% sales tax. California residents add 6% sales tax. We reserve the right to limit quantities and substitute manufacturer. Prices subject to change without notice. Send SASE for complete list.



ZENITH MONITOR

MODEL ZVM-121

- * 12" P-31 Green phosphor
- * SELECTABLE 40 or 80 CHARACTERS PER LINE
- * 15 MHZ BANDWIDTH

\$119⁹⁵

ORDER TOLL FREE

800-538-5000

800-662-6279

(CALIFORNIA RESIDENTS)

.....●●●●●●●●●●
**We Will
 Beat Any
 Competitors
 Prices**

●●●●●●●●●●
 A copy of this policy is available upon request.

A LETTER FROM THE PRESIDENT.....

At JDR Microdevices, Inc. 100% customer satisfaction is our goal! Our first priority is to make sure that all of our customers receive our world famous JDR service:

GUARANTEED LOWEST PRICES!

If you see an item advertised elsewhere for less, tell us - we will match or beat their price.*

FRIENDLY STAFF!

To make doing business with JDR a pleasant experience.

SPEEDY SERVICE!

To speed your order on its way in one day with superb accuracy.

To better help us serve the needs of our customers, we have installed a new IBM System 34 Computer. This will enable us to reach our goal of 100% Customer Satisfaction, but we need your help - please use your customer number whenever ordering. Your permanent customer number can be found on the left-hand side of your computer printed invoice.

I would like to take this opportunity to thank all of our customers for making JDR one of the fastest growing electronic firms in the world!

Jeffery D. Rose

* A copy of this policy is available upon request.

DISKETTES

5 1/4"

- ANTHANA SS SD SOFT 24.95
- WABASH SS SD SOFT 24.95
- VERBATIM SS SD SOFT 29.95
- VERBATIM 10 SECTION HARD... 29.95

8"

- VERBATIM SS SD SOFT 44.95

BOOKS BEST SELLERS

OSBORNE/MC GRAW-HILL

- Apple II User's Guide 14.95
- CRT Controller's Handbook 6.99
- 68000 Assembly Language Programming 16.99
- CBASIC User Guide 15.00
- The 8086 Book 16.99

SYBEX

- Your First Computer 6.95
- The CP/M Handbook 14.95
- From Chips to Systems 14.95
- The PASCAL Handbook 18.95
- Microprocessor Interfacing Techniques 17.95

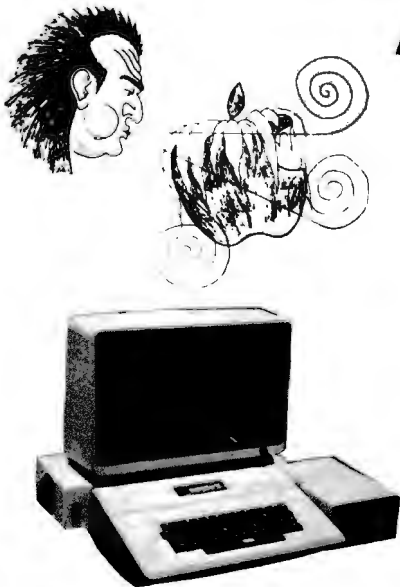

APPLE* FAN

\$69⁰⁰

- OUTLET ON THE REAR OF THE FAN FOR A MONITOR - CONTROLLED BY THE SWITCH
- ULTRA-QUIET APPLE FAN DRAWS COOL AIR THROUGH YOUR COMPUTER
- ELIMINATES DOWN TIME
- SAVES REPAIR CHARGES
- INCREASES RELIABILITY
- CLIPS ON—NO HOLES OR SCREWS
- LONG LIFE, LOW NOISE MOTOR

*Apple is a trademark of APPLE COMPUTER, INC.

ADD ON DISK DRIVE For Apple* II

- ★ Includes metal cabinet
- ★ Color matches Apple*
- ★ 35 Tracks/single side
- ★ Includes cable
- ★ Use with Apple* II Controller

\$375⁰⁰



JDR MICRODEVICES, INC.

1224 S. Bascom Avenue

San Jose, CA 95128

800-538-5000 • 800-662-6279 (CA)

(408) 995-5430 • Telex 171-110

Circle 205 on inquiry card.

HOURS: Mon. - Fri. 9 to 5; Sat. 11 to 3

VISIT OUR RETAIL STORE!

TERMS For shipping include \$2.00 for UPS Ground, \$3.00 for UPS Blue Label Air \$10.00 minimum order. Bay Area residents add 6 1/2% sales tax. California residents add 6% sales tax. We reserve the right to limit quantities and substitute manufacturer. Prices subject to change without notice. Send SASE for complete list.

What's New?

seeking printing in mono-spaced alphanumeric mode, unidirectional and logic-seeking printing in the graphics mode, 6- or 8-pin graphics, 7 resident international character sets, selectable forms length from 3½ inches to 15½ inches in half-inch increments, and user-selectable 6, 9, or 18 lines per inch. The Model 122 is software-compatible with the Centronics Model 739.

The Model 122 graphics dot-matrix printer costs \$1195. Further information is available from Centronics Data Computer Corp., Hudson, NH 03051, (603) 883-0111.

Circle 514 on inquiry card.

Add-on Memory for the IBM

Davong Systems of Mountain View, California, has introduced a series of add-on memory cards for the IBM Personal Computer. The cards offer 64K, 192K, and 256K bytes of RAM (random-access read/write memory) and complete hardware- and software-compatibility with the IBM. The boards range in price from \$395 to \$1075 and are available at selected Computerland stores. For your nearest dealer, contact Davong Systems Inc., 1061 Terra Bella Ave., Mountain View, CA 94043, (415) 965-7130.

Circle 515 on inquiry card.

Color Computer Expansion Unit

The Color Computer Expansion Unit gives the TRS-80 Color Computer an additional 64K bytes of RAM (random-access read/write memory) and the circuitry necessary for an 80-character by 25-line alphanumeric display. The Expansion Unit has a Z80A microprocessor that gives the Color Computer the added versatility of running the CP/M operating system while maintaining full compatibility with 6809 software such as the Flex and OS-9 operating systems. Other features provided with the Expansion Unit include software-selectable video-display formats of 80 characters by 25 lines or the standard 32 characters by 16 lines and a dual-density 5¼-inch disk controller capable of supporting four drives with up to 800K bytes of storage per drive for a total of 3.2 megabytes. Standard features supplied include a Color Computer-compatible RS-232C serial port, two expansion buses for hard-disk and custom applications, and a built-in audio driver and speaker.

Optionally the Expansion Unit can be equipped with an IEEE-488/1980 controller and a light pen. The Color Computer Expansion Unit has a suggested price of \$1585; dealer inquiries are invited. For further information, contact George Associates, POB 960, Berkeley, CA 94701, (415) 843-3587.

Circle 516 on inquiry card.

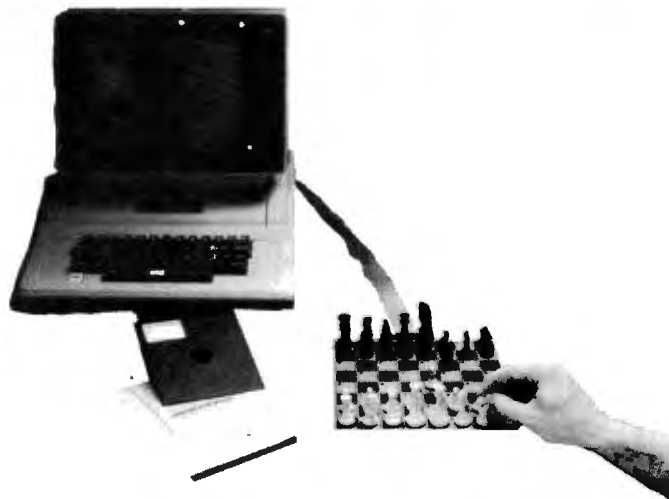

Chess Peripheral

Mate, a hardware and software peripheral for the Apple II, includes the strongest chess-playing program ever developed for a microcomputer, according to the manufacturer. Designed for 32K-byte Apple, TRS-80, and PET computers, Mate is supplied with a magnetic sensor chessboard, magnetic pieces, plug-in interface card, and a cable. Its many game-playing features include the ability to "think" on opponent's time, nine levels of play, an opening library of more

than 6000 moves, best and randomized move selection, move suggestions, reverse board, and print-out of an entire game. Full documentation for the interface software is provided for those who want to create their own chess programs.

Manufactured by Applied Concepts, Mate is available for \$269.95, including game program on cassette or disk and a manual, from PMK Associates, POB 598, East Brunswick, NJ 08816, (201) 246-7680.

Circle 517 on inquiry card.

Color Monitor for IBM and Apple

Amdek's Color II is a 16-color, high-resolution video monitor designed for the IBM Personal Computer or, with the Amdek DVM (digital video multiplexer) interface board, the Apple II. The 13-inch RGB (red/green/blue) Color II can generate an 80-character by 24-line display and 560 horizontal by 260 vertical resolution.

The Color II, including

access cable, is available at Computerland stores, IBM Personal Computer Centers, and Apple dealers for \$999. The DVM, including an access cable for the Apple II and III, costs \$200. Further details can be obtained from Amdek Corp., 2420 East Oakton St., Arlington Heights, IL 60005, (312) 364-1180.

Circle 518 on inquiry card.

What's New?



Scientific Control and Data-Collection Tools

The Adalab data-acquisition and control interface card for the Apple II controls and collects data from most scientific instruments, including spectrophotometers, strip-chart recorders, chromatography systems, and temperature controllers. Optional accessories for the Adalab include the Ada-Amp instrumentation amplifier with a 0.1 to 1000 gain range, the Vidisampler real-time data-acquisition software package that permits simultaneous data-acquisition from four analog inputs, and the Tempense hardware and software package for monitoring up to 64 thermocouples or heat sensors. Other equipment available for the Adalab includes a 32-bit digital I/O multiplexer accessory called Ada-Byte and Vidimemory, an extended-memory/bulk data-storage option that works with 16K-, 64K-, or 128K-byte RAM (random-access read/write memory) cards.

Complete details on the Adalab data-acquisition

and control interface card and its wide variety of accessories are available from Interactive Microware Inc., POB 771, State College, PA 16801, (814) 238-8294.

Circle 519 on inquiry card.



Give the H-89 Speech

Mako's multiple programmable sound generators (PSGs) give Heath or Zenith computers equipped with the General Instrument AY3-8910 PSG chip the ability to produce a wide variety of complex sounds under software control. The PSGx2, designed for the Z-89 or H-89, plugs directly into the P504 or P505 bus slots and uses any decoded port address. The PSGx4 has four PSG chips and plugs directly in-

to the H-8 bus. Each board is supplied with a speaker, a built-in audio monitor amplifier, and crystal time base. Options for the boards include the Micro-Piano 2.0, which is capable of playing up to a six-note polyphony over an eight-octave range.

The PSGx2 costs \$125, and the PSGx4 costs \$225, plus \$5 shipping and handling. The Micro-Piano is available for \$24.95. Orders are being accepted at Mako Data Products, 1441-B North Red Gum, Anaheim, CA 92806, (714) 632-8583.

Circle 520 on inquiry card.

Turn Your Micro Into a Mini

The Loadstar 8000 upgrades any single-user 8-bit Z80 microcomputer with from 4K to 64K bytes of RAM (random-access read/write memory) to a 16-bit Z8000 minicomputer with 64K bytes of RAM (expandable to 8.3 megabytes and multiple users). The Loadstar has two ROMs (read-only memories) that contain part of the operating system and the interface circuitry and are capable of storing 8K bytes. Other features include a 4-MHz system clock, 414 machine-language instructions, and the ability to handle from 1250 to 5000 instructions per second. When the Loadstar 8000 is connected to any Z80-based system, such as the TRS-80, Apple (with the Microsoft Softcard), Exidy, Superbrain, Godbout, or

Cromemco, the system has the capability of addressing 128 times more memory and increasing system speed 5 to 20 times.

The Loadstar 8000 has a suggested retail price of \$900. Additional details can be obtained from Loadstar Technology Corp., 10073 Saich Way, Cupertino, CA 95014, (408) 996-8333.

Circle 521 on inquiry card.



Modem Uses Inductive Coupling

The MFJ-1230 originate/answer modem uses an inductive-coupling technique for receiving data. This approach provides more reliable data transfer because it eliminates errors caused by room noise, vibrations, and other acoustic-coupling problems. The Bell 103-compatible MFJ-1230 operates at data rates from 0 to 300 bps (bits per second) and features half- and full-duplex operation, TTL, CMOS, and RS-232C compatibility, and I/O ports for a cassette tape recorder.

The price for the crystal-controlled MFJ-1230 is \$129.95. A version for the Apple, the MFJ-1231, costs \$139.95. Complete specifications are available from MFJ Enterprises Inc., 921 Louisville Rd., Starkville, MS 39759, (800) 647-1800; in Mississippi, (601) 323-5869. Circle 522 on inquiry card.

What's New?

Add a Computer to the IBM Personal Computer

Baby Blue is an accessory printed-circuit board and software package for the IBM Personal Computer. When used with its software, the Baby Blue board becomes a Z80 computer within your computer, allowing you to run programs written for the CP/M-80 operating system. Baby Blue's hardware is made up of 64K bytes of dual-ported 200-nanosecond RAM (random-access read/write memory) with parity checking and a Z80B microprocessor that can operate with the 4.77-MHz system clock speed of the IBM's 8088 microprocessor. The software is made up of a translator and an intelligent converter that activates the Z80B, reads files from many 5¼-inch soft-sectored CP/M disk formats, and determines which files are executable machine-language files.

The Baby Blue, complete with software on disk, costs \$600. Optionally, Baby Blue can be purchased with the Wordstar and Mailmerge programs for \$980. For further details, contact Xedex Corp., 1345 Ave. of the Americas, New York, NY 10105, (212) 489-0444. Circle 523 on inquiry card.

Video Controllers

Zircon International's Video Command series of video controllers are designed for game or graphics applications on Apple,

Atari, PET, VIC, and TRS-80 computers. Among the controllers available is the Video Stick, which combines X and Y functions in a single unit. Video Stick features dual fire buttons and gimbal assembly, potentiometers, and switches. Its suggested retail price is \$49.95, and versions are available for the Apple, the TRS-80 Color Computer, and the IBM Personal Computer.

The Video Command XYZ controller has an eight digital switch mechanism and is compatible with most existing PET, VIC, and Atari software. The suggested price for the Video Command is \$14.95. For complete details on the Video Command series of controllers, contact Zircon International Inc., 475 Vandell Way, Campbell, CA 95008, (408) 866-8600. Circle 524 on inquiry card.

SOFTWARE

Language Series for the IBM

The Computer Language series offers IBM Personal Computer users a wide choice of programming languages and operating systems. Some of the products available are a macro assembler that runs under PC-DOS, a FORTRAN compiler that also runs under PC-DOS, and UCSD Pascal p-System, an advanced operating system with UCSD Pascal or FORTRAN-77.

Prices for products in the Computer Language series range from \$100 to \$625. The series is available at local IBM Product Centers, Computerland stores, and Sears Roebuck and Company's Business Systems Centers. For the address of your nearest IBM dealer, call (800) 447-4700; in Illinois, (800) 322-4400; in Alaska and Hawaii, (800) 447-0890.

Circle 525 on inquiry card.

Robot Simulator

The Karel Simulator implements a Pascal-like compiler/debugger environment that can be used to teach beginners structured programming techniques. The Simulator lets students write programs that make Karel, an on-screen robot, manipulate a world of intersecting streets and objects. The Simulator's language is easy to learn, but rich enough for challenging tasks such as escaping from mazes and following paths. The Simulator's programming language is documented in Richard E. Pattis's *Karel the Robot: A Gentle Introduction to the Art of Programming* (John Wiley & Sons, 1981).

The Karel Simulator runs on Apple computers with a language card, one disk drive, and a 40- or 80-column display screen. The complete package costs \$85 and includes a notebook, a protected copy of the Simulator, a preformatted disk with two dem-

onstration programs, a 24-page instruction manual, and a tutorial on using the UCSD Pascal filer and editor. For teaching or self-instruction, a complete set of two course disks containing all the examples from the book (a total of more than 125 files) is available for \$150. The Karel Simulator can be purchased from Cybertronics International Inc., Software Publishing Division, 999 Mount Kemble Ave., Morristown, NJ 07960, (201) 766-7681.

Circle 526 on inquiry card.

Pascal Compiler for CP/M

JRT Systems recently introduced version 2 of its Pascal compiler for CP/M. Version 2 is a one-step compiler with separately compiled external procedures and functions that allow very large programs to be developed. Standard features include the ability to link together or auto-load program sections at run-time, a virtual storage manager that allows programs of unlimited size to be run while providing full support for dynamic Pascal variables, and no size limit for procedures, nesting levels, or recursion. The compiler's arithmetic ability has 14 digits of precision, and its BCD (binary-coded decimal) format eliminates conversion errors. For scientific applications, the compiler's floating-point exponent ranges from

What's New?

-64 to +63. Dynamic text strings can be as large as 64K bytes. Other features include the ability to access random disk files by relative record number or relative byte address and the ability to process disk files as ASCII text or as binary data.

A single-user license for version 2 of the JRT Pascal compiler for CP/M costs \$29.95. It is available from JRT Systems Inc., 1891 23rd Ave., POB 22365, San Francisco, CA 94122, (415) 566-4240.
Circle 527 on inquiry card.

Pascal-Like Language for the Apple

The XPLO language system gives Apple II users a fast-executing alternative to UCSD Pascal. It retains Pascal's syntax and control structures, so it is easy for Pascal programmers to learn. In contrast to Pascal, XPLO has loose variable typing, which gives it greater flexibility for most programming applications. Among its standard features are the full set of Pascal control structures; a full range of simple data types including integers, reals, and characters; a complete set of intrinsic functions for mathematical calculations; support for Apple hardware such as high- and low-resolution graphics, game paddles, and sound; and program-development features such as chaining, overlays, and library capability.

The XPLO Language sys-

tem costs \$185. Optionally, XPLO is available with Advanced Micro Devices' 9511 floating-point processor for number-crunching applications for \$205. XPLO can be obtained from Computer Sight, Suite 503, 2490 Channing Way, Berkeley, CA 94704, (415) 644-1688.

Circle 528 on inquiry card.

IBM Word Processor and Text Editor

Lifetree Software has introduced a new word processor and text editor for the IBM Personal Computer called the Volkswriter. Standard editing features include a full-screen editor, Reset key, automatic word-wrap, rapid line or character insertion, flexible search and replace, automatic centering, left and right justification, and an onscreen, step-by-step tutorial. Print features include page numbering as well as the ability to define the format through a menu, to print an entire document or a single page at a time, and to define paper size and printing area. With an optional asynchronous adapter, you can prepare files for transmission to a typesetter. Since its files are standard PC-DOS format, Volkswriter is compatible with most IBM Personal Computer software.

Volkswriter requires an IBM Personal Computer with a minimum of 64K bytes of memory, a single disk drive, PC-DOS, and an IBM, Epson, or NEC Home

Electronics printer with Centronics-type parallel interface. For extensive writing, two disks and 128K bytes of memory are recommended. The Volkswriter is available for \$195. For the name of your nearest dealer, contact Lifetree Software Inc., Suite 342, 177 Webster St., Monterey, CA 93940, (408) 659-3211.

Circle 529 on inquiry card.

Apple Graphics Language

The GraFORTH graphics programming language for the Apple II has easy-to-read code and programs that are fully compiled to machine language for fast execution. It features fast three-dimensional color animation graphics, including rotation, scale, transposition, and perspective. According to the manufacturer, lines can be drawn faster than with BASIC and colored lines are never broken. GraFORTH includes turtle graphics, for rapidly drawing line shapes at any angle, and a software-based music synthesizer.

GraFORTH requires a 48K-byte Apple II with DOS 3.3 and one disk drive (use of a 16K-byte RAM card is recommended). It's available for \$75, including a 220-page manual, from Insoft, Suite 202B, 10175 Southwest Barbur Blvd., Portland, OR 97219, (503) 244-4181.

Circle 530 on inquiry card.

Relational Query Language

RQL is a relational algebraic query language implemented in Applesoft floating-point BASIC that lets you see a database as a collection of tables. This approach allows computer novices to use RQL to build, interrogate, and search databases. Commands provided with RQL include define and access a database; define a table; insert, delete, and update rows in a table; create a table from one or two existing tables by means of selection, union, intersection, symmetric difference, etc.; and compute the aggregate functions of average, count, sum, minimum, and maximum.

RQL requires an Apple II or Apple II Plus computer with DOS 3.3, Applesoft, and two floppy-disk drives. RQL on a floppy disk, a program listing, and the user's manual together cost \$140. The user's manual and the program listing alone cost \$120, and the user's manual is available separately for \$20. For details, contact Hello Software, 8380 Roanne Dr., Orlando, FL 32817, (305) 677-1108.

Circle 531 on inquiry card.

MISCELLANEOUS

Office Filing System

The Colortrol is a business filing system that's used in conjunction with a desktop computer or a word processor. It provides an automatic computer-

What's New?

generated color-coded filing system and a database for easy file management. When used with a printer, Colortrol can print color-coded file labels. Formats include 8-inch IBM soft-sectored, North Star double-density, Micropolis Model II, Superbrain 3.0, Apple II with CP/M, and 5¼- and 8-inch Xerox.

Colortrol requires an 8080-, 8085-, or Z80-based microcomputer with 48K bytes of RAM (random-access read/write memory), CP/M, and an Epson or NEC Home Electronics printer. Its price is \$195. The manual alone costs \$30. Complete details are available from Digital Marketing, 2670 Cherry Lane, Walnut Creek, CA 94596, (415) 938-2880.

Circle 532 on inquiry card.

BASIC Reference Card for the IBM

Minimagic has introduced a BASIC language reference card for the IBM Personal Computer. The card has 14 panels of selected information, including a discussion on getting BASIC up and running, alphabetized descriptions of more than 80 BASIC statements, graphics and color programming information, BASIC control commands for program development and execution, and functions relating to mathematics, string manipulation, and I/O. All entries are alphabetized and grouped by function for quick and easy reference, and each entry has a brief

description and examples of usage. Each grouping contains all the facilities offered by IBM BASIC.

The BASIC language reference card for the IBM Personal Computer costs \$3.50, postage paid. Contact Minimagic Co., 104 Park Rd.#34, West Hartford, CT 06119.



Surge Suppressors

Kalglo Electronics' Quad series of surge suppressors features four filtered outlets. The Quad-I has transient absorption only, while the Quad-II has transient absorption and dual three-stage low-pass filters for radio-frequency-interference noise filtering. All units are prewired and ready to use. The Quad-I costs \$49.95, and the Quad-II costs \$59.95. For further details, contact Kalglo Electronics Co. Inc., Department Quad, 6584 Ruch Rd., East Allen Township, Bethlehem, PA 18017, (800) 523-9685. For technical information or to order within Pennsylvania, call (215) 865-0006. Circle 533 on inquiry card.

Automatic Shut Off for Disk Drives

Optronics Technology's Drive Control Unit (DCU) gives you automatic on/off control over your 8-inch floppy-disk drive motor. The DCU has connectors that allow it to fit within the drive assembly in series with the drive motor. During drive access, the motor is energized at zero-crossing for low noise. After 8 seconds (adjustable) of idle time, the drive will switch off, which minimizes media damage due to constant use and lowers overall system noise levels.

In kit form, the DCU costs \$29.95. An assembled and tested version is available for \$39.95. For additional details, contact Optronics Technology, POB 81, Pittsford, NY 14534, (716) 377-0369. Circle 534 on inquiry card.

High-Density Floppy Disks

Brown Disc Manufacturing has unveiled a new series of high-density 5¼-inch floppy disks: the UHR I and the VHR I families. The UHR I floppy disk provides ultra-high-density recording capabilities for 150- to 200-tpi (track per inch) applications. According to the manufacturer, the UHR I disk is the only media qualified as a 1.6-megabyte single-sided disk for use with Amlyn Corporation's Models 5860 and A506 high-capacity mini-floppy-disk drives. The VHR I is designed for 96-tpi data-storage applications.

Both families are made with a spin coating technique that's similar to that used for hard-disk media. This method provides a more consistent dispersion of the magnetic coating. Further information is available from Brown Disc Manufacturing Inc., 1015 Garden of the Gods Rd., Colorado Springs, CO 80907, (303) 593-1015. Circle 535 on inquiry card.

Data-Encryption Device

The Black Board is an S-100-bus-compatible module with a built-in, high-speed data-encryption device and bus interface/control logic that is certified by the National Bureau of Standards. Designated the Model ESB-2S, the device is useful for secure tape or disk storage, program protection, and data security and protection schemes. The Black Board uses two consecutive output ports for control and data, and the key, which is not externally accessible, is stored on a chip. Other features include encryption and decryption of 64-bit data words using a 56-bit key, a 1.3-megabit-per-second transfer rate, parity checking during key loading, and no wait states at a speed of 4 MHz. It's compatible with the CP/M, CDOS, Unix, Cromix, and MP/M operating systems. Supplied software includes low-level drivers and encryption/decryption programs.

Optional software for

What's New?

the Black Board includes the Keyper System, which is an automated file-access security system with infinite master key capabilities. The Black Board, including documentation and software to get your system up and running, is available for \$595; the bare board alone costs \$495. For more details, contact Cydat Inc., Suite 322, 500 Airport Blvd., Burlingame, CA 94010, (800) 227-2400, ext. 906; in California, (800) 772-2666, ext. 906.

Circle 536 on inquiry card.

Software Locator Service

Subscribers to the Sofsearch software locator service have access to information on more than 12,000 software products for both small computers and large computers. Sofsearch provides custom reports on software products that meet up to five sets of subscriber-specified selection criteria ranging from computer system used or considered to industry/activity to be served. Each report has product name, supplier address,

contact information, and a general description of the product. Product reports are packaged in an indexed binder and are updated quarterly. Subscribers can also request special one-time reports for an additional fee.

A year's subscription to the Sofsearch software locator service costs \$125. A complete description of Sofsearch is available from CCS Inc., Corporate Offices, POB 5276, San Antonio, TX 78201, (512) 340-8735.

Circle 537 on inquiry card.

the existing card edge plug on the printed-circuit board of the keyboard and expansion ports. Compatibility is maintained because it permits the use of existing female connectors on all cables. Additionally, all existing expansion devices can be used without modifications.

To install the Gold Plug 80, disassembly of the keyboard and/or Expansion Interface is required, as well as soldering directly to the Model I's existing card connector. The Gold Plug 80 adds slightly more than a half inch to the card edge plugs.

In kit form, the Gold Plug 80 for the keyboard printed-circuit board to Expansion Interface costs \$18.95. Versions for the Expansion Interface to disk, printer, screen printer, or RS-232C ports cost \$9.95 each. A complete set of cables for all the ports is available for \$54.95. For details, contact E.A.P. Co., POB 14, Keller, TX 76248, (817) 498-4242.

Circle 538 on inquiry card.

TANTALUM CAPACITORS 200P 50V 3.3 \$1.50 47P 75V 1.0 \$1.45 100P 75V 1.5 \$1.50 220P 75V 2.0 \$1.55 470P 75V 2.5 \$1.60 1000P 75V 3.0 \$1.65 2200P 75V 3.5 \$1.70 4700P 75V 4.0 \$1.75 10000P 75V 4.5 \$1.80 22000P 75V 5.0 \$1.85	LINEAR CIRCUITS LM301 75 LM301 748 30 LM301 745 30 741C 75 741 35 141 60 1496 80 4735 80 807 45 LM307 33 LM308 75 LM309 75 LM332A 65 LM332B 65 LM333 75 LM334 75 LM335 75 LM337 75 LM338 75 LM339 75 LM340 75 LM341 75 LM342 75 LM343 75 LM344 75 LM345 75 LM346 75 LM347 75 LM348 75 LM349 75 LM350 75 LM351 75 LM352 75 LM353 75 LM354 75 LM355 75 LM356 75 LM357 75 LM358 75 LM359 75 LM360 75 LM361 75 LM362 75 LM363 75 LM364 75 LM365 75 LM366 75 LM367 75 LM368 75 LM369 75 LM370 75 LM371 75 LM372 75 LM373 75 LM374 75 LM375 75 LM376 75 LM377 75 LM378 75 LM379 75 LM380 75 LM381 75 LM382 75 LM383 75 LM384 75 LM385 75 LM386 75 LM387 75 LM388 75 LM389 75 LM390 75 LM391 75 LM392 75 LM393 75 LM394 75 LM395 75 LM396 75 LM397 75 LM398 75 LM399 75 LM400 75	CRYSTALS 2.000 18.432 20.000 \$4.25 ea 3.000 5.000 8.000 3.579 8.000 10.000 4.000 8.144 18.000 \$2.50 ea
RS232 CONNECTORS DB 25P male \$2.75 DB 25S female 3.75 HOODS 1.50	INTERFACE & DRIVERS FD1791 34.95 1488 30 1489 1.0 8831 2.50 8832 2.50 8833 2.50 8834 2.50 MM5320 3.50 MM5321 3.50 MM5322 2.50	REGULATORS LM317T 81.75 LM337K 82.50 723 5.50 78M05 9.35 78L05 8.45 LM305G 9.75 3207 5.12, 15 or 24 5.90 340K 12, 15 or 24V 81.50 3407 5, 8, 9, 12, 15, 18 or 24V 9.85 208P - OPDT 1.80 208P - OPDT CENTER OFF 11.75
QUART'S A/F5 1013 3.75 FR1602B 1.95 R11602B 2.25 MB882A 8.95 LDM207 3.75	CPU'S & SUPPORT CHIPS 8080A 3.75 8080B 1.95 AMD 2801 4.95 6802 30.00 6803 2.25 6814 3.00 6816 2.90 6818 3.25 6824 3.25 6826 2.75 8086 (1884) 2.75 2114L 3 4118 3 4118 3 4118 3 2110 3 TMS 3408 1.75 M6802 3 M6809 11 M6810 1.75 M6812 1.75 M6813 1.75 M6814 1.75 M6815 1.75 M6816 1.75 M6817 1.75 M6818 1.75 M6819 1.75 M6820 1.75 M6821 1.75 M6822 1.75 M6823 1.75 M6824 1.75 M6825 1.75 M6826 1.75 M6827 1.75 M6828 1.75 M6829 1.75 M6830 1.75 M6831 1.75 M6832 1.75 M6833 1.75 M6834 1.75 M6835 1.75 M6836 1.75 M6837 1.75 M6838 1.75 M6839 1.75 M6840 1.75 M6841 1.75 M6842 1.75 M6843 1.75 M6844 1.75 M6845 1.75 M6846 1.75 M6847 1.75 M6848 1.75 M6849 1.75 M6850 1.75 M6851 1.75 M6852 1.75 M6853 1.75 M6854 1.75 M6855 1.75 M6856 1.75 M6857 1.75 M6858 1.75 M6859 1.75 M6860 1.75 M6861 1.75 M6862 1.75 M6863 1.75 M6864 1.75 M6865 1.75 M6866 1.75 M6867 1.75 M6868 1.75 M6869 1.75 M6870 1.75 M6871 1.75 M6872 1.75 M6873 1.75 M6874 1.75 M6875 1.75 M6876 1.75 M6877 1.75 M6878 1.75 M6879 1.75 M6880 1.75 M6881 1.75 M6882 1.75 M6883 1.75 M6884 1.75 M6885 1.75 M6886 1.75 M6887 1.75 M6888 1.75 M6889 1.75 M6890 1.75 M6891 1.75 M6892 1.75 M6893 1.75 M6894 1.75 M6895 1.75 M6896 1.75 M6897 1.75 M6898 1.75 M6899 1.75 M6900 1.75 M6901 1.75 M6902 1.75 M6903 1.75 M6904 1.75 M6905 1.75 M6906 1.75 M6907 1.75 M6908 1.75 M6909 1.75 M6910 1.75	74LS SERIES 74LS00 30 74LS01 30 74LS02 30 74LS03 30 74LS04 30 74LS05 25 74LS06 25 74LS07 25 74LS08 25 74LS09 25 74LS10 25 74LS11 25 74LS12 25 74LS13 25 74LS14 25 74LS15 25 74LS16 25 74LS17 25 74LS18 25 74LS19 25 74LS20 25 74LS21 25 74LS22 25 74LS23 25 74LS24 25 74LS25 25 74LS26 25 74LS27 25 74LS28 25 74LS29 25 74LS30 25 74LS31 25 74LS32 25 74LS33 25 74LS34 25 74LS35 25 74LS36 25 74LS37 25 74LS38 25 74LS39 25 74LS40 25 74LS41 25 74LS42 25 74LS43 25 74LS44 25 74LS45 25 74LS46 25 74LS47 25 74LS48 25 74LS49 25 74LS50 25 74LS51 25 74LS52 25 74LS53 25 74LS54 25 74LS55 25 74LS56 25 74LS57 25 74LS58 25 74LS59 25 74LS60 25 74LS61 25 74LS62 25 74LS63 25 74LS64 25 74LS65 25 74LS66 25 74LS67 25 74LS68 25 74LS69 25 74LS70 25 74LS71 25 74LS72 25 74LS73 25 74LS74 25 74LS75 25 74LS76 25 74LS77 25 74LS78 25 74LS79 25 74LS80 25 74LS81 25 74LS82 25 74LS83 25 74LS84 25 74LS85 25 74LS86 25 74LS87 25 74LS88 25 74LS89 25 74LS90 25 74LS91 25 74LS92 25 74LS93 25 74LS94 25 74LS95 25 74LS96 25 74LS97 25 74LS98 25 74LS99 25 74LS00 25 74LS01 25 74LS02 25 74LS03 25 74LS04 25 74LS05 25 74LS06 25 74LS07 25 74LS08 25 74LS09 25 74LS10 25 74LS11 25 74LS12 25 74LS13 25 74LS14 25 74LS15 25 74LS16 25 74LS17 25 74LS18 25 74LS19 25 74LS20 25 74LS21 25 74LS22 25 74LS23 25 74LS24 25 74LS25 25 74LS26 25 74LS27 25 74LS28 25 74LS29 25 74LS30 25 74LS31 25 74LS32 25 74LS33 25 74LS34 25 74LS35 25 74LS36 25 74LS37 25 74LS38 25 74LS39 25 74LS40 25 74LS41 25 74LS42 25 74LS43 25 74LS44 25 74LS45 25 74LS46 25 74LS47 25 74LS48 25 74LS49 25 74LS50 25 74LS51 25 74LS52 25 74LS53 25 74LS54 25 74LS55 25 74LS56 25 74LS57 25 74LS58 25 74LS59 25 74LS60 25 74LS61 25 74LS62 25 74LS63 25 74LS64 25 74LS65 25 74LS66 25 74LS67 25 74LS68 25 74LS69 25 74LS70 25 74LS71 25 74LS72 25 74LS73 25 74LS74 25 74LS75 25 74LS76 25 74LS77 25 74LS78 25 74LS79 25 74LS80 25 74LS81 25 74LS82 25 74LS83 25 74LS84 25 74LS85 25 74LS86 25 74LS87 25 74LS88 25 74LS89 25 74LS90 25 74LS91 25 74LS92 25 74LS93 25 74LS94 25 74LS95 25 74LS96 25 74LS97 25 74LS98 25 74LS99 25 74LS00 25 74LS01 25 74LS02 25 74LS03 25 74LS04 25 74LS05 25 74LS06 25 74LS07 25 74LS08 25 74LS09 25 74LS10 25 74LS11 25 74LS12 25 74LS13 25 74LS14 25 74LS15 25 74LS16 25 74LS17 25 74LS18 25 74LS19 25 74LS20 25 74LS21 25 74LS22 25 74LS23 25 74LS24 25 74LS25 25 74LS26 25 74LS27 25 74LS28 25 74LS29 25 74LS30 25 74LS31 25 74LS32 25 74LS33 25 74LS34 25 74LS35 25 74LS36 25 74LS37 25 74LS38 25 74LS39 25 74LS40 25 74LS41 25 74LS42 25 74LS43 25 74LS44 25 74LS45 25 74LS46 25 74LS47 25 74LS48 25 74LS49 25 74LS50 25 74LS51 25 74LS52 25 74LS53 25 74LS54 25 74LS55 25 74LS56 25 74LS57 25 74LS58 25 74LS59 25 74LS60 25 74LS61 25 74LS62 25 74LS63 25 74LS64 25 74LS65 25 74LS66 25 74LS67 25 74LS68 25 74LS69 25 74LS70 25 74LS71 25 74LS72 25 74LS73 25 74LS74 25 74LS75 25 74LS76 25 74LS77 25 74LS78 25 74LS79 25 74LS80 25 74LS81 25 74LS82 25 74LS83 25 74LS84 25 74LS85 25 74LS86 25 74LS87 25 74LS88 25 74LS89 25 74LS90 25 74LS91 25 74LS92 25 74LS93 25 74LS94 25 74LS95 25 74LS96 25 74LS97 25 74LS98 25 74LS99 25 74LS00 25 74LS01 25 74LS02 25 74LS03 25 74LS04 25 74LS05 25 74LS06 25 74LS07 25 74LS08 25 74LS09 25 74LS10 25 74LS11 25 74LS12 25 74LS13 25 74LS14 25 74LS15 25 74LS16 25 74LS17 25 74LS18 25 74LS19 25 74LS20 25 74LS21 25 74LS22 25 74LS23 25 74LS24 25 74LS25 25 74LS26 25 74LS27 25 74LS28 25 74LS29 25 74LS30 25 74LS31 25 74LS32 25 74LS33 25 74LS34 25 74LS35 25 74LS36 25 74LS37 25 74LS38 25 74LS39 25 74LS40 25 74LS41 25 74LS42 25 74LS43 25 74LS44 25 74LS45 25 74LS46 25 74LS47 25 74LS48 25 74LS49 25 74LS50 25 74LS51 25 74LS52 25 74LS53 25 74LS54 25 74LS55 25 74LS56 25 74LS57 25 74LS58 25 74LS59 25 74LS60 25 74LS61 25 74LS62 25 74LS63 25 74LS64 25 74LS65 25 74LS66 25 74LS67 25 74LS68 25 74LS69 25 74LS70 25 74LS71 25 74LS72 25 74LS73 25 74LS74 25 74LS75 25 74LS76 25 74LS77 25 74LS78 25 74LS79 25 74LS80 25 74LS81 25 74LS82 25 74LS83 25 74LS84 25 74LS85 25 74LS86 25 74LS87 25 74LS88 25 74LS89 25 74LS90 25 74LS91 25 74LS92 25 74LS93 25 74LS94 25 74LS95 25 74LS96 25 74LS97 25 74LS98 25 74LS99 25 74LS00 25 74LS01 25 74LS02 25 74LS03 25 74LS04 25 74LS05 25 74LS06 25 74LS07 25 74LS08 25 74LS09 25 74LS10 25 74LS11 25 74LS12 25 74LS13 25 74LS14 25 74LS15 25 74LS16 25 74LS17 25 74LS18 25 74LS19 25 74LS20 25 74LS21 25 74LS22 25 74LS23 25 74LS24 25 74LS25 25 74LS26 25 74LS27 25 74LS28 25 74LS29 25 74LS30 25 74LS31 25 74LS32 25 74LS33 25 74LS34 25 74LS35 25 74LS36 25 74LS37 25 74LS38 25 74LS39 25 74LS40 25 74LS41 25 74LS42 25 74LS43 25 74LS44 25 74LS45 25 74LS46 25 74LS47 25 74LS48 25 74LS49 25 74LS50 25 74LS51 25 74LS52 25 74LS53 25 74LS54 25 74LS55 25 74LS56 25 74LS57 25 74LS58 25 74LS59 25 74LS60 25 74LS61 25 74LS62 25 74LS63 25 74LS64 25 74LS65 25 74LS66 25 74LS67 25 74LS68 25 74LS69 25 74LS70 25 74LS71 25 74LS72 25 74LS73 25 74LS74 25 74LS75 25 74LS76 25 74LS77 25 74LS78 25 74LS79 25 74LS80 25 74LS81 25 74LS82 25 74LS83 25 74LS84 25 74LS85 25 74LS86 25 74LS87 25 74LS88 25 74LS89 25 74LS90 25 74LS91 25 74LS92 25 74LS93 25 74LS94 25 74LS95 25 74LS96 25 74LS97 25 74LS98 25 74LS99 25 74LS00 25 74LS01 25 74LS02 25 74LS03 25 74LS04 25 74LS05 25 74LS06 25 74LS07 25 74LS08 25 74LS09 25 74LS10 25 74LS11 25 74LS12 25 74LS13 25 74LS14 25 74LS15 25 74LS16 25 74LS17 25 74LS18 25 74LS19 25 74LS20 25 74LS21 25 74LS22 25 74LS23 25 74LS24 25 74LS25 25 74LS26 25 74LS27 25 74LS28 25 74LS29 25 74LS30 25 74LS31 25 74LS32 25 74LS33 25 74LS34 25 74LS35 25 74LS36 25 74LS37 25 74LS38 25 74LS39 25 74LS40 25 74LS41 25 74LS42 25 74LS43 25 74LS44 25 74LS45 25 74LS46 25 74LS47 25 74LS48 25 74LS49 25 74LS50 25 74LS51 25 74LS52 25 74LS53 25 74LS54 25 74LS55 25 74LS56 25 74LS57 25 74LS58 25 74LS59 25 74LS60 25 74LS61 25 74LS62 25 74LS63 25 74LS64 25 74LS65 25 74LS66 25 74LS67 25 74LS68 25 74LS69 25 74LS70 25 74LS71 25 74LS72 25 74LS73 25 74LS74 25 74LS75 25 74LS76 25 74LS77 25 74LS78 25 74LS79 25 74LS80 25 74LS81 25 74LS82 25 74LS83 25 74LS84 25 74LS85 25 74LS86 25 74LS87 25 74LS88 25 74LS89 25 74LS90 25 74LS91 25 74LS92 25 74LS93 25 74LS94 25 74LS95 25 74LS96 25 74LS97 25 74LS98 25 74LS99 25 74LS00 25 74LS01 25 74LS02 25 74LS03 25 74LS04 25 74LS05 25 74LS06 25 74LS07 25 74LS08 25 74LS09 25 74LS10 25 74LS11 25 74LS12 25 74LS13 25 74LS14 25 74LS15 25 74LS16 25 74LS17 25 74LS18 25 74LS19 25 74LS20 25 74LS21 25 74LS22 25 74LS23 25 74LS24 25 74LS25 25 74LS26 25 74LS27 25 74LS28 25 74LS29 25 74LS30 25 74LS31 25 74LS32 25 74LS33 25 74LS34 25 74LS35 25 74LS36 25 74LS37 25 74LS38 25 74LS39 25 74LS40 25 74LS41 25 74LS42 25 74LS43 25 74LS44 25 74LS45 25 74LS46 25 74LS47 25 74LS48 25 74LS49 25 74LS50 25 74LS51 25 74LS52 25 74LS53 25 74LS54 25 74LS55 25 74LS56 25 74LS57 25 74LS58 25 74LS59 25 74LS60 25 74LS61 25 74LS62 25 74LS63 25 74LS64 25 74LS65 25 74LS66 25 74LS67 25 74LS68 25 74LS69 25 74LS70 25 74LS71 25 74LS72 25 74LS73 25 74LS74 25 74LS75 25 74LS76 25 74LS77 25 74LS78 25 74LS79 25 74LS80 25 74LS81 25 74LS82 25 74LS83 25 74LS84 25 74LS85 25 74LS86 25 74LS87 25 74LS88 25 74LS89 25 74LS90 25 74LS91 25 74LS92 25 74LS93 25 74LS94 25 74LS95 25 74LS96 25 74LS97 25 74LS98 25 74LS99 25 74LS00 25 74LS01 25 74LS02 25 74LS03 25 74LS04 25 74LS05 25 74LS06 25 74LS07 25 74LS08 25 74LS09 25 74LS10 25 74LS11 25 74LS12 25 74LS13 25 74LS14 25 74LS15 25 74LS16 25 74LS17 25 74LS18 25 74LS19 25 74LS20 25 74LS21 25 74LS22 25 74LS23 25 74LS24 25 74LS25 25 74LS26 25 74LS27 25 74LS28 25 74LS29 25 74LS30 25 74LS31 25 74LS32 25 74LS33 25 74LS34 25 74LS35 25 74LS36 25 74LS37 25 74LS38 25 74LS39 25 74LS40 25 74LS41 25 74LS42 25 74LS43 25 74LS44 25 74LS45 25 74LS46 25 74LS47 25 74LS48 25 74LS49 25 74LS50 25 74LS51 25 74LS52 25 74LS53 25 74LS54 25 74LS55 25 74LS56 25 74LS57 25 74LS58 25 74LS59 25 74LS60 25 74LS61 25 74LS62 25 74LS63 25 74LS64 25 74LS65 25 74LS66 25 74LS67 25 74LS68 25 74LS69 25 74LS70 25 74LS71 25 74LS72 25 74LS73 25 74LS74 25 74LS75 25 74LS76 25 74LS77 25 74LS78 25 74LS79 25 74LS80 25 74LS81 25 74LS82 25 74LS83 25 74LS84 25 74LS85 25 74LS86 25 74LS87 25 74LS88 25 74LS89 25 74LS90 25 74LS91 25 74LS92 25 74LS93 25 74LS94 25 74LS95 25 74LS96 25 74LS97 25 74LS98 25 74LS99 25 74LS00 25 74LS01 25 74LS02 25 74LS03 25 74LS04 25 74LS05 25 74LS06 25 74LS07 25 74LS08 25 74LS09 25 74LS10 25 74LS11 25 74LS12 25 74LS13 25 74LS14 25 74LS15 25 74LS16 25 74LS17 25 74LS18 25 74LS19 25 74LS20 25 74LS21 25 74LS22 25 74LS23 25 74LS24 25 74LS25 25 74LS26 25 74LS27 25 74LS28 25 74LS29 25 74LS30 25 74LS31 25 74LS32 25 74LS33 25 74LS34

**SUNNY LOW LOW COST
POWER SUPPLIES
(LINEAR & SWITCHING)
FOR S-100, DISK DRIVES**



KIT 1, 2 & 3 For S-100

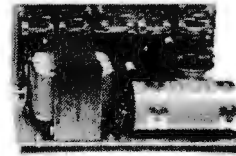

R3 For Three 8" or 5 1/4" Disk Drives

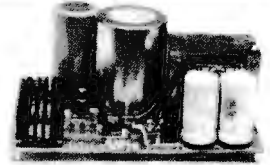

S3 2 in 1 Unit for S-100 and two 8" or 5 1/4" Disk Drives. It fits most Disk System Mainframes.

S-100 POWER SUPPLY KITS (OPEN FRAME WITH BASE PLATE, 3 HRS. ASSY. TIME)

ITEM	USED FOR	@ + 8 Vdc	@ - 9 Vdc	@ + 16 Vdc	@ - 16 Vdc	@ + 28 Vdc	SIZE W x D x H	PRICE
KIT 1	15 CARDS SOURCE	15A	---	2.5A	2.5A	---	12" x 5" x 4 7/8"	54.95
KIT 2	SYSTEM SOURCE	25A	---	3A	3A	---	12" x 5" x 4 7/8"	61.95
KIT 3	DISK SYSTEM	15A	1A	2A	2A	4A	14" x 6" x 4 7/8"	69.95

DISK DRIVE POWER SUPPLY "R3" REGULATED, OPEN FRAME, ASSY. & TESTED 69.95

SPECS +5V @ 6A OVP, -5V @ 1A +24V @ 6A, SHORTS PROTECT. 2 SIZES AVAIL., 1) 9" (W) x 6 1/4" (D) x 4 3/8" (H), 2) 9" (W) x 4 7/8" (D) x 5 1/4" (H)
OPTION 1) REPLACE +24V BY +12V, 2) FOR SIZE 1 ONLY, ADD + 12V @ 1A, AT AN ADDITIONAL \$12.00.

IDEAL FOR THREE 8" or 5 1/4" FLOPPY DISK DRIVES, SUCH AS SHUGART 801/851, SIEMANS FDD 100-8/200-8 OR 100-5 ETC.

*** DISK SYSTEM PWR SUPPLY "S3" OPEN FRAME, ASSY. & TESTED. COMPACT SIZE: 10"(W) x 6"(D) x 5"(H) 102.95**

REGULATED OUTPUTS FOR DISK DRIVES: +5V @ 5A, -5V @ 1A, +24V @ 5A (OR +12V @ 5A).

UNREGULATED OUTPUTS FOR S-100, +8V @ 14A, ± 16V @ 3A.

A COMPLETE UNIT FOR DISK SYSTEM WITH THE MAINFRAME CONTAINING 12 SLOTS & TWO

FUSES PROTECT REG. OUTPUTS.
WITH OVP CIRCUIT FOR +5V.

POWER TRANSFORMERS (WITH MOUNTING BRACKETS)

ITEM	PRIMARY	SECONDARY #1	SECONDARY #2	SECONDARY #3	SIZE W x D x H	PRICE
T1	110/120	2 x 8 Vac, 15A	28 Vac, CT, 2.5A	---	3 3/4" x 3 3/8" x 3 1/8"	22.95
T2	110/120	2 x 8 Vac, 25A	28 Vac, CT, 3.5A	---	3 3/4" x 4 3/8" x 3 1/8"	28.95
T3	110/120	2 x 8 Vac, 15A	28 Vac, CT, 2.5A	48 Vac, CT, 2A	3 3/4" x 4 3/8" x 3 1/8"	30.95
T4	110/120	2 x 8 Vac, 6A	28 Vac, CT, 1.5A	48 Vac, CT, 3A	3 3/4" x 3 3/8" x 3 1/8"	23.95
T5	110/120	2 x 8 Vac, 6A	28 Vac, CT, 2A	---	3" x 3" x 2 1/2"	15.95

SHIPPING FOR EACH POWER SUPPLY: \$5.50 in Calif.; \$8.00 in other states; \$18.00 in Canada.

For each Transformer \$5.00 in all states; \$12.00 in Canada. Calif. residents add 6% sales tax.

ATTENTION O.E.M.'S

**YOUR SPECIAL NEEDS OR
DESIGNS OF TRANSFORMER,
LINEAR & SWITCHING PWR
SUPPLY WILL BE MADE TO
ORDER AT SUNNY LOW LOW
COST & FASTEST DELIVERY.**

MAILING ADDRESS:

P.O. BOX 4296
TORRANCE, CA 90510
TELEX 182558

SUNNY INTERNATIONAL

(TRANSFORMERS MANUFACTURER)
(213) 328-2425 MON-SAT 9-6

SHIPPING ADDRESS:

22129 1/2 S. VERMONT AVE
TORRANCE, CA 90502



**GET CONTROL OF
YOUR WORLD!**

**With the help of your computer
and the RX-10**

The RX-10 provides a communications link between ANY computer system with a parallel port and AC lines, in order to remotely control switches such as the BSR/System X-10® remote modules. Potential applications include reduction of excessive electrical bills and control of security, lighting and environmental systems. *The future is now; there has never been a better time to put your computer in complete control.*

Features:

- ✓ Utilizes advanced CMOS-LSI technology
- ✓ Easy to program and use, completely cost effective and compact
- ✓ Complete 256 channel control (not just 16)
- ✓ Extensive documentation and program examples included

Introducing The Sound Commander: Model RL-10

The RL-10 is available as a plug-in enhancement to the BSR/System X-10 remote control system which provides precision remote volume control for any stereo sound system. When used with a lamp module or dimmer, the RL-10 allows setting the mood from any room or listening position—a convenience you'll wonder how you ever lived without.

Suggested Prices: RX-10 \$149.95
RL-10 \$49.95

**Contact us for more information and order forms.
Dealer inquiries invited.**

BSR/System X-10 is a trademark of BSR, Ltd.

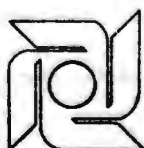

Available From:

ENVIRONMENTAL CONTROL SYSTEMS

9319 Willowview Lane • Houston, Texas 77080 • (713) 464-1717

General Software

Mailing Address:
1454 S. 25th St.
Terre Haute, IN 47803

WE HONOR
VISA and MASTERCARD

TOLL FREE - Outside Indiana
1-800-457-0517

ORDER DESKS
(812) 234-9421

Best Selection

Best Service

Write for our famous CATALOG. Contains many items not in ad. Still only \$1.00 (refund with purchase) Outside US add \$10 plus Air Parcel Postage. Add \$3.50 postage and handling per each item. Indiana residents add 4% sales tax. Allow 2 weeks on checks. COD add \$3.00 per item. Prices subject to change without notice. All items subject to availability.

	Disk with Manual	Manual Only
ARTIFICIAL INTELLIGENCE		
Dental (PAS-3)	\$849/40	
Medical (PAS-3)	\$849/40	
BYROM SOFTWARE		
*BSTAM	\$149	
*BSTMS	\$149	
DIGITAL RESEARCH		
CP/M		
2.2 Intel MDS-800	\$149/25	
Northstar (Horizon)	\$149/25	

Micropolis	\$169/25
TRS Model II	\$159/35
CB-80	\$459/35
CBasic2	\$ 98/20
Pascal MT + Compiler	\$429/30
SPP	\$140/15

FRIENDS	
ACCESS 80 I	\$249/50
ACCESS 80 II	\$429/50

FRONTIER SOFTWARE	
Professional	
Time Accounting	\$549/40
General Subroutine	\$269/40
Application Utilities	\$439/40

ISA	
Spellguard	\$229/25
SP/Law	\$109

PASCAL LANGUAGE	
Pascal Z	\$349/30
Pascal MT + V5.5	\$429/30
Compiler	\$316/20
SPP Only	\$140/15

KEY BITS	
Wordsearch	\$179/50
String 80	\$ 84/20
String 80 (Source)	\$279
String Bit	\$ 65

MICRO AP	
Selector IV	\$269/35
Selector V	\$469/50
SBasic	\$269/25

MICRO TAX	
*Level I	\$249
*Level II	\$995
*Level III	\$749
*Combo II + III	\$1495
Microsoft 5.3	49

MICRO PRO	
Wordstar	\$309/60
WS Training Guide	20
WS Custom Notes	\$429/na
MailMerge	\$109/25
WS-Mailmerge	\$419/85
Datastar	\$249/60
DS Custom Notes	\$429/na
Calcstar	\$259/na
Supersort I	\$199/40
Spellstar	\$175/40

MICROSOFT	
Basic-80	\$298
Basic Compiler	\$329

Fortran-80	\$349
Cobol-80	\$629
M-Sort	\$124
Macro-80	\$144
Edit-80	\$ 84
MuSimp/muMath	\$224
MuLisp-80	\$174

ORGANIC SOFTWARE	
*Textwriter III	\$111/25
*Datebook	\$269/25
*Milestone	\$269/30

PACIFIC SOFTWARE	
Sequitur	
Onyx Plexus	\$3495/NA
PDP-11	\$5000/NA

PEACHTREE SOFTWARE	
General Ledger	\$399/40
Accounts Receivable	\$399/40
Accounts Payable	\$399/40
Payroll	\$399/40
Inventory	399/40
Mailing Address for P5 Version	\$399/40 add \$119
Series 6-Peachtree	
CPA	\$799/40
Property Mgt	\$799/40
Passive Payroll	\$449/40
Series 7-Peachtree	
Sales Tracker	\$3049/55
AR-Sales Analysis	\$1299/50
Inventory	\$799/40
Order Entry	\$699/40

SOHO GROUP	
Matchmaker	\$ 97/20
Worksheet	\$177/20
SORCIM	
*Pascal/M Z80	\$349/40
*Pascal/M 86/88	\$449/40
*Act 65	\$149/20
*Act 68	
*Act 69	
*Act 86/88	\$149/25
*Trans 86	\$119/25
*SuperCalc	\$269

SOUTHERN COMPUTERS	
*Raid	\$224/35
*Raid FP	\$349/35
*FFF	\$224/15
*Recover	\$ 75
*RADAR	\$449/25
ISIS	\$224/20

STRUCTURED SYSTEMS GROUP

GL, AR, AP, PR, DE	\$849/40
--------------------	----------

Call for others	
SUPERSOFT	
*Diagnostic II	\$ 84/20
*Form	\$149/30
*SSS Fortran	\$219/30
*Fortran w/RATFOR	\$289/35
*C Compiler	\$175/20
*Disk Doctor	\$ 84/20
*Term I	\$129/25
Term II	\$169/25
Z8000 Xassembler	\$449/35

WHITESMITHS	
C Compiler	\$700/40
Pascal (incl C)	\$900/45
Cross Compiler 8080/Z80 host	
Target M68000, PDP11, 11/70, VAX	
	\$1400/50

IBM PERSONAL COMPUTER	
Wordstar 3.0	\$309/60
Mailmerge	\$109/25
Supercalc	\$269/NA
Visicalc (256K)	\$229/NA
Optimizer	\$200/NA

CP/M-86	
Supersoft C	\$500/NA
Pascal MT + 86 w/SPP	\$730/NA
CBasic-86	\$299/NA
SuperCalc	\$369/NA
SuperSoft C Compiler	\$450/NA
Wordmaster	\$Call

MISCELLANEOUS	
*dBASE II	\$575/50
Plan-80	\$269/30
*Fabs (B-Tree)	\$159/25
Ultrasort	\$159/25
*Super vxx	\$ 89/15
*Micro B+	
(Specify Language)	\$229/20
*Mini Model	\$449/50
*Spellbinder	\$349/45
*Statpak	\$439/40
*"The Word"	\$ 75
*Lynx	\$199/20

Mfg. Inventory and Control Program	
T1990, 300 Meg. storage required	
Distributed in Cobol object code	
Call for info	\$20000/NA
Write for catalog (\$1.00) and other listings	

* Available for Apple with Softcard

A

FLOPPY DISK DRIVES

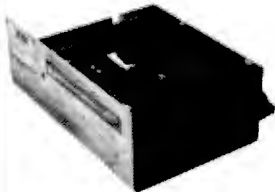

SPECIAL!!!!!! QUME DATATRAK 8

Virtually the industry standard. High quality/reliability. Full featured, double sided, double density.

Tandon TM 848. \$545

\$525 quantity 1, \$499 quantity 2 up.

TANDON DOUBLE SIDED, DOUBLE DENSITY MINIS

TM100-2 48 TPI (500 KBYTES) \$325

Compatible with Northstar, Cromemco, TRS-80

TM100-4 96 TPI (1000 KBYTES) \$425

Compatible with Zenith, Heath, etc.

TANDON 5 1/4" HARD DISKS

TM 602 (5MB) \$1195

TM 603 (10MB) \$1295

CONTROLLERS

Tarbell single density kit	\$195
Tarbell single density A & T	\$310
Tarbell double density A & T	\$425
CCS 2422 w/CPM 2.2	\$350
Godbout Disk 1	\$450
MDA MXV-21 LSI-11 controller (RX-01, RX-02 compatible)	\$1050



MISCELLANEOUS

2 Disk drive enclosure	\$ 95
(fits Siemens, Shugart, Qume)	
CP-206 power supply	\$110
(powers two floppies)	
Cable Kits	2 drives \$ 35
	3 drives \$ 40
	4 drives \$ 45
Diskettes ss	\$39/10 - ds \$59/10

Mini-Enclosure with power supply	
1 drive	\$ 85
2 drives	\$120

CPU

CCS 2810	\$ 275
Godbout Z-80A	\$ 275
Godbout 8085A	\$ 295

MEMORY

CCS 2065 64K dynamic	\$ 595
CCS 2116 32K static	\$ 625
Godbout RAM 17 64K	\$ 675

I/O

CCS 2710 4 SIO	\$ 325
Godbout Interfacer 1	\$ 225
Godbout Interfacer 2	\$ 225

NEW !!!!

Qume Sprint 9 DAISY WHEEL PRINTER . . \$2395

45 CPS, RO. Available in KSR version.

Call for further particulars.

Ribbons: \$125/case

Bidirectional tractor feed \$225

NEW !!!!

ABM 85 Video Terminal . . \$ 895

- Detachable keyboard

- Televideo 920, ADM 3A compatible

- High resolution green phosphor (23 MHZ)

- Extra multi-bus or S-100 slot for stand-alone capability

Terms of sale: cash or checks, MC/VISA. Min. order \$25. CA residents add 6% tax. Prices subject to change without notice. All goods subject to prior sale.

Electrolabs

POB 1608, Palo Alto, CA 94302 (415) 965-7040

Our Name Means a Great Deal

NEC

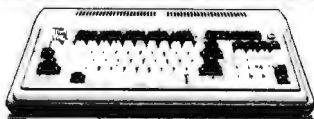

PC 8001A Microcomputer (32K) CALL
 PC 8031A Dual mini-disk drives CALL
 PC 8012A I/O unit, 32K, 7 slots 489⁰⁰
 FDC I/O port 139⁰⁰
 32K Memory Add-on card 169⁰⁰
 Ram/Tape Wedge Expansion w/32K 459⁰⁰
 NEC Software
 NEC CP/M Operating System 125⁰⁰
 FORTRAN by Microsoft 349⁰⁰
 General Accounting System 249⁰⁰
 Accounts Receivable System 249⁰⁰
 Inventory Control System 249⁰⁰
 Payroll System 249⁰⁰
 Job Cost System 249⁰⁰
 Select Word Processing w/Speller 149⁰⁰
 Report Manager 29⁰⁰
 Games Pack 1 Alien, Space War 29⁰⁰
 Games Pack 2 UFO Galaxian, Bomber 29⁰⁰
 Wordstar by Micropro 299⁰⁰

Call for prices on MicroPro packages. More software and accessories everyday.

Commodore

NEW! COMMODORE 64

8032 Computer with 32K 1079⁰⁰
 8050 Dual mini-disk 1 Mb system 1259⁰⁰
 8250 Dual mini-disk 2 Mb system 1749⁰⁰
 4022 Dot Matrix Printer 599⁰⁰
 4040 Dual Disk drive system 979⁰⁰
 16K and 32K Pet Computers CALL
 The SUPER Pet 1599⁰⁰
 Winchester Hard Disk Systems CALL
 Tax Preparation System 329⁰⁰
 Medical Accounting System 399⁰⁰
 Legal Time Accounting System 399⁰⁰
 General Ledger 289⁰⁰
 VisiCalc for CBM 189⁰⁰

We carry the complete line of CBM Hardware & Software at great prices.

ATARI



Atari 800 (16K) 679⁰⁰
 Atari 400 (16K) 329⁰⁰
 410 Program Recorder 79⁰⁰
 810 Disk Drive 439⁰⁰
 850 Interface Module 169⁰⁰
 Atari Joysticks (pair) 29⁰⁰
 Axton Ramcirom 32K module 149⁰⁰
 Atari 16K Module by Microtek 89⁰⁰
 EDU PAKS Educational Tape Series CALL
 VisiCalc for Atari (Disk) 189⁰⁰
 Pac-Man (cartridge) 34⁰⁰
 Centipede (cartridge) 34⁰⁰
 Asteroids (cartridge) 34⁰⁰
 Missile Command (cartridge) 34⁰⁰
 Star Raiders (cartridge) 39⁰⁰
 Space Invaders (cartridge) 34⁰⁰
 Cavema of Mars (disk) 34⁰⁰
 Assembler Editor (cartridge) 49⁰⁰

We carry all ATARI software and hardware.

VIC-20



\$244⁵⁰

VIC 20 Personal Computer 244⁵⁰
 VIC 1540 Single Disk Drive 489⁰⁰
 Datasette Cassette I/O unit 65⁰⁰
 VIC 1515 Graphic Printer 329⁰⁰
 VIC Super Expander 54⁰⁰
 3K Ram Cartridge 34⁰⁰
 8K Ram Cartridge 49⁰⁰
 VIC IEEE 488 interface 79⁰⁰
 VIC RS-232C Terminal interface 39⁰⁰

UMI SOFTWARE FOR VIC 20

V-Calc Viable Calculator (I/T) 11⁰⁰
 V-Check Visible Catalog (8K) (I/T) 20⁰⁰
 ViCheck - Checkbook Mgt (8K) (I/T) 18⁰⁰
 ViTerm - Dumb Terminal (I/T) 27⁰⁰
 Basic Programmers Utility ROM 39⁰⁰
 Spiders of Mars (C) 31⁰⁰
 AMOK (C) 15⁰⁰
 AMOK (I) 39⁰⁰
 Meteor Run (C) 19⁰⁰
 Alien Blitz (C) 7⁰⁰
 Alien Blitz (I) 7⁰⁰
 Simon (I) 7⁰⁰
 Kiddie Checkers (I) 7⁰⁰
 3-D Maze (I) 11⁰⁰
 Raceway (I) 11⁰⁰
 Kosmic Kamikaze (8K/I) 20⁰⁰
 Kiddie Pak I (4 Tapes) 39⁰⁰
 Super Four I (4 Tapes) 39⁰⁰
 The Alien (8K/I) 19⁰⁰
 Renaissance-Oheilo (C) CALL
 SkyMath (8K/T) 12⁰⁰
 LongDive (8K/T) 12⁰⁰
 SpaceDiv (8K/T) 12⁰⁰
 Super Hangman (8K/I) 17⁰⁰
 T Tape, C=Cartridge 8K=3K expansion

16K RamBoard

\$69⁰⁰

ASSEMBLED & TESTED
 KIT FORM \$50.00

IBM Accessories

64K Memory card by Microsoft 379
 128K memory card by 499
 192K memory card by 659
 256K memory card by 999
 64K ram chip upgrade kit 169
 Serial Async Comm. card w/1 port 129
 Serial Async card with 2 ports 249
 IBM Joysticks 54
 IBM VisiCalc (Works up to 256K) 189
 EasyWriter II Word Processor New! 279
 EasySpeller 80K word dictionary 159
 Expansion Chassis CALL
 Baby Blue Z 80 w/64K & CP/M CALL

Printers

Anadex

ANADEx DP 9501 w/2K buffer 1349⁰⁰

C. Itoh

C Itoh F 10 40 CPS (parallel) 1399⁰⁰
 C Itoh F-10 40 CPS (serial) 1450⁰⁰
 C Itoh ProWriter (parallel) 529⁰⁰
 C Itoh ProWriter (serial) 579⁰⁰

EPSON

EPSON AMERICA, INC.
 Epson MX 80 T Type III w/graphics CALL
 Epson MX 80 F T Type III w/graphics CALL
 Epson MX 82 FT Type III w/graphics CALL
 Epson MX 100 Type III w/graphics CALL

Integral Data Systems, Inc.

IDS 560G Paper Tiger 1099⁰⁰
 Prism 80 w/color 999⁰⁰
 Prism 132 w/color 1649⁰⁰
 Apple Prism color software 55⁰⁰

NEC

NEC Spinwriters (most models) CALL
 NEC 8032 Impact Dot Matrix 489⁰⁰

OKIDATA

Okidata Microline 80 (11g quan) 319⁰⁰
 Okidata 82A w/intractor 80 col 489⁰⁰
 Okidata 83A w/intractor 132 col 725⁰⁰
 Okidata 84A 132 col serial 1189⁰⁰
 Okidata 84A 132 col parallel 1029⁰⁰

SCM

Smith Corona Printer parallel 749⁰⁰

MODEMS

Novation

Hayes

Novation (All Models) CALL FOR PRICES
 Universal Data (All Models)
 D.C. Hayes (All Models)

DISKETTES

Dysan 5 1/4" (Soft 10 or 16 sectors) 10/539⁰⁰
 Dyan 8" Sgl Den Sgl Sided 10/544⁰⁰
 Verbatim 5 1/4" (Soft 10 or 16 sect) 10/529⁰⁰
 Verbatim 8" Sgl Den Sgl Sided 10/534⁰⁰
 Snatch 3M 5 1/4" (Soft 10 or 16 Sect) 10/526⁰⁰
 Sanitas above in quantity of 100 5245⁰⁰
 Scotch 3M 8" Diskettes (all types) CALL
 Scotch 3M Drive-Head Cleaning Kit (1/5, 8/1) 529⁰⁰

Accessories

Mountain Computer

Videx

Novation

16K RamBoard assembled & tested 69⁰⁰
 16K RamBoard by CCI in kit form 50⁰⁰
 SYNERGY Multi Card CALL
 Prometheus VisiCalc Card 218⁰⁰
 CPS Multi-Funktion card 189⁰⁰
 Hayes Micromodem II 289⁰⁰
 Hayes Smartmodem 245⁰⁰
 Hayes Chronograph 199⁰⁰
 Novation Apple Cat modem 319⁰⁰
 Novation Cat II Async modem 149⁰⁰
 Videx Video Term 80 column card 245⁰⁰
 Videx Keyboard Enhancer I (Orig.) 75⁰⁰
 Videx Keyboard Enhancer II 129⁰⁰
 2.80 SoftCard by Microsoft 289⁰⁰
 ThunderClock/Calendar card 119⁰⁰
 Smartterm 80 column card 289⁰⁰
 Corvus Winchester 5 Mb Disk 2950⁰⁰
 Corvus Winchester 10 Mb Disk 4295⁰⁰
 Corvus Winchester 20 Mb Disk 5195⁰⁰
 ALF 9 voice Music Card 179⁰⁰
 ALF 9 voice Music Card 149⁰⁰
 Joysticks by Keyboard Co. 44⁰⁰
 23 Key Numeric Keypad by " 115⁰⁰
 Music System (16 voices) Mountain 259⁰⁰
 A/D + D/A Interface by Mountain 279⁰⁰
 Expansion Chassis (8 slots) 569⁰⁰
 Clock/Calendar card by Mountain 228⁰⁰
 SuperTalker SD 200 by Mountain 149⁰⁰
 Rompius + card 129⁰⁰
 RomWriter card 149⁰⁰
 RamPlus 32K ram add-on (w/16K) 149⁰⁰
 Sup R-Fan 45⁰⁰
 Sup R-Terminal 80 column card 299⁰⁰
 Versawriter Digitizer Tablet 249⁰⁰
 Asynchronous Serial card by CCS 139⁰⁰
 Centronics Parallel card by CCS 119⁰⁰
 Graffiti Printer Interfaces 139⁰⁰
 SVA 2 + 2 Sgl Den 8" Disk Cont CALL
 SVA 2VX4 Megabyte/8" Disk Cont CALL
 Apple Cache 256K by SVA CALL
 IEEE 488 Interface by SSM 399⁰⁰



Micro-SCI MICRO-SCI

MICRO-SCI APPLE II COMPATIBLE DISK DRIVES

A2 with controller 469⁰⁰
 A2 w/o controller 399⁰⁰
 A40 with controller 479⁰⁰
 A40 without controller 369⁰⁰
 A70 with controller 599⁰⁰
 A70 without controller 499⁰⁰

SOFTWARE

VISICORP

VisiCalc 185⁰⁰
 VisiCalc Templates (New!) CALL
 VisiFile (Data Base Manager) 185⁰⁰
 Visi-Trend/VisiPlot 199⁰⁰
 Visi-Schedule (New!) 239⁰⁰
 Visi-Term 89⁰⁰
 Visi/Ox 185⁰⁰
 Desktop Plan II 185⁰⁰

MikroPro

WordStar by MicroPro 249⁰⁰
 MailMerge by MicroPro 85⁰⁰
 Spelt Star 149⁰⁰
 Data Star 179⁰⁰
 Galk Star 119⁰⁰

Tax Preparer by Howard Soft 119⁰⁰
 Real Estate Analyzer by 119⁰⁰
 Creative Financing by 119⁰⁰
 PFS - Personal Filing System 79⁰⁰
 PFS - Report 79⁰⁰
 DB Master 165⁰⁰
 Systems Plus Accounting Software CALL
 Peachtree Accounting Software CALL
 Continental Accounting Package ea 189⁰⁰
 Microsoft TASC Applesoft Compiler 149⁰⁰
 Microsoft Software we carry it all!
 * Requires a 2.80 Soft Card

APPLE II SPECIAL DELIVERY SOFTWARE CALL FOR PRICES

XEROX SAM



CALL FOR BEST PRICE

TERMINALS

TeleVideo

ADDS

We carry all models
 Please Call for Best Price.

consumer computers



We Bring Prices Down to Earth

Toll Free Order Line Free Shipping*

800-854-6654

Information Line
 Calif. residents and outside U.S.
714-698-8088

Ordering information. Phone orders using VISA, MASTERCARD, AMERICAN EXPRESS, DINER'S CLUB, CARTE BLANCHE, bank wire transfer, cashier's or certified check, money order or personal check allow ten days to clear. Unless prepaid with cash, please add 5% for shipping, handling and insurance (minimum 5.00). California residents add 6% sales tax. Foreign customers please add 10% for shipping (Minimum 50.00). OEM's, institutions and corporations please send for a written quotation. All equipment is subject to price change and availability without notice. All equipment is new and complete with manufacturer's warranty (usually 90 days). Showroom prices may differ from mail order prices. Send Orders to: 8336 Center Drive La Mesa, CA 92041

*prepaid cash orders
 (continental U.S. only)

Telex 695000
 Ans "Beta" Attn "CCMO"

Your FORTH 9.95

Questions Answered PPD*
30 minute audio cassette and 8-page booklet tell what FORTH is, how it works and gives pros & cons of using FORTH for all kinds of applications.

Learn FORTH 57.95

Fundamentals for PPD*
Two floppy diskettes with interactive tutorial designed to teach FORTH fundamentals quickly, easily and inexpensively. Requires CP/M operating system. CP/M is a trademark of Digital Research.

FORTH Workshops now being scheduled nationwide

For orders or information contact:

Laxen & Harris, Inc.
24301 Southland Dr., #216
Hayward, CA 94545
(415) 887-2894

*Post Paid We accept VISA, Mastercard & Checks.

Circle 215 on inquiry card.

NOT 5 MEGABYTES BUT 10!!! 10 MB Winchester Disk System S-100 \$1995 APPLE II

If you desire the speed, capacity, and reliability of Winchester technology, the ASC W10 is the system for you.

10 MB hard disk drive
Smart controller

S-100 or Apple II® computer interface
Enclosure
Power supply
All cabling
CP/M™ Auto-configuration utility

CP/M 2.2 if required is available. Special discounts on all Micropro software products (originators of Wordstar®). For additional information circle the reader service number below. Quantity discounts available.



P.O. Box 815
Lanington Park, MD 20883
(301) 353-8787
CP/M is a registered trademark of Digital Research.
Apple II is a trademark of Apple Computers.
™ Trademark of Micropro International

Circle 35 on inquiry card.

ATARI®

VIC-20 \$249	800 (16K)	649
	400 (16 K)	319
	410 Recorder	74
	810 Disk Drive	439
	822 Printer (THERMAL)	269
	825 Printer (80 COLUMN)	589
	830 Modem	149
	850 Interface	164
	853 Memory (16K)	79

ATARI SOFTWARE

4002 BASIC CARTRIDGE	45	483 THE PROGRAMMER	29
4003 ASSEMBLER EDIT	45	484 THE COMMUNICATOR	29
4006 SUPER BREAKOUT	33	404 WORD PROCESSOR	116
4007 MUSIC COMPOSER	45	405 PLOT (EDUC.)	99
4008 SPACE INVADERS	33	4106 PROGRAMMING	2
4009 COMPUTER CHESS	33	4117 PROGRAMMING	3
4011 STAR WARRIORS	37	8126 MICROSOFT BASIC	86
4012 MISSILE COMMAND	33	8121 MACRO ASSEMBLER	66
4013 ASTEROIDS	33	813 CAVERNS OF MARS	29

CALL OR WRITE FOR FREE CATALOG

COSMIC COMPUTERS

UNLIMITED
278 N. PROSPECTORS RD.
DIAMOND BAR, CA. SHIPPING EXTRA \$2 MINIMUM
91765 PRICES SUBJECT TO CHANGE
CALIF. RESIDENTS ADD TAX
OPEN 7 DAYS (714) 861-1265
Mon - 9pm

Circle 116 on inquiry card.

MICROANGELO Software

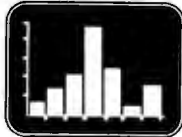

GRAPH-PAK

Fortran compatible interactive plotting package based on CALCOMP standards. Output is to MicroAngelo or to pen plotter. \$270.00
(CP/M and Microsoft Fortran-80 required)

SPRINT

Hardcopy program for MicroAngelo. Output is to I D S or EPSON graphics printers. CP/M compatible. . . . \$125.00

Laboratory Computer Systems, Inc.
139 Main Street, Cambridge, MA 02142
(617) 547-4708

© Trademark of SICOM Corp

Circle 213 on inquiry card.

C compilers and Cross compilers

Available for:

PDP-11 RT-11/RX-11
6809 SDOS/FLEX
8080 CP/M
8085 CP/M
Z80 CP/M
8086 CP/M86
8088 MSDOS CP/M86

OTHERS PENDING

The full C language, as described in "The C Programming Language" by Kernighan and Ritchie.

UNIX version 7 compatible.
Starting at \$200.00

UNIX is a trademark of Bell Labs. RT-11/RX-11 are trademarks of Digital Equipment Corp. SDOS is a trademark of Software Dynamics. CP/M is a trademark of Digital Research. FLEX is a trademark of Technical Systems Consultants

TELECON SYSTEMS
90 E. Gish Road, Suite 25
San Jose, California 95112
408-275-1659

Circle 378 on inquiry card.

Maxell Floppy Disks

The Mini-Disks with maximum quality.



Dealer inquiries invited. C.O.D.'s accepted. Call FREE (800) 235-4137.



PACIFIC EXCHANGES
100 Foothill Blvd., San Luis
San Luis Obispo, CA 93401
In Cal. call (800) 592-5935 or
(805) 543-1037

Circle 292 on inquiry card.

T.H.E. SMART TERMINAL®



Software that turns your Atari 400 or 800 into a real smart terminal. Send and receive data from all popular data services. Works with cassette or disk for upload/download. 16K min. Available at Atari Dealers Worldwide or directly from Binary. VISA/MC/AMEX/COD/CHECK. Cassette \$47.95 Disk \$49.95 add \$2.50 P & H U.S., \$5.00 overseas.

BINARY™
Computer Software
3237 Woodward Ave.
Berkley, MI 48072
(313) 548-0533
BINARY CORPORATION

Circle 48 on inquiry card.

ELIZA IS HERE!

AT LAST! A FULL IMPLEMENTATION of the original ELIZA program is now available to run on your microcomputer!

Created at MIT in 1966, ELIZA has become the world's most celebrated artificial intelligence demonstration program. ELIZA is a non-directive psychotherapist who analyzes each statement as you type it in and then responds with her own comment or question — and her remarks are often startlingly appropriate!

Designed to run on a large mainframe, ELIZA has hitherto been unavailable to personal computer users except in greatly stripped down versions lacking the sophistication which made the original program so fascinating.

Now, our new microcomputer version possessing the FULL power and range of expression of the original is being offered at the introductory price of only \$25. And if you want to find out how she does it (or teach her to do more) we will include the complete Source Program for only \$20 additional!

Order your copy of ELIZA today and you'll never again wonder how to respond when you hear someone say "Okay, let's see what this computer of yours can actually do!"

ELIZA IS AVAILABLE IN THE FOLLOWING DISK FORMATS:

- Standard 8 inch single density for all CP/M based computers \$25 for ELIZA COM - add \$20 for Microsoft BASIC-80 Source
- 5 1/4 inch CP/M for Apple II equipped with Z-80 SoftCard \$25 for ELIZA COM - add \$20 for Microsoft BASIC-80 Source
- 5 1/4 inch for 48K Apple II with Applesoft ROM and DOS 3.3 \$25 for Protected File - add \$20 for Applesoft Source
- 5 1/4 inch for 84K IBM Personal Computer \$25 for Protected File - add \$20 for BASIC Source

ARTIFICIAL INTELLIGENCE RESEARCH GROUP
921 NORTH LA JOLLA AVENUE
LOS ANGELES CALIFORNIA 90046
(213) 656-7308 (213) 656-2214
MC, VISA and CHECKS ACCEPTED

Circle 32 on inquiry card.

APPLE TREE GENEALOGY SYSTEM for your APPLE II+ Computer



- Professional-level Family Recordkeeping System
- 1000 Names (variable-length)
- Hierarchical Data-Structure
- Easy to Use
- Fast Memory-Resident Scroll
- Unique Label Control Matrix
- 100 User-Definable Fields
- The Linkage Analyzer™
- Customize Your Own Reports
- Automatic Proofreader Report
- Self-teaching Tutorial
- Backed by 4 Years Gen. Computing
- Apple II+ 48K DOS 3.3 (1 or 2 Drives)

JFSS J.Fiske Software Systems, Inc.
One University Place
New York, NY 10003

\$69.95

NYC/NYS Add Tax



Apple™ - Apple Computer
Apple Tree™/The Linkage Analyzer™ - JFSS

Circle 201 on inquiry card.

We Have It! 'till July 5, take an EXTRA 5% OFF the Prices in this ad!

SUPER COMPUTER VALUE FROM CALIFORNIA COMPUTER SYSTEMS	
4MHz, Z-80, 64K RAM, Disk Controller, C/PM 2.2	
w/dual 5 1/4" SS DD	\$2349
w/dual 5 1/4" DS DD	2599
w/dual 8" SS DD	2995
w/dual 8" DS DD	3595

INTERTEC SUPERBRAIN

Self-contained computer with dual disks and two RS232C ports. Complete with CP/M 2.2. 64K Double Density, **NEW LOW** \$2099
64K Quad Density, **NEW LOW** 2495

VIDEO TERMINALS

INTERTEC EMULATOR	\$ 749
INTERTEC INTERTUBE III	749
ZENITH Z-19	729
SOROC IQ 120	649
SOROC IQ 130	595
SOROC IQ 135	749
SOROC IQ 135G	799
SOROC IQ 140	1149
HAZELTINE ESPRIT	CALL
1420	CALL
1500	CALL
1510	CALL
1520	CALL
TELEVIDEO 910C	CALL
912C	CALL
920C	CALL
925C	CALL
950C	CALL
TEXAS INST. 940 BASIC	1599
940 Package	2079
745 Portable Terminal	1399
745 Portable Terminal w/U/L/Case	1495

PRINTERS

ANADEX DP-9500	\$1349
DP-9501	1349
PAPER TIGER IDS-560G	1139
PRISM PRINTER IDS-80, w/o color	998
IDS-80, w/color	1349
IDS-132, w/color	1695
NEC 3510, RO RS232C 36 CPS	1945
NEC 3530, RO, Centr. Inter. 35CPS	1945
NEC 7710, RO RS232C 56 CPS	2395
NEC 7720, KSR, RS232C 56CPS	2999
NEC 7730, RO, Centr. Inter. 56 CPS	2395
QUME	
Sprint 9/45, LTD. 45 CPS, RS232C	2119
C. ITOH Pro Writer, Parallel	549
Serial and Parallel	629
DIABLO 630, RS232C, 56 CPS	2299
CENTRONICS 730-1, Parallel	399
730-3, RS232C	489
739-1 w/Graphics, Parallel	525
739-3B w/Graphics, RS232C	639
704-11, Parallel	1695
704-9, RS232C	1595
122G, Parallel, 120 CPS	949
EPSON	
MX80	489
MX80FT	589
MX100FT	789
RS232 Serial Interface	65
RS232/2K BufferInterface	125
Graftrax II	90
Apple Printer Interface	75
T1810 Basic, RS232C	1349
810 Basic, RS232C & Parallel	1395
810 w/full ASCII, vertical forms control compressed print,	1599
820 RO, Basic	1645
820 KSR, Basic	1839

All prices, F.O.B. shipping point, subject to change. All offers subject to withdrawal without notice. Advertised prices reflect a 2% cash discount (order prepaid prior to shipment). C.O.D.'s and credits cards are 2% higher.

OKIDATA	
Microline 80	\$465
Tractor-feed option	59
Microline 82A	519
Microline 83A	849
Microline 84	1199

MONITORS

ZENITH-ZYM-121, 12" Green Phos.	\$125
AMDEK 100, 12"	139
100G, 12" Green Phosphor	149
300, 12" Green Phos., Hi. Res.	199
Color, 13"	359
Color II, 13", R.G.B. Hi Res.	799
Apple adapt. for R.G.B.	159
BMC, 12", Green Phosphor	169

NORTH STAR Call For Prices

FLOPPY DISK SYSTEMS

MORROW DESIGNS	
Discus 2D, single drive DD	\$898*
Dual Discus 2D, dual drive DD	1549*
Discus 2+2, double sided DD	1239*
Dual Discus 2+2	2139
*Includes CP/M 2+2 and Microsoft Basic	

HARD DISK SUBSYSTEMS

MORROW DESIGNS	
Discus M-5 5 Meg.	\$2095*
Discus M-10 10 Meg.	3095*
Discus M-20 20 Meg.	4069*
Discus M-26, 26 Meg.	3795*
CORVUS 5 Meg.	3185
10 Meg.	4545
20 Meg.	5499
KONAN David 5 Meg.	2499
10 Meg.	3049
15 Meg.	3295
INTERTEC 10 Meg.	SPECIAL \$3195
*S-100 only w/CP/M 2+2 & Microsoft Basic	

FLOPPY DISK CONTROLLER BOARDS

CROMEMCO 16FDC DD	\$499
NORTH STAR DD	479
MORROW Disk Jockey 2D, A&T	329
SD SYS. Versafloppy I, A&T	319
SD SYS. Versafloppy II, A&T	429
DELTA DD Disk Cont., A&T	345
CONDUCTOR DD, A&T	269
INTERSYSTEMS, FDC-2, A&T	439
TARBELL DD, A&T	445
SYSTEMS GROUP DD DMA	439

ESCON CONVERSION FOR IBM SELECTRIC

Complete with microprocessor controller and power supply. Factory built. User installs solenoid assembly or it can be done at ESCON Factory.

RS232 Serial & Parallel	\$534
Cable for above	25

PROM PROGRAMMERS

SSM PB1 Kit	\$152
SSM PB1, A&T	225

MODEMS

NOVATION CAT Acoustic Modem	\$149
D-CAT Direct Connect	155
AUTO-CAT Auto Ans.	219
APPLE CAT	329
USD 103 LP Direct Connect	175
103 JLP Auto Answer	209
DC HAYES MICROMODEM II (Apple)	299
MODEM 100 (S 100)	339
Smart Modem (RS 232)	239
Potomac Micro Magic (S 100)	339

CALIFORNIA COMPUTER SYSTEMS

Z80 CPU Board	\$ 269
Disk Controller 2422, w/CP/M	359
16K Static, A&T	259
32K Static, A&T	599
64K Dynamic RAM	449
System 2210 w/64K, CP/M 2.2.	1795

CPU BOARDS

(assembled unless noted)

NORTHSTAR Z-80A (ZPB-A/A)	\$269
INTERSYSTEMS (MPU-80)	349
SSM CB1 8080, A&T	214
CB2, Z-80, A&T	289
CB2, Z-80, Kit	219
DELTA Z-80 with I/O	289
SD SYSTEMS, SBC-100, A&T	349
SBC-200, A&T	399
SYSTEMS GROUP Z-80 with I/O	419

MEMORY BOARDS

NORTHSTAR 16K RAM	\$299
HRAM 64K	589
HRAM 32K	419
CROMEMCO 16KZ	419
CROMEMCO 64KZ	595
MEMORY MERCHANT	
16K Static, 4MHz	159
64K Static, 4MHz	549

SYSTEMS GROUP

(Measurement Systems & Controls)	
DM4800 48K Board	499
DM6400 64K Board	529
DMB6400 64K Board	595
INTERSYSTEMS 64K Dynamic	845

GODBOUN (A&T)

CPU Z	\$4249
CPU 8085 88	359
RAM 20 30	359
RAM 17 64	675
RAM 21	1439
Interface 1	210
Interface 2	210
Disk 1	419
System Support 1	335
Enclosure 2 (Desk)	699
Enclosure 2 (Rack)	760

VIDEO BOARDS I/O Mapped

SD SYSTEMS	
VDB-8024, A&T	\$469
SSM VB2 I/O, Kit	169
VB2 I/O, A&T	229
MEMORY MAPPED	
VB1C, 16x64, Kit	152
VB1C, 16x64, A&T	206
VB3, 80 Char. 4MHz, Kit	359
VB3, 80 Char. 4MHz, A&T	419

APPLE BOARDS

CALIFORNIA COMPUTER	
7710A Asynchronous Ser Interface	\$129
7712A Synchronous Der Interface	149
7424A Calendar Clock	99
7728A Centronics Printer Interface	99

MOUNTAIN HARDWARE

CPS Multifunction Board	\$199
Supertalker SD200	259
Romplus w/ keyboard filter	179
Romplus w/o keyboard filter	130
Keyboard filter ROM	49
COPYROM	49
Music System	459
ROMWRITER	149
Apple Clock	239
A/D/D/A	295
Expansion Chassis	625
VISTA	
8" Disk Controller (Apple II)	\$495

MiniMicroMart, Inc.

943 W. Genesee St. P.O. Box 2991B Syracuse, N.Y. 13220 (315) 422-4467 TWX 710-542-0431

Expansion Memory

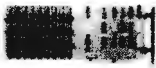

for

The IBM Personal Computer

- Parity generation & checking
- Fully assembled, quality tested
- One year warranty

PART. NO.	UNIT	PRICE
AIM-256-01B	64KB	\$349.
AIM-256-02B	128KB	\$499.
AIM-256-03B	192KB	\$639.
AIM-256-04B	256KB	\$769.
AIM-256-00B	Bare board, Bracket & Schematic	\$ 99.
AIM-256-09B	64KB EXP. KIT	\$149.

ADD \$4.00 FOR SHIPPING AND HANDLING

APSTEK, INC.

P.O. Box 5306

Richardson, TX 75080

(Texas residents add applicable sales tax)

VISA, M/C 24hr. order line

(817) 571-7171

Dealer inquiries invited

Circle 30 on inquiry card.

YOU CAN SAVE \$\$\$

5 1/4" DISKETTES (Soft or Hard Sector) Box of 10
Single Side/Double Density \$25.25
Double Side/Double Density \$31.25

Altos • North Star • Zenith Data Systems

RIBBONS FOR:

Anadex DP 9500/9501	\$14.00
Centronics 700 Series		
Zip Pack (Package of 3)	\$ 8.25
Cartridge	\$ 8.50
D.E.C. LA-34 (Box of 6)	\$30.00
Diablo 630 (Box of 6)	\$25.90
Epson MX 70-80	\$12.95
NEC Spinwriter (Box of 6)	\$24.00
Okidata Microline 80 (Pkg of 3)	\$ 8.90
Qume (Boxes of 6)		
(Black)	\$19.00
(Red, Green, Blue or Brown)	\$16.00
Texas Instruments 810 (Bx of 6)	\$19.00

Plus many others - Call for more information

CHECK - MASTER CARD - VISA Accepted

Add \$3.00 for Shipping & Handling:

Illinois Residents Add 6% Tax

ILLINOIS COMPUTER PRODUCTS CO.

P.O. Box 112

Mt. Prospect, IL 60056 (312) 228-5590

Circle 181 on inquiry card.



Scotch

DISKETTES

SAVE 40% Write for our complete list.

5 1/4" Specify soft, 10 or 16 sector	Price/10
#744 1 side/sgl dens \$26.70
#744D 1 side/dbl dens 31.20
#745 2 sides/dbl dens 38.40

8" Specify soft or 32 sector	
#740 1 side/sgl dens 27.30
#741 1 side/dbl dens 35.80
#743 2 sides/dbl dens 43.80

CHECKS - VISA - MC - C.O.D.
(313) 777-7780 ADD \$2 SHIPPING

LYBEN COMPUTER SYSTEMS
27204 Harper Ave.
St. Clair Shores, MI 48081

Authorized Distributor
Information Processing Products



Circle 222 on inquiry card.

MICROPROCESSOR CRYSTALS

1 000	1 8432	2 000	3 2768	MHz	3.00 each
3 5795	4 000	4 1934	4 9152	5 000	
5 0688	6 000	6 144	6 400	7 3728	
8 000	10 000	14 31818	18 000	19 6608	
20 000	22 1184	32 000	MHz		2.00 each

TUNING FORK CRYSTALS (3mm x 8mm Miniature)

32 768 KHz	1.00 each
30 40KHz	inquire

80Hz CRYSTAL TIME BASE

Assembled	5.00 each
Kit	4.00 each

We also carry BECKMAN PRODUCTS, please inquire:

D/A A/D Converters Resistor Networks
Trimming Potentiometers Precision Potentiometers
Displays Digital Multimeters

BET ACQUAINTED OFFER:

BECKMAN DMM TECH 300	110.00 each
BECKMAN DMM TECH 310	135.00 each
BECKMAN DMM TECH 330	185.00 each

Add sales tax in California Postage 5% of total order (\$1.00 minimum) Insurance \$1.50

SIGMATEK INTERNATIONAL CORPORATION
327 Clarkin Ct., Walnut Creek, CA 94598
P.O. Box 5007, Concord, CA 94520

Circle 350 on inquiry card.

Design Line Micro Work Stations



RETAIL
PRICE
\$185

- A complete range of work stations designed specifically to house all micro-computers.
- Delivered heavily packed, in self-assembly form needing only a Phillips screwdriver and a few minutes of your time to assemble
- Manufactured from 1" all wood particle board surfaced with hard-wearing melamine veneer, in either Oak or Walnut
- Dealer and Distribution prices on request
- For more information on our full range of work stations write or call 301-223-8900.

ATLANTIC CABINET CORPORATION

P. O. Box 100, Williamsport, Maryland 21795

Circle 38 on inquiry card.

Compuchange

Such A Deal!

Have You Ever Considered
USED EQUIPMENT?

Want To Save Lots?
We Carry All Brands of
Used Minis and Micros*
(DEC - DG - APPLE - TRS-80, ETC.)

Call or Write for FREE List of Bargains:

Compuchange
Box 4151
Anaheim, Ca. 92803
(714) 535-1990

*No Cost or Obligation
To List with Us!
Call for More Info!

Circle 87 on inquiry card.

TYPESETTING from your own COMPUTER

Type your manuscripts, catalogs, or other text into your word processing computer.

Send it to us on a diskette or via a modem transmission and we'll send you camera ready film copy.

Computer typesetting provides high quality, easy to read copy at a fraction of the cost of conventional typesetting.

Call or write for instructional brochure that includes typeset selections, formatting instructions, and examples.

Dream Electronics

131 N.W. 2nd. St. 1-503-7524833
Corvallis, Oregon 97330

Circle 142 on inquiry card.

JULY SPECIALS

MCP/SCC-6 SIX MHz Z80 S-100 CPU 2.4 or 6 MHz	\$275.00
Two serial, three parallel ports, 2K EPROM, 1K Ram.	
MCP/SCC FOUR MHz Z80 S-100 CPU 2 or 4 MHz	\$225.00
Can be upgraded to 6 MHz	
MCP/SCC DUAL DENSITY S-100 FLOPPY DISK INTERFACE	\$288.00
Supports single or double sided 5 1/4" floppy disk drives.	
MCP/SCC 8024 VIDEO DISPLAY CONTROLLER	\$225.00
Features 8845 CRT controller and strobed keyboard port.	
MCP 64K S-100 STATIC RAM BOARD	\$440.00
Uses 2K x 8 H6116 or DMN2016 static ram.	
(WITH 64K 150NS RAM)	\$385.00
(WITH 48K 150NS RAM)	\$365.00
(WITH 32K 150NS RAM)	\$320.00
MCP MICROPROCESSOR PERFORMANCE S-100 package	\$995.00
Includes MCP/SCC-6 CPU, CP/SCC DD Floppy, CP/M 2.2	\$895.00
Interface MCP 64Ks with 64K ram.	without CP/M 2.2

Circle 237 on inquiry card.

HY-TYPE 1 & 11 • QUME

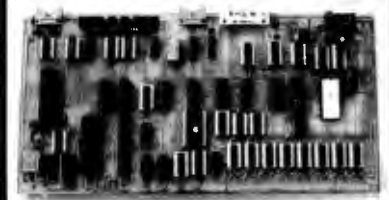

INTELLIGENT PRINTER INTERFACE

16,000 BYTE BUFFER / STAND ALONE
PARALLEL / SERIAL INPUT (BAUD RATES - 50 to 19,200)
OPTIONS INCLUDE: GRAPHICS • REVERSE PRINT • BOLD PRINT
UNDER-SCORE • REPRINT OF BUFFER
ADJUSTMENT OF LINES PER INCH
CHARACTERS PER-INCH SELECTION
DOUBLE LINE

CUSTOM OPTIONS ALSO AVAILABLE

A & T FROM \$450.00 BARE BOARD \$125.00

MASTER CARD & VISA ACCEPTED

WARN ELECTRONICS, LTD.

PO BOX 526 KNIGHTDALE, NC 27545 (919) 266-9411

Circle 399 on inquiry card.

FOR ONLY \$129.95 Learn Computing From The Ground Up

Build a Computer kit that grows with you, and can expand to 64k RAM, Microsoft BASIC, Text Editor/Assembler, Word Processor, Floppy Disks and more.

EXPLORER/85

Here's the low cost way to learn the fundamentals of computing, the all-important basics you'll need more and more as you advance in computer skills. For just \$129.95 you get the advanced-design Explorer/85 motherboard, with all the features you need to learn how to write and use programs. And it fits right into a system that is a match for any personal computer on the market. Look at these features: 8085 Central Processing Unit, the microprocessor "heart" of the Explorer/85 (Join the millions who will buy and use the 8085/8088 this year alone!). Four 8-bit parallel ports for input/output devices from which you can input and output your programs, as well as control exterior switches, relays, lights, etc. a cassette interface that lets you store and reload programs you've learned to write. A deluxe 2,000 byte operating system/monitor makes it easy to learn computing in several important ways. It allows simpler, faster writing and entering of programs. It permits access by you to all parts of the system so you can check on the status of any point in the program. It allows tracing each program step by step, with provision for displaying all the contents of the CPU (registers, flags, etc.) and it does much more!

You get all this in the starting level (Level A) of the Explorer/85 for only \$129.95. Incredible! To use, just plug in your 8VDC power supply and terminal or keyboard/display — if you don't have them see our special offers below.

Level A computer kit (Terminal Version) \$129.95 plus \$3 P&I *
Level A kit (Hex Keypad/Display Version) \$129.95 plus \$3 P&I *

LEVEL B — This "building block" converts the motherboard into a two-slot S100 bus (industry standard) computer. Now you can plug in any of the hundreds of S100 cards available.

Level B kit \$49.95 plus \$2 P&I *
S100 bus connectors (two required) \$4.85 each, postpaid

LEVEL C — Add still more computing power: this "building block" mounts directly on the motherboard and expands the S100 bus to six slots.
Level C kit \$99.95 plus \$2 P&I *

S100 bus connectors (five required) \$4.85 each, postpaid

LEVEL D — When you reach the point in learning that requires more memory we offer two choices: either add 4k of a memory directly on the motherboard and add 16k to 64k of memory by means of a single S100 card, our famous "JAWS" — see above.

Level D kit (CHECK ONE) 4k on board \$49.95 plus \$2 P&I * 16k S100 "JAWS" \$149.95 plus \$2 P&I * 32k S100 "JAWS" \$199.95 plus \$2 P&I * 64k S100 "JAWS" \$249.95 plus \$2 P&I * 8k S100 "JAWS" \$299.95 plus \$2 P&I *

LEVEL E — An important "building block," it activates the 8k ROM/EPROM space on the motherboard. Now just plug in our 8k Microsoft BASIC or your own custom programs.
Level E kit \$6.95 plus 50¢ P&I *

Microsoft BASIC — It is the language that allows you to talk English to your computer. It is available three ways: 8k cassette version of Microsoft BASIC (requires Level B and 12k of RAM minimum, we suggest a 16k S100 "JAWS" — see above) \$94.95 postpaid 8k ROM version of Microsoft BASIC (requires Level B and Level E and 4k RAM, just plug into your Level E sockets. We suggest either the 4k Level B RAM expansion or a 16k S100 "JAWS" — see above) \$99.95 plus \$2 P&I *

Disk version of Microsoft BASIC (requires Level B, 32k of RAM, floppy disk controller, 8" floppy disk drive) \$329.95 postpaid

TEXT EDITOR/ASSEMBLER — The editor/assembler is a software tool (a program) designed to simplify the task of writing programs. As your programs become longer and more complex, the assembler can save you many hours of programming time. This software includes an editor program that enters the programs you write, makes changes, and saves the programs on cassettes. The assembler performs the task of translating symbolic code into the computer readable object code. The editor/assembler program is available either in cassette or a ROM version.

Editor/Assembler (Cassette version requires Level B and 8k (min) of RAM (we suggest 16k "JAWS" — see above) \$99.95 plus \$2 P&I *
Editor/Assembler (ROM version supplied on an S100 card, requires Level B and 4k RAM (min) — we suggest either Level D or 16k "JAWS") \$99.95 plus \$2 P&I *

8" FLOPPY DISK — A remarkable "building block" that adds 8" floppy disk when you need faster operation, more convenient program storage, perhaps a business application and access to the literally thousands of programs and program languages available today. You simply plug them into your Explorer/85 disk system — it accepts all IBM formatted CP/M programs.

8" Floppy Disk Drive \$499.95 plus \$12 P&I *
Floppy Controller Card \$199.95 plus \$2 P&I *
Disk Drive Cabinet & Power Supply \$99.95 plus \$3 P&I *

Drive Cables (set up for two drives) \$25.00 plus \$1.50 P&I *

CP/M 2.2 Disk Operating System includes Text Editor/Assembler, dynamic debugger, and other features that give your Explorer/85 access to thousands of existing CP/M-based programs \$150.00 postpaid

NEED A POWER SUPPLY? Consider our AP-1. It can supply all the power you need for a fully expanded Explorer/85 (note: disk drives have their own power supply). Plus the AP-1 fits neatly into the attractive Explorer steel cabinet (see below).

AP-1 Power Supply kit (8V @ 5 amps) in deluxe steel cabinet \$39.95 plus \$2 P&I *

NEED A TERMINAL? We offer you choices: the least expensive one is our Hex Keypad/Display kit that displays the information on a calculator type screen. The other choice is our ASCII Keyboard/Computer Terminal kit that can be used with either



4 Plug in Level E. Here, it accepts Microsoft BASIC or Editor/Assembler in ROM.
5 Add two S100 boards.
6 Add your own custom programs (printing, etc.).
7 Connect terminal.

1 Plug in Netronics's Hex Keypad/Display.
2 Add Level B in convert to S100.
3 Add 4k RAM

• CRT monitor or a TV set (if you have an RF modulator).
 Hex Keypad/Display kit \$99.95 plus \$2 P&I *

FASTERM-64 TERMINAL KIT — Featuring a 56 key ASCII Keyboard, 128 character set upper and lower case, 75 ohm output, 8 baud rates, 150 to 190 200 (switch select) RS232C or 20 MA output, 32 or 64 character by 16 line formats, complete with Deluxe Steel Cabinet and Power Supply \$199.95 plus \$3 P&I *

RF Modulator kit (allows you to use your TV set as a monitor) \$6.95 postpaid

12" Video Monitor (10MHz bandwidth) \$139.95 plus \$5 P&I *

Deluxe Steel Cabinet for the Explorer/85 \$49.95 plus \$3 P&I *

Fan for cabinet \$15.00 plus \$1.50 P&I *

ORDER A SPECIAL-PRICE EXPLORER/85 PAK — THERE'S ONE FOR EVERY NEED.

Beginner Pak (Save \$26.00) — You get Level A (Terminal Version) with Monitor Source Listing (\$25 value) AP-1 5-amp power supply Intel 8085 Users Manual (Reg. \$199.95) SPECIAL \$199.95 plus \$4 P&I *

Explorer Pak (Save \$53.40) — You get Level A (Hex Keypad/Display Version) with Hex Keypad/Display Intel 8085 User Manual, Level A Hex Monitor Source Listing, and AP-1 5-amp power supply (Reg. \$279.95) SPECIAL \$226.55 plus \$6 P&I *

Special Microsoft BASIC Pak (Save \$103.00) — You get Levels A (Terminal Version), B (D 4k RAM), E (8k Microsoft in ROM, Intel 8085 User Manual, Level A Monitor Source Listing, and AP-1 5-amp power supply (Reg. \$629.70) SPECIAL \$526.70 plus \$7 P&I *

Add a Rom-Version Text Editor/Assembler (Requires levels B and D or S100 Memory) \$99.95 plus \$2 P&I *

Starter 8" Disk System — Includes Level A, B floppy disk controller, one CDC 8" disk-drive two-drive cable, two S100 connectors, just add your own power supplies, cabinets and hardware. (Reg. \$1065.00) SPECIAL \$999.95 plus \$13 P&I * 32k Starter System, \$1164.95 plus \$13 P&I * 48k Starter System, \$1369.95 plus \$13 P&I * 64k Starter System, \$1549.95 plus \$13 P&I *

Add to any of above Explorer steel cabinet, AP-1 five amp power supply, Level C with two S100 connectors, disk drive cabinet and power supply, two sub-D connectors for connecting your printer and terminal (Reg. \$225.95) SPECIAL \$199.95 plus \$3 P&I *

Complete 64k System, Wired & Tested \$1690.00 plus \$26 P&I *

Special Complete Business Software Pak (Save \$625.00) — Includes CP/M 2.2 Microsoft BASIC, General Ledger, Accounts Receivable, Accounts Payable, Payroll Package (Reg. \$1325) SPECIAL \$699.95 postpaid

*P&I stands for "postage & insurance." For Canadian orders, double this amount.

Continental Credit Card Buyers Outside Connecticut

TO ORDER
Call Toll Free:
800-243-7428

To Order From Connecticut, or For Technical Assistance, Call (203) 354-9375

CP/M is a reg. trademark of Digital Research

★ (Clip and mail entire ad) ★

SEND ME THE ITEMS CHECKED ABOVE
Total Enclosed (Conn. Residents add sales tax): \$ _____
Paid by:

Personal Check Cashier's Check/Money Order

VISA MASTER CARD (Bank No. _____)

Acct. No. _____ Exp. Date _____

Signature: _____

Print Name: _____

Address: _____

City: _____

State: _____ Zip: _____

ANNOUNCING TWO NEW TERMINALS

Smart • Fast • Graphics • Matching Modem and \$295 Printer

Netronics announces a state of the art breakthrough in terminals. Now at prices you can afford, you can go on-line with data-bank and computer phone-line services. It's all yours: "electronic newspapers," educational services, Dow-Jones stock reports, games, recipes, personal computing with any level language, program exchanges, electronic bulletin boards... and more every day!!!

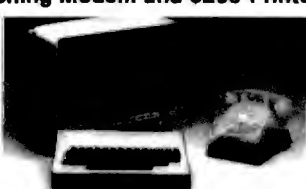

Netronics offers two new terminals. Both feature a full 56 key/128 character typewriter-style keyboard, baud rates to 19.2 kilobaud, a rugged steel cabinet and power supply. The simplest one, FASTERM-64, is a 16 line by 64 or 32 character per line unit, with a serial printer port for making hard copy of all incoming data, and optional provisions for block and special character graphics. The "smart" version, SMARTERM-80, features either 24 line by 80 characters per line or 16 by 40 characters per line, it offers on-screen editing with page-at-a-time printing, 12,000 pixel graphics, line graphics, absolute cursor addressing, underlining, reverse video one-half intensity and much more... simply plug them into your computer or our phone modem and be on-line instantly. Use your TV set (RF modulator required) or our deluxe green-phosphor monitor pictured above. For hard copy just add our matched printer.

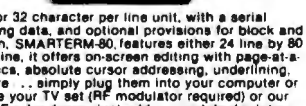

Price breakthrough!!! Own the FASTERM-64, a complete terminal kit, ready to plug in for just \$199.95 or order the SMARTERM-80 kit for just \$299.95, (both available wired and tested.) Be on-line with the million-dollar computers and data services today... we even supply the necessary subscription forms.

More good news: All the components in our terminals are available separately (see coupon), so you buy only what you need!!!

FASTERM-64... DISPLAY FORMAT: 64 or 32 characters/line by 16 lines... 96 displayable ASCII characters (upper & lower case) 8 baud rates: 150, 300, 600, 1200, 2400, 4800, 9600, 19,200 (switch sel)... LINE OUTPUT: RS232C or 20 ma current loop... VIDEO OUTPUT: 1V P/P (EA RS-170)... CURSOR MODES: home & clear screen, erase to end of line, erase cursor line, cursor up & down, auto carriage return/line feed at end of line & auto scrolling.

REVERSE VIDEO... BLINKING CURSOR... PARITY: off, even or odd... STOP BITS: 1, 1.5, 2... DATA BITS PER CHARACTER: 5, 6, 7 or 8... CHARACTER OUTPUT: 5 by 7 dot matrix in a 7 by 12 cell... PRINTER OUTPUT: prints all incoming data... 1K ON BOARD RAM... 2K ON BOARD ROM... CRYSTAL CONTROLLED... COMPLETE WITH POWER SUPPLY... OPTIONAL GRAPHICS MODE: includes 34 Greek & math characters plus 30 special graphics characters... ASCII ENCODED KEYBOARD: 56 key/128 characters

SMARTERM-80... DISPLAY FORMAT: 80 characters by 24 lines or 40 characters by 16 lines 128 displayable ASCII characters (upper & lower case) 8 baud rates: 110, 300, 600, 1200, 2400, 4800, 9600, 19,200... LINE OUTPUT: RS232C or 20 ma current loop... VIDEO OUTPUT: 1V P/P (EA RS-170)... EDITING FEATURES: insert/delete line, insert/delete character, forward/back tab... LINE OR PAGE TRANSMIT... PAGE PRINT FUNCTION... CURSOR POSITIONING: up, down, right, left, plus absolute cursor positioning with read back... VISUAL ATTRIBUTES: underline, blink, reverse video, half intensity, & blank... GRAPHICS: 12,000 pixel resolution block plus line graphics... ON-SCREEN PARITY INDICATOR... PARITY: off, even or odd... STOP BITS: 110 baud 2, all others 1... CHAR. OUTPUT: 7 by 11 character in a 9 by 12 block... PRINTER OUTPUT: 60 OR 50 Hz VERTICAL REFRESH... BLINKING BLOCK CURSOR... CRYSTAL CONTROLLED... 2K ON BOARD RAM... ASCII ENCODED KEYBOARD: 56 key/128 character... 4K ON BOARD ROM... COMPLETE WITH POWER SUPPLY.

TELEPHONE MODEM 103 O/A... FULL DUPLEX, FCC APPROVED... DATA RATE: 300 baud... INTERFACE: RS232C and TTY... CONTROLS: talk/data switch (no need to connect and disconnect phone), originate/answer switch on rear panel... NO POWER SUPPLY REQUIRED.

ASCII KEYBOARD ASCII-3... 56 KEY/128 CHARACTER ASCII ENCODED... UPPER & LOWER CASE... FULLY DEBOUNCED... 3 KEY ROLL-OVER... POS OR NEG LOGIC WITH POS STROBE... 5 KEYPRES + 5 -12V DC (SUPPLIED FROM VIDEO BOARDS)

PRINTER COMET I... SERIAL I/O TO 9600 BAUD... 80 CHARACTER COLUMN (132 COMPRESSED)... 10" TRACTOR FEED... UPPER/LOWER CASE... INDUSTRY STANDARD RIBBONS

4 CHARACTER SIZES... 9 BY 7 DOT MATRIX... BI-DIRECTIONAL PRINTING



Continental U.S.A. Credit Card Buyers Outside Connecticut
CALL TOLL FREE 800-243-7428

To Order From Connecticut Or For Tech. Assist. Call (203) 354-9375
NETRONICS R&D LTD. Dept.
333 Litchfield Road, New Milford, CT 06776

Please send the items checked below:

COMPLETE FASTERM-64 TERMINAL (Includes FASTVID-64 video board ASCII-3 keyboard, steel cabinet and power supply)... kit \$199.95 plus \$3 P&I... wired & tested \$249.95 plus \$3 P&I... graphics option: add \$19.95 to each of above

COMPLETE SMARTERM-80 TERMINAL (Includes SMARTVID-80 video board, ASCII-3 keyboard, steel cabinet and power supply)... kit \$299.95 plus \$3 P&I... wired and tested \$399.95 plus \$3 P&I

FASTVID-64 VIDEO BOARD (requires +5 & -12V DC)... kit \$99.95 plus \$3 P&I... graphics option add \$19.95... wired & tested \$129.95 plus \$3 P&I... graphics option add \$19.95

SMARTVID-80 VIDEO BOARD (requires +5 & +/-12V DC)... kit \$199.95 plus \$3 P&I... wired & tested \$249.95 plus \$3 P&I

DELUXE STEEL TERMINAL CABINET... \$19.95 plus \$3 P&I

ASCII-3 KEYBOARD (requires +5 & -12VDC)... kit \$89.95 plus \$3 P&I... wired and tested \$99.95 plus \$3 P&I

POWER SUPPLY (powers ASCII-3 keyboard & video boards)... kit only \$19.95 plus \$2 P&I

ZENITH VIDEO MONITOR (high resolution green phosphor)... wired & tested \$149.95 plus \$6 P&I

TELEPHONE MODEM MODEL 103 O/A... wired & tested \$189.95 plus \$3 P&I

DOT MATRIX PRINTER Comet I... wired & tested \$299.95 plus \$10 P&I

RF MODULATOR MOD RF-1... kit only \$8.95 plus \$1 P&I

3FT-25 LEAD MODEM/TERMINAL OR PRINTER/TERMINAL CONNECTOR CABLE... \$14.95 ea plus \$2 P&I

For Canadian orders, double the postage. Conn. res. add sales tax.

NETRONICS Research & Development Ltd.

333 Litchfield Road, New Milford, CT 06776

LABELS

299

perM

15/16"x3 1/2" white pressure
1 up - pin feed sensitive

PRICE INCLUDES SHIPPING
Packed 5M per box - Min. order 1 box - \$14.95
Check with order - Mass Residents add 5% Sales Tax



CHECK-MATETM
P.O. Box 103, Randolph, MA 02368
Telephone: 617-963-7894
CALL TOLL FREE 1-800-343-7706

Circle 73 on inquiry card.

IEEE-488 TO TRS-80* INTERFACE
Everything needed to add powerful BASIC GPIB-488 controller capability to TRS-80 Model 1 or 3, Level 2 or DOS with a minimum of 16K.



488-80C For Model 3 Operation
488-80B For Model 1 Operation

Model 488-80B or 488-80C Price: \$375.
+ shipping, insurance & tax
WHEN ORDERING SPECIFY DISK OR TAPE

SCIENTIFIC ENGINEERING LABORATORIES
11 Neil Drive • Old Bethpage, NY 11804
Telephone: (516) 694-3370

*Trademark of Tandy Corp.
There is no affiliation between Scientific Engineering Laboratories and Tandy Corp. or Radio Shack

Circle 342 on inquiry card.

\$GOLD DISKS

CP/M® Compatible

Z-80 Software

Z-80 DISASSEMBLER

An easy to use program to create source (.ASM) files from executable (.COM) files

\$175

PPD

EZ-TEXT WORDPROCESSOR

EZ-TEXT will format your text file the way you want it

\$75

PPD

Bower-Stewart & Associates

POST OFFICE BOX 1389
HAWTHORNE, CALIFORNIA 90250

213-532-1237

MasterCard

Trademark Digital Research

Circle 58 on inquiry card.

LOOK TO THE FUTURE...

EPROM-32

The only EPROM programmer you need!

- IEEE-696 (S-100) EPROM programmer for single supply (+5V) EPROMs.
- Programs current 1K through 16K (byte) EPROMs plus future 32K EPROMs
- EPROM can be verified through a port or located in memory space for verification and use.
- Personality Modules adapt board to different EPROM types
PM-1 - 2508 2758 PM-3 - 2732 2732A PM-6 - 68764
2516 2716 PM-4 - 2564 PM-7 - 2528
PM-2 - 2532 PM-5 - 2764 PM-8 - 27128
- Single zero-insertion-pressure socket accommodates both 24-pin and 28-pin EPROM packages
- On-board DC-to-DC converter with adjustable regulator for programming voltage
- Double-sided PC board with solder masks silkscreen and gold-plated contact fingers
- 8080/280 control software includes commands for programming, verification, disk I/O and editing
- Comprehensive user's manual contains source listing of control software

MicroDynamics **\$269.95**
(assembled & tested)

Price includes EPROM-32, documentation and two Personality Modules (specify). Additional Modules - \$7.95
Control software on 8 inch single density CP/M-compatible diskette - \$9.95.

Corporation
P.O. Box 17577
Memphis, TN 38117
(901)-755-0619

MasterCard & Visa TN residents add 6% sales tax.

Circle 259 on inquiry card.



Dysan CORPORATION

Solve your disc problems, buy 100% surface tested Dysan diskettes. All orders shipped from stock, within 24 hours. Call toll FREE (800) 235-4137 for prices and information. Visa and Master Card accepted.



PACIFIC EXCHANGES
100 Foothill Blvd
San Luis Obispo, CA
93401 (In Cal. call
(805) 543-1037.)

Circle 292 on inquiry card.

5 1/4" Floppy Disk Drives

(Direct IBM Plug in)

TANDON Model TM 100-1 \$219.95* ea.
2 or more - \$214.95 ea *
Floppy Drive Power Connector Kit ... \$2.00*
Tandon Manual and Schematic \$3.00*
12" Green Phosphor Zenith Monitor \$119.95*

We also stock TM-100-2's, the TM 602S, 603S, and the 603E Winchester Drives.

CALL NOW - TOLL FREE
800-824-7888 all states except CA
800-852-7777 for CA residents.
Ask for Operator #99.

MC/VISA or C.O.D. with certified check or money order. Kansas residents add 3% sales tax

*Plus shipping.
For info call: 316-683-9225
316-685-9445



gh computer systems
923 Longfellow Street
Wichita, KS 67207

Circle 169 on inquiry card.

RS-232 PROBLEMS?



LET THE RS-232 TESTER HELP YOU SOLVE YOUR COMPUTER INTERFACE PROBLEMS. DESIGNED TO CONNECT IN SERIES WITH ANY RS-232 INTERFACE, IT DISPLAYS THE STATUS OF SEVEN OF THE MOST IMPORTANT LINES: TRANSMIT DATA, RECEIVE DATA, REQUEST TO SEND, CLEAR TO SEND, DATA SET READY, CARRIER DETECT, AND DATA TERMINAL READY. THE RS-232 TESTER REQUIRES NO POWER AND MAY BE LEFT IN THE LINE PERMANENTLY.

\$39.95 POST PAID
B & B ELECTRONICS
BOX 475/MENDOTA, IL 61342

Circle 41 on inquiry card.

YOU CAN PAY MORE BUT YOU CAN'T GET MORE!



Color Computer 4K
\$310
w/16K Ext. Basic
\$459
w/32K Ext. Basic
\$525

Model III 16K
\$839
Model III 48K
2 disc & RS232C
\$2059

BUY DIRECT. These are just a few of our great offers which include Printers, Modems, Computers, Peripherals, Disc Drives, Software and more. **CALL TOLL FREE 1-800-343-8124**

We have the lowest possible fully warranted prices and a full complement of Radio Shack Software.

computer plus
Write for your free catalog.
245A Great Road
Littleton, MA 01460
617 • 486 • 3193

Circle 97 on inquiry card.

ZENITH/Heath Users



Double Your 5 1/4" disk storage capacity without adding a drive.

Get twice as much from your H88 or H89 microcomputer. Our FDC-880H floppy disk controller, in conjunction with your 5 1/4" drives, for example, expands memory capacity from 256 bytes to 512 bytes per sector.

And it handles single and double-sided, single and double-density, 8" and 5 1/4" drives - simultaneously.

Call 714/275-1272 today or write for details.



C.D.R. Systems Inc.
Controlled Data Recording Systems, Inc.
7667 Vickers St., San Diego, CA 92111

Circle 89 on inquiry card.

WE WILL NOT BE UNDERSOLD

SOFTWARE

MICROPRO	
Wordstar	\$319
Mailmerge	\$109
Wordstar/Mailmerge	\$419
Customization Notes	\$399
MICROSOFT	
Basic Interpreter	\$349
Basic Compiler	\$389
Fortran 80	\$499
Cobol 80	\$695
DATA BASE	
FMS80	\$595
dBase II	\$599
MISCELLANEOUS	
Computer Station	
Graphics Dump	\$39.95
SuperCalc®	\$269
Personal Filing System	\$75
PFS Report Writer	\$75
INFORMATION UNLIMITED for the	
IBM Personal Computer	
Easywriter II	NEW! \$299
Easyspeller II	NEW! \$149
Easyfiler	NEW! \$329

APPLE SOFTWARE

MICROPRO	
Wordstar	\$269
MailMerge	\$99
Wordstar/Mailmerge	\$349
Spellstar	\$149
VISICORP	
VisiCalc™	\$199
VisiTerm™	\$79
VisiDex™	\$199
VisiPlot™	\$169
VisiFile™	\$199
VisiSchedule™	\$259
VisiTrend/Plot™	\$239
VisiPac™	\$539
MISCELLANEOUS	
Micro Courier	\$219
Screenwriter II	\$129
ENTERTAINMENT	
Wizard and Princess	\$29
Raster Blaster	\$26
Space Eggs	\$26
Twerps	\$28
Borg	\$28
Castle Wolfenstein	\$27
Beer Run	\$28
Epoch	\$32
Sneakers	\$27
Midnight Magic	\$32
Wizardry	\$45
Time Zone	\$79
Ghost Hunter	\$29
Jawbreaker	\$20

TERMINALS

ADDS Viewpoint	\$569
Zenith Z-19	\$689
Televideo 910	\$595
Televideo 920	\$769
Televideo 925	\$779
Televideo 950	\$969

For fast delivery, send certified checks, money orders, or call to arrange direct bank wire transfers. Personal or company checks require one to three weeks to clear. All prices are mail order only and are subject to change without notice. Call for shipping charges.

APPLE ACCESSORIES

Z-80 Card by Microsoft	\$319
16K Card by Microsoft	\$159
32K Card by Saturn	\$199
Keyboard Enhancer II by Videx	\$125
Videoterm by Videx	\$259
Game Paddles by TG	\$49
Joystick by TG	\$49
Numeric Keypad by	
Keyboard Co.	\$139
Sup-R-Mod	\$25
Sup-R-Fan	\$39
ALF 9 Voice Board	\$159
Station II by Trace Systems	\$119
APPLE INTERFACE CARDS BY CCS	
Parallel #7720	\$119
Centronics #7728	\$115
Serial Asynch. #7710	\$139
Serial Synch. #7712	\$149
ADVANCED LOGIC	NEW!
Add-Ram 16K Card	NEW! \$119
Z-Card CP/M for the	
Apple II	NEW! \$225
Smarterm 80 Column Board	
with Softswitch	NEW! \$249
The Synergizer	
All of the above plus	
"The CP/M Handbook"	NEW! \$599

DISK DRIVES

CCI 100 for the TRS-80 Model 1	
5 1/4 40 track	\$299
CCI 189 for the Zenith Z-89	
5 1/4 40 track	\$379
Corvus 5M with Mirror	\$3089
Corvus 10M with Mirror	\$4489
Corvus 20M with Mirror	\$5429
Corvus Interfaces	CALL
RANA SYSTEMS add-on Disc Drive	
for the Apple II	NEW!
Elite One 40 Track	NEW! \$419
Elite Controller	NEW! \$119

DISKETTES

Maxell 5 1/4 single side	\$39
Maxell 8 single side	\$49
Maxell 5 1/4 double side	\$45
Maxell 8 double side	\$55
BASF 5 1/4	\$26.95
BASF 8	\$36
Verbatim 5 1/4	\$26.95
Verbatim 8	\$36
Wabash 5 1/4	NEW! \$34.95
Wabash 8	NEW! \$39.95

TELECOMMUNICATIONS

Prentice Star Modem	\$129
Novation Cat Modem	\$139
Novation D-Cat	\$149
Novation Auto-Cat	\$199
Novation Apple-Cat	\$299
Hayes Smart Modem	\$249
Hayes Micro-Modem	\$295
Hayes Chronograph	\$225

Dealer (National/International) Inquiries Invited.
Send for FREE catalogue

COMPUTERS

ATARI (Call for prices on the complete Atari line)	
Atari 800	\$699
Atari 400	\$369
CALIFORNIA COMPUTER SYSTEMS	
Mainframe 220	\$485
64K Ram 2065	\$569
Z-80 CPU 2810A	\$265
Floppy Controller 2422a	\$359
ZENITH (Call for prices on the complete Zenith line)	
Zenith Z-89 48K	CALL
Zenith Z-90 64K	CALL
COMMODORE VIC-20	NEW! \$239
CASIO FX702 Pocket	
Computer	NEW! \$189

SPECIAL OF THE MONTH
SANYO MBC 1000
64K COMPUTER \$1595

PRINTERS

NEC 7710 Serial	\$2395
NEC 7720 KSR	\$2749
NEC 7730 Parallel	\$2395
NEC 3510 Serial	\$1850
NEC 3530 Parallel	\$1850
NEC 8023 Dot Matrix 100cps	\$559
Olivetti DY211 Letter Quality	
Daisy Wheel Printer	\$1595
Parallel Only	\$1395
Epson MX-80	CALL
Epson MX-80FT	CALL
Epson MX-100	CALL
IDS 560	CALL
IDS Prism 80	CALL
IDS Prism 132	CALL
Okidata Microline 80	CALL
Okidata Microline 82A	CALL
Okidata Microline 83A	CALL
Okidata Microline 84	CALL
Centronics 739	\$699
Datasouth 180 cps	CALL

MONITORS

Amdek 12" B&W	\$109
Amdek 13" Color	\$329
Sanyo 9" B&W	\$135
Sanyo 9" Green	\$140
Sanyo 12" B&W	\$179
Sanyo 12" Green	\$189
Sanyo 13" Color	\$359
Zenith 12" Green	\$119
Zenith 13" Color	\$339

ELECTROHOME 13" HI-RES	
COLOR MONITOR	NEW! \$829
ELECTROHOME 13" COLOR	NEW! \$349
ELECTROHOME 12" B&W	NEW! \$179
ELECTROHOME 12"	
GREEN	NEW! \$189
ELECTROHOME 9" B&W	NEW! \$149
ELECTROHOME 9"	
GREEN	NEW! \$159

RAM

16K Ram Kit for Apple II; TRS80	\$19
200 nano seconds, 4116 chips	
Two Kits	\$35
Jumpers	\$2.50

The CPU Shop

TO ORDER CALL TOLL FREE 1-800-343-6522

420-438 Rutherford Ave., Dept. B07M, Charlestown, Massachusetts 02129

Hours: 9 AM - 9 PM (EST) Mon.-Fri. (Sat. till 7)
Technical information call 617/242-3361

TWX- 710-348-1796

Massachusetts Residents call 617/242-3361
Massachusetts Residents add 5% Sales Tax



FEEL TRAPPED BETWEEN CAPACITY AND COST?

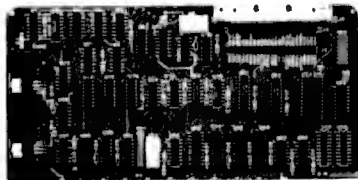

Processor Interface introduces the Cartridge Disk Controller for the S 100 bus. Configurable for 12 sector 2315 and 5440 type disk drives (1 25-10 Mbytes per drive). Complete with CPM* CBIOS disk formatter diagnostics and technical manual. low cost \$595 00

Manual only \$25 00
The performance you need at a cost you can afford



Processor Interfaces, Inc. P.O. Box 154A Elm Grove WI 53122
414 758-1749

Circle 313 on inquiry card.

CHIPS & DALE

THE INFLATION FIGHTERS!

4116 300ns 8/\$11.00
4116 250ns 8/\$12.00
4116 200ns 8/\$13.00
4116 150ns 8/\$16.00
2114L 300ns 8/\$15.00
2114L 200ns 8/\$16.50
*4164 200ns \$7.90
*6116 150ns \$8.00

1791 Disk Controller \$21.00
Z80A CPU \$5.50 ea.
8251A \$4.75 ea.
2716-1 (5V)350ns 8/\$6.50 ea. \$7.50 ea.
2716 (5V)450ns 8/\$3.75 ea. \$4.15 ea.
*2732 (5V)450ns 8/\$7.25 ea. \$9.00 ea.
2532 (5V)450ns 8/\$8.00 ea. \$9.25 ea.

Allow up to 3 wks. for personal checks to clear. Please include phone number. Prices subject to change without notice. Add \$3.50 Shipping & Handling. Wash. residents add 6.6% Sales Tax.
CHIPS & DALE
10655 N.E. 4th St., Suite 400
Bellevue, WA 98004
1-206-451-9770
Master Charge
Visa accepted

Circle 75 on inquiry card.

ANALOG ↔ DIGITAL DIGITAL ↔ ANALOG

CONVERSION MODULES

SOFTWARE GAIN CONTROL

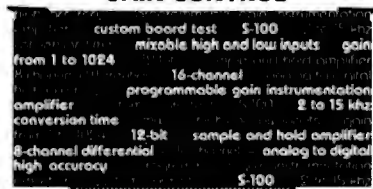

For additional details about the AD-100-4 and other fine California Data Corporation 100% individually tested, high reliability products, circle the reader service card number below or for faster response write or call us

CALIFORNIA DATA CORPORATION
3475 Old Conejo Road, Suite C-10
Newbury Park, CA 91320
(805) 498-3651

Circle 68 on inquiry card.



IPEX



"ELF" Interface Converts Your Typewriter Into Printer



- Finest print quality
- Low cost
- Easy installation
- Quick delivery
- Fits IBM Selectric® and Electronic Typewriters
- Models for all popular computers
- Call or write for more information, today!

We export to all countries -



INTERNATIONAL INC.
5115 Douglas Fir Rd.
Calabasas, CA 91302 U.S.A.
Tel: (213) 710-1444 TLX/TWX: 910 494 2100

Circle 198 on inquiry card.

p-System + CPR =
Word Processing

CPR The Vital Link

CPR is an advanced text formatter offering fast, flexible word processing for the UCSD p-System.

CPR functions include pagination, underlining, proportional spacing and a lot more.

CPR is available now on 8" diskettes for p-System versions II and IV including 175 page users' manual... \$199.00.

Users' manual alone... \$30.00

* UCSD p-System is a trademark of the Regents of the University of California

Chapin ASSOCIATES

SOFTWARE FOR SYSTEMS AND APPLICATIONS

11568 Sorrento Valley Rd San Diego, CA 92121
Suite 11 (714) 452-9340

Circle 72 on inquiry card.



maxell.

Floppy Disks

SAVE 40% Write for your complete list.

5 1/4" Specify soft, 10 or 16 sector Price/10

MD1 or MH1 SS/DD \$33
MD2 or MH2 DS/DD 47
MD1-DDM SS/QD/96 TP1 43
MD2-DDM DS/QD/96 TP1 53

8" Specify soft or 32 sector

FD1 or FH1 SS/DD 43
FD2 or FH2 DS/DD 53

CHECKS - VISA - MC - C.O.D.
(313) 777-7780 ADD \$2 SHIPPING

LYBEN COMPUTER SYSTEMS
27204 Harper Ave.
St. Clair Shores, MI 48081

Circle 223 on inquiry card.

SCR SUPER-BUYS

\$10.00 MIN ORDER HANDLING/SHIPPING \$2.50
UPS ANYWHERE IN CONTINENTAL U.S.

1982 BUYERS GUIDE NOT JUST ANOTHER CATALOGUE BUT A BUYERS GUIDE FREE

"OF THE FUTURE"

1 UHF-VHF CONVERSION KIT. Complete with PC board, all required components; jumper wire; cabinet with speaker, and comprehensive brochure incl. schematic, board layout, mounting and hook-up diagrams, parts list, and assembly and set-up instructions. All parts are industrial prime quality. \$119.95 ea.

2 NEW ZENITH ZVM-121 HIGH-LEGIBILITY CRT MONITOR. Features 12" green phosphor CRT, with 15 MHz Bandwidth 40 or 80 character widths are operator switch-selectable. Fully compatible with 80-column Apple cards, etc. \$117.95 ea.

OUTSIDE CAL 800-854-8660
INSIDE CAL (714) 527-2554

SCR ELECTRONICS INC.

VISIT OUR NEW SUPER CENTER
5303 Lincoln Ave., Cypress, CA 90630
Pay by CHECK, M.O., VISA, M/C

Circle 344 on inquiry card.

Verbatim®

Floppy Discs

SAVE 40% Write for our complete list.

5 1/4" Specify soft, 10 or 16 sector Price/10

MD525 1 side/dbl dens. \$27.30
MD560 2 sides/dbl dens. 40.30
MD577 1 side/77 track 37.10
MD567 2 sides/77 track 47.50

8" Critically Certified Soft sector

FD34-9000 1 side/sgl dens. 33.80
FD34-8000 1 side/dbl dens. 39.00
FD34-4001 2 side/dbl dens. 46.20

CHECKS - VISA - MC - C.O.D.
(313) 777-7780 ADD \$2 SHIPPING

LYBEN COMPUTER SYSTEMS
27204 Harper Ave.
St. Clair Shores, MI 48081

Circle 224 on inquiry card.

CROSS REF. PROGRAM

for MBASIC & BASCOM Source Files M80 and CP/M's ASM

MXREF will list all program variables, functions, key words, strings, constants and line number references in alphabetical order. 1000 variable names allowed. Requires an 8080 or Z80 running CP/M ver. 1.4 or later and at least 48K RAM. Price \$96.00. Manual only \$15.00. Add \$5.00 COD. MXREF available in CP/M format on 5" NorthStar or 8" single or double density soft sector.

COMPUTER TOOLBOX INC.
1325 East Main St.
Waterbury, CT. 06705
(203) 754-4197

Circle 103 on inquiry card.

SPECIALS on INTEGRATED CIRCUITS

6502	7.45	10/6.95	50/6.55	100/6.15
6502A/6512A	8.40	10/7.95	50/7.35	100/6.90
6520 PIA	5.15	10/4.90	50/4.45	100/4.15
6522 VIA	6.45	10/6.10	50/5.75	100/5.45
6532	7.90	10/7.40	50/7.00	100/6.60
2114-L200		2.45	25/2.30	100/2.15
2114-L300		2.25	25/2.10	100/2.00
2716 EPROM		5.50	5/5.15	10/4.80
2532 EPROM		9.90	5/9.45	10/8.90
6116 Hitachi 2Kx8 CMOS RAM		9.90	5/9.45	10/8.90
4116-200 ns RAM				8 for 15
Zero Insertion Force 24 pin Socket				2.00
S-100 Wire Wrap Socket				2.40

A P Products 15% OFF
A P Hobby-Blox 15% OFF

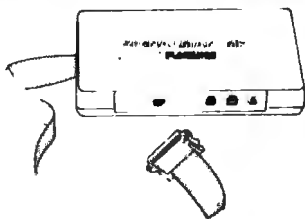

MODEM SPECIAL \$99

SIGNALMAN Mk1 from Anchor Automation
 DIRECT CONNECT Modem with RS232 Cable and Connector included Fully compatible with all Bell 103 modems 0 to 300 bps, full duplex, frequency shift keyed modulation, automatic ANSW/ORIG selection direct connect, audible tone carrier detect indicator self-contained battery powered

PET/CBM Version (Mk1P) \$169
ATARI Version \$99

COMPACT INTELLIGENT TERMINAL PACKAGE \$115
 Combines intelligent RS232 port hardware from cgrs Micro-tech with EHS Intelligent Terminal software to allow you to connect any RS232 Modem to PET/CBM

RS232 MODEM - STAR SALE \$128
IEEE 488 MODEM - STAR SALE \$199

We carry Apple II+ from Bell & Howell

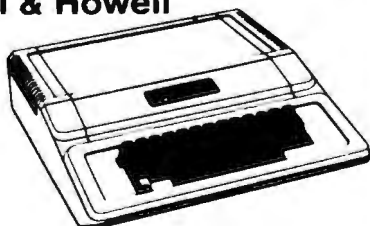

16K RAM Card for Apple 95

FLEX-FILE for PET/CBM \$80
 Very comprehensive and easily used Data Base, Report Writer with calculation capability, and Mailing Label system.

FORTH for PET by Cargile/Riley \$50
 Full FIG model with all 79 Standard extensions.
Metacompiler for FORTH for independent object code 30

KMMM PASCAL for PET/CBM \$85
 Includes translator for true machine language object code.

EARL for PET/CBM 85
 Editor, Assembler, Relocator, Linkeditor.

SuperGraphics - BASIC Language Extensions 40
 Fast Machine Language Graphics routines for PET/CBM.

commodore



CBM-PET SPECIALS

	list	SALE
8023 Printer - 136 col. 150cps bi-directional	(995)	775
8300 Daisy Wheel - 40 cps bi-directional	(2250)	1750
8032 80 x 25 CRT, business keyboard	(1495)	1100
Super Pet	(1995)	1600
8096 Board (extra 64K RAM for 8032)	(500)	400
8050 Dual Disk Drive - 1 megabyte	(1795)	1345
8250 Dual Disk Drive - 2 megabyte	(2195)	1760
CBM IEEE Modem	(395)	199
4016 full size graphics keyboard	(995)	795
4032 full size graphics keyboard	(1295)	999
4040 Dual Disk Drive - 330,000 bytes	(1295)	999
2031 Single Disk Drive - 165,000 bytes	(695)	550
4022 Tractor Feed Printer	(795)	630
C2N External Cassette Deck	(75)	65
Used CBM/PET Computers		CALL

WE WILL MATCH ANY ADVERTISED PRICE

***** EDUCATIONAL DISCOUNTS *****

Buy 2 PET/CBM Computers, receive 1 FREE

PETSCAN I \$345 base price.

Allows you to connect up to 20 CBM/PET Computers to shared disk drives and printers. Completely transparent to the user. Perfect for schools or multiple word processing configurations. Base configuration supports 3 computers.

VIC 20	259	VIC Superslot	24
VIC 1515 Printer	335	VIC Super Alien	24
VIC 3K RAM	36	VIC Maze in 3-D	12
VIC 8K RAM	54	VIC Cosmic Debris	9
VIC 16K RAM	112	VIC Amok (UMI)	17
VIC 1540 Disk Drive	500	VIC Snakman	13
VIC Invaders	24	VIC Rubik's Cube	13
VIC Jupiter Lander	24	VIC Night Rider	11

TNW 1000 Serial interface	110
TNW 488/103 with DAA	450
Computer's First Book of PET /CBM	11
WordPro 3 Plus - 32K CBM, disk, printer	195
WordPro 4 Plus - 8032, disk, printer	300
VISICALC for PET, ATARI, or APPLE	190
SM-KIT - PET ROM Utilities	40
Programmers Toolkit - PET ROM Utilities	35
PET Spacemaker II ROM Switch	36
2 Meter PET to IEEE or IEEE to IEEE Cable	40
Dust Cover for PET	8
IEEE-Parallel Printer Interface for PET	110
IEEE-RS232 Printer Interface for PET	120
The PET Revealed	12
Library of PET Subroutines	12

4 PART HARMONY MUSIC SYSTEM for PET

The Visible Music Monitor, by Frank Levinson, allows you to easily enter, display, edit, and play 4 part harmony music. Includes whole notes thru 64ths (with dotted and triplets), tempo change, key signature, transpose, etc. The KL-4M unit includes D to A converter and amplifier ready to hook to your speaker

KL-4M Music Board with VMM Program \$80

DISK SPECIALS



SCOTCH (3M) 5"	10/2.45	50/2.35	100/2.30
SCOTCH (3M) 8"	10/2.60	50/2.45	100/2.40

WE STOCK VERBATIM DISKS

Try the new Verbatim Head Cleaner Kits

BASF 5" or 8"	10/2.00	20/1.95	100/1.85
Wabash 5"	10/2.00	20/1.95	100/1.85
Wabash 8"	10/2.00	20/1.95	100/1.85

WE STOCK MAXELL DISKS

Diskette Storage Pages		10 for 3.95
Disk Library Cases	8" - 2.85	5" - 2.15
Disk Hub Rings	8" - 50 @ 7.50	5" - 50 @ 6.00

CASSETTES - AGFA PE-611 PREMIUM

High output, low noise, 5 screw housings

C-10	10/56	50/50	100/48
C-30	10/73	50/68	100/66

SPECIALS

EPSON MX-80 Printer	440
EPSON MX-80 F/T Printer	540
EPSON MX-70 Printer	300
EPSON MX-100 Printer	695
Centronics 739 Printer with dot graphics	575
STARWRITER Daisy Wheel Printer F10	1445
Zenith ZVM-121 Green Phosphor Monitor	119
DC Hayes Smartmodem	230
Watanabe Intelligent Plotter 1195	6-Pen 1445
BMC BM12A Green Phosphor Monitor	99
BMC BM1400BLUC 13" Color Monitor	285
BMC RGB 13" Color Monitor	329
POWERMATE Multiple Outlet Power Strips	
ISOBAR Isolated and Filtered Outlet Strips	

ALL BOOK and SOFTWARE PRICES DISCOUNTED

Synertek Systems

SYM-1 Microcomputer	SALE	199
SYM BAS-1 BASIC or RAE 1/2 Assembler		85
KTM-2/80 Synertek Video and Keyboard		349
KTM-3/80 Synertek Tubeless Terminal		385

ZENITH data systems

Z90-80 64 K	2170
Z90-82 64K, 1 double dens drive	2395
Z89-0 48K	1950
Z89-1 48K, 1 drive	2150
Z67 10 Megabyte + Floppy Drive	4495
Z37 13 Megabyte Dual Floppy	1495
Z25 High Speed Printer	1195
Z19 Video Terminal (VT-52 compatible)	695
ZVM-121 Green Phosphor Monitor	119
All Zenith Software discounted	



ATARI SPECIALS

800 Computer	675	Microsoft BASIC	72
400 - 16K	330	MISSILE COMMAND	32
810 Disk Drive	440	ASTEROIDS	32
825 Printer	629	STAR RAIDERS	37
850 Interface	170	Space Invaders	32
Inside Atari DOS	18	MUSIC Composer	45
Paddle Pair	19	MODEM for Atari	99
Joystick Pair	19	Super Breakout	30
16K RAM	69	PAC-MAN	36
32K RAM	99	CENTIPEDE	36
Pilot	68	First Book of Atari	11

Write for prices on other Atari items

WRITE FOR CATALOG

Add \$1.25 per order for shipping. We pay balance of UPS surface charges on all prepaid orders. Prices listed are on cash discount basis. Regular prices slightly higher. Prices subject to change.

252 Bethlehem Pike Colmar, PA 18915 215-822-7727 **A B Computers**



ATARI

400 16K	\$319.00
400 YOURS to 32K or 48K	CALL
800 (16K)	\$39.00
410 RECORDER	\$4.00
810 DISK DRIVE	\$49.00
850 INTERFACE	\$69.00
830 MODEM	\$49.00
825 PRINTER	\$75.00
481 ENTERTAINER KIT	\$5.00
482 EDUCATOR KIT	\$25.00
483 PROGRAMMER'S KIT	\$60.00
484 COMMUNICATOR KIT	\$99.00

Prices subject to change without notice.
Shipping extra. No tax out of state.
Ca. residents add appropriate taxes.

WE ARE AN AUTHORIZED ATARI SALES AND SERVICE CENTER



COMPUTERTIME, INC.

P.O. Box 216
Kendall, CA 94914

CALL TOLL-FREE 800-227-2520
In California 800-772-4064

Circle 106 on inquiry card.

Beech Enterprises
6109 South I Street
Tacoma, Washington 98408
(206) 472-1094

Printers — Epson, Okidata, Nec, Anadex, Others

Epson MX-70	315.00
Epson MX-80	445.00
Epson MX-100	745.00
Anadex DP9500, DP9501	1265.00
IDS 560	1104.00

Boards — Microsoft, Videx

Z80 Softcard by Microsoft	287.00
16K Ramcard by Microsoft	146.75

Computer systems — Altos, Televideo, NEC

NEC — 64K Ram, 2 Disk, 7 Expansion Slots CRT	2379.00
--	---------

Other Products & Software Available. \$ Call

Hard Disk, Visicalc, Modems, Monitors, Furniture

Terms: Certified checks, personal checks, money orders. Allow 2 weeks for personal checks to clear. Equipment is subject to price change and availability.

Circle 46 on inquiry card.

Build and Enhance

your Apple * software library at affordable prices. For the FIRST time — PACKED disks with 60 outstanding programs

Your Apple * needs programs! At last you have an opportunity to use your Apple* to its fullest capacity!



APPLEWARE INC. offers on each disk an extensive variety of programs including:

Business	• Printer	• Graphics
Games	• Text	• Music
Utilities	• Data Base	• Finance
Science	• Engineering	• and many others with 3.3 DOS for easy demuffing.

First 3 disks available at \$59.95 each
Order all 3 for a free bonus disk.
Call now toll free: 1-800-327-8664
Fla. Residents: 305-584-7004
Please add \$3 for postage & handling.

6400 Hayes St
Hollywood, FL 33024



*TM Apple is a registered trademark of Apple Computer Co

Circle 28 on inquiry card.

Save \$ on Computer Books!

We offer a 10% discount on computer books from Addison-Wesley, Wiley, Sybex, and Murach. Fast, reliable service and low shipping charges for mail orders. Write for FREE catalog (or stop in to see us in lower Manhattan).



DOWN TOWN BOOK BAZAAR INC.

DOWNTOWN BOOK BAZAAR, Dept. B
172 Fulton St.
(near World Trade Ctr.)
New York, N.Y. 10007

Circle 140 on inquiry card.

*** ADDS ***

VIEWPOINT TERMINALS

\$495

In addition EPI carries printers DEC & DG compatible terminals and modems. Items in stock are shipped within 24 hours. ALL orders shipped COD. All items are new and in factory cartons with manufacturers warranties.

ECONOMY PERIPHERALS INC.

(404) 952-0213

Circle 147 on inquiry card.

RGB HI RESOLUTION COLOR DISPLAYS



*High Contrast Black-Stripe Tube
*Ultra-Stable Conveyance
*Displays 80 Character Text
*90 Day Warranty
*110/220VAC, 50/60 Hz
*Analog Inputs
*15.7 KHz

IBM, Apple III, CAT-100 Microangelo interfaces Available.

13" — \$359.00 420 pixels x 525 lines, 32 lbs
19" — \$389.00 640 pixels x 525 lines, 48 lbs

Active 8 long 16 Color ("Intensity")
IBM Interface Cable — \$49.00

Bezels: \$25 Build your own case and save
Enclosed Displays Now Available, Dealerships Available

NEW! "BIG BOARD" BOX

For Ferguson Board from Digital Research Computers (and similar Boards)

Attractive enclosure • Two 8" full-sized Floppies
features: • "BIG BOARD"
• Power Supply
• Power Switch + "RESET" on Front Panel
• "D" and fan Outlets on Rear Panel
+ 12 lbs Shipping • Tilt-up Stand

\$89.95

Add shipping, and insurance. We are philosophically against VISA & M.C. (for 5% who wouldn't be?)

Dealin' Electronics
718 Loma Verde, Palo Alto, CA 94301 • 415-493-5930

Circle 131 on inquiry card.

MEMOREX FLEXIBLE DISCS

WE WILL NOT BE UNDER-SOLD! Call Free (800)235-4137 for prices and information. Dealer inquiries invited and C.O.D.'s accepted.



PACIFIC EXCHANGES
100 Foothill Blvd
San Luis Obispo, CA 93401 In Cal. call (800)592-5935 or (805)543-1037

Circle 292 on inquiry card.

PC/FORTH

Complete FORTH program development systems for the IBM® Personal Computer. Packages include interpreter/compiler with virtual memory management, line editor, custom screen editor, assembler, decompiler, utilities, file and record access modules, and many demonstration programs. 100 page user manual . . . \$100.00

Floating point arithmetic extensions and cross compiler available at additional cost.

Ready to run under PC-DOS or CP/M-86® Standalone version available soon. 64 kbytes RAM and two disk drives recommended. (IBM is a registered trademark of International Business Machines Corp CP/M is a registered trademark of Digital Research, Inc.)

Laboratory Microsystems
4147 Beethoven Street
Los Angeles, CA 90066
(213) 306-7412

Circle 214 on inquiry card.

YOU'VE JUST FOUND THE MISSING LINK!



Computer Shopper is your link to individuals who buy, sell and trade computer equipment and software among themselves nationwide. No other magazine fills this void in the marketplace chain.

Thousands of cost-conscious computer enthusiasts use Computer Shopper every month through hundreds of classified ads. And new equipment advertisers offer some of the lowest prices in the nation.

Subscribe to Computer Shopper with a **6 month trial for only \$6.** MasterCard or VISA call **TOLL FREE 800-327-9920**

COMPUTER SHOPPER
P.O. Box F308 • Titusville, FL 32780
305-269-3211

Circle 416 on inquiry card.



**NOW!
176K
TOTAL
RAM**

- For the '89
- 3 MP/M II[®] Compatible Banks
- "Invisible Disk" CP/M[®] Software Included

Only **\$595.00**
MAGNOLIA
MICROSYSTEMS

2264 - 15th AVE. W • SEATTLE, WA 98119
(206) 285-7266 (800) 426-2841
CP/M[®] & MP/M II[®] are registered trademarks of
Digital Research, Pacific Grove, CA

Circle 230 on inquiry card.

Cables EIA RS 232-C

Quality cables with immediate
delivery and low prices.

Conductor	Price
1-4	\$11.50 + .15/ft.
5-7	12.00 + .25/ft.
8-12	13.00 + .30/ft.
13-16	14.00 + .40/ft.
17-25	16.00 + .50/ft.

Specify: Male or female connectors, length of
cable and pins to be connected. OEM & quantity
discounts available to qualified customers. On
prepaid orders add \$4.50 for shipping/handling.

We also supply DEC
and IBM Compatible cables.

Communication Cable Company

319 Louella Ave. Wayne, PA 19087
215-964-9404

Circle 83 on inquiry card.

CLOSE-OUT SALE

\$200,000 INVENTORY
priced below dealer cost

WRITE FOR BARGAIN LIST

Computers, terminals, disk drives,
printers, S100 main frames, boards, kits,
software

TOP BRANDS: California Computer
Systems—Ithaca Intersystems—Morrow
Designs—SD Systems—SSM Micro
Products—Tarbell Electronics—Zenith
Data Systems—Diablo—Epson—NEC—
Anadex—Okidata—Integral Data
Systems—C. Itoh Comet & Starwriter—
Livermore—Lexicon—Televideo—MicroPro

**LYBEN COMPUTER
SYSTEMS**

27204 Harper
St. Clair Shores, MI 48081

Circle 225 on inquiry card.

FORECASTING

EASI/ARIMA — The first and only microcom-
puter program to develop and run ARIMA
(Box-Jenkins) models...all automatically. De-
signed for the stock or commodity trader.
Create a database or read Compu Trac files
directly. Requires no knowledge of statistics.
\$300.

TWG/ARIMA — The statistician's version of
EASI/ARIMA. Complete control and more op-
tions, such as seasonal models and Box-Cox
transformations. \$300.

ELF is our general purpose statistical
package. \$200.

All are for the Apple II[®] with 48K of
memory, Applesoft[™] and DOS 3.3.

Visa and MasterCard accepted.
Call or write:

The Winchendon Group
3907 Lakota Road
P.O. Box 10114
Alexandria, VA 22310
(703) 960-2587

*Trademarks of Apple Computer, Inc.

Circle 404 on inquiry card.

6800 Family Software



SOFTWARE: WIZRD multitasking DOS, editor,
assembler, C, PL/W, PASCAL, FORTRAN, 12K BASIC
FIRMWARE: FANTOM monitor/debugger, MATH
long integer and floating point, 4K Industrial
BASIC

CROSS SOFTWARE: Assembler, PL/W, linker,
math/science, simulator



Wintek Corp
1801 South Street
Lafayette, IN 47904
317-742-8428

Circle 405 on inquiry card.

NEW 23K PERSONAL COMPUTER

\$239⁰⁰ FACTORY SALE
PRICE

You get the NEW APF-IM-1 Full Size Powerful
Computer: Includes 14K ROM with Level II BASIC
built in, 9K User RAM, Color, Sound, Professional
53 keyboard, Two controllers, Two 10 key numer-
ic pads, High speed cassette, A.C. adapter, RF
modulator, T.V. switchbox. Accepts TAPE-DISK-
PLUG IN CARTRIDGES. It is PLUG IN EXPAND-
ABLE at low cost. 90 day parts and labor warran-
ty, owners guide, BASIC language manual. All
this in a beautiful black and white console case
for only \$239⁰⁰.

15 DAY FREE TRIAL Return within 15 days com-
plete and undamaged for refund of purchase
price.

PROTECTO ENTERPRIZES
BOX 550, BARRINGTON, IL 60010
TO ORDER PHONE 312/382-2192

Circle 316 on inquiry card.

HAS YOUR COMPUTER LOST ITS BYTE?



Now you can get **FACTORY AUTHOR-
ORIZED** service for your Commodore or
Atari computer and peripherals at reason-
ably cost. Minimize your down
time frustration and expense. Extended
warranty available for most products,
too!

CALL
717-327-1450
**Micro Computer
Service Center**

477 E. Third St., Williamsport, PA 17701

Circle 454 on inquiry card.

Being the 3rd edition of the 1st
catalogue devoted exclusively to
PET and CBM owners everywhere



**So you own
a Commodore
PET or CBM and you
haven't received the
latest edition of the one and only
catalogue in the whole wide world
devoted exclusively to PET and CBM
products? The new Skyles catalogue:
over 70 items designed for your com-
puter. All kinds of good stuff. From
Skyles Electric Works, the oldest and
largest company for PET and CBM
computers. So, send for your cata-
logue now. It's hot off the press.
And it's FREE.**

Skyles Electric Works
231E South Whisman Rd.
Mt. View, CA 94041

Circle 351 on inquiry card.

PRICE BREAK

**EPSON
MX-80
CARTRIDGE RIBBONS**

\$9⁹⁵ EA.

\$107.46 per dozen
Minimum Order 3 Ribbons
Price Includes Shipping
We accept Mastercard and Visa

CHECK-MATE[™]
P.O. BOX 103, RANDOLPH, MA 02368
Call Toll Free - 1-800-343-7706
In Massachusetts - 617-963-7694

Circle 73 on inquiry card.

ARE YOU OUT OF CONTROL?

OUR 6502 BASED MICROCOMPUTER HAS
EVERYTHING UNDER CONTROL.

THE COMPUTER "SLIM"

- 6502 MICROPROCESSOR
- 2K BYTES RAM
- 2K OR 4K EPROM
- FOUR 8 BIT I/O PORTS
- POWER ON RESET
- CRYSTAL CLOCK
- BUFFERED SYM-AIM BUS

PRICE 81-260A **\$199.95** ASSM.
81-260K **\$149.95** KIT
81-260B \$ **39.95** BARE BOARD

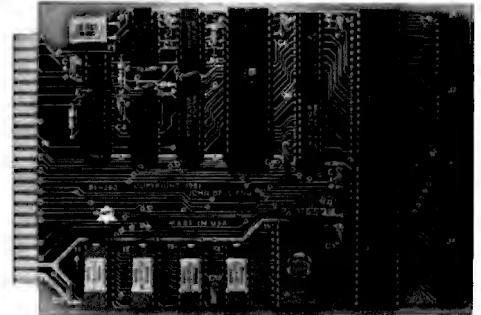

THE COMPUTER "SLIM"

ALL BOARDS ARE 4.5 X 6.5 WITH
GOLD EDGE CONNECTORS
SOLDER MASK BOTH SIDES

THE PERIPHERALS

RAM EPROM MEMORY

- 32K BYTES OF RAM OR EPROM

PRICE 81-330A \$ **99.95** ASSM. W/O MEMORY
81-330B \$ **49.95** BARE BOARD

6 SLOT MOTHER BOARD

- .750" BOARD SPACING 44 PIN BUS

PRICE 81-320A \$ **99.95** ASSEMBLED
81-320B \$ **49.95** BARE BOARD

24 HOUR REAL TIME CLOCK

- FOUR DIGIT LED DISPLAY
- ON BOARD POWER SUPPLY

PRICE 81-350A **\$149.95** ASSEMBLED
81-350B \$ **49.95** BARE BOARD

ANALOG I/O INTERFACE

- 16 ANALOG INPUT CHANNELS
- 2 ANALOG OUTPUT CHANNELS

PRICE 81-292A **\$199.95** ASSEMBLED
81-292B \$ **49.95** BARE BOARD

12 PORT PARALLEL I/O BOARD

- 12 8 BIT I/O PORTS — 6 6522S

PRICE 82-036A **\$169.95** ASSEMBLED
82-036B \$ **49.95** BARE BOARD

MONITOR + TINY BASIC 2532 **\$39.95**

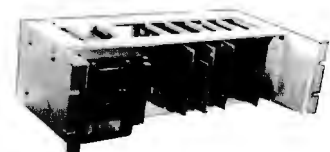
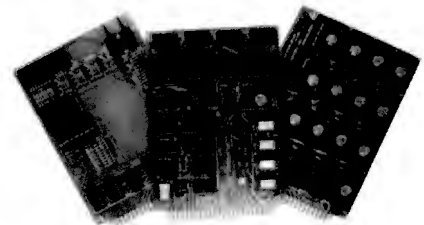

19" RACK MOUNTING

CALL 415 592-8411 FOR MORE
INFORMATION.

OUR SALES PEOPLE WILL BE
GLAD TO DEMONSTRATE OUR
PRODUCTS AT YOUR COMPANY.
OEM PRICING AVAILABLE.



JOHN BELL ENGINEERING, INC.

MC

ALL PRODUCTS ARE AVAILABLE FROM JOHN BELL ENGINEERING, INC. • 1014 CENTER ST., SAN CARLOS, CA 94070
ADD SALES TAX IN CALIFORNIA • ADD 5% SHIPPING & HANDLING 3% FOR ORDERS OVER \$100
SEND FOR CATALOG

(415) 592-8411

10% OUTSIDE U.S.A.

VISA

WILL CALL HOURS: 9am - 4pm

SUPER SALE

EPROM's

1-7 8 up 50 up

2716 (450nS, 5V) \$3.95 \$3.55 CALL
2732 (450nS, 5V) 7.85 6.95 CALL

2K x 8 CMOS RAM

1-7 8 up 50 up

6116P-3 (150nS) \$7.50 \$7.20 CALL

16K RAM EXPANSION KIT

For TRS-80 Model III

Set of 8 pieces UPD418C-2 (200nS) \$12.95
Data furnished with purchase on request.

MISC

ADC0809 (Analog/Digital Counter)

8 bit/8 channel multiplexer \$4.20

EPROM 2716-1 (350nS, 5V) \$7.20



SUNTRONICS CO., INC.

12621 CRENSHAW BOULEVARD
HAWTHORNE CALIFORNIA 90250

STORE HOURS Mon-Fri 10am to 6:30pm Sat 10am to 5pm
IN CALIFORNIA OUTSIDE CALIFORNIA TOLL FREE

(213) 644-1149 1-800-421-5775
Min Order \$10, P/H \$2 VISA, Mastercard, Check or M.O.

Circle 368 on inquiry card.

OMEGA

The Last Disassembler You Will Ever Need!

Mnemonics Externally Defined

Zilog, Intel, PASM Supplied

ASCII/HEX Preconditioner

Can Externally Def. Equates

Optional Address Listing

ASM/PASM/M80 Compatible

DB statements forcible over user
specified range

\$150. complete/\$25. manual only
for further information contact

COMPUTER TOOLBOX, INC.

1325 East Main St.

Waterbury, Ct. 06705

Phone (203) 754-4197

Circle 104 on inquiry card.

FREE IBM PC VIDEO GAME*

and Personal Storytelling Program
for requesting our Catalog of
IBM PC Software
covering
Intelligent Systems†
Personal and Business Planning Aids
Games
Educational Programs

*The video game requires Advanced BASIC and
the color graphics option. Send name, address,
and a check for \$10 to cover cost of 5 1/4" disk,
shipping by U.P.S. and handling to:

SoftWave

P.O. Box 5389, Seattle, WA 98105

Residents of Wash. State add 6.5% tax.

† Ask about our LISP, too.



Circle 354 on inquiry card.

EPICS™ COMPUTER SOFTWARE for EXECUTIVES and MANAGERS

- Name/Address/Key Information
- Personal Schedule
- Corporate Schedule
- Document Tracking
- File Indexing Schema
- Tickler File

Functional, well engineered software in
the Pascal programming language for
Apple II and TRS-80 Model II Com-
puters. Plus seminars to help your com-
puter understand you.

SOFTWARE CONSULTING SERVICES

901 Whittier Drive, Allentown, Pa. 18103

(215) 797-9690

ATT. Martha Cicholli

*TM: Apple Computer Co. **TM: Tandy Corp

Circle 355 on inquiry card.

AUTOMATE YOUR OFFICE WITH ASCI* SOFTWARE CONTROLLABLE SWITCHES



- User selectable software controllable
- Switches computers and peripherals
- User determined control words
- Supports 150 to 19200 baud
- Totally portable with AC option
- Features manual override operation

Advanced Systems Concepts, Inc.

P.O. Box Q

Alladena, California 91001

(213) 684-5461 or 794-2308

Circle 10 on inquiry card.

DATA PROCESSING OPPORTUNITIES

Mathematical Applications Group,
Inc., a major computer service bureau
located in Westchester County, NY,
has continuing opportunities for
talented individuals with background
in Micro Processing, Computer Oper-
ation, System Analysis, Data Control
& Technical Support. A high level of
technical competence and self-moti-
vation is required. For prompt consid-
eration, please send your resume to:
Attn: Denise Goepel, Personnel Mgr.

MAGI

3 Westchester Plaza
Elmsford, New York 10523

An Equal Opportunity Employer M/F

Circle 226 on inquiry card.



Dot Matrix Printer Interfaces with Apple II
Featuring an Apple II-compatible parallel
interface, Addmaster Corporation has produced
a new dot matrix printer, Model 170. The inter-
face includes a Centronics-type handshake and
DB-25 interface connector, Baudot, and day
and time clock. The Model 170 provides 18 or
21 characters per line, 6 lines per inch print
density, on standard 2 1/2" adding machine tape.
Designed to use with personal computers,
Model 170 will produce hard and carbonless
copies of programs, data or results. Write
Addmaster Corporation, 418 Junipero Serra Dr.,
San Gabriel, CA 91776 or call 213/265-1121.

Circle 7 on inquiry card.

KTERM telecommunications

**AT LAST! RECEIVE COM AND BINARY
FILES FROM ANY SOURCE!**

- Use KTERM on the receiving computer
- Use KTERM or PIP or many other
programs on the sending computer

- With KTERM on both computers get error
detection and automatic retry.

- KTERM can be used as an intelligent
terminal program.

- Now available for Vector Graphic and
Apple II* (with CP/M)**

- Coming soon Televideo and Osborne I

One CPU **\$120** Two CPU's **\$200**

Ohio Residents add 5.5% sales tax

Specify type of computer For Apple computer also
specify interfaceboard type

**TRIANGLE
MANAGEMENT**

1260 Windham Road
Columbus, OH 43220

Reg. Trademarks *Apple Computer Inc. **Digital Research Inc.

Circle 387 on inquiry card.

Verbatim flexible disks

Call Free (800) 235-4137 for
prices and information. Dealer
inquiries invited. C.O.D. and
charge cards accepted.

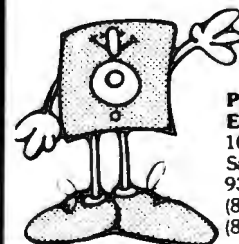

**PACIFIC
EXCHANGES**
100 Foothill Blvd.
San Luis Obispo, CA
93401. In Cal. call
(800) 592-5935 or
(805) 543-1037.

Circle 292 on inquiry card.

DoKau Computer Products, Inc.

VISIT OUR RETAIL STORE
AND RECEIVE A 5% DISCOUNT!

3250 KELLER STREET, #9 • SANTA CLARA, CA 95050

8000

8035	16.00	8239	4.75
8039	19.00	8243	4.75
8080A	3.90	8250	14.90
8085A	8.50	8251	4.50
8088	39.00	8253	8.75
8155	11.00	8253-5	9.75
8156	11.00	8255	4.50
8185	29.00	8255-5	5.20
8741	39.00	8257	8.50
8748	29.00	8259	6.85
8755	44.00	8272	39.00
8202	44.00	8275	29.00
8205	3.45	8279	9.25
8212	1.80	8279-5	10.25
8214	3.75	8282	6.50
8216	1.75	8283	6.50
8224	2.45	8284	5.50
8226	1.80	8286	6.50
8228	4.50	8287	6.50
8237	19.00	8288	25.00
8238	4.75	8289	49.00

16K APPLE RAM CARD

Upgrade your 48K Apple II
to full 64K

BARE BOARD 29.95
KIT 59.95
ASSEMBLED & TESTED 79.95

LEDS

Jumbo Red	10/1.00
Jumbo Green	6/1.00
Jumbo Yellow	6/1.00

CONNECTORS

RS 232 Male	3.00
RS 232 Female	3.50
RS 232 Hood	1.20

DYNAMIC RAMS

4027	(250ns)	2.00
4116	(200ns)	1.75
4116	(150ns)	1.85
4164	(200ns)	Call

EPROMS

1702	(1ns)	3.00
2708	(45ns)	2.99
2716	(5v 450ns)	3.95
2716-1	(5v 350ns)	8.50
2532	(5v 450ns)	8.95
2732	(5v 450ns)	8.95
2764	(5v 450ns)	Call

STATIC RAMS

2101	(450ns)	1.85
21L02	(250ns LP)	1.55
2111	(450ns)	2.49
2114	(450ns)	1.95
2114L-3	(300ns LP)	2.25
2114L-2	(200ns LP)	2.30
TMM2016	(200ns)	9.00
TMM2016	(150ns)	11.00
HM6116	(200ns)	Call
HM6116	(150ns)	Call
HM6116	(120ns)	Call

LP = Low Power

Z80

Z80 A CPU	5.45
Z80 A PIO	5.45
Z80 A CTC	7.00

Call for Complete List

MICROPROCESSOR

REAL-TIME CLOCK

MSM 5832
7.25

6800

6800	5.65	6828	14.90	6860	10.90
6802	8.65	6834	16.90	6862	11.90
6808	8.45	6840	7.95	6875	6.90
6809	24.00	6843	41.95	6880	1.80
6809E	29.00	6845	16.90		
6810	3.50	6847	15.90	68B00	10.00
6820	3.50	6850	3.50	68B21	12.00
6821	3.50	6852	3.50	68B50	12.00

CRYSTALS

32.768 KHZ	3.75	5.185	3.90
1.0 MHZ	4.50	5.7143	3.90
1.8432	4.50	6.5536	3.90
2.0	3.90	8.0	3.00
2.097152	3.90	10.0	3.00
2.4576	3.90	14.31818	3.90
3.2768	3.90	18.0	3.00
3.579545	3.00	18.432	3.00
4.0	3.00	20.0	3.00
5.0	3.00	22.1184	3.00
5.0688	3.90	32.0	3.90

74LS00 SERIES

74LS00	.24	74LS123	.95	74LS253	.80
74LS01	.24	74LS124	2.90	74LS257	.80
74LS02	.24	74LS125	.95	74LS258	.80
74LS03	.24	74LS126	.79	74LS259	2.80
74LS04	.24	74LS132	.75	74LS260	.60
74LS05	.24	74LS136	.49	74LS266	.49
74LS08	.24	74LS137	.95	74LS273	1.60
74LS10	.24	74LS138	.75	74LS275	3.25
74LS11	.30	74LS139	.75	74LS279	.49
74LS12	.30	74LS145	1.10	74LS280	1.95
74LS13	.40	74LS147	2.20	74LS283	.95
74LS14	.89	74LS148	1.20	74LS290	1.20
74LS15	.30	74LS151	.75	74LS293	1.79
74LS20	.24	74LS153	.75	74LS295	.99
74LS21	.30	74LS154	1.75	74LS298	.99
74LS22	.24	74LS155	.89	74LS324	1.75
74LS26	.30	74LS156	.89	74LS352	1.49
74LS27	.24	74LS157	.75	74LS353	1.49
74LS28	.30	74LS158	.75	74LS363	1.49
74LS30	.24	74LS160	.95	74LS364	1.95
74LS32	.36	74LS161	.95	74LS365	.89
74LS33	.55	74LS162	.95	74LS366	.89
74LS37	.55	74LS163	.95	74LS367	.69
74LS38	.35	74LS164	.95	74LS368	.69
74LS40	.30	74LS165	.95	74LS373	.99
74LS42	.49	74LS166	1.95	74LS374	1.69
74LS47	.75	74LS168	1.69	74LS377	1.40
74LS48	.75	74LS169	1.69	74LS378	1.15
74LS49	.75	74LS170	1.69	74LS379	1.35
74LS51	.30	74LS173	.75	74LS385	1.89
74LS54	.35	74LS174	.89	74LS386	.59
74LS55	.35	74LS175	.89	74LS390	1.79
74LS56	1.20	74LS181	1.99	74LS393	1.79
74LS73	.39	74LS189	9.50	74LS395	1.59
74LS74	.44	74LS190	.89	74LS399	1.59
74LS75	.49	74LS191	.89	74LS424	2.89
74LS76	.39	74LS192	.89	74LS447	.75
74LS78	.49	74LS193	.89	74LS490	1.89
74LS83	.75	74LS194	.89	74LS668	1.65
74LS85	.95	74LS195	.89	74LS669	1.85
74LS86	.39	74LS196	.79	74LS670	2.10
74LS90	.65	74LS197	.79	74LS674	9.50
74LS91	.79	74LS221	1.10	74LS682	2.99
74LS92	.65	74LS240	.95	74LS683	2.39
74LS93	.59	74LS241	.95	74LS684	2.39
74LS95	.79	74LS242	1.79	74LS685	2.39
74LS96	.79	74LS243	1.79	74LS688	2.39
74LS107	.39	74LS244	.95	74LS689	2.39
74LS109	.39	74LS245	1.89		
74LS112	.39	74LS247	.79	81LS95	1.65
74LS113	.39	74LS248	1.20	81LS96	1.65
74LS114	.49	74LS249	.89	81LS97	1.65
74LS122	.45	74LS251	1.25	81LS98	1.65

MISC.

Disc Controller

1771	20.95
1791	34.95
1793	34.95
1797	49.95

Uarts

AY3-1014	5.85
AY5-1013	3.90
AY5-2376	12.00
TR 1602	4.25

Interface

8T26	1.65
8T28	1.95
8T95	.95
8T96	.95
8T97	.95
8T98	.95
DM8131	2.90
DS8836	1.25

(800) 538-8800

ALL MERCHANDISE IS 100% GUARANTEED

DISKETTES

ANTHANA	SS SD Soft	23.95
WABASH	SS SD Soft	23.95
VERBATIM	SS SD Soft	28.95

IC Sockets

8 PIN	.10	.49
14 PIN	.12	.50
16 PIN	.15	.57
18 PIN	.20	.85
20 PIN	.25	.99
22 PIN	.25	1.30
24 PIN	.25	1.40
28 PIN	.35	1.50
40 PIN	.40	1.80

ST = Soldertail
W/W = Wirewrap

CMOS

4000	.25	4071	.30
4001	.30	4072	.30
4002	.30	4073	.30
4006	.90	4075	.30
4007	.25	4076	.90
4008	.90	4078	.30
4009	.45	4081	.30
4010	.45	4082	.30
4011	.30	4085	.90
4012	.30	4086	.90
4013	.45	4093	.90
4014	.90	4098	2.49
4015	.90	4099	1.90
4016	.45	4502	.60
4017	1.15	4503	.60
4018	.90	4508	1.90
4019	.45	4510	.90
4020	.90	4511	.90
4021	.90	4512	.90
4022	1.10	4514	1.20
4023	.35	4515	2.20
4024	.75	4516	1.50
4025	.35	4518	1.20
4026	1.60	4519	1.20
4027	.60	4520	1.20
4028	.75	4522	1.20
4029	.90	4526	1.20
4030	.45	4527	1.90
4034	2.90	4528	1.20
4035	.85	4531	.90
4040	.90	4532	1.90
4041	1.20	4538	1.90
4042	.75	4539	1.90
4043	.75	4543	2.70
4044	.75	4555	.90
4046	.90	4556	.90
4047	.90	4581	1.90
4049	.50	4582	1.90
4050	.50	4584	.90
4015	.90	4585	.90
4053	.90		
4060	1.39	80C07	.90
4066	.75	80C95	.90
4068	.39	80C96	.90
4069	.30	80C97	.90
4070	.35	80C98	1.15

DoKau Computer Products, Inc.
3250 Keller Street, #9
Santa Clara, CA 95050
(800) 538-8800
Calif. Residents (408) 988-0697



TERMS: For shipping include \$2.00 for UPS Ground, \$3.00 for UPS Blue Label Air. \$10.00 minimum order. Bay Area residents add 6 1/2% Sales Tax. California residents add 6% Sales Tax. We reserve the right to limit quantities and substitute manufacturer. Prices subject to change without notice. Send SASE for complete list.

ATARI

GPX* Software

25% OFF

CAVERNS OF MARS (Disk or Tape)
Reg. 29.95 **SALE 22.50**

EASTERN FRONT (Disk or Tape)
Reg. 29.95 **SALE 22.50**

DOWNHILL (Disk or Tape)
Reg. 17.95 **SALE 13.50**



MY 1st ALPHABET (Disk)
Reg. 29.95 **SALE 22.50**

FORTH (Disk)
Reg. 29.95 **SALE 22.50**

*ATARI and APX are registered trademarks of Atari Inc.

(209) 667-2888/634-8888

MICROTRONICS, inc.
1125 N. Golden State Blvd.
Turlock, California 95380

Circle 228 on inquiry card.

It's Now Available! The Light Pen For The IBM Personal Computer



Ideal For: ■ Program interface and menu selection. ■ Interactive graphics for engineering, business and CAD. ■ Very effective educational programs, without keyboard problems. ■ SUPER games, exciting demonstrations and just plain fun. **Professional Quality and Durable Construction, yet Inexpensive. Fully Supported Under IBM Basic for Color/ Graphics Adapter with Monochrome or Color Displays or TV's. (Not for use with IBM Monochrome Display).** Introductory Pricing: FT-156 Light Pen — \$139.95; Demo/Games Diskette — \$29.95. Call or write us, or see your participating IBM® dealer.

FTG DATA SYSTEMS

10801 Dale Street, Suite M-2
P.O. Box 815
Stanton, California 90608
(714) 995-3900 VISA & M/C Accepted

Circle 162 on inquiry card.

LARGE DISK CP/M USERS

TIRED OF SEARCHING DIRECTORY LISTINGS FOR YOUR FILES???

ANNOUNCING the CPUTIL package:

- Allows system files to be logically moved to the current user file upon logon. This means that multiple copies of system files are not needed.
- Removes all system files from directory listings unless desired by the user.
- Restores all system files to file 0 upon logoff.
- Allows user files to be referred to by a user-defined name or the file number.
- Allows a directory listing of any user file from any other user file.

INTRODUCTORY PRICE
\$49.95
including manuals
Texas res. add 6% sales tax

EARTH SCIENCE ASSOC
10218 Cantertrot
Humble, Tx. 77338
713-446-1555

SATISFACTION GUARANTEED

Circle 146 on inquiry card.

WMS IMPERIAL MICRO SUPPLY LTD.

Scotch® DISKETTES



MEMORY

4116-200NS 8 3/16
4164-200NS \$10 each

DISKS SCOTCH 3M

5 1/4" \$2.30 each

Reinforced Hubs. Any Quantity
Save more on 100 or more boxes *2 25 ea

**WMS IMPERIAL MICRO
SUPPLY LTD.**
P.O. BOX 833 DEPT. M
PONTIAC, MI 48056

Please add \$2.00 Shipping —
Michigan add 4% Tax

Circle 162 on inquiry card.

- Mod II/MOD 16 Programmers - Full-Screen Editor Puts "Word Processing Power" At Your Fingertips

If you write programs in COBOL, M80 Assembly or BASIC, you have fumbled around with old fashioned line editors long enough. Finally, proven Word Processing concepts have been effectively applied to full screen program editing.

Now program modifications are a snap, not a headache, with our Full-Screen Editor. Scroll up or down easily through your code. Use the arrow keys to move the cursor anywhere on the screen, and . . .

- Change program logic by simply typing over the existing code.
- Insert/Delete characters within a line with instant visual feedback, or
- Insert/Delete lines at will.

Also includes Global Search & Replace, Automatic Prompting, Print and much more.

Full-Screen Editor package now available for COBOL, M80 Assembly and BASIC for both TRS-80* Mod II and Mod 16 computers. Complete package, fully documented for all three languages, only \$99. Send for our FREE brochure for full details.

Computer IDEAS Corporation
4229 Hall St. • Dallas, Texas 75219

*Registered Trademark of Tandy Corporation

Circle 94 on inquiry card.

H89/Z89 USER

The M89 is an I/O expansion box for the H89/Z89 computer, please call or write us for more details.



Microflash Co.
4916 B Carol St.
Skokie, Ill. 60077
(312)677-4928

Circle 246 on inquiry card.



STARTJOB & O.T. CALENDAR CLOCK

For Apple or S-100 Computers
Only \$150.00

22:00:00

STARTJOB VERS 1.1
These Jobs Will Start At
22:00:00

Receive B:
Transmit C:Test.txt
Crun2 Update
Submit Payroll

Starting Delayed Jobs

System Solutions, Inc.
P.O. BOX 35
KNOB NOSTER MO 65336
(816) 625-7863



Z80

S-100

APPLE is a registered trademark of Apple Computer, Inc.
CP/M is a registered trademark of Digital Equipment, Inc.

Circle 370 on inquiry card.

THE LAST ONE™

THE PROGRAM THAT WRITES PROGRAMS

AVAILABLE FOR

TRS - 80 MLD II CP/M
Apple II Plus Sharp PC 3201
North Star Vantage

Still Only \$600.00

Dealer Inquiries Invited

Send to **KROWN COMPUTING**
1282 Conference Dr., P.O. 66763
Scotts Valley, CA 95066
(408) 335-3133

Circle 212 on inquiry card.

Scotch® Diskettes

Rely on Scotch® diskettes to keep your valuable data safe. Dependable Scotch diskettes are tested and guaranteed error-free. The low abrasivity saves your read/write heads. They're compatible with most diskette drives.



(800)235-4137



PACIFIC EXCHANGES
1181 Franklin Blvd.
San Luis Obispo, CA
93401 In Cal call
(805)542-5415 or
(805)548-1117

Dealer Inquiries Invited

Circle 292 on inquiry card.

INCREDIBLE? BELIEVE IT!

Washington Computer Services

an affiliate of **WASHINGTON ELECTRIC COMPANY** est. 1912

CUSTOM COMPUTER ROOM WIRING SINCE 1960

97 Spring Street, New York, New York 10012

TO ORDER: CALL OUR TOLL-FREE NUMBER: (800) 221-5416 In N.Y. State and for technical information: (212) 226-2121

HOURS: 9 AM-5:30 PM (EST) Monday-Friday TELEX: 12-5606 CABLE: WASHCOMP NYK

PRINTERS



150 cps bidirectional - 9x9 dot matrix, quietized case, 136 col, vertical form control and many other functions

NOW \$950

The best price/performance ratio available. RS-232 serial to 19,200 baud x-on, x-off add \$25

Teletype 40. 300 LPM-typewriter quality, RS-232 interface. This quality printer is available in many configurations including forms access, quietized case, etc. **\$3200**

Teletype 43 from **\$995**
Teletype AP-200. 340 cps dot matrix (similar to Data Prod. M-200) **\$2799**

NEC Spinwriter-55 cps, bidirectional, letter quality R.O. 7710 **\$2560** KSR 7720 **\$2799**

DIABLO 630-40 cps, bidirectional, daisy wheel, plot/graph **\$2349**

QUME Sprint 9/35 cps, daisy wheel **\$1944**

C. ITOH Starwriter, 40 cps, daisy wheel, F10 **\$1550**

EPSON MX-80, 100, 80 cps, 9x9 dot matrix **\$C**

ANADEX 9500/9501, up to 200 cps, high resolution dot **\$1325**

OKIDATA Microline 82A, bidirectional, friction/pin feed **\$525**

Microline 83A, bidirectional, 120 cps, uses 15" paper **\$799**

TI-810, 150 cps, Basic **\$1449**

Package-Compressed print, vertical form control **\$1630**

MANNESMANN MT 1705 200 cps, 7x9, 132 col **\$C**

TALLY MT 1805 200 cps, 7x9 + NLQ 40x18 matrix **\$C**

CENTRONICS **\$C**

739 100 cps, nx9 dot matrix, Full Graphics **\$567**

122 120 cps, International set, Full Graphics **\$987**

DEC LA-34 **\$1085**

IOS PRISM, 132 col., color **\$1785**

TERMINALS PMMI MODEM **\$359**

AMPEX DIALOGUE 30, 80, 81 Lowest Prices **\$C**

TELEVIDEO 910 C (multi-terminal) **\$610**

925C **\$795**

950C **\$950**

SORDC IQ 120 **\$729**

HAZELTINE ESPRIT **\$669**

DEC VT-100 **\$1575**

WYSE WY-100 (ALTOS 1) **NEW! \$C**

Similar savings for our HAZELTINE and LEAR SIEGLER lines

SOFTWARE

MBASIC-80 **\$275** WORDSTAR **\$300**

MBASIC COMPILER **\$316** MAILMERGE **\$110**

FORTRAN-80 **\$349** DATASTAR **\$230**

COBOL-80 **\$574** DBASE II **\$525**

PL/1-80 **\$425** CONDOR III **\$716**

PASCAL MT + V5.5 **\$398** MILESTONE **\$235**

WHITESMITH'S C **\$660** SUPERCALC **\$221**

BSTAM, BSTMS **\$200** FMS-80 **\$649**

CB-80 **\$420** SELECTOR V **\$396**

PEARL (LEVEL 3) **\$549** SPELLGUARD **\$236**

LIFEBOT SOFTWARE **\$C** SUPERSOFT **\$C**

PEACHTREE **\$C** AMERICAN BUS. SYST. **\$C**

GRAHAM-DORIAN **\$C** ACCOUNTING PLUS **\$C**

STRUCTURED SYST. **\$C** TURBODDS (MULTI) **\$500**

VANDATA/OSBDRNE **\$500** TURBODDS (1 USER) **\$220**

8" DISK DRIVE SALE

8" SHUGART SA801R **\$450** 8" SHUGART SA 851R **\$669** 2 for **\$1289**

QUME DATATRACK 8 **\$550** 2 for **\$1050**

Enclosure, power supply for 2 8" drives A & T **\$399**

MORROW DISCUS 2D + CP/M[®], MICROSOFT BASIC, CONT. **\$950**

HARD DISK SPECIALS

CORVUS 5MB, 10MB, 20MB Constellation Multiplexer and Mirror Backup

MORROW 26MB + controller + CP/M 2.2[®], M basic **\$4495** **\$3821**

controller, CDC Hawk Drive (5 fix, 5 rem) **\$7995** **\$6795**

controller, Western Dynex (5 fix, 5 rem) **\$5995** **\$5099**

RD5 & **XCOMP** 5 1/4", 8" and 14" Winchester/tape subsystems avail.

FULLY CONFIGURED BUSINESS SYSTEMS

The following are some examples of the fully assembled and tested business and scientific computer systems which we offer.

IMS The Premier Multi-User Computer System
8000 SX, multi-user, multi-processor, turbo DOS **\$C**

INTERNATIONAL CPM 2.2. FULL 2 YEAR WARRANTY!

On-Site Service Contracts Available

68000 16 bit multi-user UNIX V.7 **\$C**

SEATTLE COMPUTER 8086 16 bit, 128K RAM, Syst. #2 **\$3499**

Systems Group Call us for best prices on these high quality 2nd generation boards and systems.

California Computer Systems These high quality, reliable products have made CCS defacto industry standard for S-100 products

Assembled and tested:

2200 H.D. Mainframe **\$525** 2810A Z-80 CPU, serial port **\$316**

CCS 2210A w/floppy controller, 1 serial port **\$427**

CCS 300-1A w/1.2 MB floppy drives, 2 serial, 2 parallel ports **\$2116**

Computer Systems Fast 6 Mhz, Cache Bios Computers **\$C**

ADVANCED MICRO DIGITAL Single Board S-100 Computers **\$C**

GODBOUN We offer generous discounts on the Compupro line of

electronics™ fast, quality 8 and 16 bit boards

NorthStar **ADVANTAGE & HORIZON** **\$C**

NEC PC-800—The Professional's

Work Station. Applications for Industrial Control **\$C**

DELTA S-4500 10 User, Multi-Processor, 40 MB hard 17 MB tape **\$C**

ALTOS single and multi-user systems **\$C**

MORROW DESIGNS Decision 1, CP/M Microsoft Basic, UNIX **\$C**

XEROX 820 Desktop computer-64K, 2 floppys. (CP/M avail.) **\$C**

List **\$2995**

Similar savings on the full lines of CCS, SSM, NNC, MORROW, DELTA, TELEVIDEO, DIGIAC, ZENITH, ADOS, DEC, DATA GEN., ATARI, DYNABYTE, TECMAR, DUAL, AND MANY OTHERS

LOOK HERE! **AMPEX** Dialogue 81" 

Call us for ALL your software needs

Systems Houses, Educational Institutions, &

Government Agencies Given Special Consideration

ALL OF OUR PERIPHERALS CAN BE CONFIGURED FOR RADIO SHACK[®] MODEL II

DEALER and INTERNATIONAL INQUIRIES WELCOME

For fast delivery, send certified check, money order or call to arrange direct bank wire transfer. Personal or company checks require two to three weeks to clear. All prices are mail order only. Prices subject to change without notice; call for latest prices. Prices include 3% cash discount. N.Y. residents add sales tax. Qantex is a trademark of North Atlantic Industries, Inc. Radio Shack[®] is a trademark of the Tandy Corp. CP/M[®] is a trademark of Digital Research. All sales subject to our standard sale conditions (available on request).

MEMOREX Flexible Discs

SAVE 40% Write for your complete list.

5 1/4" Specify soft, 10 or 16 sector Price/10

1 Side, double density \$24.70
2 Sides, double density 36.40
1 Side, 80 track, double density 32.50
2 Sides, 80 track, double density 44.20
(All 5 1/4" have Hub-rings)

8" Specify soft or 32 sector

1 Side, single density 23.40
1 Side, double density 30.60
2 Sides, double density 35.80

CHECKS — VISA — MC — C.O.D.
(313) 777-7780 ADD \$2 SHIPPING

LYBEN COMPUTER SYSTEMS
27204 Harper Ave.
St. Clair Shores, MI 48081

Circle 226 on inquiry card.

NEC America



**PC-8000 Series
Microcomputer
System.**

- SYSTEMS
- PRINTERS
- SERVICE
- COMPONENTS
- SOFTWARE
- ADD-ONS

For Pricing and Catalog Call or Write



Development Systems Co.
2100-A Walsh Ave.
Santa Clara, CA 95050
Phone: (408) 727-1549

Circle 133 on inquiry card.

80,000 WORDS!

WORD BRINDER IS AN ASCII DICTIONARY OF OVER 80,000 ENGLISH WORDS WHICH IS COMPATIBLE WITH THE POPULAR PROOF READERS SUCH AS SPELLSTAR, SPELLGUARD, AND ANY OTHER PROOFER WHICH ALLOWS THE COMBINING OF ASCII FILES INTO ITS DICTIONARY. WORD BRINDER REQUIRES 3/4 MEGA-BYTE OF STORAGE AND IS AVAILABLE ON 1 FILE ON EACH OF 4 CP/M DISKS, ALSO AVAILABLE ON ANSI TAPE, TRS-80, RT-11, OR APPLE DISKS. PRICES START AT \$125.00 FOR CP/M. ORDERS: DIGITAL WORD SYSTEMS DEPT. B, 22713 VENTURA BL. STE. F, WOODLAND HILLS CA. 91364. VISA/M.C. PHONE: 213-992-0514

SPELLSTAR IS A TRADEMARK OF MICROPRO INTERNATIONAL CORP. OF SAN RAFAEL, CALIF. U.S.A.
SPELLGUARD IS A TRADEMARK OF ISA.
TRS-80 IS A TRADEMARK OF TANDY CORP.
CP/M IS A TRADEMARK OF DIGITAL RESEARCH.

Circle 208 on inquiry card.

NEC PC-8000 Computer System

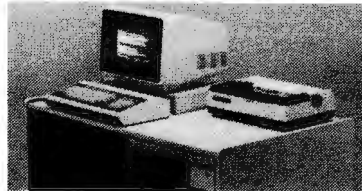

*PC-8001A Keyboard \$809.88
*PC-8012A I/O Unit \$534.88
PC-8023A-C Printer \$499.88
*PC-8031A Disk Drives \$809.88
PC-8032A Add-on Drives \$709.88
PC-8041A Monitor \$184.88
NC-8500 Wedge \$514.88

*Additional 5% discount for complete system purchase
HIGH TECHNOLOGY AT AFFORDABLE PRICES

**THE BOTTOM
LINE**

Orders & Information
(603)-673-8857

Orders Only
(800)-343-0796

12 Johnson Street, Milford NH 03055

Circle 57 on inquiry card.



Entertainer Kit . 88.00 Atari 800 16K . 710.00
Programmer Kit . 56.00 Atari 400 16K . 359.00
Communicator Kit 320.00 Atari 410 Cassette 80.00
Microsoft Basic . 72.00 Atari 810 Disk . 480.00

**ALL ATARI SOFTWARE 20% OFF
Plus Loads of 3rd Party Software!
VOTRAX TYPE'N'TALK: 340.00
ALSO EPSON & CENTRONICS PRINTERS
ZENITH & TELEVIDEO TERMINALS**

BBI Mail Order is a company made up of computer professionals. We are able to provide low prices as well as technical support. Give us a call and find out why we consider the Atari the best home computer on the market today. You won't be disappointed.



BBI Mail Order

Specializing in Atari Home Computers
P.O. Box 365
Newton Highlands, MA 02161
(617) 964 3080

Circle 45 on inquiry card.



LEO ELECTRONICS, INC.
8921 S. Sepulveda #208
Los Angeles, CA 90045
(213) 641-3101 (800) 421-2418

**WHY PAY MORE? SAVE MONEY!
LOWEST PRICES ON PARTS!**

EPROMS		REGULATORS	
2708	2.60	7805	.75
2716	4.00	7812	.75
2716-1(350ns)	6.50	7815	.75
TMS 2716	6.00	7905	.85
2732	10.00	7912	.85
2532	12.00	7915	.85

RAMS		MICROPROCESSORS	
4116(200ns)	8/13.00	Z-80A-CPU	5.50
4116(150ns)	8/16.00	8080A	2.25
2114(200ns)	8/18.00	8085A	7.00

TERMS: Check, Visa, Mastercard Call for C.O.D
U.S. Funds only California Residents add 6% Sales Tax
SHIPPING: Add \$2.00 for Ground \$5.00 for Air.
**ALL MAJOR MANUFACTURERS
ALL PARTS 100% GUARANTEED**

Circle 218 on inquiry card.

THE SBC 8671

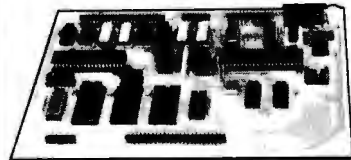

Z8* CONTROL

FEATURES: Zilog Z8671 microprocessor with on chip basic interpreter: 12K of on board user memory with choice of ROM, RAM, or PROM, selectable in 4K increments: RS 232 and 20 MA current loop serial I/O: 110 to 9600 baud: 8255 peripheral interface with choice of TTL, R-Pack, or Open Collector I/O buffers: 48 parallel I/O lines total: Pin compatibility with industry standard OPTO I/O modules: Two 8 bit counter timers with 6 bit prescalers: 6 vectored interrupts: Module bus for full expansion: All chips socketed: Industrial grade construction.

Price (1-9) \$295.00

* Z8 a trademark of Zilog Corp.

LEHMANN & ASSOCIATES
P.O. Box 566, Maumee, Ohio 43537
(419) 891-0687

Circle 217 on inquiry card.

Diagnostics and Treatment for your CP/M* Computer

TINYDOC™ 29.95 p.p.
(8 1/2" x 5 1/4" CP/M Disk)

Tests and diagnoses I/O, Memory, Disk-System, CPU; reads file parameters and mends files under software control; pinpoints bad chips, etc. (If 5 1/4" disk, specify)

MICRO SERVICE GUIDE I
"CP/M Computer System Servicing" 7.95 p.p.

MICRO SERVICE GUIDE II
"SA800/801 Disk Drive Servicing" 9.95 p.p.

MICRO SERVICE GUIDE books are written for anyone with basic electronic knowledge and ability to use screwdrivers. The appendix provides detailed repair techniques for people with soldering iron and an oscilloscope.

US Funds only. Foreign orders add \$8.00. Personal checks take 3-4 weeks. California residents add 6% tax. All orders are confirmed by mail. Write for technical details.

R. F. & ASSOCIATES
1930 Purdue Ave.
Los Angeles, California 90025
(213) 477-8310

*Trademark of Digital Research

Circle 167 on inquiry card.

DEBUG FAST



NEW

If you program, engineer, test, or repair micros, try this new invention and save endless time and effort. Shows you program flow, address, data, I/O, and timing info on 256 LEDs. Gives telescopic and microscopic views of memory. Traces instabilities. Supports most micros. Easy to learn and use. Full CPU speed. Quick setup. Rugged. Portable (10x8x2"). Lowest cost tool in its class - just \$995 complete. Circle, call, or write us now. Micro Logic Corp. POB 174-B, 100 2nd St, Hackensack, NJ 07602, (201) 342-6518.

Circle 423 on inquiry card.

Orange County ● Sunnyvale San Diego ● Los Angeles San Fernando Valley ● Dallas

Dot Matrix Printers

NEW EPSONS with GRAFTRAX-plus

Epson has improved and upgraded their best selling line of printers to include their new GRAFTRAX-plus graphics package. Features now include: 9 x 9 matrix, bi-directional/logic seeking, line spacing to n/216, programmable forms length and horizontal tabs, skip over perf, italics fonts, international symbols, superscript/subscript, normal, emphasized, double-strike, and double-emphasized print, underlining, line drawing graphics, 60/120 DPI bit image, software reset, adjustable right margin, and true back space.

MX-80 with GRAFTRAX-plus 80 column, 80 CPS, adjustable pin feed.

PRM-28080 MX-80 w/GRAFTRAX-plus \$479.95

MX-80FT with GRAFTRAX-plus same as MX-80 with friction feed added.

PRM-28082 MX-80FT w/GRAFTRAX-plus \$559.95

MX-100 with GRAFTRAX-plus 132 column, correspondence quality, up to 15" paper, friction feed & adjustable pin feed, 9 x 9 dot matrix, 80 CPS.

PRM-28100 MX-100 w/GRAFTRAX-plus \$754.95

PRA-27084 Serial interface	\$54.95
PRA-27088 Serial intf & 2K buffer	\$144.95
PRA-27081 Apple card	\$39.95
PRA-27082 Apple cable	\$19.95
PRA-27086 IEEE 488 card	\$52.95
PRA-27087 TRS-80 cable	\$24.95
PRA-27085 GRAFTRAX II	\$59.95
PRA-28085 GRAFTRAX-plus	\$79.95
PRA-27090 Extra print head	\$44.95
PRA-27083 MX-80 ribbon cart.	\$13.95
PRA-27101 MX-100 ribbon only	\$9.95

BETTER THAN EPSON! - Okidata

Microline 82A 80/132 column, 120 CPS, 9 x 9 dot matrix, friction feed, pin feed, adjustable tractor feed (optional), handles 4 part forms up to 9.5" wide, rear & bottom feed, paper tear bar, 100% duty cycle/200,000,000 character print head, bi-directional/logic seeking, both serial & parallel interfaces included, front panel switch & program control of 10 different form lengths, uses inexpensive spool type ribbons, double width & condensed characters, true lower case descenders & graphics

PRM-43082 Friction & pin feed \$499.95 |

Microline 83A 132/232 column, 120 CPS, handles forms up to 15" wide, removable tractor, plus all the features of the 82A.

PRM-43083 with FREE tractor \$744.95 |

Microline 84 132/232 column, 200 CPS, full dot graphics built in, handles forms up to 15" wide, plus all the features of the 83A.

PRM-43084 Centronics parallel \$1149.95 |

PRM-43085 Serial with 2K buffer \$1249.95 |

PRA-27081 Apple card	\$39.95
PRA-27082 Apple cable	\$19.95
PRA-27087 TRS-80 cable	\$24.95
PRA-43081 2K hi speed serial card	\$169.95
PRA-43082 Hi-res graphics ROMs 82A	\$79.95
PRA-43083 Hi-res graphics ROMs 83A	\$79.95
PRA-43088 Tractor option for 82A	\$39.95
PRA-43080 Extra ribbons pkg. of 2	\$9.95

PRINTER PAL - F.M.J. Inc.

Desk top printer stand an paper holder

PRA-99080 for MX-80, FT, Oki 82A, NEC \$24.95 |

PRA-99100 for MX-100, Oki 82A & 84 \$29.95 |

Terminals

VIDEO TERMINALS - Televideo

Inexpensive full-featured video terminals

VDT-901210 Televideo 910	\$685.00
VDT-901213 Televideo 912	\$775.00
VDT-901221 Televideo 920	\$845.00
VDT-901225 Televideo 925	\$865.00
VDT-991250 Televideo 950	\$1095.00

Dual Disk Sub-Systems

Disk Sub-Systems - Jade

Handsome metal cabinet with proportionally balanced air flow system, rugged dual drive power supply, power cable kit, power switch, line cord, fuse holder, cooling fan, neoprene rubber feet, all necessary hardware to mount 2-8" disk drives, power supply, and fan, does not include signal cable.

Dual 8" Sub-Assembly Cabinet

END-000420 Bare cabinet	\$59.95
END-000421 Cabinet kit	\$225.00
END-000431 A & T	\$359.95

8" Sub-Systems - Single Sided, Double Density

END-000423 Kit w/2 FD100-8Ds	\$975.00
END-000424 A & T w/2 FD100-8Ds	\$1175.00
END-000433 Kit w/2 SA-801Rs	\$999.95
END-000434 A & T w/2 SA-801Rs	\$1195.00

8" Sub-Systems - Double Sided, Double Density

END-000426 Kit w/2 DT-8s	\$1224.95
END-000427 A & T w/2 DT-8s	\$1424.95
END-000436 Kit w/2 SA-851Rs	\$1274.95
END-000437 A & T w/2 SA-851Rs	\$1474.95

Letter Quality Printers

LETTER QUALITY PRINTER - Jade

Uses standard daisy wheels and ribbon cartridges, 16 CPS bi-directional printing, semi-automatic paper loader (single sheet or fan fold), 10/12/15 pitch, up to 16" paper, built-in noise suppression cover.

PRD-11001 Centronics parallel	\$959.95
PRD-11002 RS-232C serial model	\$999.95

STARWRITER F-10 - C. Itoh

New 40 CPS daisy wheel printer with full 15" carriage, uses standard Diablo print wheels and ribbons, both parallel and serial interfaces included.

PRD-22010 Starwriter F-10 \$1595.95 |

80 CPS LETTER QUALITY - Fujitsu

High speed daisy wheel printer with both RS-232C serial & Centronics parallel interfaces, emulates NEC 5510, Diablo 630, Qume, and will interface to the IBM Personal Computer, features include Z-80 CPU, 16K buffer (48K optional), bi-directional printing, & baud rates up to 19.2K

PRD-86100 Fujitsu with 16K	\$2895.00
PRD-86200 Fujitsu with 48K	\$3195.00
PRA-86000 Adjustable tractor	\$190.00

Jade Bus Probe

THE BUS PROBE - Jade

Inexpensive S-100 Diagnostic Analyzer

So your computer is down. And you don't have an oscilloscope. And you don't have a front panel... You're not alone - most computers have their occasional bad days. But without diagnostic equipment such as an oscilloscope (expensive!) or a front panel (expensive!), it can be very difficult to pinpoint the problem. Even if you have an extender board with a superfast logic probe, you can't see more than one signal at a time. You're stuck, right?

Not anymore; Jade is proud to offer our cost-effective solution to the problems mentioned above: **THE BUS PROBE**.

Whether you're a hobbyist with a cantankerous kluge or a field technician with an anxious computer owner breathing down your neck, you'll find **THE BUS PROBE** speeds your repair time remarkably. Just plug in **THE BUS PROBE** and you'll be able to see all the IEEE S-100 signals in action. **THE BUS PROBE** allows you to see inputs, outputs, memory reads and writes, instruction fetches, DMA channels, vectored interrupts, 8 or 16 bit wide data transfers, plus the three bus supply voltages.

An on-board pulse generator can provide repetitive resets, interrupts, or wait states, for trouble shooting.

TSX-200B Bare board	\$59.95
TSX-200K Kit	\$119.95
TSX-200A A&T	\$149.95

Prices may be slightly higher at our retail locations. Please contact the store in your area for exact pricing.

5 1/4" Disk Drives

Tandon TM100-1 single-sided double-density 48 TPI
MSM-551001 \$248.95 ea 2 for \$219.95 ea

Shugart SA400L single-sided double-density 40 track
MSM-104000 \$234.95 ea 2 for \$224.95 ea

Tandon TM100-2 double-sided double-density 48 TPI
MSM-551002 \$324.95 ea 2 for \$298.95 ea

Shugart SA450 double-sided double-density 35 track
MSM-104500 \$349.95 ea 2 for \$329.95 ea

Tandon TM100-3 single-sided double-density 96 TPI
MSM-551003 \$324.95 ea 2 for \$298.95 ea

Tandon TM100-4 double-sided double-density 96 TPI
MSM-551004 \$448.95 ea 2 for \$419.95 ea

MPI B-51 single-sided double-density 40 track
MSM-155100 \$234.95 ea 2 for \$224.95 ea

MPI B-52 double-sided double-density 40 track
MSM-155200 \$344.95 ea 2 for \$334.95 ea

MPI B-91 single-sided double-density 77 track
MSM-155300 \$369.95 ea 2 for \$359.95 ea

MPI B-92 double-sided double-density 77 track
MSM-155400 \$469.95 ea 2 for \$459.95 ea

5 1/4" Cabinets with Power Supply
END-000216 Single cab w/power supply \$69.95 |

END-000226 Dual cab w/power supply \$94.95 |

8" Disk Drives

Shugart SA801R single-sided double-density
MSF-10801R \$394.95 ea 2 for \$389.95 ea

Shugart SA851R double-sided double-density
MSF-10851R \$554.95 ea 2 for \$529.95 ea

Tandon TM848-1 single-sided double-den thin-line
MSF-558481 \$424.95 ea 2 for \$394.95 ea

Tandon TM848-2 double-sided double-den thin-line
MSF-558482 \$574.95 ea 2 for \$549.95 ea

Qume DT-8 double-sided double-density
MSF-750080 \$524.95 ea 2 for \$498.95 ea

Siemens FDD 100-8 single-sided double-density
MSF-201120 \$384.95 ea 2 for \$349.95 ea

Software

PLANNER CALC - Target Software

Spread sheet (what if ?) program designed for with the user in mind, user oriented (simple english) commands allow you to quickly master this powerful software, supplied on 8" disk for use with CP/M based systems.

SFC-12251050F 8" CP/M version \$49.95 |

SFC-12251053F 8" Xerox \$49.95 |

SFC-12251053M 5 1/4" Xerox \$49.95 |

Place Orders Toll Free

Continental U.S. Inside California

800-421-5500 800-262-1710

For Technical Inquiries or Customer Service call:

213-973-7707

JADE Computer Products

4901 W. Rosecrans, Hawthorne, Ca 90250

TERMS of SALE: Cash, checks, credit cards, or Purchase Orders from qualified firms and institutions.

Minimum Order \$15.00. California residents add 6% tax. Minimum shipping & handling charge \$3.00.

Pricing & availability subject to change

JADE

Computer Products

3313 South Bristol St.
Santa Ana 714-549-7108

**PLACE ORDERS
TOLL FREE.**

JADE

Computer Products

1291 West El Camino Real
Sunnyvale 415-965-7980

**Continental U.S. - 800-421-5500
Inside California - 800-262-1710
Los Angeles Area - 213-973-7707**

JADE

Computer Products

4344 Convoy Street
San Diego 714-268-4661

Jade Diskettes

PREMIUM DISKETTES - Jade

We proudly put our name on these high quality diskettes - guaranteed to satisfy you or your money back.

5 1/4" Diskettes, Box of Ten		
MMD-5110103	SS, SD, 01S	\$29.00
MMD-5111003	SS, SD, 10S	\$29.00
MMD-5111603	SS, SD, 16S	\$29.00
MMD-5120103	SS, DD, 01S	\$31.00
MMD-5121003	SS, DD, 010	\$31.00
MMD-5121603	SS, DD, 16S	\$31.00

8" Diskettes, Box of Ten		
MMD-8110103	SS, SD, 01S	\$31.00
MMD-8120103	SS, DD, 01S	\$39.00
MMD-8220103	DS, DD, 01S	\$48.00

BARGAIN DISKETTES		
MMD-5110105	5 1/4" SS, DD, 01S	\$19.95
MMD-5220105	5 1/4" DS, DD, 01S	\$32.95
MMD-8110105	8" SS, SD, 01S	\$21.95
MMD-8120105	8" SS, DD, 01S	\$32.95
MMD-8220105	8" SS, DD, 01S	\$35.95

Video Monitors

9" AMBER or GREEN - Jade

High resolution 18 MHz compact video monitors.		
VDM-901201	9" Amber phosphor	\$149.95
VDM-901301	9" Green phosphor	\$139.95

HI-RES 12" GREEN - Zenith

15 MHz bandwidth 700 lines/inch, P31 green phosphor, switchable 40 or 80 columns, small, light-weight & portable.		
VDM-201201	List price \$189.95	\$129.95

12" GREEN SCREEN - NEC

20 MHz bandwidth, P31 phosphor ultra-high resolution video monitor with audio.		
VDM-561200	List price \$289.95	\$199.95

12" COLOR MONITOR - NEC

High resolution color monitor with audio.		
VDC-651212	Color monitor	\$389.95
NEC-1202D	RGB color monitor	\$999.95

COLOR MONITORS - Amdek

Reasonably priced color video monitors.		
VDC-80130	13" Color I	\$379.95
VDC-801320	13" Color II	\$694.95
IOV-2300A	DVM board for Apple	\$199.95

COLOR TELEVISION - Bohsei

High quality inexpensive color televisions with excellent color, brilliance, & reception, both UHF & VHF, perfect for Apple II, Atari, Commodore VIC-20, or TRS color computer.		
VDC-991300	13" Color receiver	\$239.95
VDC-991900	19" Color receiver	\$299.95

EPROM Erasers

ULTRA-VIOLET EPROM ERASERS

Inexpensive erasers for industry or home.		
XME-3100A	Spectronics w/o timer	\$69.50
XME-3101A	Spectronics with timer	\$94.50
XME-3200A	Economy model	\$39.95

Power Strips

ISOBAR - GSC

Isolates & protects your valuable equipment from high voltage spikes & AC line noise, inductive isolated ground, 15 amp circuit breaker, U.L. listed		
EME-115103	3 socket	\$39.50
EME-115105	4 socket	\$49.50
EME-115100	8 socket	\$54.50
EME-115110	9 socket rackmount	\$74.50

Single User System

THREE BOARD SET - SD Systems

4 MHz Z-80A CPU, 64K RAM (optional 256K), serial I/O port, parallel I/O port, double density disk controller, CP/M 2.2 & manual set, system monitor, control & diagnostic software. Includes SBC-200, 64K ExpendoRAM II, Versafloppy II, & CP/M 2.2 - all boards are assembled & tested.
Board set with 64K of RAM \$1095.00
Board set with 256K of RAM \$1295.00

Apple II Accessories

16K RAM CARD - for Apple II

Expand your Apple to 64K, 1 year warranty
MEX-16700A Save \$125.00 !!! \$74.95

Z-80 SOFTCARD - MicroSoft

Two computers in one, Z-80 & 6502, more than doubles the power and potential of your Apple, includes Z-80 CPU card CP/M 2.2, & Basic 80.
CPX-30800A A & T with software \$299.95

8" DISK CONTROLLER - Vista

New from Vista Computer, single or double sided, single or double density, compatible with DOS 3.2/3.3, Pascal, & CP/M 2.2, Shugart & Qume compatible
IOD-2700A A & T \$499.95

2 MEGABYTES for Apple II

Complete package includes: Two 8" double-density disk drives, Vista double-density 8" disk controller, cabinet, power supply, & cables, DOS 3.2/3.3, CP/M 2.2, & Pascal compatible.

1 MegaByte Package Kit	\$1495.00
1 MegaByte Package A & T	\$1695.00
2 MegaByte Package Kit	\$1795.00
2 MegaByte Package A & T	\$1995.95

A2 DISK DRIVE - Micro Sci

Inexpensive direct replacement for Apple Disk II, works with Apple II controller as first or second drive.
MSM-123101 Micro Sci A2 \$379.95
MSM-123101C A2 with contrl \$459.95

VISION 80 - Vista Computer

80 column x 24 line video card for Apple II, 128 ASCII characters, upper and lower case, 9 x 10 dot matrix with 3 dot descenders, standard data media terminal control codes, CP/M Pascal & Fortran compatible, 50,60 Hz
IOV-2400A Vista Vision 80 \$299.95

CPS MULTICARD - Mtn. Computer

Three cards in one! Real time clock/calendar, serial interface, & parallel interface - all on one card.
IOX-2300A A & T \$179.95

APPLE-CAT - Novation

Software selectable 1200 or 300 baud, direct connect, auto-answer/auto-dial, auxiliary 3-wire RS232C serial port for printer.
IOM-5232A Save \$50.00!!! \$325.95

JOYSTICK - T G Products

A better joystick for your Apple II
SYA-1512A A & T \$49.95

Modems

SIGNALMAN - Anchor

Direct-connect automatic answer/originate selection, 300 Baud full duplex, Bell 103, includes RS-232 cable
IOM-5600A Signalman \$98.50

SMARTMODEM - Hayes

Sophisticated direct-connect auto-answer/auto-dial modem, touch-tone or pulse dialing, RS-232C interface, programmable
IOM-5400A Smartmodem \$248.95
IOK-1500A Hayes Chronograph \$218.95
IOM-2010A Micromodem II \$328.95
IOM-1100A Micromodem 100 \$368.95

Single Board Computer

SUPERQUAD - Adv. Micro Digital

Single board, standard size S-100 computer system, 4 MHz Z-80A, single or double density disk controller for 5 1/4" or 8" drives, 64K RAM, extended addressing, up to 4K of EPROM, 2 serial & 2 parallel I/O ports, real time interrupt clock, CP/M compatible.
CPC-30800A A & T \$794.95
IOX-30800A Serial I/O adapter \$29.95

Z-80 STARTER KIT - SD Systems

Complete Z-80 microcomputer with RAM, ROM, I/O, keyboard, display, kludge area, manual, & workbook.
CPS-30100K Kit with workbook \$299.95
CPS-30100A A & T with workbook \$499.95

AIM-65 - Rockwell International

Complete 6502 microcomputer with alphanumeric display, printer, keyboard, & instruction manual.
CPK-50165A 1K AIM-65 \$424.95
CPK-50485A 4K AIM-65 \$474.95
SFK-74600008E 8K Basic ROM \$64.95
SFK-64600004E 4K assembler ROM \$43.95
SFK-74600020E PL/65 ROM \$84.95
SFK-74600010E Forth ROM \$64.95
SFK-74600030E Instant Pascal \$99.95
PSX-030A Power supply \$64.95
ENX-000002 Enclosure \$54.95
4K AIM-65, 8K Basic, power supply, & enclosure
Special Package Price \$649.95

S-100 EPROM Boards

PB-1 - SSM Microcomputer

2708, 2716 EPROM board with on-board programmer.
MEM-99510K Kit with manual \$154.95
MEM-99510A A & T with manual \$219.95

PROM-100 - SD Systems

2708, 2716, 2732 EPROM programmer with software.
MEM-99520K Kit with software \$189.95
MEM-99520A A & T with software \$249.95

EPROM BOARD - Jade

16K or 32K uses 2708 or 2716 EPROMs, 1K boundary.
MEM-16230K Kit w/o EPROMs \$79.95
MEM-16230A A & T w/o EPROMs \$119.95

S-100 Video Boards

SPECTRUM COLOR - CompuPro

Full-function color graphics board, up to 8 colors, 256 x 192 graphics, parallel I/O port, 8K RAM
IOV-1870A A & T \$348.95
IOV-1870C CSC \$398.95

MICROANGELO - Scion

Ultra-high-resolution 512 x 480, 256 color or black & white S-100 video board
IOV-1500A A & T \$999.95

S-100 MotherBoards

ISO-BUS - Jade

Silent, simple, and on sale - a better motherboard
8 Slot (5 1/4" x 8 1/2")
MBS-061B Bare board \$19.95
MBS-061K Kit \$39.95
MBS-061A A & T \$59.95
12 Slot (9 1/4" x 8 1/2")
MBS-121B Bare board \$29.95
MBS-121K Kit \$69.95
MBS-121A A & T \$99.95
18 Slot (14 1/2" x 8 1/2")
MBS-181B Bare board \$49.95
MBS-181K Kit \$99.95
MBS-181A A & T \$139.95
ACTIVE TERMINATOR - CompuPro
A true mother's helper.
TSX-100A A & T \$59.45

Prices may be slightly higher at our retail locations. Please call the store nearest you for local price and availability.

Circle 203 on inquiry card.

**PLACE ORDERS
TOLL FREE.**

**Continental U.S. - 800-421-5500
Inside California - 800-262-1710
Los Angeles Area - 213-973-7707**

S-100 CPU Boards

8085/8086 - CompuPro

Both 8 & 16 bit CPUs, standard 8 bit S-100 bus, up to 8 MHz, accesses 16 Megabytes of memory.

CPU-20510A 6 MHz A & T \$398.95
CPU-20510C 6/8 MHz CSC \$497.95

8086/8087 - CompuPro

16 bit, 8 or 10 MHz 8086 CPU with provisions for 8087 & 80130

CPU-70520A 8 MHz 8086 A & T \$624.95
CPU-70520C 8 MHz 8086 CSC \$764.95
CPU-70530A with 8087 A & T \$1224.95
CPU-70530C with 8087 CSC \$1455.95

CPU-Z - CompuPro

2/4 MHz Z80A CPU, 24 bit addressing.

CPU-30500A 2/4 MHz A & T \$279.95
CPU-30500C 3/6 MHz CSC \$374.95

SBC-200 - SD Systems

4 MHz Z-80A CPU with serial & parallel I/O, 1K RAM, 8K ROM space, monitor PROM included.

CPC-30200A A & T \$399.95

THE BIG Z - Jade

2 or 4 MHz switchable Z-80 CPU board with serial I/O, accommodates 2708, 2716, or 2732 EPROM, baud rates from 75 to 9600

CPU-30201B Bare board w/manual \$35.00
CPU-30201K Kit with manual \$139.95
CPU-30210A A & T with manual \$199.95

CB-2 - SSM Microcomputer

2 or 4 MHz Z-80 CPU board with provision for up to 8K of ROM or 4K of RAM on board, extended addressing, IEEE S-100, front panel compatible.

CPU-30300K Kit with manual \$229.95
CPU-30300A A & T with manual \$274.95

2810 Z-80 CPU - C.C.S.

2 or 4 MHz Z-80 CPU with serial I/O port & on-board monitor PROM, front panel compatible.

CPU-30400A A & T with PROM \$289.95

2820 Z-80 DMA CPU - C.C.S.

4 MHz Z-80 CPU board with 2 serial I/O ports & Centronics parallel I/O port, separate data & status ports, DMA daisy chain compatible.

CPU-30420A A & T with manual \$569.95

S-100 Disk Controllers

DISK 1 - CompuPro

8" or 5 1/4" DMA disk controller, single or double density, single or double sided, 10 MHz.

IOD-1810A A & T \$449.95
IOD-1810C CSC \$554.95
SFC-52506580F 8" CP/M 2.2 for Z-80 \$174.95
SFC-52506586F 8" CP/M 2.2 for 8086 \$299.95
SFO-54158000F Oasis single user \$499.95
SFO-54158002F Oasis multi-user \$849.95

DOUBLE D - Jade

High reliability double density disk controller with on-board Z-80A, auxiliary printer port, IEEE S-100, can function in multi-user interrupt driven bus.

IOD-1200B Bare board & h/w/r man \$59.95
IOD-1200K Kit w/h/w/r & s/w/r man \$299.95
IOD-1200A A & T w/h/w/r & s/w/r man \$359.95
SFC-59002001F CP/M 2.2 with Double D \$99.95

VERSAFLOPPY II - SD Systems

Double density disk controller for any combination of 5 1/4" and 8" single or double sided, analog phase-locked loop data separator, vectored interrupts, CP/M 2.2 & Oasis compatible, control/diagnostic software PROM included.

IOD-1180A A & T with PROM \$359.95
SFC-55009047F CP/M 2.2 with VF II \$99.95

2242 DISK CONTROLLER - C.C.S.

5 1/4" or 8" double density disk controller with on-board boot loader ROM, free CP/M 2.2 & manual set.

IOD-1300A A & T with CP/M 2.2 \$399.95

S-100 Memory Boards

256K RAMDISK - SD Systems

ExpandoRAM III expandable from 64K to 256K using 64K x 1 RAM chips, functions as ultra-high speed disk drive when used with optional RAMDISK software, compatible with CP/M, MP/M, Oasis, Cromemco, & most other Z-80 based systems.

MEM-65064A 64K A & T \$474.95
MEM-65128A 128K A & T \$574.95
MEM-65192A 192K A & T \$874.95
MEM-65256A 256K A & T \$774.95
SFC-55009000F RAMDISK s/w/r CP/M 2.2 \$24.95

128K RAM 21 - CompuPro

128K x 8 bit or 64K x 16 bit static RAM board, 12 MHz, 24 bit addressing.

MEM-12810A A & T \$1609.95
MEM-12810C CSC \$1794.95

64K EXPANDORAM II - SD Systems

Expandable RAM board from 16K to 64K using 4116 RAM chips.

MEM-16630A 16K A & T \$344.95
MEM-32631A 32K A & T \$364.95
MEM-48632A 48K A & T \$384.95
MEM-64633A 64K A & T \$399.95

64K RAM 17 - CompuPro

64K CMOS static RAM board, 10 MHz, low power less than 4 watts, DMA compatible, 24 bit addressing.

MEM-64180A 64K A & T \$549.95
MEM-64180C 64K CSC \$698.95

64K RAM 16 - CompuPro

32K x 16 bit or 64K x 8 bit low power static RAM board, 10 MHz, 24 bit addressing.

MEM-32180A RAM 16 A & T \$598.95
MEM-32180C RAM 16 CSC \$698.95

64K STATIC RAM - SSM

IEEE 696/S-100 standard, up to 6MHz/8 Bit, 12MHz/16 Bit, 24 Bit extended addressing, disable-able in 2K increments

MEM-64300A A & T \$749.95

64K STATIC RAM - Mem Merchant

64K static S-100 RAM card, 4 to 16K banks up to 8 MHz.

MEM-64400A 64K A & T \$594.95

2065 64K RAM - C.C.S.

4 MHz bank port/bank byte selectable, extended addressing, 16K bank selectable, front panel compatible.

MEM-64565A 64K A & T \$349.95

2066 64K RAM - C.C.S.

64K RAM board with bank and block select switching functions for Cromemco Cromix & Alpha Micro.

MEM-64566A 64K A & T \$424.95

MEMORY BANK - Jade

4 MHz S-100 bank selectable expandable to 64K.

MEM-99730B Bare board w/manual \$49.95
MEM-99730K Kit with no RAM \$179.95
MEM-32731K 32K kit \$199.95
MEM-64733K 64K kit \$249.95
Assembled & Tested add \$50.00

32K RAM 20 - CompuPro

32K static RAM, up to 10 MHz, disable-able in 4K banks, bank select or 24 bit addressing.

MEM-16180A 16K A & T \$259.95
MEM-16180C 16K CSC \$324.95
MEM-24180A 24K A & T \$324.95
MEM-24180C 24K CSC \$364.95
MEM-32185A 32K A & T \$384.95
MEM-32185C 32K CSC \$449.95

16K STATIC RAM - Mem Merchant

4MHz lo-power static RAM board, IEEE S-100, bank selectable, addressable in 4K blocks, disable-able in 1K segments extended addressing.

MEM-16171A 16K A & T \$154.95

S-100 I/O Boards

SYSTEM SUPPORT 1 - CompuPro

Real time clock, three 16 bit interval timers, dual interrupt controllers(15 levels), up to 4K EPROM/RAM, RS-232C serial channel, provision for 9511A/9512 math chip.

IOX-1850A SS1 A & T \$359.95
IOX-1850C SS1 CSC \$459.95
IOX-1855A with 9511 A & T \$554.95
IOX-1855C with 9511 CSC \$654.95
IOX-1880A with 9512 A & T \$554.95
IOX-1880C with 9512 CSC \$654.95

INTERFACER 1 - CompuPro

2 serial I/O ports 50-19 2K baud

IOI-1810A A & T \$218.95
IOI-1810C CSC \$288.95

INTERFACER 2 - CompuPro

3 parallel, 1 serial, & interrupt timer.

IOI-1820A A & T \$218.95
IOI-1820C CSC \$288.95

INTERFACER 3 - CompuPro

5 or 8 channel serial I/O board for interrupt driven multi-user systems up to 250K baud.

IOI-1835A 5 port A & T \$558.95
IOI-1835C 5 port CSC \$628.95
IOI-1838A 8 port A & T \$628.95
IOI-1838C 8 port CSC \$749.95

INTERFACER 4 - CompuPro

3 serial, 1 parallel, 1 Centronics parallel.

IOI-1840A A & T \$314.95
IOI-1840C CSC \$414.95

MPX - CompuPro

Multi-user I/O multiplexer & interrupt controller with on-board 8085A-2 CPU & 4K or 16K of RAM.

IOI-1875A 4K MPX A & T \$444.95
IOI-1875C 4K MPX CSC \$534.95
IOI-1880A 16K MPX A & T \$584.95
IOI-1880C 16K MPX CSC \$674.95

I/O-4 - SSM Microcomputer

2 serial I/O ports plus 2 parallel I/O ports.

IOI-1010B Bare board w/manual \$35.00
IOI-1010K Kit with manual \$179.95
IOI-1010A A & T with manual \$249.95

I/O-5 - SSM Microcomputer

Two serial & 3 parallel I/O ports, 110-19 2K Baud

IOI-1015A A & T \$289.95

I/O-8 - SSM Microcomputer

Eight software programmable serial I/O ports, 110 -19 2K Baud, ideal for multi-user systems

IOI-1018A A & T \$469.95

MPC-4 - SD Systems

Intelligent 4-port serial I/O card, on-board Z-80A, 2K RAM, 4K PROM area, on-board firmware, fully buffered, vectored interrupts, four CTC channels, add to SD Board set for powerful multi-user system

IOI-1504A A & T w/software \$495.00

2719 2 SER & 2 PAR - C.C.S.

Two RS-232C serial I/O ports plus two 8 bit parallel I/O ports

IOI-1080A A & T with manual \$349.95

2710 4 PORT SERIAL - C.C.S.

Four RS-232C serial I/O ports with full handshaking.

IOI-1080A A & T with manual \$319.95

2830 6 PORT SERIAL - C.C.S.

Six asynchronous RS-232C serial I/O ports with programmable baud rates

IOI-1040A A & T with manual \$529.95

Prices may be slightly higher at our retail locations. Please call the store nearest you for local price and availability.

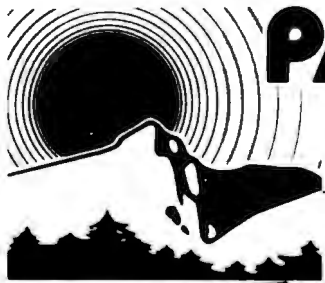

PALOMAR TAKES THE RISK

...Join the thousands of satisfied customers who buy fast response, expert technical help, and



EPSON

Features disposable print heads. Graphtrax. All models except MX-70 print text in two directions. MX-80F/T and MX-100 have both friction and tractor feed. Unparalleled dot placement accuracy. All print 80 CPS.

- MX-80 (80 col.) CALL
- MX-80 F/T (80 col.) CALL
- MX-100 (136 col.) CALL
- Interface Cards CALL
- Cables CALL



NEC-8023 A

High resolution dot graphics. Proportional spacing. Correspondent quality printing. Bidirectional tractor and friction feed. 80, 136 col. Greek and math symbols. 100 CPS matrix printer.

8023A Parallel List \$780 \$540.



C ITOH

Pro/Writer offers 8 character sizes, 5 different alphabets, proportional spacing, bidirectional, vert and horiz. tabs, high resolution graphics, nx9 matrix, 100 CPS 136 col. max. Friction and tractor feed.

8510 Serial \$645.
8510 Parallel 495.



ADLER

11 or 17.5 CPS, 10, 12, 15 CPI and proportional spacing. 2 line correcting memory. interchangeable print wheels.

SE 1010 List \$1295 \$995.
Interface Card ADD 350.

PRINTERS

JUST ARRIVED!
**SMITH-CORONA
TP-1
DAISY WHEEL**
ONLY \$895

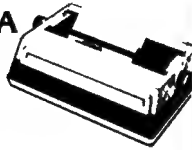

Letter quality price breakthrough! Serial or parallel data interface. 12 CPS, 10 or 12 CPI.
Smith-Corona TP-1 \$895.



OLYMPIA DAISY WHEEL

Letter quality printer typewriter interfaces to Apple, Atari, NEC, TRS80 and RS232 Serial ports. 17.5 CPS., 10, 12 CPI.

- ES 100KRO Computer printer
List \$1690 \$1295
- ES 100 Typewriter Only
List \$1195 995.
- Interface Card Only 250.
(specify serial or parallel)
- I/O Serial (specify serial or parallel) ... 25.
- Apple Serial Card 139.



LOW PRICE ON NOVELL!

Heavy duty, 150 CPS, bidirectional tractor feed, 9x9 dot matrix, 6 or 8 lines per inch. 10, 13.6 or 16.5 CPI, E17 RS-232C or parallel interface.

IMAGE 800 \$995.

RIBBONS

- NEC \$77/Doz.
- Qume 45/Doz.
- Diablo 66/Doz.
- Anadex 135/6 ea.
- Tritel 95/Doz.
- TI/DEC/TTY 45/Doz.
- Epson 13.95/ea.
- MPI/Axiom/Base 2 13.95/ea.



NEC SPINWRITERS

Letter quality printers: 7700 serial print 55 CPS, 3500 series print 33 CPS. Both series offer up to 128 char., take paper up to 16 in. wide. 7700 series: 136 col. at 10 CPI, 163 col. at 12 CPI. Same for 3500 series plus 204 col. at 15 CPI.

- 7710/7730 RO w/tractor \$2475.
- 7720 KSR w/tractor 2850.
- 3510/3530 RO 1695.
- Bidirectional tractor 200.
- Push tractor 350.

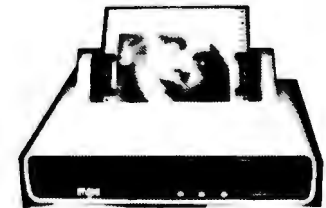

MPI 88G/99G MATRIX

High resolution dot-addressable graphics for Apple. Enhanced "correspondence quality" printing. Tractor and friction feed. Serial and Parallel input. 100 CPS bi-directional printing.

- 88 G (132 col.) List \$749 \$519.
- 99 G (132 col.) List \$849 569.
- Apple parallel I/O Card/Cable/Disk
with Graphics Prom (Ap-Pak) 145.
- IEEE I/O Card 55.
- Single Sheet Feeder 25.
- QT Cover 30.



OKIDATA UP TO 200 CPS!

Microline 82A—80 132 col., 120 CPS, 9x9 dot matrix, friction, pin feed or tractor feed (removable) rear and bottom feed. Includes bi-directional/logic seeking and serial parallel or IEEE interfaces. Double width and condensed characters, true lower case descenders and graphics.

- 82A \$519.
- Microline 83A—132/232 col., 120 CPS, handles forms up to 15 in. wide, plus all the features of the 82A.
- 83A \$745.
- Microline 84SP—132/232 col., 200 CPS, with full dot graphics built-in. Takes forms up to 15 in. wide, plus all the features of the 83A.
- 84SP \$1150.



PALOMAR

Computer Products

WRITE OR CALL **(714) 744-7314**
910-105 W. San Marcos Blvd., Dept. 7B, San Marcos, CA 92069

OUT OF MAIL ORDER BUYING

from us with confidence and know you'll receive the same guaranteed satisfaction — at **UNBEATABLE PRICES!**

APPLE SOFTWARE BUSINESS

Financial Partner	\$191.
Pascal Tutor	97.
Pro Easy Writer	137.
Easy Writer 40 col.	78.
Word Star (Req. Softcard)	241.
Super Sort (Req. Softcard)	129.
Mail Merger (Req. Softcard)	80.
Data Star (Req. Softcard)	192.
Spell Star (Req. Softcard)	129.
Calc Star (Req. Softcard)	129.
Super Tex II	117.
The Address Book	38.
Form Letter Module	78.
Visifile	229.
Desktop Plan III	275.
Desktop Plan II	229.
Visiplot	185.
Visitrend/Visiplot	275.
Visidex	229.
Visiterm	89.
Visicalc 3.3	229.
Infotory	198.
Superspell (Req. Softcard)	435.
Word Processor (Req. Softcard)	255.

PERSONAL/HOME

Typing Tutor	\$19.
Elementary Math	31.
Personal Filing System	74.
Personal Report System	74.
Algebra I	31.
Compu-Math: Arithmetic Skill	39.
Compu-Math: Fractions	31.
Compu-Math: Decimals	31.
Compu-Spells: (Req. Data Disk)	23.

MISC.

Applesoft Compiler	\$144.
Basic Compiler	27.
Apple-Doc	41.
D.B. Master	189.
D.B. Utility Pack	81.

GAMES

Raster Blaster	\$24.
Air Traffic Controller	9.
Temple of Apshal	31.
Datestones of Ryn	15.
Morloc's Tower	15.
Rescue at Rigel	23.
Hell Fire Warrior	31.
Star Warrior	31.
Crash, Crumble and Chomp	23.
Upper Reaches of Apshal	15.
The Keys to Acheron	15.
Sneak Attack	23.
The Prisoner	23.
Zonk I	31.
Zonk II	31.
Robot Wars	31.
Three Mile Island	31.
A.B.M.	19.
Castle Wolfenstein	23.
Wizard and Princes	25.
Missile Defense	23.
Cranston Manor	27.
Warp Destroyer	23.
Cyber Strike	31.
Phantoms Five	23.
Space Eggs	23.

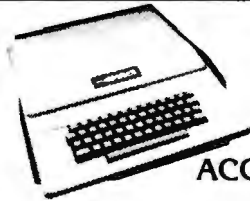

APPLE ACCESSORIES

Apple II & 48K	CALL
Disk II w/controller DOS 3.3	CALL
Disk Add-On	CALL
MICROSOFT	
Z80 Softcard	\$299.
16K RAMcard	159.
CCS	
Parallel Card	119.
ASYN Serial Card	149.
Clock Calendar Card	99.
IEEE Card	249.
A-D Card	99.
MOUNTAIN COMPUTERS	
ROM Plus	129.
Keyboard Filter ROM	49.
CPS Multifunction Card	179.
PAYMAR	
L/C Adapter-New	35.
L/C Adapter-Old	45.
VIDEX	
Video Terminal	299.
DANA	
Cooling Fan	39.
T.G. PROD	
Game Paddles	\$32.
Joy Stick	47.
Select A Port	47.

NEC PC-8000 Series Microcomputer System



- Z-80A CPU 4 MHz
- 5 user programmable function keys
- 82 Keys with numeric keypad
- 160 x 100 resolution
- 80 character screen

PC8001A Microcomputer w/32K RAM	\$750
PC 8012A I/O Unit w/32K RAM	
Expansion slots	480.
PC-8031A Dual Mini-Disk Drive Unit	750.

ATARI SOFTWARE

Adventure *1,2,3 (D)	\$32.
Adventure *4,5,6, (D)	32.
Adventure *7,8,9, (D)	32.
Adventure *10,11,12 (D)	32.
Atari Mailing List (D)	19.
Text Wizard	79.
Compu-Math/Fractions (D)	32.
Compu-Math/Fractions (D)	24.
Compu-Math/Decimals (C)	24.
Letter Perfect (D)	119.
Mail Merge/Utility (D)	24.

MODEMS

PRICE
BREAKTHROUGH



**ANCHOR AUTOMATION
SIGNALMAN MARK I** ONLY \$99.
RS232, 300 baud, Bell 103 compatible.
Automatic selection of originate or answer modes.
Signalman Mark 1



BIZCOMP Super low introductory price. Save over other modems! Apple-direct connect via game port. No serial card needed. Save \$139 or more. Apple package includes software on disk. Atari-direct connect via interface module and telelink cartridge. Each pkg. contains cable with connectors and phone T-adaptor.

Apple Comm Pkg	\$99.
VIC Comm Pkg	99.
Atari Comm Pkg	99.
UDS 103 LP, direct	169.
103 JLP Auto Answer	209.
202 LP 1200 BAUD	259.
NOVATION CAT, acoustic	145.
D-Cat, direct	155.
Auto Cat	219.
Apple Cat	329.
HAYES S100 Micromodem	349.
Apple Micromodem	299.
Smart Modem	245.

RS232 CABLES

4 wire male-male 10 ft.	\$25.
9 wire male-male 10 ft.	30.
4 wire male-female 10 ft.	25.
9 wire male-female 10 ft.	30.
RS232 Switch Box (Use 2 terminals or printers from one output port) ...	109.99

FAN FOLD PAPER

(Prices F.O.B. S.P.)

9½x11-20# Bond White (2700 ct.)	\$29.
14½x11-20# Bond White (2400 ct.)	37.
14½x11-20# Bond 1/2" Green Bar (2400 ct.)	37.

VIDEO TERMS, MONITORS

Ampex Dialog 80	\$995.
Ampex Dialog 30	795.
Televideo 920C	845.
Televideo 950	995.
SOROC IQ 120	599.
Zenith 12" Green	119.
NEC 12" Green	169.
Comrex 13" Color Lo-Res	439.

TERMS OF SALE: Cash, check, money order, bank wire transfer, credit card or purchase orders from qualified firms, and institutions. Please include telephone number with order and expiration date on credit card orders. California residents add 6% sales tax. Advertised prices are for prepaid orders. F.O.B. shipping point. Add 3% for shipping in U.S. Pricing and availability subject to change without notice.

WE CARRY
LOTS MORE THAN
LISTED HERE!
INQUIRIES WELCOME.

PALOMAR
Computer Products



7400 SERIES

7400	.19	74136	.50
7401	.19	74141	.85
7402	.19	74142	2.95
7403	.19	74143	2.95
7404	.19	74145	.60
7405	.25	74147	1.75
7406	.29	74148	1.20
7407	.29	74150	1.35
7408	.24	74151	.85
7409	.19	74152	.65
7410	.19	74153	.55
7411	.25	74154	1.40
7412	.30	74155	.75
7413	.35	74156	.85
7414	.55	74157	.55
7416	.25	74159	1.65
7417	.25	74160	.85
7420	.19	74161	.70
7421	.35	74162	.85
7422	.29	74163	.85
7423	.29	74164	.85
7425	.29	74165	.85
7426	.29	74166	1.00
7427	.29	74167	2.95
7428	.45	74170	1.65
7430	.19	74172	5.95
7432	.29	74173	.75
7433	.45	74174	.89
7437	.29	74175	.89
7438	.29	74176	.89
7440	.19	74177	.75
7442	.49	74178	1.15
7443	.65	74179	1.75
7444	.69	74180	.75
7445	.69	74181	2.25
7446	.59	74182	.75
7447	.69	74184	2.00
7448	.69	74185	2.00
7450	.19	74186	18.50
7451	.23	74190	1.15
7453	.23	74191	1.15
7454	.23	74192	.79
7460	.23	74193	.79
7470	.35	74194	.85
7472	.29	74195	.85
7473	.34	74196	.79
7474	.35	74197	.75
7475	.49	74198	1.35
7476	.35	74199	1.35
7480	.59	74221	1.35
7481	1.10	74246	1.35
7482	.95	74247	1.25
7483	.50	74248	1.85
7485	.65	74249	1.95
7486	.35	74251	.75
7489	4.95	74259	2.25
7490	.35	74265	1.35
7491	.40	74273	1.95
7492	.50	74276	1.25
7493	.49	74279	.75
7494	.65	74283	2.00
7495	.55	74264	3.75
7496	.70	74285	3.75
7497	2.75	74290	.95
74100	1.00	74293	.75
74107	.30	74298	.85
74109	.45	74351	2.25
74110	.45	74365	.85
74111	.55	74366	.85
74116	1.55	74367	.85
74120	1.20	74368	.85
74121	.29	74376	2.20
74122	.45	74390	1.75
74123	.55	74393	1.35
74125	.45	74425	3.15
74126	.45	74426	.85
74128	.55	74490	2.55
74132	.45		

CMOS

74C00	.35	4019	.45
74C02	.35	4020	.95
74C04	.35	4021	.95
74C08	.35	4022	1.15
74C10	.35	4023	.35
74C14	1.50	4024	.75
74C20	.35	4025	.35
74C30	.35	4026	1.65
74C32	.50	4027	.85
74C42	1.75	4028	.80
74C46	1.20	4029	.95
74C73	.65	4030	.45
74C74	.85	4034	2.95
74C76	.80	4035	.85
74C83	1.95	4040	.95
74C85	1.95	4041	1.25
74C86	.95	4042	.75
74C89	4.50	4043	.85
74C90	1.75	4044	.85
74C93	1.75	4046	.95
74C95	1.75	4047	.95
74C107	1.00	4049	.55
74C150	5.75	4050	.55
74C151	2.25	4051	.95
74C154	3.25	4053	.95
74C157	1.75	4060	1.45
74C160	2.00	4066	.75
74C161	2.00	4068	.40
74C162	2.00	4069	.35
74C163	2.00	4070	.35
74C164	2.00	4071	.30
74C165	2.00	4072	.30
74C173	2.00	4073	.30
74C174	2.25	4075	.30
74C175	2.25	4076	.95
74C192	2.25	4078	.30
74C193	2.25	4081	.30
74C195	2.25	4082	.30
74C200	5.75	4085	.95
74C221	2.25	4086	.95
74C373	2.75	4093	.95
74C374	2.75	4096	2.49
74C901	.80	4099	1.95
74C902	.85	14409	12.95
74C903	.85	14410	12.95
74C905	10.95	14411	11.95
74C906	.95	14412	12.95
74C907	1.00	14419	4.95
74C908	2.00	4502	.95
74C909	2.75	4503	.65
74C910	9.95	4508	1.95
74C911	10.00	4510	.95
74C912	10.00	4511	.95
74C914	1.95	4512	.95
74C915	2.00	4514	1.25
74C918	2.75	4515	2.25
74C920	17.95	4516	1.55
74C921	15.95	4518	1.25
74C922	5.99	4519	1.25
74C923	5.95	4520	1.25
74C925	8.75	4522	1.25
74C926	7.95	4526	1.25
74C927	7.95	4527	1.25
74C928	7.95	4528	1.25
74C929	19.95	4531	.95
74C930	19.95	4532	1.95
4000	.35	4538	1.95
4001	.35	4539	1.95
4002	.25	4543	2.70
4006	.95	4555	.95
4007	.29	4556	.95
4008	.95	4561	1.95
4009	.45	4562	1.95
4010	.45	4564	.95
4011	.35	4564	.95
4012	.25	4702	12.95
4013	.45	4724	1.50
4014	.95	80C07	.95
4015	.95	80C95	.85
4016	.45	80C96	.95
4017	1.15	80C97	.95
4018	.95	80C98	1.20

74S00 SERIES

74S00	.44	74S85	2.39	74S163	3.75	74S280	2.90
74S02	.48	74S86	1.44	74S168	4.65	74S287	4.75
74S03	.48	74S112	1.59	74S169	5.44	74S288	4.45
74S04	.79	74S113	1.98	74S174	1.09	74S289	6.98
74S05	.79	74S114	1.50	74S175	1.09	74S301	6.95
74S08	.48	74S124	2.77	74S181	4.47	74S373	3.45
74S09	.98	74S132	1.24	74S182	2.95	74S374	3.45
74S10	.69	74S133	.98	74S188	3.95	74S381	7.95
74S11	.88	74S134	.89	74S189	14.95	74S387	5.75
74S15	.70	74S135	1.48	74S194	2.95	74S412	2.98
74S20	.68	74S138	1.08	74S195	1.69	74S471	9.95
74S22	.98	74S139	1.25	74S196	4.90	74S472	16.85
74S30	.48	74S140	1.45	74S197	4.25	74S474	17.85
74S32	.98	74S241	3.75	74S201	14.95	74S482	15.60
74S37	1.87	74S244	3.98	74S225	8.95	74S570	7.80
74S38	1.88	74S251	1.90	74S240	3.98	74S571	7.80
74S40	.44	74S253	7.45	74S257	1.39		
74S51	.78	74S157	1.19	74S258	1.49		
74S64	.79	74S158	1.45	74S280	1.83		
74S65	1.25	74S181	2.85	74S274	19.95		
74S74	.69	74S162	3.70	74S275	19.95		

EPSON PRINTERS

MX-80 ~~479⁰⁰~~
 MX-80/FT ~~579⁰⁰~~
 MX-100 ~~775⁰⁰~~

CALL FOR THE LOWEST PRICES

16K APPLE* RAM CARD

- ★ Upgrade your 48K Apple* II to full 64K.
- ★ Fully software and hardware compatible with Apple language card and microsoft Z80 card.
- ★ Eliminates the need for Applesoft or Integer Basic ROM card when used in conjunction with DOS 3.3
- ★ Allows you to run Apple Fortran or Pascal.
- ★ Available as bare board kit, or completed and tested board.

BARE BOARD \$ 40.00
 KIT 89.95
 ASSEMBLED &
 TESTED 109.95

*Apple is a trademark of APPLE COMPUTER INC.

LED DISPLAYS

1.29	HP 5082-7760	.6"	CC	14 Pin .3"
.99	MAN 72	.3"	CA	14 Pin .3"
.99	MAN 74	.3"	CC	14 Pin .3"
.75	FND-357 (359)	.375"	CC	10 Pin .2"
.99	FND-500 (503)	.5"	CC	10 Pin .6"
.99	FND-507 (510)	.5"	CA	10 Pin .8"

LED LAMPS

		1-99	100-up
Jumbo Red	.10	.09	
Jumbo Green	.18	.15	
Jumbo Yellow	.18	.15	

HOURS: Mon. - Fri., 9 to 5; Sat. 11 to 3

VISIT OUR RETAIL STORE!

TERMS: For shipping include \$2.00 for UPS Ground, \$3.00 for UPS Blue Label Air. \$10.00 minimum order. Bay Area residents add 6 1/2% sales tax. California residents add 6% sales tax. We reserve the right to limit quantities and substitute manufacturer. Prices subject to change without notice. Send SASE for complete list.

JDR MICRODEVICES, INC.

1224 S. Bascom Avenue

San Jose, CA 95128

800-538-5000 • 800-662-6279 (CA)

(408) 995-5430 • Telex 171-110



Z-80	
2.5 Mhz	
Z80-CPU	6.00
Z80-CTC	5.95
Z80-DART	15.25
Z80-DMA	17.50
Z80-PIO	6.00
Z80-SIO/O	6.00
Z80-SIO/1	18.50
Z80-SIO/2	18.50
Z80-SIO/Ø	18.95
4.0 Mhz	
Z80-A-CPU	6.00
Z80-CTC	8.65
Z80A-DART	18.75
Z80A-DMA	27.50
Z80A-PIO	6.00
Z80A-SIO/O	22.50
Z80A-SIO/1, O	22.50
Z80A-SIO½2	22.50
Z80A-SIO/Ø	19.95
6.0 Mhz	
Z80B-CPU	17.95
Z80B-CTC	15.50
Z80B-PIO	15.50
ZILOG	
Z6132	34.95
Z8	39.95

8200	
8202	34.95
8205	3.50
8212	1.85
8214	3.85
8216	1.80
8224	2.50
8226	1.80
8228	4.90
8237	19.95
8238	4.95
8243	4.45
8250	14.95
8251	4.75
8253	9.25
8253-5	9.85
8255	4.75
8255-5	5.25
8257	8.50
8257-5	8.95
8259	6.90
8259-5	7.50
8272	39.95
8275	29.95
8279	8.50
8279-5	10.00
8282	6.65
8283	6.65
8284	5.70
8286	6.65
8287	6.50
8288	25.00
8289	49.95

8000 SERIES	
8035	7.25
8039	7.95
INS8060	17.95
INS8073	29.95
8080	3.95
8085	7.95
8085A-2	11.95
8086	59.95
8087	Call
8088	39.95
8089	89.95
8155	7.95
8156	8.95
8185	29.95
8185-2	39.95
8741	39.95
8748	29.95
8755	32.00

8600	
86000	call
8600	4.95
8602	10.95
8608	13.90
8609E	19.95
8609	19.95
8610	2.95
8620	4.95
8621	4.95
8628	14.95
8640	12.95
8643	34.95
8644	25.95
8645	16.95
8647	12.25
8650	3.45
8652	5.75
8660	10.95
8662	11.95
8675	6.95
8680	2.95
8683	24.95
86847	24.95
86848	19.95
86800	10.95
86802	22.25
86809E	29.95
86809	29.95
86810	7.95
86821	12.95
86845	35.95
86850	12.95

6500 SERIES	
1 MHZ	
6502	6.95
6504	6.95
6505	8.95
6507	9.95
6520	4.35
6522	8.75
6532	11.25
6545	22.50
6551	11.85
2 MHZ	
6502A	9.95
6522A	11.70
6532A	12.40
6545A	28.50
6551A	12.95
3 MHZ	
8502B	14.95

DISC CONTROLLERS	
1171	24.95
1791	36.95
1783	44.95
1795	54.95
1797	54.95
6843	42.95
8272	39.95
UPD765	39.95
1691	18.95
2143	18.95
INTERFACE	
8T26	1.69
8T28	2.49
8T95	.99
8T96	.99
8T97	.99
8T98	.99
DM8131	2.95
DP8304	2.29

9000 SERIES	
9316	1.00
9334	2.50
9368	3.95
9401	9.95
9601	.75
9602	1.50
96502	1.95
DATA ACQUISITION	
ADC0800	5.55
ADC0804	4.95
ADC0809	5.25
ADC0817	10.95
DAC0800	4.95
DAC0808	4.95
DAC1020	8.25
DAC1022	5.95
MC1408L3	4.95

CRYSTALS	
32.768 khz	3.95
1.0 mhz	4.95
1.8432	4.95
2.0	3.95
2.097152	3.95
2.4578	3.95
3.2768	3.95
3.579535	3.95
4.0	3.95
5.0	3.95
5.0688	3.95
5.185	3.95
5.7143	3.95
5.9904	3.95
6.0	3.95
6.144	3.95
6.5536	3.95
8.0	3.95
10.0	3.95
14.31818	3.95
15.0	3.95
16.0	3.95
18.0	3.95
18.432	3.95
20.0	3.95
22.1184	3.95
32.0	3.95

MISC	
3341	4.95
76477	3.95
AY3-8910	12.95
MC3340	1.49
95H90	7.99
11C90	13.95
8202A	34.95
3242	7.95
MC3480	9.00
MC4024	3.95
MC4044	4.50
3205	3.50
BIT-RATE GENERATORS	
14411	9.95
BR1941	9.95
4702	12.95
COM5016	16.95
MM5307	10.95
UARTS	
AY3-1014	6.95
AY5-1013	3.95
PT1472	9.95
TR1602	3.95
2350	9.95
TMS6011	5.95
IM6402	7.95
IM6403	8.95
INS8250	14.95
KEYBOARD CHIPS	
AY5-2376	11.95
AY5-3800	11.95
74C922	5.25
74C923	5.50

IC SOCKETS	
1-99 100	
8 pin ST	.13 .11
14 pin ST	.15 .12
18 pin ST	.17 .13
16 pin ST	.20 .18
20 pin ST	.29 .27
22 pin ST	.30 .27
24 pin ST	.30 .27
28 pin ST	.40 .32
40 pin ST	.49 .39
ST = SOLDERTAIL	
14 pin WW	.69 .52
18 pin WW	.69 .58
18 pin WW	.99 .90
20 pin WW	1.09 .98
22 pin WW	1.39 1.28
24 pin WW	1.49 1.35
28 pin WW	1.69 1.49
40 pin WW	1.99 1.80
WW = WIREWRAP	

CONNECTORS	
RS232 MALE	3.25
RS232 FEMALE	3.75
RS232 HOOD	1.25
S-100 ST	3.95
S-100 WW	4.95
DIP SWITCHES	
4 POSITION	.85
5 POSITION	.90
6 POSITION	.90
7 POSITION	.95
8 POSITION	.95

ORDER TOLL FREE
800-538-5000
800-662-6279
 CALIFORNIA RESIDENT

INTERSIL	
ICL7103	9.50
ICL7108	9.95
ICL7107	12.95
ICL8038	3.95
ICM7107A	5.59
ICM7208	15.95

LINEAR				BI FET				EXAR			
LM301	.34	LM350K	5.60	NE570	4.75	LM1800	2.99	TL071	.79	XR 2206	3.75
LM301H	.79	LM350T	4.60	NE571	3.95	LM1812	8.25	TL072	1.19	XR 2207	3.85
LM307	.45	LM358	.98	NE592	2.75	LM1815	5.20	TL074	2.19	XR 2208	3.90
LM308	.98	LM359	1.79	LM703	.89	LM1818	2.90	TL081	.79	XR 2211	5.25
LM308H	1.15	LM376	3.75	LM709	.59	LM1820	3.50	TL082	1.19	XR 2240	3.25
LM309H	1.95	LM377	2.29	LM710	.75	LM1830	3.50	TL083	1.19		
LM309K	1.49	LM378	2.50	LM711	.79	LM1871	5.49	TL084	2.19		
LM310	1.75	LM379	4.50	LM723	.49	LM1872	5.49	LF347	2.19	CA 3010	.99
LM311	.64	LM380	1.29	LM723H	.55	LM1877	3.25	LF351	.60	CA 3013	2.00
LM311H	.89	LM380N-8	1.10	LM733	.98	LM1889	2.49	LF353	1.00	CA 3023	2.75
LM312H	1.75	LM381	1.60	LM741N-8	.35	LM1896	1.75	LF355	1.10	CA 3035	2.49
LM317K	3.95	LM382	1.80	LM741N-14	.35	LM2877	2.05	LF358	1.10	CA 3039	1.29
LM317	1.95	LM383	1.95	LM741H	.40	LM2878	2.25	LF357	1.40	CA 3046	1.25
LM318	1.49	LM384	1.95	LM747	.79	LM2900	.85			CA 3053	1.45
LM318H	1.59	LM386	1.50	LM748	.59	LM2901	1.00			CA 3059	2.90
LM319H	1.25	LM387	1.40	LM1014	2.75	LM3900	.59	TL494	4.20	CA 3060	2.90
LM319	1.25	LM389	1.35	LM1303	1.95	LM3905	1.25	TL496	1.65	CA 3065	1.75
LM320 (see 7900)		LM390	1.95	LM1304	1.19	LM3909	.98	TL497	3.25	CA 3080	1.10
LM322	1.65	LM392	.69	LM1305	1.49	LM3911	2.25	75107	1.49	CA 3081	1.65
LM323K	4.95	LM394H	3.60	LM1307	.85	LM3914	3.95	75110	1.95	CA 3082	1.65
LM324	.59	LM399H	5.00	LM1310	2.90	LM3915	3.95	75188	1.25	CA *083	1.55
LM329	.69	NE531	3.75	MC1330	1.89	LM3916	3.95	75189	1.25	CA 3066	.80
LM331	3.95	NE536	6.00	MC1349	1.89	MC4024	4.50	75451	.59	CA 3089	2.99
LM334	1.30	NE555	.39	MC1350	1.29	MC4044	4.50	75451	.39	CA 3906	3.49
LM335	1.40	NE556	.69	MC1358	1.79	RC4136	1.25	75452	.39	CA 3130	1.30
LM336	1.75	NE558	1.50	LM1414	1.59	RC4151	3.95	75453	.39	CA 3140	1.15
LM337K	3.95	NE561	19.95	LM1458	.69	LM4250	1.75	75454	.39	CA 3146	1.85
LM337T	2.95	NE562	6.00	LM1488	.99	LM4500	3.25	75491	.79	CA 3160	1.19
LM338K	8.95	NE564	3.95	LM1489	.99	LM13080	1.29	75492	.79	CA 3401	5.99
LM339	.99	LM565	.99	LM1496	.85	LM13800	1.49	75493	.89	CA 3600	3.45
LM340 (see 7800)		LM566	1.49	LM1558H	3.10	LM13700	1.49	75494	.89		
LM348	1.20	LM567	1.29								

CLOCK CIRCUITS	
MM5314	4.95
MM5369	3.95
MM5375	4.96
MM58167	6.95
MM58174	11.95
MSM5832	8.95

FUNCTION GENERATORS		
MC4024	Dual VCO	3.95
LM566	Function Generator	1.49
XR2208	Function Generator	3.75
8038	Waveform Generator	3.95

VOLTAGE REG's			
7805T	.79	7905T	.89
7808T	.99	7912T	.89
7812T	.79	7915T	1.19
7815T	.99	7924T	1.19
7824T	.99		
		7905K	1.49
		7912K	1.49
		7915K	.79
		7912L	.79
		7915L	.79
		LM317K	3.95
		LM323K	4.95
		LM337K	3.95

T = TO-220 K = TO-3 L = TO-92



JDR MICRODEVICES, INC.

1224 S. Bascom Avenue
 San Jose, CA 95128
 800-538-5000 • 800-662-6279 (CA)
 (408) 995-5430 • Telex 171-110

HOURS: Mon. - Fri., 9 to 5; Sat. 11 to 3

VISIT OUR RETAIL STORE!

TERMS: For shipping include \$2.00 for UPS Ground, \$3.00 for UPS Blue Label Air. \$10.00 minimum order. Bay Area residents add 6 1/2% sales tax. California residents add 6% sales tax. We reserve the right to limit quantities and substitute manufacturer. Prices subject to change without notice. Send SASE for complete list.

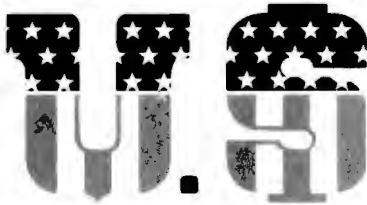

MICRO SALES

15381 CHEMICAL LANE ★ HUNTINGTON BEACH, CA 92649
★ (714) 891-2677 ★

★ SPECIALS OF THE MONTH ★

64K RAMS

These parts are starting to be short in supply, SO WE GOT 'EM for you. Buy now while the supply lasts.
4164 150NS +5V \$7.85 EA.



ONLY \$55.00

Perfect for 8" or 5" drive power. Comes with Shugart type connectors but 5" type can be put on. These are overstock from our Horizontal Cabinet shown below.
+5V @ 4A ● +24V or +12V @ 3A ● -5V @ 1A

BREAK THE COST BARRIER!

NOW IS YOUR CHANCE TO GET THAT COMPUTER LOOK AT THESE FEATURES!

- 4MHZ Z-80 CPU with 2 Programmable Serial and 3 Parallel Ports
- 64K Dynamic Ram w/Extended Addressing to 1MB
- Floppy Disk Controller with WD1795. Runs 8" or 5" Floppys Error Free
- 30 Amp Power Supply with S-100 MOD 12 Slot Mother with Regulated Floppy Supplies as Shown Below
- Tan and Charcoal Sturdy Steel Cabinet with Space for 2 Floppy Drives at Left (8" or 5")

\$1750 Retail

ONLY \$1350.00

CP/M* \$150
MP/M* \$350
DISC ACCES. \$50

SOME MECHANICAL ASSEMBLY REQUIRED IN STOCK FOR IMMEDIATE SHIPMENT



(Less Drives, Cables Pick-up Price)

*CP/M & MP/M are Trademarks of Digital Research

★ DUAL DRIVE SUBSYSTEMS ★

★ NEW ★ NEW ★ NEW ★



HORIZONTAL



VERTICAL



MINI

- Power Supply for 2 801/851 DT8 etc.
- 50 Pin Ribbon Cable, 36"
- AC Cord, Fuse, Internal Wiring and Connectors

Assembled and Tested	\$ 245.00
w/2 Empty 5"	\$ 87.00
w/2 Empty 8"	\$ 95.00
w/2 801R Shugart	\$1045.00
w/2 851R Shugart	\$1395.00
w/2 QUME DT-8	\$1295.00
w/2 MPI B-51	\$ 675.00
w/2 MPI B-52	\$ 830.00
w/2 MPI B91	\$ 850.00
w/2 MPI B92	\$ 995.00

S-100-4

Complete 4 slot S-100 computer. Perfect for word processing, small business accounting, inventory control, etc. 1.2 megabytes of storage capacity on two 8" floppy drives. (Expandable to 2.4 megabytes using double sided operation.)

- 4MHZ Z-80A
- 64K Dynamic Ram
- 2 Serial Ports 50-19,200 Baud
- 3 Parallel Ports (8255)
- Steel Tan and Charcoal Case
- Includes CP/M*



SPECIAL INTRODUCTORY OFFER
\$1595.00
Complete, ready to attach Terminal and Printer (Offer ends Aug. 30, 1982)

XOR-CPU	Z-80 4MHZ, Prom 2 Serial 3 Par	\$255
XOR-DSK	WD-1795 MINI and 8"	\$275
XOR-64K	Bank SW Memory up to 1 Meg	\$389
XOR-32K	Static Ram (Kit)	\$199
XOR-MPM	IO MPM Interface Card	\$335
XOR-DTC	Hard Disk and DTC Tape	\$225
XOR-SMS	Hard Disk Controller	\$750
XOR-SER	4 Channel Serial Board	\$195

★ XOR ★

S-100 MOD KIT \$199.00 BY XOR

For test or hobby applications complete S-100 12 Slot Sub-System power for up to 4 Floppy Disk Drives. (6 connectors supplied.)

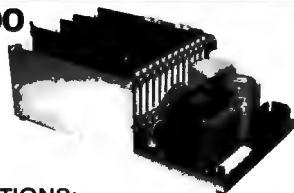

SPECIFICATIONS:

UNREGULATED	REGULATED
• 12 Slots S-100	+5 at 5 Amps
• +8VDC at 30Amps	+24 at 4 Amps
• ±16VDC at 6 Amps	-5 at 1 Amp

★ SPECIALS OF THE QUARTER ★

S-100 CARD EXTENDER



\$12.50
(Gold Contacts)

As long as there is a price war, we will fight your battle. Compare at your local Deptstore and buy US Micro

S-100 POWER



\$89.50

Simple Brute Force! S-100 Power Supply. 30A @ +8V, 6A @ +18V, 6A @ -18V, PC Board Design.

12 SLOT MOTHER



\$22.50

We have connectors and power supply too. Start your system with quality components. Terminated Connectors \$2.50 ea.

OPEN FRAME POWER SUPPLIES

DISK POWER SUPPLIES				
PRIAM-SHUGART-CENTURY-MICROPOLIS				
+5V @ 9A	-12V @ .8A	+24V @ 4.5A	US-384	89.00
SHUGART-SIEMANS-MPI 5 1/4"				
+5V @ .5A	+12V @ .9A		US-340	33.50
+5V @ 2A	+12V @ 4A		US-323	56.25
SHUGART-SIEMANS-CDC 8"				
+5V @ 1A	-5V @ .5A	+24V @ 1.5A	US-205	52.50
+5V @ 2.5A	-5V @ .5A	+24V @ 3A	US-206	69.00
+5V @ 3A	-5V @ .6A	+24V @ 5A	US-162	89.00
+5V @ 1.7A	-5V @ 1.5A	+24V @ 2A	US-272	69.00
+5V @ 2A	+12V @ .4A	-12V @ .4A	US-HTAA	37.50



If you can beat these prices we will be truly amazed. OEM's at 500 lot pay more than this. Call or write for full spec. sheets.

COMING NEXT MONTH — HARD DISK!

S100-12

California Computer Systems



- 2810 CPU Only — \$255.00
- 2422 Dsk Cont Only — \$330.00
- 2065C 64K Only — \$320.00
- 2200A Mainframe Only — \$475.00
- CCS Apple Boards Call for prices
- CCS 2200 System Tested and Assembled Only — \$1,625.00



11 EDISON DRIVE ★ NEW LENOX ★ ILLINOIS 60451
 CALL TOLL FREE: 1-800-435-9357 ★ MONDAY thru SATURDAY
 (ILLINOIS RESIDENTS CALL: 815-485-4002) ★ 8:00 a.m. to 6:30 p.m.

TERMS: Prepayment — C.O.D. up to \$100.00 — M/C Visa
 \$5.00 Processing and Handling added to each order PLUS
 Shipping Charges. Please allow personal check to clear before shipment.
 15% Restocking Charge for Non-Defective, Returned Merchandise.
 Prices subject to change without notice.

★ SPECIAL ★ SPECIAL ★ SPECIAL ★

CCS SYSTEM 2410 *FEATURES*

- * DMA Disk Controller
- * 2-Real Time Clocks
- * 2-Serial/1-Parallel Port
- * Hardware Vectored Interrupts
- * Supports C/PM, M/PM, OASIS
- ***Comes with C/PM***
only-\$2,100.00

CONTROLLER BOARD FOR 8" and 5"
 DRIVES FOR THE Z-89, Z-90, or H-89
 COMPUTERS....

Comes w/CPM 2.2 on 8" and 5"
 media Only \$550.00

SOFTWARE

ASHTON TATE	
dBASE II	\$560.00
DIGITAL RESEARCH	
C BASIC	\$118.00
MICRO PRO	
WORDSTAR	\$275.00
MAILMERS	\$115.00
DATA STAR	\$265.00
SUPERSORT I	\$190.00
SPELLSTAR	\$190.00
MICROSOFT	
BASIC 80	\$290.00
BASIC COMPILER	\$320.00
FORTRAN 80	\$400.00
COBOL 80	\$600.00
MACRO 80	\$165.00
SORCIM	
PASCAL/M	\$320.00
SUPERCALC	\$235.00
SUPERSOFT	
FORTH	\$170.00
SSS FORTRAN	\$215.00
DISK DOCTOR	\$85.00
C COMPILER	\$175.00

commodore
 computer systems
 CALL FOR PRICES

ZENITH | data systems
 CALL FOR PRICES

FEATURES! TERMINAL

- Feather Touch Capacitance Keyboard
- 60 Key Standard ASCII PLUS + Hex Keypad PLUS + 8 Special Function Keys PLUS + 20 Screen Editing Keys
- SOROC Type Screen Attribute Set
- Half Intensity

COMPUTER

- 8 Slot S-100
- 64K Dynamic Ram
- 4MHZ Z-80
- Double Density Disk Controller
- Programmable Baud Rate
- Programmable Keyboard Set
- Serial Printer Port (150-19.2K)

S-100-8

INCLUDING C/P/M 2.2*
 AND WORDSTAR*

WITH: 8" SS/DD Drives Only \$2850.00
 5 1/4" SS/DD Drives Only \$2700.00

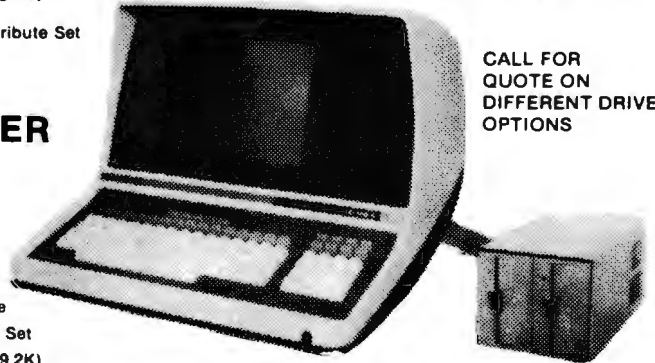

CALL FOR QUOTE ON DIFFERENT DRIVE OPTIONS

WORDSTAR is a TM of Micropro Inc. — C/P/M 2.2 is a TM of Digital Research Inc.

MONITORS

BMC MONITORS—	
W/GREEN SCREEN	\$ 95.00
ZENITH VIDEO MONITOR—	
ZVM	\$145.00
AMDEK MONITORS—	
AMDEK Color 1	\$399.00
AMDEK Video 300	\$229.00
w/Green Screen	

DISK DRIVES

• Shugart 801's	\$395.00
• Shugart 851's	\$575.00
• Qume DT-8's	\$540.00
• SA 400	\$230.00
• SA 450	\$340.00
• SA 410 SS 96 TPI	\$375.00
• SA 460 DS 96 TPI	\$425.00
• TM 100-1	\$230.00
• TM 100-2	\$340.00
• TM 100-3	\$375.00
• TM 100-4	\$425.00

TANDON SLIMLINE

• TM 848 - 1	\$480.00
• TM 848 - 2	\$550.00

COMPLETE LINE OF ADD ON DRIVES
 FOR APPLE — CALL FOR PRICES

TeleVideo
 SYSTEMS
 CALL FOR PRICES

PRINTERS

• C-ITOH PROWRITER	\$525.00
• C-ITOH F-10 40 CPS	\$1,500.00
• C-ITOH Comet II 132 Column Printer 9 x7 Dot Matrix	\$810.00
• MPI-88G	\$600.00
• EPSON MX 80	CALL
• EPSON MX 100	CALL
• Anadex 9501 Graphic Printer	\$1,235.00
• OKIDATA 82A	\$465.00
• 83A and 84A	CALL



Apple 8" Disk Controller Card	
• ZVX4 Dual Density, Single & Double Sided - Auto Boot	\$395.00
• Disk 2 + 2 Single Density Single or Dual Sided	\$300.00

TERMINALS

• Adds Regent 20	\$570.00
• Televideo 910	\$575.00
• Televideo 912C	\$685.00
• Televideo 925C	\$740.00
• Televideo 950	\$950.00
• Ampex Dialog 80	\$895.00
• Zenith Z19	\$745.00

California Digital

Post Office Box 3097 B • Torrance, California 90503

California Digital STATIC • 64



RELIABILITY OF STATIC ... PRICE OF DYNAMIC

Sixteen Bit Memory

\$595

February Price '850

30% Price Reduction

Utilizing the new Hitachi 6187/2167 ram chip, the Static 64 is the most current technology available in 8-300 memory products. 24 bit extended addressing, 8 or 16 bit data paths along with 16 bit request and acknowledge make this unique board completely compatible with the IEEE 808 S-100 bus standard.

The Static 64 has been engineered to allow each 18K segment of memory to be bank selectable supporting multiuser systems. Other selectable features allow the board to fully integrate with all current bank selecting schemes including Cromex and Alpha-Micro. Operates with all 16 bit computers including Seattle Computers, Teemar and Lonam. Designed for DMA operations at clock frequencies in excess of 10 MHz. Standby power consumption less than one Amp.

To add to the total integrity of the product, each board is subjected to extensive high temperature burn-in and test procedures. CAL-8400



GREEN PHOSPHOR MONITOR

The new Zenith ZVM-121 monitor features a P-31 green phosphor tube along with 15 MHz bandwidth.

Switch selectable for 40 and 80 character per line screen formats.

Accepts composite video and is fully compatible with 80 column Apple cards. VDM-121 20 lbs.



EPSON MX80

\$450

Epson MX80-T friction/tr \$595.00
Epson MX100 132 column 70.00
Graftrax 80 option 129.00
Apple I/O & cable (\$131) 129.00
Serial interface (\$141) 79.00
Serial Inter., 2K buf. (\$151) 149.00
Cable for TRS-80 35.00
IEEE 488 interface (\$181) 65.00
Replacement Ribbon 45.00
Paper 3500 sheets 9 1/2" 35.00

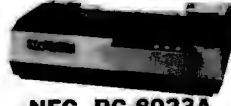

NEC PC-8023A

\$535

Dot-matrix, bi-directional, logic-seeking, friction or tractor feed, impact printer. Complete graphics, upper and lower case ASCII, Greek, mathematics along with the ability to print dot graphic screen images directly onto paper.
Proportional spacing and 132 column compressed print make this low cost machine the best value in today's printer market.



PRINTRONIX

P-300 \$4500

P-600 \$6150

PRINTERS

Epson MX80 PREM80 \$475
Epson MX80-T PREM80F 595
Epson MX100 PREM100
Anadex 9500 PR49500 1295
Anadex 9301 PR49501 1295
Anacorn 150 PRA150 1075
IDS Paper Tgr. PRC480G 1095
IDS Tiger 560 PRG560G 1350
Diablo 830 PRD830 2150
Diablo 1850 PRD1850 2850
Diablo 1840 PRD1840 2486
Dataouth 180 PRD180 1350
Printronix 300 PRP300 4500
Printronix 600 PRP600 6150

NEC/Sellum 1 PRN5510ps 2695
NEC/Sm 16K PRN5516ps 2795
TEC/Starwrit. PRV300 1395
Okidata 80 PRO80 419
Okidata 82 PRO82 619
Okidata 83 PRO83 895
Teletype 43K PTT4320K 1095
Texas Ins. 810 PRT810H 1450
Tex. Ins 810C PRT810C 1795
Centronics 730 PRC730P 529
Centronics 737 PRC737P 895
Centronics 739 PRC739P 795
Centrmx 704-9 PRC704-9
Centrmx 704-11 PRC704-11

SYSTEMS



HEWLETT
PACKARD
HP 85 COMPUTER

BELOW OUR COST

\$2295



Apple
48K Memory
\$1150



EPROM ERASER

Ultra Violet Products

\$65

UVP-11E



IBM 3101 Display Terminal

IBM Direct Price \$1395
California Digital



AMPEX
DIALOGUE 80
REDUCED PRICE

\$795

VIDEO TERMINALS

ADDS Viewpoint	VDT-RVP	595
ADDS Regent 25 numeric cluster	VDT-R25	850
ADDS Regent 30 25th status line	VDT-R30	950
ADDS Regent 40 limited graphics	VDT-R40	1195
ADDS Regent 60 Block mode	VDT-R60	1495
Amplex Dialogue 80 two page, detach	VDT-D80	
Digital Equipment VT-100	VDT-V100	1595
Digital Equipment VT-132	VDT-V132	1895
IBM 3101-10 character mode green	VDT-V3101	1195
IBM 3101-20 block mode	VDT-31012	1395
Visual 200	VDT-V200	895
Televideo 910C (new)	VDT-T910	595
Televideo 912C	VDT-T912	665
Televideo 920C	VDT-T920	745
Televideo 950C detachable keybd.	VDT-T950	985
Zenith Z-19	VDT-Z-19	

VIDEO MONITORS



BMC KG-12C 20Mhz
P31 green phosphor \$169
NEC gm. 1201 189
Zenith gm ZVM121 119
BMC color composit 339
Zenith color 13" 395
NEC RGB 1202DH 895

ACCESSORIES FOR THE APPLE COMPUTER

CALIFORNIA COMPUTER SYSTEMS

Arithmetic Processor 7811 B/C	\$319
Asynchronous serial interface 7710	129
Centronics Interface card 7720	95
12K PROM Module 7114	69
Calendar/Clock, Bat. back-up 7424	99
Parallel Interface 7720A	99
Programmable Timer 7760A	99
Analog/Digital converter 7470A	99

MICROBLOT PRODUCTS

Apple to 2-80 CPU card	378
------------------------	-----

D. C. HAYES PRODUCTS

Micromodem for Apple	310
----------------------	-----

COMPUTER STOP PRODUCTS

Double Vision / 80 Column Video	250
---------------------------------	-----

INTEGRATED STRUCTURES

16 Channel A/D card AIO/2	275
---------------------------	-----

S-100 BOARDS

Assembled • Tested • Burned-in

CPU BOARDS	
Calif. Computer 2810A 7-80	
DMA, 4MHz BHC-C2810	\$250
Godbout Z-80 24 bit, 4MHz	
BHC-C7-90	239
Godbout 8085/8088 dual 18 bit processor	
BHC-C88	375
Measurement System 4 7-80	
4 serial 2 parallel real time clock, 8 vector	
BHC-M280	395
SU Systems SBC-200 Z-80	
with serial & parallel	
I/O ports	
BHC-SBC2	385
Teletek PDC-1 single board	
CPU & floppy disk controller plus I/O	
BDC-PDC1	695

MAINFRAMES

Calif. Computer 2208A 12 slot & power supply	
ENM-C2200	
TEI 12 slot table	
ENM-T12	
TEI 12 slot table	
ENM-T22	
Godbout mainfrm.	
ENM-GMF	

MEMORY BOARDS

Calif. Computer 2085A 61K dynamic memory	
BDM-C2085	
Calif. Computer 2016 16K static memory	
BDM-C2016	259
Calif. Computer 2022 92K static memory	
BDM-C2022	583
Godbout Ram 17 84K static memory	
BDM-G17	1025
SU Systems Expanderan II	
16K dynamic	
BDM-LA16	295
64K dynamic	
BDM-L64	375
Measurement Systems UMB8400 for Alpha Micro	
BDM-M8400	68

EPROM BOARDS

Digital Research 32K, 2716	
9700 series	
BDM-DF32	99
SU Systems P-ram-100 programmer	
BDM-P100	250

FLOPPY DISK CONTROLLER

Calif. Computer 2424A with 2.2 CPU	
BUF-C2422	329
Godbout "Disk One" features the	
NIC 785 controller, DMA arbitration	
BDP-GD1	395
Measurement Systems 765 chip, single & double density, Error recovery	
BD1-MF	419
SU Systems Versafloppy II	
Usable density	
BD1-V2 2	419
Tarielli D/D	
BD1-TF2	419
Morrow Design Disk Jockey II	
single density	
BDJ-DJ1	195
Morrow Design Disk Jockey II double density	
BDJ-DJ2	345

INTERNAL ACE BOARDS

Calif. Computer 2718 I/O	
2 serial/2 par I	
BDT-C2718	
Morrow Design Switchboard	
2 serial/4 par I	
BDT-MSB	219
Morrow Design Multi-board	
3 serial/2P	
BDT-MMB	275
Godbout Interface One	
2 serial/2 par I	
BIS-C41	199
Godbout Interface Two	
1 serial/3 par I	
BIS-C82	199

SPECIALTY BOARDS

QF Computer real time clock/calendar	
BIS-QCK	135
Active Elec. Wire wrap prototype board	
BIS-AWW	75
Active Elec. General Purpose proto board	
BIS-AGP	295
Godbout Spectrum color board	
BIS-GSC	295
D. C. Hayes S-100 Micro-modem	
BD9-HMI	360
Mullen Products extender board & logic probe kit	
BIS-MTB1	49
Mullen Products Cpto-centro board kit	
BIS-MCC	139

Rotron Muffin Fan

\$14.77 \$12.00 @ 100
10.50 @ 1000

115 VAC. 7 Watts WR2A1
Factory fresh Muffin fans
NOT pull-outs. EMF-4M

TOLL FREE ORDER LINE
800 421-5041
TECHNICAL & CALIFORNIA
(213) 679-9001
TWX 910 325-6212



All merchandise sold by California Digital is premium grade. Shipping: First five pounds \$2.00; each additional add \$4.00 Foreign orders 10% shipping. Excess will be refunded. California residents add 6% sales tax. COD's discouraged. Open accounts extended to state supported educational institutions and companies with a "Strong Dun & Bradstreet." Warehouse: 15608 Inglewood Blvd. Visitors by appointment.

CALIFORNIA Digital

Post Office Box 3097 B • Torrance, California 90503

DISKETTES

FREE PLASTIC LIBRARY CASE INCLUDED WITH THE PURCHASE OF EVERY BOX OF DISKETTES

\$24.95

Private labeled for California Digital by one of the most respected producers of magnetic media. Each diskette is certified double density at 40 tracks. To ensure extended media life each diskette is manufactured with a reinforced high-tensile. And of course, a plastic library case is included with every box of diskettes. **NOTE: (CROSS COMPATIBLE)** Please specify computer or required sector.

Ten boxes \$22.75 One hundred boxes \$21.50



5 1/4" DISKETTES WITH LIBRARY CASE \$26.50

Your Choice
SCOTCH MEMOREX VERBATIM

	Soft Sector	10 Sector	16 Sector	
SCOTCH	744-0	744-10	744-16	\$26.50
MEMOREX	3401	3403	3405	26.50
VERBATIM	525-01	525-10	NA	26.50
DYSAN	104/1	107/1	NA	39.50

Single Side Double Density

DYSAN	104/1D	107/1D	NA	45.00
-------	--------	--------	----	-------

Double Side Double Density

SCOTCH	745-0	745-10	745-16	42.50
DYSAN	104/2D	107/2D	NA	49.50
DYSAN 96	204/2D	NA	NA	59.50

EIGHT INCH DISKETTES

Single Side Single Density		Single Side Double Density		
SCOTCH	740-0	29.50	SCOTCH 741-0	39.00
MEMOREX	3060	29.50	MEMOREX 3090	35.00
DYSAN	3740/1	39.50	DYSAN 3740/D	57.50
Thirty Two Sector		Double side Double Density		
SCOTCH	740-32	29.50	SCOTCH 743-0	47.50
			MEMOREX 3114	39.50
			DYSAN 3740/2D	65.00

PLEASE PHONE FOR VOLUME PRICING.



BSR SYSTEM X-10

The new BSR timer runs your home just like clockwork. Turns on lamps and appliances while your away from home. Completely compatible with your existing System X-10 devices.
BSR Timer eight channel \$65.00
Master control console 34.95
Ultracon Controller 18.95
Appliance Module 500 W. \$13.95
Lamp Modul 300 Watts 13.95
NEW ball control wall switch 14.50

WINCHESTER SUBSYSTEM

\$1250

Includes seven megabyte Winchester hard disk, dual enclosure and power supply.
Floppy backup drive \$199.00 additional.



MEMORY

64K DYNAMIC \$9.95	16K STATIC \$13.95
4164 100-	2167 70ns.
16K DYNAMIC \$2.10	2716 EPROM \$4.95
4116 100-1.85	100-4.50 1K-4.00



2732 EPROM SALE \$7.95

STATIC

	ea.	32+	100+	1K+
21L02 1K	1.19	1.09	1.05	.99
2114 300ns.	2.95	2.75	2.50	1.99
4044-4 450ns.	4.50	4.19	4.00	3.75
4044-2 250ns.	4.95	4.65	4.50	4.25
6116 18k 24 pin	7.95	7.50	6.75	6.45
2167/6187 20 pin	11.95	10.75	9.85	9.25

EPROM

2708 450ns.	3.95	3.50	3.25	3.00
2716 5V.	4.95	4.00	3.75	3.50
2716 tri-volt	8.50	7.95	7.65	7.25
2732 Intel/Fitac.	7.95	7.50	7.00	6.65
2532 Texas Inst	12.95	11.50	10.00	9.50
2764 64K Eprom	29.95	27.00	25.00	23.50



direct connect **MODEM** Your Choice **\$169**

Direct connect modems eliminate loss of information due to the carbon compression process of acoustic modems. Choose either of these two great units.

The Concentric port system 103LP is a unique interface between answer and original modems. 103LP will connect to any 103LP connects to the new modular telephone unit. 103LP power cord from the original line. No need to locate modem in proximity to a telephone. 103LP-103LP.

November 1981. Call numbers to view the new "Bell" modular modems. Used for multiple line office telephones. Requires external A.C. power. MOD-PROV 2 Line.

SWITCHES

DIP SWITCHES		TOGGLE		ea.	100+	
1	.98	75	.89	7101 on/on	1.19	1.88
2	.98	.89	.79	7103 on/off/on	1.39	1.19
3	1.05	.82	.87	7107 mtl. on	1.39	1.19
4	1.19	.89	.91	7188 mtl. on	1.39	1.19
				7205 dpdt mnt	1.85	1.65

CONNECTORS



GOLD EDGE CONNECTORS		"D" Type	
S-100 125" centers	each 10+	DE9P male	\$1.60 \$1.40 25+
Imal solder 250" row	\$2.95 \$2.50	DE9S female	2.25 2.00 1.90
Imal wire wrap (T)	3.95 3.50	D5 hood	3.50 1.35 1.20
Sallins Hi-Rel. .250"	4.90 4.00	DA15P male	3.35 2.15 2.00
Sallins Hi-Rel. W/W	5.35 4.50	DA15S female	3.25 3.10 2.90
Sallins/Altair 140"	4.95 4.50	DA hood 2/P	1.60 1.35 1.30
.156" Centers (standard)		DB25P male	2.50 2.25 2.25
22/44 Kim Eyelet	2.50 2.15	DB25S female	3.35 3.15 3.05
38/72 Digital Group S/T	5.65 5.50	DC hood 2/P	1.35 1.15 1.05
38/72 Digital Group W/W	6.60 6.15	DC77P male	4.20 4.00 3.70
43/86 Motorola 8800 S/T	6.60 6.15	DC77S female	6.00 5.75 5.60
43/86 MoCo 8800 W/W	7.00 6.65	DC hood 2/P	2.25 2.00 1.75
		DB50P male	5.50 5.10 4.75
		DB50S female	4.40 4.00 3.60
		D80S hood 2/P	2.60 2.40 2.10
INTEGRATED CIRCUIT SOCKETS		CENTRONICS	
Low Profile	Wire Wrap	57-30300	7.95 6.75 5.75
8 pin 1.10	each 100+		
14 pin 1.10	8.40 8.41		
16 pin .12	.47 .41		
18 pin .12	.11 .50 .45		
18 pin .15	.13 .88 .81		
24 pin .08	.34 .67		
40 pin .42	.40 1.60 1.47		
		RIBBON CABLE CONNECTORS	
		17/34 5" disk	4.85 4.15 3.95
		20/40 TRS-40	5.85 5.65 4.70
		25/50 6" disk	5.90 5.15 4.90



NEW OLIVETTI 801 \$295
Eight Inch Disk Drive

		ONE	TWO	TEN
★ OLIVETTI 801	single	\$319	309	295
★ OLIVETTI 802/851	double	425	419	410
SHUGART 801/R	single	395	385	375
SHUGART 851/R	double	525	495	475
QUME DATA TRACK 8	double	525	495	475

★ The 8" Olivetti drives are approx. 1/2" wider than the Shugarts.

Five Inch Disk Drives

OLIVETTI 501/400	single	199	185	175
OLIVETTI 502/451	double	235	225	215

Upon request, all drives are supplied with power connectors and one manual per order.

230 volt 50Hz. 8" add \$50.00 per drive.



\$995 Eight inch Subsystem
Two Olivetti 801 disk drives with power supply, 4" exhaust fan complete in dual enclosure with all necessary power cables. Documentation included. 50 Lbs. CAL-2801

Signal cable add \$35.00 WCA-6500

Same as above but with:

Shugart 801R	MSD2801	\$1195	Olivetti 802	CAL2802	\$1250
Shugart 851R	MSD2851	1450	Qume DT8	MSD8DT	1450

SPECIAL \$895

Volume Pricing Upon Request

Seagate Compatible 7.5 MEGABYTE Winchester Hard Disk Drive

We have priced this so low that the manufacturer has asked not to use their brand name in our advertising.
Industry standard Seagate plug compatible. Drive fits into the same space as a 5 1/4" floppy disk drive. CAL-561/2

S-100 MOTHER BOARD \$35

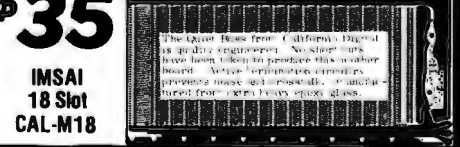

IMSAI 18 Slot CAL-M18
TOLL FREE ORDER LINE
(800) 421-5041
TECHNICAL & CALIFORNIA
(213) 679-9001
TWX 910 325-6212

All merchandise sold by California Digital is premium grade. Shipping: First five pounds \$2.00; each additional add \$.40 Foreign orders 10% shipping. Excess will be refunded. California residents add 6% sales tax. COD's discouraged. Open accounts extended to state supported educational institutions and companies with a "Strong Dun & Bradstreet." Warehouse: 15608 Inglewood Blvd. Visitors by appointment.

ADVANCED COMPUTER PRODUCTS

TOLL FREE ORDER LINE
800-854-8230



Apple Computer
Selling and Leasing

Model	LIST	ACP
Apple II 16K	\$1330.00	\$1028.00
Apple II 48K	1530.00	1099.00
Apple II 64K	1738.00	1223.00
Apple II 64K	2519.00	1773.00
w/280 Software & Vision 80		
Apple III 128K	3495.00	*2995.00

AVAILABLE IN STORE ONLY

APPLE HARDWARE

Apple Disk II w/Interface	\$129.00	\$129.00
Apple Disk II w/o	99.00	99.00
Silentype Printer	149.00	149.00
Prototype Card	29.00	29.00
IEEE-488 Interface	149.00	149.00
1 year est. warranty		
Parallel Printer Interface	149.00	149.00
Communications Card	149.00	149.00
Personal Language System	149.00	149.00
High Speed Serial Interface	149.00	149.00
Applesoft II ROM Card	99.00	99.00
Language Card	149.00	149.00
17" Color Monitor	399.00	399.00
Monitor Stand (Black) Subsystem	149.00	149.00
Language System	149.00	149.00

AVAILABLE IN STORE ONLY

IBM COMPATIBLE HARDWARE

Mountain Computer	ROM Plus	ROM Striper	RAMP Plus	CPS Multifunction	Equipment Chassis	Thunderlock	X-10 option	Paralcal option
Version 4 in 1	CCS Serial I/O	Parallel I/O	M & R Enterprise	Apple Fan	Sup'r Mod	Aux Switcher Supply	Sup'r Term	Hard Disk

APPLE SOFTWARE

Vercalc	\$199.00	\$199.00
SuperCalc	249.00	249.00
VerTrans/VerPlot	249.00	249.00
Ver/Dex	199.00	199.00
Ver/Yarn	199.00	199.00
BPJ General Ledger	249.00	249.00
Accounts Receivable	249.00	249.00
Inventory	249.00	249.00
Ver/Chart	199.00	199.00
Ver/Map	199.00	199.00
Ver/Align	149.00	149.00
Ver/Map	199.00	199.00
Ver/Map	199.00	199.00
Ver/Map	199.00	199.00
Ver/Map	199.00	199.00
Ver/Map	199.00	199.00
Ver/Map	199.00	199.00
Ver/Map	199.00	199.00
Ver/Map	199.00	199.00
Ver/Map	199.00	199.00
Ver/Map	199.00	199.00
Ver/Map	199.00	199.00
Ver/Map	199.00	199.00

FLOPPY DISK DRIVES

Qume Only	\$569.95
Qume 5.25" 5 1/4" Disk Drive	\$569.95
Apple II 5.25" 5 1/4" Disk Drive	279.00
Apple II 5.25" 5 1/4" 40 Tracks	279.00
Apple II 5.25" 5 1/4" 35 Tracks	229.00
Apple II 5.25" 5 1/4" 35 Tracks	449.00
Apple II 5.25" 5 1/4" 35 Tracks	429.00
Apple II 5.25" 5 1/4" 35 Tracks	1199.00
Apple II 5.25" 5 1/4" 35 Tracks	349.00
Apple II 5.25" 5 1/4" 35 Tracks	299.00
Apple II 5.25" 5 1/4" 35 Tracks	375.00
Apple II 5.25" 5 1/4" 35 Tracks	479.00

16K RAMCARD

* Apple II compatible
List \$195.00 ACP \$74.95

DEALER PRICING AVAILABLE

Vista

VISTA COMPUTER

Vision 80 8024 display card	299.00	299.00
Vision 40 40 col enhancement	149.00	149.00
Vision 20 20 lower case ROM	149.00	149.00
AK100 Double Density B* Controllers	149.00	149.00
MWB 8 voice music	149.00	149.00
GB75 IBM Regent Apple I/O	149.00	149.00
POS PROM development	149.00	149.00
TYPE AHEAD BUFFER	49.95	51.00



Vision 80

\$299.00

VISTA V DRIVE

Now w/Window

450.95 / \$1995.00

VISTA V 80

Microdot

329.00 / \$599.00

APPLE COMPATIBLE DRIVES (MicroSoft)

100% CERTIFIED ERROR FREE

329.95 / \$399.95

DISKETTES

VERBATIM & Maxell Diskettes

329.95 / \$399.95

ROBOTIC 8/8M

Automation or Robotic Assembly

Education in Robotic Principles

Artificial Intelligence Experiments

Computer Art and Games

Microbot

\$1695.00

USI Computer Products

USI International

329.95 / \$399.95

VIDEO MONITOR

(Sanyo Look Alike)

Model Ph 1 9" Green \$159.95

Model Ph 2 12" Green 159.95

Model Ph 3 12" Orange 199.95

\$429.00

PRINTERS

MX-80 Dot Matrix	845.00	*845.00
MX-80/FT	745.00	528.00
MX-100	999.00	725.00
Apple I/O & cable	110.00	89.00
Griffin option	95.00	89.00
IEEE I/O & cable	130.00	95.00
Serial I/O & cable	130.00	95.00
Serial w/2K & cable	175.00	149.00
Universal Graphics Utility	39.95	*35.95

BROTHER Datasheet Printer Only

\$895

TERMINALS

TELEVIDEO	LIST	ACP
910	\$ 899.00	\$ 599.00
912C	950.00	699.00
902C	999.00	799.00
950C	1199.00	999.00

SANYO

MONITORS

SANYO	LIST	ACP
9110	1899.95	1499.95
9110	1999.95	1599.95
9110	2499.95	1999.95
9110	2799.95	2199.95
9110	4299.95	3299.95
9110	4199.95	3199.95

Novation

MODEMS

Novation	LIST	ACP
Cat	\$129.95	\$149.00
D-Cat	199.95	189.00
Apple-Cat	249.95	209.00
Auto-Cat	299.95	239.95
HAYS B		
Micromodem	\$379.00	\$299.00
Smartmodem	279.00	249.00

IBM

IBM COMPATIBLE BOARDS

MAX-OUT YOUR IBM PC

\$1199.00 / \$1739.00 / \$1849.00 / \$799.00 / \$99.00 / \$19.95



ATARI

ATARI COMPUTER

Atari 400	\$179.00	\$179.00
Atari 800	199.00	199.00
Atari 1300	249.00	249.00
Atari 2600	149.00	149.00
Atari 5200	299.00	299.00

ADD-ON MEMORY

Atari 16K	\$ 69.50	\$ 74.00
Atari 32K	109.00	139.00
Atari 64K	199.50	149.00

XEROX 820

FREE TCS BUSINESS SOFTWARE

Word Processing

HEWLETT PACKARD

HP-87

HP-85A

HP-85

HP-125

HEWLETT-PACKARD COMPUTERS

HP-87	\$2495.00	\$1895.00
HP-85A	2750.00	2095.00
HP-85	2395.00	1850.00
HP-125	2750.00	2095.00
HP-87	1875.00	1475.00
HP-85A	4765.00	4765.00
HP-85	5125.00	5125.00
HP-125	1375.00	1375.00
HP-87	249.00	249.00
HP-85A	379.00	379.00
HP-85	875.00	875.00
HP-125	425.00	425.00

CALCULATORS

HP-12C

HP-15C

HP-30C

HP-31C

HP-32C

HP-33C

HP-34C

HP-35C

HP-36C

HP-37C

HP-38C

HP-39C

HP-40C

HP-41C

HP-42C

HP-43C

HP-44C

HP-45C

HP-46C

HP-47C

HP-48C

HP-49C

HP-50C

TERMS: NO Cashier's Check Bank Wire Personal checks allow 2 weeks for processing. Include Driver's License and credit card #. Visa, MC, AMEX, CB add 3% service charge. Add 3% shipping & handling or \$2 whichever is greater. Add 10% for foreign orders or US Parcel Post. Include Telephone number. NO COD'S. Prices subject to change without notice. Some items subject to prior sale. We reserve the right to substitute manufacturer. Retail prices may vary.

SUPER SPECIALS

MOUNTAIN COMPUTER	SAVE \$300	ELPAC FD206 8"	AMDEK
CPS Multifunction Card \$239.00 Sale \$169.95	Apple Board Set 280 Software (Microsoft) 16K Ramcard Vision 80 display card (Vista) All To IEEE Only V 85 1/4" 35 Tr	LIST \$395.00 195.00 169.00 395.00	ACP \$289.00 199.00 299.00
		Floppy Disk Power Supply Drives 2 Drives +24V @ 3A +5V @ 2.5A -5V @ 0.5A	12" B&W Monitor (Super Value) \$89 ea.

ADVANCED COMPUTER PRODUCTS

SEND \$2.00 for 104 PAGE CATALOG

16K Apple™ Ramcard

LIST 195
ACP
\$74.95

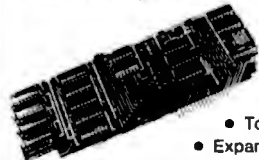

- Full 1 year warranty
- Top quality — gold fingers
- Expand Apple II 48K to 64K
- Compatible with Z-80 Softcard™
- Allows system to run with CP/M™, PASCAL, DOS 3.3, COBAL, Visicalc, etc.
- Supplied with extra 16K RAM & has (2) LED's

32K STATIC RAM

- 2 or 4 MHz
Expandable
Uses
2114's
- 16K 4 MHz Kit \$199.95
 - 16K 4 MHz AS7 \$179.95
 - 32K 4 MHz Kit \$199.95
 - 32K 4 MHz AS7 \$179.95
 - BARE BOARD \$99.95
 - Bare Bdw/all parts less mem \$99.95

BARE BOARDS

- S-100 Sound Board \$34.95
- 8080A CPU \$34.95
- 32K Static RAM (2114) \$4.95
- 8K EPROM (2708) \$4.95
- 2708/2716 EPROM \$4.95
- ACP Proto Board \$22.95
- Vector 8800 Proto \$22.20
- Vector 8803 11 slot MB \$29.95
- ACP Extender with connector \$18.95
- 13 Slot Mother Board (WMC) \$32.95
- 9 Slot Mother Board (WMC) \$29.95
- 8 Slot Mother Bd (Expandable) \$34.95
- Floppy PCB (8 - SHUGART) \$39.95
- S100 (AYS-8910) Sound Board \$34.95
- Apple Sound Board \$24.95

Astec RF Modulator

- for
COLOR
&
B/W
- P/N 1082 Channel 3 or 4 \$8.95
 - P/N 4151 UHF Channel 33 \$8.95

MOSTEK 4K RAMS

- 29¢ ea.
200,000 pieces in stock — priced to move
Same as MK4027 ext rept 1ms refresh MK4015 4Kx1 RAM

PMI "Super Beta" LOW POWER AMPLIFIER

- INTERNALLY COMPENSATED
P/N OP12J
- Voffset = 1.0 mV
 - Ibias = 5.0 mA
 - Gain = 40V/mV (quantity limited)

4K STATIC RAM SELL-OFF

- Same as TMS4024 but designed specifically for Z-80 based systems. This is a full-spec 4Kx1 RAM, 45ns. Order P/N ZIG6104 while supply lasts.

Zilog Z8 CPU with TINY BASIC

- Debug prog. \$49.95
Plus 6132 companion quasi-static RAM 29.95

"BLINKER" LED's

- Respond to sound. Complete, ready to use (2"x2") Sold at Neuman Marcus for \$9.95 ACP \$49.95 red, yellow, green LED's

16K Memory Expansion Kits for Apple/TRS-80

- 8 pins 4118 16K 200/250s
Special computer \$12.95
CALL FOR VOLUME PRICING

"D" SUB CONNECTORS

- Unreal price DB37 male, DB25 female Gold PC mount with mounting holes Mtg. AMP Specify 25 or 37 pins
- BD37 \$2.50
 - DB25 \$1.95

Stepper Motor

- USED IN DATA PRODUCTS PRINTER
\$19.95 ea.

12 VOLT BUZZER/HORN

- 2" DIAMETER ALL METAL
2/\$1.99

GE D43C3

- PNP power HFE = 40-120 VCEO = 30 IC = 3A 8,000 pcs available
69¢ ea.

CONNECTORS

- DB25P (RS232) \$3.25
DB25S Female 3.75
Hood 1.25
Set with Hood, Sale 7.50
22/44 B/T, KIM 2.85
43/86 B/T, MOT 6.95
50/100 B-100 Connector W/W 4.95
50/100 B-100 Connector S/T 3.95

Full ASCII Encoded Keyboards

- RCA128-Character, 58-Key Typewriter Format for Alphanumeric Entry
- VP-906 Async serial output Reg. \$99.00
 - ACP SALE ... \$69.95

MICROPROCESSORS

Z8001	890.00	8008-1	814.95	6802P	14.95
Z8002	89.00	2901	9.90	8035	14.95
Z80	8.25	2301A	14.95	8036	12.95
Z80A	11.95	9900A	48.95	8073A	34.95
F-6 (Z800)	18.95	6902	9.95	8735	48.95
2650	16.95	8822A	16.95	8748	48.95
1802	9.75	84030	29.95	8838	39.95
8050A	4.75	8908	11.75	8088	39.95
8085	14.95	8908B	19.95	89000	129.95

CALL FOR QTY PRICING

6118/2016	67.95	2147	85.99	5290	81.99
6264-64K	8.50	411	5.99	5298	1.49
4118-2	1.99	414	4.89	6208	4.49
4118-2 8/125	11.01	99	6518	6.79	
2101	3.99	1103	99	6561	3.79
2102	7.8	4027	4.89	8904	3.99
21L02-2	1.49	4044	3.99	9005	5.99
21L02-4	1.29	4050	4.89	9130	7.99
2111	3.49	4080	4.89	9140	5.99
2112	3.49	4096	3.99	93415	8.99
2114	1.99	4115	1.99	93425	8.99
2114L-2	3.25	4200	95		
2114L-4	2.29	4402	1.99		
2125	6.99	5280	4.00		

CALL FOR QTY PRICING

8156	99.95	8259	83.95	88047	522.95
8156	9.95	8275	19.95	89488	19.95
8202	29.95	8710	9.50	48505	22.95
8205	2.89	8810	4.75	8520	6.95
8212	2.75	8820	4.50	8622	6.95
8214	4.95	8821	6.50	8630-X	24.95
8216	2.75	8828	5.00	8632	11.95
8224	2.95	8834	18.95	8651	19.95
8226	2.95	8846	22.95	Z80-PIO	6.50
8228	3.95	8847	27.95	Z80A-PIO	6.50
8243	9.50	8850	5.25	Z80-CYC	8.50
8250	14.95	8912	5.25	Z80A-CYC	8.50
8251	6.50	8980	10.95	Z80-DMA	19.95
8253	11.95	8982	10.95	Z80-DMA	27.95
8255	4.95	8985	5.95	Z80-SIO	24.95
8257	9.50	8980	2.49	Z80A-SIO	29.95

MOS PROMS

2764 (8Kx8) TS	899.95	2708 (450nS)	85.75
2732 (4Kx8) TS	12.95	2708 (850nS)	5.25
2716/2516, 5V (2Kx8) TS	7.95	1702A	5.75
TMS2716, 5V, 12V 1708, 5V, (480nS) 3.90		MMS203AQ	14.95
		MMS204Q	9.95

HI-TECH

2513-001 5V Uppr	89.50	DAC08	89.95
2513-005 5V Lwr	10.95	DA02	9.95
2513-AD83 5V Lwr	14.95	8038 Function Generator	8.95
MC886110 8038 10pin	24.95	MC8224 VCO	2.95
MC8867 40 MHz Synthesizer	13.95	LM555 VC	1.95
MC2886 750 Alpha Control	13.45	XR2706 Function Generator	5.25
1771-01 F & Memory	24.95	1916028 (5V 12V)	3.95
1781 Dual Flip Flop	29.95	A91013 (5V 12V)	4.95
1791 01 Dual Flip Flop	29.95	A91013 (15-14V)	8.95
1794 02 Dual Flip Flop	44.95	A91013 A/83 (5V)	7.95
1794 03 Dual Flip Flop	44.95	MM6402	9.95
1797 00 Dual Flip Flop	54.95	MM6403	9.95
1691 Data Separator	18.95	230 USAT	8.95
1743 Clock Generator	18.95	17181 Address	24.95
8700 8 bit Binary	12.95	ME6111	11.95
8703 16 bit Binary	22.00	4702	14.95
9600 Vart to Preg Conv	7.75	COM5016	16.95
1790 3 1/2 Digit BCD	13.95	RS8290	15.95
14098 8 bit	3.95	AY5-275	13.75
14078 8 bit	5.95	AY5-3600	13.75
DACS10 to A	5.95	MMS17ADAC	8.95

SOCKETS

8 pin LP	16	15	14
14 pin LP	20	19	18
18 pin LP	22	21	20
18 pin LP	29	28	27
20 pin LP	34	32	30
22 pin LP	29	27	24
24 pin LP	38	37	36
28 pin LP	45	44	43
40 pin LP	80	58	56

LOW PROFILE SOCKETS (TIN)

1-24	25-49	50-100	
8 pin LP	16	15	14
14 pin LP	20	19	18
18 pin LP	22	21	20
18 pin LP	29	28	27
20 pin LP	34	32	30
22 pin LP	29	27	24
24 pin LP	38	37	36
28 pin LP	45	44	43
40 pin LP	80	58	56

3L WIREWRAP SOCKETS (GOLD)

1-24	25-49	50-100	
8 pin WW	55	54	49
10 pin WW (Tin)	55	63	58
14 pin WW	75	73	70
16 pin WW	75	73	70
18 pin WW	95	90	61
20 pin WW	115	108	99
22 pin WW	145	135	123
24 pin WW	135	126	114
28 pin WW	189	180	168
40 pin WW	225	209	189

SUPER IC CLOSEOUT SPECIALS

UM2203	2/81	99	2M8121	3/81	00	8080A CPU	2.95	5027 CRT	89.95
74L3068	3/1	99	516	2652	3.95	2102 RAM	1.49	11224	6.95
74LS377	2/1	99	74S287	1.95	4080 RAM	1.49	2583	2.99	
74LS241	2/1	99	2775 EPROM	2.95	8X200 CPU	14.95	MMS320	5.99	
8259	6.95	74173/BT10	5/1	99	74S387	1.95	9131 RAM	1.99	
6661 RAM	6.95	Z80A CPU	4.95	2708 EPROM	8/29	95	EMM402	1.99	
LM733CN	3/1	99	8522	6.95	74LS93	3/1	00	1103 RAM	3/1,50
MC1414	3/1	99	8602 CPU	5.95	2114	8/14,50	8700 A/D	2/16,95	

TOLL FREE

800-854-8230
TWIN
910-595-1565

LINEAR

78H06K	55.95	LM1414N	2.99	7400 S	19	7475 S	38	74181 S	28
78M06	1.49	LM1458C/N/N	49	7401	22	7476	34	74192	39
78L06	1.49	MC1489	2.99	7402	22	7479	40	74193	39
LM1084H	2.95	MC1498N	99	7403	22	7480	49	74194	87
LM300H	99	LM1498N	99	7404	22	7482	95	74195	87
LM301CN	35	LM1558N	1.50	7405	23	7483	55	74196	120
LM304H	1.98	LM1820N	1.95	7406	35	7485	65	74197	185
LM305H	1.99	LM1850N	95	7407	35	7486	55	74199	139
LM308H	3.25	LM1869N	3.10	7408	39	7489	175	74172	475
LM307CN	29	LM2111N	1.75	7409	23	7490	39	74173	70
LM308CN	98	LM2900N	99	7410	22	7491	57	74174	89
LM308K	1.49	LM2901N	2.50	7411	29	7492	45	74175	85
LM310CN	1.25	LM2917N	2.95	7412	29	7493	45	74176	75
LM312H	89	CA3013T	2.19	7413	39	7494	39	74177	95
LM317	1.70	CA3021T	3.49	7414	59	7495	65	74179	134
LM318CN	1.49	CA3023T	2.99	7416	29	7496	69	74180	75
LM319NH	1.25	CA3035T	2.75	7417	29	7497	290	74181	175
LM320K-XX*	1.35	CA3039T	1.29	7420	22	74100	290	74182	96
LM320T-XX*	1.39	CA3046N	1.29	7421	36	74107	32	74184	225
LM320H-XX*	1.25	LM3053N	1.49	7422	29	74109	37	74185	225
LM323K	4.95	CA3059N	3.19	7423	29	74116	95	74188	9.95
LM324N	95	CA3060N	3.19	7426	29	74123	39	74190	115
LM337K	5.95	CA3062N	4.95	7427	25	74129	59	74191	115
LM338K	6.95	LM3065N	1.69	7428	45	74135	39	74192	95
LM339K	6.95	CA3080	1.49	7429	39	74140	29	74193	85
LM340K-XX*	1.75	CA3081N	1.89	7432	29	74128	59	74194	85
LM340T-XX*	1.25	CA3082N	1.69	7437	25	74132	69	74195	85
LM340H-XX*	1.25	CA3083N	1.55	7438	29	74136	75	74196	85
LM344H	1.95	CA3086N	2.99	7439	29	74139	95	74197	85
LM349H	1.95	LM3089N	3.49	7440	19	74143	95	74198	85
LM350K	5.60	CA3096N	2.49	7441	79	74142	295	74199	139
LM358CN	96	CA3097N	1.99	7442	57	74143	295	74221	119
LM380N	1.49	CA3130T	1.30	7443	95	74144	295	74251	95
LM387N	1.95	CA3140T	1.19						

DIGITAL RESEARCH COMPUTERS

(214) 271-3538

32K S-100 EPROM CARD

NEW!

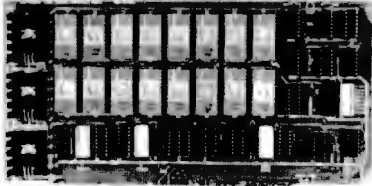

\$79.95
KIT

USES 2716's
Blank PC Board - \$34
ASSEMBLED & TESTED
ADD \$30

SPECIAL: 2716 EPROM's (450 NS) Are \$9.95 Ea. With Above Kit.

KIT FEATURES

1. Uses +5V only 2716 (2Kx8) EPROM's
2. Allows up to 32K of software on line!
3. IEEE S-100 Compatible
4. Addressable as two independent 16K blocks
5. Cromemco extended or Northstar bank select
6. On board wait state circuitry if needed
7. Any or all EPROM locations can be disabled
8. Double sided PC board, solder-masked, silk-screened
9. Gold plated contact fingers
10. Unselected EPROM's automatically powered down for low power
11. Fully buffered and bypassed
12. Easy and quick to assemble

64K S100 STATIC RAM

\$399⁰⁰ KIT
NEW!

LOW POWER!
RAM OR EPROM!
BLANK PC BOARD
WITH DOCUMENTATION
\$55

SUPPORT ICs + CAPS
\$17.50

FULL SOCKET SET
\$14.50

FULLY SUPPORTS THE
NEW IEEE 696 S100
STANDARD
(AS PROPOSED)
FOR 56K KIT \$349
ASSEMBLED AND
TESTED ADD \$40



FEATURES:

- * Uses new 2K x 8 (TMM 2016 or HM 6116) RAMs.
- * Fully supports IEEE 696 24 BIT Extended Addressing.
- * 64K draws only approximately 500 MA.
- * 200 NS RAMs are standard. (TOSHIBA makes TMM 2016s as fast as 100 NS. FOR YOUR HIGH SPEED APPLICATIONS.)
- * SUPPORTS PHANTOM (BOTH LOWER 32K AND ENTIRE BOARD).
- * 2716 EPROMs may be installed in any of top 48K.
- * Any of the top 8K (E000 H AND ABOVE) may be disabled to provide windows to eliminate any possible conflicts with your system monitor, disk controller, etc.
- * Perfect for small systems since BOTH RAM and EPROM may co-exist on the same board.
- * BOARD may be partially populated as 56K.

16K STATIC RAM KIT-S 100 BUSS

PRICE CUT!

\$149⁹⁵ KIT

FOR 4MHZ
ADD \$10

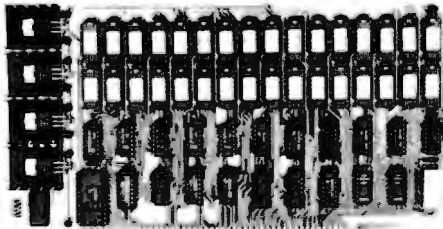

KIT FEATURES

1. Addressable as four separate 4K Blocks
2. ON BOARD BANK SELECT circuitry (Cromemco Standard!) Allows up to 512K on line!
3. Uses 2114 (450NS) 4K Static Rams
4. ON BOARD SELECTABLE WAIT STATES
5. Double sided PC Board, with solder mask and silk screened layout. Gold plated contact fingers
6. All address and data lines fully buffered
7. Kit includes ALL parts and sockets
8. PHANTOM is jumpered to PIN 67
9. LOW POWER under 1.5 amps TYPICAL from the +8 Volt Buss
10. Blank PC Board can be populated as any multiple of 4K.

BLANK PC BOARD W/DATA-\$33
LOW PROFILE SOCKET SET-\$12
SUPPORT IC'S & CAPS-\$19.95
ASSEMBLED & TESTED-ADD \$35

**OUR #1 SELLING
RAM BOARD!**

64K SS-50 STATIC RAM

\$299⁰⁰ (48K KIT)

NEW!

LOW POWER!
RAM OR EPROM!
BLANK PC BOARD
WITH
DOCUMENTATION
\$52

SUPPORT ICs + CAPS
\$18.00

FULL SOCKET SET
\$15.00

56K Kit \$349
64K KIT \$395
ASSEMBLED AND
TESTED ADD \$40

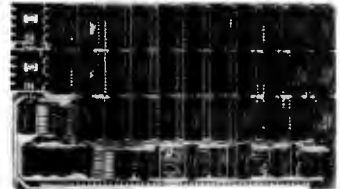

FEATURES:

- * Uses new 2K x 8 (TMM 2016 or HM 6116) RAMs.
- * Fully supports Extended Addressing.
- * 64K draws only approximately 500 MA.
- * 200 NS RAMs are standard. (TOSHIBA makes TMM 2016s as fast as 100 NS. FOR YOUR HIGH SPEED APPLICATIONS.)
- * Board is configured as 3-16K blocks and 8-2K blocks (within any 64K block) for maximum flexibility.
- * 2716 EPROMs may be installed anywhere on Board.
- * Top 16K may be disabled in 2K blocks to avoid any I/O conflicts.
- * One Board supports both RAM and EPROM.
- * RAM supports 2MHZ operation at no extra charge!
- * Board may be partially populated in 16K increments.

STEREO! S-100 SOUND COMPUTER BOARD

NEW!

At last, an S-100 Board that unleashes the full power of two unbelievable General Instruments AY3-8910 NMOS computer sound IC's. Allows you under total computer control to generate an infinite number of special sound effects for games or any other program. Sounds can be called in BASIC ASSEMBLY LANGUAGE, etc.

KIT FEATURES:

- * TWO GI SOUND COMPUTER IC'S
 - * FOUR PARALLEL I/O PORTS ON BOARD
 - * USES ON BOARD AUDIO AMPS OR YOUR STEREO
 - * ON BOARD PROTO TYPING AREA
 - * ALL SOCKETS, PARTS AND HARDWARE ARE INCLUDED
 - * PC BOARD IS SOLDERMASKED, SILK SCREENED WITH GOLD CONTACTS
 - * EASY QUICK, AND FUN TO BUILD WITH FULL INSTRUCTIONS
 - * USES PROGRAMMED I/O FOR MAXIMUM SYSTEM FLEXIBILITY
- Both Basic and Assembly Language Programming examples are included

SOFTWARE:

SCL™ is now available! Our Sound Command Language makes writing Sound Effects programs a SNAP! SCL™ also includes routines for Register-Examine-Modify, Memory-Examine-Modify, and Play-Memory. SCL™ is available on CP/M™ compatible diskette or 2708 or 2716. Diskette - \$24.95 2708 - \$19.95 2716 - \$29.95. Diskette includes the source. EPROM'S are ORG at E000H. (Diskette is 8 Inch Soft Sectored)

COMPLETE KIT!

\$84⁹⁵

(WITH DATA MANUAL)

BLANK PC
BOARD W/DATA
\$31

SPECIAL PURCHASE!

UART SALE!

TR1602B - SAME AS TMS6011,
AY5-1013, ETC. 40 PIN DIP

TR1602B

\$2⁹⁵ EACH

4 For \$10⁰⁰

CRT CONTROLLER CHIP

SMC #CRT 5037. PROGRAMMABLE FOR 80 x 24, ETC. VERY RARE SURPLUS FIND. WITH PIN OUT. \$12.95 EACH.

NEW! G.I. COMPUTER SOUND CHIP

AY3-8910 As featured in July, 1979 BYTE! A fantastically powerful Sound & Music Generator. Perfect for use with any 8 Bit Microprocessor. Contains 3 Tone Channels, Noise Generator, 3 Channels of Amplitude Control, 16 bit Envelope Period Control, 2-8 Bit Parallel I/O, 3 D to A Converters, plus much more! All in one 40 Pin DIP. Super easy interface to the S-100 or other busses. **\$11.95** PRICE CUT!
SPECIAL OFFER: **\$14.95** each Add \$3 for 60 page Data Manual.

TERMS: Add \$2.00 postage. We pay balance. Orders under \$15 add 75¢ handling. No C.O.D. We accept Visa and MasterCard. Tex. Res. add 5% Tax. Foreign orders (except Canada) add 20% P & H. Orders over \$50, add 85¢ for insurance.

Digital Research Computers

(OF TEXAS)

P.O. BOX 401565 • GARLAND, TEXAS 75040 • (214) 271-3538

*TRADEMARK OF DIGITAL RESEARCH.

WE ARE NOT ASSOCIATED WITH DIGITAL RESEARCH OF CALIFORNIA, THE SUPPLIERS OF CPM SOFTWARE.

NEW LOWER PRICES

**"THE BIG BOARD"
OEM - INDUSTRIAL - BUSINESS - SCIENTIFIC
SINGLE BOARD COMPUTER KIT!
Z-80 CPU! 64K RAM!**

NEW!

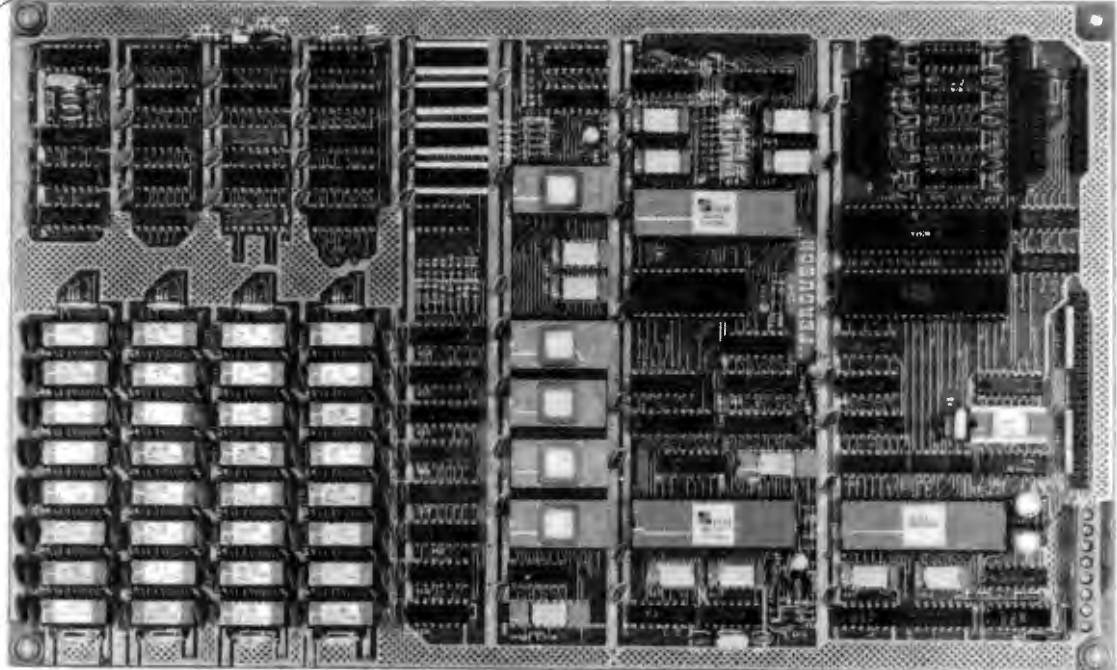

PARTIALLY ASSEMBLED KITS
For All Sockets Installed
And Soldered Add \$50.

WANT MORE INFO?
Full Documentation and
Schematics — \$5.

THE BIG BOARD PROJECT: Three years in the works, and maybe too good to be true. A tribute to hard headed, no compromise, high performance, American engineering! The Big Board gives you all the most needed computing features on one board at a very reasonable cost. The Big Board was designed from scratch to run the latest version of CP/M*. Just imagine all the off-the-shelf software that can be run on the Big Board without any modifications needed! Take a Big Board, add a couple of 8 inch disc drives, power supply, an enclosure, C.R.T., and you have a total Business System for about 1/3 the cost you might expect to pay.

\$399⁰⁰** (64K KIT BASIC I/O)

SIZE: 8 1/2 x 13 3/4 IN.
SAME AS AN 8 IN. DRIVE.
REQUIRES: 5V @ 3 AMPS
12V @ .5 AMPS.

FULLY SOCKETED! FEATURES: (Remember, all this on one board!)

64K RAM

Uses industry standard 4116 RAM'S. All 64K is available to the user, our VIDEO and EPROM sections do not make holes in system RAM. Also, very special care was taken in the RAM array PC layout to eliminate potential noise and glitches.

Z-80 CPU

Running at 2.5 MHZ. Handles all 4116 RAM refresh and supports Mode 2 INTERRUPTS. Fully buffered and runs 8080 software.

SERIAL I/O (OPTIONAL)

Full 2 channels using the Z80 SIO and the SMC 8116 Baud Rate Generator. FULL RS232! For synchronous or asynchronous communication. In synchronous mode, the clocks can be transmitted or received by a modem. Both channels can be set up for either data-communication or data-terminals. Supports mode 2 Int. Price for all parts and connectors: \$49

BASIC I/O

Consists of a separate parallel port (Z80 PIO) for use with an ASCII encoded keyboard for input. Output would be on the 80 x 24 Video Display.

24 x 80 CHARACTER VIDEO

With a crisp, flicker-free display that looks extremely sharp even on small monitors. Hardware scroll and full cursor control. Composite video or spill video and sync. Character set is supplied on a 2716 style ROM, making customized fonts easy. Sync pulses can be any desired length or polarity. Video may be inverted or true. 5 x 7 Matrix - Upper & Lower Case

FLOPPY DISC CONTROLLER

Uses WD1771 controller chip with a TTL Data Separator for enhanced reliability. IBM 3740 compatible. Supports up to four 8 inch disc drives Directly compatible with standard Shugart drives such as the SA800 or SA801. Drives can be configured for remote AC off-on. Runs CP/M* 2.2.

TWO PORT PARALLEL I/O (OPTIONAL)

Uses Z-80 PIO. Full 16 bits, fully buffered, bi-directional. User selectable hand shake polarity. Set of all parts and connectors for parallel I/O: \$19.95

REAL TIME CLOCK (OPTIONAL)

Uses Z-80 CTC. Can be configured as a Counter on Real Time Clock. Set of all parts: \$9.95

BLANK PC BOARD — \$149

The blank Big Board PC Board comes complete with full documentation (including schematics), the character ROM, the PFM 3.3 MONITOR ROM, and a diskette with the source of our BIOS, BOOT, and PFM 3.3 MONITOR.

CP/M* 2.2 FOR BIG BOARD

The popular CP/M* D.O.S. to run on Big Board is available for \$159.00.

PRICE CUT!

PFM 3.3 2K SYSTEM MONITOR

The real power of the Big Board lies in its PFM 3.3 on board monitor. PFM commands include: Dump Memory, Boot CP/M*, Copy, Examine, Fill Memory, Test Memory, Go To, Read and Write I/O Ports, Disc Read (Drive, Track, Sector), and Search. PFM occupies one of the four 2716 EPROM locations provided. Z-80 is a Trademark of Zilog.

Digital Research Computers
(OF TEXAS)
P.O. BOX 401565 • GARLAND, TEXAS 75040 • (214) 271-3538

TERMS: Shipments will be made approximately 3 to 6 weeks after we receive your order, VISA, MC, cash accepted. We will accept COD's (for the Big Board only) with a \$75 deposit. Balance UPS COD. Add \$4.00 shipping. USA AND CANADA ONLY

Mini Stereo AM/FM Receiver

WITH HEADPHONES - For Joggers, Cyclists, Skaters & Sports Events



FEATURES: Lightweight headphones. Left/right balance control. Full fidelity stereo sound. Additional black soft carrying case & shoulder strap. Belt clip (hands free). Operates on 3 AA cell batteries (not incl.). Compact size: 3 1/4" x 4 1/4" x 1". Wt. 6 oz.

Model 2830 List Price \$69.95 **\$34.95**

SPEAKERS



2 1/2" Round - 8 Ohm
2.5 Watt (4 mount holes)
Size: 2 1/4" x 3/4"
Part No. A0201 . . . \$1.25 or 2/11.98

2" Square - 16 Ohm
2.5 Watt (4 mount holes)
Large Ceramic Magnet
Size: 2 1/4" x 2 1/4" x 3/4"
Part No. SF-25018 . . . \$1.39 or 2/12.98

National Semiconductor

RAM SALE

- STATIC RAMS**
- MM2114N-2 4K (200NS) . . . \$2.49 each
 - MM2114N-2L 4K (200NS) Low Power . . . \$2.95 each
 - MM2147N 4K (70NS) . . . \$4.95 each
 - MM6116P-4 16K (200NS) . . . \$9.95 each
- DYNAMIC RAMS**
- MM4164N-20 64K (200NS) . . . \$9.95 each
 - MM5261N 1K (300NS) . . . \$11.95
 - MM5262N 2K (365NS) . . . \$11.95
 - MM5290N-2 16K (150NS) 4116 . . . \$2.95 each
 - MM5290N-4 16K (200NS) 4116 . . . \$1.95 each

EPROM Erasing Lamp



- Erases 2708, 2716, 1702A, 5203Q, 5204Q, etc.
 - Erases up to 4 chips within 20 minutes.
 - Maintains constant exposure distance of one inch.
 - Special conductive foam liner eliminates static build-up.
 - Built-in safety lock to prevent UV exposures.
 - Compact - only 7-8 1/2" x 2-7/8" x 2"
 - Complete with holding tray for 4 chips. . . \$16.95
- UVS-11EL Replacement Bulb . . . \$16.95

UVS-11E . . . \$79.95

JOYSTICKS



- JS-5K 5K Linear Taper Pots . . . \$5.25
- JS-100K 100K Linear Taper Pots . . . \$4.95
- JS-150K 150K Linear Taper Pots . . . \$4.75
- JVC-40 40K (2) Video Controller in case . . . \$4.95

5 1/4" Mini-Floppy Disc Drive

FOR TRS-80 MODEL I, II (Industry Standard)
Features single or double density. Recording mode: FM single, MFM double density. Power: +12VDC +/- 0.6V 1.8 amp max. 5VDC (+/- 0.25V) 0.8 amp max. Unit as pictured at left does not incl. case, power supply or cables. 30-page data book included. Weighs 3 1/2 pounds. Size: 5 1/4" x 8" x 1 1/2".

Part No. Limited Quantity Price
FD200 Single-sided, 40 tracks, 250K bytes capacity . . . \$179.95
FD250 Double-sided, 36 tracks, 438K bytes capacity . . . \$199.95

NEW! JE215 Adjustable Dual Power Supply

General Description: The JE215 is a Dual Power Supply with independent adjustable positive and negative output voltages. A separate adjustment for each of the supplies provides the user unlimited applications for IC current voltage requirements. The supply can also be used as a general all-purpose variable power supply.

FEATURES:

- Adjustable regulated power supplies, pos. and neg. 1.2VDC to 15VDC.
- Power Output (each supply): 5VDC @ 500mA, 10VDC @ 750mA, 12VDC @ 500mA, and 15VDC @ 175mA.
- Two, 3-terminal adj. IC regulators with thermal overload protection.
- Heat sink regulator cooling.
- LED "on" indicator.
- Printed Board Construction.
- 120VAC input.
- Size: 3-1/2" W x 5-1/8" L x 2-1/8" H

- JE215 Adj. Dual Power Supply Kit (as shown) . . . \$24.95
(Picture not shown but similar in construction to above)
JE200 Reg. Power Supply Kit (5VDC, 3 amp) . . . \$14.95
JE205 Adapter Brd. to JE200 (5, 9, 3, & 12V) . . . \$12.95
JE210 Var. Pwr. Sply. Kit, 5-15VDC, to 1.5amp. . . \$19.95

MICROPROCESSOR COMPONENTS

8080A/8080A SUPPORT DEVICES		DATA ACQUISITION (CONTINUED)	
IN5300A	8-Bit Input/Output	ADC0809CN	8-Bit A/D Converter (8-Ch. Multi.)
DP212	Priority Interrupt Control	ADC0809LCN	8-Bit A/D Conv. Micro Comp. (8098)
DP214	8-Directional Bus Driver	DAC0809CN	8-Bit D/A Converter (8-Ch. Multi.)
DP224	Clock Generator/Driver	DAC0809LCN	8-Bit D/A Conv. Micro Comp. (8098)
DP228	Bus Driver	DAC1024CN	10-Bit D/A Converter (0.05% Lin.)
DP228	System Controller/Bus Driver	DAC1024LCN	10-Bit D/A Converter (0.2% Lin.)
DP234	System Controller	CD4001N	3-Input NAND
IN5443	I/O Expander for 48 Series	CD45103	30K Auto UART
IN5450	Asynchronous Comm. Element	---RAM'S---	
DP251	Prog. Comm. 1/O (USART)	1103	256K Dynamic
DP252	Prog. Interval Timer	1104	1024K Dynamic
DP253	Prog. Interval Timer	2103 (8013)	256K Static
DP254	Prog. Interval Timer	2104	1024K Static
DP255	Prog. Interval Control	2110	256K Static
DP275	Prog. CRT Controller	3111 (8111)	256K Static
DP279	Prog. Keyboard/Display Interface	3112	256K Static MOS
DP280	Prog. DMA Controller	3113	256K Static MOS
DP304	8-Bit Bi-Directional Receiver	3214	1024K Static 40ns Low Power
DP307	8-Bit Bi-Directional Receiver	3214-2	1024K Static 200ns
DP308	8-Bit Bi-Directional Receiver	3214-2	1024K Static 200ns
DP310	Octal Latched Peripheral Driver	3214-2	1024K Static 200ns Low Power
DP311	Octal Latched Peripheral Driver	3214-2	1024K Static 200ns
MC6801	MPU	4318A (UPD4318)	16K Dynamic 20ns (MMS20N-4)
MC6802	MPU with Clock and RAM	4318N	34K Dynamic 200ns
MC6801AP1	128K Static RAM	4318N	4096K Fast 8ns
MC6801AP2	Priority Interf. Adapt (MC6801)	4318N	256K Static
MC6801AP3	Priority Interf. Controller	4318N	1024K Dynamic Fully Decoded
MC6802A	1024x8-Bit ROM (MC6802A)	4318N	256K Dynamic
MC6802B	Asynchronous Comm. Adapter	4318N	1024K Dynamic (UPD4318)
MC6803	Synchronous Serial Data Adapter	4318N	8K Dyn. 200ns (Power of MMS20N)
MC6804	4000bps Digital MODEM	4318N	16K (1Kx8) Static
MC6805	Quick 8-Bit Bus Trans. (MC6805)	4318N	64K Bit RAM (8x4096)
MC6806	4000bps Digital MODEM	4318N	4K Dynamic 80ns
MC6807	Quick 8-Bit Bus Trans. (MC6807)	4318N	4K Static
MC6808	4000bps Digital MODEM	4318N	1024K Static
MC6809	4000bps Digital MODEM	4318N	1024K Static

6800/6800 SUPPORT DEVICES		MICROPROCESSOR CHIPS	
MC6800	MPU	Z80	80C
MC6801	MPU with Clock and RAM	Z80A	80C
MC6801AP1	128K Static RAM	Z80A (780-1)	80C
MC6801AP2	Priority Interf. Adapt (MC6801)	Z80A (780-1)	80C
MC6801AP3	Priority Interf. Controller	Z80A (780-1)	80C
MC6802A	1024x8-Bit ROM (MC6802A)	Z80A (780-1)	80C
MC6802B	Asynchronous Comm. Adapter	Z80A (780-1)	80C
MC6803	Synchronous Serial Data Adapter	Z80A (780-1)	80C
MC6804	4000bps Digital MODEM	Z80A (780-1)	80C
MC6805	Quick 8-Bit Bus Trans. (MC6805)	Z80A (780-1)	80C
MC6806	4000bps Digital MODEM	Z80A (780-1)	80C
MC6807	Quick 8-Bit Bus Trans. (MC6807)	Z80A (780-1)	80C
MC6808	4000bps Digital MODEM	Z80A (780-1)	80C
MC6809	4000bps Digital MODEM	Z80A (780-1)	80C

1173AN-1 30 Tone Musical MPU Chip . . . 8.95

DATA ACQUISITION	
DC18	Mostek DC/DC Convert. -8V to +2V
MC1401P	Floppy Disk Read AMP System
MC1401L	7-Bit D/A Converter (DAC0809LCN)
MC1401A	8-Bit D/A Converter (DAC0809CN)
AF1201CN	Universal Active Filter
AF1211CN	Touch Tone Low Band Filter
AF1212CN	Touch Tone High Band Filter
MC1302CH	Super Gain Op Amp
LM1342	Constant Current Source
LM1342	Temperature Transducer
LF387N	JFET Input Op Amp
LF399N	Sample & Hold Amplifiers
LM399A	Temp. Comp. Prec. Ref. (50ppm/C)
ADCM0809CN	8-Bit D/A Converter (0.05% Lin.)
DAC0809CN	8-Bit D/A Converter (0.05% Lin.)

EEPEE Wee Boxer Fan

- 36cm free air delivery
- 3.125" sq. x 1.665" depth
- 10 VDC cont. duty at 20°C
- 115V 50/60Hz
- For Appliance uses
- PWS2107U . . . \$ 9.95 ea.
- MU2A11U . . . \$14.95 ea.

Muffin* Fan

- 105cm free air delivery
- 4.68" sq. x 1.50" depth
- 10 VDC cont. duty at 20°C
- Impedance protected
- arrivals to 70°C
- 115V 50/60Hz 14W Wt. 17 oz.
- MU2A11U . . . \$9.95 ea.
- MU2A11U . . . \$14.95 ea.

KEYBOARDS

- MICRO SWITCH 69-KEY KEYBOARD** Limited Quantity!
Uses AMI SW20350K Chip. Size: 18 1/2" L x 5 1/4" W x 1 1/2" H. Metal Frame. Light and dark grey key caps (no data sheet).
Part No. KB69SD12-2 . . . \$19.95 each
- DATANETICS 74-KEY KEYBOARD** Limited Quantity!
Uses EA20134 Chip (Electronic Array). Size: 16 1/2" L x 5 1/4" W x 1 1/2" H. White, black, blue, grey key caps. Data sheets not available.
Part No. KB354 . . . \$29.95 each
- STACKPOLE 82-KEY ASCII KEYBOARD** Standard Stocked Item!
SPST Switching (Mechanical). Size: 13 1/2" L x 3 1/4" W x 1 1/2" H. Grey key caps. Data sheets are available.
Part No. K-82 . . . \$34.95 each
(ASCII Encoded Keyboard Kit - JE610K . . . \$79.95)
- MICRO SWITCH 69-KEY KEYBOARD** Standard Stocked Item!
Uses SD 25010K Chip (AM) Size: 18 1/2" L x 5 1/4" W x 1 1/2" H. Dark and light grey key caps. Used in a Diablo 1640 Terminal (schematic avail).
Part No. 88SD22 . . . \$69.95 each

POWER SUPPLIES

- POWER SUPPLY - 5VDC @ 1 AMP REGULATED** Transcon Tech
Output +5VDC @ 1 amp (incl. +30VDC) reg. input 115VAC 60Hz. Two-tone (black/white) self-enclosed case. 6 foot, 3 conductor black power cord. Size: 6 1/2" W x 7 1/2" D x 2 1/4" H - Wt. 1.5 lbs.
Part No. PS51194 . . . \$19.95 each
- POWER SUPPLY - 5VDC @ 1 AMP REGULATED** B Industries
Output +5VDC @ 1 amp, +38-24VDC Adjusted, 400mA or less, 30VAC (isolated) @ 1.5 amp input 115VAC 60Hz. On/off breaker switch button. Black self-enclosed case with 4 rubber feet. 6 foot, 3 conductor black power cord. On/off switch. Size: 6 1/2" W x 7 1/2" D x 3 1/4" H - Wt. 1.7 lbs.
Part No. PS4072 . . . \$24.95 each
- POWER PAC Heavy Duty Multi-Voltage Power Supply - 5VDC, 12VDC & 24VDC** Output +5VDC @ 30A, +12VDC @ 2A, +24VDC @ 4A and +24VDC @ 3A. Input 115VAC, 220VAC, 250VAC, 350VAC. Regulation: $\pm 1\%$ line and load combined. Ripple: 10mV peak to peak (RMS). Overvoltage protection: 5V, +12V, -12V. Overcurrent protection included. Size: 15 1/2" L x 6 1/2" W x 1 1/2" H - Wt. 40 lbs.
Part No. 265-018 . . . \$119.95 each

\$10.00 Minimum Order - U.S. Funds Only
California Residents Add 6% Sales Tax
Postage - Add 5% plus \$1.50 Insurance
Send S.A.S.E. for Monthly Sale Flyer!

Spec Sheets - 25c each
Send 86c Postage for your
FREE 1982 JAMECO CATALOG
Prices Subject to Change

Mail Order Electronics - Worldwide

ameco ELECTRONICS

1355 SHOREWAY ROAD, BELMONT, CA 94002
PHONE ORDERS WELCOME - (415) 592-8097

NEW 1982 CATALOG

NEW! Telex Number Telex 170043

BOOKS

- National Semiconductor - Interall - Intel . . . \$6.95
- 30001 National CMOS Data Book . . . \$5.95
- 30002 National Interface Data Book . . . \$6.95
- 30003 704 page Df. DS8000, DS8300, DS7600, etc. . . \$11.95
- 30004 National Linear Data Book . . . \$11.95
- 30005 1378 page L.M. L.F. ADC, DAC, L.H. Series . . . \$4.95
- 30006 National Series - Bus Board Local Computer (224 page) . . . \$4.95
- 30007 National TTL Logic Data Book . . . \$11.95
- (824 page) 7400, LS, L.H.S., and DM8000 Series

30006 Above (3) 30001, 3, 5 as set \$24.95/lot

010480 Intel Computer Data Book . . . \$14.95

206610 Intel Peripheral Design Handbook . . . \$9.95

Full data sheets, appl. notes for Intel peripheral device components (844 pages)

AC and DC Wall Transformers

Pat. No. DC8912
With Universal Plug and 9V Battery Snap

Selective voltages: 6.3, 12VDC
Polarity selection (+/-), six-foot line from adapter to plug - six-inch line from adapter to battery snap. 120V/60Hz, 300mA.

Part No.	Input	Output	Price
AC 250	117V/60Hz	12VAC 250mA	\$3.95
AC 500	117V/60Hz	12VAC 500mA	\$4.95
AC 1000	117V/60Hz	12VAC 1 amp	\$5.95
AC 1700	117V/60Hz	9VAC 1.7 amp	\$3.95
DC 200	120V/60Hz	5VDC 200mA (Batt. charger)	\$1.95
DC 500	120V/60Hz	6.3, 12VDC 500mA	\$9.95
DC 2000	117V/60Hz	9VDC 200mA	\$3.95
DC 12000	120V/60Hz	12VDC 300mA	\$2.95

CONNECTORS

- DB25P D-Subminiature Plug . . . \$2.95
- DB25S D-Subminiature Socket . . . \$3.50
- DB25/1226 Screw Lock Hdw. (2) DB25P/P . . . \$7.99
- DB25/1226 Cover for DB25P/P . . . \$1.75
- 22/44SEA P.C. Edge (22/44 Pin) . . . \$2.95
- UG88/U BNC Plug . . . \$1.79
- UG88/U BNC Jack . . . \$3.79
- UG17/U UHF Adapter . . . \$.49
- SO239 UHF Panel Recp. . . \$1.29
- PL258 UHF Adapter . . . \$1.60
- PL269 UHF Plug . . . \$1.60
- UG280/U BNC Plug . . . \$1.79
- UG1084/U BNC Bulkhead Recp. . . \$1.29

TRS-80 16K Conversion Kit

- Expand your 4K TRS-80 System to 16K
- Kit comes complete with:
- 6 ea. MM5290 (UPD418/4116) 16K Dyn. Ram (*na)
- Documentation for conversion
- TRS-16K2 *150ns . . . \$19.95
- TRS-16K3 *200ns . . . \$16.95
- TRS-16K4 *250ns . . . \$14.95

Mostek DC/DC Converter

- +5 VOLTS TO -8 VOLTS
- Input: +5V. Output: -8V (regulated) @ 30mA.
- Printed circuit mounting.
- DC10 . . . \$2.95 ea. or 2/\$4.95

JE610 ASCII Encoded Keyboard Kit



The JE610 ASCII Keyboard Kit can be interfaced into most any computer system. The kit comes complete with an industrial grade keyboard switch assembly (82-key), IC's, sockets, connector, electronic components and a double-sided printed wiring board. The keyboard assembly requires +5V @ 150mA and -12V @ 10 mA for operation. Features: 60 keys generate the 126 characters, upper and lower case ASCII set. Fully buffered. Two user-definable keys provided for custom applications. Case lock for upper-case-only alpha characters. Utilizes a 2376 (40-pin) encoder read-only memory chip. Outputs directly compatible with TTL/DTL or MOS logic arrays. Easy interfacing with a 16-pin dip or 16-pin edge connector. Size: 3 1/2" x 14 3/4" x 8 3/4" D.

- JE610/DTE-AK (as pictured above) . . . \$124.95
- JE610 Kit - 62-Key Keyboard, PC Board, & Components (no case) . . . \$ 79.95
- DTE-AK (case only - 3 1/2" H x 1 1/2" W x 8 3/4" D) . . . \$ 34.95
- DTE-AK (case only - 3 1/2" H x 1 1/2" W x 8 3/4" D) . . . \$ 49.95

JE212 - Negative 12VDC Adapter Board Kit
NEW! for JE10 ASCII KEYBOARD ADAPTER!
Provides -12VDC from incoming 5VDC . . . \$9.95

JE600 Hexadecimal Encoder Kit

- FULL 8-BIT LATCHED OUTPUT 19-KEY KEYBOARD

The JE600 Encoder Keyboard Kit provides two separate hexadecimal digits produced from sequential key entries to allow direct program entry to 8-bit microprocessor or 8-bit memory circuits. Three additional keys are provided for user operations with one having a bistable output available. The outputs are latched and monitored with 9 LED readouts. Also included is key entry strobe. Features: Full 8-bit latched output for microprocessor use. Three user-definable keys with one being bistable operation. Debounce circuit provided for all 19 keys. 9 LED readouts to verify entries. Easy interfacing with standard 16-pin IC connector. Only 5VDC required for operation. Size: 3 1/2" H x 8 3/4" W x 8 3/4" D

- JE600/DTE-HK (as pictured above) . . . \$99.95
- JE600 Kit - 19-Key Hexadecimal Keyboard, PC Board & Cmpnts. (no case) . . . \$59.95
- K19 19-Key Keyboard (Keyboard only) . . . \$14.95
- DTE-HK (case only - 3 1/2" H x 8 3/4" W x 8 3/4" D) . . . \$44.95

1 ONE

CompuPro



**NEW! CPU BOARDS
CO-PROCESSOR 8086/8087 (816)**
16 bit 8 or 10 MHz 8086 CPU with sockets
for 8087 and 80130

Part No.	Description	List Price	Our Price
868BT108A	A&T 8MHz 8086 only	\$695.00	\$ 625.00
868BT109C	CSC 10MHz 8086 only	\$950.00	\$765.00
868BT108A87	A&T with 8087 option	\$1295.00	\$1225.00
868BT108C87	CSC with 8087 option*	\$1550.00	\$1458.00

DUAL PROCESSOR 8085-8088

6 or 8 MHz Provides true 16 Bit Power with a standard 8 bit S-100 bus

868BT1012A	A&T 6MHz	\$425.00	\$399.00
868BT1012C	CSC 6/8 MHz	\$525.00	\$498.00

CPU-Z Z80 CPU

2/4 MHz Z80 CPU 24 Bit Addressing

868BT108A	A&T	\$295.00	\$260.00
868BT108C	CSC 3-8 MHz	\$395.00	\$375.00

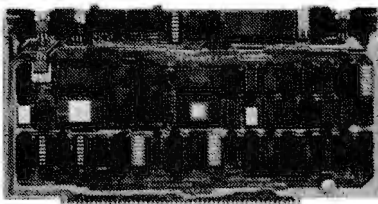

I/O BOARDS

SYSTEM SUPPORT 1 MULTIFUNCTION BOARD

Serial port (software prog. baud), 4K EPROM or RAM provision, 15 levels of interrupt, real time clock, optional math processor

Part No.	Description	List Price	Our Price
868BT102A	Assembled & Tested	\$399.00	\$360.00
868BT102C	CSC	\$495.00	\$460.00
868BT0231	Math Chip	\$195.00	\$195.00
868BT0232	Math Chip	\$195.00	\$195.00
868BT102AM1	A&T with 8231 Math Chip	\$585.00	\$585.00
868BT102CM1	CSC w/8231 Math Chip	\$655.00	\$655.00
868BT102AM2	A&T w/8232 Math Chip	\$655.00	\$655.00
868BT102CM2	CSC w/8232 Math Chip	\$655.00	\$655.00

MPX CHANNEL BOARD

I/O Multiplexer, using 8085A-2 CPU on board with 4K RAM

868BT106AA	Assembled & Tested	\$495.00	\$445.00
868BT106C4	CSC	\$595.00	\$535.00

With 16K RAM

868BT106A10	Assembled & Tested	\$649.00	\$585.00
868BT106C10	CSC	\$749.00	\$675.00

INTERFACER 1

Two Serial I/O

868BT133A	Assembled & Tested	\$249.00	\$218.00
868BT133C	CSC	\$324.00	\$298.00

INTERFACER 2

Three parallel, one serial I/O board

868BT158A	Assembled & Tested	\$249.00	\$218.00
868BT158C	CSC	\$324.00	\$298.00

INTERFACER 3

Eight channel multi-use serial I/O board

868BT1748A	Assembled & Tested	\$699.00	\$629.00
868BT1748C	CSC 200 hr. 8 Port	\$849.00	\$759.00
868BT1745A	Assembled & Tested	\$599.00	\$559.00
868BT1745C	CSC 200hr. 5 port	\$699.00	\$629.00

NEW!

INTERFACER 4

Three Serial, 1 Parallel, 1 Centronics Parallel

868BT187A	Assembled & Tested	\$350.00	\$315.00
868BT187C	CSC	\$450.00	\$415.00

SPECTRUM COLOR GRAPHICS

Color Graphics board with Parallel I/O

868BT144A	Assembled & Tested	\$399.00	\$349.00
868BT144C	CSC	\$449.00	\$399.00
868BT20	Sublogic Universal Graphics Interpreter Software		\$35.00

S-100 MOTHERBOARDS

Active termination, 6-12-20 Slot

868BT153A	A&T 6 slot, 2 lbs.	\$140.00	\$128.00
868BT153C	CSC 6 slot, 2 lbs.	\$190.00	\$175.00
868BT154A	A&T 12 slot, 3 lbs.	\$175.00	\$155.00
868BT154C	CSC 12 slot, 3 lbs.	\$240.00	\$220.00
868BT155A	A&T 20 slot, 4 lbs.	\$265.00	\$235.00
868BT155C	CSC 20 slot, 4 lbs.	\$340.00	\$319.00

ACTIVE TERMINATOR

Allows older S-100 motherboards to run faster and quieter

868BT106A	Assembled & Tested		\$59.50
-----------	--------------------	--	---------

CompuPro



**STATIC MEMORY BOARDS
RAM 20 - 32K STATIC RAM**

RAM 20 10 MHz, 4K byte block disable, bank select or 24 bit addressing available 8, 16, 24 or 32K

Part No.	Description	List Price	Our Price
868BT164AA8	8K A&T	\$210.00	\$190.00
868BT164AC8	8K CSC	\$280.00	\$260.00
868BT164AA16	16K A&T	\$285.00	\$260.00
868BT164AC16	16K CSC	\$355.00	\$325.00
868BT164AA24	24K A&T	\$355.00	\$325.00
868BT164AC24	24K CSC	\$425.00	\$395.00
868BT164AA32	32K A&T	\$425.00	\$395.00
868BT164AC32	32K CSC	\$495.00	\$460.00

CMOS STATIC RAM

For a complete analysis of the advantages of CMOS memory, see the "Product Description" on page 416 of the January issue of BYTE

RAM 17 - 64K CMOS STATIC RAM

RAM 17, 10 MHz, 2 Watt, DMA Compatible 24 Bit Addressing

868BT175AA4	64K A&T	\$599.00	\$569.00
868BT175C4	64K CSC	\$750.00	\$699.00

RAM 16 - 32K x 16 BIT CMOS STATIC RAM

8 and/or 16 Bit

RAM 16 10 MHz, 32K x 16 or 64K x 8

IEEE/896 16 Bit 2 Watt, 24 Bit Addressing

868BT190A	64K A&T	\$650.00	\$609.00
868BT190C	64K CSC	\$750.00	\$699.00

NEW! RAM 21 - 128K STATIC RAM

RAM 21 12MHz, 128K x 8 or 64K x 16

IEEE/896 8 or 16 Bit 1.2 Amps, 24 Bit Addressing

868BT190A	128K A&T	\$1895.00	\$1818.00
868BT190C	128K CSC	\$1895.00	\$1795.00

M-DRIVE SOLID STATE DISK DRIVE, (816)

3500% FASTER!

Not Really, But the Next Best Thing for CompuPro 8085/88 Users. Call for Detail on M-Drive.

M-Drive requires a 6MHz CPU 8085/88 dual processor, Disk 1 DMA disk controller and System Support 1 Multifunction Board

868BTM0128K	128K of A&T memory & M-Drive Software	\$1195.00	
868BTM0128KC	128K of CSC memory & M-Drive Software	\$1395.00	
868BTM0256K	256K of A&T memory & M-Drive Software	\$2395.00	
868BTM0256KC	256K of CSC memory & M-Drive Software	\$2795.00	

DISK CONTROLLERS



DISK 1 FLOPPY CONTROLLER

Fast DMA, Soft Sector, Controls 8" or 5 1/4" Single or Double Density. OUR BEST!

868BT0171ACPM	A&T w/CP/M 2.2 & BIOS	\$870.00	\$450.00
868BT171C	CSC	\$595.00	\$565.00

CP/M 2.2 for Z80/8086 with manuals & BIOS 8" S/D disk

CP/M for 8086 with manuals & BIOS 8" S/D disk

Oasis 8 bit single user 8" S/D disk

Oasis 8 bit multiuser, 8" S/D disk

NEW! DISK 2/SELECTOR CHANNEL HARD DISK CONTROLLER

Fast DMA 2 board set. Controls 4 Shugart 4000 series or Fujitsu 2300 type drives

868BT177A	Assembled & Tested	\$795.00	\$750.00
868BT177C	CSC	\$895.00	\$850.00



S-100 MAINFRAME

110V 60Hz CVT Mainframe uses famous 20 slot COMPUPRO Motherboard. 55 lbs.

868BTENC20RM	20 Slot Rack Mount	\$895.00	\$825.00
868BTENC20DK	20 Slot Desk Top	\$825.00	\$769.00

Turn page for complete CompuPro Systems

MORROW DESIGNS



FLOPPY DISK CONTROLLERS & SUBSYSTEMS

DISK JOCKEY 2B FLOPPY CONTROLLER

Memory mapped controller handles 4 8" drives, single or double density

Part No.	Description	List Price	Our Price
86MDS0J2200	A&T w/CP/M™ 2.2	\$399.00	\$378.00

DISCUS 2D & DISCUS 2+2 SUBSYSTEMS

Each subsystem includes DJ/2B controller 8" double density drives with cabinet, power supply, CP/M™ 2.2 and Microsoft Basic

SINGLE SIDED - DISCUS 2D

86MDS0F1216	1 Drive 30 lbs.	\$1095.00	\$ 950.00
86MDS0F1226	2 Drive 48 lbs.	\$1875.00	\$1675.00

DOUBLE SIDED - DISCUS 2+2

86MDS0F012	1 Drive 30 lbs.	\$1395.00	\$1250.00
86MDS0F022	2 Drive 48 lbs.	\$2495.00	\$2300.00

DISK JOCKEY/DMA FLOPPY CONTROLLER

DMA Controller supports 4 soft-sectored 8" drives and 4 10 sector 5 1/4" drives simultaneously. On board Z80A

86MDS0J0MA	A&T w/CP/M™ 2.2	\$495.00	\$460.00
------------	-----------------	----------	----------

DISK JOCKEY DMA SUBSYSTEMS

Each subsystem includes DJ/DMA controller, 8" double-density drives or 5 1/4" 48 TPI drives, cabinet, power supply, CP/M™ 2.2 and Microsoft BASIC

SINGLE SIDED DISCUS 2D/DMA

86MDS0F011	1 Drive 30 lbs.	\$1195.00	\$1050.00
86MDS0F021	2 Drive 48 lbs.	\$1975.00	\$1775.00

DOUBLE SIDED DISCUS 2+2/DMA

86MDS0F012	1 Drive 30 lbs.	\$1495.00	\$1325.00
86MDS0F022	2 Drive 48 lbs.	\$2575.00	\$2395.00

DOUBLE SIDED - DISCUS MINI-FLOPPY/DMA

86MDS0F5124	1 Drive 17 lbs.	\$ 995.00	\$895.00
86MDS0F5224	2 Drive 32 lbs.	\$1695.00	\$1525.00

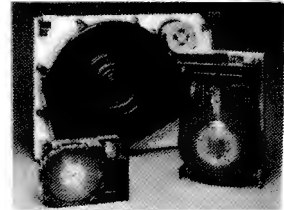

NEW! S-100 5-26 MB HARD DISK SUBSYSTEMS

5 - 10 Mb DMA SUBSYSTEMS

Each subsystem includes DMA Hard Disk Controller, Seagate ST506 5 Mb or ST412 10 Mb 5 1/4" Hard Disk, Cabinet, power supply, CP/M™ 2.2 and Microsoft BASIC.

Software supplied on 8" IBM 3740 disk with blank I/O and INSTALL program

Software configured for Morrow DJ/2B controller and Mult I/O as console

Software configured for Morrow DJ/DMA controller and Mult I/O as console

Software supplied on 5 1/4" 10 sector North Star disk with blank I/O and INSTALL Program

Replace * in above part numbers with 5 for 5Mb Subsystems or 10 for 10Mb Subsystems.

DISCUSM5 - 5Mb Subsystems \$2195.00 \$1875.00

DISCUSM10 - 10Mb Subsystems \$3195.00 \$2675.00

(order by part numbers listed above)

DISCUS HDC 20-26 Mb SUBSYSTEMS

Each subsystem includes HDCA3 I/O mapped controller, Shugart SA4008 14" 26Mb or Fujitsu 2308 8" 20Mb Hard Disk, cabinet, power supply, CP/M™ 2.2 & Microsoft BASIC.

86MDS0H0C20 Discus M20 A&T \$4795.00 \$3995.00

86MDS0H0C20 Discus M26 A&T \$4495.00 \$3895.00

I/O BOARDS

MULTI I/O

Three Serial, Two Parallel

86MDS0M03200	Assembled & Tested	\$359.00	\$329.00
--------------	--------------------	----------	----------

SWITCHBOARD

Two serial I/O, four parallel I/O, one status port, one strobe port

86MDS0S02411		\$299.00	\$269.00
--------------	--	----------	----------

Call for complete DECISION 1 Systems

PRIORITY ONE ELECTRONICS

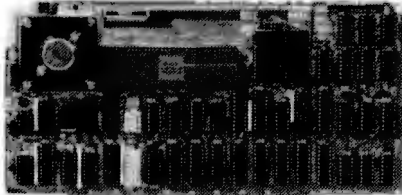

CPU BOARDS

CPU/68000 - 8MHz 68000 CPU

16 bit 68000 CPU with on board ROM containing MACSBUG Monitor or Motorola 68541 Memory Management Unit (MMU).

Part No.	Description	List Price	Our Price
BGDULCP68000	A&T with Monitor	\$1195.00	\$1075.00
BGDULCP68000M	A&T with MMU	\$1495.00	\$1305.00

MEMORY BOARDS

DMEM256KP-256K DYNAMIC MEMORY MODULE

256Kb with byte parity error detection for 8 or 16 bit computers

BGDULMEM256	256K A&T	\$1495.00	\$1305.00
-------------	----------	-----------	-----------

CMEM NONVOLATILE CMOS MEMORY

Nonvolatile CMOS memory with 3-10 year battery backup on board.

BGDULCMEM8	8K A&T	\$695.00	\$620.00
BGDULCMEM16	16K A&T	\$795.00	\$725.00
BGDULCMEM32	32K A&T	\$995.00	\$840.00

2716/2732 EPROM BOARD WITH 16 BIT DATA PATHS

Designed to hold 32Kb of 2716 type or 64Kb of 2732 type EPROMs, or ROMs for read only use with 16 bit CPU systems.

BGDULEPROM32	2716 EPROM Board A&T	\$295.00	\$260.00
BGDULEPROM64	2732 EPROM Board A&T	\$295.00	\$260.00

REAL TIME & DATA ACQUISITION

SI04/DMA INTELLIGENT CONTROLLER

4 port RS232 interface with DMA transfers for output. 256b FIFO input buffer; On board 8085A-2 processor; 16 program selectable baud rates and occupies only 16 I/O addresses. Ideal for DUAL UNIX* or other multi-user systems.

NEW!

BGDULSI04DMA	Assembled & Tested	\$695.00	\$650.00
--------------	--------------------	----------	----------

AIM 12-12 BIT A/D CONVERTER

A/D input module with 12 bit accuracy, 32 input channels and optional instrumentation amplifier

BGDULAIM12	A&T with Instrumentation Amp.	\$745.00	
BGDULAIM12B	A&T without Instrumentation Amp.	\$680.00	

AOM 12-12 BIT D/A CONVERTER

D/A output module, 4 channels, 12 bit accuracy. Optional VIC420 industrial output module (4-20Ma), 4 channels, used in conjunction with AOM12.

BGDULAOM12	Assembled & Tested	\$675.00	\$640.00
BGDULVIC420	Assembled & Tested	\$675.00	\$640.00

CLK24-NONVOLATILE CLOCK/CALENDAR

Day, date, hours, minutes, seconds, and 3-5 year battery backup on board. Read or write directly from I/O port. Jumperable for 64Hz UNIX* or real time applications.

BGDULCLK24C	A&T w/64Hz Interrupt	\$300.00	\$265.00
-------------	----------------------	----------	----------

SOFTWARE

DIGITAL RESEARCH

BGDURCPM	CP/M* 2.2 Control Program/ Microcomputers	\$150.00	
BGDURMAC	MAC* Macro Assembler	\$ 90.00	
BGDURRMAC	RMAC* Relocating MAC	\$200.00	
BGDURSID	SID* Symbolic Instruction Debugger	\$100.00	
BGDURTEX	TEX* Text Formatter	\$100.00	
BGDURDES	DESPOOL* Background Print Utility	\$ 50.00	
BGDURCBAS	CBASIC* Programming Language	\$150.00	
BGDURCB88	CBASIC-88* Programming Language	\$325.00	

*Trademark of Digital Research

MICROPRO INTERNATIONAL

BGDMSWOSTR	Wordstar* Version 3.0	\$360.00	
BGDMSMIMG	Mail Merge*	\$100.00	
BGDMSPEPR	Spell Star*	\$150.00	
BGDMSCALSTR	Calc Star*	\$200.00	
BGDMSGATSTR	Data Star*	\$200.00	
BGDMSUPPET	Supersort*	\$150.00	

*Trademark of Micropro International

SORCIM

BGSURSCAL	SUPERCAL* a Superior Electronic Worksheet	\$205.00	
BGSURACTI	ACT I* 8080/Z80 Assembler	\$175.00	
BGSURACTII	ACT II* 8086/8088 Assembler	\$175.00	
BGSURTRS	TRANS* 8086/8088 Translator	\$175.00	
BGSURPASC	PASCAL/M* REL4 8080/8085/Z-80	\$305.00	
BGSURPASC	PASCAL/M* 8086	\$405.00	

*Trademark of Sorcim

MICROSOFT

BGMSBAS30	BASIC-80* Version 5.X Extended Disk Basic	\$300.00	
BGMCPCBASC	BASIC* Compiler Version 5.X	\$205.00	
BGMSMFT	FORTRAN-80*	\$600.00	

*Trademark of Microsoft Consumer Products

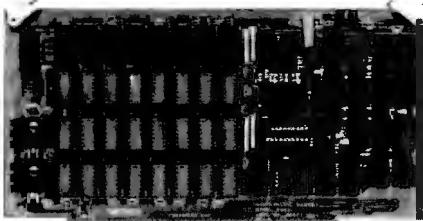

CPU BOARDS

2810 Z80 SBC CPU

2/4 MHz Z80A CPU with RS232C Serial I/O Port complete with Monitor PROM for 2422 Disk Controller

Part No.	Description	List Price	Our Price
BGCC2810A	Assembled & Tested	\$300.00	

2820 Z80 DMA CPU

4MHz Z80 with 2 RS232C Serial Ports, Centronics Parallel Port, separate data and status ports and DMA Daisy Chain Capability

BGCC2820B	Assembled & Tested	\$505.00	
-----------	--------------------	----------	--

I/O BOARDS

2830 - 6 PORT SERIAL

Six Asynchronous RS232C Ports using three Z-80 DARTS. Programmable baud rates.

BGCC2830B	Assembled & Tested	\$550.00	
-----------	--------------------	----------	--

2710 4 PORT SERIAL

4 Full handshaking RS232 ports and optional 2K ROM

BGCC2710B	Assembled & Tested	\$325.00	
-----------	--------------------	----------	--

2719 2 SERIAL & 2 PARALLEL

2 RS232C ports, 2 8 bit parallel ports & optional 2K ROM

BGCC2710B	Assembled & Tested	\$300.00	
-----------	--------------------	----------	--

2720 4 PORT PARALLEL

4 8 bit parallel ports and optional 2K ROM

BGCC2720B	Assembled & Tested	\$275.00	
-----------	--------------------	----------	--

2422 FLOPPY DISK CONTROLLER

I/O Mapped, controls 8", single or 5 1/4" double density A&T with CP/M* 2.2 8" S.D.

BGCC2422A	Assembled & Tested	\$425.00	
-----------	--------------------	----------	--



MEMORY BOARDS

2065 64K DYNAMIC MEMORY BOARD

64K 4MHz, Z80 or 8080 compatible, bank select for memory expansion to 512K, DMA compatible.

BGCC2065B	Assembled & Tested	\$375.00	\$350.00
-----------	--------------------	----------	----------

2066 BANK SWITCH DYNAMIC MEMORY

64K Memory with bank and block select switching functions for Cromemco Cromix* & Alpha Microsystems

BGCC2066C	Assembled & Tested	\$450.00	\$425.00
-----------	--------------------	----------	----------

2116 16K STATIC RAM

16K 4MHz using 2114 RAMs. Maybe divided into 4K blocks Cromemco & Alpha Microsystems compatible

BGCC2116B	Assembled & Tested	\$200.00	
-----------	--------------------	----------	--

2032 32K STATIC RAM

32K 4MHz using 2114s. Divided into 4 8K blocks. Bank-port/bank-byte scheme compatible with Cromemco and Alpha Microsystems.

BGCC2032B	Assembled & Tested	\$500.00	
-----------	--------------------	----------	--

S-100 MAINFRAME

12-slot motherboard with removable termination card

BGCC32200B	Office Cream	35 lbs.	\$875.00
BGCC32200B	Blue	35 lbs.	\$875.00

SEND \$1.00 TODAY FOR THE NEW, FULL COLOR SPRING 1982 ENGINEERING SELECTION GUIDE!



PRIORITY ONE ELECTRONICS

9161 DEERING AVE • CHATSWORTH, CA 91311



ORDER TOLL FREE (800) 423-5922 CA, AK, HI CALL (213) 709-5464

Terms: U.S. VISA, MC, BAC, Check, Money Order, U.S. Funds Only. CA residents add 6% Sales Tax. MINIMUM PREPAID ORDER \$15.00. Include MINIMUM SHIPPING & HANDLING OF \$3.00 for the first 3 lbs. plus 25¢ for each additional pound. Orders over 50 lbs. sent freight collect. Just in case, please include your phone number. Prices subject to change without notice. We will do our best to maintain prices through July, 1982. Credit Card orders will be charged appropriate freight. If you haven't received your Spring '82 Engineering Selection Guide by May 10th, send \$1.00 for your copy. Sale prices are for prepaid orders only.



SUPERQUAD - ADVANCED MICRO DIGITAL AT LAST, A FULL S-100 SYSTEM ON A SINGLE BOARD!

• IEEE S-100 Bus Compatible • Z80A CPU @ 4MHz • Floppy Disk Controller, Single & Double Density (Supports up to 4 disk drives 5 1/4" or 8") • 64Kb Memory, 16K Bank Selectable • S-100 Extended Address A16-23 • 2 Serial and 2 Parallel I/O Ports • 2K or 4K of Shadow EPROM • Real Time Interrupt Clock • One Year Warranty • Runs with CP/M, MP/M, CP/NET • All of These Features on a Single Standard Size S-100 Board

Part No.	Description	List Price	Our Price
BGAMSSBC1	A&T w/Asynch RS232 ports	\$875.00	\$785.00
BGAMSPB1	1 Asynch adapter board required for each serial port used		\$ 30.00

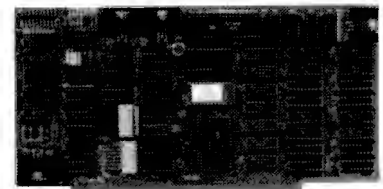

VIDEO AND I/O

VB 3 - HIGH RESOLUTION VIDEO

80 x 25 or 50 character video display Memory Mapped, Parallel Keyboard port

BGSSMV3A24	80 x 24 A&T	\$499.00	\$440.00
BGSSMV3UP	80 x 50 Line Upgrade		\$ 30.00

VB 2 - I/O MAPPED 64 x 16 DISPLAY

I/O Mapped Video Board, with Parallel Keyboard port 64 x 16

BGSSMVB2A	Assembled & Tested	\$269.00	\$220.00
-----------	--------------------	----------	----------

VB 1B MEMORY MAPPED 64 x 16 DISPLAY

Memory Mapped Video Board 64 x 16 character display or 64 x 16 graphics display

BGSSMVB1A	Assembled & Tested	\$242.00	\$220.00
-----------	--------------------	----------	----------

I/O 4

Two serial I/O, two parallel I/O

BGSSMI04A	Assembled & Tested	\$290.00	\$200.00
-----------	--------------------	----------	----------

NEW!

I/O 5

2 Serial, 3 parallel including 1 Centronics

BGSSMI05I	Assembled & Tested	\$329.00	\$309.00
-----------	--------------------	----------	----------

NEW!

I/O 8

8 Port Serial I/O with Timer

BGSSMI08A	Assembled & Tested	\$550.00	\$405.00
-----------	--------------------	----------	----------

CPU, RAM & PROM

CB2 Z80 CPU

2/4 MHz will accept 2716, or 2732, or RAM

BGSSMCB2A	Assembled & Tested	\$299.00	\$275.00
BGSSMZ80M	SSM Z80 Monitor		\$ 80.00

MB10A 16/8K 8/16 BIT STATIC RAM

16K byte /8K word, 24 bit extended, addressing, "M write," Phantom disable, addressable in 4K blocks

BGSSMB10A	Assembled & Tested	\$299.00	\$275.00
-----------	--------------------	----------	----------

MB8A 1K/16K EPROM BOARD

1K/16K 2708 EPROM board, disable in 1K increments

BGSSMB8AA	Assembled & Tested	\$179.00	\$160.00
-----------	--------------------	----------	----------

PBI PROM PROGRAMMER

Programs 2708 or 2716's, operates as a 4K/8K EPROM BOARD AS WELL

BGSSMPB1A	Assembled & Tested	\$265.00	\$220.00
-----------	--------------------	----------	----------

1
ONE



PERFORMANCE, QUALITY, RELIABILITY, HIGH PERFORMANCE SYSTEMS DESIGNED TO EXPAND WITH YOUR NEEDS

All CompuPro systems have been designed with your future in mind. Each system is expandable so you can upgrade your system as your needs continue to grow. Single user systems may be upgraded into multi-user systems for under \$3,000.00. Additional users may be added to multi-user systems at any time. Hard disk storage is also available with the new DISK 2 DMA Winchester disk controller. Unlike many "personal" computers, your CompuPro system will not become obsolete when it is time to expand. The modular design of the IEEE 696/S-100 bus allows you to plug in additional boards when they are needed. CompuPro system components feature the latest state-of-the-art technology to prevent obsolescence.

Each CompuPro system component is fully assembled and tested under rigorous burn-in conditions at the factory and then shipped to Priority One Electronics, your authorized CompuPro Systems Center, for final integration and configuration. CompuPro systems carry the best warranty in the business, 1 year on A & T systems, 2 years on CSC systems. The Qume drives have a full six month warranty, the best drive warranty anywhere. The components are integrated into a complete system by a factory trained Priority One Electronics technician. The systems are then partially disassembled for shipping. After a short time for unpacking and check-out, your CompuPro system will be ready to load and go!

SYSTEM COMPONENTS

- Each CompuPro system includes the following:
- CPU 8085/86 6MHz Dual Processor CPU (8088 runs at 8MHz in CSC systems)
 - Disk 1 Lightning Fast DMA Floppy Disk Controller
 - CP/M® 2.2 and CP/M 86™ Operating Systems
 - Sorcim's SUPERCALC-86 Electronic Spreadsheet program
 - Two double-sided, double-density Qume DT-8 disk drives in an attractive desk top enclosure
 - Rugged Desk Enclosure 2 with 20 slot actively terminated motherboard, fan, air and line filters, and constant voltage power supply for years of reliable operation
 - Internal I/O cables and floppy disk data cable
 - Complete documentation for each system component as well as a system integration guide

ENTRY LEVEL SINGLE-USER SYSTEM — The system is designed for high performance at a minimal cost. It may be upgraded at any time by additional memory. Each system includes the common components listed above and the following:

- 128K 10MHz Low Power Static Ram for low power consumption and reliability
- Interfacer 4 I/O board with three RS232 Serial ports, one bi-directional parallel port, and one Centronics parallel port

8085/86 Single User System Desk Top, A&T \$5495.00
8085/86 Single User System Desk Top, CSC \$5895.00

M-DRIVE OPTION — M-Drive provides up to a 3500% increase in speed during intensive computing. M-Drive uses the 16 bit 8088 CPU on the Dual Processor board to run extended address IEEE 696/S-100 RAM under CP/M® 2.2, so that the memory appears identical to a disk drive. The RAM can be formatted, it has a directory, and it can hold files which may be written, read, copied to or from another disk, or executed. A floppy disk drive is still required for system initialization, and for saving finished files. Additional CompuPro memory may be added at any time without having to change or recompile your programs. M-Drive requires a 6 MHz CPU 8085/86 dual processor, Disk 1 DMA disk controller and System Support 1 Multifunction Board.

8085/86 128K 128K of A&T memory & M-Drive Software \$1198.00
8085/86 128K 128K of CSC memory & M-Drive Software \$1398.00
8085/86 256K 256K of A&T memory & M-Drive Software \$2395.00
8085/86 256K 256K of CSC memory & M-Drive Software \$2795.00

SINGLE USER M-DRIVE SYSTEM — This system may be operated with CP/M® 2.2 in 8 bit mode as a 128K M-Drive system or in 16 bit mode with CP/M 86™ to give the user maximum flexibility. This system includes the common components listed above and:

- 192K 10MHz Low Power Static RAM for low power consumption and reliability
- System Support 1 Multifunction Board
- Interfacer 3 Eight port RS232 Serial Interface Board
- M-Drive Software for use in 8 bit mode

8085/86 M-Drive System Desk Top, A&T \$6995.00
8085/86 M-Drive System Desk Top, CSC \$7748.00

ENTRY LEVEL MULTI-USER SYSTEM — This system is designed for two or three users depending upon user memory allocation size. This system includes everything in the above Single-User M-Drive system plus:

- 6MHz 8088 standard on Dual Processor CPU board
- 64K of additional memory for a total of 256Kb of low power 10MHz static memory
- MPX1-16 Multiplexer to increase system throughput
- MP/M (®) Multi-user software. MP/M 816 is a CompuPro proprietary implementation of Digital Research's MP/M 86™ 16 bit multi-user operating system. This software package includes CP/M® V2.2, CP/M86™, and MP/M 86™. The beauty of this software is that both 8 bit CP/M® 2.2 and 16 bit CP/M 86™ programs may be run on the system at the same time by different users. This allows the user to take advantage of the vast library of 8 bit software as well as the growing selection of 16 bit software without being limited to one or the other. When running CP/M® 2.2 programs under MP/M (®), there is 60K of user memory rather than the usual 48K for better system performance; another CompuPro exclusive! This unique software package, ideal for software development or scientific applications, is available only as part of a CompuPro system.

8085/86 Multi-User System Desk Top, A&T \$8995.00
8085/86 Multi-User System Desk Top, CSC \$9845.00

Rack mount systems are also available; please call or write for details. All CompuPro systems are shipped via motor or air freight collect; please specify at time of order. All boards are shipped in standard configurations. CP/M, CP/M 86, and MP/M 86 are trademarks of Digital Research. MP/M (®), a proprietary implementation of MP/M 86, is a trademark of CompuPro under license from Digital Research. (®) is a trademark of CompuPro.

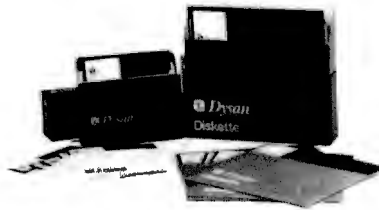

WHY SETTLE FOR LESS?

DYSAN DISKETTES have long been regarded as the standard that all others attempt to duplicate. Today, Dysan still manufactures the ultimate in flexible recording media for 5 1/4" and 8" flexible disk drives. Both the 5 1/4" and 8" diskettes are certified to be 100% error free over the entire recording surface providing you with the best insurance from data error.

5 1/4" DISKETTES 35/40 TRACK CERTIFIED

Part No.	Sectors	Density	Sides/ Heads	PRICE Box of 10
86DSN1041	Soft	Single	1/1	\$45.00
86DSN1041D	Soft	Double	1/1	\$50.00
86DSN1051D	16 Hard	Double	1/1	\$50.00
86DSN1071D	10 Hard	Double	1/1	\$50.00
86DSN1042D	Soft	Double	2/2	\$60.00

77/80 TRACK

86DSN2082D	16 Hard	Double	2/2	\$68.00
------------	---------	--------	-----	---------

8" DISKETTES

86DSN37401	Soft	Single	1/1	\$68.00
86DSN37401D	Soft	Double	1/1	\$85.00
86DSN37402D	Soft	Double	2/2	\$88.00



FCC CLASS 2 APPROVED DATA DISPLAY MONITORS

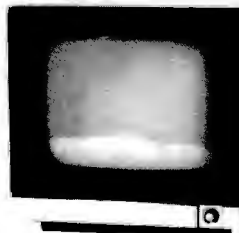

Part No.	Description	List Price	SALE
86STVM4506	9" B&W P4, 10MHz (15 lbs)	\$215.00	\$169.00
86STVM4506CX	9" Green, P31, 10MHz (15 lbs)	\$200.00	\$169.00
86STVM0012C	12" B&W P4, 18MHz (24 lbs)	\$250.00	\$228.00
86STVM0012CC	12" Green, P31, 18MHz (24 lbs)	\$260.00	\$238.00
86STVM0013	13" Color, 16 x 64 (35 lbs)	\$470.00	\$425.00
86STVM0013*	13" RGB Color (35 lbs)	\$995.00	\$895.00

*As used with IBM P.C.



A800 DOUBLE DENSITY 8" DISK CONTROLLER

- High Speed DMA Transfer of Data (1 Microsecond/Byte)
- Uses All Standard Apple DOS Commands (OPEN CATALOG, LOCK, DELETE, LOAD, etc) Except for INIT Which Has Been Improved and Enhanced in a Vista Format Routine
- Compatible with Apple DOS 3.2/3.3, Pascal 1.1 and CP/M 2.2 (With the Z80 Soft Card by Microsoft)
- Interfaces to All Shugart/ANSI Standard Eight-Inch Floppy Disk Drives
- 2Kx8 PROM Contains Autoboot Functions and All 8" Floppy Drive Code Allowing Complete Memory Usage Map Compatibility w/Apple DOS 3.2/3.3

86VIS4800	Controller and disk	\$595.00	\$499.00
86VIS0180	Vision 80 80 x 24 Display Card	\$395.00	\$348.00
86VIS0104	Vision 40 - 40 Column, upper/lower case enhancement	\$195.00	\$175.00

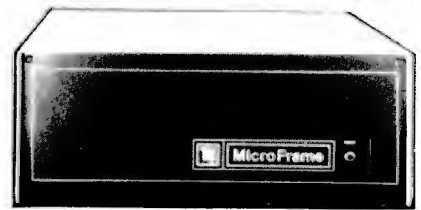

110V 60Hz CVT Mainframes, the best money can buy!
 12 Slot ±8V 17±16V @ 2A
 22 Slot ±8V @ 30A± 16V @ 4A

PART NO.	DESCRIPTION	LIST PRICE		DGR PRICE	
		1-4	10-24	1-4	10-24
86TEIMCS112	12 Slot Desk	\$755.00	\$666.00	\$627.00	\$527.00
86TEIMCS122	22 Slot Desk	\$910.00	\$798.00	\$778.00	\$678.00
86TEIRW12	12 Slot Rackmount	\$800.00	\$718.00	\$681.00	\$581.00
86TEIRW22	22 Slot Rackmount	\$965.00	\$888.00	\$828.00	\$728.00

Shipping Weight: On 12 Slot Mainframes: 45 lbs.
 On 22 Slot Mainframes: 55 lbs.

3-100 MAINFRAME WITH 12 SLOT MOTHERBOARD AND CUTOFFS FOR 3 - 5 1/4" FLOPPY DISK DRIVES

+8V @ 17A±16V @ 2A+12V @ 1.2A Internal Power Cable

86TEITF12	12 Slot desk	\$745.00	\$678.00	\$638.00
86TEIRF12	12 Slot Rackmount	\$855.00	\$788.00	\$732.00

Shipping Weight: On 12 Slot Desk: 40 lbs.
 On 12 Slot Rackmount: 45 lbs.

DUAL 8" DISK DRIVE CHASSIS

For two Shugart 801R or two Qume DT-8 size drives with internal power cables provided
 +24V @ 1.5A +5V @ 1.0A -5V @ .25A

86TEIRFD0	Desk Top	\$565.00	\$528.00	\$498.00
86TEIRFD0	Rackmount	\$725.00	\$688.00	\$638.00

Shipping Weight: On Desk Top: 40 lbs.
 On Rackmount: 45 lbs.

PRIORITY ONE ELECTRONICS is a master distributor for TEI Dealers & DEM's call for quantity pricing.

PRENTICE



THE STAR OUR MOST POPULAR MODEM

We've Sold Thousands!

- 0 to 300 baud • Bell 103 and 113 • Exclusive triple seal acoustic chamber • Self Test • ±0.3% frequency stability, crystal controlled • Receiver Sensitivity of -50dB or -53dB off • FSK Modulation • RS232 Compatible • Switches: Originate/Off/Answer, Full Duplex/Test/Half Duplex • Indicators: Transmit Data, Receive Data, Carrier Ready, Test

Part No.	Description	List Price	SALE
86PRSTAB	RS232, TTL, 20Ma Current Loop	\$199.00	\$129.00



SMARTMODEM

- Auto Answer, Auto Dial, Full or Half-Duplex, Loop Back • Serial binary, and asynchronous data formats with 7 or 8 data bits, 1 or 2 stop bits, odd, even or no parity • 0-300 baud • RS232C interface • Z8 Microprocessor with 2Kb control program • 40 character command buffer • Size: 1.5" x 5.5" x 9.6"

86DCH0200P	Smartmodem (Sh. Wt. 6 lbs.)	\$279.00	\$249.00
86DCH0300P	Chronograph (Sh. Wt. 3 lbs.)	\$249.00	\$219.00
86DCH0100P	Microcom 100 (Sh. Wt. 4 lbs.)	\$399.00	\$369.00
86DCH2901D	CP/M® 8" Terminal Program for above		\$ 25.00
86DCH0900P	Microcomem II	\$379.00	\$329.00
86DCH2401D	Datacom (PASCAL patch) for above		\$ 50.00

FUJITSU & NEC LETTER QUALITY PRINTERS FROM SELSUM

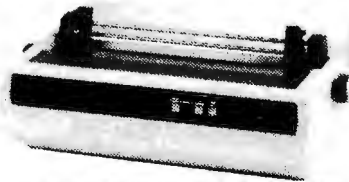

Speed and Unmatched Performance

Interfaces: • RS232C and Current Loop • Centronics type parallel interface • IEEE488 All are DIP switch selectable.
Personality Protocols: • NEC5510 • DIABLO 630 • QUME Sprint 9 • IBM Personal Computer • ATARI (Centronics 737).
Special Features: • Z80 CPU • 12K ROM • Standard 16K Buffer • Optional 48K Buffer • 50 - 19.2K baud • Micro-coded alarm differentiates error conditions with pulse combinations • Intelligent bi-directional printing with logic seeking • Complete word processing features • Self test • Auto reprint • Auto clear error • Proportional spacing • Supports Automatic justification • Complete Vector plotting routines • Sheet feeder mode allows easy interface to most mechanical sheet feeders • 6 month warranty • Quiet - 60db • Front panel forms control • Universal power supply 115/220V 50/60 Hz.

BEST BUY! 80 Characters per Second!
LETTER QUALITY!
USING THE FUJITSU SP830 **WOW!**

Part No.	Description	List Price	Our Price
BGSLM706	Intelligent Printer	\$3495.00	\$2995.00
OPTIONS			
BGSLM706VT	Vertical forms tractor		\$200.00
BGSLM70648K*	48K RAM buffer		\$400.00
Call for pricing on sheet feed options			
BGSLM771	Intelligent Printer	\$3295.00	\$2895.00
OPTIONS			
BGSLM771VT	Vertical Forms Tractor		\$ 230.00
BGSLM7710FT	Bidirectional Forms Tractor		\$ 400.00
BGSLM771CSF	NEC Cut Sheet Feeder		\$1500.00
BGSLM771CSF2	Twin Cut Sheet Feeder		\$2150.00
BGSLM7748K*	48K RAM Buffer		\$ 400.00

*Must be ordered with the printer

INTERFACE CABLES

BGCPAM572	Centronics IBM/NEC Cable	\$30.00
BGSC0251	RS232C Serial Cable	\$60.00

Call for other cables not listed

Para Dynamics



18 SLOT S-100 MAINFRAME

CVT Power Supply, forced air cooling; security lock 120 or 220V AC at 50 or 60Hz+8V@20A, ±16@3.5

BGPN2010D	Desk Top	\$799.00	\$699.00
BGPN2010R	Rack Mount	\$849.00	\$749.00

8 SLOT S-100 MAINFRAME WITH CUTOUPS FOR 2 5 1/4" DISK DRIVES

+5@5A, -5@500MA, +8@15A, +12@8A, +16@2, -16@2			
BGPN2500D	Desk Top	\$899.00	\$799.00
BGPN2500R	Rack Mount	\$949.00	\$849.00

DISK DRIVE FACILITY

Accommodates two 8" floppy drives, of Shugart, Qume, or similar design and dimensions. 110 or 220V AC at 50 or 60Hz CVT power.

BGPN2200D	Desk Top	\$659.00	\$579.00
BGPN2200R	Rack Mount	\$679.00	\$599.00



Free standing cabinet. Will accept 2, 8" Floppy disks and 1, 8" Rigid disk. 18 slot card cage will accept the double height 10" x 10" S-100 cards (Alpha Micro and others) CVT Power Supply.

+24@7A, +16@2.2A, -16@3.5A, +8@20A, +5@5A

BGPN2010	PRONTO	\$1295.00	\$1129.00
----------	--------	-----------	-----------

PRONTO COMPLETE WITH POWER SUPPLY POWER-UP SEQUENCER

BGPN2010S	with sequencer	\$1395.00	\$1249.00
-----------	----------------	-----------	-----------

Shipped motor freight collect



COMPARE OKIDATA'S FEATURES TO ANY OTHER PRINTER!
COMPARE PRIORITY ONE'S PRICES TO ANY - THEN DECIDE!
Don't be fooled by those who try to "soak" you for the options

- BI-DIRECTIONAL-120 CPS • Both Parallel and 1200
- 9 x 9 Matrix (Alphanumeric) baud Serial I/O (82A & 83A)
- 6x9or12 Matrix for graphics • Self Test
- 5,8,3, 10, 16 Characters • Out of Paper Switch
- Per Inch • Friction or Optional Tractor
- 80 CPL @ 10 CPI for 82A • Feed (Tractor Standard on 84)
- 132 CPL @ 100CPI for • 10 different character sets 83A & 84

All three printers feature front panel switch selectable for lengths; 10 lengths from 3" to 14". Front or bottom gear loading for up to 4 part forms and tear bar. All of these features make OKIDATA the best value in low cost printers!

Part No.	Description	List Price	SALE
BOKKIDAT2AT	80 column printer w/friction (25 lbs.)	\$539.00	
BOKKIDAT2E	Tractor Feed for OKIDAT 82A	\$ 99.95	
BOKKIDAT2H	High Resolution graphics ROM 60 x 66	\$ 75.00	
BOPKIDAT2G	OKIDAT82A w/tractor and graphics	\$599.00	
BOKKIDAT83A	132 column printer w/friction (35 lbs.)	\$750.00	
BOKKIDAT8T	Tractor Feed for OKIDAT83A	\$ 69.95	
BOKKIDAT8H	High Resolution graphics ROM 60x66	\$ 75.00	
BOPKIDAT8G	OKIDAT83A w/tractor & graphics	\$850.00	
BOKKIDAT8E	9600 Baud 2K serial buffer/interface	\$149.00	
BOKKIDAT84AP	132 col. printer parallel interface	\$1095.00	
	with graphics and tractor (35 lbs.)		
BOKKIDAT84AS	132 col. printer 9600 baud serial 2K	\$1250.00	
	interface, graphics and tractor (35 lbs.)		
BOMBSAPLWTC*	Apple Parallel Interface w/Cable	\$ 75.00	

*Sold only with printer

COMPARE PRICES!!

ADDS

Applied Digital Data Systems Inc.

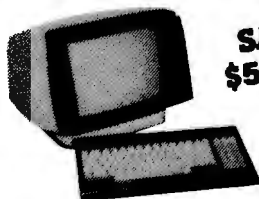

SALE!
\$525.00

VIEWPOINT - ADDS

Detachable keyboard, RS232 interface and auxiliary port, 80 x 24 display, tiltable screen.

B040V070P	Sh. weight: 30 lbs.	\$699.00	\$525.00
-----------	---------------------	----------	----------

DISK CABINETS

V-100 - VISTA

- Desk or rack mountable • Internal power and data cables
- Drives pull out for easy service and maintenance

B04VS100	Disk Drive Cabinet (43 lbs)	\$495.00	\$449.00
----------	-----------------------------	----------	----------

B04VS100	With purchase of two 8" Disk Drives	\$399.00	
----------	-------------------------------------	----------	--

SINGLE 8" - Q.T.

B04TC80C	Single 8" cabinet with power supply (22 lbs.)	\$249.00	\$225.00
----------	---	----------	----------

B04TC80C	Dual 8" cabinet with power supply (24 lbs.)	\$395.00	\$349.00
----------	---	----------	----------

5" CABINETS - VISTA

B04VS001	Single 5" with P.S.	\$ 65.00	
B04VS002	Dual 5" with P.S.	\$119.00	

SEND \$1.00 TODAY FOR THE NEW, FULL COLOR SPRING 1982 ENGINEERING SELECTION GUIDE!



PRIORITY ONE ELECTRONICS

9161 DEERING AVE • CHATSWORTH, CA 91311

ORDER TOLL FREE (800) 423-5922 - CA, AK, HI CALL (213) 709-5464

Terms: U.S. VISA, MC, BAC, Check, Money Order, U.S. Funds Only. CA residents add 6 1/2% Sales Tax. MINIMUM PREPAID ORDER \$15.00. Include MINIMUM SHIPPING & HANDLING of \$3.00 for the first 3 lbs., plus 25¢ for each additional pound. Orders over 50 lbs sent freight collect. Just in case, please include your phone number. Prices subject to change without notice. We will do our best to maintain prices through July, 1982. Credit Card orders will be charged appropriate freight. If you haven't received your Spring '82 Engineering Selection Guide, send \$1.00 for your copy today! Sale prices are for prepaid orders only.

Tandon

Tandon TM-800 Thinline is exactly half the size of conventional 8" floppy disk drives.



Exactly one-half the height of any other model. Proprietary, high-resolution, read-write heads patented by Tandon. D.C. only operation - no A.C. required. Industry standard interface.

	Three millisecond track-to-track access time	(9 lbs.)
B04TM80481	Single Sided \$429.00	2 or more \$399.00
B04TM80482	Double Sided \$379.00	2 or more \$369.00
B04TM80800	Manual - not included with drive	\$ 19.00

TANDON 5 1/4" DRIVES

B04TM1001	Single Sided, 250KB (5 lbs.)	\$249.00**
	2 or More \$220.00	
B04TM1002	Double Sided, 500KB	\$329.00 ea.
	2 or More \$299.00	
B04TM1003	Single Sided, 500KB	\$329.00 ea.
	2 or More \$299.00	
B04TM1004	Double Sided, 1000KB	\$449.00 ea.
	2 or More \$420.00	
B04TM1050	manual, not included with drive	\$ 19.00

*As used in the IBM P.C.

MITSUBISHI ELECTRIC

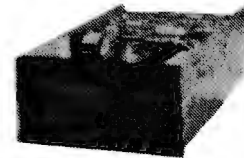

Better Than QUME!
Better Than SHUGART!

B81T206483	8", Double-sided, double-density, interchangeable with QUME & Shugart	\$399.00
B81T209483M	Sh. Weight 16 lbs. Manual	\$ 19.00
	2 or More \$325.00 each	

Shugart 801R

B80H001R	Single sided, double density - most popular 8" drive	\$425.00 ea. or 2 or more (16 lbs) for \$399.00 ea.
B8SHUG001RM	Manual for 801R drives	\$ 19.00



INTERNATIONAL INSTRUMENTATION, INC.



UNIVERSAL DISK ENCLOSURES

- Accepts any combination of 8" drives (QUME/Shugart 801R type or 1/2 size Tandon type) • Also accepts hard disks • Positive pressure • Optional Disk environment monitor shows supply voltage and internal cabinet temperature • Internal power and data cables provided.
- UNIVERSAL DRIVE CABINET complete with power supply, fan and filter, and all internal cables for attachment of two 8" floppy drives.
- | | | | |
|--------------|--|----------|----------|
| B04IUD004 | Dual Drive Cabinet (Sh. Wt. 40 lbs) | \$495.00 | \$499.00 |
| B04IUD004 | With purchase of two 8" Disk Drives | \$399.00 | |
| B04IUD004EM | w/Environmental Monitor installed | \$584.95 | \$539.00 |
| B04IUD004EM | With purchase of two 8" Disk Drives | \$485.00 | |
| B04IUD004OAG | Dual Drive cabinet with Augmentation power supply module to increase 5V supply from 6 amps to 9 amps for use with two hard disks or 4 Tandon drives. Also includes Disk Environment Monitor (45 lbs) | \$733.00 | \$650.00 |
- B04IUD004OAG 19" Rack Mount kit UDE004 \$ 99.00

THIN THREE DRIVE CABINET complete with power supply, and all internal cables for attachment of three thin 8" floppy drives (Tandon type). One AC power connector is also provided for use with full size drive.

B04IUD007	Three Drive Cabinet (Sh. Wt. 35 lbs)	\$495.00	\$499.00
B04IUD007EM	with Environmental Monitor installed	\$584.95	\$539.00

HOW CLEAN IS YOUR POWER?



The Sola Micro/Mini Computer Ultra Isolated Regulator provides instantaneous voltage regulation, and ultra isolation from both transverse and common mode noise for any type of load. It also suppresses transients, protects against overloads and serves as a portable dedicated line. It is the ultimate in AC line conditioning equipment.

The Sola "Micro/Mini" is particularly applicable in systems involving mini or micro computers, POS equipment, microprocessors, or data terminals — where noise and transients cause errors, or low voltage and short term disruptions can result in loss of memory. The output waveshape is sinusoidal and contains less than 3% harmonic distortion, making it ideal for any electronic load.

Common mode noise rejection exceeds 120 dB for the regulator, while transverse noise rejection is better than 60 dB — true ultra isolation. Brownout protection is a real bonus feature. Input line voltage variations as great as $\pm 15\%$ are instantaneously regulated to a maximum output deviation of $\pm 3\%$. And, the output will remain within NEMA voltage specifications for input voltages as low as 65% of nominal.

Especially designed for office type environments, the Sola "Micro/Mini" is truly portable and has a low sound level of 43 dB.

- Instantaneous regulation
- Regulator common mode noise rejection of 120 dB
- Regulator transverse mode noise rejection of 60 dB
- Completely portable — no installation costs
- Matches Mic o/Mini computer packaging
- Complete isolation from power line - less than 3pFd
- Quiet operation — below normal office levels
- Operating range from -20°C to +50°C
- No loss of output for line loss up to 3 msec
- Line cord
- On-off switch
- Dual output receptacles

MINICOMPUTER REGULATORS

PORTABLE 120VAC 60 Hz SINGLE PHASE

Part No.	Maximum Output VA Rating	Dimensions L x W x D (Approx.)	Approx. Shipping Weight	List Price	Our Price
B6SLA0313070	70	12 x 6 x 6	10 lbs.	\$186.85	\$150.00
B6SLA0313114	140	12 x 6 x 6	18	\$244.90	\$200.00
B6SLA0313250	250	14 x 8 x 8	31	\$291.00	\$248.05
B6SLA0313150	500	17 x 9 x 9	47	\$404.20	\$344.00
B6SLA0313175	750	17 x 9 x 9	60	\$515.60	\$438.00
B6SLA0313210	1000	17 x 9 x 9	75	\$597.20	\$508.25
B6SLA0313220	2000*	17 x 11 x 11	108	\$1015.60	\$864.35

Output voltage is 120VAC $\pm 3\%$ for an input voltage of 95-130VAC
*Unit has 30 Amp twist receptacle.
Also available are Hard Wired and 50Hz Models.

MINI UPS

A mini UPS goes one step further than a minicomputer regulator. It provides the same voltage, noise and brownout protection plus maintains power to keep equipment running smoothly during a blackout. When a power failure occurs, the internal maintenance free battery continues powering the inverter without the use of any switching devices. This provides uninterrupted, conditioned AC power to the critical load.

A true UPS always between the AC line and critical load providing complete protection from brownouts and blackouts as well as line noise and transients. Output waveshape is sinusoidal with less than 3% single harmonic and 5% total harmonic distortion. Regulated output is $\pm 3\%$ when operating from either AC line or battery. Handles load surges and fault clearing providing 125% overload for 10 minutes, 150% overload for 10 cycles and 200% in short circuit with 2 automatic recharges before shutdown. Maintenance-free battery automatically recharges upon return of AC line. Oper. Temp. 0°C to 40°C. Especially designed for small, sensitive electronic equipment such as minicomputers, data terminals, P.O.S. systems. Input voltage, 115VAC.

PORTABLE 120VAC 60Hz UNINTERRUPTIBLE POWER SYSTEMS

Part No.	Maximum Output VA Rating / Time	Dimensions L x W x D (Approx.)	Approx. Shipping Weight	List Price	Our Price
B6SLA200000400300	400/10Min	12x19x11	85	\$1544.00	\$1314.00
B6SLA200000400301	400/20Min	12x19x11	95	\$1574.00	\$1330.00
B6SLA200000750300	750/10Min	12x19x11	125	\$1674.00	\$1428.00

Also available are 220V 50Hz models of the above.
Call for all SOLA products not listed.

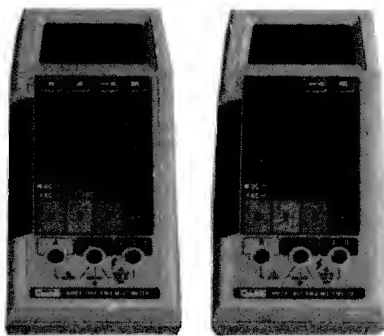

NEW 4 1/2 DIGIT HANDHELDS!

The FLUKE 8060A and 8062A offer the most powerful combination of capabilities ever in a handheld DMM, including these:

- 4 1/2 digit resolution
- 100KHz True RMA (8060A)
- Relative Reference
- Self diagnostics
- 10 μ V, 10mA, 10M sensitivity
- 30KHz True RMS (8062A)
- Constant current diode test
- Basic DC accuracy of 0.04% (8060A); 0.05% (8062A)

The 8060A also offers dBm, relative dB, frequency measurements to 200KHz, Auto ranging megohms to 300k Ω , and conductance (2000 nS).

- B6FLU8060A with safety designed test leads \$348.00
- B6FLU8062A with safety designed test leads \$278.00

3 1/2 DIGIT HANDHELDS: THE WORLD STANDARD

- 11 functions:
- dc voltage
 - ac voltage
 - dc current
 - ac current
 - resistance
 - diode test
 - conductance
 - temperature (via K-type thermocouple)
 - peak hold on voltage and current functions 0.1% basic dc accuracy (8024B & 8020B) 0.25% basic dc accuracy (8021B & 8022B)
 - visual logic level detection
 - high-speed continuity beeper and continuity indicators

Extensive overload 3 1/2-digit resolution protection with 600V double-fused current input. Safety-designed test leads. Two-year parts and Two-year labor warranty. Calibration Cycle.

- B6FLU8024B (All 11 functions) \$238.00
- B6FLU8020B (First 8 functions) \$188.00
- B6FLU8021B (First 7 functions) \$148.00
- B6FLU8022B (First 6 functions) \$138.00

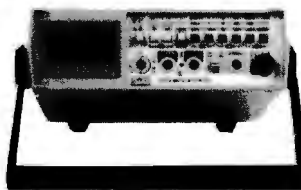

8010A/8012A. Measurement versatility on the bench

- 7 functions:
- dc voltage
 - ac voltage
 - dc current
 - ac current
 - resistance
 - diode test
 - conductance

10 amp current range (8010A)
2 Ω and 20 Ω resistance ranges (8012A)
True RMS ac measurements
3 1/2-digit resolution
0.1% basic dc accuracy
Holds voltage, resistance and conductance readings via 80T-H Touch Hold Probe

Extensive overload protection with 600V double-fused current input

The 8050A. 4 1/2 digits of unique function and features above 7 features, plus:

- 16 selectable reference impedances
- Relative reference/offset
- 4 1/2-digit resolution
- dBm (measuring ac and dc voltage)
- 0.03% basic dc accuracy

- B6FLU8050A 4 1/2 digit True RMS Bench DMM \$388.00
- B6FLU8050A01 with Ni-Cad battery option \$410.00
- B6FLU8010A 10 amp True RMS Bench DMM \$258.00
- B6FLU8010A01 8010A with Ni-Cad battery option \$288.00
- B6FLU8012A Low-Ohms TrueRMS Bench DMM \$338.00
- B6FLU8012A01 8012A with Ni-Cad Battery Option \$378.00

The shipping weight on bench DMM is 5 lbs.; 5 lbs. with Ni-Cad Battery Option

KEITHLEY

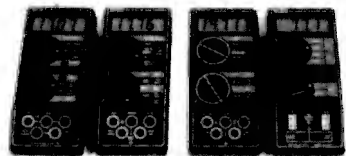

Handheld DMMs For Every Application and Budget

- dc voltage
- dc current
- ac current
- Resistance
- Diode Test
- Easy-to-use Rotary Switches
- Large 0.6" LCD displays
- 3 1/2 or 4 1/2 digit accuracy
- Overload protection
- Externally accessible battery & fuse
- Rugged 0.1" ABS Plastic Case
- Shock-Mounted PC Board

- BGKTH130 $\pm 0.5\%$ DCV accuracy, 10M Ω input impedance auto polarity and current measurement through 10A \$124.00
- BGKTH131 Same as BGKTH130 except 0.25% accuracy \$138.00
- BGKTH120 See/hear display includes both over/under threshold indicator arrows, audible tone that operates on all ranges & functions, and adjustable threshold \$138.00
- BGKTH135 4 1/2 digit, 0.05% accuracy \$238.00
- BGKTH071 Thermocouple (TC) based thermometer \$188.00
- BGKTH1304 Soft Carrying Case & Stand (handhelds) \$ 18.00
- BGKTH1306 Deluxe Carrying Case (handhelds) \$ 25.00



Bench DMMs: Solid Price/Performance Values

- BGKTH188 0.25% DCV 3 1/2 digit LCD display \$188.00
- BGKTH176 0.05% DCV 4 1/2 digit LCD display \$288.00
- 20KHz bandwidth on lower ranges
- BGKTH178A 0.04% DCV 4 1/2 digit LED display \$388.00
- 20A capability TRMS ACV
- BGKTH1782 BCD Output Option for BGKTH179A \$188.00
- BGKTH1783 IEEE interface for BGKTH179A \$325.00



GLOBAL SPECIALTIES LOGIC PROBES SPECIFICATIONS

MODEL	LP1	LP2	LP3
Response	50 ns, 80 ns	300 ns; 1.5 MHz	6 ns typical single-shot event, pulse train tested at 10 ns, 10MHz pulse train
Pulse Mode	High Speed Trainor Single Event		

Part No.	Description	List Price	Our Price
B6GSCLP1	Standard 10MHz w/Memory	\$50.00	\$45.00
B6GSCLP2	Economy 1.5MHz	\$32.00	\$30.00
B6GSCLP3	High-Speed 50MHz w/Memory	\$77.00	\$88.00
B6GSCLP4	100MHz + ECL Logic Probe	\$150.00	\$138.00
B6GSCPI	High-speed digital pulser, 100 PPS or single-shot	\$83.00	\$78.00

16 AND 40 CHANNEL LOGIC MONITORS

LM1 clips over any DIP IC up to 16 pins. Each of its 16 contacts connects to a single bit level detector that drives a high intensity, numbered LED readout activated when the applied voltage exceeds a fixed 2 V threshold. Logic "1" turns LED on; logic "0" keeps LED off.

- B6GSCLM1 \$79.00 \$72.00
- LM-4 will instantly and clearly display the logic states of any digital IC up to 40 pins or any of up to 40 independent circuit points when used with its standardly supplied connector cable terminated with a 40-pin IC test clip
- B6GSCLM4 \$199.00 \$188.00

- ### LOGICAL ANALYSIS KITS
- B6GSCLC1 LP1, DP1 & LM1 in molded case \$240.00 \$220.00
 - B6GSCLC2 LP3, DP1 & LM1 in molded case \$270.00 \$245.00

PRIORITY ONE ELECTRONICS

page NC Drilled Boards

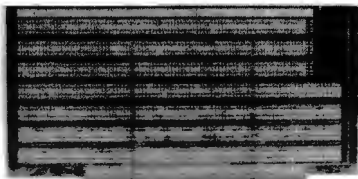

Page's NC[®] DRILLED Printed Circuit Boards offer you benefits not currently available from a conventional punched board. If you are involved in professional prototyping of PC boards, you know that a "clean" prototype is always more representative of what you can expect in your final production board. AND isn't that what prototyping is all about? *If you Want the Best... Ask for PAGE!*

SPECIFICATIONS:

UL Approved.
 Material: .062" (1.57mm) thick FR-4 epoxy glass laminated copper per MIL-T-55561 Type GF.
 Hole Diameter: .042" NC drilled.
 Plating: Circuitry: Electroless tin 50 x 10-6 in.
 Contact fingers: .0010" gold over .0050" nickel.
 Contact fingers are chamfered for ease of insertion.

S-100 BOARDS

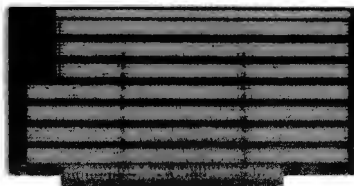

P1002 Component Side

PART NO.	DESCRIPTION	PRICE		
		1-4	5-9	10-24
BPBP1001	S100 Bare Board	\$15.95	\$13.95	\$11.95
BPBP1002	S100 Horizontal Busses	\$22.95	\$19.95	\$17.95
BPBP1003	S100 Vertical Busses	\$22.95	\$19.95	\$17.95
BPBP1004	S100 Pads Per Hole	\$23.95	\$20.95	\$18.95

APPLE BOARDS



P5002 Component Side

PART NO.	DESCRIPTION	PRICE		
		1-4	5-9	10-24
BPBP5001	Apple Bare Board	\$15.95	\$13.95	\$11.95
BPBP5002	Apple Horizontal Busses	\$22.95	\$19.95	\$17.95
BPBP5004	Apple Pads Per Hole	\$23.95	\$20.95	\$18.95

GENERAL PURPOSE PLUGBOARDS

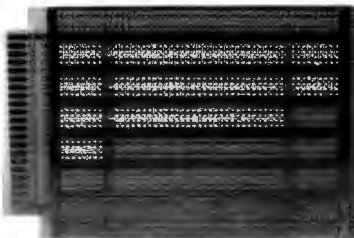

P4413 Wiring Side

BPBP4411	4.5"x6"	22/44	156"	Bare Board	\$ 9.95	\$ 8.95	7.95
BPBP4413	4.5"x6"	22/44	156"	Vertical Buss	\$13.95	\$12.95	\$11.95
BPBP4414	4.5"x6"	22/44	156"	Pads Per Hole	\$14.95	\$13.95	\$12.95
BPBP4421	4.5"x9.6"	22/44	156"	Bare Board	\$19.95	\$ 9.95	\$ 9.95
BPBP4423	4.5"x9.6"	22/44	156"	Vertical Buss	\$14.95	\$13.95	\$12.95
BPBP4424	4.5"x9.6"	22/44	156"	Pads Per Hole	\$15.95	\$14.95	\$13.95
BPBP7211	4.5"x6"	36/72	1.1"	Bare Board	\$ 9.95	\$ 9.95	7.95
BPBP7213	4.5"x6"	36/72	1.1"	Vertical Buss	\$13.95	\$12.95	\$11.95
BPBP7214	4.5"x6"	36/72	1.1"	Pads Per Hole	\$14.95	\$13.95	\$12.95
BPBP7221	4.5"x9.6"	36/72	1.1"	Bare Board	\$19.95	\$ 9.95	\$ 9.95
BPBP7223	4.5"x9.6"	36/72	1.1"	Vertical Buss	\$14.95	\$13.95	\$12.95
BPBP7224	4.5"x9.6"	36/72	1.1"	Pads Per Hole	\$15.95	\$14.95	\$13.95

We stock the entire PAGE line of boards, pre-cut and pre-stripped wire wrap wire, and pre-assembled IDC flat cable assemblies. Please see our Spring catalog or call for products not listed.

RS232 and "D" SUB-MINIATURE CONNECTORS

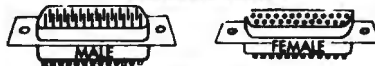

SOLDER TYPE

P=Plug, Male Type — S=Socket, Female Type — C=Cover, Hood

PART NO.	DESCRIPTION	PRICE		
		1-9	10-24	25-99
BGCNDDECP	9 Pin Male	\$ 2.10	\$ 1.90	\$1.70
BGCNDDES	9 Pin Female	\$ 2.70	\$ 2.40	\$2.10
BGCNDDEC	9 Pin Cover	\$ 1.50	\$ 1.25	\$1.10
BGCNDDA15P	15 Pin Male	\$ 2.75	\$ 2.45	\$2.15
BGCNDDA15S	15 Pin Female	\$ 3.95	\$ 3.60	\$3.20
BGCNDDA15C	15 Pin Cover	\$ 1.50	\$ 1.30	\$1.10
BGCNDAA25P	25 Pin Male	\$ 3.00	\$ 2.75	\$2.25
BGCNDAA25S	25 Pin Female	\$ 4.00	\$ 3.75	\$3.00
BGCNDDB51212	1 Pc. Grey Hood	\$ 1.90	\$ 1.45	\$1.30
BGCNDDB5	2 Pc. Grey Hood	\$ 1.50	\$ 1.25	\$1.10
BGCNDDB51226	2 Pc. Black Hood	\$ 1.90	\$ 1.95	\$1.45
BGCNDDB37P	37 Pin Male	\$ 5.80	\$ 5.10	\$4.45
BGCNDDB37S	37 Pin Female	\$ 8.70	\$ 7.70	\$6.70
BGCNDDB37C	37 Pin Cover	\$ 1.90	\$ 1.55	\$1.30
BGCNDDB50P	50 Pin Male	\$ 8.75	\$ 7.75	\$6.70
BGCNDDB50S	50 Pin Female	\$11.65	\$10.25	\$8.90
BGCNDDB50C	50 Pin Cover	\$ 2.90	\$ 1.90	\$1.90
BGCNDDB20418	Hardware Set 2/Pr RS232, DB25P, EIA	\$ 1.90	\$.98	\$ 1.70
BGCNDRS232RF	Class 1 Cable 8 Con 8 Ft	\$18.95	\$17.95	\$15.95
BGCND573030	Cent. 700 Series/ Epson Printer Conn.	\$ 9.90	\$ 7.50	\$6.90
BGIDC573080	IDC Version of Above	\$ 9.95	\$ 8.90	\$6.90

CALL FOR IDC "D" CONNECTORS

ROBINSON NUGENT, INC.

IGN SERIES GOLD 3 LEVEL WIRE WRAP SOCKETS



- 10 µ in GOLD Plated Pins
- Deep Chamfered Closed Entry Contacts
- RN Side Wipe Contact Design
- Phosphor Bronze Contact Material
- Terminal Barbs Allow Self-lock into PC Board
- Rugged Socket Body Design
- Deep Chamfered Closed Entry Contacts

PART NO.	STANDARD PINS	PCBRE.	PRICE EACH				
			10-24	25-99	100-249		
BGRNS09WWW	8	52	.90	N/A	.49	.45	.41
BGRNS14WWW	14	30	.75	.70	.65	.65	.65
BGRNS18WWW	16	26	.85	.75	.70	.60	.52
BGRNS19WWW	18	23	1.90	.90	.80	.75	.71
BGRNS20WWW	20	21	1.20	1.05	.90	.91	.87
BGRNS22WWW	22	19	1.35	1.25	1.15	1.05	.99
BGRNS24WWW	24	17	1.35	1.25	1.15	1.05	.99
BGRNS29WWW	28	15	1.70	1.55	1.40	1.34	1.25
BGRNS40WWW	40	10	2.20	2.05	1.85	1.60	1.50

*MINIMUM ORDER \$1.00 per line item. To receive quantity prices beyond 1st column you must order EXACT multiples of STANDARD PACKAGES.

GOLD PLATED CONTACTS



NEW!

SELECTIVE PLATED PINS THAT WILL SAVE YOU MONEY BY HAVING GOLD ONLY WHERE IT COUNTS! Same as above except pins are selectively plated.

BGRNS09TWW	8	52	.55	N/A	.45	.41	.37
BGRNS14TWW	14	30	.65	.55	.50	.47	.44
BGRNS16TWW	16	26	.75	.65	.62	.51	.46
BGRNS18TWW	18	23	.90	.70	.75	.70	.65
BGRNS20TWW	20	21	1.10	.95	.91	.87	.82
BGRNS22TWW	22	19	1.25	1.15	1.05	.94	.89
BGRNS24TWW	24	17	1.25	1.15	1.05	.99	.99
BGRNS29TWW	28	15	1.50	1.45	1.35	1.25	1.15
BGRNS40TWW	40	10	2.00	1.90	1.80	1.40	1.30

*MINIMUM ORDER \$1.00 per line item. To receive quantity prices beyond 1st Column you must order EXACT multiples of STANDARD PACKAGES.

SEND \$1.00 TODAY FOR THE NEW FULL COLOR, SPRING 1982 ENGINEERING SELECTION GUIDE



PRIORITY ONE ELECTRONICS

9161 DEERING AVE • CHATSWORTH, CA 91311

ORDER TOLL FREE (800) 423-5922 - CA, AK, HI CALL (213) 709-5464
 Terms: U.S. VISA, MC, BAC, Check, Money Order, U.S. Funds Only. CA residents add 6% Sales TAX. MINIMUM PREPAID ORDER \$15.00. Include MINIMUM SHIPPING & HANDLING at \$3.00 for the first 3 lbs., plus 25¢ for each additional pound. Orders over 50 lbs. sent freight collect. Just in case, please include your phone number. Prices subject to change without notice. We will do our best to maintain prices through July, 1982. Credit Card orders will be charged appropriate freight. If you haven't received your Spring '82 Engineering Selection Guide, send \$1.00 for your copy today! Sale prices are for prepaid orders only.

PROTECT YOUR INVESTMENT
 PROTECT YOUR DATA WITH



With Built-In Noise Filters and Surge Suppressors



ISOLATES SENSITIVE AND VALUABLE EQUIPMENT FROM: Equipment interaction - Damaging High Voltage Spikes - AC line noise and hash
PROTECTS AGAINST: Voltage transients caused by lightning, contact switching, turn-off of inductive components, noise due to electro-magnetic coupling
USE THE GSC ISOBAR TO ISOLATE: Microprocessor from peripherals - Lab instruments from noisy equipment - Sensitive pre-amp or tape deck from power amplifier
THE GSC ISOBAR ELIMINATES: Equipment interaction - Equipment damage from power line spikes and surges - Errors - False printouts - Disk Skips - Audio or video hash
FEATURES: Inductive isolated ground - Sockets individually filter isolated - Circuit breaker protected at 15A.
VOLTAJE TRANSIENT SPIKE PROTECTION: 2000 A peak for up to 6 Sec duration spikes. 1000A, 8/20 Sec protection from repeated spikes.
LOAD HANDLING: 1875 W max. total load; 15A per socket.
INPUT: 125 VAC, 15 amps; standard 3-prong plug.
ISOAR 3 - Three common outlets built-in circuit breaker, pilot light, hang-up bracket and a 6-foot cord.

		List Price	Our Price
ISOAR 3	Sh. Wt. 3 lbs.	\$59.95	\$42.00
ISOAR 4B	Four independently isolated outlets. Built-in 15A circuit breaker, pilot light, switch, and 6-foot cord.		
ISOAR 4B	Sh. Wt. 4 lbs.	\$79.95	\$49.95
ISOAR 8B	8 outlets, grouped to form 4 independently isolated sets of two. Built-in 15A circuit breaker, on/off switch, pilot light.		
ISOAR 8B	Sh. Wt. 5 lbs.	\$84.95	\$64.95
ISOAR 8RM	Eight rear-mounted outlets grouped to form four independently isolated sets of two, plus one non-isolated convenience outlet on front face. 19" rack mount cabinet. Built-in 15A circuit breaker, pilot light, on/off switch, and 6-foot cord.		
ISOAR 8RM	Sh. Wt. 6 lbs.	\$99.95	\$74.95

RS232 Breakout Box

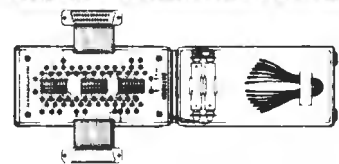

A must for every technician, repair man or systems integrator

Databox is contained in a tough, plastic case and is powered by two, 1.5 volt penlight batteries. No power is consumed by the tester when not in use. Dimensions: 2.9"x5.5"x1.45". Weight: 10 oz. w/batteries.
BGRNS2290X \$199.00 \$184.00

MICROCOMPUTER PRODUCTS

PART NO.	PRICE	PART NO.	PRICE
BG411BAC20	\$718.00	BGINS8080A	\$5.50
BG2018P2	\$572.00	BGINS8080B	\$19.95
BG2114N3L	\$528.00	BGDP212H	\$2.95
BG2527N3L	\$550.00	BGDP214H	\$5.25
BG2732	\$598.00	BGDP218H	\$2.95
BG2716	\$548.00	BGDP224H	\$3.25
BG2708	\$520.00	BGDP224-4H	\$9.95
		BGDP228H	\$3.50
Z80 SERIES			
BGZ80A	\$13.38	BGDP228H	\$5.55
BGZ80AP10	\$11.18	BGDP230H	\$5.55
BGZ80ACT	\$11.18	BGINS8250H	\$15.95
BGZ80ADMA	\$33.38	BGINS8251H	\$7.50
BGZ80AS100	\$36.95	BGINS8253H	\$17.95
BGZ80AS101	\$36.95	BGINS8255H	\$6.60
BGZ80AS102	\$36.95	BGINS8257H	\$18.45
		BGINS8258H	\$18.00
		BGINS8259H	\$69.95
UARTS			
BGAYS1013A	\$5.95	BGINS8275H	\$69.95
BGTR1802B	\$4.95	BGINS8278H	\$24.95
BGTR1803	\$4.95		
BGINS402	\$7.95	FLOPPY DISC CONTROLLER	
		BGFO1771B-01	\$24.95
		BGFO1791B-01	\$44.95

Why use their flexible discs:

BASF, Control Data, Dysan, IBM, Kybe, Maxell, Nashua, Scotch, Syncom, Verbatim or Wabash
when you could be using

MEMOREX

high quality error free discs?

Product Description	Part #	CE quant. 100 price per disc (\$)
8" SSSD IBM Compatible (128 B/S, 26 Sectors)	3062	2.09
8" SSSD Shugart Compatible, 32 Hard Sector	3015	2.09
8" SSSD CPT 8000 Compatible, Soft Sector	3045	2.99
8" SSDD IBM Compatible (128 B/S, 26 Sectors)	3090	2.74
8" DSDD Soft Sector (Unformatted)	3102	3.34
8" DSDD Soft Sector (128 B/S, 26 Sectors)	3115	3.34
8" DSDD Soft Sector (256 B/S, 26 Sectors)	3103	3.34
8" DSDD Soft Sector (512 B/S, 15 Sectors)	3114	3.34
8" DSDD Soft Sector (1024 B/S, 8 Sectors)	3104	3.34
5 1/4" SSDD Soft Sector w/Hub Ring	3481	2.34
5 1/4" SSDD 10 Hard Sector w/Hub Ring	3483	2.34
5 1/4" SSDD 16 Hard Sector w/Hub Ring	3485	2.34
5 1/4" DSDD Soft Sector w/Hub Ring	3491	3.09
5 1/4" DSDD 10 Hard Sector w/Hub Ring	3493	3.09
5 1/4" DSDD 16 Hard Sector w/Hub Ring	3495	3.09
5 1/4" SSDD Soft Sector w/Hub Ring (96 TPI)	3504	2.99
5 1/4" DSDD Soft Sector w/Hub Ring (96 TPI)	3501	3.99

SSSD = Single Sided Single Density, SSDD = Single Sided Double Density
DSDD = Double Sided Double Density, TPI = Tracks per inch

Memorex Flexible Discs... The Ultimate in Memory Excellence

Free Memorex Mini-Disc Offer - Save 10%

Every carton of 10 Memorex 5 1/4 inch mini-discs sold by Communications Electronics, now has a coupon good for a free Memorex mini-disc. For every case of 100 Memorex mini-discs you buy from CE, you'll get 10 free mini-discs directly from Memorex. There is no limit to the number of discs you can purchase on this special offer. This offer is good only in the U.S.A. and ends on December 31, 1982.

Quality

Memorex means quality products that you can depend on. Quality control at Memorex means starting with the best materials available and continual surveillance throughout the entire manufacturing process. The benefit of Memorex's years of experience in magnetic media production, resulting, for instance, in proprietary coating formulations. The most sophisticated testing procedures you'll find anywhere in the business.

100 Percent Error Free

Each and every Memorex Flexible Disc is certified to be 100 percent error free. Each track of each flexible disc is tested, individually, to Memorex's stringent standards of excellence. They test signal amplitude, resolution, low-pass modulation, overwrite, missing pulse error and extra pulse error. Rigid quality audits are built into every step of the manufacturing process and stringent testing result in a standard of excellence that assures you, our customer, of a quality product designed for increased reliability and consistent top performance.

Customer-Oriented Packaging

The desk-top box containing ten discs is convenient for filing and storage. Both box labels and jacket labels provide full information on compatibility, density, sectoring, and record length. Envelopes with multi-language care and handling instructions and color-coded removable labels are included. A write-protect feature is available to provide data security.

Full One Year Warranty—Your Assurance of Quality

Memorex Flexible Discs will be replaced free of charge by Memorex if they are found to be defective in materials or workmanship within one year of the date of purchase. Other than replacement, Memorex will not be responsible for any damages or losses (including consequential damages) caused by the use of Memorex Flexible Discs.

Quantity Discounts Available

Memorex Flexible Discs are packed 10 discs to a carton and 10 cartons to a case. Please order only in increments of 100 units for quantity 100 pricing. We are also willing to accommodate your smaller orders. Quantities less than 100 units are available in increments of 10 units at a 10% surcharge. Quantity discounts are also available. Order 500 or more discs at the same time and deduct 1%; 1,000 or more saves you 2%; 2,000 or more saves you 3%; 5,000 or more saves you 4%; 10,000 or more saves you 5%; 25,000 or more saves you 6%; 50,000 or more saves you 7% and 100,000 or more discs earns you an 8% discount off our super low quantity 100 price. Almost all Memorex Flexible Discs are immediately available from CE. Our warehouse facilities are equipped to help us get you the quality product you need, when you need it. If you need further assistance to find the flexible disc that's right for you, call the Memorex compatibility hotline. Dial toll-free 800-538-8080 and ask for the flexible disc hotline extension 0997. In California dial 800-672-3525 extension 0997. Outside the U.S.A. dial 408-987-0997.

Buy with Confidence

To get the fastest delivery from CE of your Memorex Flexible Discs, send or phone your order directly to our Computer Products Division. Be sure to calculate your price using the CE prices in this ad. Michigan residents please add 4% sales tax. Written purchase orders are accepted from approved government agencies and most well rated firms at a 30% surcharge for net 30 billing. All sales are subject to availability, acceptance and verification. All sales are final. Prices, terms and specifications are subject to change without notice. Out of stock items will be placed on backorder automatically unless CE is instructed differently. Minimum prepaid order \$50.00. Minimum purchase order \$200.00. International orders are invited with a \$20.00 surcharge for special handling in addition to shipping charges. All shipments are F.O.B. Ann Arbor, Michigan. No COD's please. Non-certified and foreign checks require bank clearance.

Mail orders to: Communications Electronics, Box 1002, Ann Arbor, Michigan 48106 U.S.A. Add \$8.00 per case or partial-case of 100 8-inch discs or \$6.00 per case or partial case of 100 5 1/4-inch mini-discs for U.P.S. ground shipping and handling in the continental U.S.A. If you have a Master Card or Visa card, you may call anytime and place a credit card order. Order toll-free in the U.S. Dial 800-521-4414. If you are outside the U.S. or in Michigan, dial 313-994-4444. Order your high quality, error free Memorex discs today.

Copyright © 1982 Communications Electronics™

Ad #061782

Free disc offer Save 10%



Order Toll-Free!
(800) 521-4414

In Michigan (313) 994-4444

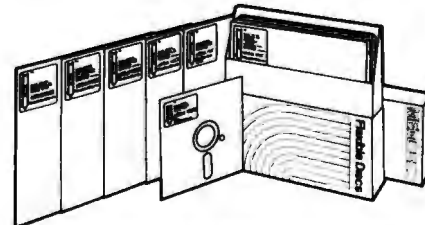

For Data Reliability—Memorex Flexible Discs

COMMUNICATIONS ELECTRONICS™

Computer Products Division

854 Phoenix □ Box 1002 □ Ann Arbor, Michigan 48106 U.S.A.
Call TOLL-FREE (800) 521-4414 or outside U.S.A. (313) 994-4444

Unclassified Ads

FOR SALE: BYTE from issue #1 through August 1979. Mint condition. Make offer. Dan S. Tong, Northwestern U. Tech. 3763, Evanston, IL 60201. [312] 492-7686 days.

FOR SALE: Centronics 101 printer: 165 cps, 132 characters per line, 5 by 7 dot matrix, and 60-200 lines per minute. Recently overhauled. Heavy-duty printer for \$1500 or best reasonable offer. Also, two Techtran 8410 datacassette recorders, RS-232 interface with manuals. In mint condition. \$500 or best reasonable offer. David V. Fansler, 700 Ward St., Graham, NC 27253, [919] 227-7640 after 6 p.m. ET.

FOR SALE: Complete Atan 400 computer system: 16K Atan 400, 410 program recorder, BASIC cartridge, over \$100 worth of game cartridges (Star Raiders, Missile Command, Super Breakout, Avalanche), full manuals, and 530 operating-system manuals in a special binder. System only a few months old; would cost over \$630 new. Only \$389 plus free shipping. Brett Bobley, High Farms Rd., Glen Head, NY 11545, [516] 671-6707.

WANTED: Schematics for Extensys Corporation Model RM64-64K dynamic RAM board for S-100 bus. Will pay reasonable reproduction and mailing costs. W. E. Buoy Jr., 16319 Pebbleglen, Houston, TX 77095.

FOR SALE: PDP-8 and dual DEC tape drives. I would also like to hear from microcomputer users in medicine. Derek Enlander, M.D., Nuclear Medicine Department, N.Y.U. Medical Center, 560 First Ave., New York, NY 10016.

FOR SALE: Heavy-duty Centronics 102A printer. Very high speed (330 cps). Perfect working order. Asking \$995. L. Neuzeling, 1200 Arundel Dr., Kokomo, IN 46901, [317] 452-8971 evenings.

FOR TRADE: Games for the TRS-80 Color Computer. Original programs sent will be replaced by mine, written for extended 16 K. Also interested in homemade hardware. Cassettes come with listing. M. T. Baran, POB 1448, Hayfork, CA 96041.

FOR SALE: PAIA 8700 computer-based synthesizer system. D/A, QUASH, V.C.O., V.C.A., envelope generator, ring modulator, phlanger, parametric eq, spring reverb, mini preamp, and power supplies. Includes all types of patch cords and all documentation. Jeff Wurster, B Hickory Pl., Seneca Falls, NY 13148.

FOR SALE: 43 issues of BYTE, June 1977 through December 1980. Excellent condition \$80 firm, postage paid. Also, four issues of onComputing, Summer 1979 through Spring 1980, and five issues of Personal Computing, October 1980 through January 1981 and March 1981. \$2 each, postage paid. Larry Felton, 5140 Yvette, El Paso, TX 79924.

FOR SALE: Two Hazelton 2000 dual cassette decks and one silent (TI) printer for same. Also, one hard-copy portable terminal with coupler and case (not working). \$500 plus shipping takes all. David Greenblatt, 812 Roosevelt Court, Far Rockaway, NY 11691, [212] 471-2456.

FOR SALE: Complete S-100 disk system for \$1200. System includes a Micropolis disk drive, Polymorphic 8080 processor and video, 64K memory, 12-inch TV with RF modulator, GRI keyboard, 20-slot motherboard, and 28-A power supply. Everything is assembled, tested, and working. Includes documentation. Also, 15-inch Sanyo monitor; \$150. Newtech music (S-100) board; \$50, and ASCII CRT; \$100. Mark Hanslip, 1128 Lavern Ave., Kettennig, OH 45429, [513] 293-3324.

FOR SALE: Apple II communications card; \$125. Novaton D-Cat modem with cable, \$125. Centronics 737 printer (parallel) with cable, \$545. Philip Castevens, 3915 A Valley Court, Winston-Salem, NC 27106, [919] 765-5588 evenings.

FOR SALE: IBM/ 8080 mainframe: S-100/EEE-696 system with 18 slots. Warnaco front panel (hex displays), two Warnaco 8080 processor boards, Warnaco 8K static RAM board, Warnaco I/O board, Biotech BCG-800 color graphics board, SSM extender board, and Vector proto board. No monitor. Complete documentation and accessories. Only \$700 plus shipping. R. Fischer, 5152 Lynd Ave., Lyndhurst, OH 44124, [216] 442-8054 evenings.

WANTED: Several Pocket Com CB units. They are miniature multichannel units. Also needed is a schematic of the same unit. Please include price. Pat Sagstetter, 8201 NPS USN, Orlando, FL 32813.

FOR SALE: One complete set each, some in binders, of: Interface/Interface Age, BYTE, and Klobaud Microcomputing. Best offer for a complete set. Pick up only. Alan P. Biddle, 3511 Mae Dr. SE, Huntsville, AL 35801.

WANTED: I am a dedicated college student trying to complete my degree in Computer Science. Any contribution you can send would be greatly appreciated and acknowledged immediately. Please help me. Mark Kopec, 9526 South Central Park, Evergreen Park, IL 60642.

FOR SALE: Attention homebrewers! I am selling much of my home stock of ICs, LEDs, capacitors, memory chips, voltage regulators, etc. All items new and unused. Top-name brands at really low prices. Send SASE for list of items and prices. L. E. Steiner, 4876 Aleda Ave. SE, Kentwood, MI 49508.

FOR SALE: PET 2001 8K old ROMs. 32K Expandamen board with Programmers Toolkit. Over 150 programs, mostly games, including Space Invaders and Microchess 2.0. \$750. Jeff Taylor, 272 Hartley Ave., Princeton, NJ 08540, [609] 683-0571.

WANTED: Used microcomputer, software, and equipment for use in small rural library. Donate for tax deduction or low fee; send UPS collect. R. W. Dorog, 37 West Main St., Brocton, NY 14716, [714] 792-9012.

FOR SALE: 48K TRS-80 Model III with powerful Level III BASIC; \$850. 32K expansion interface for the Model I, \$400. Both components are new. Make an offer on either component. Rene Putnier, 14344 Starbuck St., Whittier, CA 90605, [213] 698-3361.

WANTED: Hammers from Potter LP3000 line printer. Must have blade attached. Will pay \$10 each for two or three of them. Stephen Wenzel, 516 South Scoville Ave., Oak Park, IL 60304.

FOR SALE: 32K North Star with two quad-density disk drives and Wordsmith word processor, including Screensplitter video (86 characters by 40 lines), 15-inch monitor, and Wordsmith WP keyboard. [See May 1981 BYTE for review of this WP system.] Also, Diablo 1650 printer for highest quality print plus graphics capabilities. Total system, like new, for \$7000. Will consider selling printer or Wordsmith alone. Bob Renegar, 23 Brookside Rd., Wallingford, PA 19086, [215] 566-4097.

FOR SALE OR SWAP: BASF 5-inch disk drive; \$175. BYTE: Vol. 1-4, new condition; make offer. EICO Model 460 oscilloscope; \$150. I will consider any offer or trade. Want OSI bus-compatible boards, a Superboard, ZX81, or VIC-20. Quintin Leach, 11985 Southwest Parkway, Portland, OR 97225, [503] 646-6644.

FOR TRADE: Want to swap game programs for TRS-80 Pocket Computer. Send your list of programs to trade, and I'll send mine. John Riggs, 1114 Elaine, Livermore, CA 94550.

WANTED: Hewlett-Packard 9830 with or without peripherals or other HP desktop. A. Specht, 2302 Viewlynn, North Vancouver, B.C., V7J 2X1 Canada, [604] 987-9691.

FOR SALE: SOL-20 48K with two North Star drives and a Heathkit monitor. Lots of software, including CPM, CBASIC, ECB Disk BASIC, games, etc. \$1200. Works fine. Upgrading to 8-inch system. Texas Instruments 743 printer/terminal; \$750. Gerry Fricke, 435 South Charter, Monticello, IL 61856, [217] 762-7143.

FOR SALE: SwTPC 6800/2 computer with 24K memory, CT-64 terminal, CT-EA screen read, AC-30 cassette interface, and software. \$900 or best offer. W. Faulconer, 4725 West Quincy #601, Denver, CO 80236, [303] 798-4499.

FOR SALE: Four GTE Model 5-60 teletype terminals with built-in offline tape storage. Uses Selectric-type element and has internal modem capability. Comes with complete documentation. Used, need some work. Jerry Pav, 2370 Fellowship Park Way, Los Angeles, CA 90039.

FOR SALE: SwTPC CT-64 terminal with 9-inch video monitor, RS-232 interface, up to 1200 bps, all options installed. Works fine. \$150. Paul Pennington, 2912 Palmetto Dr., Martinez, GA 30907, [404] 860-2934.

FOR SALE: Heathkit ET-3400 microprocessor trainer. Assembled and working perfectly. \$100. ET-3401 microprocessor trainer course, including components. \$50. S. K. Cooper, 533 North Marlborough C., Shreveport, LA 71106.

FOR SALE: Tarbell S-100 cassette interface board. Manual is included and all chips are socketed. \$25. January 1979 to January 1981 BYTE. \$25. Joe Cyszczyewski, 12607 Blackfoot, Round Rock, TX 78664, [512] 258-0337.

FOR SALE: Westware Business Accounting System with KSAM Board, Payroll, Receivables, Inventory, General Ledger, etc. August 1981 revision. Unused manuals and 10 disks for Apple II 48K AS ROM. \$800. \$1600 retail. Also, new Trendcom printer with Apple interface. \$200. Dan Shanis, POB 145, McGrath, AK 99627, [907] 524-3892.

FOR SALE: Okidata Microline printer for TRS-80, Apple, Atan, etc. New, still in box. Asking \$375. Bernhard Walther, 100 Cedar 308, Dobbs Ferry, NY 10522, [914] 693-5720.

FOR SALE: Apple II plus with 48K memory, Disk II with DOS 3.3 plus controller, Integer firmware card, and a variety of programs, including Apple Pie, Apple Plot, Microsoft Adventure, Sargon II, and many others. Total value over \$2400. Asking \$1800. All in excellent condition. Richard Ling, 4550 Scott Ave., Apt. 619, St. Louis, MO 63110, [314] 361-2064 evenings. 454-5351 days.

FOR SALE: Trendcom 40-column printer and interface to Apple II. Two D.C. Hayes Micromodem II with microcoupler. Hewlett-Packard HP-67 calculator plus Business, Math and Stat Pac, and blank cards. Donald Robbins, 251-25 Gaskell Rd., Little Neck, NY 11362, [212] 428-8442.

FOR SALE: Commodore PET 2001. Original 8K with manual and more than 40 programs; \$510. Also, two 8-inch Shugart single-sided disk drives with power supply (working), less case. \$580. With or after sale of PET will sell Best S-100 expansion for PET with power supply and case for \$90, three 8K 21L02 S-100 memory boards at \$80 each, and 16K EPROM S-100 boards at \$60. Edward Shields, 117 Devol Dr., Marietta, OH 45750, [614] 373-7672.

UNCLASSIFIED POLICY: Readers who are soliciting or giving advice, or who have equipment to buy, sell or swap should send in a clearly typed notice to that effect. To be considered for publication, an advertisement must be clearly noncommercial, typed double spaced on plain white paper, contain 75 words or less, and include complete name and address information.

These notices are free of charge and will be printed one time only on a space available basis. Notices can be accepted from individuals or bona fide computer users clubs only. We can engage in no correspondence on these and your confirmation of placement is appearance in an issue of BYTE.

Please note that it may take three or four months for an ad to appear in the magazine

Unclassified Ads

FOR SALE: Apple II+ with 48 K plus Pascal language card, Apple disk drive, and controller card. Software includes Integer and Applesoft BASICs, DOS 3.3, DOS Tool Kit, Pascal, 3-D Graphics, text editor, Apple Invaders, Apple Adventure, and 10 disks full of games and miscellaneous fun. \$1997 Dale N. Reynolds, 719 Sunrise Lane, Boulder, CO 80302, (303) 447-9461.

FOR SALE: TRS-80 16 K Model I, Level II (new 2-chip ROM), like new. Includes CTR-80 recorder, mini-amp for SFX, system desk, Advanced Statistical Analysis (eight tapes, full documentation), Cross-reference Utility, LI-III Program/Data Conversion, LI in LI, Typing Tutor, Microchess, Space Warp, Flying Saucers, Raaka-Tu, several LI games, TRS-80 Microcomputer News July 1980 to present, miscellaneous books, and magazines. \$850 takes all. Tim Howlett, 900 Union Commerce Bldg., Cleveland, OH 44115, (216) 344-8339.

WANTED: Used TRS-80 expansion interface and disk drives. Pick-up only. Tom Jung, 7-04 166 St., Whitestone, NY 11357.

WANTED: Used NEC Spinwriter, Diablo, ITOH Starwriter, or OUME correspondence printer. Kenneth Glyn Hales, 5990 North Calle Kino, Tucson, AZ 85704, (602) 888-9199.

FOR SALE OR TRADE: PMC-80 [16 K, Level II TRS-80 work-alike]. \$450 or will trade for OSI C4P or KIM-compatible boards. PMC has lowercase modification installed, plus some software and books. Paul Miller, 7623 Pecan Villas #7, Houston, TX 77061, (713) 749-5509 days, 641-3923 nights and weekends.

FOR SALE: NEC TK-80 and TK-80BS (full memory) with power supply (DC +5 V 10 A, -5 V 1 A, +12 V 1 A). Good condition. \$700 or best offer on all three. Send two IRCs for more information. Toshiharu Kitano, POB 4, Higashimurayama, Tokyo, 189 Japan.

FOR SALE: BYTE: all of 1979 except March; all of 1980 except February; all of 1981. 34 issues for \$75 postpaid. R.L. Murray, POB 5596, Raleigh, NC 27650

FOR SALE: DECwriter IV (LA-34) terminal in absolutely perfect condition, including custom-fitted fabric cover and manual. \$900 FOB or best offer over \$750. Al Vazquez, Harvard Business School, 2 Soldiers Field Park 507, Boston, MA 02163.

FOR SALE: Radio Shack LP(II)-Centronics 779 printer. Fast 60 cps matrix-type with fully adjustable forms tractor. Adjustable character size. Unit was just upgraded and cleaned by Centronics. Always covered. Mechanically and cosmetically like new. \$465. Charles Okstein, 6 Storrs Rd., Willimantic, CT 06226, (203) 487-1616.

FOR SALE: Tarbell cassette-controller board complete with cables, data-stream cassette, instruction manual, and data-stream cassette made with this board. Make reasonable offer. Also have Digital Group cassette-system-controller board. No reasonable offer will be refused. Delbert Williams, 3500 Fleetwood Dr., Salt Lake City, UT 84109, (801) 359-7794 days, 272-3107 evenings.

FOR SALE: AIM-65 microcomputer with 4 K RAM, BASIC and assembler in ROM, power supply (24 V, +12 V, -12 V, +5 V), and audio tape player for mass storage. All mounted in standard briefcase. \$500 or best offer. Also, 8086 processor chip. \$45. May trade for Apple gear. D.J. Lija, 404 South Prairie Apt. 8, Champaign, IL 61820, (217) 351-0947.

FOR SALE: SOL-20 computer with burned-out power supply. Worked perfectly for four years until capacitor blew. \$280 or best offer. Jeff Roloff, 2503 Myers Court #7, Champaign, IL 61820, (217) 359-8010.

FOR SALE: North Star floating-point board. Working, one year old, but has seen little use. Best offer over \$250. 24 K Morrow Memory Master. One year old, reliable. Best offer over \$300. Ray Robinson, POB 30452, Atlanta, GA 30332, (404) 872-3850.

MAGAZINES WANTED: Interface Age: December 1975, January 1976-March 1976, September 1976, December 1976, March 1977, and April 1977. BYTE: February 1977. Any condition. Will pay top dollar for good condition. For Sale: BYTE: July 1976 and August 1976; Dr Dobb's: April 1977, January 1978, and May 1978; \$2 each. Andy Beck, POB 571, Jackson, NJ 08527, (201) 370-9889 days, 370-9568 evenings.

FOR SALE: Centronics 101A dot-matrix printer, 165 cps; \$250. IBM Selectric with RS-232 built in; \$599. Perkin-Elmer keyboard, letter quality, 15-inch carriage, 40 cps computer printer/terminal with RS-232 built in (cost over \$5000 new); \$750. All in perfect condition. Lee Wainwright, 535 Main St., Bethlehem, PA 18018.

FREE: Free fixes available for ramware APL-80 Version 3.0 system. If you are using this system and would like to receive bug fixes for "RESHAPE" and "JUPDATE", send a SASE. APL, POB 55, Ardsley, NY 10522.

ATARI MILITARY USERS: Military members who use Atari 400 or 800 computers and are stationed overseas, let's get together and form a users group. Sp/4 Bill Karoly, 212th MP CO, c/o HHC 1st Bde, APO New York, NY 09702 (if you're stationed at an APO, drop the New York, NY for faster mail service).

BOMB

BYTE's Ongoing Monitor Box

Article #	Page	Article	Author(s)
1	34	The Input/Output Primer, Part 6: Interrupts, Buffers, Grounds, and Signal Degradation	Leibson
2	50	Computers, Fiction, and Poetry	McKean
3	54	Scion Color System	Dahmke
4	60	Add Programmable Sound Effects to Your Computer	Ciarcia
5	76	Breaking the Jargon Barrier: Designing Programs for Humanists	Heite, Heite
6	108	Microcomputers in the Study of Politics, Predicting Wars with the Richardson Arms-Race Model	Schrodt
7	138	Software Tools for Writers	Holder
8	166	The Historian and the Microcomputer, A Student of the Past Meets the Machine of the Future	Rowney
9	178	Simulating Neighborhood Segregation	Dethlefsen, Moody
10	208	Measuring Attitudes with a PET, A BASIC Program That Finds Out How People Feel	Heise
11	250	Microcomputers in Cultural Anthropology, APL Programs for Qualitative Analysis	Werner
12	284	Mediamix's ETI ²	Weilborn
13	290	User's Column: Ada, MINCE, CP/M Utilities, Overpriced Documentation, and Analiza II	Pournelle
14	312	Color Computer Disk System	Stearman
15	330	Upward Migration, Part 2: A Comparison of CP/M-86 and MS-DOS	Taylor, Lemmons
16	360	Using the Model III RS-232C Port	Barden
17	378	Programming the Critical-Path Method in BASIC	Zimmernan, Conrad
18	392	Computers for Humanity	Pournelle
19	408	It All Depends On Your Viewpoint	Moore
20	412	Database Management with Ashton-Tate's dBASE II	Abbott

April BOMB Fooled Us

First place in the April BOMB results goes to Robert G. Cooper Jr., Paul Thain Marston, John Durrett, and Theron Stimmel for their presentation of "A Human-Factors Case Study Based on the IBM Personal Computer." Our congratulations to these authors who will share the \$100 prize. Second place, and an award of \$50, goes to Philip Schrodt for his humorous parody "The Generic Word Processor, A Word-Processing System for All Your Needs." We guess the joke is on us. Third place was captured by John Durrett and Judi Trezona for "How to Use Color Displays Effectively, A Look at the Elements of Color Vision and Their Implications for Programmers."

Reader Service

Inquiry No.	Page No.	Inquiry No.	Page No.	Inquiry No.	Page No.	Inquiry No.	Page No.
1	47th STREET PHOTO 293	86	COMPONENTS EXPRESS 428	173	H&E COMPUTRONICS 323	257	MICRO WORKS, THE 401
2	800 SOFTWARE 70	87	COMPUCHANGE 468	85	HAVA COMPUTER 401	258	MICROCOMP.BUSN.IND. 35
3	A.S.T.RESEARCH 91	88	COMPULINK CORP. 128	174	HAYES MICROCOMP.PROD.: 28	442	MICROCOMP.TECH.INC. 243
4	AB COMPUTERS 473		COMPUROGGOBOUT 136, 137, 291	175	HAYES MICROCOMP.PROD. 241	259	MICRODYNAMICS 470
5	ABM PRODUCTS 424	88	COMPUSERVE 127	176	HEATH COMPANY 97		MICROHOUSE 12, 13
6	ACTION COMPUTER 129	93	COMPUTER AGE 453	177	HEWLETT-PACKARD 47	260	MICROMAIL 116
7	ADDMASTER CORP. 478	90	COMPUTER CHANNEL 300	178	HEWLETT-PACKARD 264, 265	261	MICROSOFT 271
8	ADV.COMP.PROD. 496, 497	91	COMPUTER EXCHANGE 282, 283	179	I.B.C. 33	262	MICROSOFT (CPD) 153
9	ADV.MICRO DIGITAL CORP. 77	92	COMPUTER FURN. & ACCSS. 146	180	IBM 84, 85	263	MICROSOFT (CPD) 69
10	ADV.SYS.CONCEPTS 478	94	COMPUTER IDEAS CORP. 480	181	ILLINOIS COMP.PROD. 468	264	MICROSTUF.INC. 159
452	ADVENT PRODUCTS 114	95	COMPUTER INNOVATIONS 429	182	IMPERIAL MICRO SPLY 480	265	MICROTECH EXPORTS 308
453	ADVENT PRODUCTS 114	96	COMPUTER MAIL ORDER 346, 347		INDEPENDENT BUS.SYS.INC. 83	266	MIKOS 160
12	AEGIS SYSTEMS 170	448	COMPUTER MAIL ORDER 288	185	INNOVATIVE SFTW.APPL. 172	267	MILLER MICROCOMP.SERV. 144
444	AFTERTHOUGHT ENG 256	97	COMPUTER PLUS 470	166	INNOVATIVE SFTW. 259	268	MINI COMP.SUPPLIERS 436
*	ALF PRODUCTS, INC. 134	98	COMPUTER RESOURCES 431	187	INT'L INST. OF APPLD.TECH 162	269	MINI MICRO MART 314
291	ALIEN GROUP 177	99	COMPUTER SHOPPER 414	188	INT'L INST. OF APPLD.TECH 162	270	MINI MICRO MART 467
13	ALPHA BYTE COMP.PROD. 38, 39	416	COMPUTER SHOPPER 474	169	INT'L MICRO SYS. 182	271	MORROW DESIGNS 11
14	ALPHA BYTE COMP.PROD. 311	101	COMPUTER SPCLTIES. 156, 157	190	INTEGRAL DATA SYS. 121	272	MORROW DESIGNS 209
17	ALPHA SOFTWARE 125	*	COMPUTER STOP, THE 301	191	INTEGRAND 302	273	MOUNTAIN COMPUTER 19
19	ALSPA COMP.SYS. 191	103	COMPUTER TOOLBOX, INC. 472	192	INTERACTIVE MICROWRE. 399	274	MOUNTAIN VIEW PRESS 275
20	ALTOS COMP.SYS. 232, 233	104	COMPUTER TOOLBOX, INC. 478	193	INTERACTIVE STRUCT. 45	275	MTI SYSTEMS CORP. 274
21	AMDEK CORP. 111		COMPUTER WRHSE. 155	194	INTERFACE INC. 306		MULTI LIST INC. 319
22	AMER.SMALL BUSN.COMP 227	105	COMPUTERS WHOLESALE 258	195	INTERTEC DATA SYS. 73	276	MULTITECH ELECTR.INC. 43
23	AMER.SQUARE COMP. 148, 149	106	COMPUTERTIME INC. 474	187	INTEX SYSTEMS 67	278	MUSYS CORP 316
24	ANDERSON JACOBSON 395	107	COMPUTERWORLD INT'L. 221	196	IPEX INT'L. 472	415	NATIONAL TECH SALES 384
25	ANSWER CORP. 126	108	COMPUVIEW PROD.INC. 74, 75	187	ISE 280, 261	277	NEBS 416
246	ANTEX DATA SYS. 242	109	CONCORD COMP.PROD. 118	198	ITHACA INTERSYSTEMS 8	278	NEC HOME ELECTR.USA 215
26	APPARAT INC 325	110	CONCURRENT CORP. 405	199	ITHACA INTERSYSTEMS 9	279	NEECO 341
27	APPLE COMPUTER INC 248, 249	111	CONSUMER COMP. 131	200	J.C.SYSTEMS 206		NETRONICS 469
28	APPLEWARE, INC. 474	112	CONSUMER COMP. 465	201	J.FISKE SFTW.SYS. 466	280	NETWORK CONSULTING CORP 142
29	APPLIED ANALYTICS 361	113	CONTEXT MANGMNT.SYS. 20	202	JADE COMP.PROD. 483	281	NEW GENERATION SYS. 150
30	ARCTEK INC. 468	114	CONTEXT MANGMNT.SYS. 21	203	JADE COMP.PROD. 484, 485	282	NORTH STAR COMPUTERS 110
449	ARCHILL OFFICE MACH 288	115	COPROCESSORS INC. 345	204	JAMECO ELECTR. 500, 501		OASIS SYSTEMS 214
31	ARCHIVE 253	116	COSMIC CONT'UNLTD. 466	205	JDR MICRODEVICES 488, 489	283	OLYMPIC SALES 132
32	ARTIFICIAL INT'L.RESRCH 466	117	COVER CRAFT 421	206	JDR MICRODEVICES 490, 491	284	OMEGA SALES 335
33	ASAP COMP.PROD.INC. 15	118	CPU SHOP, THE 471	207	JMSCOT, INC. 399	285	OMNITEC DATA 405
221	ASAP COMP.PROD.INC. 349	120	CROMEMCO 2, 1	209	KADAK PRODUCTS 285	286	ORANGE MICRO 130
35	ASC ASSOCIATES 466	121	CROMEMCO 2, 1	210	KIAI SYSTEMS 226	287	ORANGE MICRO 237
446	ASC COMP. SYS. 288	122	CUSTOM COMPS.SYS. 212, 213	211	KRAMER SYS INT'L. 376	288	ORXY SOFTWARE 158
36	ASHTON-TATE 94, 95		CYBERNETICS INC 289	212	KROWN COMPUTING 480	289	ORXY SOFTWARE 350
*	ASPEN SFTW.CO. 42	123	DATA ACCESS CORP 251	213	LABORATORY COMP.SYS. 466	290	OSBORNE COMPUTERS 29
37	ATARI 140, 225	*	DATA SOURCE SYS.CORP. 437	214	LABORATORY MICROSYS. 474	290	OSBORNE/MCGRAW-HILL 303
38	ATLANTIC CABINET CORP. 468	124	DATA-ED 122	215	LAXEN & HARRIS INC. 466	291	OWENS ASSOC. 22, 23
*	AUDIO-LIGHT INC. 36	125	DATA-RX INC. 436	216	LEADING EDGE PROD CIII	292	PACIFIC EXCHGS 466, 470, 474, 478, 480
40	AVOCET 310	126	DATAFACE 44	217	LEHMANN & ASSOC. 482		PALOMAR COMPEQUIP 486, 487
41	B&B ELECTR. 470	128	DATASOUTH COMP.CORP. 101	218	LEO ELECTRONICS 482	298	PAN AMERICAN ELEC INC. 427
42	BAUSCH & LOMB INSTR.SYS. 231	129	DATASOUTH COMP.CORP. 246	219	LNW RESEARCH 169	299	PANASONIC 89
43	BAUSCH & LOMB INSTR.SYS. 231	440	DAY STAR TECHNOLOGY 145	220	LOGICAL DEVICES 439		PC 2 78
44	BAY TECHNICAL ASSOC. 366	130	DAY STAR TECHNOLOGY 247	334	LOMAS DATA PRODUCTS 171		PERCOM DATA 7, 207
45	BBI MAIL ORDER 482	131	DEALIN' ELECTR. 474	222	LYBEN COMP.SYS. 468	300	PERIPHERALS UNLTD. 173
46	BEECH ENTERPRISES 474	132	DELTA PRODUCTS 18	223	LYBEN COMP.SYS. 472	301	PERISOFT INC. 419
*	BELL, JOHN ENGR. 477	133	DEVELOPMENT SYS.CO. 482	224	LYBEN COMP.SYS. 472	302	PERSONAL COMP.SYS 192
47	BILLINGS 109	134	DIGICOMP RESRCH CORP 262	225	LYBEN COMP.SYS. 476	303	PERSONAL COMPUTER AGE 229
48	BINARY CORP. 466	135	DIGITAL MARKETING 6	226	LYBEN COMP.SYS. 482	304	PERSONAL SYS.TECHN. 363
49	BISON PRODUCTS 187	136	DIGITAL MICROSYSTEMS 93	227	MACROTECH INT'L 16	305	PHASE ONE SYS.INC. 331
50	BISON PRODUCTS 187	137	DIGITAL RESEARCH 48, 49	228	MACROTRONICS 480	306	PHONE I, INC. 150
51	BISON PRODUCTS 187	*	DIGITAL RESEARCH COMP. 498, 499	229	MAGI 478	307	PI-TECH 10
52	BISON PRODUCTS 187	208	DIGITAL WORD SYS 482	230	MAGNOLIA MICROSYS. 476	308	PICKLES & TROUT 180
53	BISON PRODUCTS 187	139	DOKAY COMP.PROD.INC. 479	231	MARK OF THE UNICORN 235		POPULAR COMPUTING 257
458	BIT 3 319	140	DOWNTOWN BOOK BAZAAR 474		MARTIN MARIETTA CORP 398		POTOMAC MICRO-MAGIC 435
54	BLAT RESRCH & DEVELP. 415	141	DRAKE, R.L. CO. 366	232	MARYMAC INDUSTRIES 80	309	PRACTICAL PERIPH. 24, 25
55	BMC INTL 79	142	DREAM ELECTRONICS 468	233	MASTER COMPUTING INC. 46	425	PRIORITY ONE 174
56	BOTTOM LINE, THE 168	143	DUAL SYS.CONTROL CORP. 205	234	MAXTEK 397	426	PRIORITY ONE 175
57	BOTTOM LINE, THE 482	119	dy-4 SYSTEM 263	235	MBI 105	310	PRIORITY ONE 502, 503
58	BOWER-STEWART 470	144	DYMARC IND. 368		MBP SFTF.&SYS.TECH. 307	311	PRIORITY ONE 504, 505
60	BUSINESS SOLUTIONS 395	145	DYSAN CORP. 296, 297	236	MCGRAW-HILL BOOK CO. 272	312	PRIORITY ONE 506, 507
61	BYTE BOOKS 255	146	EARTH SCIENCE ASSOC. 480	237	MCGRAW-HILL BOOK CO. 287	430	PRIORITY ONE 322
427	BYTE BOOKS 270	147	ECONOMY PERIPHERALS 474	238	MCMILLAN BOOK CLUBS 321	432	PRIORITY ONE 390
62	BYTE BOOKS 279	148	ECOSOFT 427	237	MCP COMPUTER PROD. 468	313	PROCESSOR INTERFACES INC. 472
63	BYTE BOOKS 305	149	EDUCATIONAL MICROCOMP. 429	238	MEDIA DISTRIBUTING 269	314	PROFESSIONAL DATA SYS. 267
65	BYTE BOOKS 391	150	ELECTROLABS 464		MEDIAMIX 280	455	PROMPT-DOC 281
*	BYTE BACK ISSUES 254	151	ELECTRONIC SPCLISTS 435	239	MEMOREX MEDIA PROD. 151	316	PROTECTO ENTERPR. 476
*	BYTE SUBSCRIBER 433	152	ELECTRONIC SYS.FURN 202	240	MEMORY MERCHANT 161	317	PURCHASING AGENT, THE 26
66	BYTEK COMP. SYS. 395	153	ELLIS COMPUTING 403	241	MEMOTECH 179	319	QUALITY SOFTWARE 351
67	BYTEWRITER 268	154	EMERGING TECH.CONSLT. 134	242	MFJ ENTERPRISES INC 154	320	QUASAR DATA PROD.INC. 115
68	CALIF. DATA CORP 472	155	EMPIRICAL RESRCH GRP. 124	243	MICRO AGE COMP.STORE 123	321	QUES 195
*	CALIF. DIGITAL 494, 495	156	ENVIRONMENTAL CTRL SYS. 463	244	MICRO BUSINESS WORLD 219	322	QUEST ELECTR. 475
69	CDR SYSTEMS 470	157	EPIC COMP.CORP. 139	245	MICROCOM 358, 359	323	QUME CORP. 41
70	CENTENNIAL SOFTWARE 328	158	EPIC COMP.CORP. 414	246	MICROCOMP BUSN.INT'L. 322	324	R.C.ELECTRONICS 292
71	CENTRONICS 87	159	EPSON AMERICA 374, 375	454	MICRO COMPUTER DIST. 476	325	RACET COMPUTES 404
72	CHAPIN ASSOCIATES 472	160	ESSEX PUBLISHING 348		MICRO EXPRESS CO. 294	326	RADGO 397
73	CHECK-MATE 470, 476	161	EXPOTEK 82	248	MICRO FLASH 480	327	RADIO SHACK CIV
74	CHECKS-TO-GO 163	162	F.T.G.DATA SERV. 480	249	MICRO FOCUS 189	328	RADIX TECHNOLOGIES 141
75	CHIPS & DALE 472	163	FIRST SYSTEMS 327	423	MICRO LOGIC 482		RAINBOW COMP.INC. 206
76	CHRISLIN INDUSTRIES 333	164	FORETHOUGHT PRODUCTS 405	250	MICRO MAGAZINE 324	331	RANA SYSTEMS 30, 31
77	CHRISLIN INDUSTRIES 385	*	FOURTH DIMENSION 143	251	MICRO MANAGEMENT SYS. 286	332	RCE 344
78	CHROMANETICS CORP. 411	165	FRANKLIN COMP.CORP. 184, 185	252	MICRO MANAGEMENT SYS. 430	333	RED BARON COMP.PROD. 164, 165
79	COLONIAL DATA SERV. 40	166	FREDERICK COMP.PROD. 104		MICRO MFG SYS. 198	336	RENAISSANCE TECHN. 204
80	COLONIAL DATA SERV. 103	167	FUJITA, RICHARD & ASSOC 482	253	MICRO MINT 353	335	ROCKWELL INT'L. 285
81	COMMODORE BUSN.MACH. 135	168	G & G ENGINEERING 133	254	MICRO PRINTER MRKTG 181	337	RUPERT NEVE INC. 113
82	COMMUNICAL, INC. 100	169	G-H COMPUTER SYS. 470	255	MICRO PRO INT'L. 217	338	S C DIGITAL 266
83	COMMUNICATION CABLE 476	171	GENERAL SOFTWARE INC. 464	256	MICRO SCI 289		S-100 INC 376
84	COMMUNICATIONS ELECTR. 508	172	GNT AUTOMATIC INC 326		MICRO SYS.INC. 357	339	S.P.C.TECH.INC. 198
						340	SAGE COMP. TECH. 167
						341	SATURN SYSTEMS INC. 288
						342	SCIENTIFIC ENG. 470
						343	SCION CORP 5
							SCOTSDALE SYSTEMS 197
						344	SCR ELECTR. 472
						345	SEATTLE COMP PRODS 211
						346	SEATTLE COMP PRODS 313
						424	SEIKO-SHA CORP. 223
						347	SHAPE INC. 390
						348	SHARED SYS.TECHN. 222
						349	SIERRA DATA SCIENCES 37

To get further information on the products advertising in BYTE, fill out the reader service card with your name and address. Then circle the appropriate numbers for the advertisers you select from the list. Add an 18-cent stamp to the card, then drop it in the mail. Not only do you gain information, but our advertisers are encouraged to use the marketplace provided by BYTE. This helps us bring you a bigger BYTE. The index is provided as an additional service by the publisher, who assumes no liability for errors or omissions. *Correspond directly with company.

Reader Service

Inquiry No.	Page No.	Inquiry No.	Page No.	Inquiry No.	Page No.	Inquiry No.	Page No.
350	SIGMATEK 468	365	STROBE 239	382	TERMINALS TERRIFIC 278	398	WALLACE MICRO MART 401
351	SINCLAIR RESEARCH 199, 200, 201		SUBARU OF AMERICA 371	383	TEXAS COMP.SYS. 245	399	WARN ELECTRONICS 468
352	SKYLES ELECTRIC WORKS 476	366	SUBLOGIC 318		TINNEY,RBT.GRAPHICS 393	400	WASHINGTON COMP.SERV. 481
353	SLUDER 433	367	SUNNY INT'L. 463	384	TNW CORP. 120	401	WEST STAR MICRO 194
354	SOFTTECH CONSULTANTS 288	368	SUNTRONICS 478		TOPPERS 277	402	WESTWARE 32
355	SOFTWARE 478	369	SUPERSOFT 425	385	TRANSNET CORP. 431		WHITESMITHS LTD 240
356	SOFTWARE CONSLTG.SERV. 478	370	SYSTEM SOLUTIONS 480	386	TRAXX COMP.CORP. 119	403	WILD HARE COMP.SYS. 317
357	SOFTWARE DISTR. 377	371	SYSTEMS GROUP, THE 27	387	TRIANGLE MANAGEMENT 478	404	WINCHENDON GRP.,THE 476
358	SOFTWARE HOUSE,THE 329	372	SYSTEMS PLUS INC. 147	388	TRISTAR DATA SYS. 196	405	WINTEK CORP. 476
359	SOFTWARE PROD.INT'L. 117	373	TAB BOOKS 389	389	U.S. MICRO SALES 492	406	WINTERHALTER & ASSOC. 399
360	SOFTWARE SYS.TECH. 288	375	TARBELL ELECTR. 434	390	U.S. MICRO SALES 493	407	WRITE WRITER,THE 367
	SOLID STATE SALES 462	376	TECMAR INC 71	391	U.S. ROBOTICS 437	408	XAVAX CORP. 397
361	SOUTHERN COMP.SYS. 176	377	TECMAR INC 337	392	UNISOURCE ELECTR.INC 252	409	ZOBEX 203
422	SPECTRA MKTING 72		TEKTRONIX INC. 273	395	VIDEX 17		
362	STANDARD SFTW.CORP. 152	378	TELECON SYSTEMS 466		VISICORP INC. 193		
363	STATIC MEMORY SYS 309	379	TELETEK 99	396	VISTA COMPUTER CO 81		
436	STRAWBERRY TREE 304	380	TELEVIDEO INC 106, 107		VR DATA 343		
364	STREET ELECTR CORP 234	381	TERAK 315	397	VYNET CORP. 418		

*Correspond directly with company.

National Advertising Sales Representatives:

Northeast (617) 444-3946

ME, NH, VT, MA, CT, RI, DE, MD,
VA, WV, OK, TX, Upstate NY,
Eastern Canada

Hajar Associates
280 Hillside Ave.
Needham Heights, MA 02194

Mid Atlantic (201) 741-7744

NY, NYC, NJ, PA

Hajar Associates
321 Broad St.
Red Bank, NJ 07701

Southeast (305) 628-3525

NC, SC, GA, FL, AL, MS, TN, KY, LA

Hajar Associates
Diplomat Bldg.
5400 Diplomat Circle
Suite 272
Orlando, FL 32810

Midwest (312) 966-0160

MN, WI, MI, IA, IL, IN, OH,
MO, NE, KS, ND, SD, AR

Hajar Associates
5225 Old Orchard Rd.
Suite 50
Skokie, IL 60076

Northwest (415) 964-0706

AK, HI, WA, OR, ID, MT, WY,
Northern California, Nevada Except
Las Vegas, Western Canada

Hajar Associates
1000 Elwell Ct.
Suite 124
Palo Alto, CA 94303

Southwest (714) 540-3554

UT, CO, AZ, NM, Las Vegas,
Southern California

Hajar Associates
3303 Harbor Blvd.
Suite H-4A
Costa Mesa, CA 92626

European Advertising Sales Representatives:

Mr. Simon Smith
McGraw-Hill Publishing Co.
34 Dover St.
London W1X 3RA
England 1-493-1451

Mr. Andrew Karnig
Andrew Karnig & Associates
Kungsholmsgatan 10
112 27 Stockholm, Sweden
08/51-68-70

Mr. Hans Csokor
Publimedia
Relsnerstrasse 61
A-1037 Vienna, Austria

Mr. Fritz Krusebecker
McGraw-Hill Publishing Co.
Liebigstrasse 27C
D-6000 Frankfurt/Main 1
West Germany
72-01-81

Mr. Michael Sales
McGraw-Hill Publishing Co.
17 rue Georges Bizet
F 75116 Paris
France
720-33-42

Mr. Elio Gonzaga
McGraw-Hill Publishing Co.
Via Bracchini 1
20123 Milan, Italy
88-90-617

Mrs. Gurit Gepner
McGraw-Hill Publishing Co.
115 Yoseptal St.
Bat Yam, Israel
866-561

THE PROWRITER COMETH.

(And It Cometh On Like Gangbusters.)



Evolution.

It's inevitable. An eternal verity.

Just when you think you've got it knocked, and you're resting on your laurels, somebody comes along and makes a dinosaur out of you.

Witness what happened to the Centronics printer when the Epson MX-80 came along in 1981.

And now, witness what's happening to the MX-80 as the ProWriter cometh to be the foremost printer of the decade.

SPEED

MX-80: 80 cps, for 46 full lines per minute throughput.

PROWRITER: 120 cps, for 63 full lines per minute throughput.

GRAPHICS

MX-80: Block graphics standard, fine for things like bar graphs.

PROWRITER: High-resolution graphics features, fine for bar graphs, smooth curves, thin lines, intricate details, etc.

PRINTING

MX-80: Dot matrix business quality.

PROWRITER: Dot matrix correspondence quality, with incremental printing capability standard.

FEED

MX-80: Tractor feed standard; optional friction-feed kit for about \$75 extra.

PROWRITER: Both tractor and friction feed standard.

INTERFACE

MX-80: Parallel interface standard; optional serial interface for about \$75 extra.

PROWRITER: Parallel and serial interface standard.

PRICE

Heh, heh.

Distributed Exclusively by Leading Edge Products, Inc., 225 Turnpike Street, Canton, Massachusetts 02021. Call: toll-free 1-800-343-6833; or in Massachusetts call collect (617) 828-8150. Telex 951-624.

LEADING EDGE.

Circle 218 on Inquiry card.

Radio Shack's TRS-80® is Your Best Choice in a First Computer

Why? Because you can start with our \$999 Model III and easily—and economically—expand into a powerful, professional system!

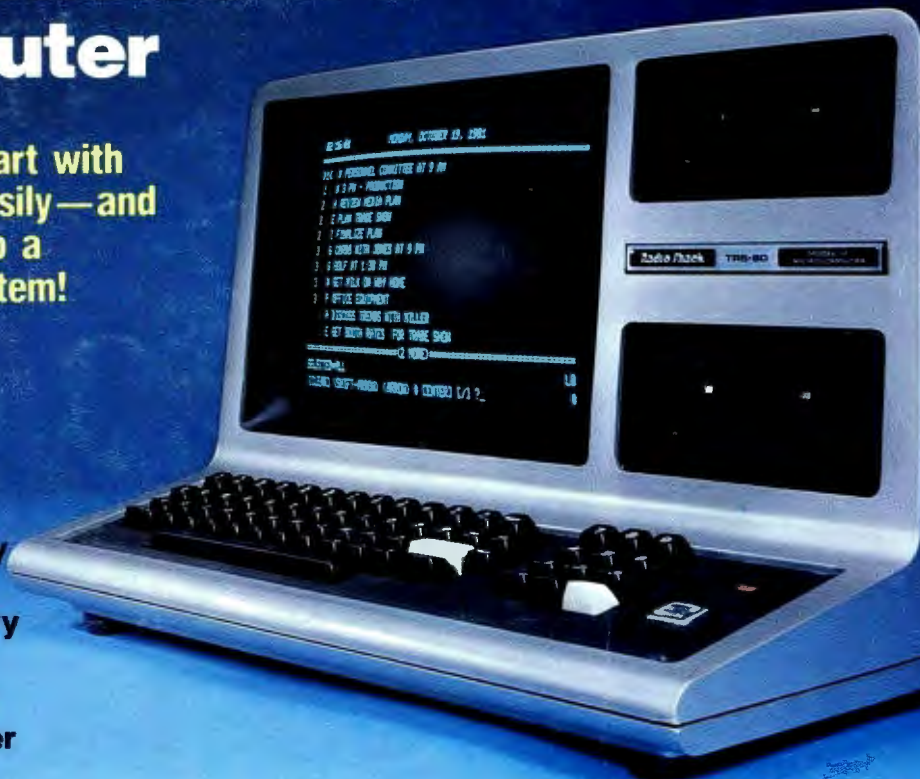

- Add Up to 4 Double-Density Disk Drives—2 Internally
- Go from 16K to 48K Memory
- Add RS-232-C Interface
- Or Get It All with Our \$2495 Model III Desktop Computer

A Radio Shack Model III is a versatile, self-contained computer that can grow with you. Whether you're a beginner or a pro, there's one that fits your budget and intended use. And features you'd expect to pay extra for are standard on Model III.

The built-in "extras". Our \$999 system includes: a 65-key keyboard with 12-key data pad, a 12" high-resolution monitor, and a parallel printer interface.

You get much more, including 16K memory, powerful Model III BASIC language, 500 and 1500 baud cassette operation, 16 lines of 64 or 32 upper and lower case characters, repeating keys, special graphics characters, program editor and real time clock.

Model III is ready for a wide range of professional and personal uses. Choose from our large library of user-proven programs or develop your own applications in easy-to-learn BASIC. Just add a cassette recorder to store and run programs and data. Cat. No. 26-1062. **\$999**

Choose our professional Model III Desktop Computer for more sophisticated applications. You get the same basic features as the smaller model, but with 48K internal memory, two built-in double-density mini disk drives for 368K of program and data storage and a built-in RS-232 Serial Interface to communicate with other computers using an optional telephone coupler, like our new Modem II (right). Our powerful disk operating system (TRSDOS) is included along with an expanded Disk BASIC language. And we have optional programming languages to meet specific needs—choose from COBOL, Assembler, Compiler BASIC and FORTRAN. And of course the smallest Model III can be upgraded to this top of the Model III line. Cat. No. 26-1066. **\$2495**

Get a "hands-on" demonstration of the TRS-80 Model III today at more than 240 Radio Shack Computer Centers and 6200 Radio Shack stores and participating dealers nationwide. Ask about our service and leasing plans, too.

NEW! Direct-Connect Modem II Automatically Dials and Answers Phone



Connects Directly to Phone Line And Any RS-232-Equipped TRS-80

Now your TRS-80 can access and transfer data by telephone. Program the Modem II to dial and answer, receive and transmit, even hang-up. 300 baud. FCC registered. Cat. No. 26-1173. **\$249**

Send me a free TRS-80 catalog.

Mail To: Radio Shack
Dept. 83-A-28
1300 One Tandy Center
Fort Worth, TX 76102

NAME _____
COMPANY _____
ADDRESS _____
CITY _____
STATE _____ ZIP _____

Retail prices may vary at individual stores and dealers.

Radio Shack®
The biggest name in little computers™
A DIVISION OF TANDY CORPORATION

Circle 327 on Inquiry card.