

BYTE[®]

the small systems journal

AUGUST 1982 Vol. 7, No. 8
\$2.95 in USA
\$3.50 in Canada/£1.85 in U.K.
A McGraw-Hill Publication



```
FULL SCREEN  
HIDETURTLE
```

```
MAKE :BIGUNIT 100  
BGSQ (2 # :BIGUNIT)
```

```
SETPROPS  
REPEAT :TIMES [MOVEBUG 1 MOVEBUG 2 MOVEBUG 3 MOVEBUG 4]  
END
```

Logo

Powerful.

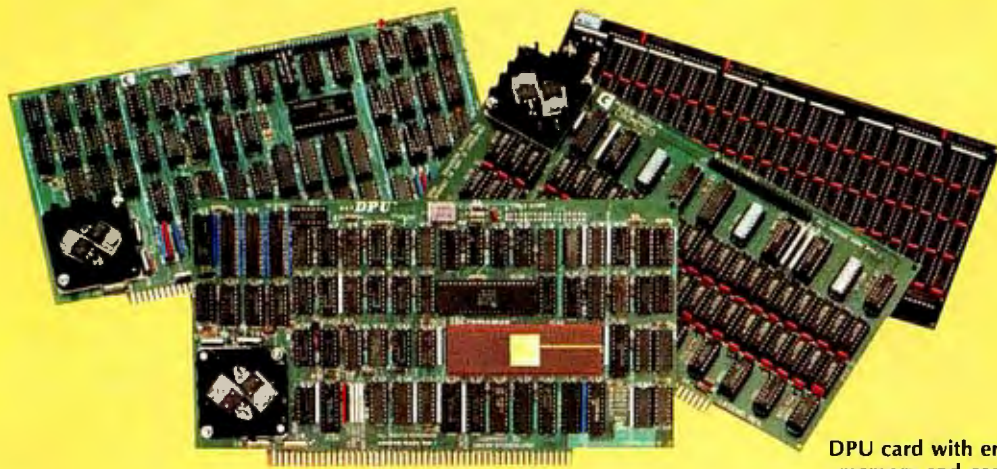

DPU card with error-correcting memory and controller cards

68000-Powered for tomorrow

Once again you get a big stride forward with Cromemco.

This time it's our new DPU Dual Processor Unit. It gives enormous power to Cromemco computer systems such as our System One shown here.

Compares with mainframes

With the new DPU you get the almost unbelievably powerful 68000 processor and its 32-bit data-handling capabilities combined with its **16 Megabyte** address space.

In other words with the System One/DPU combination you get a small machine that's the equal of superminis and mainframes in some areas.

8-Bit and 68000 software

The dual part of the DPU refers to its on-board Z-80A processor. With this you have access to existing CP/M* software.

But besides being compatible with this wealth of existing 8-bit software, the System One/DPU has available a whole family of new 68000 system software. This includes a wide range of high-level software such as our 68000 Assembler, FORTRAN 77, Pascal, BASIC, COBOL, and C.

Beyond all this there's a version for the 68000 of our widely admired CROMIX† Operating System. It's like UNIX‡ but has even more features and gives multi-tasking and multi-user capability. In fact, one or more users can run on the Z-80A processor while others are running on the 68000. Switching between the Z-80A and 68000 is automatically controlled.

The System One itself is a bus-oriented machine that has options for color graphics, for 390K or 780K of floppy storage, a 5 MB hard disk option, communications capability, and multi-processor capability using our I/O processor card.

Powerful new micro. Powerful software.



System One CS-1H

3715 Printer

3102 Terminal

Highly expandable

With the System One/DPU combination, you get tremendous expandability. Right now you can have up to 2 MB of RAM storage. You get this with our new Memory Storage cards and our Memory Controller. The Controller fully supports the 16 MB storage space of the 68000, allowing you vast future expansion capability.

Further, the memory has built-in **error detection and correction**, a feature normally found only in much more costly systems.

Present customers can field-upgrade their Cromemco systems to use the DPU and still be able to run their present software using the Z-80A on the DPU. It's one more

instance of Cromemco's policy of providing obsolescence insurance for Cromemco users.

Low priced

With all this performance you might not be ready for the low price we're talking about. With 256K of RAM and 780K of floppy storage, the price of the System One/DPU is only \$5495. That's hard to beat.

So contact your rep now. He'll fill you in on the many more features that this outstanding and powerful machine offers.

*CP/M is a trademark of Digital Research
†CROMIX is a trademark of Cromemco, Inc.
‡UNIX is a trademark of Bell Telephone Laboratories

 **Cromemco**TM
i n c o r p o r a t e d
280 BERNARDO AVE., MOUNTAIN VIEW, CA 94040 • (415) 964-7400
Tomorrow's computers today
Circle 124 on Inquiry card.

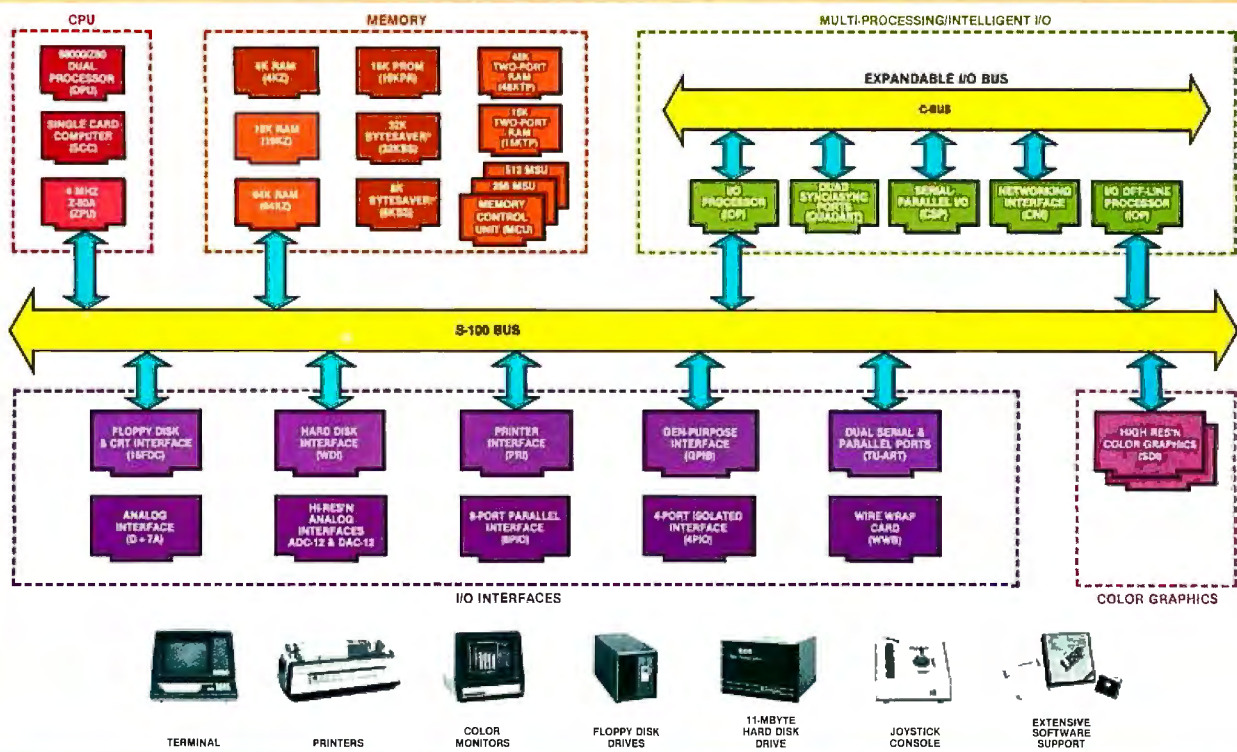

What Cromemco computer card capability can do for you

The above diagram shows in a functional way one of the most complete lines of computer cards in the industry.

Look it over carefully. It could be well worth your while.

These are all cards that plug into our S-100 bus microcomputers.

You can also assemble them into a custom system in convenient Cromemco card cages.

MULTI-PROCESSING AND INTELLIGENT I/O

The range of capabilities and versatility you can draw upon is enormous.

In processors, for example, you have a choice of CPU's including our extremely useful new I/O Processor. This can be used as a satellite processor to do off-line processing, multi-processing, and to form intelligent I/O. It opens the door to a whole new group of applications and tasks. Ask us about it.

HIGH RESOLUTION COLOR GRAPHICS

Again, you can have beautiful high-resolution color graphics with our color graphics interface. You can select from over 4000 colors and have a picture with a resolution at least equal to quality broadcast-TV pictures.



You have an unprecedented selection of memory including our unusual 48K and 16K two-port RAMs which allow high-speed color graphics.

LOTS OF STORAGE

These days you often want lots of disk storage. So you can select from our disk controller card which will operate our 5" and 8" floppy disk drives (up to 1.2 megabytes). Or select our WDI interface to operate our 11-megabyte hard disk drives.

POWERFUL SOFTWARE AND PERIPHERAL SUPPORT

There's much more yet you can do with our cards. And, of course, there's an easy way to put them to work in our 8-, 12-, and 21-slot card cages. Our PS8 power supply makes it simple to get the system into operation.

Finally, Cromemco offers you the strongest software support in the industry

with languages like FORTRAN, C, COBOL, ASSEMBLER, LISP, BASIC and others. There is also a wide choice from independent vendors.

To top it all off, you can draw from a substantial array of peripherals: terminals, printers, color monitors and disk drives.

There is even more capability than we're able to describe here.

NOW AT HALL-MARK AND KIERULFF

For your convenience Cromemco products are now available at Hall-Mark Electronics and Kierulff Electronics. Contact these national distributors for immediate product delivery.

CROMEMCO COMPUTER CARDS

- PROCESSORS — 4 MHz Z-80 A CPU, single card computer, I/O processor
- MEMORY — up to 64K including special 48K and 16K two-port RAMs and our very well known BYTESAVERS® with PROM programming capability
- HIGH RESOLUTION COLOR GRAPHICS — our SDI offers up to 754 x 482 pixel resolution.
- GENERAL PURPOSE INTERFACES—QUADART four-channel serial communications, TU-ART two-channel parallel and two-channel serial, 8PIO 8-port parallel, 4PIO 4-port isolated parallel, D+7A 7-channel D/A and A/D converter, printer interface, floppy disk controller with RS-232 interface and system diagnostics, wire-wrap and extender cards for your development work.



Cromemco™
I n c o r p o r a t e d

280 BERNARDO AVE., MOUNTAIN VIEW, CA 94040 • (415) 964-7400

Tomorrow's computers today

Circle 125 on inquiry card.

Features

57 High-Resolution Sprite-Oriented Color Graphics by Steve Ciarcia / You don't need Logo to use sprites for animation with the illusion of depth.

88 A Beginner's Guide to Logo by Harold Abelson / Although Logo is used as a language for introducing computers to children, it is not just for kids.

116 Logo in the Schools by Daniel Watt / Putting computers in the classroom has led to some unexpected results.

138 Designing Computer-Based Microworlds by R. W. Lawler / Well-written Logo procedures stimulate children's desire to learn by making complex ideas understandable and intrinsically interesting.

163 Why Logo? by Brian Harvey / Logo is designed to encourage development of problem-solving skills.

196 Introducing Logo to Children by Cynthia Solomon / Teaching Logo requires an awareness of different learning styles.

210 Logo—A Cultural Glossary by E. Paul Goldenberg / Common Logo terms are defined and their interrelationships are highlighted.

230 Logo for the Apple II, the TI-99/4A, and the TRS-80 Color Computer by Gregg Williams / Each version of Logo is best suited for a particular audience.

291 A General-Purpose I/O Board for the TRS-80 Models I and III by William Barden Jr. / The system bus is described, and plans are presented for an interface board with 24 lines of discrete input/output.

323 The Logo Journal, News and Views of the Logo Community—A collection of articles / Learning Physics from a Dynaturtle by Andrea A. diSessa and Barbara Y. White, 324; Logo Music by Jeanne Bamberger, 325; Leading Fish to Water by Dr. William Higginson, 328; Logo Project PROKOP by Heinz-Dieter Boecker and Gerhard Fischer, 329; The Group of the Turtle by Dr. Uri Leron, 330; The Lamplighter Project by Henry Gorman Jr., 331; Logo Research at Bank Street College by Jan Jewson and Roy D. Pea, 332; Young People's Logo Association by James H. Muller, 333; and Logo Update by Phil Lemmons, 334.

342 User's Column: Semidisk, Software Tools, the BDOS Blues, Power, and LISPs by Jerry Pournelle / A veteran computer user voices his opinions, bashed and unabashed.

Reviews

38 Program Generators by George Stewart

366 The Commodore 8032 Business System by Harold Dickerman

398 The Heath/Zenith Model 47 Dual Floppy-Disk Drive by Christopher O. Kern

408 Assisted Instructional Development System by George Wolfe

Nucleus

6 Editorial: Keeping Our Technological Edge

20 Letters

84 BYTE Game Contest: Winners and Rules for Contest #2

380 Technical Forum: Let the MC68701 Program Itself

416 Book Review: Software Design: Methods and Techniques

418 Ask BYTE

422 Software Received

426 BYTE's Bits

428 Clubs and Newsletters

430 Books Received

430 BYTE's Bugs

432 Event Queue

443 System Notes: Using the LOOKUP Function in Visicalc

446 BYTELINES

451 What's New?

509 Unclassified Ads

509 BOMB, BOMB Results

511 Reader Service



Page 57



Page 116



Page 138

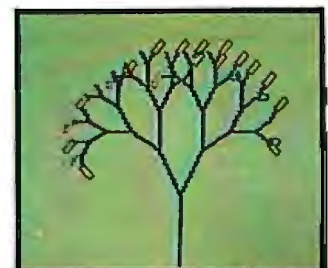

Page 230



Editor in Chief

Christopher P. Morgan

Managing Editor

Mark Haas

Technical Editors

Gregg Williams, Senior Editor;
Richard S. Shuford, Curtis P. Feigel,
George Stewart, Arthur Little,
Stanley Wszola, Pamela Clark, Richard Malloy;
Phillip Lemmons, West Coast Editor; Steve
Ciarcia, Mark Dahmke, Consulting Editors;
Jon Swanson, Drafting Editor

Copy Editors

Beverly Cronin, Chief;
Faith Hanson, Warren Williamson, Anthony J.
Lockwood, Hilary Selby Polk, Elizabeth Kepner,
Nancy Hayes, Cathryn Baskin; Margaret Cook,
Junior Copy Editor

Assistants

Faith Ferry, Debe Wheeler, Beverly Jackson

Production

David R. Anderson, Assoc. Director;
Patrice Scribner, Jan Muller, Virginia Reardon;
Sherry McCarthy, Chief Typographer;
Debi Fredericks, Donna Sweeney,
Valerie Horn

Advertising

Thomas Harvey, Director;
Marion Carlson, Rob Harnings, Deborah
Porter, Vicki Reynolds, Cathy A. R. Drew, Lisa
Wozmak; Jacqueline Earnshaw, Reader
Service Coordinator; Wai Chiu Li, Advertising/
Production Coordinator; Linda J. Sweeney

Circulation

Gregory Spitzfaden, Manager;
Andrew Jackson, Asst. Manager;
Agnes E. Pery, Barbara Varnum,
Louise Menegus, Pinky Krulis,
Sheila A. Bamford;
James Bingham, Dealer Sales;
Deborah J. Cadwell, Asst;
Linda Ryan

Marketing

Wilbur S. Watson, Marketing Coordinator;
Timothy W. Taussig, Marketing Production
Coordinator

Controller's Office

Daniel Rodrigues, Controller;
Mary E. Fluhr, Acct. & D/P Mgr.; Karen
Burgess, Jeanne Cilley, Linda Fluhr,
Vicki Bennett, L. Bradley Browne

Traffic

N. Scott Gagnon, Scott Jackson,
Kathleen Reckart

Receptionist

Jeanann Waters

Publishers

Virginia Londoner, Gordon R. Williamson;
John E. Hayes, Associate Publisher;
Cheryl A. Hurd, Michele P. Verville, Publisher's
Assistants;

Officers of McGraw-Hill Publications Company: Paul F. McPherson, President; Executive Vice Presidents: Daniel A. McMillan, III, Gene W. Simpson; Senior Vice President-Editorial: Ralph R. Schulz; Vice Presidents: Kemp Anderson, Business Systems Development; Harry L. Brown, Special Markets; Robert B. Doil, Circulation; James E. Hackett, Controller; Eric B. Herr, Planning and Development; H. John Sweger, Jr., Marketing.

Officers of the Corporation: Harold W. McGraw Jr., Chairman and Chief Executive Officer; Joseph L. Dionne, President and Chief Operating Officer; Robert N. Landes, Senior Vice President and Secretary; Ralph J. Webb, Treasurer.



In This Issue

Welcome to our annual language issue. This year we present Logo, the microcomputer language perhaps best known for its turtle graphics. Mathematically minded readers may recognize the cover illustration by Robert Tinney as BYTE's own version (influenced slightly by M.C. Escher) of the classic four-bug puzzle. In this puzzle, for which a Logo program is shown on the cover, four bugs are placed at each corner of a square; each bug attempts to walk toward the bug to its immediate right. In the process they trace Archimedean spirals. The object is to calculate the length of the spirals. The answer: each is equal to the length of one side of the original square. But Logo is more than turtles, and our articles will tell you what it's all about.

To get you started, Harold Abelson presents "A Beginner's Guide to Logo," Brian Harvey answers the question "Why Logo?," and E. Paul Goldenberg fills you in on the jargon with "Logo—A Cultural Glossary." Daniel Watt discusses "Logo in the Schools," and Cynthia Solomon describes "Introducing Logo to Children." R. W. Lawler explains one of the unique abilities of Logo in "Designing Computer-Based Microworlds."

Steve Ciarcia shows you how to build a graphics board for your Apple II computer using the Texas Instruments TMS9918A, and William Barden Jr. designs "A General-Purpose I/O Board for the TRS-80 Models I and III." Of course, we have Jerry Pournelle's User's Column and more.

BYTE is published monthly by BYTE Publications Inc, 70 Main St, Peterborough NH 0345B, phone (603) 924-9281, a wholly-owned subsidiary of McGraw-Hill, Inc. Office hours: Mon-Thur 8:30 AM - 4:30 PM, Friday 8:30 AM - Noon, Eastern Time. Address subscriptions, change of address, USPS Form 3579, and fulfillment questions to BYTE Subscriptions, POB 590, Martinsville NJ 08836. Second class postage paid at Peterborough, N.H. 0345B and additional mailing offices. USPS Publication No. 528890 (ISSN 0360-5280). Canadian second class registration number 9321. Subscriptions are \$19 for one year, \$34 for two years, and \$49 for three years in the USA and its possessions. In Canada and Mexico, \$21 for one year, \$38 for two years, \$55 for three years. \$43 for one year air delivery to Europe, \$35 surface delivery elsewhere. Air delivery to selected areas at additional rates upon request. Single copy price is \$2.95 in the USA and its possessions, \$3.50 in Canada and Mexico, \$4.50 in Europe, and \$5.00 elsewhere. Foreign subscriptions and sales should be remitted in United States funds drawn on a US bank. Printed in United States of America.

Address all editorial correspondence to the editor at BYTE, POB 372, Hancock NH 03449. Unacceptable manuscripts will be returned if accompanied by sufficient first class postage. Not responsible for lost manuscripts or photos. Opinions expressed by the authors are not necessarily those of BYTE. Entire contents copyright © 1982 by BYTE Publications Inc. All rights reserved. Where necessary, permission is granted by the copyright owner for libraries and others registered with the Copyright Clearance Center (CCC) to photocopy any article herein for the base fee of \$1.00 per copy of the article or item plus 25 cents per page. Payment should be sent directly to the CCC, 21 Congress St, Salem MA 01970. Copying done for other than personal or internal reference use without the permission of McGraw-Hill is prohibited. Requests for special permission or bulk orders should be addressed to the publisher.

BYTE® is available in microform from University Microfilms International, 300 N Zeeb Rd, Dept PR, Ann Arbor MI 48106 USA or 1B Bedford Row, Dept PR, London WC1R 4EJ England.

Subscription questions or problems should be addressed to:

BYTE Subscriber Service
P.O. Box 328
Hancock, NH 03449



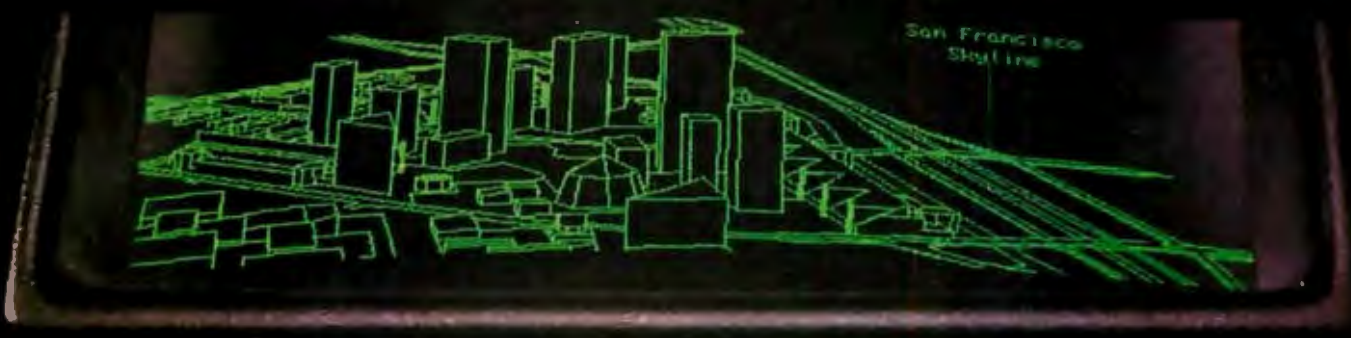

ADD QUALITY GRAPHICS For Just \$711.*

The OEM's best choice for graphics is MicroAngelo™, the single board graphics display computer from SCION. Install MicroAngelo in your Multibus or S-100 host and let this intelligent display processor bring your screen to life with full graphics and text. MicroAngelo features 512 by 480 pixel graphics and 40 line by 85 character text displays.

Save development time and overhead with SCREENWARE™, SCION's high level display firmware language. SCREENWARE provides point, vector, region, circle, flood, crosshair, light pen interface, tracking cross, screen load and dump, split screen, macro, and full terminal emulation commands. Use MicroAngelo both as your main console and as your application software's display screen.

MicroAngelo's on-board processor frees your host processor and bus to perform other tasks, while on-board memory and firmware reduce the size of your application programs. With our direct, easy interface to any high level language, you are no more than a simple sub-



routine call away from MicroAngelo's powerful capabilities. Use one MicroAngelo for monochrome graphics displays. And combine two or more MicroAngelos to create high resolution color graphics.

MicroAngelo is the OEM's choice because it is a powerful self-contained graphics display computer that is easy to add to your host. A graphics display computer that is proven reliable in over 1000 field installations. A graphics display computer that is so affordable you don't have to design your own.

Think SCION for your graphics display needs. Think MicroAngelo. Call us at (703) 476-6100.

*OEM quantity 25 price for Multibus or S-100 board.

SCION

if the image is important.

12310 Pinecrest Rd./Reston, VA 22091
(703) 476-6100 TWX: 710-833-0684

Circle 362 on inquiry card.

THINK AHEAD



THINK CP/M-86™

MILESTONE-86™—\$395. Manual alone — \$30.
 "Critical path" network analysis program for scheduling manpower, dollars and time to maximize productivity. Interactive project management program that runs under CP/M-86. MILESTONE can be used to track paper flow, build a computer, check a department's performance, or build a bridge. MILESTONE can be used by executives, engineers, managers, and small businessmen.

- Produce PERT chart in minutes.
- Find critical tasks that can't be delayed.
- Investigate tradeoffs between manpower, dollars and time.
- Give plans to others using a printed project schedule.
- Change details and immediately see results on the screen.
- Balance time, manpower and costs.

Formats: 8, 10W, IPC.

SUPERCALC-86™ — \$295.
 Allows a layman to manipulate data in a variety of forecasting and accounting applications. Combines the interactive nature of an electronic spreadsheet with the power and convenience of a simple simulation language. Video display can be scrolled over the entire worksheet using cursor controls. Symbolic vector references eliminate repetitive low-level data manipulation commands. Easy to use menu driven "help" command.
 Also available for IBM-DOS.
 Formats: 8, 10W, IPC.

DATEBOOK-86™—\$295. Manual alone—\$30.
 Schedule appointments for up to 27 different doctors, lawyers, rooms etc. Three appointment schedules are displayed on the screen at a time. File structure allows for appointments for up to one year in advance. Searches for openings that fit time of day, day of week and/or day of year constraints. Appointments made, modified or cancelled easily. Copies of day's appointments can be printed easily.
 Formats: 8, 10W, IPC

MORE SOFTWARE	PRODUCT/MANUAL	ALONE
CBASIC/86	\$325.	\$25.
PASCAL/M-86	\$495.	\$25.
Pascal/SORT-86	\$195.	\$20.
FIELD COMPANION-86	\$295.	\$30.
PERSONAL DATEBOOK	\$150.	\$30.
TEXTWRITER-86*	\$125.	\$30.

* Also available for IBM-DOS

FORMAT CODES: 8 (8" single density IBM soft-sector) 10W (IBM Display Writer with CP/M-86) IPC (IBM Personal Computer with CP/M-86)

SOFTWARE
 SOFTWARE
DIGITAL MARKETING
 DIGITAL MARKETING™



DIGITAL MARKETING CORPORATION

2670 CHERRY LANE • WALNUT CREEK • CALIFORNIA • 94596
 (415) 938-2880 • Telex 17-1852 (DIGMKTG WNCX)

Dealer Inquiries Invited

TRADEMARKS: CP/M-86, CBASIC/86 - Digital Research, Milestone, Datebook, Personal Datebook, Textwriter - Organic Software, Pascal/M - Sorcim, Pascal/SORT, Field Companion - Technical Software

Editorial

Keeping Our Technological Edge

by Chris Morgan, Editor in Chief

This month, as we do every August, we're devoting a portion of BYTE to a single computer language. This year's language is Logo, and we have dedicated this issue of BYTE to Seymour Papert, who developed the language.

We chose Logo this year for many reasons, but the most important is that the first computer language you learn has a lifelong effect on how you think, computerwise. Thus, the computer language we choose for use in the schools becomes vital. I believe, for reasons detailed in various articles in this issue, that Logo is a much better language to use for introducing children to computers than, say, BASIC.

Unfortunately, Dr. Papert recently left the United States, where he spent so many years advancing the state of the computer art. He now lives in France and has become the chief scientist of the newly formed World Computer Center. We wish him well, but the circumstances that led to his departure are both disturbing and encouraging. They are related to a potential crisis in American computer research and development today. Fortunately, there's still time to do something about the impending crisis. One way is through proposed legislation currently before Congress—I'll say more about that later.

I may sound alarmist in using the word "crisis" to describe the current state of affairs, especially when the mainframe and microcomputer industries are doing so well. But consider this: *three* of America's leading computer scientists have recently left the United States to be part of the World Computer Center under the leadership of Jean-Jacques Servan-Schreiber. In addition to Seymour Papert, they are Nicholas Negroponte, former Director of Computers and Communications at the Massachusetts Institute of Technology, who will become the new Director General of the Center, and Professor Raj Reddy, former director of the Robotics Institute at Carnegie-Mellon University.

The reason they left is simple. The French government had the foresight to see the need for and create a world computer center that will directly or indirectly benefit every world citizen. The United States lacked that foresight. As U.S. Rep. Albert Gore Jr. (D., Tenn.) said recently at a Washington briefing, "We have some serious thinking to do when scientists as distinguished as Nicholas Negroponte and Seymour Papert leave the United States in order to be part of the World Computer Center."



Introducing the **PERCOM** Alternative to **ATARI** Disk Storage

Your Atari 800 is the finest home computer on the market. Now you can own a floppy disk system that measures up — an RFD mini-disk storage system from Percom.

At Percom we've been making disk storage systems since 1977.

Our designs are proven, our quality is well known. And we back our dealers with service know-how. Expect more from Percom. You won't be disappointed.

- Operate in either single- or double-density storage mode using Atari DOS 2.0S. In double-density you can store almost 184 Kbytes (formatted) on one side of a 40-track diskette.
- Connect your Percom RFD first-drive system directly to your computer or connect into your system through your Atari 810 Disk Drive.
- Add an RFD first-drive system with its versatile four-drive controller, then connect as many as three more low-cost RFD add-on drives.
- Write application programs that can query and set up your system to operate a different type drive at each cable position — that can even change configuration as the program executes.
- Get quality and state-of-the-art capability at competitive prices. Percom first-drive RFD systems are priced from only \$799, first add-on drive is only \$459. Cables included.

Watch for announcement of a new, powerful, easy-to-use disk-operating system for your Percom-equipped Atari 800 computer.

Minimum system requirements — are an Atari 800 computer with 24-Kbytes of RAM and compatible video display system; Atari's disk-operating system (ver 2.0S) and owner's manual; and, for add-on drives (if used) an optional disk drives interconnecting cable available from Percom.

For the best thing next to your computer, see your Atari dealer about a Percom RFD floppy disk storage system. For the name of your nearest dealer, call Percom toll-free 1-800-527-1222.

PERCOM

PERCOM DATA COMPANY, INC.
11220 PAGEMILL RD. • DALLAS, TX 75243 • (214) 340-7081

ATARI 800 & ATARI 810 are trademarks of the Atari Corporation.
PERCOM is a trademark of Percom Data Company, Inc.

PRICES AND SPECIFICATIONS
SUBJECT TO CHANGE
WITHOUT NOTICE.

Yes ... I'd like to know more about Percom RFD disk drives for my Atari 800 Computer. Rush me free literature.

Send to: PERCOM DATA COMPANY, Inc., DEPT 18-B01
11220 Pagemill Road, Dallas, Texas 75243

name _____
street _____
city _____ state _____
zip _____ phone number _____
I plan to add a hard disk system to my Atari: yes no.
MAIL TODAY!

Wizard-SOB™

SERIAL OUTPUT BUFFER CARD

Input a new task while your old task prints out

NO MORE DELAY FOR SLOW PRINTERS

WIZARD-SOB is a serial printer interface that lets you operate your Apple while data from your previous operation is printing out. It ends waiting while your printer prints. The WIZARD-SOB contains a 16K byte "character buffer" that may be expanded to 32K bytes of character buffering. It accepts data at the Apple's rapid transfer rate, stores the data and feeds it to your printer at the rate the printer can accept.

- Fully compatible with all Apple II and Apple II Plus* computers
- Fully compatible with most

- Apple software including Applesoft BASIC*, Integer BASIC*, CP/M, Pascal, etc.
- Fully compatible with most Apple II expansion boards.
- Low power consumption for cool reliable operation
- Leads soldered directly into board for reliable operation
- Many formatting features.
- Two-year factory replacement warranty
- RS-232 printer interface compatible

Backed by the world's #1 independent manufacturer of peripheral controllers

Available at all fine Computer Stores \$249.00
Telephone (800) 854-8737
(714) 850-1666

 **WESPER MICRO Systems™**

SUBSIDIARY OF WESPERCORP

*Registered Trademark of Apple Computers, Inc.



Editorial

At that same Washington briefing Jean-Jacques Servan-Schreiber showed, in a speech by turns stimulating and troubling, just how fragile our significant technological advantage in the computer field is. For example, the Japanese have made inroads into the jet engine market. Three years ago they entered into a joint venture with the ailing British Rolls-Royce jet engine division that significantly improved the company's financial position. Again and again we hear stories of Japanese companies dominating technologies pioneered in America: liquid crystals, for example, are now made almost exclusively in Japan. The same tenacity the Japanese have shown in the automobile, camera, stereo, and ship-building fields is now being directed at the personal-computing industry, and while I am not immediately concerned about a possible Japanese "threat" for reasons I detailed in my May 1982 editorial, we must still be aware of the precariousness of our position.

The World Computer Center

The World Computer Center is a new, ambitious effort to put computer power in the hands of the people. Among the Center's proposals is a project to install a personal computer in each of 500 villages (mostly in the Third World, although some sites are in developed nations including the United States). Servan-Schreiber, the Center's director, lobbied long and hard in France to short-circuit the (as Negroponte puts it) "Byzantine" maze of French bureaucracy and create the World Computer Center in Paris that has, in one sweeping gesture,

EMPLOYMENT BY THE INFORMATION SECTOR

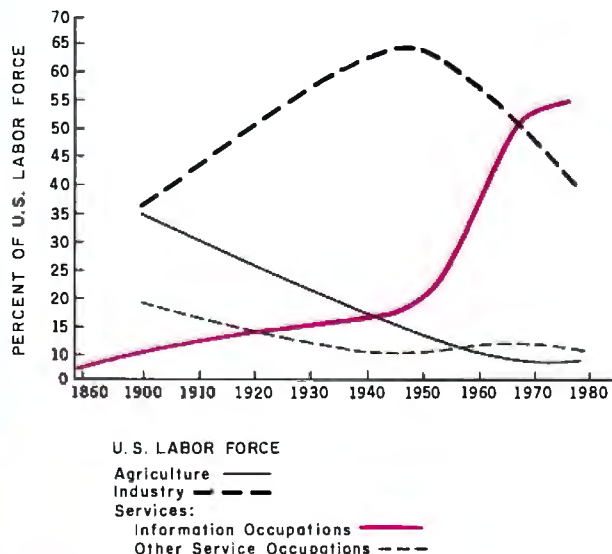
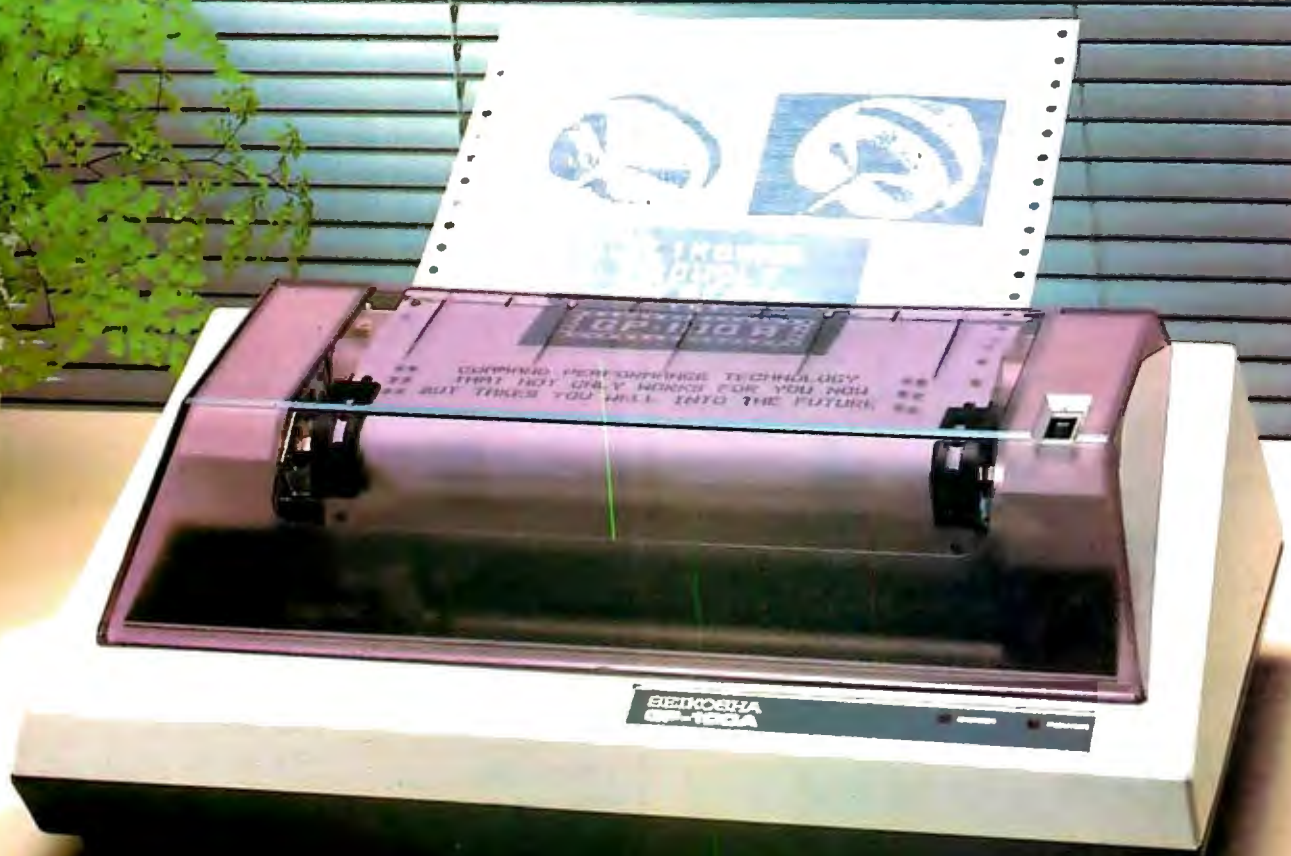

Figure 1: The percentage of U.S. workers in service-related industries has been increasing steadily since 1860, with the most dramatic increase beginning in the 1950s. (Figures 1, 2, and 3 courtesy of Congressional Committee on House Administration.)

SEIKOSHA
GP-100A



GP-100A: US\$389

COMMAND PERFORMANCE.

Seikosha gives you all the best features—including economy and super-clear graphics.

Unlike some graphic printers, Seikosha's new GP-100A Uni-Hammer Graphic Printer puts full dot addressable graphics at your command. The GP-100A lets you repeat a column of data as many times as needed with just one command. Software control enables double-width character output, and the positioning is both character and dot addressable. Designed for simple operation, it ranks among the most cost-efficient graphic printers on the market. Command performance technology that not only works for you now, but takes you well into the future.

Other valuable features:

- Graphics, regular and double width character modes can be intermixed on the same line.
- Automatic printing. When the text exceeds the maximum line length, there is no loss of data due to overflow.
- Self-test printing is a standard feature.
- Centronics type parallel interface.
- Paper width is adjustable up to 10 inches.
- Optional Interface: RS232C, IEEE488, apple II, etc

Graphic Printer **GP** Series

Available at COMPUTERLAND and other fine stores in your area

Distributed by **AXIOM CORPORATION** 1014 Griswold Avenue San Fernando, Calif. 91340 Phone (213) 365-9521 TWX (910) 496-1746
Manufactured by **SEIKOSHA SYSTEM EQUIPMENT DIV.** 4-1-1 Taihei Sumida-ku Tokyo Japan. Phone: 03-623-8111 Telex: 262-2620
Circle 366 on Inquiry card.

1982 VERSION IFR SIMULATOR Apple II Plus DOS 3.3

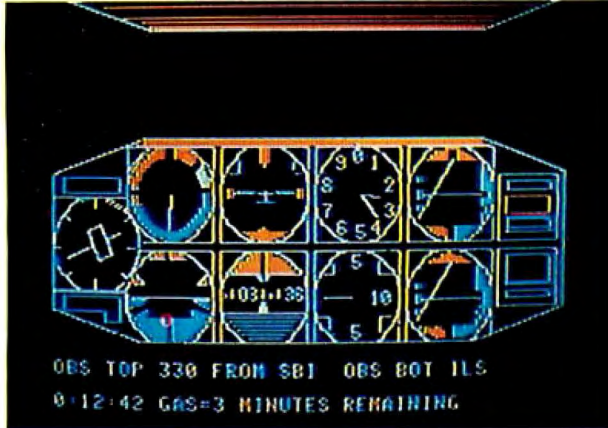

Features a lifelike panel that simulates the airplane instruments that are used for flying and navigating in clouds. FLY IFR LANDINGS, PATTERNS, and CROSS COUNTRY in several areas of The United States. \$50.00 at your computer store or direct from:

PROGRAMMERS SOFTWARE
2110 N.2nd St.
Cabot Arkansas 72023
(501) 843-2988

Editorial

PERCENTAGE OF WORK FORCE
IN INFORMATION-RELATED EMPLOYMENT

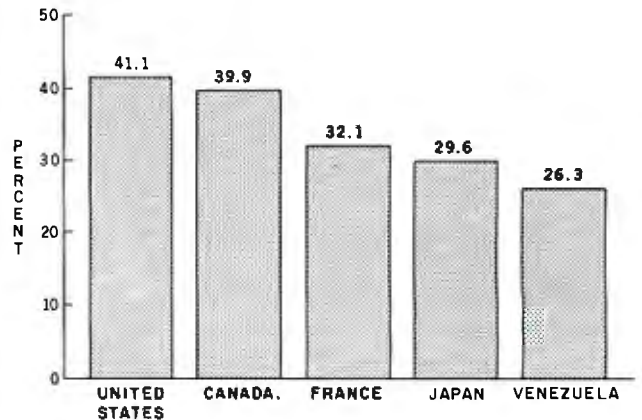

Figure 2: With 41.4 percent of its work force engaged in information-related employment, the U.S. is the leader of the five nations represented in the graph.

provided Negroponte with twice the resources and manpower he had at MIT, which had taken 15 years to build up to its current status.

The World Computer Center has the right idea. Take a look at figure 1. It shows the astonishing growth in the percentage of U.S. workers in service-related jobs from 1860 to 1980. Figure 2 shows the current percentages of work forces in information-related jobs by country. Surprisingly, countries like Venezuela, not normally regarded as technologically advanced, already have sizable work forces in the information field.

Servan-Schreiber takes the somewhat radical view that, in several years, human beings will no longer work the production lines. All such work, he believes, will be done by robots and machines. Therefore, he warns, people will have to learn to be processors of information. Whether or not you subscribe to this view, the trend is undeniable. Robots are attractive in many ways, not the least of which is their cost of operation. Figure 3 indicates that robots currently cost less than human workers to "employ." It's obvious to me that we must all become computer literate to survive in the future world. Yet our government is doing virtually nothing to ensure that survival.

Some Legislative Answers

One answer to the dilemma is government subsidy and encouragement of computer-literacy programs. Practically speaking, this means that personal computers must get into homes and schools. Two bills currently before Congress seek to provide financial incentives for computer manufacturers, businesses, and schools to increase their commitment to computer-literacy goals.

One of the bills, which has received a good bit of publicity, can be credited to the foresight of Steve Jobs, chairman of the board of Apple Computer Inc. The

SLUDER FOR SOFTWARE, S-100 BOARDS, FAST 6 to 10 MHz SYSTEMS, Terminals & Printers. WE INTEGRATE SYSTEMS WITH S-100 BOARDS FROM:

CompuPro™ division **GOOBOUT** ELECTRONICS

LOMAS DATA PRODUCTS
Seattle Computer Products, Inc.

6MHZ CPU Z BUDGET 5Y5 64K, (2)8"DR5, CP/M(TM)80 \$2795.
6MHZ 85/88 BUDGET 5Y5 64K, (2)8"DR5, CP/M 80 2795.
7MHZ 85/88 LUXURY 5Y5 64K, (2)8"D5 DR5, CSC CP/M 4025.
LOMAS 10MHZ 8086, 128K, (2)8"DR5, CP/M86, 2 SERIAL 3195.
MPM86 2 USER, 256K, 8086, 8089, (2)8"DR5, MPM86(TM) 4190.
SEATTLE 8086, 64K, DD CONTR, M5D05, (2)8"DR5 10 SLOT 3195.
SEATTLE SYSTEM I 64K \$2459. SEATTLE 5Y5 II 128K 3135.
Z80A 56C SYSTEM W/64K, (2)8"DR5, CP/M80 2195.
SLAVE PROCESSORS AVAILABLE FOR Z80A SYSTEM ABOVE

MORROW DESIGNS

MICRO DECISION 1 1 DR \$ 949. MICRO 2 DRIVE 1225.
DJ DMA W/CP/M \$366. 65K RAM \$404. MULTI I/O 276.
GOOBOUT DISK 1 A&T 371. DISK II W/CP/M 596.
LOMAS LIGHTING 1 10MHZ 520. SEATTLE RAM+192K IBM 599.
CP/M & MPM ARE TRADEMARKS OF DIGITAL RESEARCH OF CALIF.
P.O. BOX 951 WESTMINSTER, CA 92683-0951 (714) 895-1746

SuperBrain II™



Summa Cum Laude!

Just three years ago, Intertec stunned the microcomputer industry when its SuperBrain™ desktop computer graduated with honors . . . outperforming all the others by achieving the best price/performance ratio in its class. Today, that scholastic achievement remains unchallenged. At least until now. . .

Announcing SuperBrain II™ . . . our latest microcomputer marvel that's destined to be the "Most Likely to Succeed" in the Class of '82. With thousands of SuperBrains in use worldwide, it's no surprise that SuperBrain II users have given our new model the **highest** honors yet. Standard features include a powerful 64K of internal memory, a CP/M* operating system, a 24 line × 80 column display on a 12-inch non-glare screen, a full-featured ASCII keypad with operator convenience keys, twin Z80 processors and dual RS-232 communications and printer ports. But SuperBrain II outsmarts its Class of '79 counterpart by

offering *leaner* pricing, *more* features and *better* overall system performance. New SuperBrain II features include a faster, enhanced disk operating system, a library of new visual attributes including reverse video, below-the-line descenders and impressive graphics capabilities *and* Microsoft® BASIC — all included at absolutely no extra cost!

SuperBrain II's internal circuitry has also been completely redesigned and is now computer tested to ensure optimum field reliability. Plus, there are four new SuperBrain II models from which to choose, offering disk storage capacities from 350K bytes to 10 megabytes! But, best of all, prices start as low as \$2,495, including software!

Of all the single-user microcomputers available today, our SuperBrain II is certainly in a class by itself. Not only does it outprice *and* outperform its competitive classmates, it's also backed by our comprehensive customer protection

programs — depot maintenance, extended warranties, a satisfaction guarantee and a factory sponsored users group. All in all, the SuperBrain II™ represents the most incredible microcomputer value we've ever seen (or probably ever will see) in a long, long time.

Contact your local dealer or call or write us at the address below for more information on our full line of single and multi-user microcomputers. Ask for our SuperBrain II "Buyers Guide" and find out why so many microcomputer buyers who insist on quality and value . . . insist on Intertec.



2300 Broad River Rd. Columbia, SC 29210
(803) 798-9100 TWX: 810-666-2115

Circle 460 on Inquiry card.

MICROPRO

WordStar®

The number one selling microcomputer word processing package in the world.

8" CP/M®

LIST PRICE: 495.00

MH PRICE: 289.00

5 1/4" APPLE®

LIST PRICE: 375.00

MH PRICE: 234.00

MICROPRO

MailMerge™

A multi-purpose text-data merging program. One of its most popular uses is producing personalized form letters. Requires WORDSTAR®

8" CP/M®

LIST PRICE: 150.00

MH PRICE: 99.00

5 1/4" APPLE®

LIST PRICE: 125.00

MH PRICE: 83.00

MAILMERGE, DATASTAR, SPELLSTAR, CALCSTAR, and SUPERSORT are trademarks of MicroPro International, San Rafael, California USA. QUICKCODE, QUICKSCREEN, and dUTIL are trademarks of Fox & Geller Associates. VISITREND/VISIPLOT, VISIFILE, VISISCHEDULE, VISIDEX, VISITERM, and DESKTOP PLAN are trademarks of VisiCorp. dBASE II is a trademark of Ashton-Tate. MATHSTAR is a trademark of Force Two, LTD. SUPERCALC is a trademark of Sorcim. SPELLGUARD is a trademark of Innovative Software Applications. T.I.M. is a trademark of Innovative Software, Inc. CROSSTALK is a trademark of MicroStuf. EASY WRITER and EASY SPELLER are trademarks of Information Unlimited Software. PERFECT WRITER and PERFECT SPELLER are trademarks of Perfect Software, Inc. WORDSTAR is a registered trademark of MicroPro International, San Rafael, California USA. VISICALC is a registered trademark of VisiCorp. CP/M is a registered trademark of Digital Research. APPLE is a registered trademark of Apple Computers. IBM is a registered trademark of International Business Machines.

MICROPRO

DataStar™

The office-oriented system for data entry, retrieval, and updating. DATASTAR allows you to create a form, be it a price list, catalog, or order form. You can edit, update, or save this information in a file or simply print it out. DATASTAR interfaces with MAILMERGE and SUPERSORT.

8" CP/M

LIST PRICE: 350.00

MH PRICE: 235.00

5 1/4" APPLE®

LIST PRICE: 295.00

MH PRICE: 199.00

MICROPRO

CalcStar™

Financial planning and business decision-making made simpler, faster, and more accurate. CALCSTAR calculates solutions to complex numerical problems in business and finance. CALCSTAR turns your microcomputer's video screen into a 'window' on a gigantic electronic ledger sheet with up to 600 entries arranged the way you want.

8" CP/M®

LIST PRICE: 295.00

MH PRICE: 199.00

5 1/4" APPLE®

LIST PRICE: 195.00

MH PRICE: 149.00

FORCE TWO, LTD.

MathStar™

MATHSTAR is a combination adding machine/calculator program, designed specifically for use with MicroPro's WORDSTAR®. Provides basic math functions, formatted results, and accounting notation.

8" CP/M®

LIST PRICE: 125.00

MH PRICE: 99.00

5 1/4" APPLE®

Same as 8" CP/M®

ASHTON-TATE

dBASE II™

THE database management system for the microcomputer.

8" CP/M®

LIST PRICE: 700.00

MH PRICE: 489.00

5 1/4" APPLE®

Same as 8" CP/M®

FOX & GELLER

QuickCode™

QUICKCODE allows dBASE II users to create the following programs, in a matter of seconds, without programming.

- Data entry programs
- Data retrieval programs
- Date edit/validation programs
- Menus
- dBASE II files

PLUS: 4 New Data Types:

- Date
- Dollars
- Telephone
- Social Security number

QUICKCODE includes a powerful new version of QUICKSCREEN, the dBASE II screen builder.

8" CP/M®

LIST PRICE: 295.00

MH PRICE: 249.00

5 1/4" APPLE®

Same as 8" CP/M®

FOX & GELLER

dUTIL™

dUTIL is the dBASE II utility program which saves valuable computer time and work by:

- Increasing command file running time
- Creating standard text files to use within your word processor
- Automatically debugging dBASE II command files

dUTIL does not require QUICKCODE or QUICKSCREEN.

8" CP/M®

LIST PRICE: 99.00

MH PRICE: 75.00

5 1/4" APPLE®

Same as 8" CP/M®

Call Toll-Free: 1-800-523-9511

In Pennsylvania: 1-215-868-8219

The Software:

PACKAGES

	CP/M®		APPLE®	
	COMBINED LIST PRICE:	MICROHOUSE PRICE	COMBINED LIST PRICE:	MICROHOUSE PRICE
MH-1 WORDSTAR® /MAILMERGE	645.00	319.00	500.00	259.00
MH-2 WORDSTAR® /MAILMERGE/DATASTAR	995.00	519.00	795.00	399.00
MH-3 WORDSTAR® /CALCSTAR	790.00	419.00	570.00	299.00
MH-4 WORDSTAR® /MATHSTAR	620.00	369.00	500.00	319.00
MH-5 dBASE II/WORDSTAR® /MAILMERGE	1345.00	819.00	1200.00	719.00
MH-6 dBASE II/QUICKCODE/ WORDSTAR® /MAILMERGE	1640.00	999.00	1495.00	899.00
MH-7 dBASE II/QUICKCODE/dUTIL	1070.00	749.00	1070.00	749.00

NEW: The IBM®-PC Software Menu.

MICROPRO

WordStar®	289.00
MailMerge	99.00
SpellStar	149.00
DataStar	199.00
SuperSort	170.00
CalcStar	199.00

VISICORP

VisiCalc®	190.00
VisiTrend/VisiPlot	228.00
VisiFile	169.00
VisiPlot	179.00
VisiSchedule	249.00
VisiDex	190.00
VisiTerm	80.00
Desktop Plan	190.00

IUS

Easy Writer II	299.00
Easy Speller	149.00

PERFECT

Perfect Writer	289.00
Perfect Speller	149.00

SORCIM

SuperCalc	209.00
-----------------	---------------

ISA

SpellGuard	249.00
------------------	---------------

ISI

T.I.M.	399.00
-------------	---------------

MICROSTUF

CrossTalk	119.00
-----------------	---------------

ASHTON-TATE

dBASE II	CALL
----------------	-------------

MICROHOUSE™

The Microcomputer People.™



MuSYS gives S-100 the best in networks... with TurboDOS*

With CP/M* compatible TurboDOS and MuSYS network slave boards you can turn any Z80-based, S-100 system into a superior multi-processor, multi-user network.

TurboDOS is faster than CP/M for system functions. TurboDOS supports larger files (134 MB) and disks (1048 MB) and, unlike CP/NET*, it's compatible with nearly all 2.2 applications software. Many features which are optional, extra cost or not available at all in CP/M are standard with TurboDOS. Add a MuSYS NET/82* and you've got a complete, hardware isolated network slave including Z80A CPU, two serial ports and many other advanced features. For special applications an additional bank of 64K memory is available.

Expand your S-100 system economically with MuSYS now! Ask for all the facts on TurboDOS and our expanding line of network slave boards. (Generous quantity/dealer discounts available.)

*TurboDOS is a trademark of Software 2000, Inc. CP/M and CP/NET are trademarks of Digital Research, Inc. NET/82 is a trademark of MuSYS Corp.

MuSYS
CORP
Specialists in Multi-user Microsystems

1451 Irvine Blvd., Suite 11
Tustin, CA 92680
(714) 730-5692
TWX: 910-595-1967
CABLE: MUSYSTSTN

Circle 292 on inquiry card.

Editorial

INDUSTRIAL OCCUPATIONS
HOURLY WAGES
1979

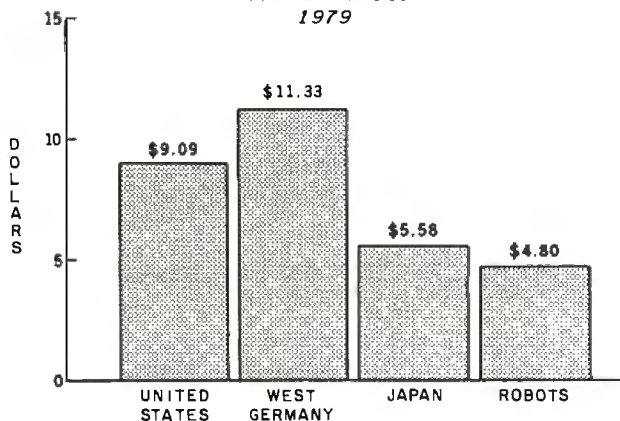

Figure 3: This chart indicates that at \$4.80 an hour robots cost less to employ than their human counterparts in the U.S., West Germany, and Japan (1979 figures).

Technology Education Act of 1982 (HR5573 and S2281) was introduced by U.S. Rep. Pete Stark, a California Democrat. Its terms are simple: for a period of one year, computer manufacturers would be allowed to receive an increased deduction for donating computers to schools.

Built-in safeguards will assure that all manufacturers receive equal benefits. For instance, each manufacturer could give only one computer to a school. This would prevent any attempt to overpower the schools. And the computers must be state of the art. To prevent the dumping of obsolete equipment, manufacturers could not donate equipment that has been in inventory for more than two years. The manufacturer's deduction would increase from the current 50 percent of manufacturer's cost to the cost plus one half of its markup, not to exceed 75 percent of the list price. This is hardly a radical bill. Another bill currently on the books allows computer companies the same increased deduction for research equipment donated to universities. To my mind, HR5573 is a logical and much needed extension of the existing bill. I applaud Steve Jobs's willingness to push computer manufacturers into action.

The other bill, The Family Opportunity Act (HR6397), was recently introduced by U.S. Rep. Newt Gingrich, a Republican from Georgia. The Family Opportunity Act would offer a \$100 per year, per family member, tax credit for up to 50 percent of the cost of a home-computer hardware or software system, with five years to write off the investment. With this bill, a family of four could buy a \$4000 system and, over five years, take \$2000 in tax credits.

"I want every American to have access to the same opportunities that computers provide for General Electric and AT&T," Gingrich says. "That's why working Americans should have the same kinds of tax breaks corporations get automatically."

New from HIPLØT™

multi-pen plotting for as little as \$1480*.



FCC class B tested.
UL listed.

the Houston way

The new HIPLØT DMP Series 6-pen option makes high performance multi-pen plotting affordable. It's available on the DMP 2, 3, and 4 models in the HIPLØT family so you can enjoy the advantages of multi-colored plots on 8½" × 11" (DIN A4) surfaces. Of course, you also get the standard HIPLØT range of capabilities such as intelligence, controls, interfaces and resolutions. There's a model for virtually every plotting application.

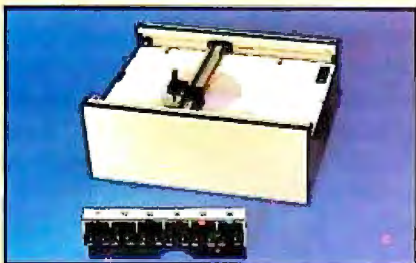

Big Performance in a Small Plotter
Since its introduction, the HIPLØT DMP Series has been recognized as the innovative plotter

line which made low-cost, high performance digital plotting a reality.



Now, with our new 6-pen option, there's an exciting new dimension in the DMP Series' versatility. Imagine two standard models with RS-232-C and parallel interfaces, four intelligent models with RS-232-C or Centronics® compatible interfaces, a choice of controls, resolutions, and pen speeds. Add to this the ability to plot with 6-pens on paper, vellum or mylar (ideal for overhead projectors) and you have the ultimate plotter price/performance combination — the perfect choice for the user or OEM.

8-Pen Models Also Available.

If you need a little more capability, take a look at our new 8-pen option. It's available on the DMP 5, 6, and 7 so you can have 8-pen multi-colored plots on 11" × 17" (DIN-A3) surfaces.

Why wait? Let us send you complete information on this breakthrough in affordable, multi-pen plotting. Contact Houston Instrument, P.O. Box 15720, Austin, Texas 78761. (512) 835-0900. For rush literature requests, outside Texas, call toll free 1-800-531-5205. For technical information ask for operator #5. In Europe contact Houston Instrument, Rochesterlaan 6, 8240 Gistel, Belgium. Phone 059/27-74-45.

INSTRUMENTS & SYSTEMS DIVISION
Together...we'll create tomorrow.

BAUSCH & LOMB 

™ Trademark of Houston Instrument.
* U.S. Suggested retail prices.
Centronics® registered trademark of
Centronics Data Computer Corp.
Circle 43 on Inquiry card.

CP/M® and IBM SOFTWARE

90-DAY MONEY BACK GUARANTEE

dBASE II \$CALL QUICKCODE \$229.00

TOLL-FREE HELP LINE STAFFED BY EXPERIENCED dBASE II PROGRAMMERS.

IBM PERSONAL SOFTWARE

WORDSTAR	279.00
MAILMERGE	89.00
CROSTALK	129.00
EASYSPELLER	139.00
EASYWRITER II	289.00
TIM III	399.00
SPELLGUARD	239.00

IN STOCK—MORE ITEMS TO COME!

ACCOUNTING PLUS®

General Ledger	
Accounts Payable	
Accounts Receivable	
Payroll	
Inventory	
Sales Order Entry	
Purchase Order Entry	
Point of Sale	
1 MODULE	\$ 400
2 MODULES	750
3 MODULES	1109
4 MODULES	1465
5 MODULES	1820
6 MODULES	2140
7 MODULES	2440
8 MODULES	2720

DIGITAL RESEARCH®

MAC	85
SID	65
ZSID	90
TEX	90
DESPPOOL	45
PL/1-80	449
BT-80	175
PASCAL MT+	425
CB-80	419
CBASIC 2	110

FOX & GELLER®

Quickscreen	139
dUTIL	69

LEXISOFT®

Spellbinder	299
-------------	-----

LIFEBOAT®

T/Maker II	229
------------	-----

MICRO - AP®

S-Basic	269
Selector IV	259
Selector V	399

MICROCRAFT®

Legal Billing	\$ 495
Time Billing	495

MICROPRO®

Wordstar	279
Mailmerge	89
Spellstar	159
Datastar	249
Calcstar	219
Supersort	199
Customization Notes	349
Wordmaster	119

MICROSOFT®

Basic 80	284
Basic Compiler	325
Fortran 80	345
Cobol 80	569
Macro 80	144
Edit 80	84
MU Math /MU Simp	219
MU Lisp/MU Star	165
M-Sort	129

PICKLES & TROUT®

CP/M	179
CP/M (Hard Disk)	259

SORCIM®

Supercalc	199
-----------	-----

DATA BASE®

FMS-80	649
CONDOR 20-I	249
CONDOR 20-II	529
CONDOR 20-III	839
CONDOR 20-R	249
CONDOR 20-Q	149

XEROX 820 ACCESSORIES®

DUAL DENSITY BOARD	395
SERIAL PRINTER DRIVER	99
SMARTERM	129
PARALLEL PRINTER SOFTWARE	99

AND MUCH MORE!

standard software

CORPORATION OF AMERICA

10 MAZZEO DRIVE, RANDOLPH, MA. 02368

617-963-7220

800-343-8420

MasterCharge, VISA, C.O.D.

3% Discount on prepayment made by check (software only)

All items subject to availability and price change

CP/M is a Trademark Of Digital Research



★ SOFTWARE ★ SUPPLIES ★ DISCOUNT PRICES ★ HARDWARE ★

★ SOFTWARE ★ SUPPLIES ★ DISCOUNT PRICES ★ HARDWARE ★

Editorial

If you can see the value of these two bills, I urge you to write to your senator and representative. Both bills must be approved by the House Ways and Means Committee before they can be voted on. The best way to make your voice heard is to contact the chairman of that committee, Dan Rostenkowski, at the House Ways and Means Committee, 1102 Longworth House Office Building, Washington, DC 20515, (202) 225-3625. If hearings are held, they will probably be before the Select Revenue Measures Subcommittee, chaired by Pete Stark. You can contact him at his office, (202) 225-5065; direct your mail to The Honorable Pete Stark, House of Representatives, 1034 Longworth House Office Building, Washington, DC 20515. Support from both Republicans and Democrats is essential if these bills are to get attention.

I cannot stress too strongly the need to make Congress aware of the urgency attached to the goal of getting computers into the hands of every American. Only then will we be able to hold our own in tomorrow's computer society.

* * *

Software Arts' TK Solver

Software Arts Inc., in case you've forgotten, is the company that created the immensely successful Visicalc program. Now that company, headed by Visicalc co-authors Dan Bricklin and Bob Frankston, has announced the first product to be marketed by Software Arts itself (Visicalc is marketed by Visicorp, formerly Personal Software). TK Solver (see photo 1) allows you to enter a series of formulas in a natural format (for example, "distance = time × speed"); it then compiles a list of all the variables. You can then give it a set of known values and tell it to solve for the unknown ones; it either does so or tells you why it cannot.



Data Acquisition Is Just
The Beginning...

easylab™

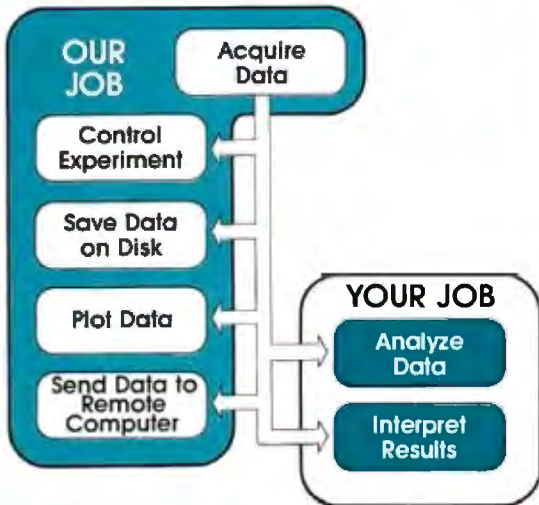
THE TOTAL CONCEPT
In Laboratory Automation Software
for the Apple II®



easylab™ software is ideally suited for industrial and scientific applications.

-  Powerful, elegant, easy-to-learn, easy-to-use commands. Develop applications in minutes, not days.
-  Simultaneous data acquisition and processing. Interrupt driven.
-  Supports a variety of analog, digital and communications interfaces for the Apple II.

PRICE: Systems start at \$995.

mia
Microcomputer Innovations
and Applications
137 RR#1, Califon, N.J. 07830
(201) 439-3665

® Apple is a Registered Trademark of Apple Computer, Inc.

Editorial

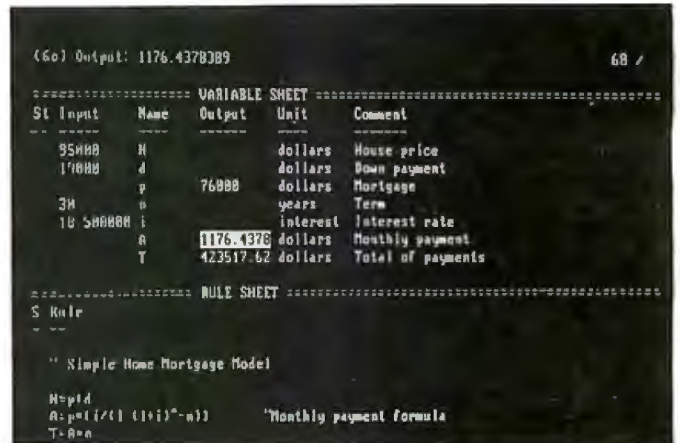

Photo 1: The new TK Solver, from Software Arts, lets you enter a series of formulas in a natural format.

TK Solver will initially be available for the Apple II and the IBM Personal Computer. It will be on the market later this year at the price of \$299. Also available will be various application packages that will supply a predefined set of rules concerned with a given specialty; these will probably be in the \$50 or \$100 price range.

Sound simple? Of course, but then so does Visicalc when you describe it. The basic idea has several good things going for it. First, it is extremely well human-engineered—it has to be because its potential users are not necessarily computer-oriented. Second, it automates repetitive calculations, thus giving you answers faster and more accurately than you could do yourself. Third (and most important), it allows you to do problem solving with a body of equations *without your having to manipulate them algebraically*.

Software Arts says that TK Solver lets the professional use the microcomputer as a problem-solving tool without having to learn programming. Will this product be as big a hit as Visicalc? Only time will tell, but look for an in-depth review of TK Solver in an upcoming issue of BYTE.

* * *

Omission

On page 70 of the May 1982 issue of BYTE we inadvertently omitted a distributor for the NEC PC-8001A. In addition to the distributor listed, NEC Home Electronics (USA) Inc., Personal Computer Division, 1401 Estes Ave., Elk Grove Village, IL 60007 (312) 228-5900 also will provide all components in the PC-8000 series. We regret the omission and hope our readers will find this new information useful. Our thanks to Thomas L. Priestly, General Manager of the Personal Computer Division, for pointing this out to us. ■

Mountain Computer Presents The Hard Disk System with Dynamic File Allocation

Long before you are out of space
on our system, other disk systems
will have given up!

The DYNAMIC 5M Disk System™ with—
The Mountain Virtual File System (MVFS)™
software:

- Uses dynamic file allocation which automatically consumes file space only when needed, not when initialized.
- Makes available up to 50% more disk space than competitive units and uses no extra memory space.
- Allows large files, up to 5 MBytes for database applications in CP/M and Pascal.
- Supports DOS, CP/M, & PASCAL for Apple II and MS DOS & CP/M 86 for the IBM Personal Computer.

QUALITY — The Mountain Computer reputation for quality peripherals combined with a one year warranty.

RELIABILITY — The dependable disk system from a leading supplier of personal computer peripherals, with a service organization to support it.

DYNAMIC 5M Disk System™ . . .
for the Apple II and the IBM PC.
(available soon for other systems)

(Includes everything you need: disk controller, power supply, interface card, cabinet, cabling, and the Mountain Virtual File System software.)

See your local computer store for
this and other innovative
Mountain Computer Products.



Mountain Computer
INCORPORATED

300 El Pueblo Rd. Scotts Valley, CA 95066
TWX: 910 598-4504 (408) 438-6650

Quality and Performance,
at an affordable price — \$2,695.

Letters

Commodore Comments

I am writing concerning the article "A Human-Factors Case Study Based on the IBM Personal Computer" by Robert G. Cooper Jr., Paul Thain Marston, John Durrett, and Theron Stimmel (April 1982 BYTE, page 56), in which a comparison of business-oriented microcomputer keyboards was included.

The Commodore keyboard used was from a PET 2001 series microcomputer, and while we appreciate being included in the comparison, certain factors must be considered: first, the PET 2001 has not been in production for about two years; second, the PET 2001 is oriented for education, not business, and our business-oriented microcomputer, the CBM 8032, was not included in the comparison.

We realize that the article and comparison were done by nonstaff authors, but we want you to know that we would be more than happy to cooperate fully with BYTE, its in-house staff, and freelancers in order to ensure that your readers get the latest and most accurate information possible about all Commodore products.

David A. Kaminer, Director of
Public Relations
Computer Systems Division
Commodore Business Machines Inc.
The Meadows
487 Devon Park Rd.
Wayne, PA 19087

Unix Feedback

I find I grow tired of the Unix-versus-CP/M argument, particularly as it is phrased by people like John Lynn Roseman (April 1982 BYTE, "Letters," page 22): "Unix is a full-featured operating system which is widely regarded as the finest ever written, while CP/M is little more than a program loader." Really? I defy anybody to take a competent secretary and make him or her a useful word-processing person on the Unix EX/VI in less time than it takes to get your work done on the CP/M Wordstar system.

And I don't like the crystal-ball predictions and dogma-before-the-fact apparent in Mr. Roseman's statement: "... we can be sure that the commercial software

which will eventually be available under Unix will be of higher quality than that found in the CP/M market." We can?

I direct your attention to an article by Donald Norman that appeared in *Data-mation* magazine all the way back in November 1981 (page 139 and following). It is titled "The Trouble with Unix," and it hits a number of nails on the head. Although I am fluent in a number of dialects of a number of languages and in a number of operating systems, I still haven't found the ultimate anything. CP/M has a number of serious limitations, but so does Unix (and so does anything else I have ever used).

Allow me to paraphrase Norman's conclusions, in which he states his three most important concepts for system design: be consistent, provide the users with a clear idea of what is going on at all times, and provide mnemonics as aids to us poor humans. I would add a final imperative: remember the users' context. In other words, decide what you want to have a given system do, and for what audience. CP/M is a tremendous environment for single users doing word processing and data acquisition; BASIC is a wonderful tool for a wide range of (generally small and one-of-a-kind) programming tasks; Unix is an amazing tool for some of the data-intensive work I sometimes need to do.

But please, give us all a break from the search for a perfect system for all people for all time. Provide me with information, tell me (as objectively as possible) about the tools that are available, and then leave me alone so I can get my work done.

Jeffrey L. Star, Research Geographer
Geography Remote Sensing Unit
University of California
Santa Barbara, CA 93106

I have some sad news for John Lynn Roseman and the recent crop of university-type Unix supporters. Unix has been running on 16-bit computers called Digital Equipment Corporation (DEC) PDP-11s for many years. There have been some other operating systems for the same machines. Guess which operating system is *not* at the top of the popularity list?

The most popular operating system on PDP-11 computers large enough to run Unix is RSTS/E. The primary language

used with RSTS/E is BASIC PLUS, not the "powerful C language." While RSTS/E is used in the commercial PDP-11 environment, RSX11M is more popular on the scientific systems. When DEC introduced the VAX11 superminicomputer, it did not select Unix but rather upgraded RSX11M. I have never even seen an advertisement for a programmer with Unix or C experience.

This is not meant as a criticism of Unix or C, nor is it meant to endorse RSTS/E or RSX11M. I would be tempted to write off RSTS/E as a primitive, crude system except that it is enormously popular and its users extremely enthusiastic. The marketplace is different from the university classroom. The needs of the end user are different from those of the system software developer.

CP/M is a rinky-dink kind of operating system. It does, however, do most of what most microcomputer users want, with a minimum of fuss. I have used various operating systems on IBM, DEC, and Control Data Corporation machines, and I don't feel neglected or abused by CP/M.

Unix, C, and Pascal may be excellent teaching and development tools, but they may not be so good for commercial production work. While we "old-timers" must be open to new ideas, the new crop of computer science graduates must keep in mind the difference between theory and practice. (By the way, what ever happened to ALGOL?)

Mike Draper
18 Cowdy St.
Kingston, Ontario
K7K 3V7 Canada

More on Human Factors

Hurrah! Hallelujah! Human factors have arrived. While BYTE has occasionally published comments on the importance of making computer systems easy to use, I was overjoyed to see human factors engineering as the theme for the April 1982 BYTE. The article "Designing the Star User Interface" by Dr. David Canfield Smith, Charles Irby, Ralph Kimball, Bill Verplank, and Eric Hanslem (page 242) was particularly outstanding in showing how human factors can be incorporated into the design process.

However, several points about human



Proven tools for programmers. From Microsoft.

Old friends. Eight years ago, Microsoft put BASIC on the first microcomputer. Today, there are more than 1,000,000 copies of Microsoft™ languages in use. BASIC interpreter. BASIC compiler. FORTRAN, and COBOL. A proven set of programming tools. All, fully supported by Microsoft.

The best get better. Good tools work better if you keep them sharp. That's why we constantly improve the tools we offer. Enhancing them. Increasing their utility. Taking full advantage of the strengths of each language. Supporting you, the user, with a full range of finely honed programming tools.

Technical support. When you buy our tools, you get our number. If you have technical problems, call the Microsoft support staff for assistance. If we don't have the answers now, we'll find them and call you back.

Compatible documentation. All Microsoft languages share a common approach to documentation. Starting with plain English. That means that even when you're learning a new language, you won't have to learn a new vocabulary.

Linkable code. All Microsoft compilers share common utilities. A linker accompanies each

compiler. That means you can write programs in two or more languages, taking advantage of the specific strengths of each, then, link and run them as a single program.

Leadership in micros. Nobody gave us leadership. We earned it through innovation, enhanced programming tools and complete user support. Today, Microsoft is the only software supplier to offer you a complete programming environment. Including specialized languages that support you in a wide variety of programming situations. Tomorrow, you can look to Microsoft to make that environment even more productive.

Better tools. Ask your Microsoft dealer about Microsoft's family of proven tools for programmers: BASIC interpreter, BASIC compiler, FORTRAN and COBOL. Each is a specialized tool for a special programming problem. Better tools. And better tools make better programs.



BETTER TOOLS FOR MICROCOMPUTERS

MICROSOFT
Microsoft Corporation
10700 Northup Way
Bellevue, WA 98004

Microsoft is a trademark of Microsoft Corporation.

Circle 276 on Inquiry card.

Letters

factors and computer system design that do not emerge from the April issue of BYTE as a whole need to be emphasized.

First, human factors need to be considered very early in design, well before the first line of code is written or the first circuit developed. Specifically, to ensure that a product will be human engineered, design from the outside in. First construct the user interface and write the user's manual. Everything else should follow. All too often the situation presented to human factors experts is: "We have built this system and are delivering it tomorrow. Isn't it wonderful? Please bless it."

Second, test, test, test. Throughout the life of a system observe user performance. Begin with simulations during the conceptual phase and conduct further tests in succeeding phases—on the documentation, on the first prototype, on the first production system, and on systems that have seen considerable operation. The focus should be on what the user does and how the system responds. While the opinions of human factors experts and user surveys provide clues about improvements, *it is essential to collect time and error measures of user-computer interaction*. A modicum of concrete data outweighs many opinions. Also keep in mind that computer scientists and engineers are poor critics of the friendliness of the systems they build and are not the best test subjects. They know far more about the internals of computer systems and differ in many other significant ways from ordinary users.

Third, human factors work, while sometimes costly, is money well spent. Project managers are often reluctant to spend funds for human engineering when there are more conventional projects to support (for example, developing file managers that require less memory or power supplies that run more coolly). Human factors considerations are an integral part of design and should be assigned a commensurate priority and funding. Managers need to appreciate that users don't care why a system doesn't work. To users, incomprehensible commands, and error messages, inscrutable manuals, computational errors, and blown fuses are all equally bad.

Finally, one does not become a human factors expert by being annointed by one's supervisor, living with a system, or just being human. Human factors expertise is obtained primarily through experience and special training in such areas as statistics and experimental design, sensa-

tion, perception, cognition, time and motion study, safety engineering, occupational health, biomechanics, work physiology, and anthropometry. In addition, one should complete several courses specifically dealing with human factors engineering.

Paul Green, PhD
HSRI—Human Factors
University of Michigan
Ann Arbor, MI 48104

I have just finished reading the April 1982 BYTE, the issue devoted to human factors engineering. While some topics were discussed adequately, I feel the issue lacked a general discussion of the human-machine interface. It is the user interface that is the most important issue in determining how user-friendly a system is to be. Only after this subject is carefully treated can the aspects of program design be discussed. In this respect, the article "Designing the Star User Interface" presents an example of one way to implement the man-machine interface.

Currently, the most reliable low-cost man-machine interface is the touch screen. Touch screens allow the simplest possible user interface. Users visually see what item they're interested in, then reach out and touch it. The computer system then responds. Since it relies solely on the users' visual and tactile senses, no prior training is required.

Our experience in the creation of touch-sensitive database systems in library catalog, hospital, merchandising, publishing, and other public-use applications suggests that this technology will rapidly become dominant in environments where training of the user is not feasible or practical.

From a human factors point of view, we have learned that there are also additional considerations that improve the prospects for the success of a system in use. First of all, we have found that a combination of visual and aural responses supporting the physical sensation of touch creates a strong feeling of comfort. Using inverse video or highlighting the touched region and ringing the audible bell have proved to be helpful features. Also, if the user touches a region of the screen not relating to a valid choice, the response should be similar to that for a valid touch, but the region of the screen touched should restore to normal video almost immediately. This action tells users that the

The Context MBA is available now at the leading personal computer retailers listed below:

California

ComputerLand/Almaden 408/267-2182
ComputerLand/Belmont 415/595-4232
ComputerLand/Burlingame 415/348-7731
ComputerLand/El Cerrito 415/527-8844
ComputerLand/Pasadena 213/449-3205
ComputerLand/San Diego 714/560-9912
ComputerLand/San Diego East 714/464-5656
ComputerLand/San Diego North 714/434-7001
ComputerLand/San Fernando Valley 213/716-7714
ComputerLand/Sonoma 707/528-1775
ComputerLand/South Bay 213/371-7144
ComputerLand/Thousand Oaks 805/495-3554
ComputerLand/Ventura 805/656-7711
ComputerLand/West Covina 213/960-6351
ComputerLand/West Los Angeles 213/559-3353

Connecticut

ComputerLand/Danbury 203/748-2300
ComputerLand/Fairfield 203/255-9252
ComputerLand/Hartford 203/561-1446
ComputerLand/New Haven 203/288-5162
ComputerLand/Stamford 203/964-1224

Delaware

ComputerLand/New Castle County 302/738-9656

Illinois

ComputerLand/Arlington Heights 312/870-7500
ComputerLand/Downers Grove 312/964-7762
ComputerLand/Joliet 815/741-3303
ComputerLand/Lake County 312/949-1300
ComputerLand/Naperville 312/369-3511
ComputerLand/Niles 312/967-1714
ComputerLand/Northbrook 312/272-4703
ComputerLand/Oak Lawn 312/422-8080
ComputerLand/Schaumburg 312/843-7740

Massachusetts

Business Data Systems/Hanover 617/878-7888

Minnesota

ComputerLand/Bloomington 612/884-1474
ComputerLand/Hopkins 612/933-8822
ComputerLand/Minneapolis 612/333-3151

New Jersey

ComputerLand/Morristown 201/539-4077

ComputerLand/Princeton 609/882-1400

New York

ComputerLand/Nassau County 516/742-2262
ComputerLand/Suffolk County 516/499-4484
Morris Decision Systems/New York 212/742-9590
Super Business Machines/New York 212/943-4130

Oregon

ComputerLand/Multnomah County 503/295-1928
ComputerLand/Salem 503/620-6170
ComputerLand/Portland 503/620-6170

Pennsylvania

ComputerLand/Dresher 215/542-8835
ComputerLand/Harrisburg 717/763-1116
ComputerLand/Paoli 215/296-0210
ComputerLand/Philadelphia

Texas

ComputerLand/Dallas 214/363-2223
ComputerLand/Fort Worth 817/292-7114
ComputerLand/Houston Bay Area 713/488-8153
ComputerLand/North Dallas 214/235-1285
ComputerLand/Southwest Houston 713/977-0909
ComputerLand/Westwood 713/270-1200

Virginia

ComputerLand/Richmond 804/741-3502
ComputerLand/Tyson's Corner 703/893-0424
ComputerLand/Woodbridge 703/491-4151

Washington

ComputerLand/Bellevue 206/746-2070
ComputerLand/Federal Way 206/838-9363
ComputerLand/Lynnwood 206/774-6993
ComputerLand/Renton 206/221-8585
ComputerLand/Seattle 206/223-1075
ComputerLand/Tacoma 206/383-4951
ComputerLand/Vancouver 206/695-1540

Washington, DC

ComputerLand/Washington, DC 202/835-2200

THE CONTEXT MBA: IT PUTS ADVANCED BUSINESS SCHOOL TECHNIQUES TO WORK FOR YOU TODAY.

Will The Personal Computer Revolution Leave You Behind?

You've read all the stories about how personal computers are going to revolutionize the way you work. The stories are true. But until now, you had to be a computer expert to exploit this amazingly powerful new tool.

The Context MBA is a remarkable new software program that lets any manager utilize advanced business techniques. All you need is an IBM Personal Computer.

A Complete Set of Management Tools.

Some of the computer programs available today can help you in one phase or another of your job. But only the Context MBA combines five powerful functions into one easy-to-use system.

You start with a giant electronic spreadsheet for your projections, budgets and models. You can ask "what if" questions simply by changing one number—every effected item is instantly recalculated.

Want a chart to summarize your results? The graphics feature gives it to you with a few keystrokes. And—unlike any other program—C-MBA automatically revises your charts to reflect changes you make in the spreadsheet numbers.

C-MBA's database saves information in a vast electronic library for near instant recall.

Still another unique feature is the ability to access other computers and data banks.

It's a simple matter to tap into your company data center, a financial information service, or electronic mail system. The data you need goes directly where you need it, without tedious re-typing.* Finally, the C-MBA's executive word processing capability lets you assemble text and figures into neat, error-free reports—without the hazards of typing and transcription errors. You can actually revise a document yourself faster than you can explain the changes to your secretary.

Synergy in Software

By itself, each of the Context MBA's functions would be a significant productivity booster. But it's only when all these capabilities are combined—with a simple, consistent set of commands—that you will begin to appreciate the true power at your

fingertips. With just a bit of practice, you'll be accomplishing in hours what used to take days.

The Context MBA is sold only by selected computer retailers who have completed special training courses to help managers get the most from the program.

Personal Computers Are Full of Promise. Context Makes Them Deliver.

IBM is a trade mark of IBM. *Version 1 of the C-MBA will not include communications. Version 1 owners will receive a free upgrade to version 2 which will include communications. The MBA is currently available for the IBM Personal Computer. Versions for other second generation personal computers are under development.

Context

Management Software for Personal Computers

23864 Hawthorne Boulevard

Torrance, CA 90505

(213) 378-8277

Telex 181149 WEST LSA

Source ID TCA442

© Copyright 1982 Context Management Systems.

Circle 117 on Inquiry card.



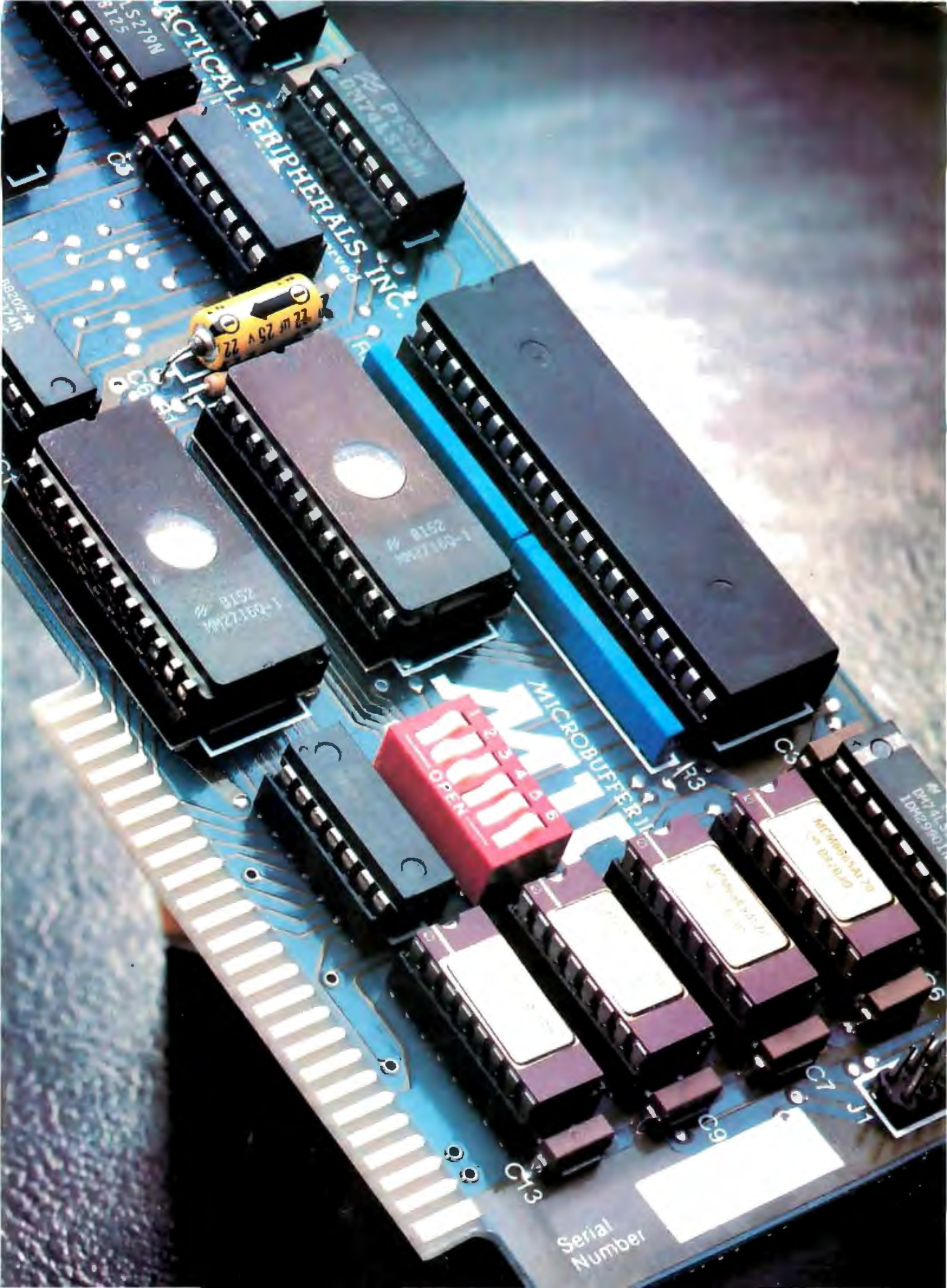

PRACTICAL PERIPHERALS, INC.

8125
S-279N

8125
S-279N

220
25V
22

8152
M27169-1

8152
M27169-1

1 2 3 4 5 6
OPEN

MICROBUFFER II

F3

C5

10K459011
PR17413

M27169-1
C

M27169-1
C

M27169-1
C

M27169-1
C

M27169-1
C

M27169-1
C

M27169-1
C

C13

C9

C7

J1

Serial Number

INTRODUCING MICROBUFFER.

NOW YOU CAN USE YOUR PRINTER WITHOUT WASTING COMPUTER TIME.

As you know, your computer drives your printer. And when it's performing this function, you can't use it for anything else.

A program that takes fifteen minutes to print makes you wait fifteen minutes before you can compute again. And if it takes two hours to print, you wait two hours.

A waste of valuable time.

THE NEW MICROBUFFER™ INCREASES YOUR EFFICIENCY.

Microbuffer allows you to print and process simultaneously. No waiting!

MICROBUFFER ACCEPTS PRINTING DATA AS FAST AS YOUR COMPUTER CAN SEND IT.

Microbuffer first stores the data in its own memory buffer and then takes control of your printer. This frees the computer for more productive functions.

Additional output may be dumped to the buffer at any time and it will be printed in turn.

MICROBUFFER WILL SPEED UP ANY PROGRAM THAT REQUIRES PRINTING.

The full line of Microbuffers is designed to accommodate virtually any computer/printer combination.

Microbuffers are available in Centronics-compatible parallel or RS-232C serial versions.

FOR APPLE II COMPUTERS, Microbuffer II features on-board firmware for text formatting and advanced graphics dump routines. Both serial and parallel versions have very low power consumption. Special functions include Basic listing formatter, self-test, buffer zap, and transparent and maintain modes. The 16K model is priced at \$259 and the 32K, at \$299.

✓ FOR EPSON PRINTERS, Microbuffer starts at \$159 in either an 8K serial or a 16K parallel version. The serial buffer supports both hardware handshaking and XON-XOFF/ETX-ACK software handshaking at baud rates up to 19,200. Both Epson interfaces are compatible with all Epson commands including GRAFTRAX-80. Both are user-expandable to 32K.

ALL OTHER COMPUTER/PRINTER COMBINATIONS are served by the in-line, stand-alone Microbuffers.

Both serial and parallel versions are expandable up to 256K. The serial stand-alone will support different input and output baud rates and handshake protocol. The 32K model starts at \$299, 64K for \$349. 64K add-ons for up to a total of 256K are just \$179.00.

SIMPLE TO INSTALL.

Microbuffer II, being slot-independent, will fit into any slot directly inside the Apple except zero.

Microbuffer for your Epson mounts easily in the existing auxiliary slot directly inside the Epson printer.

The stand-alone Microbuffer is installed in-line between virtually any computer and any printer.

MICROBUFFER FROM PRACTICAL PERIPHERALS.

When you think of how much time Microbuffer will save, can you afford to *not* have one?

PRACTICAL PERIPHERALS, INC.™
31245 LA BAYA DRIVE
WESTLAKE VILLAGE, CA 91362
(213) 991-8200

What if you want more assurance your valuable data won't fade away?



Rely on SYNCOM diskettes with Ectype[®] coating. Balanced coercivity means long-lasting signal life.

Syncom diskettes assure excellent archival performance in the following ways.

First, with calibrated coercivity – a precisely balanced blend of milled ferrous oxides that allows Ectype[®] coating to respond fully to "write" signals, for strong, permanent data retention.

Then, a burnished coating surface to boost both signal strength and packing density.

Carbon additives drain away static charge before it can alter data.

And, finally, every Syncom diskette is write/read-back certified to be 100% error free.

To see which Syncom diskette will replace the one you're using now, send for our free "Flexi-Finder" selection guide – and the name of the supplier nearest you.

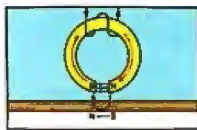

Balanced coercivity of Ectype[®] coating allows write current to saturate fully.

Syncom, Box 130, Mitchell, SD 57301.
800-843-9862; 605-996-8200.

SYNCOM

Manufacturer of a full line of flexible media

Letters

equipment is working and thus they have simply touched an invalid region for this particular point in their use of the system.

The design of data formats for successful touch-based systems should follow guidelines similar to those which have evolved for the design of keyboard-oriented systems; i.e., the processes should mirror and reflect the functions to be performed. One additional consideration is that menu items should be separated from each other to accommodate the accuracy of the human finger. Typically, touchable menu entries should be displayed either double the normal text size or on every other line. This spacing allows almost any user to touch the desired selection on the first try. Software products which convert the menus of already existing programs to convenient touch-screen formats are commercially available and inexpensive.

Your readers should feel free to contact us if they desire additional information about the touch-sensitive technology.

Jonathan J. Bloom, Marketing Manager
Interaction Systems Inc.
24 Munroe St.
Newtonville, MA 02160

A Matter of Pride

Some of us in the software industry do accept responsibility for delivering high-quality products and back up that responsibility with a warranty. We at Micro-Integration take great pride in being one of the few (the only one we know) software vendors that offer a written warranty as a part of our standard software license agreement. The agreement reads, in part:

Micro-Integration warrants that the Software will perform according to the product specifications in effect at time of purchase of the use license by the customer. If it fails to perform according to these specifications, Micro-Integration will repair any defect or, on request for termination of the license by the customer, will refund the license fee.

We are in the communications software business, providing IBM BISYNC (Binary Synchronous) and SNA/SDLC (Systems Network Architecture/Synchronous Data Link Control) communications software for microcomputers. The operation of our

Plot your next meeting yourself.

Read how 2 pens can become your best presentation tools.

Introducing the New Personal Computer Plotter from Hewlett-Packard.

Now you can use your personal computer to generate your own presentation charts, graphs, and pie charts. How? Simply add on the new high quality, low cost HP 7470A Personal Computer Plotter.

The 7470A helps you save time and save money, and lets you communicate quickly, accurately and *effectively*.

Quicker understanding.

Data, when visualized graphically, becomes information fast. Charts and bar graphs can make any presentation clearer and more readily understood. But asking your staff to produce the graphics manually for your next presentation doesn't ensure accuracy or artistic talent. And going to outside graphics suppliers can be costly. Combined with your personal computer, the new HP 7470A plotter does the communicating for you. Quickly. Logically. And with off-the-shelf software available from most HP dealers.



Fast and pretty.

The 7470A gives you high plotting speed with excellent line quality...faster than any competitive small plotter. On top of all that, it comes in an attractive design package that looks nice on your desk. And it does it for only \$1,550. (U.S.A. domestic suggested retail price.)



Count on it.

The 7470A is built the Hewlett-Packard way. To last. Designed and engineered with only a few parts, none of which require adjustment. And with customized integrated circuits that ensure reliability.

Pen pals.

The HP 7470A has two single-pen stables. Simple pen changes give you multi-color plots in your choice of ten coordinated colors. Pens are automatically capped and stored.

An option you'll want, too.

For only \$95, you can also get a 17057 Overhead Transparency Kit that turns your plots into transparencies for overhead projectors. For "I need it tomorrow at 9:00 A.M.!" meetings, it's a necessity.

Start plotting your next presentation today. Clip and mail the coupon below. Now.

Mail the coupon below and we'll send you—absolutely free—a sample plot, a more detailed brochure, and a sample overhead transparency.

Then...stop in at your nearest Hewlett-Packard Dealer. See the HP 7470A in action. Once you see it demonstrated you'll find a hundred ways to make your own applause-winning presentations.

When performance must be measured by results



Circle 193 on inquiry card.

Seeing is believing. Send me a sample plot, an overhead transparency, and more detailed information.

Name _____ Title _____

Company _____

Address _____

City, State & Zip _____

Phone Number () _____

Send to: Hewlett-Packard, 16399 W. Bernardo Drive, San Diego, CA 92127 — Attn: Nancy Carter

11203 BT-8

It's the best part of any Apple.



Your Apple computer can grow from ordinary to awesome in a matter of minutes.

The Elite disk drive Series by Rana Systems gives you that kind of magic. Quickly, easily and cost-effectively.

This superb family of sophisticated floppy drives was designed and perfected by a team of industry-respected engineers expressly for Apple® computer owners who have long been demanding more disk drive for their money.

Now they *have* a drive that makes an Apple perform the way it should. For example;

Elite One, the most economical Rana drive, delivers 15% more storage capacity than Apple's drive. The top-of-the-line Elite Three will provide an astonishing *four-times* more storage,

approaching hard disk performance. It's done through exclusive high-density single and double-sided disks and heads.

Here's a tantalizing taste of just how formidable your Apple can become.

Next to enormously increased disk space, Apple buyers are most excited about Rana's fingertip Write/Protect feature. A pushbutton on the LED-lit panel gives you a new measure of failsafe control.

While Elite drives are all plug-compatible with Apple's controller, Rana's vastly superior controller card is a *must* for those with growing data processing demands. With it, you control up to *four* floppy drives using only one slot... while still utilizing your

Apple computer to achieve dramatic new heights of system flexibility and processing power.

A specially programmed Rana utility disk assures you of far-reaching compatibility, and extra dimensions of business, leisure and learning applications with your Rana-enhanced Apple computer.

There are many, many more operating refinements: Uncanny head-positioning accuracy, 300% faster track-to-track speed, better operating economy, and gentler clamping action through an all-new diskette centering cone, to name just a few.

A disk drive package like this doesn't grow on trees, so write or call today for more information about the Elite Series.

RanaSystems



20620 South Leapwood Avenue, Carson, CA 90746 213-538-2353. For dealer information call toll free: 1-800-421-2207. In California only call: 1-800-262-1221. Source Number TCT-654.

Apple is a registered trademark of Apple Computer Inc.

Rana Systems Distributors

MicroDistributors Incorporated
Los Angeles, California
714-540-4781

Trak MicroComputer Corporation
Chicago, Illinois
312-968-1716

Computer Data Services
Boston, Massachusetts
603-673-7375

DRV Electronics
British Columbia, Canada
604-576-1045

Regional Service Centers

Rana Systems
Los Angeles, California
213-538-2353

Peripheral Marketing Inc.
Palo Alto, California
415-964-4652

Peripheral Marketing Inc.
Boston, Massachusetts
617-449-5404

Peripheral Marketing Inc.
New York, New York
201-584-0010

YOUR VALUABLE DATA

**Precise head-positioning
saves you valuable time, your
disks and your temper.**

Your factory-supplied Apple® disk drive has a plastic head positioner. Like a toy, it's a workable but sloppy way to capture data. Characters are obscured, and multiple passes are needed to deliver a given bit of information.

Rana's head positioner is 50 percent more precise. It uses finely machined lead screws and metal band positioners that assure fast data recognition and optimum disk life.

Your local Rana Dealer can give you the complete picture on this and other major operating advantages.

RanaSystems



20620 South Leapwood Avenue
Carson, CA 90746 213-538-2353

®Apple is a registered trademark of Apple Computer, Inc.

Letters

software, therefore, depends not only on the local microcomputer but also on modems, telephone lines, and a remote IBM processor running mainframe communications software. The possibilities for undetected protocol errors are enormous because all of these components normally function correctly and boundary conditions are not usually encountered in normal operation.

How, then, can we offer a warranty? By testing, testing, and testing! We have developed both hardware and software test vehicles that allow us to simulate all components of the communications path that are external to the microcomputer, including the local microcomputer operator and the remote IBM processor. Using these test harnesses we can perform functional tests that ensure that each function of the software performs as advertised and stress tests that test boundary conditions, host-generated protocol errors, and performance under high load. Any errors that slip through the test suites and are reported by customers are then incorporated into the test suites to ensure that any problem reported is never again present in a release. The software becomes more and more stable as a function of time.

From a user's viewpoint, a software warranty means that you can count on (1) getting the level of customer support needed to make the software run in your environment, (2) the software's being very stable once it is running, and (3) receiving patches and updates that correct problems found by other users.

This implies, from the vendor's viewpoint, that (1) the software must be easy to set up and run (or the vendor must have a huge customer service staff) and (2) the vendor must be prepared to expend a lot of time and money in sending out updates if the software is not stable.

We believe that the time and money spent testing, supporting our customers, and sending out updates (yes, we still find occasional bugs) is well worth it. We couldn't live with ourselves if we sent out junk that had little chance of running. Our customers deserve the best we can provide—after all, they're paying our salaries!

John A. Parsons, CDP
President
Micro-Integration Inc.
63 Maple St.
POB 335
Friendsville, MD 21531

Misrepresenting the Videotex Standard

I read with interest Chris Morgan's editorial, "Of IBM, Operating Systems, and Rosetta Stones," in the January 1982 BYTE. Of particular interest was the mention of Microsoft's device driver for the AT&T proposed videotex graphics standard. For your Canadian readers you might point out that the AT&T system is based on the Telidon coding system developed by the Federal Department of Communications in Ottawa. Mr. Morgan is in error, however, in the implication that this is a low-resolution standard. It is, on the contrary, an extremely high resolution standard, allowing up to an incredible 24 bits of data to specify each x and each y coordinate. This, admittedly, exceeds the capability of any current hardware including the printing press.

The key and the beauty of the system, however, is in the concept of the unit screen, which treats these data bits as decimal values between 0 and 1, thus achieving hardware independence and upward compatibility.

If you probe the standard further, you will see similar capability and expandability in all aspects of the code, including color, character fonts, text sizes, and the like. It is anything but a minimal standard.

It may be of interest that a Unix-based system has been written to meet the earlier Telidon standard (of which the AT&T system is essentially a superset).

Robert A. Abell, President
Alphatel Systems Ltd.
Edmonton, Alberta
Canada

We thank Mr. Abell for setting us straight about the videotex graphics standard. We are currently working on an issue, to be published in early 1983, that will be devoted in large part to the subject of standards in the microcomputer industry.

... C. M.

The Last Laugh

I was much amused by your facetious entry in the What's New? section of the April 1982 BYTE (page 424) concerning the hard disk for the ZX81. I'm afraid the joke is on you, however, and I quote from a recent press release ("Micro Forecast," Vol. 3, No. 5):

After the first £100 computer—the ZX80—two years ago, Sinclair are looking to become the first company to market a £100 disk drive.

The project to produce a low-cost mass memory storage on hard disk for personal computing will be led by Rodime, the Glenrothes-based, all-British disk drive company, if agreement can be reached between the two companies.

The new disk drive will use 3½-inch rather than 5¼-inch hard disks and both Sinclair and Rodime hope that users of the ZX81 will take up the disk-drive facility when it becomes available, creating a new £250 million market for the disks. At the same time it will give the ZX81 and future Sinclair computers an enormous boost as the battle for a share of the microcomputer markets heats up.

Rodime, who will develop the disks, say there are no serious technical problems preventing them from going ahead with a 3½-inch

disk and claim that with or without Sinclair they will be marketing one by 1983.

The problem of bringing the cost down, however, could confound Rodime and it would need Sinclair's mass market as well as their gift for making a success of low-cost computing before they could seriously contemplate a £100 price tag.

Sinclair meanwhile are not expected to be involved in selling the disk drives for some time yet. The first proposal came from Rodime, and Sinclair will need to overcome technical problems and plan production—possibly from the Timex plant where the ZX81 is built.

Dr. C. T. Spracklen
Department of Applied Physics
and Electronics
University of Durham
Science Laboratories, South Road
Durham, DH1 3L3
United Kingdom

What's the Story, Jerry?

I have enjoyed BYTE's "User's Column" by Jerry Pournelle for some time now. He has presented products through the eyes of an actual user, rather than an impartial reviewer, with some amusing results (it took me three days to stop laughing at his "review" of Microproof [April 1982 BYTE, page 212]). This "actual user" view brings things down to earth.

However, I'm starting to doubt that Mr. Pournelle and I are on the same planet. He gets phone calls from Arthur C. Clarke ("Long-distance from Sri Lanka, Mr. Pournelle. . ."), and when he has some questions about Godbout products, he calls Bill Godbout himself. To make myself feel better, I tried looking up Joe Northstar in the Osceola County phone book (I had a few questions myself), but to no avail.

I'm also getting the teensy-weensiest bit tired of Mr. Pournelle's telling us losers about "the way to go" for his money. It would be my way to go too, if it were still his money. He proceeds to describe a system (oh, what a system) that I've dreamed about having (with a few minor additions) for years.

And now he sells his own software: "I've always liked it [his program], and I'm happy to share it." For a price, no? Why not share it in the pages of BYTE? Alas, the rich get richer. . . .

The most comforting thing I've read in "User's Column" is that Mr. Pournelle owns a TRS-80 Model I—a souped-up TRS-80, but that which we call a TRS-80, by any other name, would still run at less than 4 MHz.

I do hope all I've written so far just points out how envious I actually am of Mr. Pournelle, or at least of his hardware and software. But if he wants to publish Arthur Clarke's or Bill Godbout's home phone numbers, that's fine with me.

One more thing: besides the fact that everyone except myself has infinitely better computer stuff, do all computer owners except myself have names for their computers? Mr. Pournelle insists on calling one of his computers "Ezekial," or "Zeke," instead of the more obvious "Z-2," and I have a friend who calls his dad's TI bubble-memory terminal "Ben-ny." I myself admit to calling the two lamps in my bedroom "Scott" and "Zelda," but I call my OSI C1P "my OSI C1P," or "the damned computer" for short. Maybe having names for one's

Go To The Head Of Your Class



Polish off your Apple™ with a disk drive from A.M. Electronics!

Now there is an affordable, high performance, 5¼-inch disk drive that is fully compatible with your Apple—and compatible with your pocketbook.

The A.M. Electronics drive comes complete with an Apple-beige case and connecting cables. It's fully tested with Apple's disk operating system and software.

Just plug it in — it's ready to run.

You also receive a 90-day limited warranty and a 10-day money back guarantee.

Order Today. The Apple-compatible disk drive is now available direct from A.M. Electronics for only \$395 (40 track) or \$495 (80 track). Upgrade your Apple with our disk drive today and increase the fruit of your labor.



A.M. ELECTRONICS, INC.
3446 Washtenaw Avenue • Ann Arbor, MI 48104
313-973-2312



Attention Dealers & Distributors: For information on attractive pricing and sales opportunities, call us today. Key territories are still available.



Every week,
2500 more people like
you are going to work
with an Osborne[®]
personal business
computer.

They're moving faster than they were before.

Today, the Osborne 1 Personal Business Computer sells for \$1795. Complete. Including software.

The Osborne is portable, because your ideas don't always happen at the office.

The Osborne is affordable, so there's no reason to wait.

The Osborne is complete.

Dollar for dollar, no other computer comes close.

The Osborne is easy to learn, fun to use, and quickly becomes indispensable.

A visit to your local authorized Osborne computer retailer will convince you that today, more than ever, how fast you go up depends on which buttons you are pushing.



\$1795. Complete. Including Software.

For your nearest dealer,
call (in California) 800 772-3545
ext. 905; (outside California) call
800 227-1617
ext. 905.

OSBORNE
COMPUTER CORPORATION

The \$1795 suggested retail price for the Osborne 1 (a registered trademark of Osborne Computer Corporation) includes a full business keyboard, built-in CRT display, two built-in floppy disk drives, CPU and 64 kilobytes of RAM memory, RS-232 and IEEE 488 interfaces, and the following software packages: WORDSTAR[®] word processing with MAILMERGE[®] (a trademark and a registered trademark of MicroPro International Corporation of San Rafael, California); SUPERCALC[®] electronic spreadsheet system (a trademark of Sorcim Corporation); CBASIC[®] (a registered trademark of Compiler Systems); MBASIC[®] (a registered trademark of Microsoft); and CP/M[®] (a registered trademark of Digital Research).

Letters

hardware is a function of the cost of it; perhaps Mr. Pournelle could speculate on this in the next "User's Column."

All in all, the "User's Columns" are the best reading I've had since *The Mote in God's Eye* by Larry Niven and Jerry Pournelle (Simon and Schuster, 1974), and to me they are not in different classes. (I'm as likely to be capable of purchasing Qume double-sided double-density drives as I would be capable of purchasing an Alderson Drive.)

Karim Alim
2414 Sable Drive
Kissimmee, FL 32741

Jerry Pournelle replies:

I'm glad Mr. Alim (usually) likes my columns. As to my friendships with Bill Godbout and Arthur Clarke, what am I to do? I can't believe Mr. Alim really believes that those unable to talk with everyone should speak to no one.

Regarding "dream" systems: the last time I looked, Priority One was selling the VISTA box with two Qume DT-8 drives for \$1600. This isn't cheap, but I noted

yesterday that my local membership discount department store sells 5¼-inch drives for Atari 800s at about \$475, and I expect \$500 is closer to what you'd pay at a regular store. I'd rather pay the extra \$600, which is indeed what I did; I do, after all, trust my livelihood to my machines.

I make no secret that I believe the best way to go is to get a good S-100 bus with the best disks you can buy: later on you can replace the boards in your computer. Iron's expensive, but silicon's getting cheaper all the time.

Regarding my letting Barry Workman sell my programs: I worry about that, but I've neither the time nor the ability to be a publisher, and Barry neither can nor will do it for free. It seemed to me that making the programs available is worthwhile and does no harm.

I've asked Zeke about computer names, and he tells me that his electronic friends enjoy having human appellations; it makes their humans think they are somehow the equals of computers.

I'm glad that Mr. Alim likes my other works.

Looking for Adventure

Help! Is there really no adventure game other than the original adventure for CP/M systems? Nothing like the Temple of Apshai or Invasion Orion and all the others? Is there no one out there who has a heart for all the owners of nice CP/M systems who want to play and cannot afford to buy an Apple for this reason alone? I went through all BYTE issues for that matter, and whenever I find the new BYTE in my postbox I go through it, but no, everything is for TRS-80 or Apple. Every mornin' finds me moanin'.

Hans Strasburger
Tal 58/IV
D-8000 Munich 2
West Germany

Advice for Apple

I'm a relatively new reader of your excellent publication, but a letter from

What is Unique-NISS™?

FREE CALL
FREE CATALOGUE

- 1** An unprecedented forecasting software support service that provides you with one-on-one interaction with our staff of professionals.
- 2** The leading forecasting software packages available today for the leading personal computers.

Maximize your personal productivity through the use of our forecasting software, a one-year service agreement, newsletters and prompt access via our toll-free hot lines.

Call us now and profit from the integration between you, the discerning end-user, and NISS, the unequalled direct support service.



1-800-525-SOFT

In Colorado (303) 694-1994

8800 East Arapahoe Road, Denver, Colorado, 80112

BY8-82

And The Winner Is... IBC By Four Users!

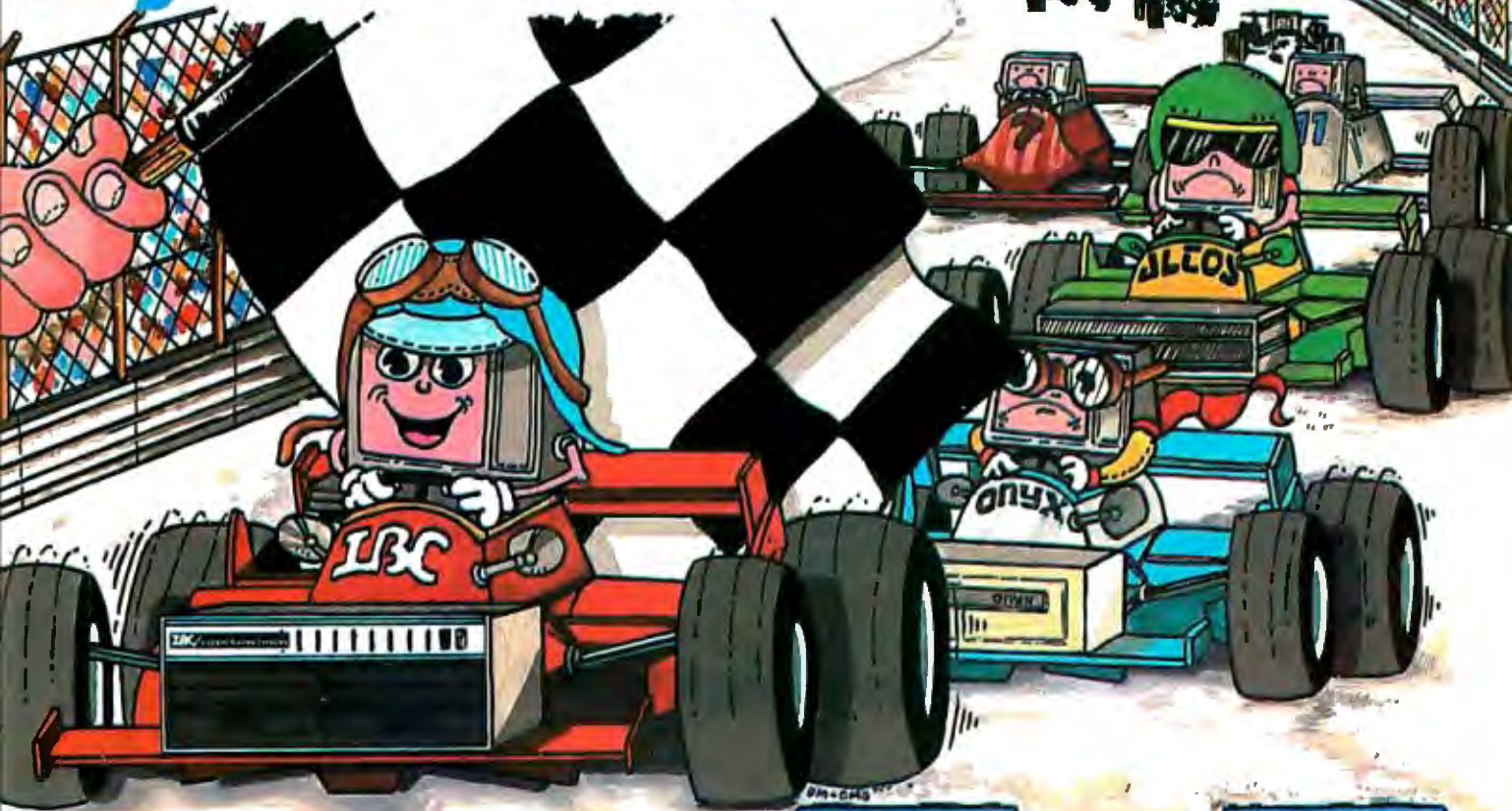

When you are racing toward that finish line, beating the competition is everything. IBC is the choice of OEM's, system integrators and dealers throughout the world, because in benchmark after benchmark our small business computer systems finish first.

We finish first because we are faster, offer higher quality peripherals and can expand our system significantly beyond our nearest competitors. In fact, looking at the chart below, you can quickly see why knowledgeable resellers are choosing IBC.

	IBC	ONYX	ALLOS
Oasis Operating System (Max. Users)	9	5	4
CPU Speed (MHz)	6	4	4
Disk Speed I/O (MB/Sec.)	.81	.65	.54
Seek (Milli Sec.)	35	50	65
Cache Disk Memory	Yes	No	No



For dealers only, circle 474
All other inquiries, circle 476

Join us in the winners circle with high performance equipment and the best dealer plan in the industry. Call or write:

OUTSIDE THE USA

IBC Integrated Business Computers

21592 Marilla Street
Chatsworth, CA 91311
(213) 882-9007 TELEX NO. 215349

WITHIN THE USA

IBC DISTRIBUTION

4185 Harrison Blvd., Suite 301
Ogden, UTAH 84403
(801) 621-2294

A BETTER DEAL THAN MAIL ORDER!

YOU SAVE WHEN WE BUY FOR YOU AS YOUR AGENT.

We are a commercial buying company. Our fee is one-fourth of what we save you off list price.

We offer:

- Better prices
- Exporting
- Leasing
- Full service and support
- Access to 500 manufacturers
- Assembly, integration, testing

These are just a few of the products we can buy for you:

COMPUTERS

Adds Multivision I	\$ 3,074	IBM Personal comp.	CALL
Alpha Micro 1030	12,047	Seattle boards	CALL
Alpha Micro 1051	17,634	Davong 5 meg. H.D.	1,575
Alspa AC1-2/SS	2,320	IBC Cadet	4,211
Altos 8000-02	2,629	Micromation	CALL
Altos 8000-10	6,295	NEC 8000 64K PC system	
Altos 8000-15	3,585	incl. CP/M, Wordstar	2,266
Altos 8600-10	7,586	NorthStar Advantage	2,695
Altos Series 5-150	2,182	NorthStar Adv. HD 5	4,395
Altos Series 5-5D	4,372	NorthStar Hor 64K QD	2,650
Apple 2 + 48K	1,208	Onyx 5001 MU-6	7,350
BMC 20 B	5,422	Onyx 8000 MU-10	7,900
CCS Series 300-1A	4,414	Osborne	CALL
Columbia Data	CALL	Sanyo 2000	2,708
Corvus Concept	CALL	Seattle System 2	3,251
Cromemco System 1	2,946	Televideo TS-802	2,600
Cromemco System 2	3,400	Televideo TS-802H	4,995
Cromemco 68000 System 1	4,395	Televideo TS-806	5,200
DEC VT-180xx	3,344	Vector 2600	3,895
Dual	12,636	Vector 3005	5,495
Dynabyte	26% OFF	Vector 4	CALL
Eagle II	3,796	Victor	22% OFF

PRINTERS

Amperex GP 300	3,695	NEC 3510	CALL
Brother, parallel	853	NEC 7710 R/O	2,325
C. Itoh F-10, daisy	1,400	NEC 7720 KSR	2,685
C. Itoh Comet II, dot	799	NEC/Sellum 1, 16K, tractor	2,595
Diablo 630, daisy	2,098	Qume 9/45 full panel	2,045
IDS 560/G	995	Qume 9/55 full panel	2,180
IDS Prism 80	744	Smith Corona TP-1	681
IDS Prism 132 column	1,430	Tally	CALL

DISK DRIVES, MODEMS, ETC.

Amdek Color II term.	694	Houston Instr. DMP-2	1,147
Ventel 212 + modem	765	Houston Instr. DMP-4	1,460
Corvus 10 meg. H.D.	3,825	Houston Instr. DMP-7	2,077
DEC VT-100 terminal	1,390	Morrow 20 meg. H.D.	3,650

Mastercard, VISA at 3% handling fee. Prices subject to change without notice. Minimum fee \$150. 15% restocking charge.

EXPORT SERVICES available. We are buying agents for overseas computer dealers and distributors. International Telex 470851

THE PURCHASING AGENT

1635 School Street, Suite 101, Moraga, CA 94556

Call Toll Free 800-227-2288 In California (415) 376-9020

Letters

Dennis Pratt in the March 1982 BYTE (see "Apple's Decision Questioned," page 14) concerning Apple Computer Inc.'s decision to restrict mail-order and telephone sales struck a responsive chord. Having followed the development and success of the personal and small-business computer market, I'm simply amazed that Apple is attempting to justify its actions with the excuse that customers can be served properly only through the retail outlet. Because all versions of the Apple were available through the mail up until the end of last year, I suppose the company is implying that its customers are now much less intelligent than they once were. If you believe that Apple's motives are anything other than pure economics, then you probably also believe that the intense competition for the personal computer market is simply a passing fad.

If I were in the Apple boardroom, however, I would worry. As I sit here typing on my non-Apple system and consider the number of personal computers that are now on the market, many available through multiple sales outlets (i.e., retail, mail, etc.), I can only suggest that the people at Apple rethink their policy. Don't they realize that Apple is not the only game in town anymore?

Mitch Che
Geothermex Inc.
Suite 201
5221 Central Ave.
Richmond, CA 94804

Stick to Computers

In addition to learning from the wealth of information contained in the various articles in each issue of BYTE, I find that I also learn a substantial amount by reading the advertisements of the latest products. I am delighted that your magazine has such a diversity of computer products presented in each issue.

This brings me to a problem, however: I really don't care to see advertisements for the Heirloom Library, Ford Motor Company, or whoever else is willing to pay for a page of BYTE.

Please, stick to computers and directly related products and services!

Dr. Alan D. Wilcox
119 Hall Ave.
Clarks Green, PA 18411

Display Manager™

The competitive edge in applications development.

You can significantly reduce development time and provide better application programs with Display Manager from Digital Research. Display Manager lets you interactively design displays faster than ever before, and ensures that whatever features your CRT supports can be used by the program, automatically. Since Display Manager supports most CRT attributes, including flashing, reverse video, underlining, and highlighting, your program is more dramatic and easier to use, no matter what CRT you use.

You can even test a prototype application without a lot of costly and laborious coding. In short, Display Manager

saves time, provides CRT independence and saves memory.

Display Manager works with Digital Research's commercial programming languages, Pascal/MT+™, PL/I-80™, and CB-80™, the CBASIC® Compiler. Combined with Display Manager, they add up to the most powerful programming packages you can buy. So try Display Manager, the advanced productivity tool that makes your CP/M compatible programs better than the competition's. For more information, call Digital Research, (408) 649-5500 or (408) 649-3896, or write to 160 Central Avenue, Pacific Grove, CA 93950.

Circle 146 on Inquiry card.

**DIGITAL
RESEARCH™**
The creators of CP/M™

Europe

Vector International Research Park
B-3030 Leuven, Belgium, 32 (16) 20-24-96
Telex: 26202 VECTOR

Far East

Microsoft Associates
6 Floor A.Y. Building, 3-2-2 Kitaoyama
Minato-ku, Tokyo 107, Japan, 03-403-2120
Telex: 2426875



Our prices have reached a new low! Check 'em out.

16K RAM KITS . . . 13.95

Set of 8 NEC 4116 200 ns. Guaranteed one full year.

DISKETTES

ALPHA DISKS 21.95

Single sided, certified Double Density 40 Tracks, with Hub-ring. Box of 10. Guaranteed one full year

VERBATIM DATALIFE

MD 525-01, 10, 16	26.50
MD 550-01, 10, 16	44.50
MD 557-01, 10, 16	45.60
MD 577-01, 10, 16	34.80
FD 32 or 34-9000	36.00
FD 32 or 34-8000	45.60
FD 34-4001	48.60

DISKETTE STORAGE

5 1/4" PLASTIC LIBRARY CASE	2.50
8" PLASTIC LIBRARY CASE	3.50
PLASTIC STORAGE BINDER w/ Inserts	9.95
PROTECTOR 5 1/4" (50 Disk Capacity)	21.95
PROTECTOR 8" (50 Disk Capacity)	24.95
DISK BANK 5 1/4"	5.95
DISK BANK 8"	6.95

NEC PERSONAL COMPUTERS

PC-8001A CPU	899.00
PC-8012A I/O	559.00
PC-8033A DISK I/O	125.00
PC-8031A DUAL DISK	899.00

ALTOS COMPUTER SYSTEMS

Call Alpha Byte for our low Altos prices.

ATARI COMPUTERS

ATARI 800	679.00
-----------	--------

ATARI 400 (16K)	339.00
ATARI 810 DISK DRIVE	445.00
ATARI 850 INTERFACE	169.00
ATARI 410 PROGRAM RECORDER	75.00
EPSON CABLE	35.00
MEMORY MODULE (16K)	89.95
JOYSTICK CONTROLLER	10.00
PADDLE CONTROLLERS	19.95
STAR RAIDERS	35.00
MISSILE COMMAND	35.00
ASTEROIDS	35.00
PACMAN	35.00

HEWLETT PACKARD

HP CALCULATORS

HP-11C LCD SCIENTIFIC	115.95
HP-12C LCD BUSINESS	128.95
HP-37E BUSINESS	64.95
HP-32E SCIENTIFIC w/ STATS	46.95
HP-33C Programmable Scientific	76.95
HP-41C Advanced Programmable	211.95
HP-41CV Advanced Prog 2K mem	274.95

ACTIVISION ATARI CARTRIDGES

LAZAR BLAST	21.95
SKIING	21.95
DRAGSTER	21.95
BOXING	21.95
CHECKERS	21.95
BRIDGE	21.95
KABOOM	21.95

INTEC PERIPHERALS RAM MODULES

48K FOR ATARI 400	279.00
32K FOR ATARI 800	125.00

HP-41 PERIPHERALS

HP-82106A MEMORY MODULE	27.95
HP-82170A Quad Memory Module	89.00
HP-82143A PRINTER/PLOTTER	324.95
HP-82160A I/L INTERFACE	119.00
HP-82161A DIGITAL CASSETTE	419.00
HP MATH PAC	29.00
HP STATISTICS PAC	29.00

HP REAL ESTATE PAC	39.00
HP SURVEYING PAC	29.00
HP STRUCTURAL ANALYSIS PAC	39.00

HP COMPUTERS

HP-85A PERSONAL COMPUTER	2195.00
HP SINGLE 5 1/4" DISK DRIVE	1295.00
HP DUAL DISK DRIVE	1995.00
HP-85A 16K MEMORY MODULE	239.00
HP-7225B GRAPHICS PLOTTER	2195.00
HP PLOTTER MODULE	605.00
HP HP-IB INTERFACE	329.00
HP STD APPLICATIONS PAC	83.00
HP GENERAL STATISTICS PAC	83.00
HP GRAPHIC PRESENTATIONS	159.00
HP VISICALC PLUS	159.00
HP ROM DRAWER	39.00
HP PRINTER/PLOTTER ROM	116.00
HP MASS STORAGE ROM	116.00
HP RS-232 INTERFACE	329.00

PRINTERS

ANADEX DP 9500	1295.00
ANADEX DP 9501	1295.00
C-ITOH F-10 40 CPS PARALLEL	1545.00
C-ITOH 45 CPS PARALLEL	1770.00
C-ITOH 40 CPS SERIAL	1295.00
C-ITOH PROWRITER PARALLEL	549.00
C-ITOH PROWRITER SERIAL	695.00
EPSON MX-80 W/GRAFTRAX PLUS	\$CALL
EPSON MX-80 F/T W/GRAFTRAX PLUS	\$CALL
EPSON MX-100 W/GRAFTRAX PLUS	\$CALL
EPSON GRAFTRAX PLUS	60.00
IDS PRISM 80 W/O COLOR	1099.00
IDS PRISM 80 W/COLOR	1599.00
IDS PRISM 132 W/COLOR	1799.00
NEC 8023A	485.00
NEC SPINWRITER 3530 P. RO	1995.00
NEC SPINWRITER 7710 S. RO	2545.00
NEC SPINWRITER 7730 P. RO	2545.00
NEC SPINWRITER 7700 D SELLUM	2795.00
NEC SPINWRITER 3500 SELLUM	2295.00
OKIDATA MICROLINE 80	389.00
OKIDATA MICROLINE 82A	480.00
OKIDATA MICROLINE 83A	720.00
OKIDATA MICROLINE 84	1199.00
OKIGRAPH 82	33.95
OKIGRAPH 83	33.95

CORVUS

FOR S-100, APPLE OR TRS-80 MOD I, III

Controller, Case/P.S., Operating System, A & T.	
5 MEGABYTES	3245.00
10 MEGABYTES	4645.00
20 MEGABYTES	5545.00
MIRROR BACK-UP	725.00

APPLE HARDWARE

VERSA WRITER DIGITIZER	259.00
ABT APPLE KEYPAD	119.00
SOFTCARD PREMIUM SYSTEM	625.00
MICROSOFT 2-80 SOFTCARD	299.00
MICROSOFT RAMCARD	159.00
VIDEX 80 x 24 VIDEO CARD	299.00
VIDEX KEYBOARD ENHANCER II	129.00
VIDEX ENHANCER REV 0-6	99.00
M & R SUPERTERM 80 x 24 VIDEO BD	315.00
SSM AIO BOARD (INTERFACE) A & T	165.00
SSM AIO BOARD (INTERFACE) KIT	135.00
APPLE COOLING FAN	44.95
T/G JOYSTICK	44.95
T/G PADDLE	29.95
T/G SELECT-A-PORT	54.95
VERSA E-Z PORT	21.95
MICRO SCI A2 W/CONTROLLER	510.00
MICRO SCI A2 W/O CONTROLLER	419.00
MICRO SCI A40 W/CONTROLLER	479.00
MICRO SCI A40 W/O CONTROLLER	409.00
MICRO SCI A70 W/CONTROLLER	629.00
MICRO SCI A70 W/O CONTROLLER	549.00
THE MILL-PASCAL SPEED UP	270.00
PROMETHEUS VERSACARD	180.00
LAZAR LOWER CASE +	59.00
MICROBUFFER II 16K W/GRAPHICS	259.00
MICROBUFFER II 32K W/GRAPHICS	299.00

MONITORS

NEC 12" GREEN MONITOR	179.00
NEC 12" COLOR MONITOR	399.00
SANYO 12" MONITOR (B & W)	249.00
SANYO 12" MONITOR (GREEN)	269.00
SANYO 13" COLOR MONITOR	469.00
ZENITH 12" HI RES GREEN MONITOR	124.00
AMDEK COLOR I	389.00
AMDEK RGB COLOR II	859.00
AMDEK RGB INTERFACE	169.00
COMREX 12" GREEN MONITOR	165.00

MOUNTAIN HARDWARE

CPS MULTIFUNCTION BOARD	199.00
ROMPLUS W/ KEYBOARD FILTER	179.00
ROMPLUS W/O KEYBOARD FILTER	130.00
KEYBOARD FILTER ROM	49.00
COPYROM	49.00
MUSIC SYSTEM	369.00
ROMWRITER	149.00
APPLE CLOCK	252.00
A/D + D/A	299.00
EXPANSION CHASSIS	625.00
RAMPLUS 32K	149.00

CALIF. COMPUTER SYSTEMS

S-100 BOARDS	
2200A MAINFRAME	459.00
2065C 64K DYNAMIC RAM	539.00
2422 FLOPPY DISK CONT. & CP/M®	359.00
2710 FOUR SERIAL I/O	279.00
2718 TWO SERIAL/TWO PARALLEL I/O	269.00
2720 FOUR PARALLEL I/O	199.00
2810 Z-80 CPU	259.00

APPLE BOARDS

7710A ASYNCHRONOUS S. INTERFACE	149.00
7712A SYNCHRONOUS S. INTERFACE	159.00
7424A CALENDAR CLOCK	99.00
7728A CENTRONICS INTERFACE	105.00

VISTA COMPUTER CO.

APPLE VISION 80-80 COL CARD	329.00
APPLE 8" DISK DRIVE CONTROLLER	549.00

MODEMS

NOVATION CAT ACOUSTIC MODEM	135.00
NOVATION D-CAT DIRECT CONNECT	156.00
NOVATION AUTO-CAT AUTO ANS	219.00
NOVATION APPLE-CAT	325.00
UDS 103 LP DIRECT CONNECT	175.00
UDS 103 JLP AUTO ANS	209.00
HAYES MICROMODEM II (APPLE)	289.00
HAYES 100 MODEM (S-100)	325.00
HAYES SMART MODEM (RS-232)	227.00
HAYES CHRONOGRAPH	199.00
LEXICON LEX-11 MODEM	109.00

TERMINALS

TELEVIDEO 910	639.00
TELEVIDEO 912C	745.00
TELEVIDEO 920C	830.00
TELEVIDEO 950C	995.00
ADDS-VIEWPOINT	599.00

TRS-80 MOD I HARDWARE

PERCOM DATA SEPARATOR	27.00
PERCOM DOUBLER II	159.00
TANDON 80 TRACK DISK DRIVE	429.00
TANDON 40 TRACK DISK DRIVE	289.00
LNW DOUBLER W/ DDSPLUS 3.3	159.00
MOD III DRIVE KIT	649.00

MORROW DESIGNS

FLOPPY DISK SYSTEMS

Controller, P.S., Microsoft Basic, CP/M® A & T.	
DISCUS 20 (Single Drive — 500K)	1075.00
DISCUS 2D (Dual Drive — 1 MEG)	1695.00
DISCUS 2 + 2 (Single Drive — 1 MEG)	1777.00
DISCUS 2 + 2 (Dual Drive — 2 MEG)	2317.00

HARD DISK SYSTEMS

Controller, P.S., Microsoft Basic, CP/M® A & T.	
DISCUS M10 (10 Megabytes)	3345.00
DISCUS M26 (26 Megabytes)	4045.00

ISOLATORS

ISO-1 3-SOCKET	53.95
ISO-2 6-SOCKET	53.95

BARE DRIVES

TANDON 5 1/4 INCH	
100-1 SINGLE HEAD 40 TRK	209.00
100-2 DUAL HEAD 40 TRK	275.00
100-3 SINGLE HEAD 80 TRK	275.00
100-4 DUAL HEAD 80 TRK	399.00

TANDON THINLINE 8 INCH

848-1 SINGLE SIDE	420.00
848-2 DUAL SIDE	515.00

MICRO PRO

APPLE CP/M®	
WORDSTAR*†	222.00
SUPERSDR†	145.00
MAILMERGE*†	79.00
DATASTAR*†	179.00
SPELLSTAR*†	119.00
CALCSTAR*†	149.00

CP/M®

WORDSTAR	285.00
SUPERSORT	168.00
MAILMERGE	103.00
DATASTAR	235.00
SPELLSTAR	155.00
CALCSTAR	199.00

MICROSOFT

APPLE	
FORTRAN*	150.00
BASIC COMPILER*	315.00
COBOL*	550.00
Z-80 SOFTCARD	299.00
RAMCARD	149.00
TYPING TUTOR	17.95
OLYMPIC DECATHLON	24.95
TASC APPLESOFT COMPILER	145.00

CP/M®

BASIC 80	299.00
BASIC COMPILER	319.00
FORTRAN 80	345.00
COBOL 80	568.00
MACRO 80	189.00
mu MATH/mu SIMP	215.00
mu LISP/mu STAR	165.00

APPLE SOFTWARE

MAGIC WINDOW	79.00
MAGIC SPELL	59.00
BASIC MAILER	59.00
DB MASTER	169.00
DB MASTER UTILITY PACK	69.00
DATA CAPTURE 4.0/80	59.95
PFS: GRAPH	89.95
PFS: (NEW) PERSONAL FILING SYSTEM	85.00
PFS: REPORT	79.00
Z-TERM*	89.95
Z-TERM PRO*	129.95
ASCII EXPRESS	63.95
EASY WRITER-PRO	199.00
EASY MAILER-PRO	79.00
EXPEDITER II APPLESOFT COMPILER	73.95
A-STAT COMP. STATISTICS PKG.	129.00
SUPER TEXT II	129.00
LISA 2.5	59.95

CONTINENTAL SOFTWARE

G/L	199.00
A/R	199.00
A/P	199.00
PAYROLL	199.00
PROPERTY MGMT.	399.00
THE HOME ACCOUNTANT	59.95
VISICORP	
DESKTOP PLAN II	189.00
VISIPILOT	158.00
VISITREND/VISIPILOT	229.00
VISIDEX	189.00
VISITERM	79.00
VISICALC	189.00
VISIFILES	189.00

CP/M® SOFTWARE

THE WORD-SPELL CHECK	75.00
d BASE II	599.00
SUPER CALC	209.00
SPELLGUARD	239.00
P & T CP/M® MOD II TRS-80	175.00
COMM X TERMINAL PRG.	82.50
C BASIC 2	115.00
PASCAL Z	349.00
PASCAL MT+	439.00
PASCAL/M	205.00
SYSTEMS PLUS —	
G/L, A/R, A/P, P/R	1799.00
CONDOR I	579.00
CONDOR II	849.00

DIGITAL RESEARCH

MAC	89.00
SID	69.00
ZSID	97.00
PL/ 1-80	439.00

SUPERSOFT

DIAGNOSTIC I	69.00
DIAGNOSTIC II	89.00
'C' COMPILER	179.00
UTILITIES I	59.00
UTILITIES II	59.00
RATFOR	89.00
FORTRAN	239.00

TRS-80 GAMES

TEMPLE OF APSHA I	34.95
HELLFIRE WARRIOR	34.95
STAR WARRIOR	34.95
RESCUE AT RIGEL	24.95
CRUSH, CRUMBLE AND CHOMP	24.95
INVADERS FROM SPACE	17.95
PINBALL	17.95
STAR TREK 3.5	17.95
MISSILE ATTACK	18.95
STAR FIGHTER	24.95
SCARFMAN	17.95

TRS-80 SOFTWARE

NEWDOS/80 2.0 MOD I, III	139.00
LAZY WRITER MOD I, III	165.00
PROSOFT NEWSOFT MOD I, III	99.00
SPECIAL DELIVERY MOD I, III	119.00
X-TRA SPECIAL DELIVERY MOD I, III	199.00
TRACKCESS MOD I	24.95
OMNITERM SMART TERM. MOD I, III	89.95
MICROSOFT BASIC COMP. FOR MOD I	165.00
LOOS 5.1 MOD I, III	169.00

APPLE GAMES

PERSONAL SOFTWARE	
CHECKER KING	21.95
GAMMON GAMBLER	21.95
MONTY PLAYS MONOPOLY	29.95

BRODERBUND

GALAXY WARS	20.95
ALIEN TYPHOON	20.95
APPLE PANIC	24.95
MIDNIGHT MAGIC	29.95
SPACE QUARKS	24.95

AUTOMATED SIMULATIONS

INVASION ORION	20.95
STAR WARRIOR	32.95
TUES. MORNING QUARTERBACK	25.95
CRUSH, CRUMBLE AND CHOMP	24.95
THE DRAGON'S EYE	20.95

MUSE SOFTWARE

ROBOT WARS	32.95
THREE MILE ISLAND	32.95
A.B.M.	20.95
GLOBAL WAR	20.95
CASTLE WOLFENSTEIN	24.95

ON-LINE SYSTEMS

WIZARD AND PRINCES	29.95
MISSILE DEFENSE	25.95
SABOTAGE	20.95
SOFT PORN ADVENTURE	24.95
THRESHOLD	31.95
JAW BREAKER	24.95
CROSSFIRE	24.95

TIME ZONE	69.95
H/R FOOTBALL	32.95
H/R CRIBBAGE	20.95
PEGASUS II	25.95

SIRIUS SOFTWARE

SPACE EGGS	24.95
GORGON	32.95
SNEAKERS	24.95
EPOCK	29.95
BEER RUN	24.95
HADRON	29.95
PULSAR II	24.95
EPOCK	29.95

EDU-WARE

PERCEPTION PKG.	19.95
COMPU-READ	24.95
COMPU-MATH: ARITHMETIC	39.95
COMPU-MATH: FRACTIONS	34.95
COMPU-MATH: DECIMALS	34.95
COMPU-SPELL (REQ. DATA DISK)	24.95
COMPU SPELL DATA DISKS 4-8, ea.	17.95

MORE GREAT APPLE GAMES

COMPUTER QUARTERBACK	32.95
TORPEO FIRE	49.95
THE SHATTERED ALLIANCE	49.95
PDOL 1.5	29.95
ULTIMA	33.95
RASTER BLASTER	24.95
FLIGHT SIMULATOR	27.95
INTERNATIONAL GRAND PRIX	25.95
SARGON II	28.95
SHUFFLE BOARD	29.95
FIREBIRD	24.95
SNACK ATTACK	24.95
THIEF	24.95
ROACH HOTEL	29.95
JABBERTALKY	24.95
THE WARP FACTOR	32.95
COSMO MISSION	24.95
WIZARDRY	37.95
ZORK I	32.95
ZORK II	32.95

SUPPLIES

AVERY TABULABLES

1,000 3 1/2 x 15/16	8.49
3,000 3 1/2 x 15/16	14.95
5,000 3 1/2 x 15/16	19.95

FAN FOLD PAPER

(Prices F.O.B. S.P.)

9 1/2 x 11 18lb WHITE 3,000 ct.	29.00
14 7/8 x 11 18lb WHITE 3,000 ct.	39.00

Alpha Byte

COMPUTER PRODUCTS

To order or for information call
(213) 706-0333
 Modem order line: **(213) 883-8976**

We guarantee everything for 30 days. If anything is wrong, return the item and we'll make it right. And, of course, we'll pay the shipping charges.

We accept Visa and Master Card on all orders; COD up to \$300.00.

Add \$2.00 for standard UPS shipping and handling on orders under 50 lbs, delivered in continental U.S. Call for shipping charges over 50 lbs. Foreign, FPO and APO orders, add 15% for shipping. Californians add 6% sales tax.

Prices quoted are for stock on hand and subject to change without notice.

31245 LA BAYA DRIVE, WESTLAKE VILLAGE, CALIFORNIA 91362

Program Generators

*They're not as easy to use
as some advertising copy suggests.*

George Stewart
Technical Editor

Would you like to be able to tell your computer what you want it to do without ever having to learn a programming language? Well, you can. You simply tell your computer what you want in layman's terms, and it figures out how to accomplish your wish and creates a program to do it.

The software tools that perform this feat are called program generators or application generators. (Technically, a program generator creates a *stand-alone* program that you can list, store, copy, and use. An application generator, on the other hand, generates a software package that is dependent on the application generator: to run your generated program, you use a *run-time* portion of the application generator. In this article, I'll use the term *program generator* to include both kinds.)

The first program generators were written for mainframe computers back in the late 1960s. Their purpose was to increase the productivity of data-processing departments. Now several have been announced for microcomputers and, for the first time, are being aimed at nonprogrammers as well as professional programmers.

Photos by Katherine Coker



The most heavily and boldly advertised package is The Last One, \$600 from D. J. 'AI' Systems Ltd. One typical ad starts out with the headline "Your prayers have been answered." Understandably, the promotion has produced considerable skepticism and controversy in the computer community. Another product introduced with less fanfare is Quic-N-Easi, \$395 from Standard

Microsystems Inc. I'll use these two products as examples in this background report on program generators. (For more specifics on each product, see the text boxes.)

How Program Generators Work

Program generators are *problem-oriented* rather than *procedure-oriented*. In other words, because the program generators possess information about common programming problems like keyboard entry, file input/output, and data sorting, they let you concentrate on the problem you're trying to solve rather than on the special computer procedures required to solve it.

Let's say you want a program that creates a mailing-list file on a floppy disk. First, of course, you must decide exactly how you want information stored in that list—even a manual, paper-based system requires that much. Do you want to store the names in alphabetical order or by member ID? Last name first or vice versa? What's the longest name and how many lines are in the address?

You must also specify the exact steps for inputting and storing names. You would have to do much the same thing if you were explaining your wishes to another person instead of to a computer. Table 1 summarizes the

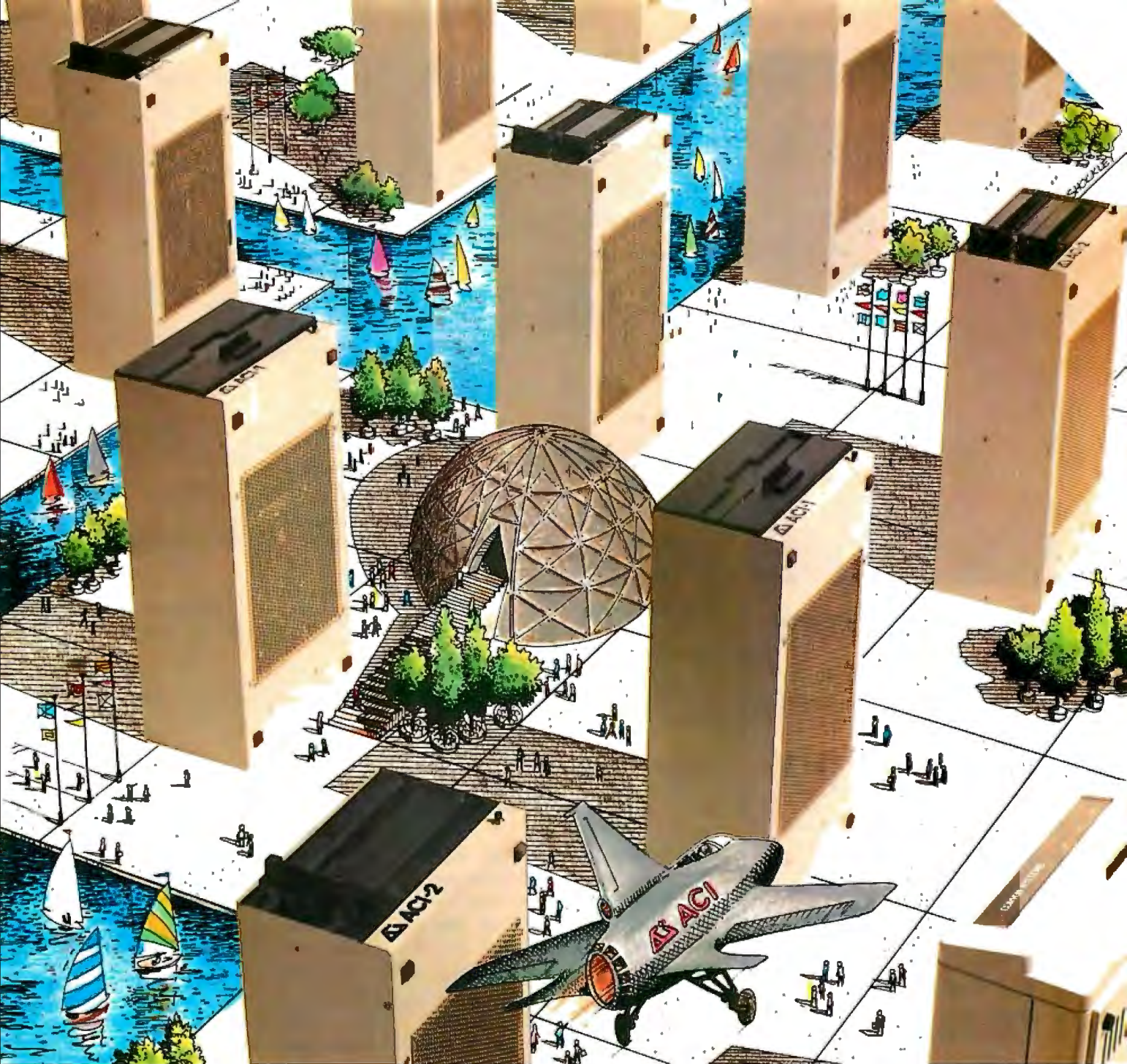

Alspa Computers PLUS Multi-User Hard Disk



SMALL SIZE AND LOW COST

ALSPA full performance, CP/M computers are the smallest 8" drive micro's around. An ALSPA computer with a 4 MHz Z80A CPU, 64K of RAM, one or two 8" floppy drives, three RS-232 serial ports, one parallel port, and one hard disk port is no larger than most single add-on drives, and weighs only about 18 lbs. An ACI-1 can be yours for as little as \$1995.00 plus CP/M.

CORVUS** INTERFACE

Standard on all ALSPA computers in a hardware interface which connects directly to either a Corvus hard disk drive or a Corvus Constellation**, multi-user hard disk system. Our Corvus operation system is easy to install and use.

**Corvus and Corvus Constellation are trademarks of CORVUS SYSTEMS, INC.

SUPERIOR PERFORMANCE

One demonstration will prove that our compact and durable ALSPA computers are designed to provide dependable, powerful computing service. Look at capability and speed and you'll agree we're the best value for the dollar.

DEALER INQUIRIES INVITED



Alspa Computer, Inc.

MORE THAN OUR NAME IS UNIQUE

300 Harvey West Blvd., Santa Cruz, CA 95060 (408) 429-6000

*CP/M is a trademark of DIGITAL RESEARCH, INC.

Circle 16 on Inquiry card.

Compliment your Apple III® or IBM...



Introductory Offer...

COLOR RGB MONITORS
BUY DIRECT!!

\$389⁰⁰

plus \$9.50 shipping & handling.

- * 13" RGB Color.
- * 8 Colors standard.
- * 16 Colors on your IBM or Apple III.
- * Analog
- * Up to 80 Characters per line.
- * 360 Dots per color.
(horizontal resolution)

Apple III and IBM customers please add \$29.50 for factory installed mod board.

MasterCard / VISA / American Express / Prepaid / C.O.D.

Call Toll Free for immediate shipment: **1-800-258-6370**

® Apple III is a registered trademark of Apple Computer.



18 Bridge Street, Salem, NH 03079
Tel. (603) 893-2047
TWX: 710-366-0502

At a Glance

Name
The Last One

Type
Program generator

Manufacturer
D. J. 'Al' Systems Ltd.
Two Century Plaza, Suite 480
2049 Century Park East
Los Angeles, CA 90067
(213) 203-0851

Price
\$600

Format
8-inch or 5¼-inch floppy disks

Language
BASIC

Computer
CP/M systems, Radio Shack TRS-80 Model II, Apple II, Commodore PET

Documentation
Tutorial manual plus machine notes for specific computers

Audience
Nonprogrammers who want custom software

At a Glance

Name
Quic-N-Easi

Type
Program generator

Manufacturer
Standard Microsystems
136 Granite Hill Court
Langhorne, PA 19047
(215) 968-0689

Price
\$395

Format
8-inch or 5¼-inch floppy disk

Language
Machine code

Computer
CP/M systems, Radio Shack TRS-80 Model III

Documentation
Three-ring binder containing tutorial, quick-reference card, and programmer's reference

Audience
Nonprogrammers who want custom software and programmers seeking to speed programming efforts

steps you might take in planning your mailing list.

Now how do you communicate all this information to a program generator? If the program generator is to be useful for nonprogrammers, most of your work should already have been done (in the planning phase just described). You'll probably communicate with the program generator in three phases: data description, screen design, and program procedure.

Data description tells the computer how many pieces of information (fields) exist in each logical file entry (record) and what kind of data goes into each. *Screen design* is the arrangement of headings and prompting messages that the operator will see on the screen. *Program procedure* tells the computer what to do with the data that is typed in. Data description and screen design are relatively straightforward, but the program design phase is where the program generator really shows its stuff (or lack of it).

After you've completed the pro-

gram specification, the generator will take care of the programming details, asking you for additional information whenever necessary. Figures 1 through 4 and listings 1 and 2 show uses of The Last One and Quic-N-Easi to specify the mailing-list application.

Using an ordinary programming language, your task is far more involved. The data description, screen design, and program procedure all must be coded in computer-language statements covering a multitude of details: how to create and initialize a disk file, input each data item from the keyboard, write each completed record to disk, etc. Including steps to handle errors (keyboard mistakes or disk problems) is an especially intricate and burdensome task. Instead of focusing on your problem in layman's terms, you must convert it into technical terms.

Evaluating Program Generators

In your evaluation, you should look for capabilities in six general areas: data entry, program logic spec-

IT TAKES A HOT COMPUTER TO RUN NON-STOP IN A DEEP-FREEZE

Smoke Signal's Chieftain™ computer series: The kind of tough reliability you need today on your business team.

Chieftains are preferred by discerning buyers when extra performance has to be delivered under less-than-ideal operating conditions. The track record this computer has achieved in hundreds of demanding installations worldwide is proof that a Chieftain can meet any challenge your business environment has to offer.

Select from a family of field-proven systems.

Chieftains range from floppies to this 5¼-inch Winchester hard disk system with 20-megabyte tape streamer option.

It's available with the new OS-9 Level I and II, multi-user, UNIX comparable operating system for mainframe-like performance.

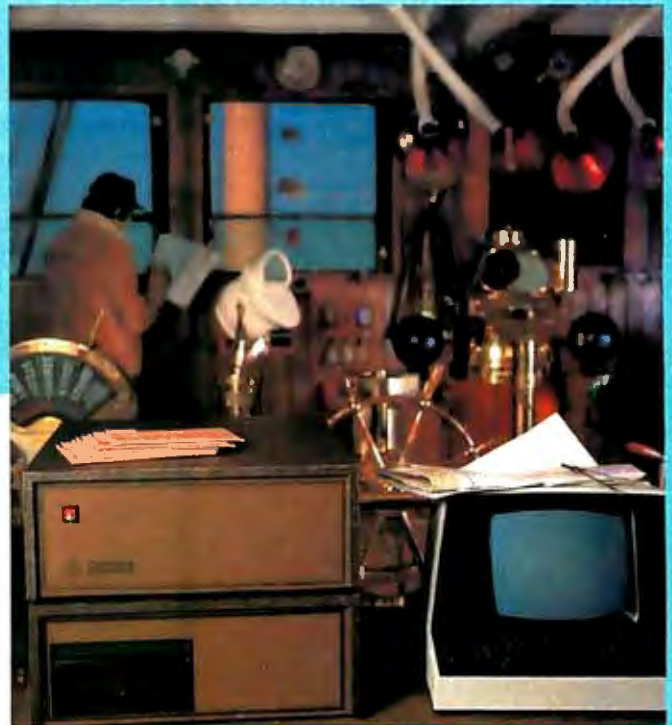

6809-based Chieftains deliver six months of continuous operation at Arctic Circle

Two Chieftains accompanied an Adak research expedition during the frigid winter of 1981. The computers fulfilled a vital support role for an earthquake prediction study. In sub-zero temperatures, rain, snow, ice and wind-driven weeds and dust, the extraordinary Chieftains — supported by Smoke Signal's factory-based staff — proved they were up to the challenge.



All Chieftains are so cost-effective and advanced, they obsolete most other systems available today at any price.

Whether you select an upward-compatible 5¼- or 8-inch floppy disk system, or 5¼- or 8-inch hard disk configurations of 4- to 60-megabyte capacity, you'll receive Chieftain's widely acclaimed quality — plus value that makes your dollar go a lot further. Smoke Signal's huge software array begins at comprehensive business programs, and expands into esoteric applications for rare and specialized tasks.

Here's a sampling of the latest additions to the Chieftain hard disk computer systems that are destined to change the way you think about data processing:

THE CHIEFTAIN 95W4

4-megabyte, 5¼-inch Winchester with a 360-k floppy disk drive

THE CHIEFTAIN 98W15

15-megabyte, 5¼-inch Winchester with a 1-megabyte 8-inch floppy disk drive

THE CHIEFTAIN 95XW4

4-megabyte, 5¼-inch Winchester with a 750-k octo-density floppy disk drive

THE CHIEFTAIN 9W15T20

15-megabyte, 5¼-inch Winchester with a 20-megabyte tape streamer

WRITE OR CALL TODAY FOR DETAILS ON THE TOTAL CHIEFTAIN SERIES . . . AND ON DEALERSHIP OPPORTUNITIES STILL AVAILABLE . . .

Smoke Signal Broadcasting • 31336 Via Colinas, Westlake Village, CA 91362 • (213) 889-9340



SMOKE SIGNAL
Chieftain Computers

Circle 370 on Inquiry card.

Name _____
Title _____
Company _____
Address _____
City _____
State _____ Zip _____
Telephone () _____

Did you know
that with
the new

UCSD*

P-SYSTEM

VERSION IV

you can write
programs in



and run them on

ALTOS, APPLE,
COMMODORE,
CROMEMCO, DEC, IBM,
INTERTEC, PHILIPS,
OHIO SCIENTIFIC,
RADIO SHACK, TERAQ,
TEXAS INSTRUMENTS,
VECTOR GRAPHIC,
XEROX, ZENITH,
and many more...

without change!

(Think about that next time
you want a larger market)

We support systems
software and/or applica-
tions ready-to-run on

APPLE, DEC LSI-II‡,
RADIO SHACK
MODEL II§ & III§ and ALTOS.

PCD SYSTEMS

P.O. Box 143
Penn Yan, NY 14527
315-536-7428

‡TM Digital Equipment
§TM of Tandy Corp.
*TM U. of California

ification, file storage, report generation, calculations, and editing convenience.

Data entry: Getting information into the computer, as illustrated in the mailing-list application previously described, is the bread and butter of program generators. It's the simplest part of most programs and yet often the most tedious to program. A good program generator should allow easy creation of display forms, the screen layouts that prompt the operator for data. Photo 1 shows a typical display form. Ideally, you should be able to construct the display form on the screen, not on paper, and modify the screen-input form without modifying the entire application program. Checks for invalid entries should be provided automatically by the program generator.

Program logic specification: How hard is it to tell the computer what you want? That depends on how much knowledge is embedded in the program generator. To take a few minor examples, does the program generator know what alphanumeric data looks like (A-Z, a-z, 0-9, ., +, -), or do you have to make up a procedure to check the validity of each entry?

As a general rule, if an operation is generically repetitive (such as searching through a table for a specific en-

Description of each member record:
Last name (15 letters)
First name (10 letters)
Member ID (5 digits)
Date of last contact (8 characters as mm/dd/yy)
Street (25 characters)
City (20 letters)
State (2 letters)
Zip (5 digits)

General description of program operation:

1. Ask operator to type in a record (e.g., information for one member).
2. Check all entries for validity.
3. Write the information to the disk file.
4. Ask operator if there are member records to be entered; if there are, then repeat step 1.
5. If not, end the program.

Table 1: Details of mailing list to be worked out before using the program generator. Numbers in parentheses are maximums for each item.

try), you shouldn't have to take great pains specifying the procedure to accomplish it. If you do, then you, not the program generator, are doing most of the programming work.

File storage: This is an important characteristic of program generators, and it may take some careful study. Does the program generator allow both major types of file storage—sequential and random access? Sequential access allows you to read information in the same order in which



Photo 1: A data-entry screen created with Quic-N-Easi.

OUT OF A GALAXY OF MULTIUSER SYSTEMS ARRIVES...

HARDWARE
SOFTWARE



SIERRA DATA SCIENCES

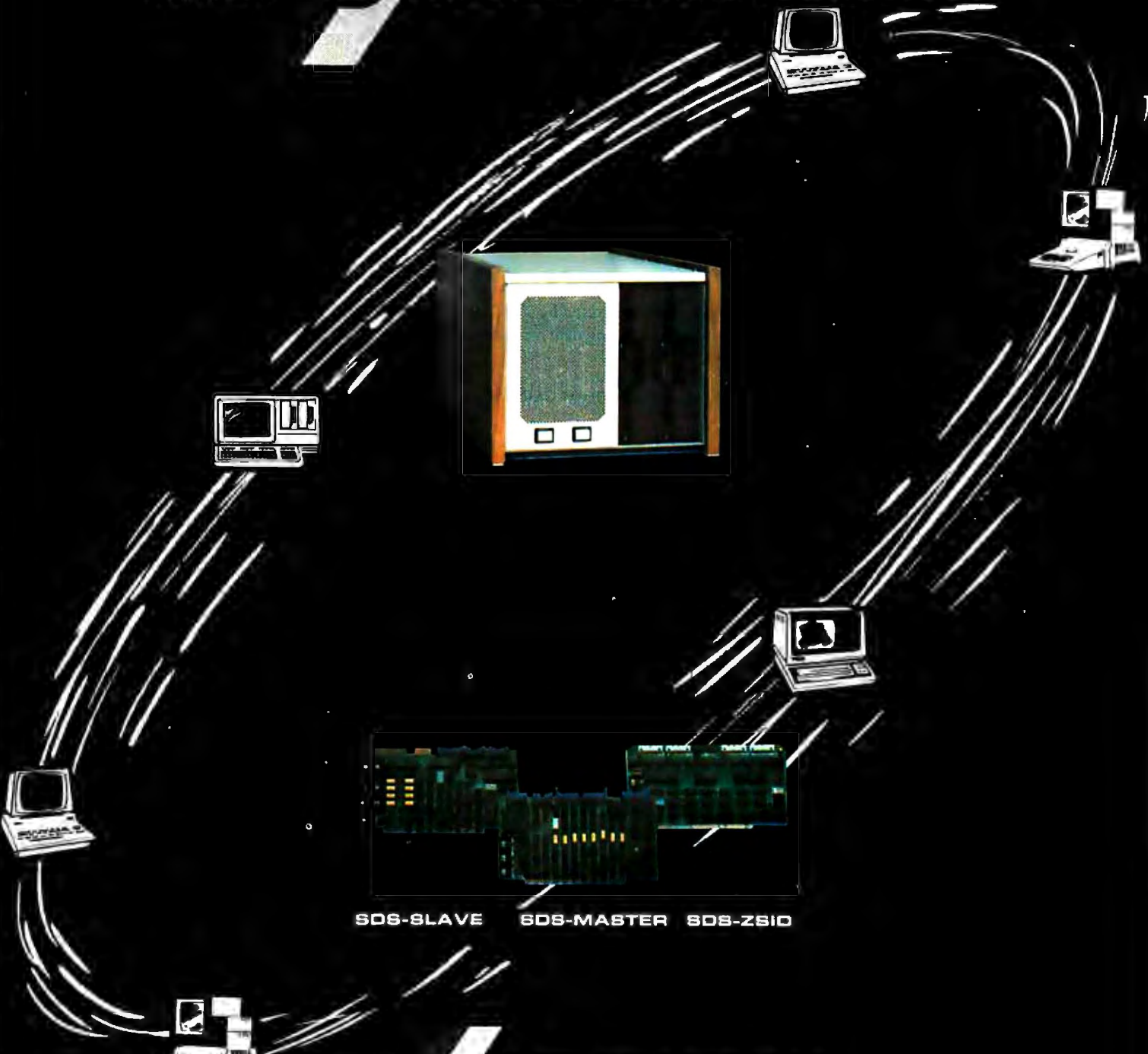

SDS-SLAVE SDS-MASTER SDS-ZSID

HARDWARE
SOFTWARE



SIERRA DATA SCIENCES

Fresno, California

Marketing Division

21162 Lorain Ave./Fairview Park, Ohio 44126 / (216) 331-8500

Field =====	Field Label =====	A/N/D =====	Field Size =====
1	LAST NAME	Alpha	15
2	FIRST NAME	Alpha	10
3	MEMBER ID	Numeric (0)	6
4	DATE OF LAST CONTACT	Date	8
5	STREET	Alpha	25
6	CITY	Alpha	20
7	STATE	Alpha	2
8	ZIP	Numeric (0)	6

Figure 1: The data description for the mailing-list program using The Last One.

```

1      .. Open MEMLIST file
2      .. Set pointer to the end of MEMLIST file
3      .. Keyboard input using labels from MEMLIST
4      .. Write data to MEMLIST file
5      .. Ask user < ANY MORE RECORDS TO ENTER >. If yes branch to 3
6      .. Terminate program

```

Figure 2: The procedure description for the mailing-list program in the form of a general flowchart using The Last One.

Listing 1: A small part of the BASIC mailing-list program generated by The Last One. The total dialogue required to specify the program is not shown. The application specified here is for entering new records only; another program would be needed to update existing records.

```

8 CLEAR 5000:DEFDBL N:DEFINT R:ONERRORGOTO60000
9 DIM AA$(8)
10 CLOSE:OPEN"D",1,"MEMLIST:1",92
11 FIELD 1,15 AS AA$(1),10 AS AA$(2),6 AS AA$(3),8 AS AA$(4),25 AS AA$(5),20 AS
AA$(6),2 AS AA$(7),6 AS AA$(8)
12 RC(1)=LOF(1)+1
13 CLS:X8=0:X9=0
14 PRINT@(1,26),"MAILING LIST CREATION PROGRAM"
15 PRINT@(6,1),"LAST NAME":PRINT@(6,12),STRING$(15,46):PRINT@(6,12),:LINEINPUTS
$:IFLEN(S$)<=15THEN17
16 PRINT@(6,12),SPC(LEN(S$)):GOTO15
17 LSET AA$(1)=S$
18 PRINT@(6,40),"FIRST NAME":PRINT@(6,53),".....":PRINT@(6,53),:LINEINPUTS
$:IFLEN(S$)<=10THEN20
19 PRINT@(6,53),SPC(LEN(S$)):GOTO18
20 LSET AA$(2)=S$

```

it was written. Random access allows reading, writing, or updating information in any order. For applications that require frequent updates of information scattered throughout a file, random access is almost a necessity. Some program generators offer a third kind of file access called indexed sequential. In effect, your data is sorted automatically as it is entered. Instead of referring to data in terms of arbitrary record numbers, you can refer to it in terms of filing keys. The same thing can be accomplished through random-access files, but you have to provide the indexing.

Another important feature is interactivity. Do all data files have to be explicitly named during program generation, or can the end user specify files at run time? For example, suppose you have generated a sorting program. Can the operator enter the name of the file to be sorted, or does the generated program have to know about it in advance? The answer to these questions will tell you much about the flexibility of a program generator.

Equally important, what file structures are available? Can information be defined in a hierarchy? In a mail-

ing list, can a list of family members be grouped under "member name" or a list of previous addresses be grouped under "address"? You can write powerful applications programs more simply if the program generator has built-in facilities for such *hierarchical data*.

Report specification: When it comes to outputting results, is it easy to explain your desired report format to the program generator? You should not have to go to great lengths to have headings and subheadings inserted at the appropriate positions. If many columns are to be printed, you

PRODUCTS FOR THE APPLE II COMPUTER

Give More Drive To Your



MACRO-88 8088 PROCESSOR BOARD

With MS-DOS \$799 CDN
\$699 US

- Apple can now run high-speed 16 bit software.
- True multiprocessing capability
- Interface to expansion memory allows up to 1 Mbyte of memory to be DIRECTLY addressable using 1 or more DISKULATORS. Contiguous memory is thus available for MS-DOS, UCSD PASCAL IV OR CP/M86.
- Supplied with MS-DOS.
- Socket on board for 8087.
- Macro assembler for use with MS-DOS available.

DISKULATOR

128k - \$795 CDN
\$599 US

- 64K/128K MEMORY BOARD FOR THE APPLE - the MACRO-MACROMEM.
- Disk emulation software for DOS 3.3, PASCAL AND CP/M - completedisk can be downloaded in 20 seconds!
- EXPANDABLE TO 384K (PIGGY-BACK board).
- Special circuitry for low current.
- Inter-faces to the MACRO-88 for contiguous memory for the 8088.
- Information on DISKULATOR can be accessed by the 6502 or 8088 in 4k banks.
- The most flexible and expandable Ram board for the Apple.
- VC-EXPAND and VC-EXPAND 80 for 64k and 128k boards for Visicalc expansion.

MACROMEM-1

\$195 CDN
\$139 US

- 16k memory board for the Apple II.
- DOS 3.3 MACRODISK SOFTWARE included.
- PASCAL and CP/M MACRODISK options.

MACROMEM-2

\$299 CDN
\$239 US

- 32k memory board for the Apple II.
- With software for moving DOS into one 16k bank. Second BASIC language can be loaded into the second bank.
- RAMEXPAND allows overlaying of programs and storing of large arrays in the memory board - effectively expanding the Apple memory for Applesoft.
- PSEUDODISK software included.
- VC EXPAND and VC-EXPAND 80 available.

MACRODISK FOR 16K BOARDS

\$59 CDN
\$49 US

- MACRODISK software turns one or more memory boards into a disk emulator.
- Free with all Macrotech memory boards.
- SAVE, BSAVE, RUN, BRUN, and other commands can be made to/from memory board as if it were a normal disk.
- Speed of transfer typically 2 to 10 times that of a real disk.
- Equivalent PASCAL and CP/M MACRODISK also available - Particularly valuable to PASCAL users as the 'second' disk drive in the system can be a MACRODISK - NO NEED TO BUY YOUR SECOND DRIVE!!
- Pascal Macrodisk automatically set up on boot.

VC-EXPAND and VC-EXPAND 80 VISICALC EXPANSION

software by Saturn Systems available for 32k, 64k, and 128k memory boards - expansion of array size and use with 80 column boards.

MACROPRINT Parallel Interface

\$175 CDN
\$139 US

- Parallel INPUT AND OUTPUT inter face for Apple.
- Compatible with Apple software and hardware.
- Inverted acknowledge and strobe for printers requiring them.
- Low Res and Hi Res Graphics Dumps.
- An all-round best parallel board at best prices.
- Many many extra Commands - margin, width etc.
- Also the most attractive looking!

MACROPEATER - AUTOREPEAT BOARD

\$35 CDN
\$29 US

- Enables autorepeat on the Apple II.
- Press a key, hold down for a second and it will be repeated until released.
- Invaluable for VISICALC and word processing applications.
- Versions for old and new keyboards.
- Simple to install - no wiring!
- Compatible with other hardware or software including keyboard enhancer.

DOSTILITIES

\$59 CDN
\$49 US

- Password protection for DOS 3.3 disks.
- CATALOG MODS of all sorts - double catalogs, file-type I.D. mods etc.
- Error instruction modification.
- Printer-dump utility.
- Editor for EXEC TEXT FILES.
- Most valuable general utility for APPLE PROGRAMMERS.

Dealer and distributor inquiries most welcome

- Apple II is a trademark of Apple Computer Inc.
- CP/M is a trademark of Digital Research Corporation.
- MS-DOS is a trademark of Microsoft Consumer Products Inc.
- U.C.S.D. is a trademark of Regents of the University of California.
- VC-EXPAND is a trademark of Saturn Systems LTD.

MACROTECH Computer Products LTD is also a distributor for:

Quality Software, Prometheus Products, Continental Software, Avante Garde Creations, Saturn Systems, Rocky Mountain Software, Xebec, A.L.S. etc. etc. and many more.

Payment may be made by VISA, certified check or money order.

MACROTECH Computer Products LTD
4116 Grace Crescent
North Vancouver, B.C. V7R481
604-986-7633

MACROTECH Computer Products LTD. is also seeking other designers or manufacturers who are interested in MACROTECH Producing hardware or software products for the Canadian and international markets for dealer distribution (Considering the Canadian - U.S. dollar exchange rate this may be the only way for you to get your product to the market effectively in Canada).

MACROTECH Computer Products Ltd.



shouldn't have to worry about squeezing them all in. The program generator should take care of that by breaking the column headings into two or more lines, etc.

Calculations: Most applications will require some calculations on the data: comparisons between names, arithmetic operations, etc. Obviously, you will need to understand the required operations fully before you

can explain them to the program generator. However, you should be able to enter the necessary operations and formulas without resorting to computerese. For example, if you want to update an account balance, you should be able to accomplish this in a straightforward manner such as:

NEW BALANCE = OLD BALANCE -
PAYMENT RECEIVED

You should *not* have to resort to formulas like this:

$$V1 = V2 - V3$$

Editing convenience: This may be the most important aspect of a program generator, since 60 to 80 percent of programming time is usually devoted to maintenance (modification) of existing programs. Obviously,

MEMBER ID: #####

LAST NAME: #####

FIRST NAME: #####

DATE OF LAST CONTACT: ##/##/##

STREET: #####

CITY: #####

STATE: ##

ZIP: #####.

PRESS <F1> TO UPDATE THIS RECORD
PRESS <ESC> <1> TO LEAVE IT UNCHANGED (CANCEL ALL CHANGES)
PRESS <ESC> <0> TO EXIT FROM THIS PROGRAM

Figure 3: The screen layout for the mailing-list program using Quic-N-Easi. The "#" signs show the size and position of keyboard input fields.

OFFSET	FIELD	LEN	R	C	DESC	JUST	FILL	MY-EN	MU-EN	MU-FL	MU-TB	PROC
0	ID	5	3	12	D	R	Y	Y	N	N		GETRECORD
1	LASTNAME	15	6	12	x	L	Y	N	N	Y		
2	FIRSTNAME	10	6	53	x	L	Y	N	N	Y		
3	MONTH	2	9	23	D	R	Y	N	Y	Y		
4	DAY	2	9	26	D	R	Y	N	Y	Y		
5	YEAR	2	9	29	D	L	Y	N	Y	Y		CHECKDATE
6	STREET	25	13	9	x	L	Y	N	N	Y		
7	CITY	20	16	7	x	L	Y	N	N	Y		
8	STATE	2	16	48	A	L	Y	N	Y	Y		
9	ZIP	5	16	63	D	L	Y	N	Y	Y		

Figure 4: The data descriptions given to Quic-N-Easi. Column abbreviations used are LEN=field length, R=display row, C=display column, DESC=data description, JUST=justification (left or right), FILL=character, MY-EN=may enter, MU-EN=must enter, MU-FL=must fill, MU-TB=must tab, and PROC=procedure associated with this field. As soon as the operator types in a member ID number, the GETRECORD procedure gets the member record, if it has been written. The CHECKDATE procedure ensures that the operator enters a valid date as mm/dd/yy.

NOW- Fully Transparent Mass Storage Systems For Your Personal Computer.

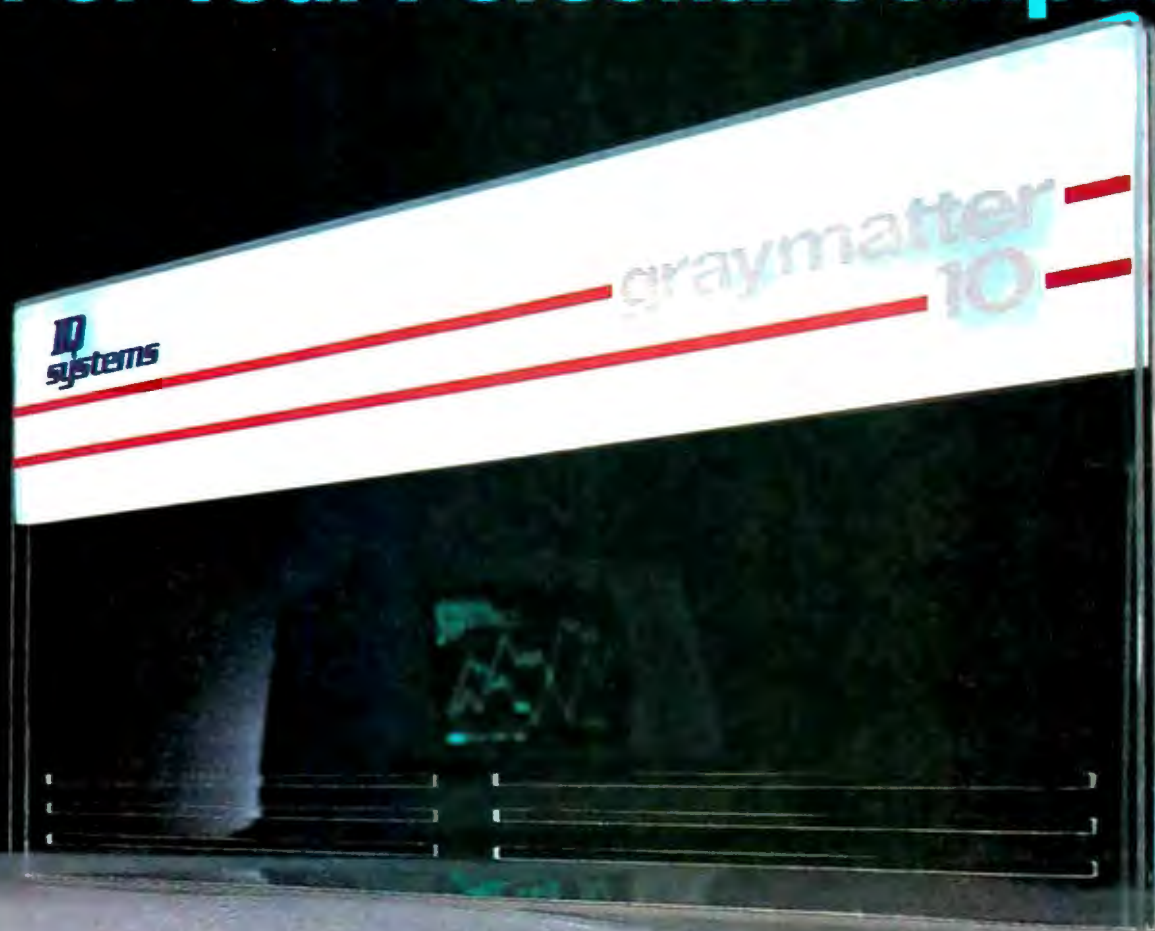

The
graymatter™ by **IQ systems**
Brea, California

Transparent Operation—Visible Results.

The graymatter is available in 5, 10, 15 & 20 Mbyte storage systems.
Contact Your Local Computer Dealer for more Information.

Distributed by:



Professional Integration 2701 Saturn Street, Brea, CA 92621 (714) 524-2470

WE DROVE THE COST OF DISK DRIVES WAY DOWN



Apparat continues to expand our line of IBM PC compatible products. Buy a minimum IBM system from any dealer, then look to Apparat to complete and expand it. And save about 25% over a comparable system. You will even find that we've developed some products you can't find from any other manufacturer or distributor.

IBM compatible add-in and expansion drives.

- Single and Double sided 40 track drives. Both drives (Tandon or CDC available) are fully supported by PC DOS version 1.1, and you can mix or match. Drives are easily installed in minutes. Single sided (160k) — \$225 each, Double sided (320K) — \$315 each.
- Double sided 80 track (650K) Tandon drive. Easily installed in

minutes. Requires software patch — \$435.

- Expansion cabinet for 3rd and 4th drives. Any of the IBM compatible drives above are easily mounted into the matching case. Power supply and cable included — \$275. With 2 dual 40's internally and 2 in the expansion cabinet you have over 1.2 megabytes of storage on-line and supported by an unmodified PC DOS 1.1.

SO YOU CAN DRIVE YOUR IBM PC CAPABILITIES WAY UP



More savings on these add-ons.

- **Combo Card.** Adds parallel printer, RS 232 asynchronous communications and clock calendar functions. Uses only one slot and includes RS 232 cable — \$279.
- **Clock Calendar Card.** Features seconds, minutes, hours, day of week, date, month and year. Battery backup maintains time and date even when system is turned off. Software compatible with PC DOS — \$129.
- **Prototype Card.** 3.5 by 8 inch wirewrap area holds over 85-14 pin dips — \$29.95.
- **64K Byte Hardware Print Spoolers.** Internal spooler comes with parallel printer adapter. External version connects easily between computer and printer. Both

buffer 32 pages of print output and are user programmable — \$399.

- **Add-On Memory Card.** Uses 64K dynamic RAM chips, with parity. All are expandable to 256K. 64K — \$299, 128K — \$399, 192K — \$499, 256K — \$599.
- **Monitors.** High quality, reliable, 12 inch green screen. NEC, 20 MHz BW — \$195, Amdek, 18 MHz BW and anti glare — \$180.
- **Printers.** A variety of the newest Epson, NEC and Okidata printers available. Call for prices.
- **48K Additional Ram.** 27 chips plug easily into master PC board — \$75.
- **RGB Color Monitors.** Includes cable and modification to include 16 colors — intensity control. NEC (resolution 690 by 230) — \$995, Amdek (560 by 240) — \$899.

- **From Blaster.** Programs most 4K to 64K bit 24 PIN EPROMS. Complete with personality modules and read/write software — \$149.
- **Apparat Game Diskette.** Includes blackjack, othello, matches and spiralgraph — \$24.95.

Apparat will continue to develop add-on products for your IBM PC. And Apparat warrants and services all the products we sell. Call today to order any of the products listed here or to find out more information write Apparat, Inc., 4401 So. Tamarac Parkway, Denver, CO 80237, (303) 741-1778. Dealer inquiries welcome. To order any product today call

800/525-7674.

IBM PC is a trademark of IBM.



Apparat, Inc.



Listing 2: *The procedures you must specify using the Quic-N-Easi language for the mailing-list application. In effect, you write this "program"; however, it is much shorter and simpler than an equivalent program written in an ordinary programming language. This application uses indexed sequential files and allows you to update existing records.*

```
10: * FUNCTION KEY PROCEDURE
10:     PROC KEY0
10:     CLOSE 1
10:     SYSTEM
10:     END
10:     PROC KEY1
10:     UNLOCK ID
10:     HOMECLEAR
10:     END

100:     PROC GETRECORD
100:     IF ID GE 1 AND ID LE 200 THEN GOTO 10010
100:     ERROR "MEMBER ID NUMBER IS OUT OF RANGE: [1 - 200]"
100:     CLEAR ID
100:     RESUME
100:     END
100: 10010  POSN 1 TO ID
100:         READ 1: 10020
100:         GET * FROM 1
100:         LOCK ID
100:         END
100: 10020  UNLOCK ID
100:         END

200:     PROC LOAD
200:     OPEN "MEMLIST",3,97,1: 20010
200:     END
200: 20010  MAKE "MEMLIST",3,97,10,5,1: 20020
200:     END
200: 20020  ERROR "CAN'T CREATE FILE"
200:     SYSTEM
200:     END

300:     PROC ENTER
300:     UNLOCK ID
300:     RESTART 1
300:     PUT * TO 1
300:     WRITE 1: 30010
300:     SECURE 1: 30020
300:     END
300: 30010  ERROR "ERROR IN WRITING RECORD"
300:     CLOSE 1
300:     SYSTEM
300:     END
300: 30020  ERROR "ERROR IN SECURING FILE"
300:     CLOSE 1
300:     SYSTEM
300:     END

400:     PROC CHECKDATE
400:     IF MONTH LT 1 OR MONTH GT 12 THEN GOTO 40010
400:     IF DAY LT 1 OR DAY GT 31 THEN 40010
400:     END
400: 40010  ERROR "ERROR IN DATE FORMAT --- USE MONTH/DAY/YEAR"
400:     CLEAR MONTH
400:     CLEAR DAY
400:     CLEAR YEAR
400:     NEXT MONTH
400:     END
```

QUME

It doesn't cost more
to make the best
impression
with Qume.

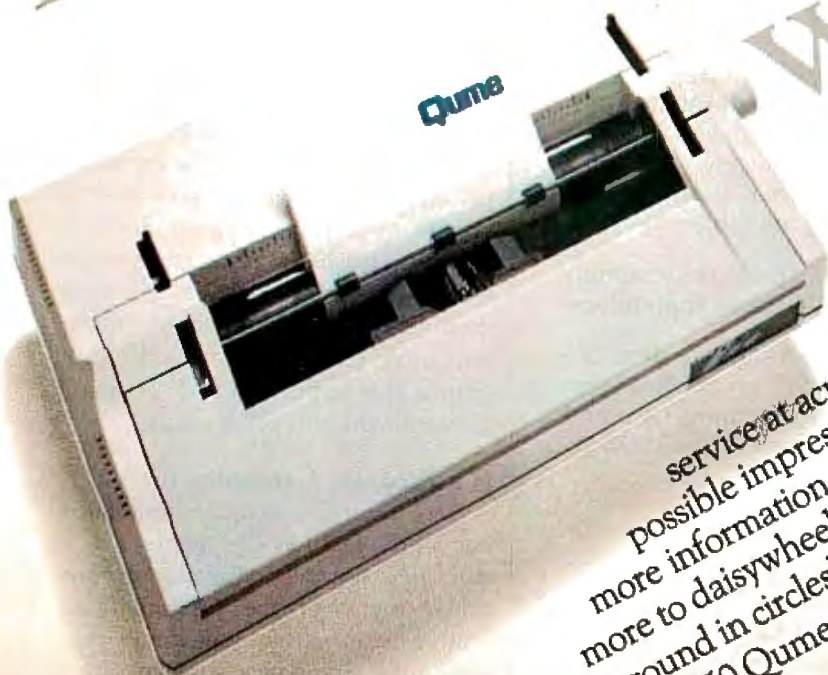

When you buy a Qume daisywheel printer, you get superior speed and reliability at competitive prices, while other companies simply offer inexpensive printers. Now you can have close-to-home quality and service at across-the-ocean prices. So make the best possible impression with a Qume daisywheel printer. For more information and a free copy of our booklet, "There's a lot around in circles," call or write Qume (408) 942-4000. 2350 Qume Drive, San Jose, California 95131.

Qume[®]
A Subsidiary of ITT

Circle 348 on Inquiry card.

Microprocessor Independent Program Library



THE *UNIQUE* CROSS-COMPILER FOR MICROPROCESSOR INDEPENDENCE

With **PLMX** you are no longer restricted to any one microprocessor. **PLMX** is a flexible cross-compiler that generates code for the **8080/8085**, **Z-80**, **1802**, **6800/6802/6809**, and **9900** microprocessors and executes under **TEKDOS***, **DOS/50***, **CP/M****, and **CP/M** derivative operating systems. This flexibility enables you to convert your existing **PL/M** libraries into a Microprocessor - Independent Program Library.

PLMX implements the structured syntax of **PL/M** and produces assembly language source files which can be assembled for **ROM-based** applications.

And **PLMX** offers the features you are looking for in a software development tool: portability, better program organization, more efficient management of large programming jobs and savings in programming time and money. **Protect your software investment, contact Roger Carlson - TODAY. He'll tell you all about PLMX.**

 **SYSCON**
CORPORATION
4015 Hancock Street • San Diego, CA 92110
Phone (714) 292-PLMX • TWX (910) 335-1660

* **TEKDOS** and **DOS/50** are trademarks of Tektronix, Inc.
** **CP/M** is a trademark of Digital Research, Inc.

you'd like to use the program generator to modify your generated programs, rather than deal with them directly. Can you change one part of a program—for example, the report format or the screen input format—without having to go through the entire specification procedure again? If you change the data-file structure, will this change be automatically reflected in the programs using that file? Ideally, changes in one part of a program or file should be reflected automatically throughout.

What kind of program is generated? It varies from one product to another. The Last One produces a stand-alone BASIC program. The BASIC program is intended for use with your machine's built-in BASIC interpreter. Quic-N-Easi produces format files and procedures that can

**Editing convenience
may be the most
important
aspect of a program
generator.**

be executed only by the Quic-N-Easi run-time package.

Each approach has advantages and disadvantages. When the final program is written in a standard language like BASIC, you have more flexibility in using it. If you know the programming language, you may be able to modify the program directly. On the other hand, programs such as Quic-N-Easi that use a run-time module may be considerably faster and more efficient than BASIC programs; this applies to both program development and program use.

Is a Program Generator for You?

Even though a program generator has all the features I've mentioned, it still may not be for you. For one thing, many of the program generators assume that you know programming. Some program generators require you to learn a specification language—usually quite simple. Using such a language will require that you master at least a few elementary

Performance Breakthrough...

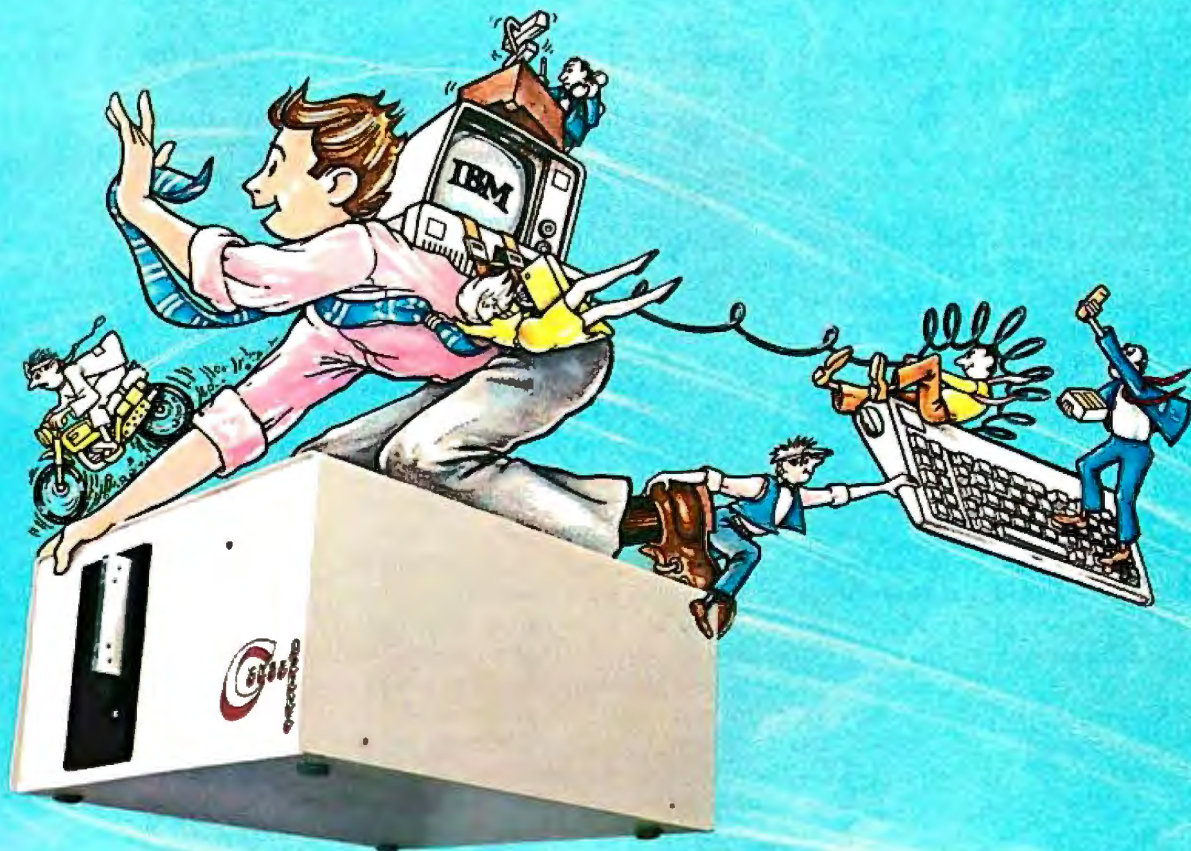

... the **CYBERDRIVE™** for the **IBM Personal Computer**

13.5 or 27 million bytes of disk capacity in a single cabinet with an integrated mini-cartridge tape for secure data backup.

Setting an exciting new microcomputer standard, the **CYBERDRIVE™** combines a full package of features.

It offers new, higher performance levels, with an integrated business-oriented backup device.

As the **CYBERDRIVE** is made available for other systems, media transfer is assured regardless of the host hardware or Operating System.

The **CYBERDRIVE** slashes the seek time dramatically—e.g. the usual 5 Megabyte stepper-motor Winchester disk offers average seek time typically in the range of 100 to 200 milliseconds (incl. head settling).

With the **CYBERDRIVE**, the average seek time across more than five times as much data is only 33 milliseconds (incl. head settling).

This basic speed, coupled with disk cache buffering and a peak transfer rate of 1 million bytes per second, make the **CYBERDRIVE** a performance champ!

The integrated mini-cartridge tapes used for backup of data allow dumping of (for example) 10 million bytes of data in about 10 minutes... much faster than other tape or floppy disk backup techniques. Hardware read-after-write error checking is incorporated in the tape device.

... And don't fail to ask about our superb lineup of serious business software (also offered in **CYBERDRIVE** format) including:

RM/COBOL™ compiler—the micro industry standard.

MBSI™ RM/COBOL general business applications (derived from **MCBA™** minicomputer packages)... thousands in use... money back guarantee... source program license.

CRT!™ from Cybernetics (COBOL Reprogramming Tool!)- Program generator for **RM/COBOL** to ease program development and maintenance... an alternative to a Data Base System.

CBASIC™ & **CBASIC86™** compilers... for aficionados of a useful BASIC.

The software is available on a variety of industry-standard Operating Systems including **CP/M™**, **MP/M™** (both -80 & -86), **OASIS™**, **PCDOS™**, and **UNIX™**. Inquire for specific details and prices.

Trademarks of:

1. Cybernetics, Inc. 2. Ryan-McFarland Corp. 3. Micro Business Software, Inc.
4. Mini-Computer Business Applications, Inc. 5. Digital Research, Inc. 6. Phase One Systems, Inc. 7. Bell Laboratories

The Last One

The rather grandiose idea implicit in the product's name is that it will be the last program you ever need to buy. If that is indeed the case, the reason will probably be that you give up computing out of sheer frustration with *The Last One*.

The Last One is written entirely in BASIC. It consists of dozens of separate program and data files comprising more than 175,000 bytes of code (on the Model II version). In terms of sheer program size, D. J. 'AI' Systems is certainly giving you your money's worth. Of course, programs can't be rated solely in terms of cost per byte of code. Far more important is how useful the code is.

The Last One is a fully menu-driven system; that means at every stage of its operation, the screen lists currently available options. For example, when you start the program, you see the main dispersal menu:

```
Create program.....<1>
Modify program.....<2>
Modify file.....<3>
External files.....<4>
Enquiry.....<5>
Certify new disk.....<6>
Return to BASIC.....<7>
```

Each time you select an option, *The Last One* must load the appropriate program and run it. This makes the system quite sluggish. Most of your time is spent watching the computer display the message "Please wait...working." Because of a complex hierarchy of menus, skipping from one activity to another (from, for example, screen design to procedure specification) is tortuous if not impossible.

Sample Use

For generating routine data-entry applications (such as the mailing list described in the main article), *The Last One* is acceptable but cumbersome. You start by specifying exactly what information goes into the file. You assign a name to each field, describe the field (any characters, numeric only, or date-format data), and specify the field size. Having only three data types puts a larger burden on you to check data entries for valid informa-

tion; often you will need to ensure that the data falls into a much narrower category (compare with *Quic-N-Easi*). If you make a mistake, you can correct it by retyping all the information for the affected field.

After describing the data, you set a "file pointer," which determines the position in the file where input/output will begin. This is probably the first place where previous computer knowledge is useful.

Next you specify the program logic in two steps. Using a "flowchart creation menu," you select the desired sequence of operations for your program. Figure 2 shows the steps used to program the mailing-list application. When you're done with the flowchart, you have a very general description of the program logic. However, most of the work is yet to be done.

The next phase is called "coding," and it's by far the most tedious. All the generalities of the flowchart must be turned into specific procedures. Wherever you have indicated a branch (change in program flow), you now specify the destination of the branch, referring back to the original flowchart. Wherever you have specified "input from keyboard" in the flowchart, you will now be prompted to design an input screen. *The Last One* doesn't have a full-featured screen editor, so you must locate the prompting fields using row and column numbers. To change a completed screen, you must erase it and start all over.

Wherever you have indicated calculations, *The Last One* will ask you to specify them as formulas. Unfortunately, you cannot use the field names but must resort to meaningless symbols like V1, V2, V3, etc.

Outputting results is similar to keyboard input: you specify the output format by relating data fields to various rows and columns on the screen. *The Last One* will go through the entire list of variables in your program and ask where each one of them is to be output. Typically, only a very few of them are desired as output. This means much needless effort.

When the generalities have all been reduced to specifics, *The Last One* will generate a BASIC program. The final

result will contain routines to handle keyboard and disk-related errors. You will be able to use the program (and associated data files) independently of *The Last One*.

Should you ever want to modify the program, you'll probably want to use *The Last One* again, even if you know BASIC. The reason is that the generated program is completely undocumented. Variable names used have no meaning, and no explanatory remarks are embedded in the program. You can have a copy of the flowchart included at the beginning of the program, but that is too general to be really helpful in program modification. It's easy to modify a flowchart, and generating the flowchart isn't difficult in itself. The hard part is modifying the coded program. Rather than changing a few parts and leaving the rest of the coding unchanged, you must painstakingly repeat the entire coding procedure.

Documentation

The instruction manuals are tutorial and quite readable. One describes the package in general; the other describes specifics related to the machine you are using. The general manual takes you step by step through a simple mailing-list application, the best way to get you into the subject. However, the manual is not organized for easy reference. Information is scattered about in different sections, and much information is too abbreviated.

Summary

The Last One does contain a considerable amount of embedded knowledge. It can generate a great deal of BASIC code given a few simple commands. Unlike other program generators, *The Last One* doesn't require you to learn a specification language. It's a shame that the system isn't faster and easier to use.

If you are willing to wade through a tedious maze of menus and specification procedures that may take hours, and if you refuse to learn BASIC or any other programming language, you can probably find a use for *The Last One*, especially if your application is to perform simple data storage and retrieval. . . . G. S.

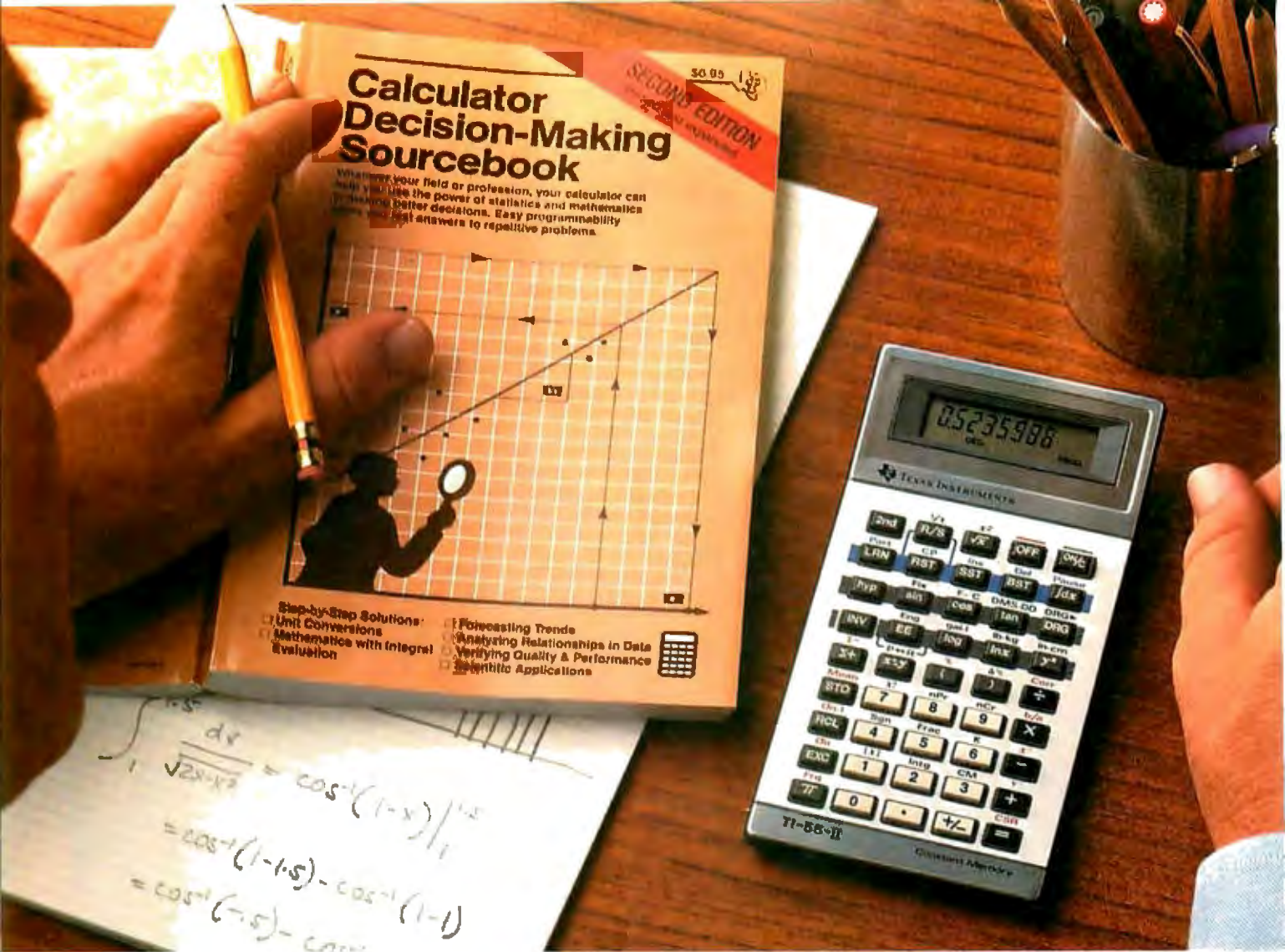

How the TI-55-II makes short work of long problems.

Whenever you can solve complex problems quickly and accurately, you're ahead of the game. And that's exactly what the TI-55-II does for you. By giving you 112 pre-programmed functions (like definite integrals), it allows you to take short cuts without losing accuracy. You'll accomplish a lot more in less time which means increased efficiency.

With our TI-55-II you can tackle problems you thought could only be solved with higher-priced programmables. You're not only getting the standard slide rule functions but also statistical capabilities. This way you can work out linear regressions, permutations and combinations, just to name a few.

The TI-55-II also gives you enough programmability to eliminate a lot of repetitive key punching. Our Constant Memory™ keeps programs and data on tap, even when the calculator is turned off. So once you've entered a formula, you can simply put in the variables to get your solution. The Liquid Crystal Display shows your

answers in standard, scientific or engineering notations – clearly and precisely.

We also help you get the most out of your calculator with the Calculator Decision-Making Sourcebook. It gives you step-by-step examples of the best techniques used for solving mathematical, scientific and statistical problems. And we've included a special section on how to program your TI-55-II.

So next time you're facing another time-consuming problem, cut it down to size with the TI-55-II.



**TEXAS
INSTRUMENTS**

© 1982, Texas Instruments Incorporated.



Quic-N-Easi

The instruction manual describes Quic-N-Easi as "an applications development language that dramatically reduces development time and produces more professional, clearer screen presentations." Compared to *The Last One's* hyperbole, this is a refreshingly modest and accurate description.

To use this product successfully, you will need to learn some programming concepts and the Quic-N-Easi language. That's going to take a while (anywhere from a day to a week or more). But once you've learned it, you have a tool that really can speed up the programming of common business applications. (If you learn the advanced features, you can go far beyond run-of-the-mill data entry and retrieval applications.)

Quic-N-Easi consists of two programs, the "format builder" and the "run-time interpreter." The format builder lets you describe the data, set up screen formats, and specify procedures in the Quic-N-Easi language. The result of this effort is called a format file and is really your application program. The run-time program interprets the format file and, in so doing, performs the application.

The striking features of Quic-N-Easi are ease of editing and logical operation. You work with only three "modes" or activities while creating a format file: building a format background (designing the screen layout), defining the data fields, and specifying program procedures. It's simple to skip from one activity to another without losing work in either area.

Sample Use

To generate the sample mailing-list application (see main article), you start by defining the screen format. Quic-N-Easi has a screen editor that makes this easy: rather than referring to screen locations with row and column numbers, you type the desired information right onto the screen. Next you locate operator-entry fields on the screen and specify what kind of data goes in each. There are nine categories of data, including various combinations of numbers, uppercase letters, and lowercase letters. This generous selection takes much of the burden of data checking from you during the procedure specification stage: the computer will automatically ensure that valid data is entered from the keyboard.

Finally, you specify procedures to be executed immediately after each field is entered or after the entire screen form is filled. Listing 2 shows the procedures used to generate the mailing-list application.

The Quic-N-Easi language is simpler than BASIC; nevertheless, it is a computer language. If it's your first, expect some difficulty. One good thing about this language is that you can always refer to your data in terms of names you choose, like ID, STREET, etc. This is true even when you're specifying calculations to be performed on these fields. Only for internal calculations do you have to resort to names like #S0, #N0, and #B0.

Disk input/output is another strong point of this product. In addition to se-

quential and random-access files, Quic-N-Easi offers indexed sequential files, which enable your file update programs to operate with exceptional speed. (See section entitled "File Storage" page 42.) The mailing-list application was programmed using indexed sequential files.

Documentation

The instruction manual for Quic-N-Easi contains a self-teaching guide and a programmer's reference section. The self-teaching guide uses prepared format files supplied with the software distribution disk and makes an effective introduction to the system. Mastering the system is going to take quite a while, and the programmer's reference section will become useful as you begin to grasp the principles of operation. A handy reference card is also provided.

Summary

Quic-N-Easi will not free you from the task of programming. To make full use of it, you will need to understand fundamental principles of programming—as well as learn the Quic-N-Easi language. However, once you've passed these hurdles, Quic-N-Easi should help you to generate common business-application programs much faster than could be done using BASIC or other programming languages. And the level of expertise required to create a given application with Quic-N-Easi is lower than that required to create the same application in an ordinary language. . . . G. S.

programming concepts and techniques.

One final point seems obvious but is often missed: to use a program generator effectively, you must fully understand the desired application. It's no use, for example, trying to make a program generator produce a double-entry ledger system if you

know nothing about accounting. Even the mailing-list application requires that you have a good understanding of the best way to store data. (How many characters should be allowed for the name field, address field, etc?) Manual systems are much more flexible than computer systems in these areas; you'll probably have

to do more specific planning than you're used to.

One thing's for sure. Using an application generator will give you more appreciation for the work programmers do. If using a program generator takes so much effort, think about what programmers have to go through. ■

High-Resolution Sprite-Oriented Color Graphics

*You don't need Logo to use sprites
for animation with the illusion of depth.*

Steve Ciarcia
POB 582
Glastonbury, CT 06033

A funny thing happened on my way to writing this article. Very rarely do I ever know what BYTE's monthly theme is when I am planning a project. The editors tell me, but I am always working on so many hardware projects simultaneously that I can't keep track. And I sometimes juggle my project schedule at the last minute.

This time, three weeks before my deadline, I told Senior Editor Gregg Williams that I was designing a sprite-graphics interface for August. He reminded me that the theme of the issue was Logo and that my project was a perfect enhancement to a Logo package produced by Terrapin Inc. of Cambridge, Massachusetts.

"What's Logo?" I thought to myself, but not wishing to appear completely ignorant, I took his word for it and sent my wire-wrapped prototype board to Leigh Klotz Jr. and Patrick Sobalvarro at Terrapin. It took them less than a week to devise ways to

control my sprite-graphics interface using the Logo language.

Their help came just at the right time. Since I was struggling with using assembly language to draw the pictures necessary for this article, I gratefully accepted a copy of the Terrapin MIT Logo language from them, along with the Logo routines they wrote to manipulate sprites. Using Terrapin's software, I quickly came to understand why Logo and a sprite-graphics interface are a natural combination.

The key component is the TMS9918A Video Display Processor.

But you don't have to have Logo to use the sprite-graphics board. You can approach this project either as a versatile color graphics interface that you can mold to fit your requirements or as a sprite-graphics system for use with Terrapin MIT Logo. In either case, you will not be disappointed.

The TMS9918A VDP

The key component in this month's project is an integrated circuit from Texas Instruments, the TMS9918A

Video Display Processor (VDP). This chip offers features that are not, to my knowledge, found in any other graphics system. A summary of its capabilities is shown in table 1.

The TMS9918A VDP is intended to be interfaced to a host microprocessor through an 8-bit bidirectional data bus and three control lines. The VDP's output is a composite color video signal, which can be fed directly into a video monitor or, with the addition of an RF (radio-frequency) modulator, to the antenna terminals of a television set.

Up to 16K bytes of dynamic RAM (random-access read/write memory) can be attached directly to the VDP. This VRAM (video RAM), which contains the data that defines the graphics image to be displayed, is automatically refreshed by the VDP. The VRAM needs no direct connection to the host computer.

The host processor interacts with the 9918A by reading from or writing to its registers or the VRAM. The interpretation of the data flow is controlled by the states of the three control lines. The timing of register and VRAM updates is asynchronous with the video output; thus the host processor can communicate with the VDP at any time.

Copyright © 1982 by Steven A. Ciarcia.
All rights reserved.

*Certain figures and diagrams pertaining to the
TMS9918A are reprinted courtesy of Texas In-
struments Inc.*

1. display resolution of 256 by 192 pixels
2. 16 colors, including black and transparent
3. supports 16K bytes of separate video memory
4. real-time interrupt capability
5. 32 sprites for simulation of three-dimensional effects
6. composite video output
7. four display modes:
 - a. graphics I (256 by 192 dots—limited color)
 - b. graphics II (256 by 192 dots—extended color)
 - c. text mode (24 lines of 40 user-defined characters)
 - d. multicolor mode (64 by 48 low-resolution positions)
8. external video and sync inputs
9. automatic, transparent dynamic RAM refresh

Table 1: Characteristics of the Texas Instruments TMS9918A Video Display Processor integrated circuit.

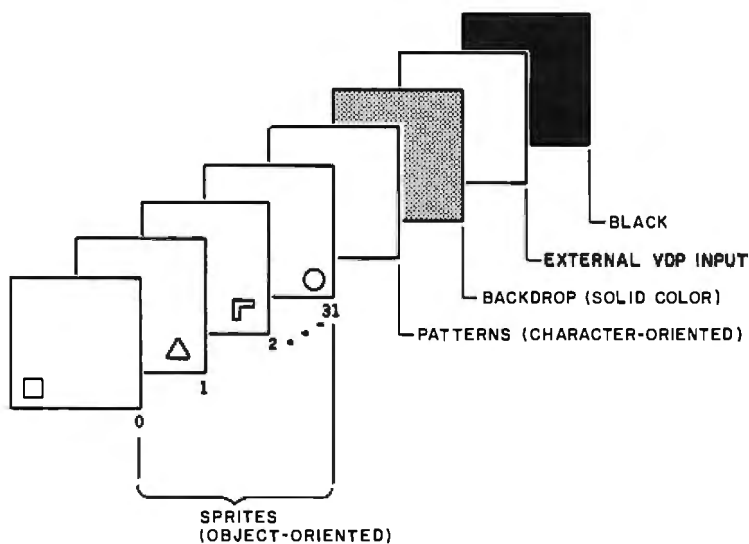

Figure 1: The TMS9918A's screen image can be envisioned as a set of overlapping display planes sandwiched together. Image objects in planes figuratively closer to the viewer (the top layers of the sandwich) seem to be in front of objects on planes further away (the bottom layers of the sandwich). The top 32 sprite planes are in front of the pattern plane, the backdrop plane, and the external VDP (video) plane, which can contain a video image from almost any compatible external source. The 9918A combines the multiple image sources to form a single composite image.

Distinctive Architecture

The TMS9918A VDP displays an image on the screen that can be best envisioned as a set of overlapping display planes sandwiched together, as shown in figure 1. This distinctive graphics architecture makes possible

the simulation of depth relationships between animated objects in the display without the use of complex hidden-line algorithms.

Image objects in planes figuratively closer to the viewer (the top layers of the sandwich) have higher priorities

of visibility than the planes further away (the bottom layers of the sandwich). When the objects on two different planes attempt to occupy the same spot on the screen, the object on the higher-priority plane will be seen by the viewer. For an object on one of the lower-priority planes to be visible, all planes in front of the object's plane (the higher-priority planes) must be transparent at that point.

The top 32 planes are designated for the display of special graphics objects called sprites, which I'll explain shortly. Behind the sprite planes is the pattern plane. The pattern plane is used for text and graphics generated in one of four color-display modes. This pattern plane works like a conventional single-plane, spriteless graphics system. The resolution varies depending on the display mode selected.

Behind the pattern plane is the backdrop plane. Its area is larger than the other planes so that it can form a border around them. The backdrop is always either 1 of 15 solid colors or transparent.

The last, rearmost plane is called the external VDP plane, which can allow one 9918A chip to overlay its display over the output of a second 9918A. But the external VDP plane could contain a video image from almost any compatible external source such as a TV camera, a videotape recorder, or another computer display, as long as the external source is synchronized to the 9918A's Clock and $\overline{\text{Reset}}$ /Sync inputs. It might also be necessary to adjust the signal voltage levels.

The four image sources (sprites, pattern plane, backdrop, and external input) can be combined to create a single composite image in the 9918A. In most applications, however, the 9918A's external VDP input is not used, and the image is formed from the pattern, backdrop, and sprite planes.

What Are Sprites?

A sprite is a graphics object of a specified pattern appearing on its plane in a position determined by a single coordinate pair specifying the

(2a)

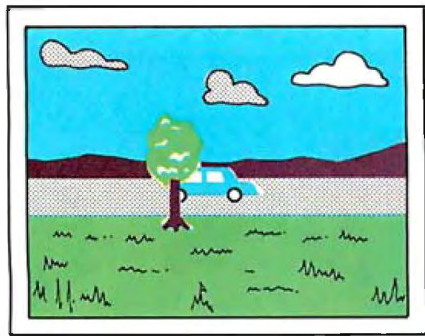

(2b)

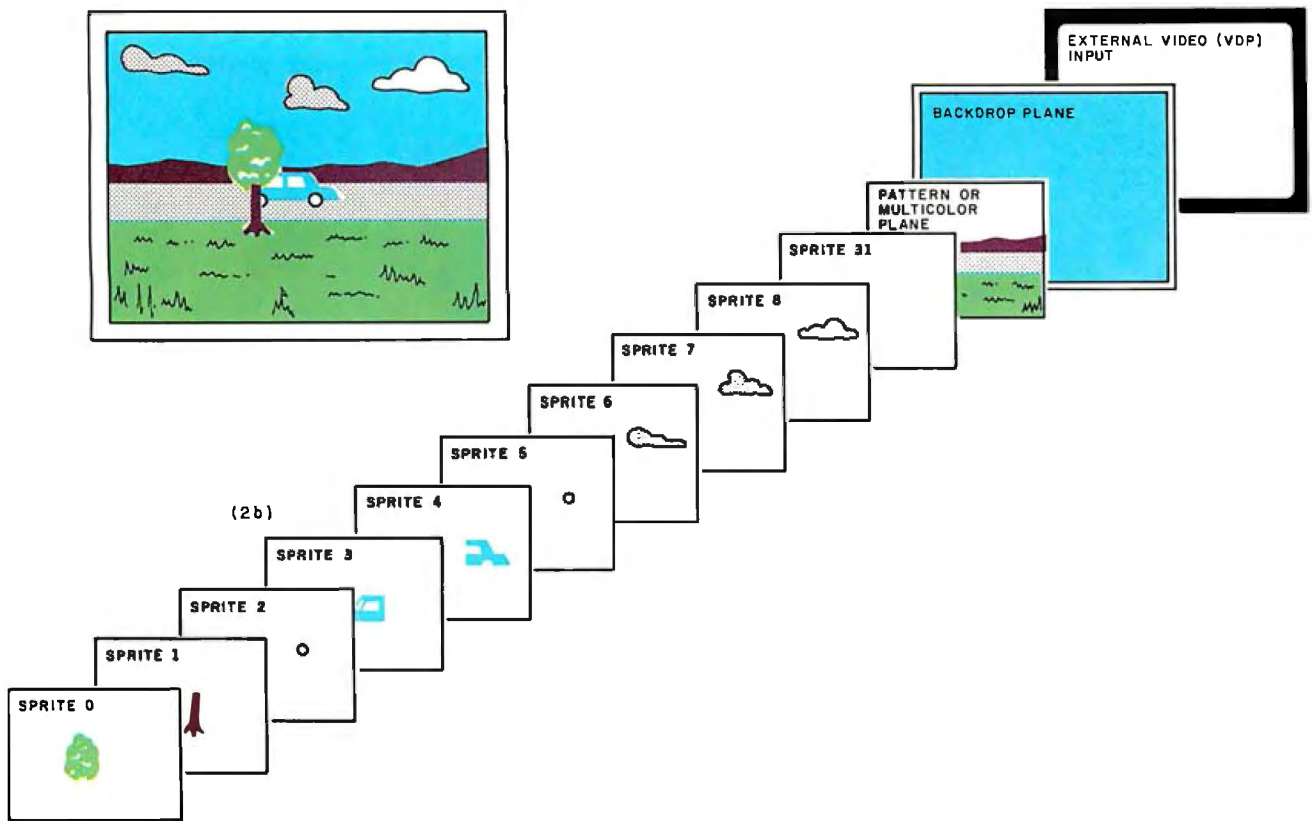

Figure 2: A possible application for sprites: displaying a graphics image of an automobile driving along a road through hilly country, past a field containing grass and a single tree, under a sky populated by clouds.

The background, comprising the hills, grass, road, and sky, is "painted" on the pattern plane. Sprites 0 and 1 are set up with patterns representing the tree's foliage and trunk. The sections of the car are drawn using sprites 2 through 5. Finally, three clouds are drawn using sprites 6 through 8. Each of the sprites can be made to move smoothly across the screen by continuously changing a 2-byte address pointer in the sprite-attribute table.

As sprites 2 through 5 (the car sprites) are moved past the position occupied by sprites 0 and 1 (the two tree sprites), the VDP selects the displayed pixel values at each point from the highest-priority plane that is not transparent at that point; therefore our view of the car is automatically blocked out as it passes behind the tree.

sprite's location on the screen in the horizontal and vertical axes. By changing this one set of coordinates, the sprite can be moved easily and quickly across the screen.

Sprites come in two sizes: 8 by 8 pixels (picture elements) and 16 by 16 pixels; they can be expanded to 32 by 32 pixels by using the magnification feature. Their resolution of movement is one pixel on the 192- by 256-pixel viewing area. Each sprite plane contains exactly one sprite; all the plane's area outside the sprite pattern is transparent. The sprite plane with the highest priority is identified as sprite 0, and the one with the lowest priority is sprite 31.

The ease of programming complex graphic displays through the use of sprites is the most significant feature of the TMS9918A.

Example of Sprite Use

Let's consider a possible application: displaying a graphics image of an automobile driving along a road through hilly country, past a field containing grass and a single tree, under a sky populated by clouds (see figure 2). Starting from the foreground, we see that there is a tree between our point of view and the roadway. Naturally we expect the car to be obscured by the tree when passing behind it. And the car should obscure the background hills wherever it goes.

This scene is set up on the 9918A as follows. The background, comprising the hills, grass, road, and sky, is "painted" on the pattern plane in a way similar to the use of any conventional display.

Since the size of the sprites is

limited and each sprite can be only one color, it sometimes becomes necessary to use multiple sprites to define a single entity in the picture. (When the entity is to be moved across the screen, all the sprites that form it must be moved at the same time.) So, following this plan, sprites 0 and 1 are set up with patterns representing the tree's foliage and trunk. The sections of the car (front and rear of the body plus the two visible tires) are drawn using sprites 2 through 5. Finally, three clouds (of slightly different colors) are drawn using sprites 6 through 8. Sprite planes 9 through 31 are left transparent.

Animation Comes Easy

Once the static display has been established, we can see why sprites are so useful in animating the display,

(1a)

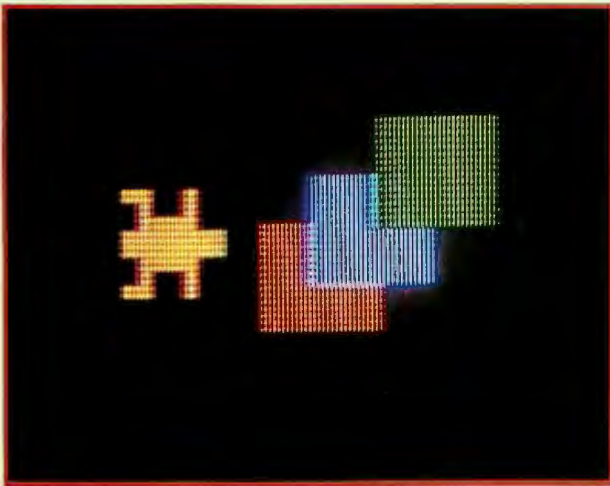

(1b)



Photo 1: A step-by-step illustration of the use of sprites and the concept of plane priority. The yellow turtle (sprite 3) is programmed to pass from left to right past the green box (sprite 0), the blue box (sprite 1), and the red box (sprite 2). The transparent pattern plane and backdrop cause the background to be black.

that is, causing parts of it to move. What would ordinarily be an extensive programming task is handled almost entirely in hardware by the 9918A.

Unlike spriteless systems, moving the car does not require that the software repaint the entire display pattern. Simply by continuously changing a 2-byte address pointer in the sprite-attribute table in VRAM, each of the sprites can be made to move

smoothly across the screen.

In addition, as sprites 2 through 5 (the car sprites) are moved past the position occupied by sprites 0 and 1 (the two tree sprites), the VDP selects the displayed pixel values at each point from the highest-priority plane that is not transparent at that point; therefore our view of the car is automatically blocked out as it passes behind the tree. Similarly, if the clouds are different colors (perhaps

white and gray) and made to pass each other, they will also appear to pass in front or behind in a pseudo-three-dimensional view. This hidden-view capability is provided in hardware and requires no special software, unlike conventional graphics systems.

Additional Examples

Photo sequences 1 and 2 are step-by-step illustrations of the use of

(2a)

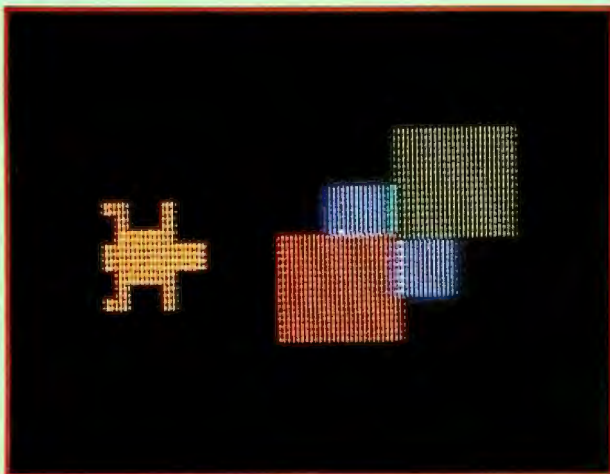

(2b)

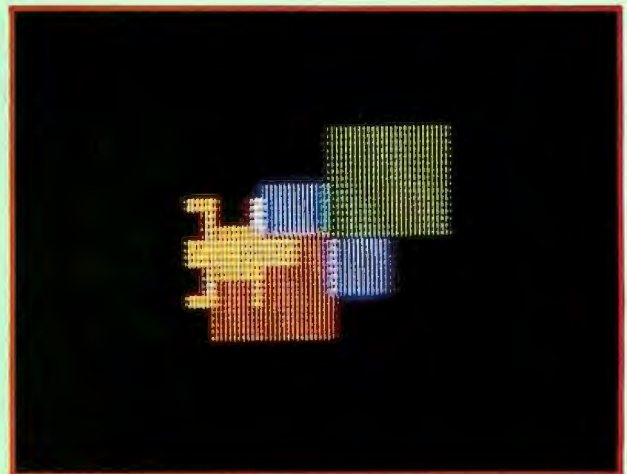
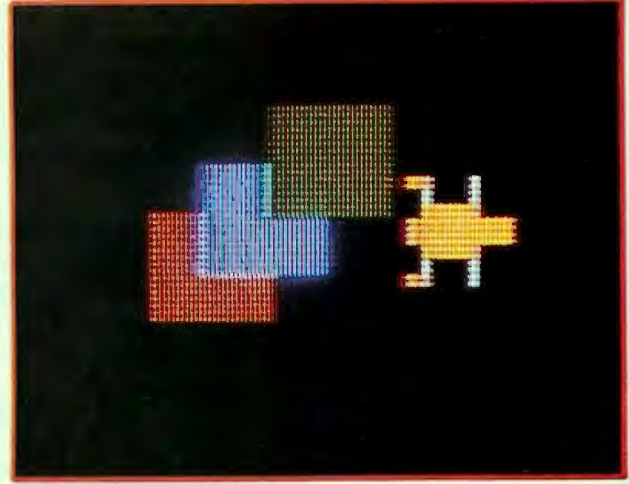

Photo 2: Some priorities have been exchanged from photo 1: the shapes have been set up on a new permutation of planes. The green and red boxes remain sprites 0 and 2, respectively, but the turtle is now sprite 1 and the blue box is sprite 3. The boxes now overlap in a different order; instead of the sequence green, blue, red, we now have green, red, blue.

(1c)



(1d)



The turtle is obscured from view as it passes from left to right past the three boxes, beginning in photo 1b. It is not fully visible until it emerges again on the right in photo 1d. Since the three boxes reside on sprite planes of higher priority than the turtle's plane, the pixel values of the boxes take precedence in being displayed wherever the sprite shapes intersect. Also, the three boxes overlap according to their planes' priorities.

sprites and the concept of plane priority. Both examples use four sprites, but the priorities of the planes used for each sprite shape are changed to demonstrate different effects. Three of the sprites are solid-color boxes, and one is a shape described as a turtle. The turtle is programmed to pass from left to right past the boxes.

In photos 1a through 1d, the green box is sprite 0, the blue box is sprite 1, and the red box is sprite 2. The yellow

turtle is sprite 3. No other sprites are involved, and the pattern plane and backdrop are transparent, resulting in a black background.

You'll notice that the turtle is obscured from view as it passes from left to right past the three boxes, beginning in photo 1b. Since the three boxes reside on sprite planes of higher priority than the turtle's plane, the pixel values of the boxes take precedence in being displayed wherever the

sprite shapes intersect. Observe also that the three boxes overlap according to their planes' priorities. The green covers the blue, and the blue covers the red. As for the turtle, it has the lowest priority and is not fully visible until it emerges again on the right in photo 1d.

In photos 2a through 2d, some priorities are exchanged: the shapes have been set up on a new permutation of planes. The green and red boxes re-

(2c)



(2d)

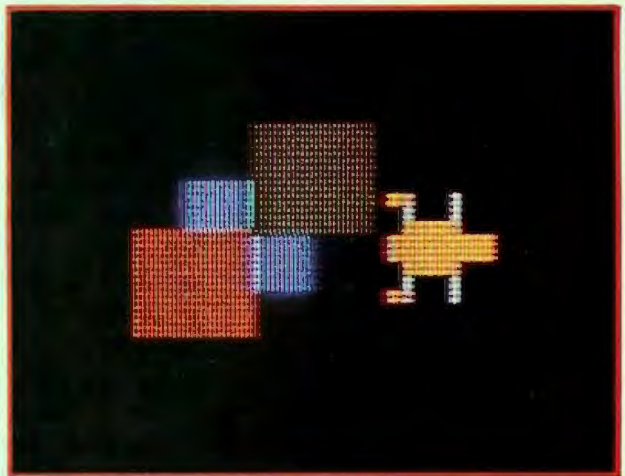

As the turtle (now sprite 1) passes from left to right, it passes in front of the red box (sprite 2) and the blue box (sprite 3), as shown in photo 2b, but it goes behind the green box (sprite 0), in photo 2c.

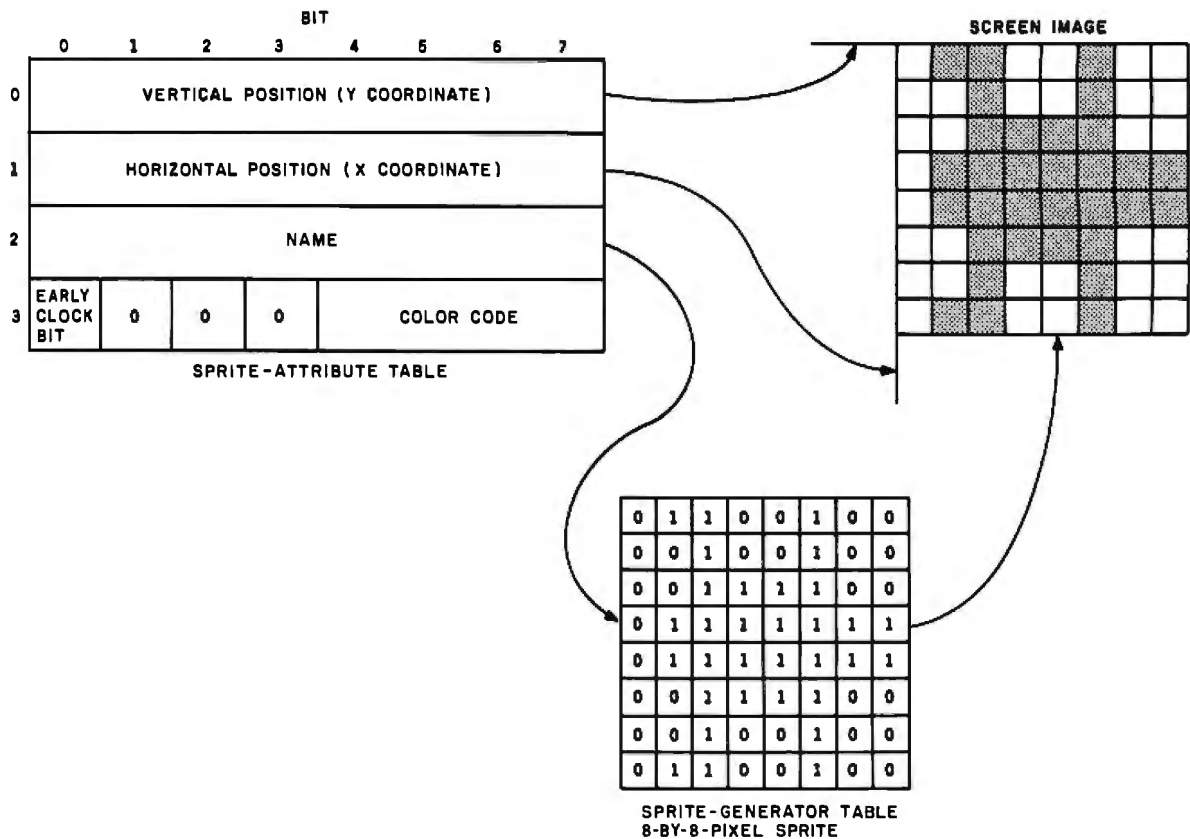

Figure 3: The binary coding for an 8-by-8-pixel sprite pattern is stored in VRAM in the sprite-generator table in 8 bytes. Each bit in the pattern coding corresponds to one pixel in the displayed pattern. Wherever a 1 is stored in a pixel's pattern bit, the sprite will be colored; where the bit is a 0, the sprite will be transparent. Each sprite can be only a single color.

Each sprite's attributes are stored in the 128-byte sprite-attribute table. Each set of attributes takes up 4 bytes. In each set of attributes, the first two bytes set the x,y coordinates of the sprite on the screen, referenced from the screen's upper left corner. The third attribute byte contains the sprite's "name" (actually the low-order bits of the address of its segment of the sprite-generator table), and the fourth byte defines the sprite's color, according to the 4-bit color values given in table 2.

Hexadecimal Value	Color
0	transparent
1	black
2	medium green
3	light green
4	dark blue
5	light blue
6	dark red
7	cyan
8	medium red
9	light red
A	dark yellow
B	light yellow
C	dark green
D	magenta
E	gray
F	white

Table 2: Four-bit binary codes used by the 9918A to specify the color of a picture element or color pattern.

main sprites 0 and 2, respectively, but the turtle is now sprite 1 and the blue box is sprite 3. The first feature of note is the reordering of the overlapping boxes. Instead of the sequence green, blue, red, we now have green, red, blue.

As the turtle (now sprite 1) passes from left to right, it passes in front of the red box (sprite 2) and the blue box (sprite 3), as shown in photo 2b, but it goes behind the green box (sprite 0), as we see in photo 2c. The appearance is that it is passing among rather than behind the boxes.

Boxes and turtles may not impress you very much in themselves, but remember that no complicated hidden-line algorithms are needed to determine pixel precedence. Everything I've demonstrated is done completely in hardware on the 9918A. The only

software computation (other than initially generating the sprites) is to change a 2-byte x,y coordinate pair to move the turtle.

There is a restriction, however, on the number of sprites that may occupy a single horizontal scan line in the video display raster: only four may do so simultaneously. If a fifth sprite is moved into a position such that part of its pattern is on the same line with parts of four other sprites, the conflicting parts of the *lowest priority* sprite of the five will be made transparent on the display. Also, the number of the fifth sprite will appear in the 9918A's status register.

Structure of Sprites

There are two basic sizes of sprites: 8 by 8 pixels and 16 by 16 pixels. The 8-by-8-pixel sprite is more often used;

the binary coding for its pattern is stored in VRAM in the *sprite-generator table* (SGT) in 8 bytes, as shown in figure 3. The larger 16- by 16-pixel sprite requires 32 bytes for storage of its pattern coding.

Each bit in the SGT pattern coding corresponds to one pixel in the displayed pattern. Wherever a 1 is stored in a pixel's pattern bit, the sprite will be colored; where the bit is a 0, the sprite will be transparent. Each sprite can be only a single color.

Either size sprite may be enlarged (magnified) by a factor of 2 under software control; the magnification factor (1 or 2) is global, affecting all sprites. The display produced for the priority demonstration of photo sequences 1 and 2 consisted of 16- by 16-pixel sprite shapes made from 8- by 8-pixel sprites magnified to be twice as big as normal.

Each sprite's attributes (values that determine the characteristics of color, coordinate position, and SGT pattern location) are stored in the *sprite-attribute table*, or SAT, in VRAM. Each set of attributes takes up 4 bytes; to support 32 sprites, the table must be 128 bytes long. To find the storage location of a particular sprite's attributes, we merely take the sprite's number, multiply it by 4, and add the result to the base address of the sprite-attribute table, which is stored in the 9918A's register 5.

In each set of attributes, the first two bytes set the *x,y* coordinates of the sprite on the screen, referenced from the screen's upper left corner. The third attribute byte contains the sprite's "name" (actually the low-order bits of the address of the sprite's SGT segment), and the fourth byte defines the sprite's color, according to the 4-bit color values given in table 2.

Not Only Sprites

In addition to sprites, the TMS9918A VDP is capable of considerable graphic feats using only the pattern plane, which operates in any of four display modes. Not all modes use the full 16K-byte memory capacity that the 9918A is capable of supporting. The display mode and memory allocation are selected by setting

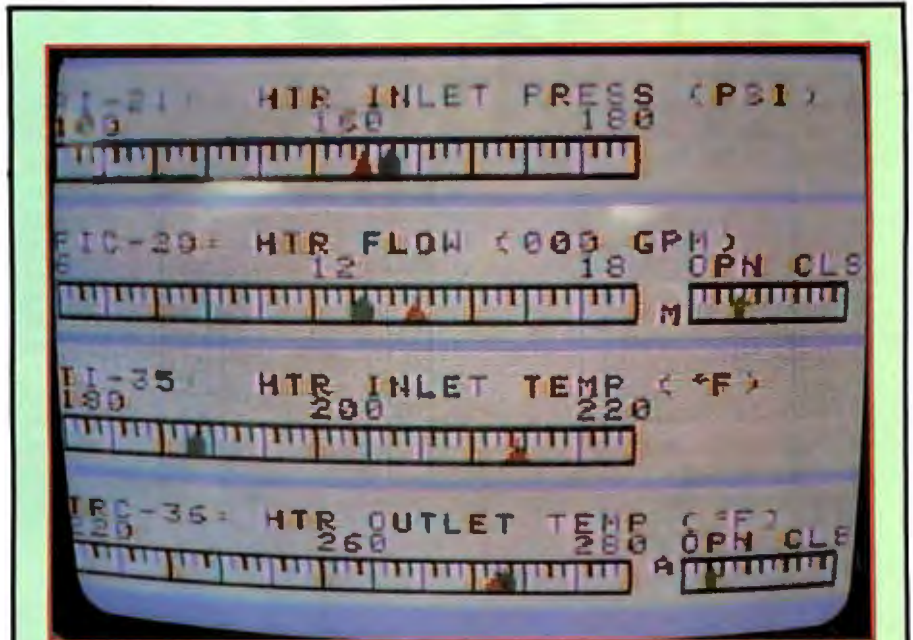

Photo 3: A Graphics-II-mode display combined with sprites, showing a simulation of some analog sensor meters. The pattern plane contains the meter scales and alphanumeric labeling, while the pointers within the meter scales are sprites, which are easily moved to represent changes in the measured quantities.

bits in the VDP's registers. Let's look at some of these other methods of display.

Graphics I Mode

In the Graphics I mode, the screen is divided up into a grid of pattern positions arranged in 24 rows of 32 columns: a total of 768 positions. Each pattern position contains 64 pix-

The ease of programming complex graphic displays through use of the sprites is the most significant feature of the TMS9918A.

els arranged in 8 rows of 8 columns. The contents of the pattern-generator table (PGT) in VRAM determine what is displayed in these pattern positions, and the pattern-color table (PCT) defines the colors associated with them.

In Graphics I mode, up to 256 different patterns can be stored; any one of these can be used in any of the 768 pattern positions, and each pattern

can contain two of fifteen possible colors. The patterns can be alphanumeric characters or small sections of a large display picture, disassembled as if it were a jigsaw puzzle.

The pattern definition in the pattern-generator table consists of an 8-byte segment of memory; each bit in the segment corresponds to one pixel in the 8 by 8 matrix; the first byte is the top row of the matrix, and the second byte is the second row, etc. The colors to be used in a given pattern are determined by the two 4-bit values stored in the pattern's color byte in the pattern-color table; binary 1s and 0s are set in the pattern-generator table to turn on one color or the other for each pixel in the pattern.

Graphics II Mode

The Graphics II mode is similar to the Graphics I mode except that it allows 768 separate pattern definitions instead of only 256. In addition, instead of only two colors within each 8- by 8-pixel pattern block, Graphics II mode allows two colors to be defined separately for each byte in the pattern block, so potentially sixteen colors could appear in a single

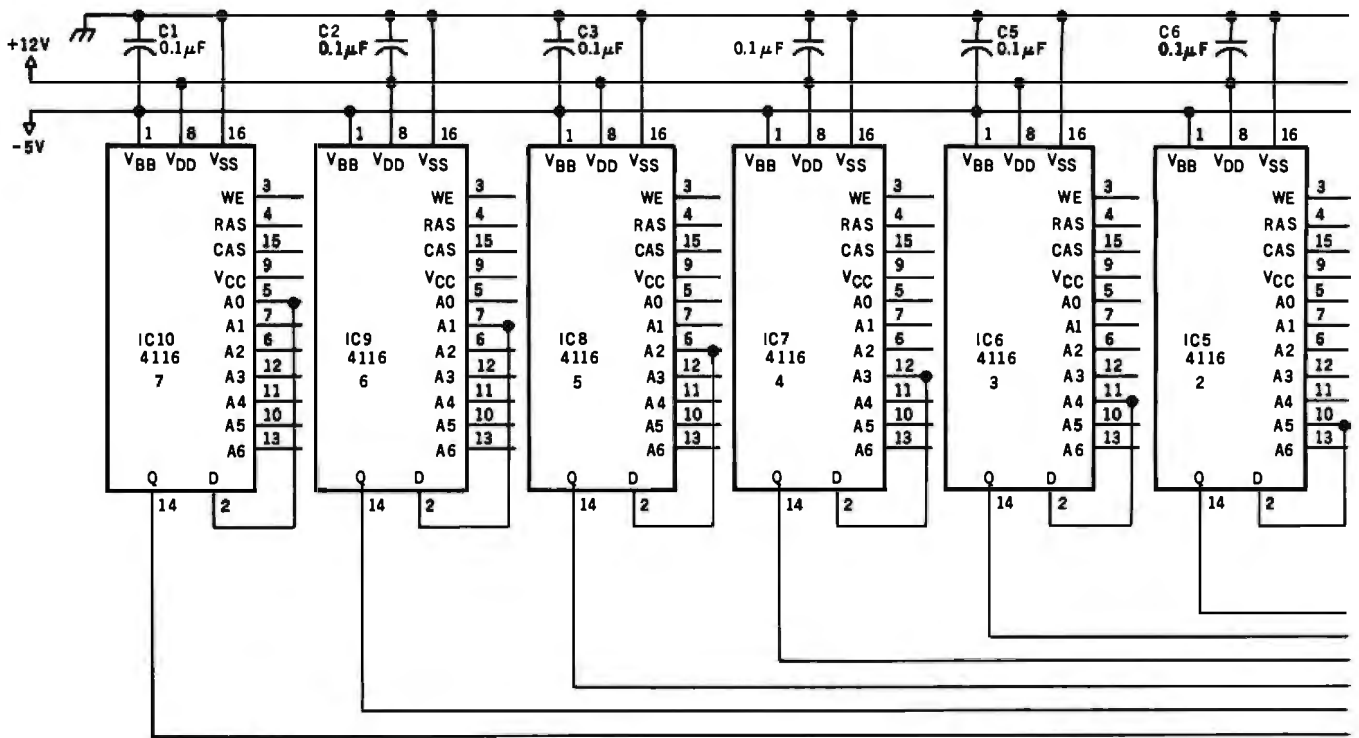

Number	Type	+5V	GND	-5V	+12V
IC1	TMS9918A	33	12		
IC2	74LS00	14	7		
IC3	4116	9	16	1	8
IC4	4116	9	16	1	8
IC5	4116	9	16	1	8
IC6	4116	9	16	1	8
IC7	4116	9	16	1	8
IC8	4116	9	16	1	8
IC9	4116	9	16	1	8
IC10	4116	9	16	1	8

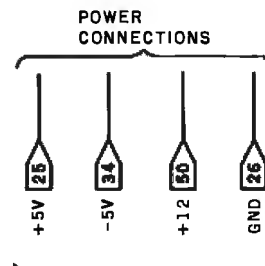

Figure 4: A schematic diagram of the E-Z Color Graphics Interface. Very few components are needed to connect the TMS9918A to the computer's electrical bus; most of the integrated circuits are simply memory components used as the 9918A's VRAM.

block. As you might expect, this mode uses more memory, potentially as much as 12K bytes of VRAM.

By allowing 768 distinct patterns for the 768 available pattern locations, the Graphics II mode equals the image capacity of the widely used conventional 256- by 192-pixel displays. Virtually any scene pictured in the Apple II high-resolution graphics mode, for example, can be recreated on the pattern plane of the 9918A. With a little additional application programming to set register pointers and load the pattern and color tables, the Graphics II mode can exactly syn-

thesize the point- and line-plotting functions of conventional graphics interfaces. And you still can use the sprites.

Photo 3 is an example of a Graphics-II-mode display combined with sprites, showing a simulation of some analog sensor meters. The pattern plane contains the meter scales and alphanumeric labeling, while the pointers within the meter scales are sprites, which are easily moved to represent changes in the measured quantities. Since there is no screen re-writing required to move the dial pointers, there is absolutely no

flicker, and the pointer placement is an easily calculated x displacement.

Multicolor Mode

The Multicolor mode is essentially a low-resolution graphics mode. In it, the screen is divided into 3072 blocks, each measuring 4 by 4 pixels, in a 48-line by 64-column format. The color of each block can be any of the fifteen colors or transparent.

Text Mode

In the Text mode, the screen is divided into a grid measuring 24 lines by 40 columns of pattern positions,

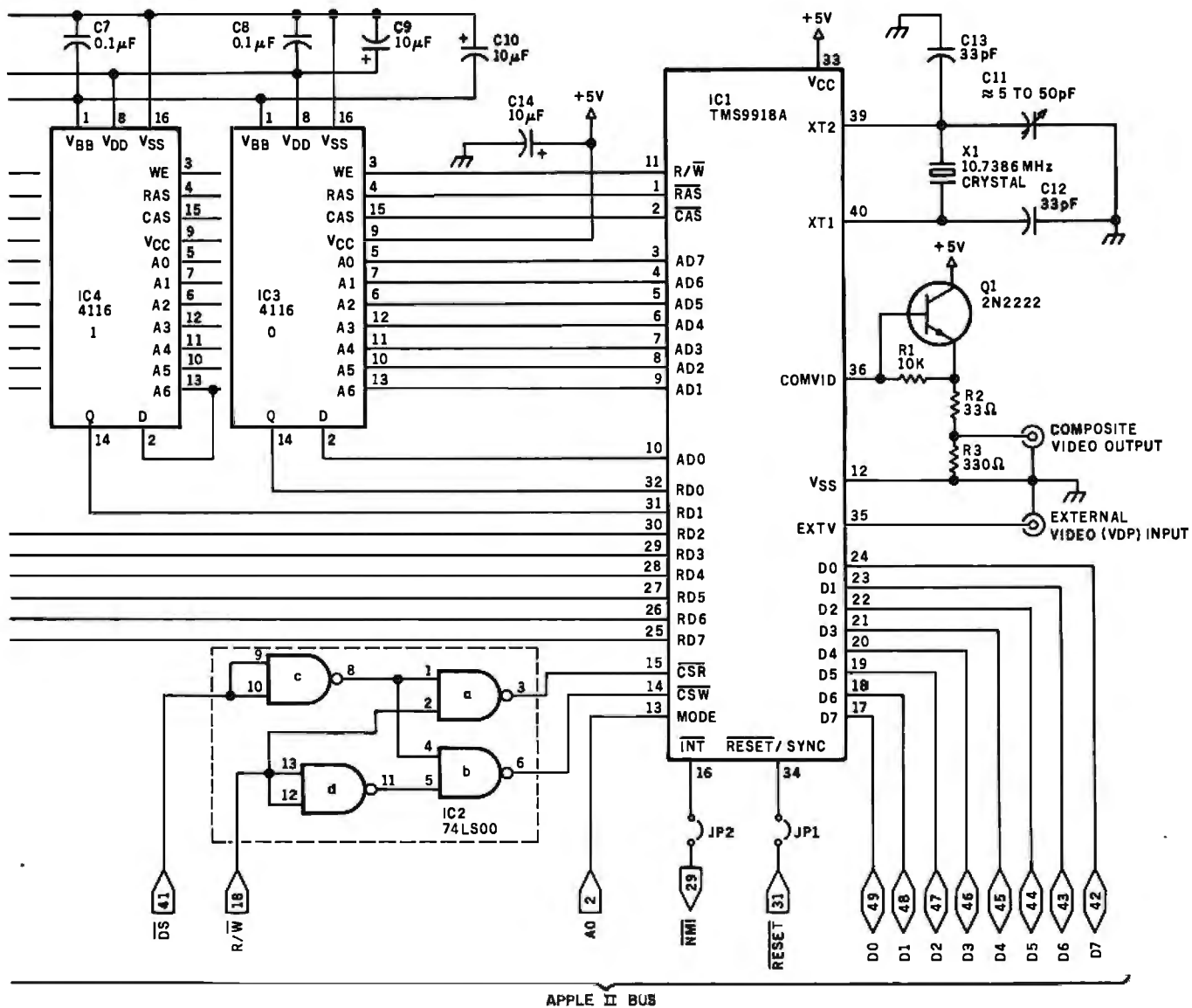

APPLE II BUS

The circuit shown is intended for use with an Apple II computer, with the circuit board plugged into a slot on the motherboard (usually slot 4), but other versions of the circuit for S-100-bus computers and the IBM Personal Computer are under development. The E-Z Color Graphics Interface may also be adapted for use with other computers.

each of which measures 6 by 8 pixels. The Text mode is intended for display of alphanumeric characters rather than graphics patterns. There can be up to 256 unique character patterns defined at a single time to fill the 960 pattern positions. The sprite planes are not available in Text mode. (If you need both sprites and text simultaneously, you can generate character patterns in the Graphics I mode if you don't mind a slightly shorter line length than in the Text mode.)

The character set is stored in the pattern table in VRAM. Since the cells measure 6 by 8 pixels, the char-

acters should occupy a 5- by 7-pixel format to allow some space between characters. By properly setting the register pointers, it is possible to have the table addresses for the character patterns equal the characters' ASCII (American Standard Code for Information Interchange) values, which makes character generation easy.

Use of Memory

While the 9918A project I built has 16K bytes of VRAM, not all modes use that much. A typical application that uses only two colors with 256 unique 8- by 8-pixel patterns and 32

sprites would take less than 4K bytes of VRAM. By providing 16K bytes of VRAM with the 9918A, I found that I often had room to store four complete displays; the VDP can switch between them by simply changing pointers in the registers.

E-Z Color Graphics Interface

Figure 4 is the schematic diagram of my project for this month, which I call the Circuit Cellar E-Z Color Graphics Interface. The design is a typical 9918A color graphics interface in that it is interfaced to a microcomputer bus with a minimum of compo-

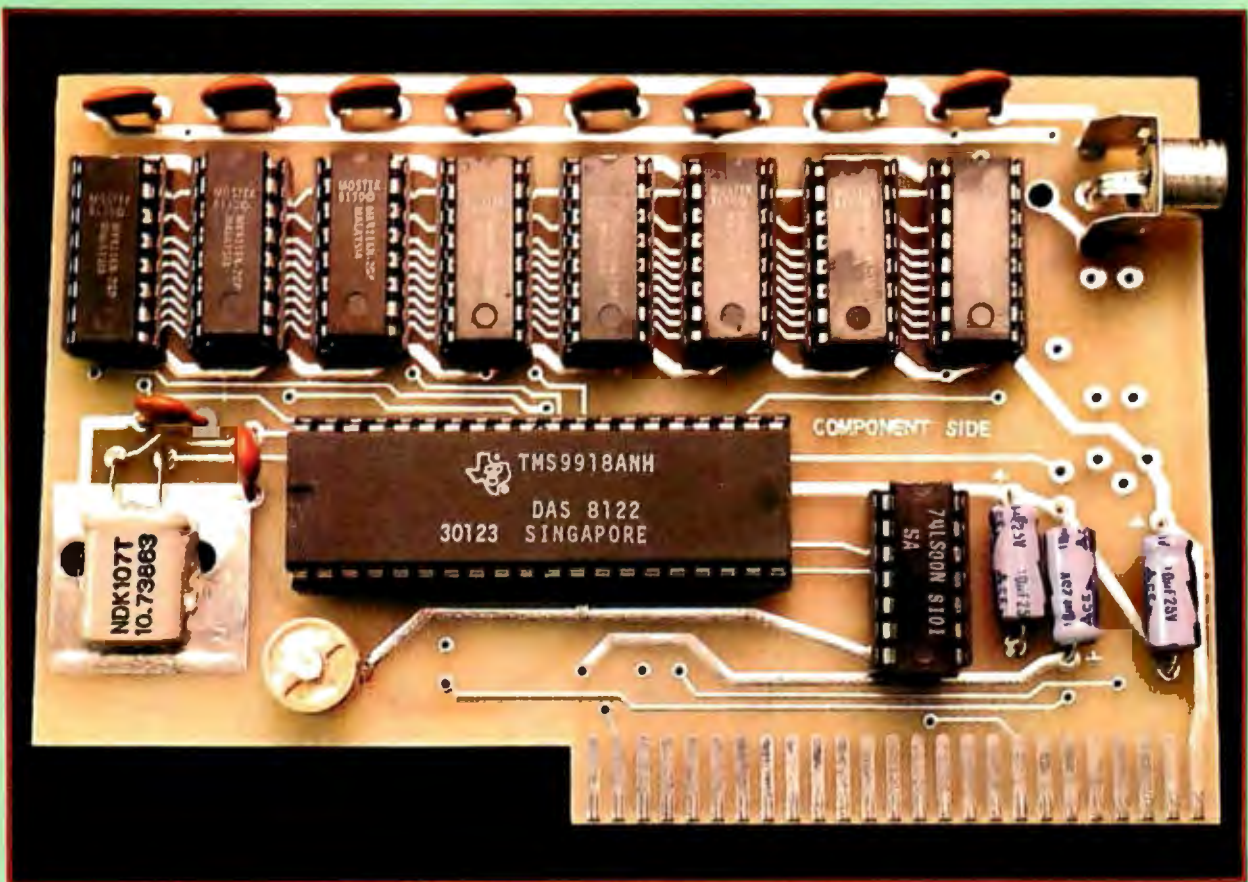

Photo 4: The Circuit Cellar E-Z Color Graphics Interface; a prototype printed-circuit board is shown. This typical TMS9918A color graphics interface is interfaced to the Apple II microcomputer bus with a minimum of components.

nents. A prototype printed-circuit board is shown in photo 4.

This particular design has been configured for use with an Apple II, yet its signals are compatible with those used in many other computer systems. If you are willing to add a 40-pin connector and do some hand-wiring, you can use this board with some other kind of microcomputer.

The circuit requires an 8-bit bi-directional data bus, one address line (typically A0), and the two control signals Read Enable (\overline{CSR}) and Write Enable (\overline{CSW}). For operation with the Apple II, these signals are formed by logically combining the Apple's \overline{DS} (Device Select) and R/W (Read/Write) lines. The two control signals are known by different names in other computer systems, but their functions are generally compatible. Two additional lines, INT (Interrupt

and $\overline{Reset/Sync}$, are shown as jumper connections. They are available for various optional enhancements, such as interrupt-driven animation or synchronization with external video sources.

By the time you read this article, I shall have completed the designs for S-100-bus and IBM Personal Computer versions of the E-Z Color interface. Check with the parts source given at the end of the article for availability.

Assembly-Language Sprite Use

As I alluded before, the 9918A is initialized by loading values into control bits and address pointers in eight write-only registers. Drawing and moving sprites across the screen is simply a matter of choosing the proper register parameters and changing the pointers.

Listing 1 on page 68 is a program that demonstrates the routines needed to display and move sprites. The program is written in 6502 assembly language to run on an Apple II computer equipped with the E-Z Color Graphics Interface, installed in motherboard slot 4 at hexadecimal address C0C0.

The first requirement is to initialize the eight registers and clear the VRAM. In this example the 9918A is set to the following operating specifications: Graphics II mode, external video input disabled, and 16- by 16-pixel sprites, with selectable magnification to twice the normal size (32 by 32 pixels) under keyboard control.

When the program starts, four different sprites are displayed, as shown in photo 5. You can change the display as follows. When you press the M key, the sprites' position coor-

dinates are incremented and the sprites move. Pressing the O key and then a hexadecimal digit 1 through F will set one of the fifteen background colors or transparency (shown). Pressing the left- or right-arrow keys will vary the sprites' size between 16 by 16 and 32 by 32 pixels.

If you are ambitious, one possible exercise is to add more sprites to this program. Photo 6 shows how complicated things get when we have 24 sprites.

Logo Sprite Use

If you don't care to concern yourself with the intricacies of assembly language, you may choose to use routines written in Terrapin's version of MIT Logo to control the E-Z Color graphics.

Terrapin Logo normally uses a single video monitor for all its display functions: text listings and line drawing. The colors available are limited to the six supported by the Apple's high-resolution graphics mode. When the E-Z Color Graphics Interface is installed, the regular display screen is still used for text display and the regular turtle graphics; the E-Z Color board must be connected to a second color video monitor for its display to be simultaneously visible. Photo 7 on page 68 shows the two-monitor set-up. (If you don't need to see both displays at once, you could set up a switch to select the video output of one source or the other for display on a single monitor.)

The Logo procedures developed by Leigh and Pat implement user commands to specify the characteristics of each sprite; these commands include SETSHAPE, SETCOLOR, and SXY (for "set x,y position"). If you like, you can map out your own sprite shapes and incorporate them into the routines, but some predefined patterns, shown in photo 8, are provided. (People from Terrapin seem to like turtle shapes.)

The photo sequences 1 and 2 used earlier to demonstrate sprite planes were done using a Logo program. For example, the three boxes (shown in photo 9) are drawn in Logo using the following groups of simple statements:

Text continued on page 80

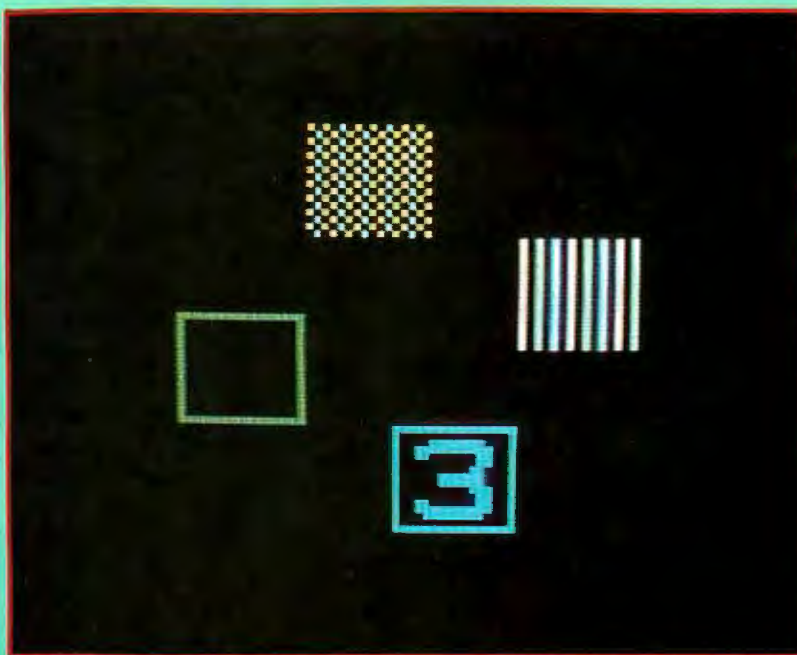

Photo 5: Display of four sprites produced by the 6502 assembly-language program of listing 1. The user can change the display in the following ways. Pressing the M key causes the sprites to move. Pressing the O key and then a hexadecimal digit 1 through F sets one of the fifteen background colors or transparency (shown). Pressing the left- or right-arrow keys varies the sprites' size between 16 by 16 and 32 by 32 pixels.



Photo 6: The display can get complicated when 24 sprites are visible.

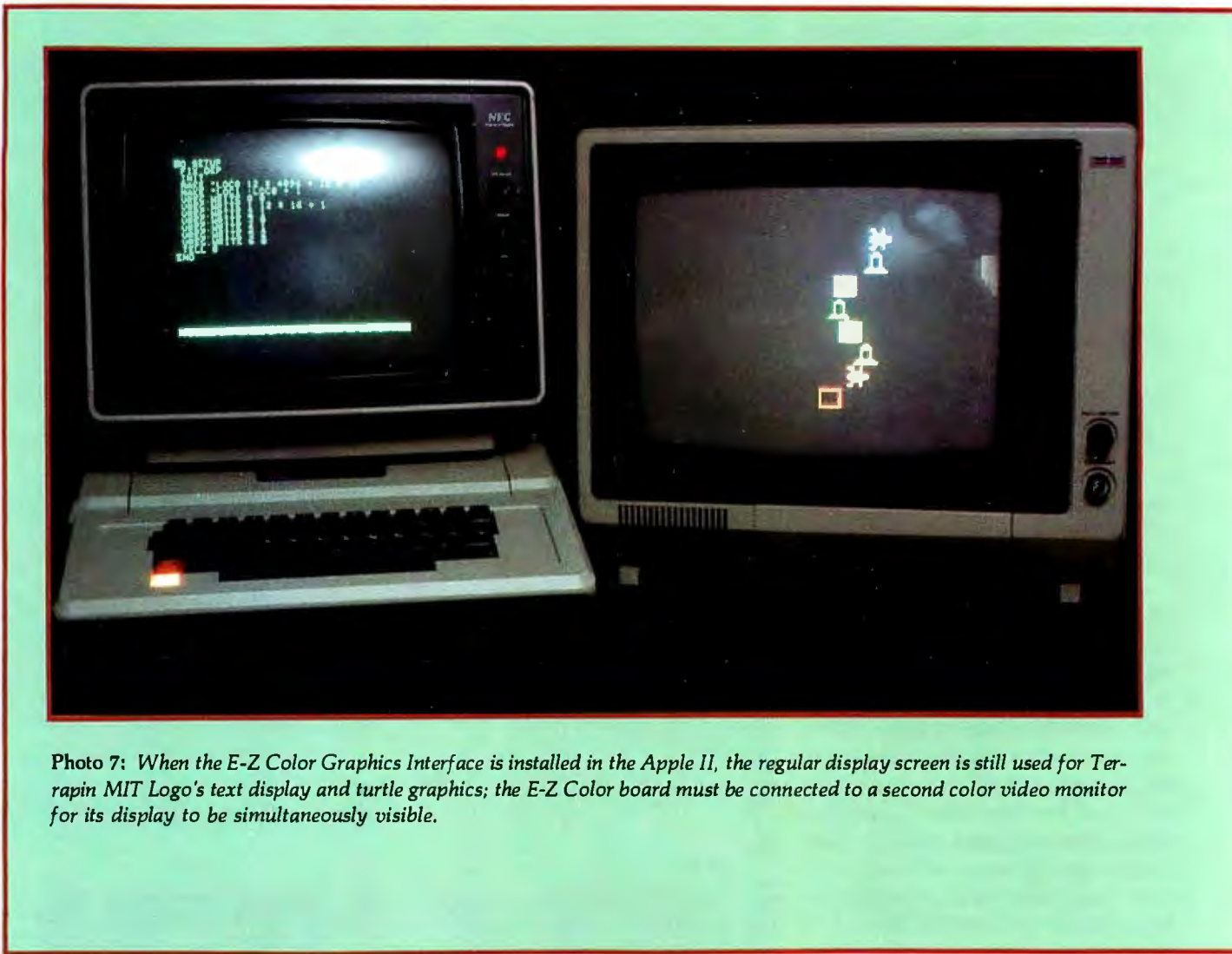

Photo 7: When the E-Z Color Graphics Interface is installed in the Apple II, the regular display screen is still used for Terapin MIT Logo's text display and turtle graphics; the E-Z Color board must be connected to a second color video monitor for its display to be simultaneously visible.

Listing 1: Program written in 6502 assembly language to run on an Apple II computer equipped with an E-Z Color Graphics Interface installed in motherboard slot 4.

```

LINE# LOC CODE      LINE
0002 0000          ;
0003 0000          ;*****
0004 0000          ;
0005 0000          ;          *** VIDEO DEMO ***
0006 0000          ;
0007 0000          ;
0008 0000          SLOT =          $40          ;SLOT = NO. X 10 HEX
0009 0000          KBD =          $C000         ;APPLE KEYBOARD DATA
0010 0000          KSTRB =         $C010         ;KEYBOARD DATA CLEAR
0011 0000          VREG =          $C081+SLOT      ;VDP REGISTER
0012 0000          VDATA =         $C080+SLOT      ;VDP RAM
0013 0000          ;
0014 0000          *=          $1000          ;PROGRAM STARTING ADDRESS
0015 1000          ;
0016 1000          ;***** INITIALIZE VDG *****
0017 1000          ;
0018 1000 A087          LDY #$87          ;REGISTER SELECT
0019 1002 A207          LDX #$07          ;INITIALIZE COUNTER
0020 1004 BDC610 INIT1 LDA ITAB,X          ;LOAD INIT TABLE

```



Photo 8: The Logo procedures developed at Terrapin Inc. provide you with commands such as SETSHAPE, SETCOLOR, and SXY. You can map out your own sprite shapes and incorporate them into the routines, but some predefined patterns are provided, including a box, a rocket, a turtle, and a block.

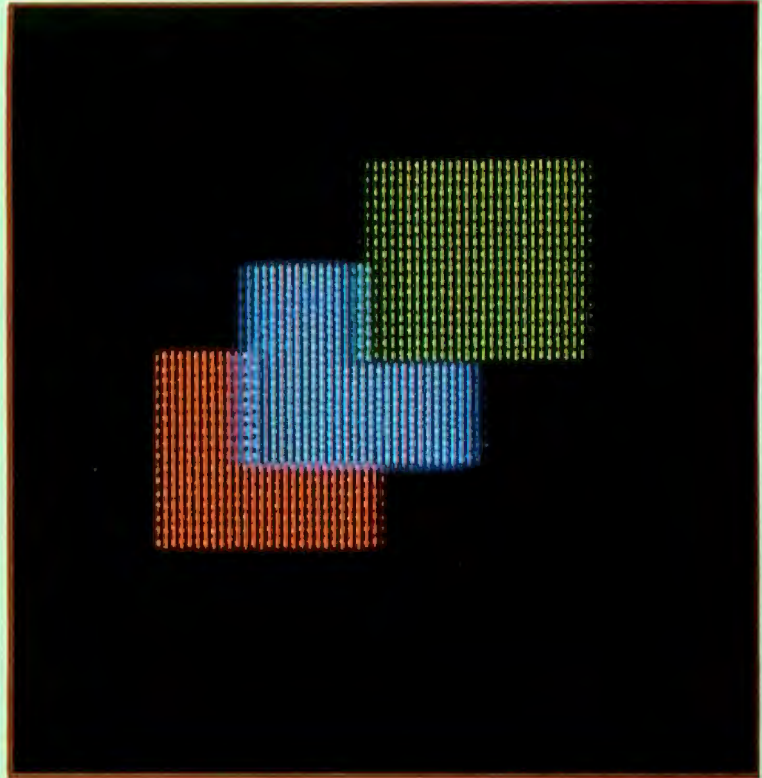

Photo 9: Each of the three boxes is drawn and placed in position with only four Logo statements.

Listing 1 continued:

```

0021 1007 209F10          JSR SREG          ;WRITE TO VDP
0022 100A 88             DEY                ;DECREMENT REGISTER
0023 100B CA             DEX                ;DECREMENT COUNTER
0024 100C D0F6          BNE INIT1         ;DONE?
0025 100E                ;
0026 100E                ;***** CLEAR ALL MEMORY *****
0027 100E                ;
0028 100E A040           LDY #$40          ;BYTE2 ADDRESS SET UP
0029 1010 A900           LDA #$00          ;BYTE1 ADDRESS SET UP
0030 1012 209F10        JSR SREG          ;WRITE TO VDP
0031 1015 A2C0           LDX #$C0          ;COUNTER HIGH BYTE
0032 1017 A000 NEXF     LDY #$00          ;COUNTER LOW BYTE
0033 1019 8DC0C0 FILL   STA VDATA         ;WRITE TO VDP RAM
0034 101C C8             INY                ;INCREMENT LOW COUNTER
0035 101D D0FA          BNE FILL         ;LOW COUNTER FULL?
0036 101F E8             INX                ;INCREMENT HIGH COUNTER
0037 1020 D0F5          BNE NEXF         ;HIGH COUNTER FULL?
0038 1022                ;
0039 1022                ;***** LOAD SPRITE ATTRIBUTES *****
0040 1022                ;
0041 1022 A047 LOOP     LDY #$47          ;BYTE2 AT 0700 HEX
0042 1024 A900           LDA #$00          ;BYTE1 ADDRESS SET UP
0043 1026 209F10        JSR SREG          ;WRITE TO VDP
0044 1029 A200           LDX #$00          ;INITIALIZE COUNTER

```

Listing 1 continued on page 70

```

LINE# LOC CODE LINE
0045 102B BDCE10 NEXA LDA ATAB,X ;LOAD ATTRIBUTE
0046 102E 8DC0C0 STA VDATA ;STORE TO VDP RAM
0047 1031 E8 INX ;INCREMENT COUNTER
0048 1032 8A TXA
0049 1033 C910 CMP #$10 ;TEST COUNTER
0050 1035 D0F4 BNE NEXA ;DONE?
0051 1037 ;
0052 1037 ;***** LOAD SPRITE PATTERNS *****
0053 1037 ;
0054 1037 A040 LDY #$40 ;BYTE2 AT 0000 HEX
0055 1039 A900 LDA #$00 ;BYTE1 ADDRESS SET UP
0056 103B 209F10 JSR SREG ;WRITE TO VDP
0057 103E A200 LDX #$00 ;INITIALIZE COUNTER
0058 1040 BDDE10 NEXTS LDA PTAB,X ;LOAD PATTERN BYTE
0059 1043 8DC0C0 STA VDATA ;STORE TO VDP RAM
0060 1046 E8 INX ;INCREMENT COUNTER
0061 1047 8A TXA
0062 1048 C980 CMP #$80 ;TEST COUNTER
0063 104A D0F4 BNE NEXTS ;DONE?
0064 104C ;
0065 104C ;***** CHANGE BACKGROUND *****
0066 104C ;
0067 104C AD00C0 CBACK LDA KBD ;TEST FOR
0068 104F C9CF CMP #$CF ;"O" KEY INPUT
0069 1051 D008 BNE CSIZE ;TO SET BACKGROUND COLOR
0070 1053 20A610 JSR LOADN ;READ KEYBOARD
0071 1056 A087 LDY #$87 ;BYTE1 REGISTER 7
0072 1058 209F10 JSR SREG ;STORE TO VDP
0073 105B ;
0074 105B ;***** CHANGE SIZE *****
0075 105B ;
0076 105B AD00C0 CSIZE LDA KBD ;TEST FOR LEFT ARROW
0077 105E C988 CMP #$88 ;MAGNIFICATION X 1
0078 1060 D00A BNE ONE
0079 1062 ADC710 LDA ITAB+1 ;LOAD REGISTER 1
0080 1065 29FE AND #$FE ;MASK 0 ON LSB
0081 1067 A081 LDY #$81 ;BYTE1 REGISTER 1
0082 1069 209F10 JSR SREG ;STORE TO VDP
0083 106C C995 ONE CMP #$95 ;TEST FOR RIGHT ARROW
0084 106E D00A BNE MOVE ;MAGNIFICATION X 2
0085 1070 ADC710 LDA ITAB+1 ;LOAD REGISTER 1
0086 1073 0901 ORA #$01 ;MASK 1 ON LSB
0087 1075 A081 LDY #$81 ;BYTE1 REGISTER 1
0088 1077 209F10 JSR SREG ;STORE TO VDP
0089 107A ;
0090 107A ;***** MOVE SPRITES *****
0091 107A ;
0092 107A AD00C0 MOVE LDA KBD ;MOVE?
0093 107D C9CD CMP #$CD ;TEST FOR "M" KEY
0094 107F D018 BNE JUMP
0095 1081 EECE10 INC ATAB ;SPRITE0 UP
0096 1084 CECF10 DEC ATAB+1 ;SPRITE0 LEFT
0097 1087 EED210 INC ATAB+4 ;SPRITE1 UP
0098 108A EED310 INC ATAB+5 ;SPRITE1 RIGHT
0099 108D CED610 DEC ATAB+8 ;SPRITE2 DOWN
0100 1090 CED710 DEC ATAB+9 ;SPRITE2 LEFT
0101 1093 CEDA10 DEC ATAB+$C ;SPRITE3 DOWN
0102 1096 EEDB10 INC ATAB+$D ;SPRITE3 RIGHT
0103 1099 2C10C0 JUMP BIT KSTRB ;CLEAR KEYBOARD

```

Verbatim Datalife™ flexible disks now come in a bold, new storage box. But more important, they now come to you with a five year warranty.*

We can give you a warranty this long because we're confident the way we make Datalife disks will make them perform better, last even longer.

All of our Datalife disks feature seven data-shielding advances for greater disk durability, longer data life. To protect your data from head-to-disk abrasion. To shield your data against loss due to environmental conditions. To insure a longer lifetime of trouble-free data

recording, storage and retrieval.

Every Datalife disk is extensively tested under the most extreme conditions. Critically-certified to be 100% error-free. Assuring you an added margin of performance, no matter what the operating conditions.

And we back it up with a five year warranty. Five times longer than the industry standard. Because Verbatim is the standard of excellence.

For flexible disks you can depend on—a lot longer—call (800) 538-1793. In California, or outside the U.S. call (408) 737-7771

collect for the name of your Verbatim dealer.

If you want longer data life, keep all your data on Verbatim Datalife. Our name is the promise. Our warranty is the proof.

Datalife



Verbatim®

Here's the most exciting part of Verbatim's new packaging.

5 Year Warranty

Listing 1 continued:

```
LINE# LOC CODE      LINE
0104 109C 4C2210          JMP LOOP                ;JUMP TO START
0105 109F          ;
0106 109F          ;
0107 109F          ;***** STORE VIDEO REGISTERS *****
0108 109F          ;
0109 109F 8DC1C0 SREG   STA VREG            ;STORE BYTE1
0110 10A2 8CC1C0          STY VREG            ;STORE BYTE2
0111 10A5 60          RTS                ;RETURN
0112 10A6          ;
0113 10A6          ;***** LOAD KEYBOARD INPUT *****
0114 10A6          ;
0115 10A6 2C10C0 LOADN  BIT KSTRB          ;CLEAR KEYBOARD
0116 10A9 2C00C0 WAIT   BIT KBD           ;TEST KEYBOARD
0117 10AC 10FB          BPL WAIT           ;IS KEY PRESSED ?
0118 10AE AD00C0          LDA KBD
0119 10B1 29F0          AND #$F0           ;TEST IF NUMERICAL INPUT
0120 10B3 C9C0          CMP #$C0
0121 10B5 F006          BEQ LETER
0122 10B7 AD00C0          LDA KBD
0123 10BA 290F          AND #$0F           ;MASK OFF HIGH NIBBLE
0124 10BC 60          RTS                ;RETURN
0125 10BD AD00C0 LETER  LDA KBD
0126 10C0 18          CLC
0127 10C1 6909          ADC #$09           ;CONVERT INPUT TO HEX VALUE
0128 10C3 290F          AND #$0F           ;MASK OFF HIGH NIBBLE
0129 10C5 60          RTS                ;RETURN
0130 10C6          ;
0131 10C6          ;***** TABLES ***
0132 10C6          ;
0133 10C6 02          ITAB  .BYT $02,$C2,$01,$80 ;INITIALIZE TABLE
0133 10C7 C2
0133 10C8 01
0133 10C9 80
0134 10CA 01          .BYT $01,$0E,$00,$01
0134 10CB 0E
0134 10CC 00
0134 10CD 01
0135 10CE          ;
0136 10CE 40          ATAB  .BYT $40,$60,$00,$03 ;SPRITE 0 ATTRIBUTE
0136 10CF 60
0136 10D0 00
0136 10D1 03
0137 10D2 60          .BYT $60,$60,$04,$07 ;SPRITE 1 ATTRIBUTE
0137 10D3 60
0137 10D4 04
0137 10D5 07
0138 10D6 40          .BYT $40,$80,$08,$0B ;SPRITE 2 ATTRIBUTE
0138 10D7 80
0138 10D8 08
0138 10D9 0B
0139 10DA 60          .BYT $60,$80,$0C,$0F ;SPRITE 3 ATTRIBUTE
0139 10DB 80
0139 10DC 0C
0139 10DD 0F
0140 10DE          ;
0141 10DE FF80        PTAB  .DBY $FF80,$8080,$8080,$8080 ;SPRITE 0 PATTERN
0141 10E0 8080
0141 10E2 8080
0141 10E4 8080
```

Listing 1 continued on page 76

RCA Microboards speak your language.

Write 100 percent of your code—including I/O control statements—in high-level language for most applications.

These six languages have been tailored especially for RCA CMOS microprocessors and Microboards.

BASIC 1.

- Compiler/interpreter.
- Develop program using interpreter and compile for code compactness in target system.

BASIC 2.

- Extended BASIC interpreter with μ P I/O control statements.

- Floating point math, string variables, multi-dimensional arrays.

BASIC 3.

- ROM-BASIC interpreter runs on low-cost Microboard Development Systems.
- Run-time, auto-start interpreter ROM option available (also for BASIC 2).

Micro Concurrent PASCAL.*

- For real-time multi-tasking 1802 and Microboard applications.
- Cross-compilers available for most computers.
- ROM-able 1802 p-code interpreters, with and without floating point.
- Also available on CompuServe time-sharing service.

PLM-1800.

- 1802 microprocessor dialect of PL-1.

- Structured language.

- Runs on RCA development systems.

MACROASSEMBLER.

- Nested macro capability lets you define your own instructions.

- Parameter substitution.

- Conditional and repetitive assembly.

In plain English: whatever your μ P or Microboard application, we've made it easier than ever to program.

You can get started now with one of our development systems. The price of the low-cost system is only \$499.**

Contact any RCA Solid State sales office, representative or distributor. **Or call (800)526-3862.**

*Trademark of Enertec, Inc.

**Optional U.S. distributor resale.

RCA Solid State headquarters: Somerville, NJ. Paris. London. Hamburg. Sao Paulo. Hong Kong.

Circle 355 on inquiry card.

BASIC 1

BASIC 2

BASIC 3

**Micro Concurrent
PASCAL**

PLM-1800

**MACRO-
ASSEMBLER**

"Old Reliable"

RCA

COMPUVIEW'S CP/M-86 GIVES YOU WHAT IBM CAN'T

Increased Productivity

Innovative features which dramatically increase productivity include built-in horizontal scrolling for up to 254 columns and screen line editing, which lets you extensively edit or re-enter any command line on the screen for CP/M-86 and application programs. Previously only available on mainframe computers, this greatly reduces the amount of re-typing necessary due to mis-typed or repeated commands. Long strings of commands can also be repeated with a few keystrokes. Its almost like having a built-in full screen editor for every program you use. And with 25% more disk capacity you will be swapping disks a lot less.

We Don't Lock You In

We can read and write not only IBM CP/M-86 disks, but also IBM MSDOS and many other CP/M double density disks. And files may be transferred with other CP/M and CP/M-86 computers via the serial port. The screen driver with status line and horizontal scrolling faithfully emulates many popular terminals. Of course we're software compatible with IBM and have a superset of their features. And you may even find our manual to be better than IBM's.

No Software Shortage

Most CBASIC programs will run perfectly with our CP/M-86 and CBASIC-86. Even most programs compiled with CBASIC 8080 will run with CBASIC-86. And Pascal-MT is available too. Remember, we emulate most CRT terminals.

V-COM DISASSEMBLER Labels, ASCII, Exceptional Speed

No other Z80 CP/M disassembler produces understandable source code as quickly as V-COM. It is INTEL and ZILOG compatible, and features easy to read code with a cross reference table. Best of all, it can create source code with user defined labels, storage areas and ASCII strings. V-COM is exceptionally fast and can disassemble a typical 12K .COM file into a 76K .ASM file, containing 7500 lines of source code, and a 33K cross reference file in under two minutes with 8" SD floppies. (About five times faster than others).

The unique user created information files let you specify labels for 8 and 16 bit values and the location of storage areas, tables and ASCII strings. The disassembled code can be sent to the console, the disk and the printer, or any combination at once.

Compare CompuView with IBM CP/M-86

Feature	Compuview	IBM
Horizontal Scrolling	Yes	No
Screen Line Editing	Yes	No
Page Control	Yes	No
Emulate Popular Terminals	Yes	No
'Smart' CRT Functions	Yes	No
Read/Write IBM MSDOS Disks	Yes	No
Serial File Transfer	Yes	No
Support Non-IBM Hardware	Yes	No
Menu Driven Configuration	Yes	No
Programmable Function Keys	Yes	Yes
Status Line	Yes	Yes
Serial and Parallel Printers	Yes	Yes
File Capacity	193K	154K

CP/M-86 for IBM PC \$285
 Quad Density Drive Version . \$350
 Winchester Disk Version \$425
 Manual Only \$20

VEDIT-86 With Above
 Purchase \$125
 This version of VEDIT has horizontal scrolling up to 254 columns

CBASIC-86 \$325
 PASCAL-MT-86 \$600

782K for your IBM PC

Tandon quad density, double sided drive gives 782K file capacity. Fits into IBM PC as drive B or connect two externally as drives C and D. Requires CompuView CP/M-86. Easy to install. \$450
 Complete external drive expansion with 1.5Mbyte capacity. Call

Each package includes a 30 page manual, sample program files and variations of V-COM compatible with TDL, MAC and ZILOG assemblers. Feature for feature, no other disassembler at any price even comes close. \$80
 Manual Only \$12

8086 SOFTWARE

VEDIT full screen editor for CP/M-86, MSDOS, IBM Personal Computer and IBM Displaywriter \$195

CP/M-86 BIOS for popular S-100 disk controllers and SCP 8086 computer. Source Code \$90

Bootable CP/M-86 disks for popular S-100 computers . . Call



The newest generation VEDIT combines sophisticated program development editing with useful word processing features and new powerful 'TECO' like macros.

User Oriented

Fast and easy editing for program development and word processing. Includes automatic screen scrolling, a status line with the cursor's line and column positions, an 'Undo' key, and recovery from full disk conditions (you can delete files or change disks). Fully adapts to your system with a menu driven customization for keyboard layout, CRT selection and more. Since VEDIT receives major enhancements twice a year, you're assured that VEDIT will always be 'state of the art' with our inexpensive update option and support you can really count on.

Performance

Exceptional speed and true 'what you see is what you get' full screen editing with a convenient array of cursor movements and editing functions. Edits files up to one disk in length, and holds up to 45K of a file entirely in memory. You can insert a specified line range of another file anywhere in the text, and change disks in the middle of an edit session. Includes search and replace, text move and copy, complete file handling and flexible macros. Unique automatic indenting for use with structured languages such as Pascal, 'C' and PL/I. Other features for assembly language, Fortran and Cobol.

Word Processing

Features include word wrap, adjustable left margin, reformatting of paragraphs, word and paragraph oriented cursor movement and deleting, and printing with imbedding of printer control characters. May be used stand-alone or in conjunction with most text output processors.

Hardware Support

CRT version supports over 40 terminals, including ANSI standard and all screen sizes. Utilizes 'smart' terminal features for fast screen updating. Your keyboard layout can use any available function and cursor keys. Memory mapped version offer high speed, flexibility, supports bank select and the SSM VB3. Versions for Fulcrum VIO-X, PIICEON and TDL video boards.

New Macros

Ten buffers can hold macro command strings. These may be executed, edited, saved and loaded from disk. Macros can perform complex editing operations. (For example, a macro could automatically perform a series of global search and replace on many files). The buffers may also hold text, allowing extensive text 'cut and paste', including portions from multiple files. New startup command file can also setup VEDIT parameters, initialize a terminal's programmable function keys and more.

Ordering

Please specify your microcomputer, video board or the CRT terminal version, 8080, Z80 or 8086 code, and disk format.

VEDIT - Disk and Manual
 For 8080 or Z80 \$150
 For CP/M-86 or MSDOS \$195
 Manual Only \$18

VISA and MASTERCARD

Dealers - You can now carry VEDIT
 and V-COM on consignment.

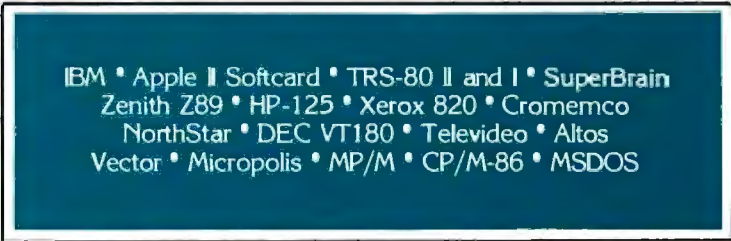

1955 Pauline Blvd., Suite 200
 Ann Arbor, Michigan 48103
 (313) 996-1299

CompuView
 PRODUCTS, INC.

CP/M and MP/M are registered trademarks of Digital Research, Inc. Apple II is a registered trademark of Apple Computer, Inc. Softcard is a trademark of Microsoft. TRS-80 is a trademark of Tandy Corporation. IBM Personal Computer is a trademark of International Business Machines, Inc.

MAINFRAME FEATURES FOR MICROCOMPUTERS

Listing 1 continued:

LINE#	LOC	CODE	LINE	
0142	10E6	8080		.DBY \$8080,\$8080,\$8080,\$80FF ;16 X 16 PIXELS
0142	10E8	8080		
0142	10EA	8080		
0142	10EC	80FF		
0143	10EE	FF01		.DBY \$FF01,\$0101,\$0101,\$0101 ;32 BYTES / SPRITE
0143	10F0	0101		
0143	10F2	0101		
0143	10F4	0101		
0144	10F6	0101		.DBY \$0101,\$0101,\$0101,\$01FF
0144	10F8	0101		
0144	10FA	0101		
0144	10FC	01FF		
0145	10FE		;	
0146	10FE	FF80		.DBY \$FF80,\$879F,\$9880,\$8083 ;SPRITE 1 PATTERN
0146	1100	879F		
0146	1102	9880		
0146	1104	8083		
0147	1106	8380		.DBY \$8380,\$8098,\$9F8F,\$80FF
0147	1108	8098		
0147	110A	9F8F		
0147	110C	80FF		
0148	110E	FF01		.DBY \$FF01,\$F1F9,\$1919,\$31F1
0148	1110	F1F9		
0148	1112	1919		
0148	1114	31F1		
0149	1116	F139		.DBY \$F139,\$1919,\$F9F1,\$01FF
0149	1118	1919		
0149	111A	F9F1		
0149	111C	01FF		
0150	111E		;	
0151	111E	AA55		.DBY \$AA55,\$AA55,\$AA55,\$AA55 ;SPRITE 2 PATTERN
0151	1120	AA55		
0151	1122	AA55		
0151	1124	AA55		
0152	1126	AA55		.DBY \$AA55,\$AA55,\$AA55,\$AA55
0152	1128	AA55		
0152	112A	AA55		
0152	112C	AA55		
0153	112E	AA55		.DBY \$AA55,\$AA55,\$AA55,\$AA55
0153	1130	AA55		
0153	1132	AA55		
0153	1134	AA55		
0154	1136	AA55		.DBY \$AA55,\$AA55,\$AA55,\$AA55
0154	1138	AA55		
0154	113A	AA55		
0154	113C	AA55		
0155	113E		;	
0156	113E	AAAA		.DBY \$AAAA,\$AAAA,\$AAAA,\$AAAA ;SPRITE 3 PATTERN
0156	1140	AAAA		
0156	1142	AAAA		
0156	1144	AAAA		
0157	1146	AAAA		.DBY \$AAAA,\$AAAA,\$AAAA,\$AAAA
0157	1148	AAAA		
0157	114A	AAAA		
0157	114C	AAAA		
0158	114E	AAAA		.DBY \$AAAA,\$AAAA,\$AAAA,\$AAAA
0158	1150	AAAA		
0158	1152	AAAA		
0158	1154	AAAA		

Listing 1 continued on page 78

GALAXY OF FEATURES

A GALAXY of features makes the LNW80 a remarkable computer. As you explore the LNW80, you will find the most complete, powerful, ready to run, feature-packed personal and business computer ever made into one compact solid unit.



MODEL I COMPATIBILITY - The LNW80 is fully hardware and software compatible with the Model I. Select from a universe of hardware accessories and software - from VisiCalc® to space games, your LNW80 will launch you into a new world of computing.

FULLY LOADED - A full payload includes an on-board single and double density disk controller for 5 1/4" and 8" single or double sided disk drives. RS232C communications port, cassette and parallel printer interfaces are standard features and ready to go. All memory is fully installed - 48K RAM, 16K graphics RAM and 12K ROM complete with Microsoft BASIC.

QUALITY CONSTRUCTION - Instrumentation quality construction sets LNW80 computers apart from all the rest. Integrated into the sleek solid steel case of the LNW80 is a professional 74-key expanded keyboard that includes a twelve key numeric keypad.

HIGH RESOLUTION GRAPHICS & COLOR - The stunning 480 X 192 resolution gives you total display control - in color or black and white. The choice of display formats is yours; 80, 64, 40 and 32 columns by 24 or 16 lines in any combination of eight colors.

PERFORMANCE - Lift-off with a 4MHz Z80A CPU for twice the performance. The LNW80 outperforms all computers in its class.



Our down to earth price won't send you into orbit

LNW Research Corp.

2620 WALNUT Tustin, CA. 92680
(714) 641-8850 (714) 544-5744

Monitor and Disk drives not included
TM Personal Software, Inc.

Listing 1 continued:

```
LINE# LOC CODE    LINE
0159 1156 AAAA          .DBY $AAAA, $AAAA, $AAAA, $AAAA
0159 1158 AAAA
0159 115A AAAA
0159 115C AAAA
0160 115E          ;
0161 115E          .END
```

ERRORS = 0000 <0000>

SYMBOL TABLE

SYMBOL	VALUE
ATAB	10CE CBACK 104C CSIZE 105B
FILL	1019 INIT1 1004 ITAB 10C6
JUMP	1099 KBD C000 KSTRB C010
LETER	10BD LOADN 10A6 LOOP 1022
MOVE	107A NEXA 102B NEXF 1017
NEXTS	1040 ONE 106C PTAB 10DE
SLOT	0040 SREG 109F VDATA C0C0
VREG	C0C1 WAIT 10A9
END OF ASSEMBLY	

Compare our price and performance. *Le Monitor is second to none!*



A complete line of monitors with these outstanding features.

- 9" and 12" models
- Green or white phosphor
- 80x24 character display
- High resolution-800 lines, non-glare CRT
- 1 year warranty!

**Dealer Inquiries
Invited**

Pi-Tech Limited
2 Douglas Pike
Smithfield, RI 02917
(401) 231-2080
TWX 710-381-8788

Q.I. Distributors
18720 Oxnard
Tarzana, CA 91356
(800) 423-5886
in CA (213) 996-2252

MICRO-SCI IS IN THE GAME FOR ALL THE APPLES...

μ-SCI

μ-SCI



...WITH A FULL HOUSE OF 5 1/4" DRIVES

Micro-Sci has three disk drives and two controllers so you can configure your Apple II™ or Apple II Plus™ system to fit your individual budget and performance requirements.

THE FIRST ACE — A2

The new A2 is the price/compatibility substitute for the Disk II™, intended as the second drive on an existing controller, or as a full A2 subsystem. The A2 drive or A2 subsystem is an ideal choice when the drives will be primarily used for entertainment or prepackaged software programs.

THE SECOND ACE — A40

The A40 is a price/performance alternative to the Disk II. With 40 tracks, you get an additional 20K bytes, and faster track-to-track access. The A40 is intended for use in dedicated DOS, CP/M and Pascal applications, and as a companion drive for the A70. The A40 is Micro-Sci's most cost-effective

disk subsystem for the Apple IIs.

THE THIRD ACE — A70

At over a quarter million bytes per drive, the A70 has the capacity of two Disk IIs or an eight-inch floppy, but costs only slightly more than a single Disk II. One A70 supports a DOS file as large as 270K, a CP/M file up to 254K, and 560 blocks in Pascal.

THE PAIR — MICRO-SCI'S CONTROLLERS

The A2 comes with a unique new controller. This controller supports any combination of A2s or Disk IIs, you have complete flexibility.

The A40 and A70 share a common controller. Mix A40s and A70s in any fashion, one A40 with one A70, two A40s or two A70s — all on the same controller.

You can have a Disk II or A2 controller with

Disk II or A2 drives and still add an A40 or A70 subsystem. That's full system-level compatibility.

THE PAT HAND

Versatility, reliability, capability are assured when choosing Micro-Sci. Pick the drive, pick the controller, pick the capacity and function. Whatever your need, DOS 3.2, 3.3, Pascal, CP/M, games or pre-packaged software, Micro-Sci has the drive. Start wherever you choose with the knowledge that you can expand without concern. All Micro-Sci products are backed by a full 120-day warranty (parts and labor).

Our complete line of Apple compatible products makes us the dealer's choice. We're always looking for good dealers.

International dealer inquiries:
International Market Co., Telex: 69-6191.
TELEX CD LSA

μ-SCI

MICRO-SCI

17742 IRVINE BOULEVARD • SUITE 205 • TUSTIN, CALIFORNIA 92680 • 714/731-9461 • TELEX: 910-346-6739

MICRO-SCI IS A DIVISION OF STANDUN CONTROLS, INC.

™—APPLE II, APPLE II PLUS **DISK II ©—APPLE, APPLE II AND DISK II ARE REGISTERED TRADEMARKS OF APPLE COMPUTERS, CUPERTINO, CALIFORNIA

Continued from page 67:

```
TELL 0
SETSHAPE :BOX
SETCOLOR :GREEN
SXY 20 20
```

The first command specifies that sprite 0 is being addressed. The second tells Logo to use the predefined box pattern, while the third says that the sprite is to be colored green (remember, the rest of the sprite plane will be transparent). Then the fourth command states that the sprite is to be drawn at coordinate 20,20.

Now, to add the blue box as sprite 1 at x,y coordinates 12,12.

```
TELL 1
SETSHAPE :BOX
SETCOLOR :BLUE
SXY 12 12
```

Finally, to draw the red box as sprite 2 at position 5,5.

```
TELL 2
SETSHAPE :BOX
SETCOLOR :RED
SXY 5 5
```

A turtle can be drawn simply by using a similar procedure substituting the command SETSHAPE :TURTLE.

At this writing, Terrapin MIT Logo does not support turtle velocity (automatic constant movement actuated by the commands SETSPEED and SETHEADING) as does the Logo package available for the Texas Instruments TI 99/4A microcomputer,

but a future version of Terrapin's product may do so.

In Conclusion

The TMS9918A Video Display Processor has many more capabilities than I have room to write about here, and my examples of a few boxes and turtles are an inadequate demonstration of the powerful combination of the E-Z Color Graphics Interface and Terrapin MIT Logo. I am certain that you can fully appreciate them only by observing a dynamic display and seeing how few commands are needed to create it.

I don't usually get excited over mega-bit-width processors or super-high-level languages. What does excite me, however, is taking one of my projects hot off the soldering iron and seeing it operate so easily in synergism with someone else's work. After seeing the graceful mating of the E-Z Color Graphics Interface with Terrapin MIT Logo, I can't help but be excited about other sprite-graphics applications.

Next Month:

Build the MicroVox text-to-speech voice synthesizer. ■

References

1. Gutttag, Karl and John Hayn. "Video Display Processor Simulates Three Dimensions," *Electronics*, November 20, 1980, page 123.
2. Nelson, Harold. "Logo for Personal Computers," *BYTE*, June 1981, page 36.
3. *TMS9918A Video Display Processor*. Houston, TX: Texas Instruments Semiconductor Group, 1981.

Editor's Note: Steve often refers to previous *Circuit Cellar* articles as reference material for each month's current article. Most of these past articles are available in reprint books from *BYTE Books*, 70 Main St., Peterborough, NH 03458. *Ciarcia's Circuit Cellar, Volume I*, covers articles that appeared in *BYTE* from September 1977 through November 1978. *Ciarcia's Circuit Cellar, Volume II*, contains articles from December 1978 through June 1980. *Ciarcia's Circuit Cellar, Volume III*, contains the articles that were published from July 1980 through December 1981.

To receive a complete list of Ciarcia's *Circuit Cellar* project kits available from the *Micromint*, circle 100 on the reader service inquiry card at the back of the magazine.

Parts Source

The following products are available from:

The Micromint Inc.
917 Midway
Woodmere, NY 11598
telephone: (516) 374-6793
(for technical data)
(800) 645-3479
(orders only)

Apple II plug-compatible E-Z Color Graphics Interface, provided with user manual, sample programs, and TMS9918A reference manual.

Assembled and tested.....\$175
Kit.....\$150

Terrapin MIT Logo for the Apple II; requires 48K-byte user memory and one floppy-disk drive.

On DOS version 3.3 disk. . Call for price

S-100-bus and IBM Personal Computer versions of the E-Z Color Graphics Interface are planned. Call for price and availability.

Prices include shipping in the U.S. Foreign orders add \$8 for shipping. Residents of the state of New York please add 7% sales tax.

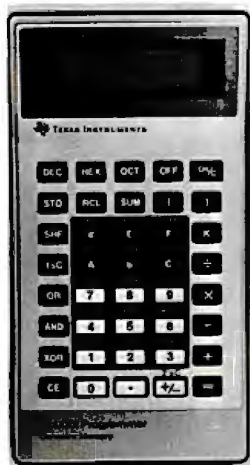

New! TI LCD Programmer. Hexadecimal and Octal Calculator/Converter.

The brand new tilt-top TI LCD Programmer can save you hours of work. It was designed specifically for the problems you do, and has features that make it ideally suited for applications in computer programming, debugging, repair and digital logic design.

- Performs arithmetic in any of three number bases — OCT, DEC, HEX.
- Integer, two's complement arithmetic in OCT and HEX.
- One's complement capability in OCT and HEX.
- Converts numbers between OCT, DEC and HEX.
- Fifteen sets of parentheses available at each of four processing levels.
- Logical functions AND, OR, EXCLUSIVE OR and SHIFT operate bit by bit on OCT or HEX numbers.

Unisource Electronics has committed to buy TI's initial production of this unique product. Availability is limited! Order now.

15-Day Free Trial.

The best way to evaluate the TI LCD Programmer is to try it yourself — on the job — for 15 days. If you're not 100% satisfied, simply return it for a full refund. Order now by calling toll-free:

1-800-858-4580

In Texas call 1-808-745-8835

Lines open 8 am to 6 pm CST



Just give us your name, shipping address and Visa or MasterCard number and we will charge the tax deductible* \$75.00 purchase price, plus \$2.00 shipping and handling (Texas residents also add 5% sales tax) to your account. Or send your check or money order to:

Unisource Electronics, Inc.
P.O. Box 64240 • Lubbock, Tx. 79464

* When used for business.



Introducing a direct line to a 60 MHz Tektronix scope built for your bench!

From the world's most respected name in oscilloscopes: a new scope, plus a new direct order number, that finally makes it practical to put Tektronix quality on your bench... at work or home.

Among professional engineers and technicians there is no substitute for the performance and reliability of Tektronix oscilloscopes.

Now, for the first time, Tektronix is offering an advanced scope at an unprecedented low price—and has a direct order line that lets you get your order processed today!

The scope: the 2213. Its radical new design brings you Tektronix quality for well below what you would pay for

lesser-name scopes.

The 2213's practical design includes 65% fewer mechanical parts, fewer circuit boards, electrical connectors and cabling. Result: a lower price for you plus far greater reliability.

Yet performance is pure Tektronix: there's 60 MHz bandwidth for digital and high-speed analog circuits. The sensitivity for low signal measurements. The sweep speeds for fast logic families. A complete trigger system for digital, analog or video waveforms. And new high-performance Tektronix probes are included!

2213 PERFORMANCE DATA

Bandwidth: Two channels, dc—60 MHz from 10 V/div to 20 mV/div. (50 MHz from

2 mV/div to 10 mV/div).

Sweep speeds: Sweeps from 0.5 s to 50 ns (to 5 ns/div with X10 mag).

Sensitivity: Scale factors from 100 V/div (10X probe) to 2 mV/div (1X probe). Accurate to $\pm 3\%$. Ac or dc coupling.

Delayed sweep measurements: Standard sweep, intensified after delay, and delayed.

(Need dual time-base performance and timing accuracy to $\pm 1.5\%$? Ask about our 2215 priced at \$1400.)

Complete trigger system: Modes include TV field, normal, vertical mode, and automatic; internal, external, and line sources; variable holdoff.

Probes: High perform-

ance, positive attachment, 10-14 pF and 60 MHz at the probe tip.

The price: Just \$1100 complete*. Order direct from Tektronix National Marketing Center. Phones are staffed by technical people to answer your questions about the 2213. Your direct order includes a 15-day return policy and full Tektronix warranty.

Now it's easier than ever to get your hands on a Tek scope!

ORDER TOLL-FREE

800-547-1845

Ask for Dept. A0328

(In Oregon, Alaska and Hawaii: 1-503-627-5402 collect.) Lines are open from 8 am EST to 5 pm PST.

*Price F.O.B., Beaverton, OR.

ZX81

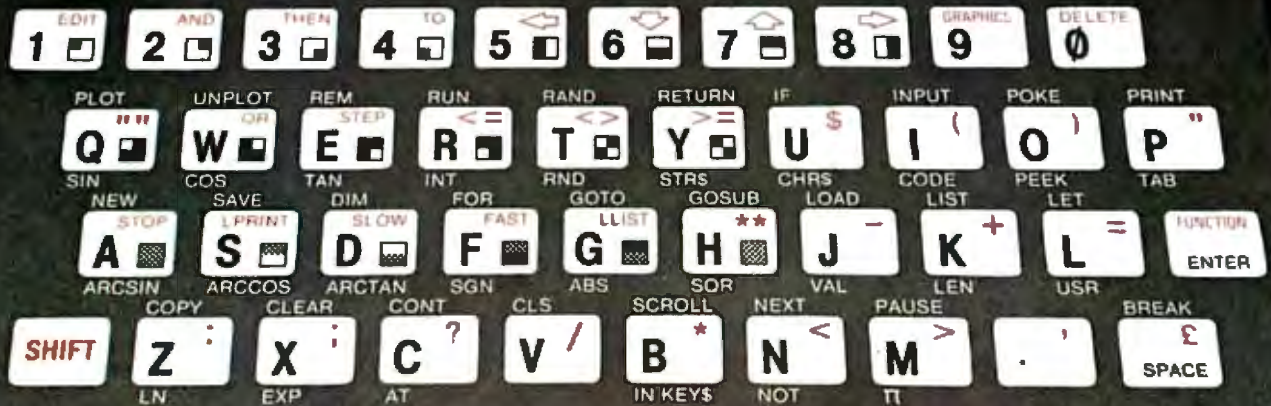

Introducing the Sinclair ZX81.

If you're ever going to buy a personal computer, now is the time to do it.

The Sinclair ZX81 is the most powerful, yet easy-to-use computer ever offered for anywhere near the price:

only \$99.95* completely assembled.

Don't let the price fool you. The ZX81 has just about everything you could ask for in a personal computer.

A breakthrough in personal computers.

The ZX81 is a major advance over the original Sinclair ZX80 – the first personal computer to break the price barrier at \$200.

In fact, the ZX81's 8K extended BASIC offers features found only on computers costing two or three times as much.

Just look at what you get:

- Continuous display, including moving graphics

THE \$99.95 PERSONAL COMPUTER.

- Multi-dimensional string and numerical arrays
- Mathematical and scientific functions accurate to 8 decimal places
- Unique one-touch entry of key words like PRINT, RUN and LIST
- Automatic syntax error detection and easy editing
- Randomize function

useful for both games and serious applications

- 1K of memory expandable to 16K
- A comprehensive programming guide and operating manual

The ZX81 is also very convenient to use. It hooks up to any television set to produce a clear 32-column by 24-line display. It comes with a comprehensive programming guide and operating manual designed for both beginners and experienced computer users. And you can use a regular cassette recorder to store and recall programs by name.

Order at no risk.**

We'll give you 10 days to try out the ZX81. If you're not completely satisfied, just return it to Sinclair Research and we'll give you a full refund.

And if you have a problem with your ZX81, send it to Sinclair Research within 90 days and we'll repair or replace it at no charge.

Introducing the ZX81 kit.

If you really want to save money, and you enjoy building electronic kits, you can order the ZX81 in kit form for the incredible price of just \$79.95.* It's the same, full-featured computer, only you put it together yourself. We'll send complete, easy-to-follow instructions on how you can assemble your ZX81 in just a few hours. All you have to supply is the soldering iron.

A leader in microelectronics.

The ZX81 represents the latest technology in microelectronics. More than 10,000 are sold every week. In fact, the ZX81 is the fastest selling personal computer in the world.

We urge you to place your order for the ZX81 today.

To order.

To order, simply call toll free. Or use the coupon below. Remember, you can try it for 10 days at no risk.** The sooner you order, the sooner you can start enjoying your own computer.

Call toll free 800-543-3000.

Ask for operator #509.
In Ohio call: 800-582-1364;
in Canada call: 513-729-4300.
Ask for operator #509. Phones open 24 hours a day, 7 days a week. Have your MasterCard or VISA ready.

These numbers are for orders only. If you just want information, please write: Sinclair Research Ltd., 2 Sinclair Plaza, Nashua, NH 03061.

*Plus shipping and handling. Price includes connectors for TV and cassette, AC adaptor, and FREE manual.
**Does not apply to ZX81 kits.

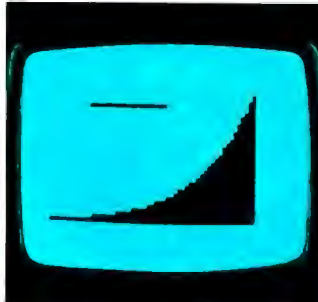

NEW SOFTWARE: Sinclair has published pre-recorded programs on cassettes for your ZX81. We're constantly coming out with new programs, so we'll send you our latest software catalog with your computer.



16K MEMORY MODULE: Like any powerful, full fledged computer, the ZX81 is expandable. Sinclair's 16K memory module plugs right onto the back of your ZX81. Cost is \$49.95, plus shipping and handling.

sinclair

To order call toll free: 800-543-3000

Ad Code	08BYOS	Price*	Qty.	Amount
ZX81		\$99.95		
ZX81 Kit		79.95		
16K Memory Module		49.95		
Shipping and Handling		4.95		\$4.95
TOTAL				

MAIL TO: Sinclair Research Ltd.,
One Sinclair Plaza, Nashua, NH 03061.

Name _____

Address _____

City _____ State _____ Zip _____

*U.S. dollars



And The Winners Are...

For those of you breathlessly awaiting the results of BYTE's Game Contest (see the December 1981 BYTE for details), direct your attention to the display before you. Although it was difficult to convince the judges to abandon their everyday routine and spend hours playing games, everyone eventually made that ultimate sacrifice. With bloodshot eyes fixed on the displays and nervous fingers manipulating keyboards and joysticks, these tireless individuals toiled day and night. And when the chairs were finally pushed away from the table . . .

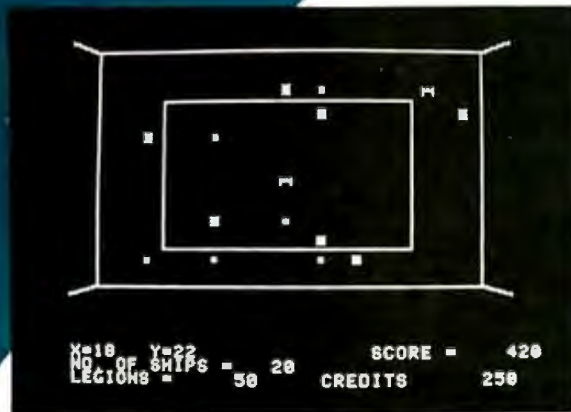

1

Cosmic Conquest Apple II
Alan Sartori-Angus
Grahamstown, Republic of South Africa
A real-time space strategy game.

2

Apple II **CHARGE!**
C. Anthony Ray
Urbana, Illinois
A trajectory game that shoots electrons through stationary ions.

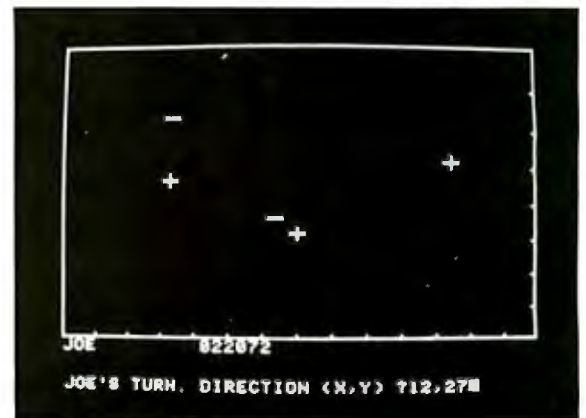

3



The Game of Rat and Dragon Apple II
Truck Smith
Fullerton, California
A chase with a rat, some cheese, and a dragon.

4

TRS-80
Model III

JETSET
(Jet
Simulator Elec-
tronic Trainer)

Gene Szymanski
Princeton, New Jersey
A flight simulator.

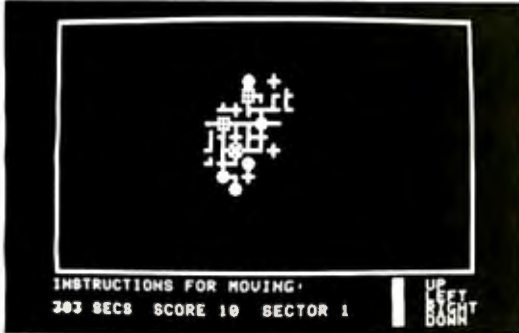

5

RINGQUEST Apple II
Gordon Mills
Bradford, England
A Tolkien-style
adventure.

6

TRS-80
Model III

**MARKET-
PLACE**

Robert Dickinson
Thousand Oaks,
California
A two-machine
marketing simulation.

RESULTS FOR		YEAR 1	QUARTER 1	MARKETPLACE VER 1 (1M)					
PROD	TECH	MFG	TECH	MKT	DEMAND	SOLD	COST	PRICE	
1 0	1 0	1 0	1 0	0 50	100	100	2500	3000	
1 0				0 50	100	100		3000	
INVENTORY	RET	EARN	PROD	R&D	MFG	R&D	ADVERT	FIXED	COST
0	1500 0		0 0	0 0	0 0	0 0		65 0	
	1500 0								

INPUT VALUES FOR QUARTER 2

MAXIMUM LOT SIZE 573
LOT SIZE ? 400
RETAINED EARNINGS 435 0
PRODUCT R&D BUDGET (IN 1000)? 100
MANUFACTURING R&D BUDGET (IN 1000)? 0
ADVERTISING BUDGET (IN 1000)? 0



7

Three Dee Tee TRS-80
John Stuart Color
Tulsa, Computer
Oklahoma
Tic-tac-toe on a
Cube.

8

Apple II

Quinti-Maze
Robert Tsuk
Plattsburgh, New York
A five by five by five
cubic maze.

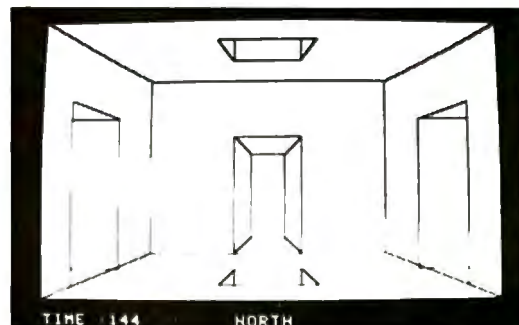

Think you have a better idea? . . . then read on

A Few Details

A detailed description and complete listing of each of the winning games will be published in future issues of BYTE. Beginning in September, two entries will be featured each month, culminating with the first and second place winners in the December 1982 BYTE games issue. Overall, the games submitted were original, playable, and enjoyable.

Fifty-one entries were received from 21 states and 6 foreign countries. Other statistics about the entries include:

Machines Used

- 19 Apples
- 13 TRS-80 Models I/III
- 9 TRS-80 Color Computers
- 4 Commodore VICs
- 3 CP/M machines
- 2 TRS-80 Model IIs
- 1 Atari 400/800

Types of Games Received

- 26 arcade games
- 8 simulations
- 7 adventures
- 5 board games
- 5 puzzle games

Programming Languages Employed

- 40 BASIC games
- 5 BASIC/machine-language games
- 3 machine-language games
- 2 Pascal games
- 1 FORTH game

Special thanks goes to Jon Swanson who administered the Game Contest and kept everything under control.

BYTE Game Contest #2

1982

* PRIZES *

Some Fortune, Some Fame
First Prize: \$500 Second Prize: \$300
Third, Fourth, and Fifth Prizes: a
custom-embroidered BYTE jacket.
Several Honorable Mention certificates
will also be awarded for other noteworthy
games. All winning games (including Honorable
Mention games) will be published in BYTE.

* A Game Is A Game Is A Game Is A Game Is A... *

What kinds of games are we looking for? Anything that's fun! Graphic arcade-style games, strategy games, puzzle games, text-only adventures, single- or multiplayer simulations, abstract games, and historical games. A game doesn't need to occupy 48K bytes of memory to be fun—it's the concept that counts! (For example, see *Quinti-Maze* and *Three Dee Tee*, the games to be published in the September 1982 *BYTE*.) We aren't interested in computer versions of games that already exist—we want to see something original!

* All The Rules Fit To Print *

- This contest will be judged by the *BYTE* editorial staff. Factors influencing the decision will be the originality and playability of the game, as well as the quality of the accompanying manuscript. The judges' decision is final.
- All entries should be marked on the outside: "MAGNETIC MATERIALS—DO NOT X-RAY."
- Game submissions cannot be returned unless they are accompanied by a return envelope stamped with sufficient postage.
- This contest is open to anyone except employees or immediate family of McGraw-Hill and its subsidiaries. Void where prohibited by law.
- Prizewinners will give all rights to the article to *BYTE* in exchange for the designated prizes. In all cases, the author retains all commercial rights to the software written, and *BYTE* readers may not distribute and/or sell the software without the author's permission. All prizewinners will receive the standard payment for a *BYTE* article (\$50 per published magazine page).
- Only one entry per contestant is permitted.
- Games must be in the format specified.

* Computers and Formats *

Prepare your game for one of the following computers, in the format indicated. (We apologize if your computer is not on this list, but we are limited by those to which we have access.) Games *must* be submitted on the appropriate media.

Apple II, Atari 800, Commodore PET/CBM, IBM Personal Computer, Radio Shack TRS-80 Model I or III: 5¼-inch disk

Commodore VIC, Radio Shack TRS-80 Color Computer: cassette tape

Radio Shack TRS-80 Model II: 8-inch disk

CP/M with "plain vanilla" terminal (i.e., no special features of the terminal are used): single-density 8-inch disk

Note: All disks (except for CP/M systems) must contain the operating system used and two copies of the game you are submitting. If your game is on cassette tape, be sure to record several copies of the game on a high-quality tape recorder.

Submit your game on the magnetic media listed for your computer. Include whatever documentation may be necessary to play your game: a clear listing on unlined paper, a brief introduction to the game, how it was designed, and how it works. All written materials should be typed double-space for possible publication in BYTE. (Send a stamped, self-addressed legal-size envelope for a copy of our author's guide.)

* DEADLINE *

Entries must be sent to:

BYTE Game Contest
POB 372
Hancock, NH 03449

Entries will *not* be accepted before January 1, 1983, and must be postmarked no later than February 15, 1983. Results will be published in the July 1983 BYTE.

* Hints, Clues, Tricks, and Other Helpful Info *

Four words are your passport to success in the Second BYTE Game Contest:

Imagination, Playability, Presentation, and Simplicity

Imagination: What the gaming community has seen very rarely is a game that fully exploits the unique strengths of the computer (and avoids its weaknesses). Ask yourself, "What is my computer good at? How can I design a game around it? What kind of game can I create that has never been seen before?"

Playability: A technically perfect game that isn't fun to play has no chance in the Second BYTE Game Contest. Be sure that your game appeals to the player(s): action games should have variation, pacing, and increasing levels of difficulty; strategy games should give the players a "rich" set of moves that allow them to exercise their ingenuity and cunning in the face of victory or defeat; adventures should be self-consistent and clever. All games should make user input easy to understand by including error-trapping and other user-friendly features.

Presentation: You should pay as much attention to your presentation as you do to your game. In the next four months, look over BYTE's publication of winning entries (from the First Game Contest) to see which presentations caught our eye!

Simplicity: This quality is such an important component of playability that it deserves special mention. Games, like short stories or vintage automobiles, require polishing to look their best—and much of that polishing is cutting out extraneous or confusing details and refining the game design to a sleek final version. Remember the adage, "Less is more."

A Beginner's Guide to Logo

Logo is not just for kids.

Harold Abelson
Laboratory for Computer Science
MIT NE43-805
Cambridge, MA 02139

In the 1960s, computers were very expensive and didn't have much memory. A computer such as the IBM 1620 could store a maximum of 24K bytes (or 60,000 decimal digits). Even the largest research computers could manage only six times that much. Since programs had to use memory sparingly, computer languages were designed to reflect this concern.

Languages had to be simple for the computer, even at the expense of being cumbersome for the programmer. For example, to help the compiler keep track of memory, most programming languages insisted on a close tie between the *names* used in a program and the *storage cells* in the computer memory. As a consequence, the only kinds of data objects that could be directly named and manipulated by program operations were those that could be stored in a single cell. The only data structures available were those whose size could be prespecified at compile time. Most languages also required the program-

mer to include bookkeeping "declaration" statements, or adhere to other restrictions on the use of names, to make it easy for the compiler to determine what kind of storage each variable required. (For example, some languages required names beginning with I or J to refer to integers, arrays had to be declared together with their size, and defined functions had to have a name beginning with FN, followed by a digit.)

The concern for conserving memory permeated not only the language, but the computer system as a whole. For instance, if the system included a program editor, editing a line of code required the programmer to abort the program, load the editor, read a file, perform the edit, write a new file, exit the editor, recompile the edited code, and reload the program. All this because the editor and the language could not fit into main memory at the same time.

The languages of the 1960s flourished with the personal computers of the 1970s, which, although no longer very expensive, still did not have much memory. As personal computers became more popular, people began to confuse the idea that a language that is simple for a computer would also be simple for people. ("BASIC has only a few primitives; therefore, it must be easy to learn.") Some people even rationalized that the cumbersome features of

such languages were actually advantages. ("Having to declare the data types of variables makes you organize your programs better." "If it's too easy to edit programs, you won't write them carefully in the first place.") And when educators explored the potential uses of computers, they often accepted the drawbacks of these languages as an integral part of programming.

Over the past 12 years, the Logo Group at MIT under the direction of Seymour Papert, along with colleagues at a few universities and research centers around the world, has taken a different approach to educational computing. Rather than accept the limitations of affordable computers (by the standards of those days), we worked with the largest research computers available. The system we used, called Logo, is essentially a dialect of LISP, a powerful language developed for research in artificial intelligence, and used a great deal of memory compared to standards of the 1960s. (Some of the important linguistic aspects of Logo are discussed in "Why Logo?" by Brian Harvey in this issue on page 163. For a more general perspective on LISP, see "An Overview of Lisp" by John Allen in the August 1979 BYTE, page 10.)

In working with Logo, we've discovered some important things. A computer language can be both sim-

About the Author

Harold Abelson, a professor of Computer Science and Education at the Massachusetts Institute of Technology, is also the author of Logo for the Apple II and Apple Logo, introductions to the Logo programming language, published by BYTE/McGraw-Hill Books.

DAYSTAR at the center of your SYSTEM

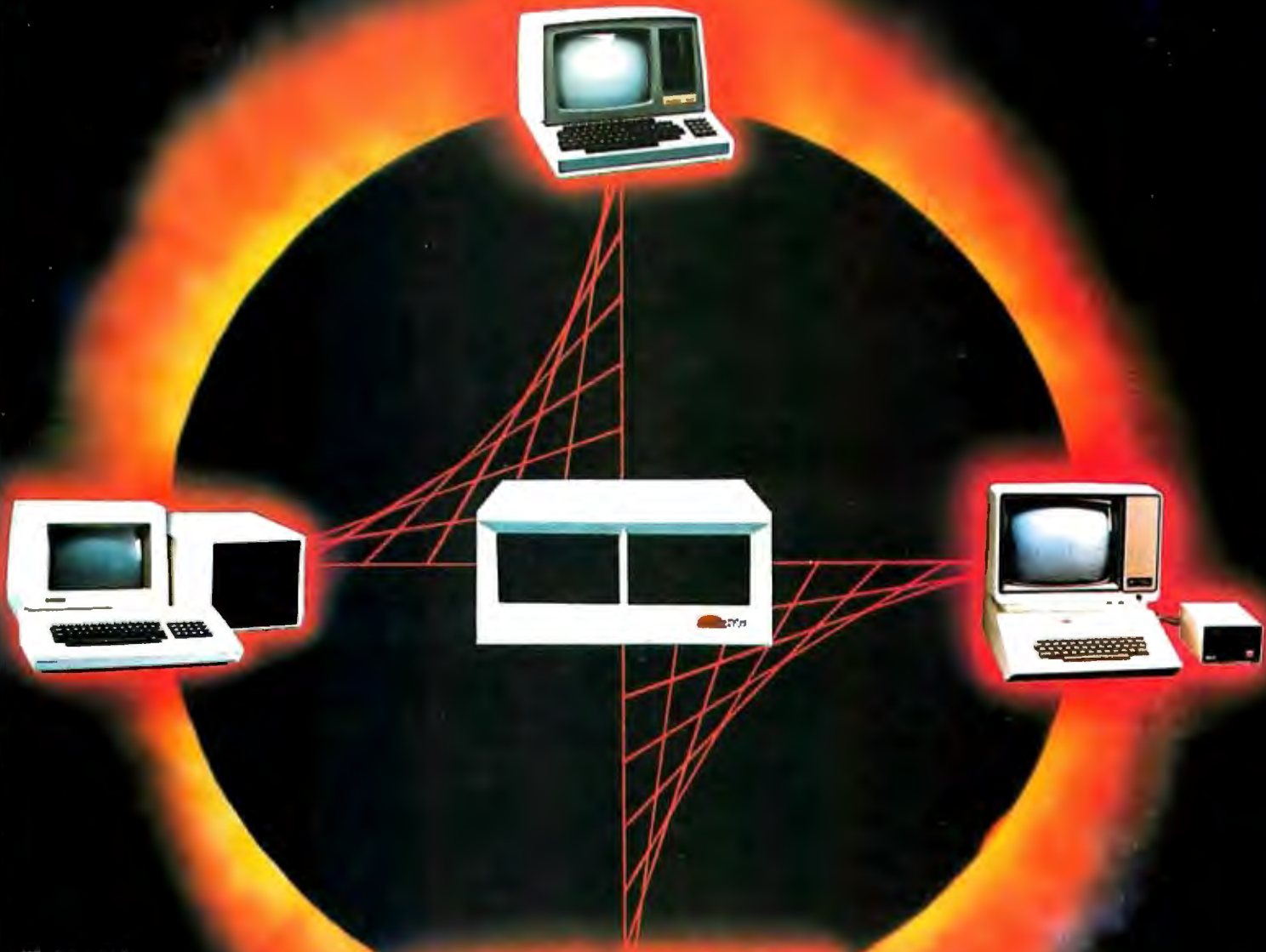

Whatever system you're using Apple™, Xerox™, TRS-80™, or Heath/Zenith™, Daystar should be at the center. Increased speed and increased data capacity adds versatility to your system that saves you time and money.

Through the use of an intelligent controller using I/O Ports and on-board data buffer feature, your microcomputer can perform up to 9 times faster. Daystar increases the data capacity of your system, with 6.4 megs or 12.8 megs of unformatted storage and each controller will handle up to 4 drives. A 1 megabyte floppy back-up is also available. This increased capacity allows your system to expand as your needs change.

Daystar, the perfect center for your system, at an affordable price.

This subsystem is available with interfaces for:

Xerox®, NEC 8000®, Apple II®, Commodore®, VIC 20®, TRS-80 Model II®, Heath/Zenith 89™, S-100, and soon Apple III®, TRS-80 III®.

asap
computer
products, inc.

1198 E. Willow St.
Signal Hill, CA 90806
(800) 421-7701 • (213) 595-6431 • (714) 891-2663

ASAP COMPUTER PRODUCTS LTD.

116 Viceroy Road, D-12 Concord, Toronto, Ontario
L4K1A9 Canada (416) 738-0500 (800) 268-1996

DAYSTAR
TECHNOLOGY INC.
A MICROBITE COMPANY

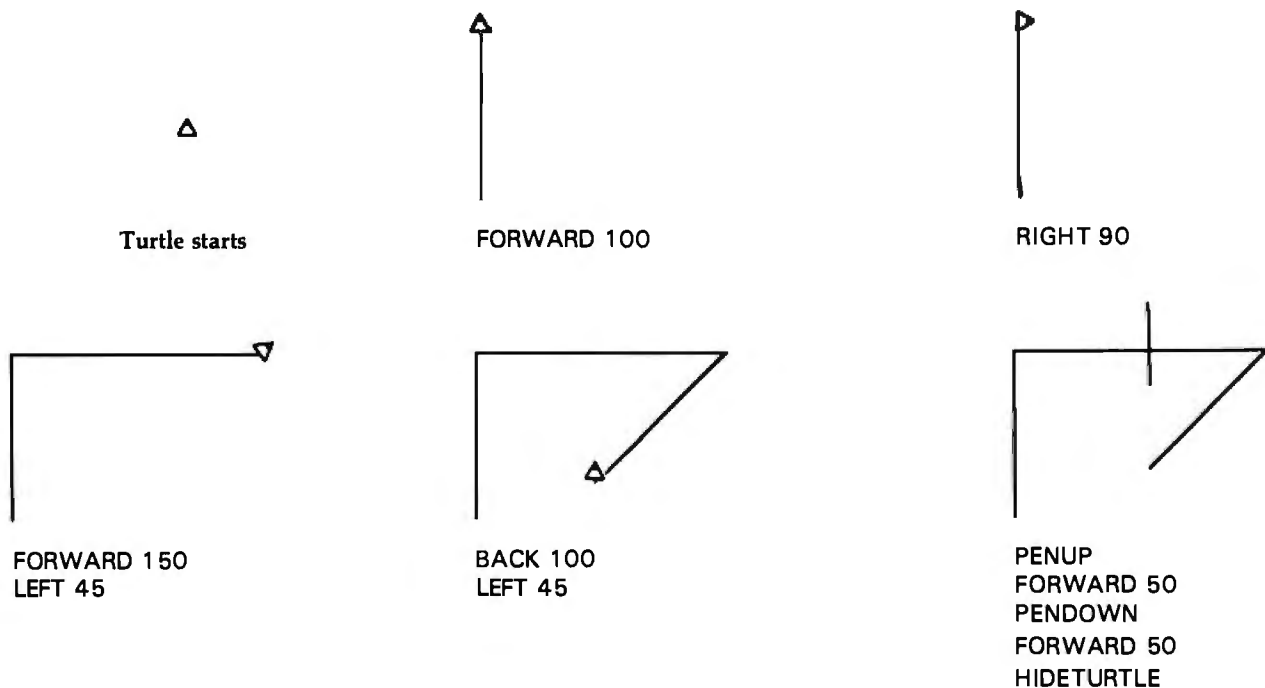

Figure 1: Moving the turtle with a simple sequence of Logo commands. FORWARD moves the turtle in the direction it is facing. RIGHT and LEFT rotate the turtle. PENUP and PENDOWN raise and lower the pen—the turtle leaves a trace when it moves with the pen down.

ple and powerful at the same time. In fact, these two aspects are complementary rather than conflicting because it is the very lack of expressive power in primitive languages such as BASIC that makes it difficult for beginners to write simple programs that do interesting things. More important, we've found that it is possible to give people control over powerful computational resources, which they can use as tools in learning, playing, and exploring. This has often required us to go beyond ordinary considerations of computer-language design to create compelling images of how computation can provide a perspective for reformulating traditional ideas from science and mathematics to make them more accessible, more in tune with intuitive modes of thought. In our research at MIT, working with preschool, elementary, junior high, high school, college students, and with their teachers, we've used Logo to introduce programming and the computational perspective at all levels. In this article, I'd like to show you what it's like to program using Logo, a simple but powerful system, enabling you to explore with a computer.

Drawing with the Turtle

Let's begin with a look at some *turtle graphics*. The turtle is a small triangular pointer on the screen that responds to a few simple commands. FORWARD moves the turtle in the direction it is facing a given number of units. If you type the Logo command FORWARD 50, the turtle will respond by moving forward 50 turtle steps (about 1/4 the height of the screen). RIGHT rotates the turtle clockwise a given number of degrees. BACK and LEFT cause the movements opposite to FORWARD and RIGHT. The turtle also carries a pen, which leaves a trace of its path on the screen as it moves while the pen is down. The commands PENUP and PENDOWN make the turtle raise and lower the pen. Figure 1 shows the result of a simple sequence of Logo commands.

It's lots of fun to make drawings by using these commands (together with a few others, such as CLEARSCREEN, which erases the screen). But in order to really make progress, you have to teach the computer some new words. For instance, you can teach the computer that the turtle can draw a square by repeating this sequence

four times: go FORWARD 50 steps, turn RIGHT 90 degrees. The Logo commands would be:

```
TO SQUARE
REPEAT 4 [FORWARD 50 RIGHT 90]
END
```

SQUARE is an example of a Logo *procedure*. The first line (signaled by TO) specifies the name of the procedure. This procedure happens to be called SQUARE (since that's what it draws), but you could have called it anything. The rest of the procedure (the procedure's *body*) specifies the list of instructions to be carried out in response to the command SQUARE; the word END indicates the end of the definition.

Once defined in this way, SQUARE becomes part of the computer's vocabulary. Whenever you give the command SQUARE, the turtle will draw a square.

Procedures with Inputs

An important difference exists between SQUARE and FORWARD. SQUARE always draws a square 50 steps on a side. But FORWARD is more versatile; it takes an *input* that determines how far the turtle should

64K STATIC RAM MEMORY.



S-100 STATIC MEMORY BREAKTHROUGH

Finally, you can buy state-of-the-art S-100/IEEE 696 static memory for your computer at an unprecedented savings.

Memory Merchant's memory boards provide the advanced features, quality and reliability you need for the kind of operational performance demanded by new high-speed processors.

Completely Assembled.

These memory boards are not kits, nor skeletons — but top-quality, high-performance memories that are shipped to you completely assembled, burned-in, socketed, tested and insured with one of the industry's best warranties.

Superior Design & Quality.

Memory Merchant's boards are created by a designer, well known for his proven ability in advanced, cost-efficient memory design. Innovative circuitry provides you with highly desired features and incredible versatility.

Only first-quality components are used throughout, and each board is rigorously tested to assure perfect and dependable performance.

No Risk Trial.

We are so convinced that you will be absolutely delighted with our boards that we extend a no-risk trial offer. After purchasing one of our boards, you may return it (intact) for any reason within 15 days after shipment and we will refund the purchase price (less shipping).

NEW S-100 PRODUCTS COMING SOON:

- * DUAL 8/16 BIT CPU BOARD
- * 128K 8/16 BIT STATIC RAM
- * 256K 8/16 BIT DYNAMIC RAM

\$629.

48K PARTIALLY POPULATED \$519.
32K PARTIALLY POPULATED \$409.

64K RAM, MODEL MM65K16S

- 64K x 8-bit
- Speed in excess of 6 MHz
- Uses 150ns 16K (2K x 8) static RAMS
- Ultra-low power (435 Ma. max. — loaded with 64K)
- Bank Select **and** Extended Addressing
- A 2K window which can be placed anywhere in the 64K memory map
- Four independently addressable 16K blocks organized as:
 - Two independent 32K banks **or**
 - One 64K Extended Address Page **or**
 - One 48K and one 16K bank for use in MP/M¹ (option)
- Each 32K bank responds independently to phantom
- 2716 (5V) EPROMS may replace any or all of the RAM
- Field-proven operation in CROMEMCO CROMIX* and CDOS*.
- Compatible with latest IEEE 696 systems such as Northstar, CompuPro, Morrow, IMS, IMSAI front panel, Altair and many others.

OEM and DEALER inquiries invited.

**14666 Doolittle Drive
 San Leandro, CA 94577
 (415) 483-1008**

Circle 253 on Inquiry card.

FULL TWO-YEAR WARRANTY.

The reliability of our boards, through quality-controlled production and proven performance, has enabled us to extend our warranty to a full two years. That's standard with us, not an option. This includes a 6-month exchange program for defective units.

Shipped direct from stock.

All Memory Merchant's boards are shipped direct from stock, normally within 48 hours of receipt of your order. Call us at (415) 483-1008 and we may be able to ship the same day.

16K RAM, Model MM16K14



16K STATIC RAM \$169.

16K x 8 Bit
 Bank Select & Extended Addressing
 Four independently addressable 4K blocks
 One 4K segment equipped with 1K windows
 Uses field-proven 2114 (1K x 4) RAMS
 Low Power (less than 1.2 Amps)
 Runs on any S-100 8080, 4 MHz Z-80 or 5 MHz 8085 system.

Prices, terms, specifications subject to change without notice.

*Cromix and CDOS are trademarks of CROMEMCO.
¹ MP/M is a trademark of Digital Research

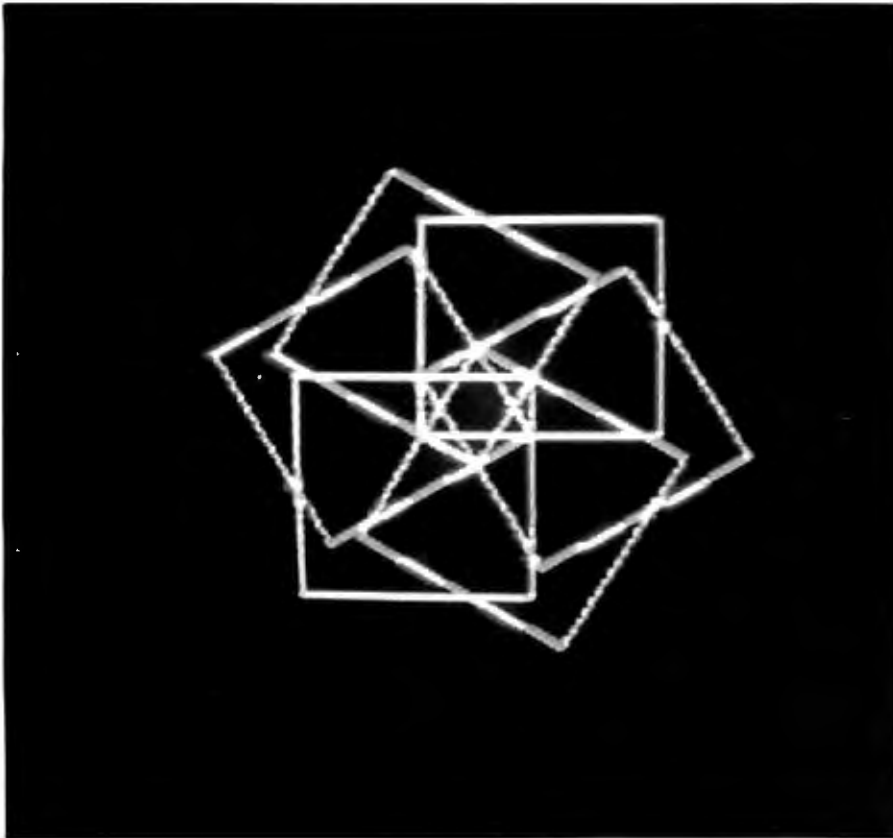

Photo 1: A design created by a simple one-line Logo program that makes the turtle repeat these steps six times: go FORWARD 20 units, turn RIGHT 60 degrees, and draw a square of size 75 units.

move. You can change the SQUARE procedure so that it also takes an input that determines the size of the square to be drawn. For example:

```
TO SQUARE :SIZE
REPEAT 4 [FORWARD :SIZE RIGHT 90]
END
```

You use SQUARE just as you would any Logo command that takes an input. That is, to draw a square with 100-step sides, you type:

```
SQUARE 100
```

To draw a square with 50-step sides, you type:

```
SQUARE 50
```

The definition of SQUARE illustrates the general rule for defining procedures that take inputs. You choose a name for the input and include it in the procedure title line preceded by a colon. Then you use the input name (with the colon) in the procedure

body wherever you would normally use the value of the input.

Since a procedure, once defined, becomes just another word the computer "knows," you can use procedures as parts of the definitions of other procedures. Here's a procedure that produces a design by repeatedly going forward, turning, and drawing a square (see photo 1):

```
TO DESIGN
REPEAT 6 [FORWARD 20
RIGHT 60 SQUARE 75]
END
```

Simple Recursive Procedures

This next procedure also draws a square of a specified size:

```
TO SQ :SIZE
FORWARD :SIZE
RIGHT 90
SQ :SIZE
END
```

Although SQ and SQUARE both draw squares, they behave very differently.

Instead of drawing a square and then stopping, SQ makes the turtle retrace the same path over and over, or until you tell the computer to stop. Here is why this happens. When you give the command:

```
SQ 100
```

the turtle must go FORWARD 100, RIGHT 90, and then do SQ 100 again, and so on, and so on.

Add a second input to SQ and you obtain a procedure called POLY, which repeats over and over the sequence: go FORWARD some fixed distance, and turn RIGHT some fixed angle. The procedure takes as inputs the size of each FORWARD step and the amount of each turn:

```
TO POLY :SIZE :ANGLE
FORWARD :SIZE
RIGHT :ANGLE
POLY :SIZE :ANGLE
END
```

To use the POLY procedure, type the word POLY, followed by specific values for the inputs:

```
POLY 60 144
```

Figure 2 shows some of the many different shapes obtained by calling POLY with various inputs.

Recursion is the programming word to describe the ability to use a procedure as part of its own definition. SQ and POLY are recursive procedures of a very simple form—they merely repeat an unchangeable cycle over and over. But recursion is a much more powerful idea and can be used to obtain much more complicated effects. To take just a small step beyond the purely repetitive kind of recursion, consider:

```
TO POLYSPI :SIZE :ANGLE
FORWARD :SIZE
RIGHT :ANGLE
POLYSPI :SIZE + 3 :ANGLE
END
```

Giving the command

```
POLYSPI 1 120
```

leads to this sequence of turtle moves:



R. DAVIDSON

Boldly Go Where No Drive Has Taken You Before...

Give your APPLE II® a Fourth Dimension — the totally compatible 5¼" drive that takes your system farther, faster. With read/write electronics so advanced that reading errors are virtually eliminated. With a track zero microswitch that keeps boot and track access smooth and quiet. With the ability to read half-track software and up to 143,360 bytes on DOS 3.3®. With similar performance on DOS 3.2.1®, Pascal® or CP/M® operating systems. And, the disk enclosure mates perfectly with APPLE cabinetry.

EXTENDED WARRANTY — We offer a 12 month parts and labor warranty extension at no cost to you.

IMMEDIATE DELIVERY — Immediately available in quantity. We offer same-day shipment if your order is received by noon (PST).

\$30 FACTORY REBATE — Receive a \$30 factory rebate if the warranty card is received by us on or before August 31, 1982. See participating dealer, or call direct. Suggested Retail Price: \$419.00.

TAKE YOUR APPLE TO THE LIMIT WITH A FOURTH DIMENSION DRIVE. Ask for additional information. Dealer inquiries invited. Contact: Fourth Dimension Systems 3100 W. Warner Avenue, #7/Dept. B Santa Ana, CA 92704 (714) 850-1228

**FOURTH
DIMENSION SYSTEMS**

Mastercard and Visa accepted.

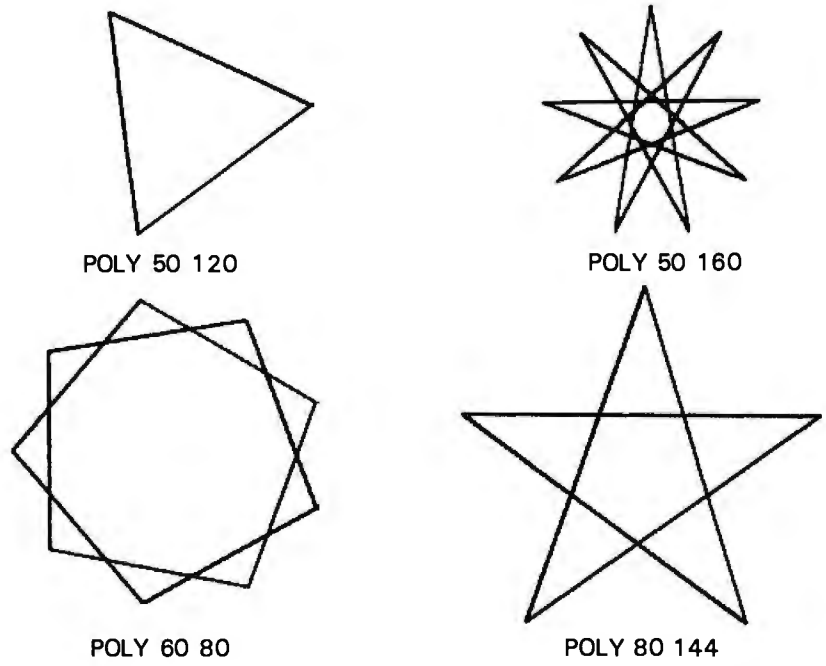

Figure 2: These shapes are all drawn by the three-line Logo program POLY, which has the turtle go FORWARD some fixed amount, turn RIGHT some fixed angle, and repeat this over and over. The figures drawn by POLY always close, but the number of sides that must be drawn before the figure closes depends upon the ANGLE input to the procedure.

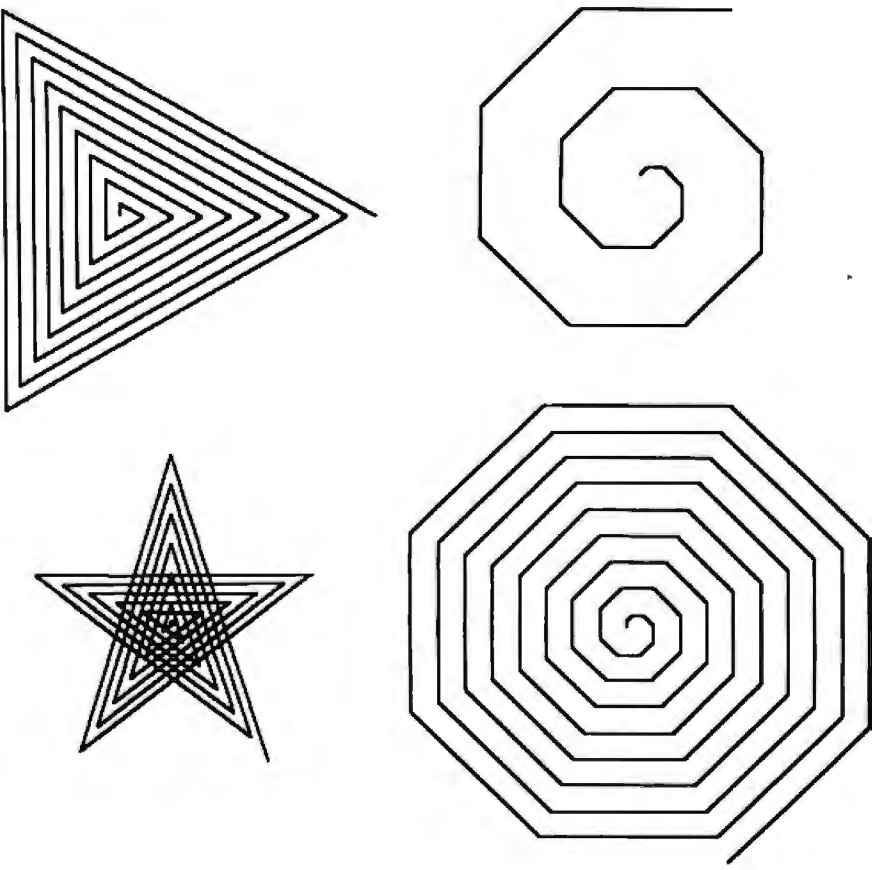

Figure 3: Figures created using POLYSPI. A variant of POLY (see figure 2), the program takes advantage of recursion to increase the turtle's FORWARD step each time the procedure calls itself. The result is a polygonal spiral. As with POLY, varying the ANGLE input changes the symmetry of the pattern.

```
FORWARD 1
RIGHT 120
FORWARD 4
RIGHT 120
FORWARD 7
RIGHT 120
FORWARD 10
RIGHT 120
...
```

which produces a triangular spiral in which each of the sides is three steps larger than the previous side. Figure 3 shows some of the shapes generated by the POLYSPI procedure. As a variant, you can replace the FORWARD step in POLYSPI by a command that draws a square:

```
TO SPINSQUARE :SIZE :ANGLE
  SQUARE :SIZE
  RIGHT :ANGLE
  SPINSQUARE :SIZE + 3 :ANGLE
END
```

The result of running

```
SPINSQUARE 1 10
```

as shown in figure 4 is a sequence of squares of increasing size starting with a square of one-step size. Each square is three units larger than the previous one and rotated from it by 10 degrees. The procedure keeps running and the squares keep growing until you tell Logo to stop. You can also modify the procedure so that it stops when the squares become larger than a certain size (e.g., 100 steps) by including a stop rule:

```
TO SPINSQUARE :SIZE :ANGLE
  IF :SIZE > 100 THEN STOP
  SQUARE :SIZE
  RIGHT :ANGLE
  SPINSQUARE :SIZE + 3 :ANGLE
END
```

Part of the power of recursion is the fact that such simple programs can lead to such varied results.

An Environment for Exploring

As you can see from the examples presented so far, it is very easy to get started programming with turtle graphics. This is partly because of the subject matter of turtle graphics. The basic commands have simple, visible effects. At the same time, turtle graphics is an incredibly rich area for

Practical Basic Programs IBM PC Edition

by Lon Poole
 Adapted to the IBM Personal Computer by David Wilson
 There are 40 fully-documented, ready-to-run programs for the IBM Personal Computer. You can get started now with no previous programming knowledge. You can income average, figure accrued interest on bonds, reconcile checking accounts, perform home budgeting, figure continuous interest compounding, and other financial tasks. With these simply written programs you'll solve your most difficult home and office problems at a cost of less than 10 cents a program.
 #0-931988-80-2 \$15.99

Microcomputer Design Guide

Robbins
 "How-to" oriented book on the principles and concepts of microprocessors doubles as a practical guide to microcomputer design as a whole. Using the 6809 as a model, Robbins guides the reader step by step through an overview of the microprocessor method.
 #7-19-85 \$19.95

CP/M® User Guide

2nd Edition
 Hogan
 This new revision includes expanded sections on CP/M® 86 and CP/M® 80 and on CP/M as related to assembly language programming. There are discussions on MP/M™ and CP/NET operating environments along with proper perspectives in terms of their uses.

The basics you need to get started plus advanced material on program modification and development—this is *the* book on CP/M.
 #82-9 \$12.99

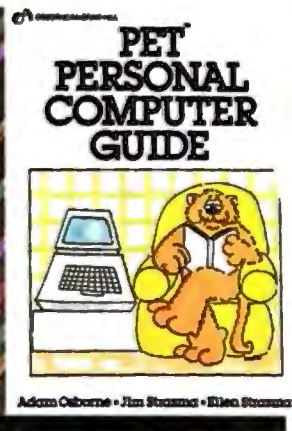
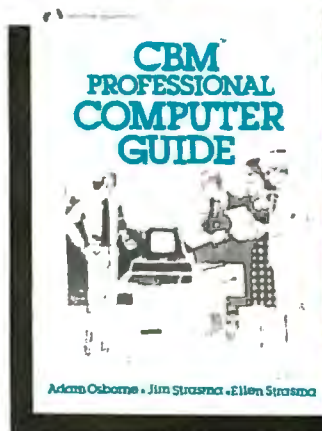

Microcomputer User Guides THE OSBORNE SUMMER LINEUP

The HP-IL System: An Introductory Guide to the Hewlett-Packard Interface Loop

by Gerry Kane, Steve Harper, David Ushijima
 This is the definitive guide to the new Hewlett-Packard Interface Loop. The Loop is a bit-serial interface that links the HP-41C or the HP Series 80 personal computers to a new generation of compact peripherals.

The book provides in-depth instructions on how to interface both HP-IL and non-HP-IL devices to the Loop. Summaries of all HP-IL remote messages and message sequences are also included.
 #77-2 \$16.99

PET®/CBM™ and the IEEE 488 Bus (GPIB) 2nd Edition

Eugene Fisher—C. W. Jensen
 The only book on the market devoted exclusively to the GPIB has been revised and expanded. New chapters include information on Bus controlled applications in closed-circuit television and in linear-control-circuit problems. The appendixes which first edition reviewers hailed as a gold mine of information on bus-compatible instruments and their manufacturers, have been thoroughly updated.
 #78-0 \$15.99

PET® Personal Computer Guide CBM™ Professional Computer Guide

Adam Osborne with Jim and Ellen Strasma
 We've made the best-selling *PET/CBM Personal Computer Guide* into two separate volumes, totally revising the material to bring you the most up-to-date step-by-step user guides available on these ever-popular machines.
 PET® Guide—#76-4 \$15.00



Osborne/McGraw-Hill

How to Order: Call Toll Free 800-227-2895
 CA dealers: 800-772-4077 Telex: 910-366-7277
 Mail Orders: 630 Bancroft Way, Berkeley, CA 94710

Circle 312 on Inquiry card.



MICROMAIL'S GOT IT!!

LETTER QUALITY PRINTERS

★ DIABLO ★

• 630 RO
• 40 CPS
• SERIAL RS232C
\$1899.00
630 KSR CALL

• 630 API-RO
"INTRODUCTORY OFFER"
\$1649.00
"TAILORED TO YOUR SYSTEM"

• 620 RO
"INTRODUCTORY OFFER"
\$1149.00
• 25 CPS
• SERIAL RS232C

NEC

- 7700 SERIES
- 3500 SERIES

Call for Our **LOW PRICES**

QUME

"ON SITE WARRANTY"

- SPRINT 9/45
- SPRINT 9/55

Call for Our **LOW PRICES**

DEC

LA 34 DA.....\$899.00
"LA 120 REPLACEMENT"
LA 12D NEW!\$1599.00
VT100.....\$1399.00
VT101..... CALL
VT131.....\$1499.00

TELEVIDEO

910\$569.00
912\$689.00
920.....\$725.00
950.....\$909.00
925.....NEW!.....CALL

DEC LA 100
• DUAL MODE
MATRIX PRINTER

★ NEW ★

3M
WHISPER WRITER
• TWX • TIME SHARE
• COMPUTER TERMINAL

ANADIX

DP 9500/9501 \$1125.00
DP 8000AP.....\$749.00
DP 9620A NEW!
6000..... NEW!..... CALL

TEXAS INSTRUMENTS

810/2\$1299.00
(Includes upper/lower case option)
810/2 VFC/CP.....\$1499.00
(Includes u/l case, fonts control & compressed print)

"PORTABLES SPECIAL"

T.I. 745\$1399.00
T.I. 743KSR.....\$849.00
TELETYPE 43 (TTL)\$999.00

VT100 / TELEVIDEO
GRAPHICS OPTION
AS LOW AS
\$999.00

CALL TOLL FREE (800) 854-6028

SAVE ON
PREPAID
ORDERS

MASTERCARD
VISA
ACCEPTED

C.O.D.
REQUIRES
15% DEPOSIT

SHIPPING IS
FREIGHT
COLLECT

WE SELL INTERNATIONALLY

MICROMAIL

P.O. Box 3297
Santa Ana, CA 92703
Phone: 714/731-4338
TWX: 910 595 1146

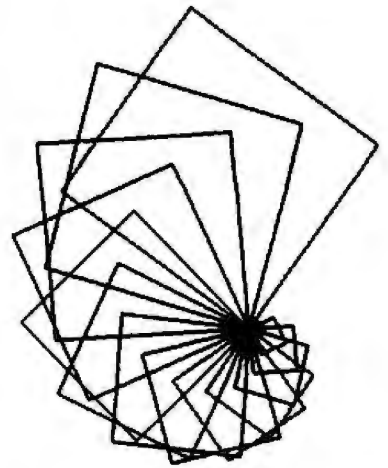

Figure 4: SPINSQUARE is a simple recursive program that draws a square of a given size, rotates it, increases the size, and continues the process.

exploration in which even simple programs can have unexpected, often beautiful results. The small amount of Logo we've seen so far is enough to support weeks of activities in programming and mathematics, exploring such questions as "How does the shape of a POLY figure depend on the angle input?" or "Why do so many repeated programs produce symmetric designs?" or simply creating beautiful patterns. Andrea diSessa and I describe some of the mathematics that arises from investigating this computer-based approach to geometry in the book *Turtle Geometry: The Computer as a Medium for Exploring Mathematics* (Cambridge, MA: MIT Press, 1981).

In addition to the subject matter, the *system interaction* also plays a crucial role. When people explore using Logo, they are continually defining new procedures and modifying old ones. A typical compiler-oriented system, in which changing a definition requires switching back and forth among separate editors, compilers, and linking loaders, is inappropriate for this kind of activity. Much of the effort in implementing Logo has gone into providing a programming environment that makes it easy to define and modify procedures. The Texas Instruments and Apple implementations of Logo include integrated screen editors. Giv-

Imitation is the sincerest form of flattery.

We're flattered.

When we announced the first dual processor in early 1980, we knew we were on to something. Now over two years later, **CPU 8085/88** is still the leading dual processor.

One processor runs 8 bit software, while the other processor runs 16 bit software.

Users love it because they can run existing libraries of 8 bit programs...or run the new generation of ultra-efficient 16 bit programs without a hardware change.

Software companies love it because they can use 8 bit techniques to debug the new 16 bit programs they're working on.

Now it seems everybody has a dual processor in the works. Like we said, we're flattered: But **CompuPro's** track record of technological leadership is not easily imitated. And while they're still figuring out how to successfully implement dual processing ...

We've joined the 8 bit and 16 bit worlds with **MP/M 8-16***, a multi-user operating system which runs 8 and 16 bit software - simultaneously - in a multi-user environment. Let one station run a 16 bit spreadsheet...another an 8 bit word processor...while other terminals execute their own 8 or 16 bit programs. Only **CompuPro's** dual processing delivers these kind of results.

* MP/M 8-16 is CompuPro's proprietary edition of Digital Research's multi-user MP/M-88 (V 2.X) operating system. MP/M is a trademark of, and is used under license from Digital Research.

When it comes to dual processing, we wrote the book. But if you thought we were going to stop there - well, you know **CompuPro** better than that.

For business, industrial, and scientific computing - 8 or 16 bit, 8 and 16 bit, single or multi-user - see your authorized **CompuPro Systems Center**.

CompuPro
SYSTEMS

CompuPro division, Godbout Electronics, Oakland Airport, CA 94614-0355.

CP/M OWNERS!

MENU PROGRAMMING LANGUAGE

MPL
ONLY \$175

A revolutionary software package that simplifies programming while increasing the versatility of personal computers.

- Runs on CP/M.
- Can be used without any special training in computer programming.
- Displays data menu-style.
- Organizes data by connecting menus together.
- Utilizes menus to drive program operation automatically.

HARD DISK BACKUP

THE BACKFIELD
ONLY \$150

A software package that backs up hard disks to floppies without special hardware.

- Runs on CP/M.
- Backs up hard disks to floppies and other disks.
- Can back up all files or selected files.
- Backs up only those sections of the disk that are in use.
- Automatically selects files that have changed since last backup.

AVAILABLE NOW!
(408) 395-0838
OR SEND CHECK TO:

Audio Light, Inc.

146 Town Terrace, Suite 4
Los Gatos, CA 95030

MPL Requires a 24 X 80 CRT.
All software is supplied on 8" single density diskette for CP/M 2.2.

*California residents add 6% for sales tax.

Dealer/OEM Inquiries Welcome

MPL is a trademark of Audio Light Inc.
CP/M is a trademark of Digital Research



ing the command TO or EDIT activates the screen editor, with the appropriate procedure definition ready to be modified. A single keystroke installs the new definition as a Logo procedure.

The success of turtle geometry is due in large part to the fact that in designing it we did not view ourselves solely as mathematicians and educators attempting to invent a new approach to geometry, nor as computer scientists attempting to implement a system. Instead, we tried to take both perspectives, continually tailoring the computer system to fit the mathematics, and vice versa.

Outputs

We've already seen how to define procedures that require inputs. You can also make a procedure output a value. For instance, the following procedure takes two numbers as inputs and outputs their average:

```
TO AVERAGE :X :Y
  OUTPUT (:X + :Y) / 2
END
```

The result returned by AVERAGE can be examined directly (using PRINT) or used in turn as an input for other operations:

```
PRINT (AVERAGE 2 3)
2.5
PRINT (AVERAGE 1 2) + (AVERAGE 3 4)
5.0
PRINT (AVERAGE (AVERAGE 1 2) 3)
2.25
```

Note the Logo convention of using parentheses to group a procedure with its inputs. Although parentheses are almost always *optional* in simple Logo lines, it is a good idea to include them because they make the lines easier to read.

Programming with Procedures

A Logo program is typically structured as a cluster of procedures. These procedures pass information among themselves by means of inputs and outputs. The advantage of this kind of organization is that it separates the program into manageable pieces, as each procedure can be simple in itself. Even in a complex program, it is unusual to have an in-

dividual procedure that is more than a few lines long. In addition, the integrated Logo editor and the general interactive nature of the Logo system enable you to define and test individual procedures separately.

To illustrate procedural organization, let's design a simple game that's played as follows. The computer chooses at random a "mystery point" on the screen, and asks the player to make successive LEFT and FORWARD moves with the turtle. Before each move, the computer prints the turtle's distance from the mystery point. The goal is to get the turtle very close to the point in as few moves as possible. Here's a transcript of the game in action. The computer's responses are printed in italics to distinguish them from what the player types:

```
DISTANCE TO POINT IS 67.6
TURN LEFT HOW MUCH?
0
GO FORWARD HOW MUCH?
25
DISTANCE TO POINT IS 90.25
TURN LEFT HOW MUCH?
180
GO FORWARD HOW MUCH?
50
DISTANCE TO POINT IS 47.38
.
.
.
```

And finally:

```
DISTANCE TO POINT IS 12.08
YOU WON IN 11 MOVES!
```

The heart of the program is a procedure called PLAY. This takes as input a number M, which indicates the number of moves so far. PLAY first checks to see if the player has won. If so, it prints a message saying how many moves have occurred, and stops. Otherwise, it asks the player to make a move, and goes on to the next round, with M increased by 1:

```
TO PLAY :M
  TEST CHECKWIN?
  IFTRUE (PRINT [YOU WON IN]
    :M [MOVES!])
  IFTRUE STOP
  MAKEMOVE
  PLAY :M + 1
END
```

The PLAY procedure is simple in itself



YOU PICK THE COMPUTER, MICROPRO™ MAKES IT PERFORM.

There are a lot of fine names in microcomputers. But there's only one name in software to remember. MicroPro. Because MicroPro has taken the best ideas in business software and put them together to make the MicroPro Software System™—a family of software products that work together on more than 100 of the most popular brands of microcomputers, probably including yours.*

Software makes the difference.

The key to getting the most out of your computer is the software you use. And the Software System is designed to get the most out, faster. The Software System is our new name for the MicroPro family of software products, each remarkably powerful and versatile—and even more so when you combine them.

The products: WordStar® (word processing), MailMerge™ (WordStar option—personalized form letters and other file-merging uses); SpellStar™ (WordStar option—spelling checker); DataStar™ (data entry and retrieval); CalcStar™ (electronic spread sheet and financial modeling); SuperSort™ (sorting, selecting, and merging); and WordMaster® (video text editing).

More solutions, less work.

The Software System enables you to use your microcomputer to its fullest with less time and effort. That's because, for one thing, most MicroPro products have similar methods of operation, so it's easier to move from one product to another. And they readily adapt to your way of doing business, instead of forcing you to make changes to fit a rigid software package, like you have to do with many other software products. Most important, you can combine MicroPro products' information and abilities. The result: a lot more ways to make your

business more productive than you'd get from just using each product by itself.

The System doesn't stop.

Count on MicroPro to keep expanding the Software System with new products that make it even more useful and powerful in your business. Coming this year: a series of in-depth accounting packages; InfoStar™, a powerful report generator and partner to DataStar; and StarBurst™, a new kind of software that will link our products together into an even friendlier and easier to use package.

If you're shopping for a computer, we recommend you shop for software even more carefully. After all, there are a lot of good hardware systems to choose from. But there's only one Software System. From MicroPro.

To get our brochure on the MicroPro Software System, visit any of our 1200 dealers around the world.

Or phone toll-free 800-227-2400, ext. 933
(In California 800-772-2666, ext. 933.)



*Ask your MicroPro dealer to let you know which microcomputers can use MicroPro software. For the IBM® Personal Computer, WordStar and MailMerge are now available—other products coming. MicroPro Apple™ software requires a CP/M®-Z-80™ adaptation device. IBM is a registered trademark of International Business Machines Corp. Apple is a trademark of Apple Computer Inc. CP/M is a registered trademark of Digital Research, Inc. Z-80 is a registered trademark of Zilog, Inc. © 1982 MicroPro International Corp.

because it delegates the problems of testing for wins and making moves to the procedures CHECKWIN? and MAKEMOVE.

Here's MAKEMOVE, which prompts the user for angles and distances, and moves the turtle correspondingly. It uses a subprocedure READNUMBER, which returns a number typed in at the keyboard:

```
TO MAKEMOVE
PRINT [TURN LEFT HOW MUCH?]
LEFT READNUMBER
PRINT [GO FORWARD HOW MUCH?]
FORWARD READNUMBER
END
```

To check for a win, the program must test whether the turtle's position is close to some predetermined point (e.g., 20 steps). The Logo primitive operations XCOR and YCOR return the turtle's *x* and *y* coordinates. We'll suppose that the *x* and *y* coordinates of the hidden point are given by variables XPT and YPT. If you assume there is a procedure DISTANCE that returns the distance between two

points, the CHECKWIN? procedure can be written as follows:

```
TO CHECKWIN?
MAKE "D DISTANCE XCOR YCOR
: XPT :YPT
(PRINT [DISTANCE TO POINT IS]
:D)
IF :D < 20 OUTPUT "TRUE
OUTPUT "FALSE
END
```

CHECKWIN? returns as its value either TRUE or FALSE, which is the result that is tested by PLAY to determine whether the game is over. Observe also the use of the MAKE statement to assign values to variables. In this case, D is used to designate the distance.

Here is the procedure for computing the distance between two points, as the square root of the sum of the squares of the coordinate differences:

```
TO DISTANCE :A :B :X :Y
MAKE "DX :A - :X
MAKE "DY :B - :Y
OUTPUT SQRT (:DX *:DX + :DY *:DY)
END
```

Now you need a procedure to start the game:

```
TO GAME
CLEARSCREEN
MAKE "XPT RANDOMCOORD
MAKE "YPT RANDOMCOORD
PLAY 0
END
```

This clears the screen, assigns values (chosen at random) to the mystery-point coordinates XPT and YPT, and calls PLAY with an initial M equal to zero.

The following procedure, used to select random coordinates, returns a random number between -75 and +75. It works by calling the Logo primitive RANDOM to obtain a random number between 0 and 150, and subtracts 75 from the result:

```
TO RANDOMCOORD
OUTPUT (RANDOM 150) - 75
END
```

The only thing needed to complete the program is READNUMBER, which returns a number input from the keyboard:

```
TO READNUMBER
OUTPUT FIRST REQUEST
END
```

READNUMBER uses the Logo primitive REQUEST, which waits for the user to type a line, and then returns a list of all the items in that line. The desired number is extracted as the first item of the input list. (We'll talk about lists below.)

Actually, it might be better to design READNUMBER so that it checks to see if the item to be returned is indeed a number, and to complain otherwise:

```
TO READNUMBER
MAKE "TYPEIN FIRST REQUEST
IF NUMBER? :TYPEIN OUTPUT
:TYPEIN
PRINT [PLEASE TYPE A NUMBER]
OUTPUT READNUMBER
END
```

Notice the final line of the procedure. Its effect is to make READNUMBER try again for an input until it gets a number, as many times as necessary.

THE MULTI-USER FRIENDLY MEMORY BOARD WITH

NO COMPROMISE

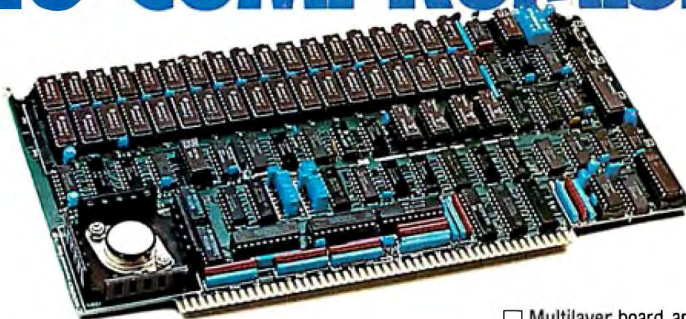

- 256 Kilobytes
- 6 MHz with no wait states—Most Processors
- Designed to operate in any S-100 System IEEE or Non-IEEE
- 16-bit addressing option: Powerful Macrotech Memory Mapping (M³) bank select architecture allows each 4K block of the 16 bit (64K) logical addresses to be dynamically translated to any 4K block of the 256K on board physical memory.
- 24-bit direct addressing option

- "Educated" cycle control module generates all timing on board *asynchronously* for maximum access speed and uniform operation
- Comprehensive technical manual with complete installation guide and source listings for MP/M II™* and "Virtual Disk" solid state disk applications.
- DMA operation fully supported in strict accordance with IEEE 696 standard.
- 8/16 data transfer protocol
- Parity error detection

- Multilayer board and bus signal filtering for noise-free operation.
- Full one year warranty

If you wish, send a check or money order for \$1,379 (In California add 6% sales tax where applicable). Manual available at \$25.00 each refundable with order.

*Registered Trademark of Digital Research Corp.
OEM & Dealer Inquiries Invited



MACROTECH International Corp.,
22133 Cohasset St., Canoga Park,
California 91303
(213) 887-5737



COMMODORE VIC-20®

“THE WONDER COMPUTER OF THE 1980s. UNDER \$300.”

—WILLIAM SHATNER



“The best computer value in the world today. The only computer you’ll need for years to come.”



VIC-20® VS. OTHER HOME COMPUTERS

Product Features	Commodore VIC-20	Atari® 400™	TI® 99/4A	TRS-80® Color Computer
Price*	\$299.95	\$399.00	\$454.00	\$399.00
Maximum RAM Memory	32K	16K	48K	32K
Keyboard Style	Full-Size Typewriter Style	Flat Plastic Membrane	Full-Size Typewriter Style	Calculator Style
Number of Keys	66	57	48	53
Programmable Function Keys	4	0	0	0
Graphic Symbols On Keyboard	62	0	0	0
Displayable Characters	512	256	192	256
Microprocessor	6502	6502	TMS9900	6809
Accessible Machine Language	YES	YES	YES	YES
Upper/Lower Case Characters	YES	YES	YES	NO
Operates with all Peripherals (Disk, Printer and Modem)	YES	NO	YES	YES
Full Screen Editor	YES	YES	YES	NO
Microsoft Basic	Standard	N/A	N/A	\$ 99.00
Telephone Modem	\$110.00	\$399.95	\$450.00	\$154.95

*Manufacturer's suggested retail price Mar. 1, 1982
 †For more information, see Commodore's Information Network on CompuServe.



Read the chart and see why COMPUTE! Magazine¹ calls the VIC-20 computer “an astounding machine for the price.” Why BYTE² raves: “...the VIC-20 computer unit is unexcelled as a low-cost consumer computer.” Why Popular Mechanics³ says “...for the price of around \$300, it’s the only game in town that is more than just a game.” And why ON COMPUTING INC.⁴ exclaims: “What is inside is an electronic marvel... if it sounds as if I’m in love with my new possession, I am.”

The wonder computer of the 1980s. The VIC-20 from Commodore, world’s leading manufacturer of a full range of desktop computers. See the VIC-20 at your local Commodore dealer and selected department stores.

1 April '81 issue 2 May '81 issue 3 November '81 issue 4 Fall '81 issue



Circle 82 on Inquiry card.

Commodore Consumer Products Division
 487 Devon Park Drive, Wayne, PA 19087
 Canadian Residents: Commodore Computer Systems
 3370 Pharmacy Ave., Agincourt, Ont., Canada, M1W 2K4

Please send me more information on the VIC-20.

Name _____
 Address _____
 City _____ State _____ Zip _____
 Phone _____

BY8



From Aspen Software

The Only Complete Document Proofreading System
For CP/M®, TRS-80® and IBM-PC Word Processors

PROOFREADER™

Featuring Random House® Dictionary

- Complete Accuracy-looks up every word; does not use less accurate root word analysis, plus Random House Dictionary

- + Full Interactive Correction-standard
- Instant Access to Dictionary
- Compact-Random House Dictionary supplied in sizes to fit your system (50,000 words standard)

GRAMMATIK™

Beyond Spelling Checking

- Detects typos, punctuation and capitalization errors, misused words and phrases
- Analyzes Writing Style
- Suggests Alternative Usages

= NO ERRORS

"The programs together (Proofreader and Grammatik) offer a dynamic tool for comprehensive editing beyond spelling corrections."

--Dona Z. Meilach in Interface Age, 5/82

"Grammatik is the perfect complement to a spelling check program."

--Dr. Alan R. Miller in Interface Age, 5/82

"If you use a word processor and a spelling checker, then you should investigate the unique capabilities of this program. Grammatik is a surprisingly fast and easy to use tool for analyzing writing style and punctuation."

--Bob Loudon in InfoWorld, 12/81

"For the user who is as tight with his dollar as I, Proofreader is the program of choice."

--Stephen Kimmel in Creative Computing, 3/82

"Anyone involved with word processing in any way, whether writing manuals, letters, brochures, newscopy, reports, etc. is encouraged to get the excellent program Grammatik."

--A.A. Wicks in Computronics, 6/82

Grammatik and Proofreader are compatible with all CP/M, MS-DOS (incl. IBM-PC), and TRS-80 word processors. Current CP/M formats: standard 8", Northstar, Omikron, Osborne, Apple. Please call/or write for details of minimum system sizes and availability of additional disk and operating system formats. Shipping costs included. Please specify your system configuration when ordering. Dealers inquiries invited.

	Proofreader	Grammatik	Both
CP/M, MS-DOS	\$129.00	\$150.00	\$250.00
TRS-80 Model II	n/a	\$99.00	
TRS-80 Mod. I/III	\$89.00	\$59.00	\$139.00

Random House is a registered trademark of Random House, Inc. Other registered trademarks: CP/M: Digital Research; TRS-80: Tandy Corp.; MS-DOS: Microsoft; IBM: IBM; Proofreader, Grammatik: Aspen Software Co.

Aspen Software Co.

P.O. Box 339-B Tijeras, NM 87059
(505) 281-1634



This makes the game behave as follows:

```
GO FORWARD HOW MUCH?
FKJSL
PLEASE TYPE A NUMBER
FIFTY
PLEASE TYPE A NUMBER
50
.
.
.
```

Lists

We've seen that Logo's procedural organization makes it an easy and convenient language for writing programs. Most modern programming languages are, in fact, procedurally organized, although few languages make it so easy to interactively define and modify procedures as does Logo.

A much more special aspect of Logo is the way it handles *collections of data*. This is done using *lists*. A list is a sequence of data objects. For example:

```
[1 2 BUCKLE MY SHOE]
```

is a list of five things. The items in a list can themselves be lists, as in:

```
[[PETER PAN] WENDY JOHN]
```

which is a list of three items, the first of which is itself a list of two items. Similarly, we can have lists whose items are lists, and so on. Lists, therefore, are a natural way to represent *hierarchical structures*, that is, structures composed of parts that themselves are composed of parts.

Logo includes a number of operations for manipulating lists. **FIRST** extracts the first item of the list. In this example:

```
FIRST [1 2 BUCKLE MY SHOE]
```

it is 1, and in the next example:

```
FIRST [[PETER PAN] WENDY JOHN]
```

it is [PETER PAN].

The **BUTFIRST** operation returns the list consisting of all but the first item of the given list, so in

```
BUTFIRST [1 2 BUCKLE MY SHOE]
```

it is [2 BUCKLE MY SHOE], while in

```
BUTFIRST [[PETER PAN]
WENDY JOHN]
```

it is [WENDY JOHN].

The **FPUT** operation takes the two objects *x* and *y* and constructs a list whose **FIRST** is *x* and whose **BUTFIRST** is *y*. For example:

```
FPUT 5 [2 BUCKLE MY SHOE]
```

produces the list [5 2 BUCKLE MY SHOE], and

```
FPUT [PETER PAN]
[BUCKLE MY SHOE]
```

produces the list [[PETER PAN] BUCKLE MY SHOE].

The **SENTENCE** operation, like **FPUT**, constructs larger lists from smaller ones, but in a slightly different way. **SENTENCE** takes a number of lists as inputs and combines all their elements to produce a single list. For example:

```
SENTENCE [PETER PAN]
[BUCKLE MY SHOE]
```

produces the list [PETER PAN BUCKLE MY SHOE].

The significant thing about lists in Logo is that they can be manipulated as what computer scientists call "first-class data objects." That is to say, Logo lists (as opposed, for example, to arrays in BASIC) can be:

- assigned as the values of variables
- passed as inputs to procedures
- returned as the outputs of procedures

For instance, you can assign names to lists:

```
MAKE "X [OOM PAH]
MAKE "Y [HEIGH HO]
```

and then refer to the values of these variables, so that **BUTFIRST :X** is the list [PAH]. You can also combine operations on lists to produce more complex operations. For example:

```
FIRST FIRST [[PETER PAN]
WENDY JOHN]
```

returns the word PETER.



**In an age when new standards are constantly emerging,
one disk consistently meets or exceeds them all.**

Maxell. The Gold Standard.

Not all disks are created equal. Some are better than others. To find out what's best for you, look for Maxell disks. They now carry the Gold Standard symbol of quality. It's your assurance Maxell disks meet or exceed every definition of quality. No matter who establishes it. We've earned this universal superiority by never relaxing our uniquely demanding quality control. Every aspect of manufacturing is checked, then checked again.

Your benefits are many. Take the perpetual problem of drop-outs. A drop-out is a tiny defect that wastes time and degrades computer accuracy and performance. Now that you understand what a drop-out is, forget it. Maxell disks don't have any. Each disk comes to you certified

drop-out free at the time of manufacture. You can depend on this quality protecting your valuable programs and programming time, indefinitely. We've run disks over ten million passes under conditions designed to find weak points and wear. We couldn't. And you won't.

There is a Maxell disk for the floppy system you use, or plan to use. Check your computer's instructions. Or write for our complete, highly informative brochure.

When you set the Gold Standard as your level of quality, you'll benefit from improved disk performance, immediately. Bank on it.



maxell®

You can also write procedures that manipulate lists:

```
TO DOUBLE :L
OUTPUT SENTENCE :L :L
END

PRINT DOUBLE [OOM PAH]
OOM PAH OOM PAH

PRINT DOUBLE DOUBLE
[OOM PAH]
OOM PAH OOM PAH
OOM PAH OOM PAH
```

The implication of this is that you can combine operations on lists, much as you combine operations on numbers in ordinary languages. For example, one very useful list operation is PICKRANDOM, which chooses an item at random from an input list. PICKRANDOM is not provided as a primitive operation, but is easily constructed out of simpler operations, such as finding the length of a list, selecting a random number in a given range, and extracting the *n*th item of a list.

Playing with Text

To illustrate how lists are used, let's examine a program that composes vacation postcards, such as:

```
DEAR DOROTHY
WISH YOU WERE HERE.
LOVE -- JOHN

DEAR MARY
EVERYONE'S FINE.
WRITE SOON -- AUNT EM
```

You begin by setting up lists of names and phrases from which the elements of the postcard will be chosen:

```
MAKE "NAMES
[JOHN
DOROTHY
[AUNT EM]
OCCUPANT]

MAKE "PHRASES
[[WISH YOU WERE HERE.]
[WEATHER'S GREAT!]
[SURF'S UP.]
[EVERYONE'S FINE.]]

MAKE "CLOSINGS
[LOVE
[SEE YOU SOON]
[WRITE SOON]]
```

Here's the main postcard program:

```
TO POSTCARD
PRINT SENTENCE [DEAR] NAME
PRINT BODY
PRINT (SENTENCE CLOSING
[-] NAME)
POSTCARD
END
```

The recursive call in the last line makes the procedure keep printing new postcards over and over. (Compare the SQ and POLY procedures.)

The procedures NAME, BODY, and CLOSING generate the elements of the postcard by selecting items from the appropriate lists:

```
TO NAME
OUTPUT PICKRANDOM :NAMES
END

TO BODY
OUTPUT PICKRANDOM :PHRASES
END

TO CLOSING
OUTPUT PICKRANDOM :CLOSINGS
END
```

You can change the postcard program so that it automatically augments its repertoire of phrases by every so often (say, one chance in three) asking the user to type in a new phrase and adding that to the PHRASES. To do this, add to the POSTCARD procedure the line:

```
IF 1.IN.3 LEARN.NEW.PHRASE
```

The 1.IN.3 procedure returns TRUE with odds of one chance in three and FALSE otherwise. One possible way to write this procedure is:

```
TO 1.IN.3
IF (RANDOM 3) = 0 OUTPUT "TRUE
OUTPUT "FALSE
END
```

Here's how the program learns a new phrase:

```
TO LEARN.NEW.PHRASE
PRINT [PLEASE TYPE IN A NEW PHRASE]
MAKE "PHRASES FPUT REQUEST
:PHRASES
END
```

The idea is that REQUEST returns (as a list) the phrase that the user types in response to the message. This is added to PHRASES (by means of

FPUT), so that the program will be able to use this phrase in future postcards, like:

```
PLEASE TYPE IN A NEW PHRASE
DON'T FORGET TO FEED THE DOG.

DEAR OCCUPANT
DON'T FORGET TO FEED THE DOG.
LOVE -- JOHN
```

Another change you can make is to generate longer postcards, whose BODY consists of one or more phrases. One way to do this is to alter the BODY procedure as follows:

```
TO BODY
IF 1.IN.2 OUTPUT SINGLE.PHRASE
OUTPUT SENTENCE BODY
SINGLE.PHRASE

TO SINGLE.PHRASE
OUTPUT PICKRANDOM :PHRASES
END
```

This uses recursion in a devious way. Half the time you call BODY, it will output a single phrase, just as before. (The procedure 1.IN.2 is analogous to the 1.IN.3 procedure above.) But the other half of the time, it recursively generates a new BODY and combines this (using SENTENCE) with a single phrase. The new (recursively called) BODY will itself generate a single phrase only half the time. Otherwise, it will call a *third* BODY. The result is that a call to body will generate a single phrase about half the time, two phrases about one-fourth of the time, three phrases about one-eighth of the time, and so on.

Here's the final postcard program in action:

```
DEAR AUNT EM
SURF'S UP. DON'T FORGET TO
FEED THE DOG.
WRITE SOON -- DOROTHY

PLEASE TYPE IN A NEW PHRASE
GET THE MONEY IN SMALL BILLS.

DEAR OCCUPANT
WEATHER'S GREAT! WISH YOU
WERE HERE. GET THE
MONEY IN SMALL BILLS.
SEE YOU SOON -- JOHN
```

ALL MATTER IS MODULAR. YOUR PRINTER SHOULD BE, TOO.



Introducing the Prism Printer™ from Integral Data Systems, the first truly modular, field-upgradeable dot matrix printer. Now your printer can be as flexible as the rest of your system.

Start with the basic printer which features text-quality printing; then add the performance options you need — when you need them. Add the automatic cut sheet feeder for word processing. Install the Sprint Mode™ for high-speed data output. For communicating information and ideas faster, nothing is more effective than the Dot Plot™ graphic option and Prism Color™ option — this gives you high-quality, multi-color output in text, graphs and charts. And that's just the beginning. More Prism option modules will be available soon.

If you're an APPLE™, IBM™ or other professional microcomputer user, Prism Printer is the key to your system solution. At last, the chemistry is right between you and your printer. You'll never pay too much or get too little again. The Prism Printer from Integral Data Systems.

For the name of your nearest Integral Data Systems Dealer, call toll free (800) 258-1386. In New Hampshire, Alaska and Hawaii, call (603) 673-9100.



Integral Data Systems, Inc.

Milford, NH 03055

Telex: 953032

APPLE is a registered trademark of Apple Corporation.

IBM is a registered trademark of International Business Machines Corporation.

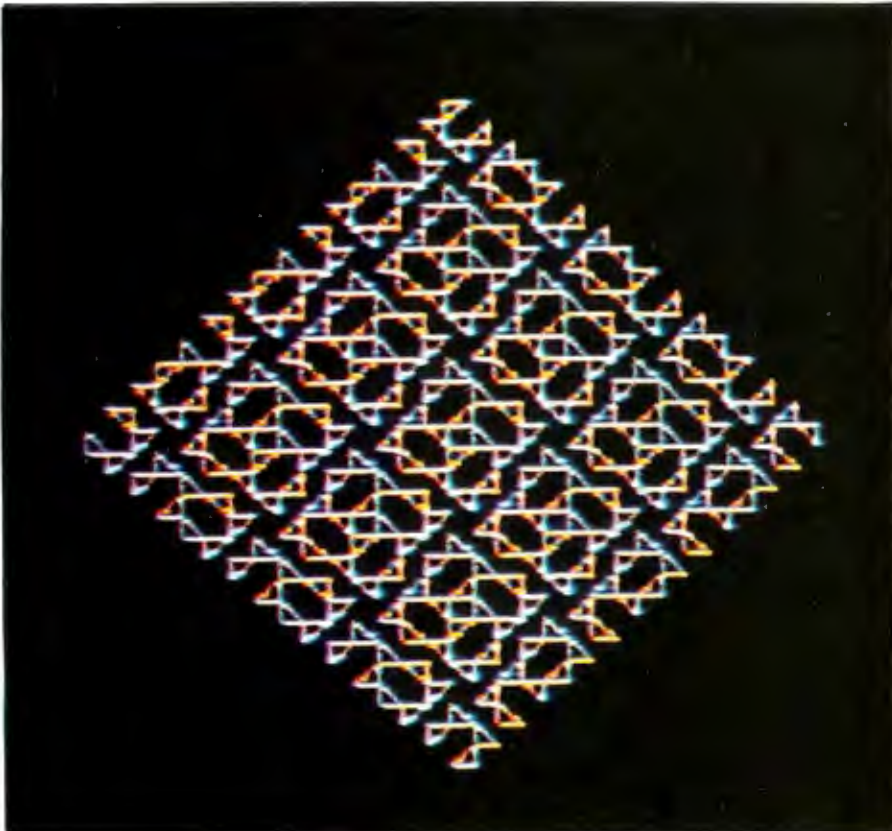

(2a)

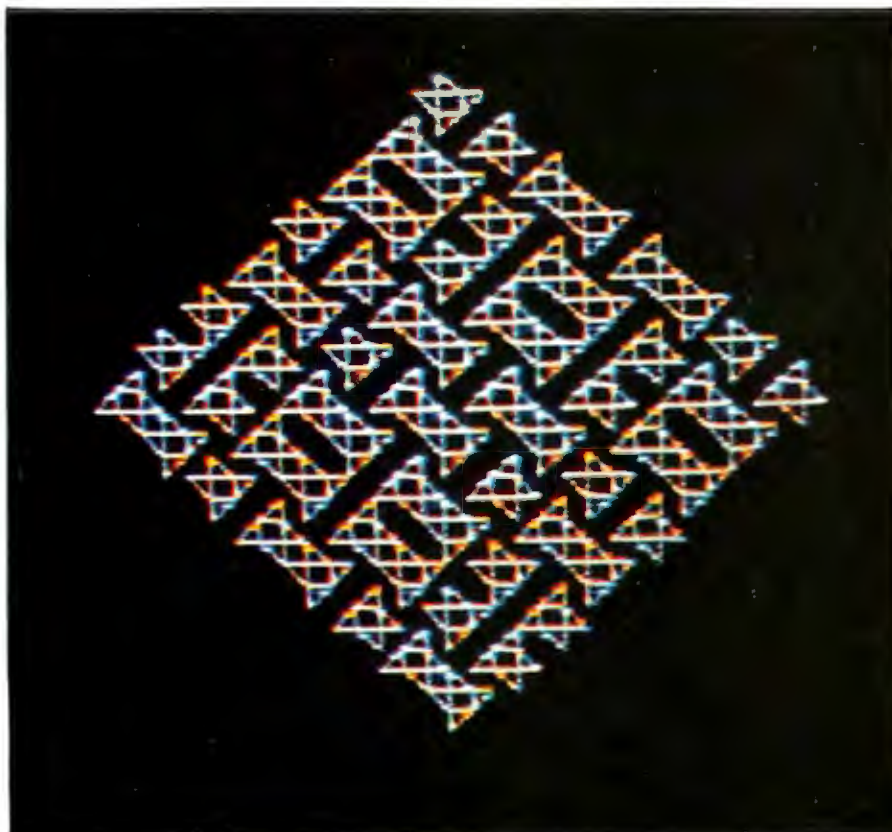

(2b)

Photos 2a and 2b: Two tiling patterns constructed from the same basic figure (a triangle within a square). The differences in the patterns are due to using different orientations when the basic figure is combined into "higher-level" patterns.

Text-generation procedures are fun to write and to play with and also easy to modify. You can make them as elaborate or as simple as you like and apply the same ideas to producing essays, poems, love letters, and so on. The idea of generating a random postcard program is based on work done at MIT by Neil Rowe, whose article "Grammar as a Programming Language" (*Creative Computing*, January/February 1978) contains many other examples of text-generation procedures. It also shows how to implement, in Logo, a special-purpose "sublanguage" for creating such programs.

Recursive Tiling

The success of Logo as a catalyst for learning involves much more than the Logo language itself, although the language does play a crucial role. The best kind of Logo activity is a synthesis of programming, mathematics, aesthetics, and, above all, the opportunity to explore. One particularly striking example of this is the "recursive tiling" program invented by Andrea diSessa and Doug Hill. This scheme enables you to write simple procedures that draw patterns such as the ones shown in photos 2 and 3, giving you literally billions of possibilities to examine and explore.

The idea is as follows. Suppose you have a program that draws a pattern inside a square of some given size. By scaling the pattern size in half and gluing together four copies, you obtain a more complex pattern in the a square of the original size, as shown in figure 5a on page 108. In fact, you can generate many different patterns from a single pattern because each copy of the original pattern that you place in each corner square can be rotated through an arbitrary multiple of 90 degrees, as shown in figure 5b.

To convert this idea into a computer program, suppose you have a procedure called PROC that draws a pattern in a square. Assume that PROC takes an input S that specifies the size of the square, scaled so that S is equal to half the diagonal of the square. Assume also that PROC is designed to begin drawing with the turtle at the center of the square pointing

at a vertex, and to end with the turtle in the same state.

Now suppose you have a square of size S divided into four "corner squares" each of size $S/2$. The following process is designed to start with the turtle at the center of the square, facing one of the corners. It draws a copy of the PROC design in that corner square and returns the turtle to the center of the larger square. Then it turns the turtle 90 degrees to point at the next corner square. The steps in the process are:

1. Move the turtle FORWARD a distance of $S/2$. This brings the turtle to the center of the small square, pointing at a vertex of *that* square.
2. Run the procedure PROC with an input of $S/2$ (half the diagonal of the smaller square). This draws the pattern and leaves the turtle at the center of the small square.
3. Move the turtle BACK a distance of $S/2$ to return it to the center of the larger square.
4. Rotate the turtle 90 degrees.

In addition, before performing step 2, you can rotate the pattern through a multiple of 90 degrees. If you do this, you should perform the opposite rotation at the end of step 2, so that the turtle will end up facing in the same direction from which it started.

The following CORNER procedure implements this strategy. CORNER takes three inputs. The first, A , is a multiple of 90 degrees to be turned before drawing the pattern (A is an integer from 0 to 3). The next input, PROC, is the name of the procedure that draws the pattern. PROC is assumed to take one input that specifies the size of the pattern. The third input to CORNER is a number S that specifies the size of the square. The procedure is used as follows:

```
TO CORNER :A :PROC :S
FORWARD :S/2
RIGHT 90 * :A
DRAWFIGURE :PROC :S/2
LEFT 90 * :A
BACK :S/2
RIGHT 90
END
```

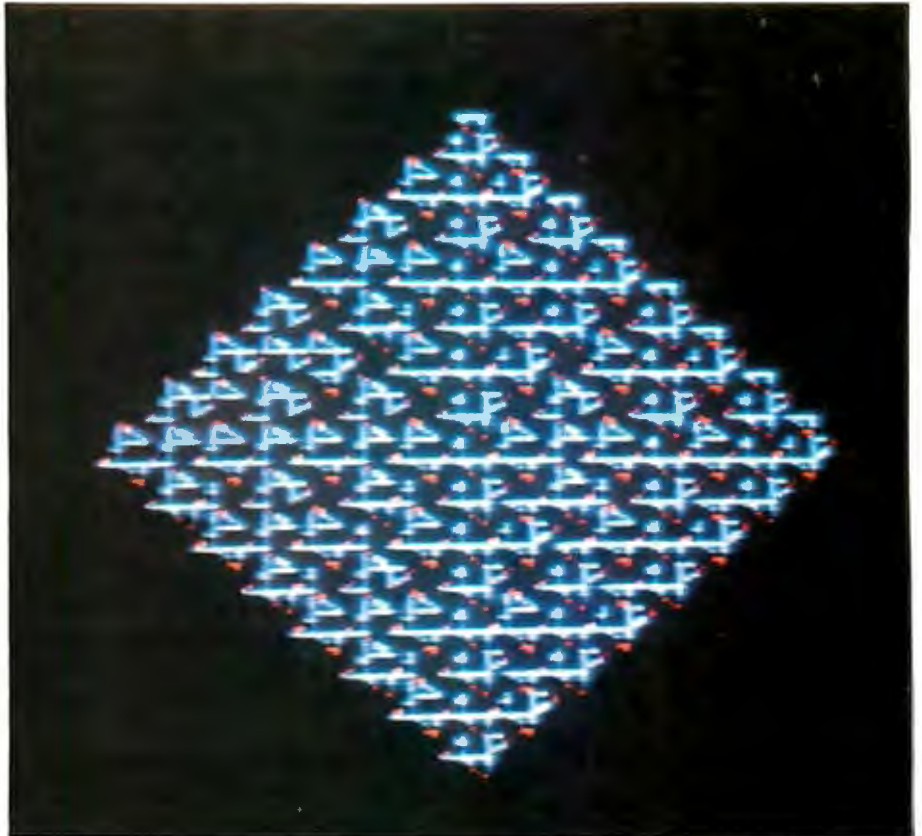

(3a)

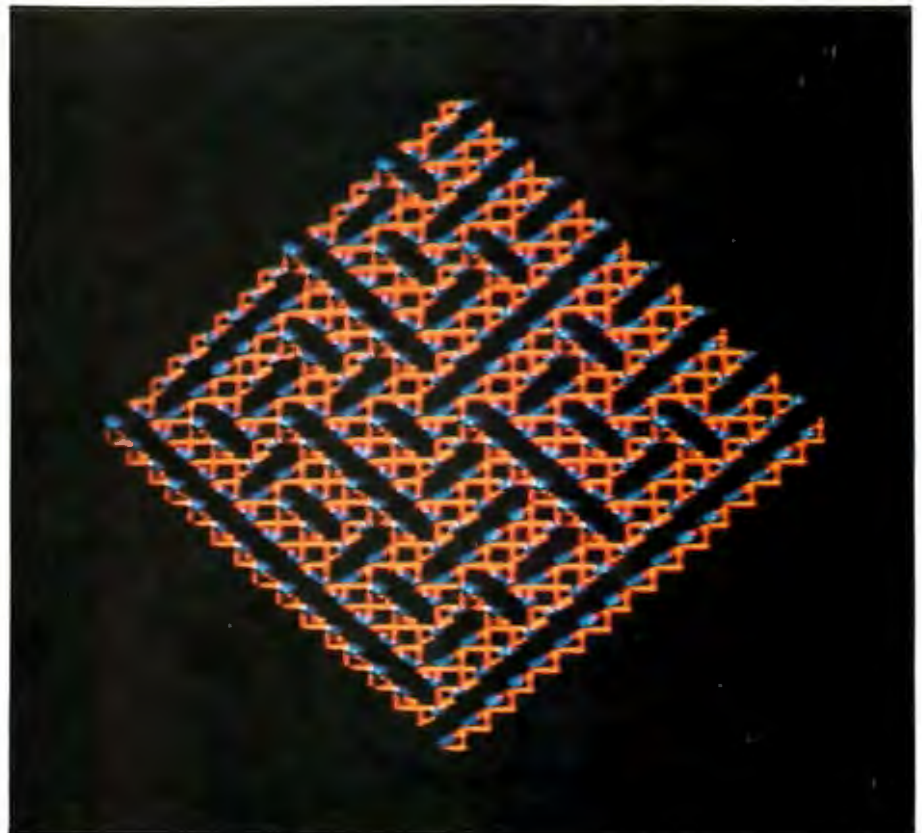

(3b)

Photos 3a and 3b: Two tiling patterns constructed on the same basic triangle as in photos 2a and 2b. All four patterns use the gluing scheme shown in figures 5a and 5b, and photos 4a, 4b, and 4c, extended to four levels.

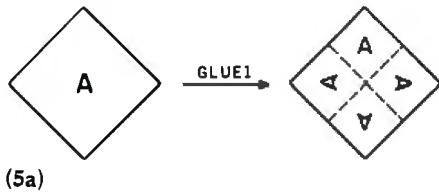

(5a)

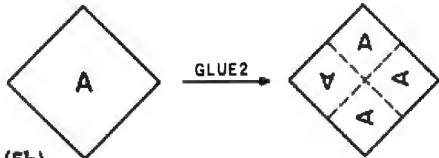

(5b)

Figure 5: Given a design that lies inside a square, four copies of the same design (each scaled to half the size of the original) will produce a more complex pattern in the same square. Varying the relative orientations of the four copies produces different overall designs. This is the basic gluing scheme used to produce the patterns in photos 2a, 2b, 3a, and 3b, starting with a triangle, and repeating the gluing process four times (i.e., working with a final pattern element scaled to 1/16 times the size of the original square).

The CORNER procedure uses a sub-procedure DRAWFIGURE, which takes as inputs a procedure name and a number and runs the procedure with the number as input. DRAWFIGURE is implemented in terms of the Logo primitive operation RUN, which executes a list as if it were a typed-in command line:

```
TO DRAWFIGURE :PROC :INPUT
  RUN SENTENCE :PROC :INPUT
END
```

For example, if you execute:

```
DRAWFIGURE [SQUARE] 100
```

this combines [SQUARE] and 100 to obtain the list [SQUARE 100] and executes this list as if it were a typed-in Logo command line, which is to say, it executes the command SQUARE 100.

The CORNER procedure begins with the turtle pointing at one corner of the large square; it ends with the turtle pointing at the next corner. This means that you can obtain a complete

gluing design by running CORNER four times. Each of the four calls to CORNER can specify a different 90-degree multiple of A, through which the design in that corner should be rotated. Since each gluing has four corners, and each corner can have any of four rotations, there are 4⁴ or 256 possible gluings for any given pattern. Here are two possible gluings:

```
TO GLUE1 :PROC :S
  REPEAT 4 [CORNER 0 :PROC :S]
END
```

```
TO GLUE2 :PROC :S
  CORNER 0 :PROC :S
  CORNER 2 :PROC :S
  CORNER 1 :PROC :S
  CORNER 3 :PROC :S
END
```

Photo 4b shows the result of entering

```
GLUE1 [TRI] 100
```

where TRI is a procedure that draws a small triangle inside a square, as

Circle 413 on Inquiry card.



Step Up The Pace... Higher Technology at Lower Cost.

- Bell 212 compatible — 1200 Baud
- Full duplex
- 120 CPS over any standard phone line

Microprocessor design has invaded the modem world. Our new 1200 baud modems pack Bell 212 compatibility into 10 integrated circuits by far the lowest parts count of any 212 modem available. The extremely low parts count translates directly into long life, outstanding reliability and low production costs — savings passed on to you in a lower price.

The Micro Link 1200 features originate and answer capability. The Auto Link 1200 includes these features plus auto answer. Both units are FCC certified for direct connection to the phone lines via a standard RJ11C phone jack and include RS232C, Self Test, and a one year limited warranty.

Take advantage of higher technology at lower cost. Call for full product specifications and today.

Micro Link 1200 \$449* Auto Link 1200 \$549*

*Suggested list price, quantity one



U.S. ROBOTICS INC.

INTRODUCING MORE REASONS FOR TRYING CONTROL DATA FLEXIBLE DISKS RIGHT NOW.

2 FREE IN EVERY BOX.

Now you have two more reasons to try Control Data flexible disks. Two free disks in every specially labeled box of 10 beginning July 1st. That's 12 disks, or 20% more in every box.

Control Data flexible disks are dependable. They're guaranteed error-free so you can count on them to perform time after time. We manufacture and test every disk to exacting standards. It's one reason many users choose our media above all others.

Control Data disks are available in both 8-Inch and 5-1/4-Inch sizes, in a variety of formats. And from now until Dec. 31, 1982, you get two free in every specially labeled box—just for trying them.

If there isn't a participating distributor near you, call toll-free 800/328-6207.

DISTRIBUTORS

CALIFORNIA

Lodi, Visible Computer Supply Corp.
209/334-9487
Orange, Data Bits, Inc.
714/633-6650
Simi Valley, The Supply Depot
805/583-0505

COLORADO

Denver, Data Pro Ltd.
303/777-8655

FLORIDA

Hialeah, KAR Printing
305/557-4782
Miami, Data Pax
305/446-9291

GEORGIA

Atlanta, Data Associates, Inc.
404/252-9818

ILLINOIS

Chicago, Thomas Computer Corp.
312/944-1401
St. Charles, Visible Computer Supply Corp.
312/377-0990

IOWA

Cedar Rapids, Network Business Forms, Inc.
319/365-8691

MARYLAND

Gaithersburg, BASY's
301/977-6900
Jessup, Data Storage, Inc.
301/953-2424

MASSACHUSETTS

Woburn, Data Research Associates
617/938-0425

MICHIGAN

Southfield, Transaction Storage Systems
313/557-3036

MINNESOTA

Bloomington, Allanson Business Prod., Inc.
612/881-1151
Minneapolis, Sexton Data Products
612/941-5880

MISSOURI

Hazelwood, Specialty Computer Ribbons & Supplies
314/731-0808

NEW JERSEY

Engelwood, Data Research Associates
201/569-2620

NEW YORK

New York, Data Research Associates
212/564-2232

OREGON

Eugene, Western Paper Company
503/686-8361
Jacksonville, Computer Exchange
503/772-3803
Portland, Western Paper Company
503/288-5646

PENNSYLVANIA

Berwyn, Used Computer, Inc. (UCI)
215/647-1881

TEXAS

Austin, Business Data Products
512/453-5129
Dallas, Philbo Enterprises
214/358-1200
Houston, Suntext Data Supplies
713/783-5270
San Antonio, Bull's I Data
512/656-6367
San Antonio, Transcontinental Distrib.
512/737-0064

UTAH

Salt Lake City, Rebel Enterprises, Inc.
801/261-3300

VIRGINIA

Fairfax, Data Research Associates
703/385-3414

WASHINGTON

Kent, Western Paper Company
206/251-5300
Pasco, Western Paper Company
509/547-1633



CD CONTROL DATA

Circle 118 on Inquiry card.

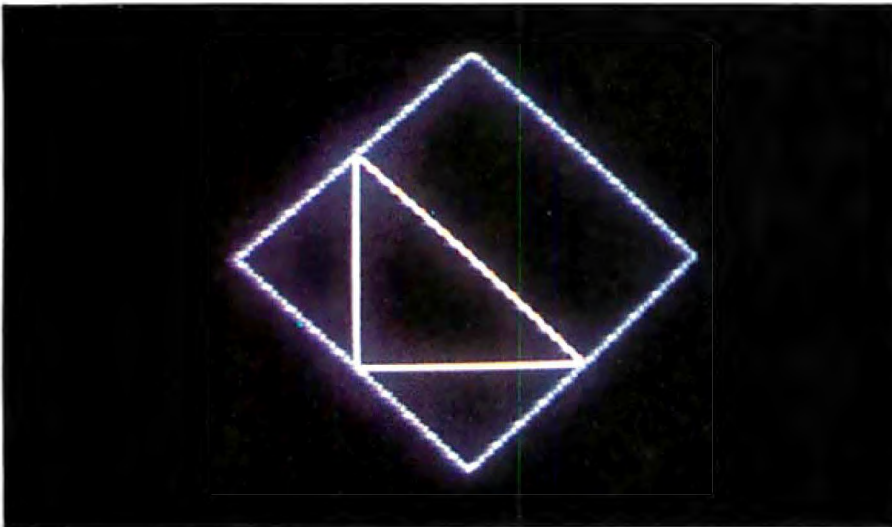

(4a)

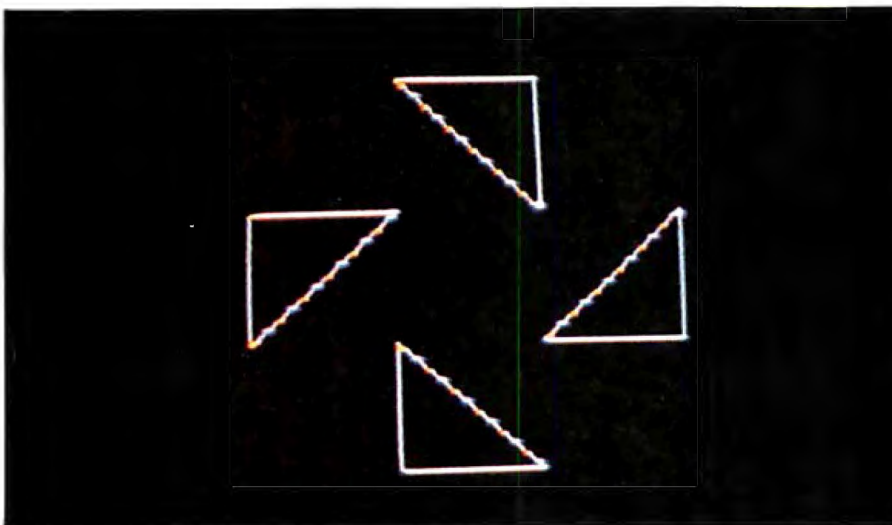

(4b)

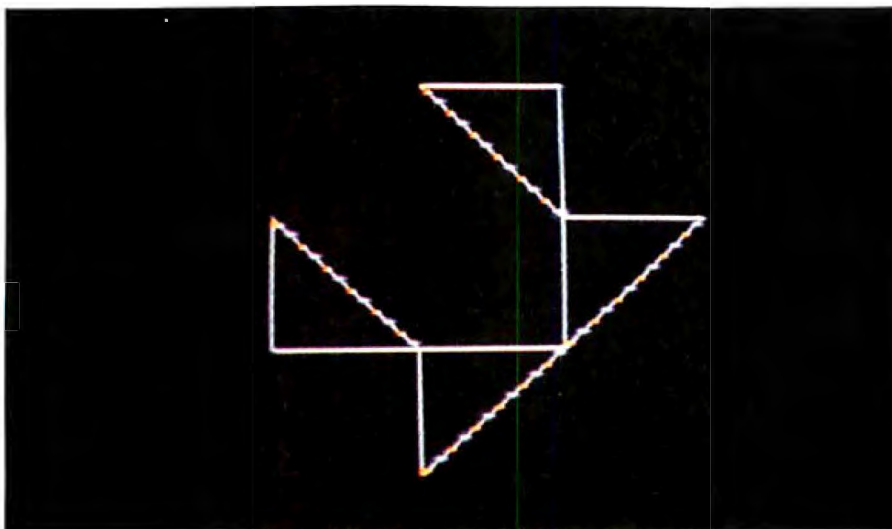

(4c)

Photo 4: Photo 4a shows a triangle inside a square, as drawn by the procedure TRI. (The square, shown here in color, is not drawn by TRI. Photos 4b and 4c show two different one-level gluings of the TRI procedure to form a more complicated figure inside a square. The complex designs in photos 2a, 2b, 3a, and 3b are four-level gluings based on the same TRI figure.

shown in photo 4a. (In accordance with general gluing strategy, TRI should be a procedure that takes one input that specifies the size of the square.) For comparison, photo 4c shows a different gluing:

GLUE2 [TRI] 100

Now comes the clever idea. The GLUE procedures enable you to glue together four copies of any pattern. On the other hand, entering

GLUE1 [TRI] 100

is *also* a command that draws a pattern in a square. In fact, the list [GLUE1 [TRI]], when combined with a size (via the DRAWFIGURE procedure), produces a command that draws a pattern in a square of the specified size. Therefore, you can use a GLUE procedure to glue together four of *these* patterns, for example:

GLUE1 [GLUE1 [TRI]] 100

or

GLUE2 [GLUE1 [TRI]] 100

But again, each of these "two-level" gluings is *itself* something that can be glued, so you can make three-level patterns such as

GLUE2 [GLUE1 [GLUE2 [TRI]]] 100

and so on and so one. The patterns shown in photos 2a, 2b, 3a and 3b are, in fact, all four-level gluings based on the same TRI procedure, using different rotations at the various levels.

There's an enormous range of possibilities to investigate here. Four levels of gluings with 256 orientation choices at each level give 256^4 or more than 4 billion possible four-level gluings, all from a single base pattern! (The number of distinct patterns is reduced by various symmetries in the gluing process, which is itself an interesting phenomenon to explore.) For more variety, you can try different base patterns, or even develop different gluing schemes, such as the one derived from dividing an equilateral triangle into four smaller equilateral triangles. (See *Turtle Geometry*

HAVEN'T YOU HEARD OF THUNDERCLOCK PLUS™?



If you want to put your Apple® to work—around the clock—Thunderclock Plus is the solution. Just plug it in and your programs can read the month, date, day of week and time—down to the second—in any of Apple's languages. So your Apple can do any number of tasks for you automatically. In the office, the lab or at home.

Most good software packages for business, data base management, communications and time management are made to read Thunderclock Plus. (It's compatible with DB Master,* Micro-Courier** and VisiDex†, to name a few). So no matter how you use your Apple now, Thunderclock Plus can make it a more versatile and efficient tool.

For example, with business or communications software, your Apple can automatically access a data base or send electronic mail when the rates are lowest.

In addition, Thunderclock Plus can organize your disk files. Our optional DOS-DATER™ software upgrades the regular DOS on your disks. So every time a program is saved or a file is modified, the time and date, *to the minute*, are stored in the CATALOG with the file name. Now you can instantly know exactly when your files were last updated.



Thunderware's DOS-DATER time and date stamps your disk files to the minute.

Thunderclock Plus can even give you a sense of security. Or just make your life a little easier. With our X-10 interface option and a BSR X-10‡ Home Control System, your Apple can turn on your lights, water your lawn... whatever you desire, according to schedules you create. It comes with our menu-driven SCHEDULER software. So it's easy to design and modify schedules that can run in the "background" while you have "hands-on" use of your Apple.

Thunderclock Plus comes with a one-year warranty. Powered by on-board batteries, it runs accurately for up to four years without battery replacement.

So now that you've heard of Thunderclock Plus, isn't it time you put your Apple to work—around the clock? See your dealer for a demonstration or contact us.

THUNDERCLOCK PLUS and BASIC software	\$150
DOS-DATER/DEMO disk	\$ 29
X-10 Interface option	\$ 49
PASCAL software disk	\$ 29

*Apple is a registered trademark of Apple Computer, Inc.
 *DB Master is a registered trademark of Stoneware, Inc.
 **Micro-Courier is a registered trademark of Microcom.
 †VisiDex is a registered trademark of VisiCorp.
 ‡BSR X-10 is a registered trademark of BSR (USA) Ltd.



THUNDERWARE, INC.

44 Hermosa Ave., Oakland, CA 94618 (415) 652-1737

Circle 408 on Inquiry card. →

Expand Your IBM P.C.



\$229⁰⁰

■ Memory Expansion Board

(PC)²'s Expansion Board offers 4 TIMES the amount of memory offered by IBM P.C. Configurations can be set at 64K, 128K, 192K and 256K Bytes. Board can be easily upgraded in 64K capacities. Upgradability is the key!



\$1895⁰⁰
For
6M Bytes

■ Add-In Winchester Disk System

(PC)²'s Add-In Winchester Disk System is housed within the IBM chassis and is easy to install directly into the floppy slot, reducing desktop space. Also available in 12 and 18 M Bytes capacity.

■ Asynchronous Communications Controller

1 or 2 line capability on one card.
Totally compatible with IBM software and diagnostics.

As
little as
\$85⁰⁰

■ DS-Disk Software

(PC)²'s software program doubles the IBM single-sided diskette capacity by using both sides. Increases capacity from 160K to 320K. Used with Tandon TM100-2 disk drive or equivalent.

\$40⁰⁰

PHONE OR WRITE — BUT ORDER NOW!

(PC)², P.O. Box 678
510 Lawrence Expressway
Sunnyvale, CA 94086

(408) 749-9313

Postage and Handling included within continental U.S.A.
One year warranty on all board products.
MasterCard, Visa and Checks accepted.



PLUG COMPATIBLES FOR PERSONAL COMPUTERS

for more investigations with "recursive designs.")

The Computational Perspective

Logo is often described as a programming language. Those of us who designed Logo tend to think of it rather as a computer-based learning environment, where the activities (exploring the symmetry of POLY) are just as integral as the programming tools used (recursion and lists). Logo is also a continually evolving environment, and the microcomputer implementations of Logo that have appeared during the past year are only the first to be widely available. We plan to extend Logo to incorporate new linguistic features, such as the "message passing" facilities found in Smalltalk and recent implementations of LISP (see the August 1981 issue of BYTE for an overview of Smalltalk), as well as new activities, such as a computer-based physics curriculum that builds upon turtle geometry. At the MIT Laboratory for Computer Science, the Educational Computing Group is designing a follow-on system to Logo suitable for the new generation of personal computers that will be coming into use during the latter half of the 1980s.

The next few years will be exciting ones in educational computing because personal computers are becoming powerful enough to support systems that are designed for the convenience of people rather than for the convenience of compilers. If we can dispel the delusion that learning about computers should be an activity of fiddling with array indexes and worrying about whether X is an integer or a real number, we can begin to focus on programming as a source of *ideas*. For programming is an activity of *describing* things. The descriptions are phrased so that they can be interpreted by a computer, but that is not really so important. Computational descriptions, like those of science or mathematics, provide a perspective, a collection of "tools of thought," such as procedural organization, hierarchical structure, and recursive formulations. Logo, and languages like it, will help make these tools available to everyone. ■

Up to now, bubble technology has been the exclusive domain of large computer systems. Now, MPC Peripherals has boldly ventured where no one has gone before — successfully channeling the same state-of-the-art bubble technology into the personal computer field.

Introducing the MPC Bubble Memory Disk Emulator for the Apple II. A compact board with 128K bytes of non-volatile data storage.

Executes DOS commands three times faster than a standard floppy disk drive. Uses less power. Functions quietly, efficiently and error-free in any hostile environment.

The rugged, solid-state bubble memory is totally non-volatile. Unlike disk, there are no moving parts to wear. On-board error correction plus automatic power-down in the event of outright power failure or brown-out ensures absolute data storage reliability.

Once again, we offer you a TWO YEAR WARRANTY — an expression of product confidence unprecedented in this industry.

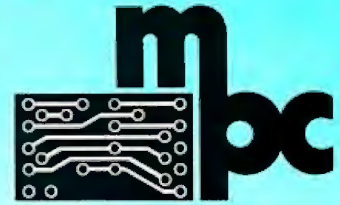

MPC Peripherals Corp.
9424 Chesapeake Drive
San Diego, CA 92123
Tel. (714) 278-0630

The Bubble has landed in the orchard





FRANKLIN **ACE** 1000



THE BEST DEAL IN TOWN!

THE FRANKLIN **ACE**1000

You just can't beat an ACE. Especially the Franklin ACE 1000. It's the professional personal computer with all the trump cards—it costs less than Apple® II and it includes 64K of RAM, upper and lower case capabilities, a numeric pad and VisiCalc® keys.

Peripherals that work with the Apple II will work with the Franklin ACE 1000. Programs that run on the Apple will run on the ACE. Totally Apple compatible . . . yet, so much more!

The Franklin Ace 1000—price, power, quality, reliability—the best deal in town. Call or write today for the name of your local authorized Franklin dealer.



FRANKLIN
COMPUTER CORPORATION

7030 Colonial Highway
Pennsauken, NJ 08109
609-488-1700

Franklin ACE is a trademark of Franklin Computer Corporation
Apple is a registered trademark of Apple Computer Inc.
VisiCalc is a registered trademark of Visi Corp.



Logo in the Schools

Putting Logo in the classroom has led to some interesting results.

Daniel Watt
Editor, BYTE Books

In the 15 years since its development, the Logo computer language has been used in a variety of research and educational settings. Students from preschool to graduate school; those with severe physical, mental, and emotional handicaps; and students with outstanding ability in science and mathematics have been involved with Logo. It has been used in educational settings to:

- provide an environment for experiential learning of mathematics
- promote the development of problem-solving abilities
- serve as an introductory programming language that helps students learn principles of structured programming

About the Author

Daniel Watt, a former elementary-school teacher, was involved in curriculum development and the Brookline Logo project at MIT. Watt holds a doctorate in engineering from Cornell University and is currently an editor with BYTE.

● serve as a vehicle for computer literacy, helping students develop a sense of personal control of a computer

● support the learning of students who, for one reason or another, have not been successful in traditional classrooms

● provide the basis for learning environments in a number of subject areas, including music, language arts, fine arts, physics, biology, and mathematics

● form a foundation for an entirely new kind of school based on Piagetian approaches to teaching and learning, using computers as all-purpose tools to facilitate learning

Each time Logo has been introduced into a school, certain objectives have been emphasized at the expense of others. This article deals with four different Logo projects and describes the settings, the goals of each project, and some of the known results. In some cases, I have drawn on the published reports listed in the

references. Where published reports are not available, I have relied on visits and interviews with people directly involved. Each of the projects has had many dimensions that are not included here because of space limitations. For further information, read the reports cited in the references or contact the projects.

Each project had a different type of student population, different choice of goals, and different kinds of results.

The Edinburgh Logo Project, Department of Artificial Intelligence, University of Edinburgh, Edinburgh, Scotland, dealt with 12- and 13-year-old boys attending a private school adjacent to the university. It focused on the use of Logo to create an environment for learning to think mathematically and on developing new methods to teach the content of conventional school mathematics.

The Brookline Logo Project, conducted as a collaboration between the MIT Logo Group and the public



Photo 1: Preschool students using TI Logo at the Lamplighter School, Dallas, Texas. Photo courtesy of Texas Instruments Inc.

schools of Brookline, Massachusetts, had two very different phases. In the first, a laboratory was set up with four computers. The emphasis of the research was to observe and document what a group of sixth-grade students actually learned, rather than assess whether they had achieved a set of preplanned objectives.

The second phase of the Brookline Logo Project involved placing computers in fourth- through eighth-grade classrooms for several weeks at a time. This project emphasized the development of curriculum materials to support the learning of Logo as one activity in a multifocused classroom. The *Computers in Schools Project*, conducted by the New York Academy of Sciences in conjunction with the New York Public Schools, provided training for elementary and junior high school teachers to use Logo as a permanent feature of their classrooms. The major focus of this project has been implementation in

the school, training and supporting teachers to ensure successful use of Logo in the classroom.

The *Lamplighter School Logo Project*, conducted at a private school in Dallas, Texas, for students aged 3 to 9, is the most ambitious Logo project to date. Conducted as a joint effort with the school, the MIT Logo Group, and Texas Instruments, the project was intended to provide the school with enough computer hardware that access to computers would not be a limitation on what the students could learn. Logo would be taught to all students and teachers, from nursery school through grade four. Eventually, the project was expected to enhance learning in many areas as it facilitated the use of the computer as a multipurpose learning tool throughout the curriculum. The Lamplighter School also served as the primary test site for the development of the Texas Instruments implementation of Logo.

The Edinburgh Logo Project

The objective of the Edinburgh Logo Project was to discover whether the students' "... ability to do mathematics and to talk about their mathematics was changed by exploring mathematical problems through [Logo] programming." The quotes in this section are taken from *Teaching Mathematics Through Logo Programming: An Evaluation Study*, by Howe, O'Shea, and Plane (see references section 1). The students were a group of 11 sixth-grade boys from the George Herriot School, a private school near the university. They were selected from the school's lowest-level math group.

The project lasted for two years, during which the students attended a Logo lab at the university. For the first year, the students worked through a set of graded worksheets to learn the basic elements of Logo. For the second year, they did special Logo exercises designed to teach topics

selected from their regular mathematics curriculum.

The project was highly structured in several respects. The students' learning experiences were structured by means of assigned worksheets that they worked through in order, each at his own rate. In this way, researchers could effectively monitor the progress of each student. During the second year of the project, Logo activities were drawn from mathematical topics such as areas of rectangles, factors and multiples, positive and negative numbers, and plotting coordinates on graphs.

The research aspect of the project was also carefully structured. Students were given standardized tests in mathematics before and after the project. Their progress was compared with that of a control group (drawn from boys in the second lowest-level math group). Both groups of boys, as well as their teachers, were also given a series of questionnaires designed to measure their attitudes toward mathematics.

Great care was taken to see that the research design was carefully carried out.

The published results of the project on student achievement were not very dramatic. Over the two years,

Teachers found that students who had taken part in the Logo classes were more willing to "argue sensibly about mathematical issues" and to explain their "mathematical difficulties clearly."

the experimental group improved a bit more than the control group on a "basic maths" test. The reverse was true on a "maths attainment" test. The most interesting finding had to do with the teachers' perceptions of

the students in both groups. Teachers found that students who had taken part in the Logo classes were more willing to "argue sensibly about mathematical issues" and to explain their "mathematical difficulties clearly." This finding may have depended as much on the teaching approach used by the Logo teachers—as compared with the classroom mathematics teachers—and on the individual assistance the Logo students received, as it did on the Logo activities themselves.

Conversations with some of the people involved indicate that a lot of interesting data about what and how the students learned was collected during this project. Unfortunately, little of that information has been analyzed or published. For people interested in teaching Logo, the most tangible results of the project may be the sets of worksheets developed to teach Logo concepts and mathematical applications. These represent a useful set of Logo teaching ideas—even if they are not used in the strictly

FORTRAN, Pascal, COBOL/Ada™* UNIX™ III 68000



XAVAX Three
Hardware

- 68000 CPU at 8MHz (10MHz option)
- Two level memory management
- 256KB on board RAM (512KB option)
- Up to 32KB of on board PROM
- 64KB RAM, bus expandable to 1MB
- Floppy disk, 6MB Winchester disk
- Full Multibus™ and multimaster
- 9 serial I/O ports
- 9 slot backplane (IEEE 796)
- 84MB Winchester hard disk
- 10MB cartridge tape backup
- 168 and 300MB hard disks

Software

- UNIX™III, multiuser version
- UC Berkeley utilities
- Screen oriented vi editor
- FORTRAN-77 (programs to 1MB)
- ISO Pascal, UCSD extensions
- RM COBOL, C, assembler
- *Ada™ under separate OS
- XCCX™ multiversion file backup
- TXT™ enhanced UNIX™ editor

Multibus™ of Intel Corporation
UNIX™ of Bell Laboratories
Ada™ of Department of Defense
Ethernet™ of Xerox Corporation

GRAPHICS 1024 x 792

- Emulates Tektronix 4014-1
- 1024 x 792 pixel landscape display
- 4096 x 4096 apparent resolution
- Bit mapped raster graphics
- Mouse pointer for display changes
- 17 inch interlaced monitor (P40)
- X,Y (0,0) coordinates displayed
- Full screen update 64 milliseconds
- Dedicated floating point hardware
- Ethernet™ local area networking

IMMEDIATE ATTENTION!

<input type="checkbox"/> XAVAX One (board only, 128KB RAM) \$2,000 <input type="checkbox"/> XAVAX Two (with 10MB Winchester) \$9,500 <input type="checkbox"/> TekGraf™ (desktop graphics system) \$12,000 <input type="checkbox"/> Manuals: XAVAX One (\$15), XAVAX Two (\$35), XAVAX Three (\$75) USA postpaid.	<input type="checkbox"/> XAVAX Three (UNIX™III) \$14,000 <input type="checkbox"/> XAVAX Four (multi-CPU) \$40,000 <input type="checkbox"/> Ethernet™ (local network) \$3,000
---	--

B882

Mail checkmarked copy: XAVAX, POB 1105. MasterCard and VISA accepted.

Phone: **XAVAX CORPORATION** TWX
 (319) 323-2332 300 Northwest Tower, Bettendorf, IA 52722 910-525-1177

The revolutionary Discovery multiprocessor is the only system that allows the total integration of powerful 16 bit 8086 processors with the more standard Z-80 user processors. The DISCOVERY system may be configured in any 8 bit/16 bit combination, or as a totally exclusive 16 bit system only to provide the ultimate in performance and flexibility in advanced micro systems.

Ultimate performance. The dpc-186 is the most sophisticated single board microcomputer available today offering more power and faster processing time through the 8086 CPU for bigger, more complex programs. Memory starts at 128 K (compared to the Z-80's 64 K), and is expandable to 1 megabyte. And the dpc-186 is fully compatible with the standard DISCOVERY multiprocessor system permitting efficient upgrading as future needs develop, without sacrificing any of your extensive hardware and software investment.

World's best multiprocessor system. The DISCOVERY system provides separate processors and memory for each of its 16 users. It offers full CP/M™ and CP/M-86™ compatibility, interprocessor communication, and shared and private files. Each user can take advantage of shared peripherals and cross submitting of tasks between processors. The system is controlled by a unique, two board dpc-280 service processor and dpc/os distributed processing operating system.

By the board or by the system. The DISCOVERY multiprocessor is ready for immediate delivery as a complete system, as processor boards, and everything in between. It offers exclusive technology in multiprocessing, yet is fully compatible with existing standards including CP/M and S-100. It is quite simply unmatched in performance, capabilities and offers a far greater degree of flexibility. DISCOVERY—offering a whole new world of possibilities.

For the first time, 8 and 16 bit processor intermixing.



Action Computer Enterprises, Inc.



The Multiprocessing Company
55 West Del Mar Boulevard, Pasadena, CA 91105 USA
(213) 793-2440, TWX 910-588-1201

Circle 7 on inquiry card.

Dealer and OEM inquiries invited.

*CP/M is a registered TM of Digital Research, Inc.

sequential format for which they were originally designed. Copies of student worksheets used in both years of the project are available from the Edinburgh Logo Group.

The Edinburgh Logo Group has also been involved in several other educational projects. In one project, student teachers who were not math specialists were taught Logo to see how it would affect their teaching of mathematics. In another project presently under way, computers have been installed in several schools so that the Logo curriculum can be taught by classroom teachers who have taken a Logo training course. This project is intended to give clearer results about the impact of Logo on the improvement of classroom performance in mathematics.

In order to carry out the current study, the Edinburgh Logo Group implemented a version of Logo on the Terak computer system, an LSI-11-based system with high-resolution graphics. Disks for this version of Logo are available from the Edinburgh Logo Group.

Other Logo implementation projects are under way for microcomputer systems widely available in Great Britain.

The Brookline Logo Project

The first Brookline Logo Project, funded by the National Science Foundation and conducted by the MIT Logo Group in collaboration with a public school in Brookline, Massachusetts, had a very different set of goals and results. In this case, 50 sixth-grade students were given the opportunity to learn Logo in a computer lab established within the school. The work of 16 of these students, representing a full range of academic abilities and interests, was selected for study.

The entire Logo learning experience of these students was carefully monitored and analyzed, documenting what the students learned, what learning styles they used, and what types of choices they made. Some common material and ideas were presented to all the students and intro-

ductory turtle geometry projects were stressed at the beginning of the project. Students also had the opportunity to choose their own activities and went on to develop many different Logo projects, including a math quiz, word games and conversations, animations, geometric explorations, tic-tac-toe, and dynamic action games. The students were expected to be in charge. The teachers were there to help them accomplish their own goals.

The results of the project indicate that Logo learning environments are suitable for many different kinds of students. All students, ranging from those who were academically gifted to those who had the poorest academic records, were successful in the Logo classes. The surprising success of students with learning disabilities led to a separate proposal to provide Logo training and equipment for teachers who specialized in this area. The final report of the project summarized the students' learning styles and analyzed what they learned in the areas of computer programming and mathematics. A second volume of the report traced the learning experiences of each of the 16 students individually. The report provides a basis for an introductory Logo curriculum, as well as a rich source of project ideas suitable for students with widely divergent interests and abilities.

The Brookline Logo Project was not very successful in obtaining "objective" data about learning gains made by the students. Standardized tests had been rejected as irrelevant to the goals of the project (the ability to use turtle geometry is not measured by sixth-grade math tests). The problem-solving tests and mathematical tests devised and administered by the project staff had inconclusive results. The problem of developing objective tests in such areas as problem solving or procedural thinking is still an open question for educational researchers.

Another limitation of the project was that it required an extremely sensitive and knowledgeable teacher, with a great deal of time to consider the needs of each student. It was the

ATTENTION APPLICATION PROGRAMMERS MCDISPLAY IS HERE

MASTERCOMPUTING has the answer to your biggest headache: user data entry.

Now devote your valuable time as a professional to the actual application rather than complex input prompt control and data entry checking.

MCDISPLAY is a two part screen oriented data entry system.

- | | |
|--|--|
| <p>1. DISPLAYDEF - Development Utility</p> <ul style="list-style-type: none"> • Define screen formats • Define entries, prompts, messages, text • Document screen format • Build screen files | <p>2. DISPLAYASM - Powerful assembly calls</p> <ul style="list-style-type: none"> • Build screens, process entries • Handle messages and prompts • User callable directives and primitives • Screen fields transparent to program |
|--|--|

DESIGN CONCEPTS

- | | |
|--|--|
| <ul style="list-style-type: none"> • Large system approach • User friendly • Language and system independent • Complete entry checking, conversion & protection • Low RAM and Disk overhead | <ul style="list-style-type: none"> • High speed operation • Screens easily changed & tested • Professional documentation • Maintenance free • Low cost - \$175.00 with Manual |
|--|--|

SYSTEM REQUIREMENTS

- CP/M™ 1.4 or 2.2 with cursor addressable terminal or CRT
- Languages - Microsoft Basic-80 and BASCOM. Other popular languages to follow

FUTURE ATTRACTIONS

- MCFILE** - a data base definition system with user directives
- MCPRINT** - a page oriented print system with user directives

BASIC 80 and BASCOM
are products of Microsoft
CP/M is a trademark
of **DIGITAL RESEARCH**



MasterComputing Inc.
P.O. Box 17442
Greenville, SC 29606
(803) 244-8174

THE BEST GETS BETTER!



Available NOW!
**ComboPlus with
Real-Time-Clock**
as shown Model MR-128SP

Fully field upgradeable
64K-256K Parity Checked Memory
Parallel Printer Port (IBM compatible)
Real-Time-Clock (MS-DOS support standard, CPM/86 support available)
Async Com. Port (IBM compatible)

Other products available for IBM PC: 1) 2780/3780 Bisync Emulation package; 2) Advance Com. card - Async, Bisync, SDLC, HDLC; 3) Expansion parity memory - 64K-256K; 4) Disk++ (memory, Async & disk host adaptor); 5) Original Memory Combo; 6) Async Communication Card - (1 or 2 ports); 7) Wire Wrap Card (13.1" X 4"); 8) Extender Card.
Ask for AST products at your local Computerland stores.

AST
RESEARCH INC.

2691 Richter Ave., Suite 104, Irvine, CA 92714 (714) 540-1333

Circle 4 on Inquiry card.



Dealer inquiries welcome

Vive la Difference.

Micros may all seem alike with their Z-80 logic, S-100 bus, and CP/M® operating system.

Until you take a hard look.

Only Delta is the "Private Computer." You won't find it in some department store. We market exclusively through systems integrators who add value to our product.

Delta fields a complete product line, from single-user systems to 64-user distributed processing networks.

Delta offers an expanding software library; engineering and software development assistance; extensive factory service and support.

Delta's flexible financial program keeps you in business, keeps your profits up.

Some of our competitors may claim there's not much difference between us and them.

But Vive La Difference.*



DELTA
PRODUCTS
INC.
15392 Assembly Lane
Huntington Beach, California 92649
(714) 898-1492
Telex: 681-367 DELTMAR HTBH

*See it, believe it. Send for Delta's half-inch video tape promo today (specify Beta or VHS).

®Registered trademark of Digital Research
Circle 142 on inquiry card.

hope of the project staff that the two-volume report, with its analysis of student learning and many examples of student projects, could be an effective resource for teachers working in less ideal settings. The report was also intended as the basis of a Logo curriculum to be developed in subsequent projects.

The second Brookline Logo Project was also funded by the National Science Foundation to develop a curriculum supporting classroom use of Logo. Computers were placed in classrooms from grades four through eight. Teachers were provided with a small amount of training, and the project developed curriculum materials to be used by students and teachers. During the project, two computers circulated among several classrooms. Each classroom had exclusive use of a computer for 8 to 12 weeks. During this time, students worked on their own at the computer, individually or in pairs, while the rest of the class went on with its regular work. About once a week, the entire class met for a lesson at which

ideas would be shared, new concepts introduced, and assignments given.

The curriculum materials developed by the project are at two different levels: an introductory Logo curriculum for grades four through six, and a set of advanced Logo projects based on playing and modifying a set of "dynaturtle" games. The introductory curriculum includes step-by-step instructions for students, as well as a number of different types of project ideas. Teachers are given information about everything from the physical arrangement of the computer in the classroom to the concepts the students will be learning, suggestions for whole class lessons, and a checklist to help them monitor student progress.

The advanced activities focus on a series of dynaturtle games that can be used in two different ways. The games provide a microworld in which students can explore the behavior of the dynaturtle—a Logo turtle that has been programmed to follow Newton's Laws of Motion. Each game introduces a new factor to be considered.

The first game involves making the dynaturtle hit a target, which forces a student to learn to control its momentum and understand something about how the vector quantities of force and momentum are combined. The second game involves driving the dynaturtle around a circular racetrack, introducing some of the concepts involved in orbital motion. The third game, a version of the familiar Lunar Lander, introduces the effect of gravity. The booklet accompanying the games contains many suggestions and challenges for the students that are designed to help them understand the physics concepts embedded in the games. (Also, see R. W. Lawler's "Designing Computer-Based Microworlds," in this issue on page 138.)

Another method for using the dynaturtle games is as a programming project. The games are deliberately designed to be simple so that they lend themselves to many obvious improvements. Every student who has played them has had ideas for making them better and more interesting. A student booklet

MICRO-TAX* PRODUCES GREAT RETURNS

On Your Microcomputer Investment

Up until now, you might have thought that microcomputers weren't powerful enough to handle those returns you send off to your computer service bureau each tax season. Micro-Tax™ and your microcomputer with CP/M* changes all of that.

With Micro-Tax™ you can save time and have the complete security of total in-house, computerized tax preparation. Nothing ever leaves your office. You won't give up versatility and power either. Micro-Tax™ computes and prints over 30 schedules and forms for multiple clients, even partnership and corporate returns. Micro-Tax™ can also compute depreciation by individual items or groups as well as handling the accelerated cost recovery system. Underpayment penalties, self-employment taxes, minimum and alternative minimum and maximum taxes as well as income averaging are all computed automatically. Plus, each tax season Micro-Tax™ can provide you with an update package quickly.

Micro-Tax™ is friendly. Data entry is organized very much like the sequence you use in manual tax preparation. It's flexible too, because you can jump to a specific form and complete

	1982 SCHEDULES AND FORMS INCLUDED		
	Level 1 INDIVIDUAL PACKAGE	Level 2 PROFESSIONAL PACKAGE	Level 3 PARTNERSHIP/ CORPORATE
1040, 1040A	x		
1065, 1120,		x	
1120S			
A, B, C, E, ES,			x
G, SE		x	
D, F,		x	x
K, K-1	x		x
R, RP		x	
1116		x	
2106	x	x	
2119		x	
2210		x	
2220			x
2440		x	
2441	x	x	
3468		x	x
3903		x	
4137		x	
4562			x
4625		x	x
4626			x
4684		x	x
4726		x	x
4797		x	x
4835		x	x
4952			x
4972		x	
5695	x	x	
6251		x	
6252		x	x
6765			x
ACRS		x	x
BATCH		x	x
Print			
Substitute	x	x	x
On IRS			
Forms		x	x
Blank			
Paper		x	x
Continuous			
Preprinted			
Forms			
Trans-	\$195.00	\$1,000	\$1,000
parencies	\$ 50	\$100	\$100
22 state returns covered			
Yearly Updates Available for all 3 levels.			

it rather than starting with the 1040. Just choose the function you want on the Micro-Tax™ menu, and follow

the instructions given by the computer.

Micro-Tax™ is your answer to the already high and increasing costs of computer service bureaus. You will be able to enter data at the time of the client interview and produce returns that look exactly like those required by the government, right in your own office. In the batch mode, you can enter data all day and print returns at night. That's productivity, and it leaves you time for more creative approaches to your client's tax problems.

For more information call your local software dealer or call direct.



MICROCOMPUTER TAXSYSTEMS, INCORPORATED

22458 Ventura Boulevard, Suite E, Woodland Hills, California 91364 (213) 704-7800

*CP/M is a registered trademark of Digital Research
*Micro-Tax is a trademark of Microcomputer Taxsystems, Inc.



\$4/DAY
PER USER

Apple II Computer System
APPLE II
PROVEN VALUE
QUALITY DELIVERY
RELIABILITY
COMPUTER SYSTEMS
BRAND
PRODUCED IN THE HEART OF SILICON VALLEY, CALIFORNIA U.S.A.

OPEN FOR BUSINESS... THE NEW ALTOS ACCOUNTANT.

Introducing the complete multi-purpose, multi-terminal desktop business accounting system with a built-in tutor.

Get everything you need to computerize your business. An ALTOS® Series 5 computer (including 5 MByte Winchester hard disk and 1 MByte floppy), three of our new smart terminals and a printer.

You also get the new ALTOS ACCOUNTANT, a completely integrated business accounting system that includes applications for general ledger, accounts payable, accounts receivable, inventory control, payroll, job costing and order processing.

There's more. You get the unique ALTOS COMPUTER TUTOR, the self-teaching tutorial that provides simple, self-paced, step-by-step training that makes using the computer easy.

Best of all, you get everything for less than \$4 per day per user.*

Complete hard disk systems start at \$9,980.

An Altos system is like having three computers in one. For example, while your bookkeeper prepares payroll, other users can check inventory, compute cost estimates or produce reports. All at the same time.

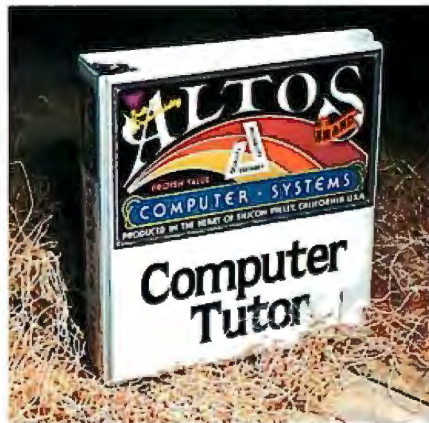

Need more? You can choose from hundreds of popular CP/M® and MP/M II™ applications like word processing, business planning, and communicating with other computers or networks. There's also nationwide on-site service available from your dealer.

Join the thousands of businesses that already rely on Altos. For more information, call our toll free number or write: Altos Computer Systems, 2360 Bering Drive, San Jose, CA 95131. We'll put you in touch with your local Altos sales and service dealer who'll introduce you to your very own ALTOS ACCOUNTANT.

Packed with fresh ideas for business

ALTOS
COMPUTER SYSTEMS

800-538-7872
(In Calif. 800-662-6265)

*Complete 3 user system for \$4 per day per user. Price approximate and may vary in your area. Daily lease based on \$12,800 principal, 20% annual interest, five-year term. Packaged system includes Altos Series 5-SD computer with 5 MByte Winchester hard disk and 1 MByte floppy, a draft quality printer, three Altos smart terminals, and the ALTOS COMPUTER TUTOR software package. Price does not include tax, installation, additional training and maintenance.

ALTOS is a registered trademark of Altos Computer Systems.
CP/M is a registered trademark and MP/M II is a trademark of Digital Research, Inc.

© 1982 Altos Computer Systems

Circle 17 on inquiry card.

provides detailed suggestions for making a series of changes in each game. Students who have already learned simple Logo programming can learn some of the intermediate features of the programming language while using these games as models for the construction of elaborate programs from small modules. Students who have gone through these projects are ready to tackle any number of interactive programming projects of their own devising.

Curriculum materials developed during the project are not yet publicly available. The MIT Logo Group is seeking a commercial publisher for them in accordance with the requirements of the National Science Foundation.

One of the most interesting aspects of the second Brookline Logo Project was the way in which students emerged as Logo teachers. Because there was a group of "student experts" at the beginning of the project, seventh graders who had participated in the first project, teachers

incorporated these students as tutors into their planning from the start.

As the project went on, certain students from this group (and others) became known as experts at Logo programming and at managing the computer systems. Teachers throughout the school routinely began to ask these students for help when necessary. When the youngest students in the school, the fourth graders, were introduced to Logo, each student was assigned an upper-grade tutor for the first few weeks. Thus, the fourth graders developed a quick proficiency with the mechanics of the system and were able to begin their own projects very quickly.

A related aspect of the project was the way that students in the same classroom worked together on Logo activities. During the first Brookline Project, student interaction had been limited by the arbitrary manner in which groups were assigned to the laboratory. In the classrooms, students formed natural groupings to share ideas and help each other. Project ideas and "secret knowledge" of

how to do certain things were passed among the students by word of mouth. The result of using students as teachers and working partners was a reduction in the teachers' role as source and authority, and the creation of a student-based Logo culture.

It had been assumed at the start that *teacher* knowledge would be a major limiting factor in what the students could achieve. It turned out that this was not the case. The limitations on *student* knowledge were what limited what other students could learn. A strategy was devised to support the transfer of knowledge from student to student. Once a week, an after-school student interest group met to work on projects and share ideas. This gave the students involved an opportunity to further their own Logo knowledge, to increase their store of project ideas, and to develop more consistent ways of thinking about how Logo works. All this made them much more effective in their informal role as spreaders of the Logo culture.

Because the project focused

"The Perfect Marriage"

ARBA Register and Accounting Plus*

Great hardware now with superb software. ARBA register, the affordable, dependable RS232 on line cash register. Accounting Plus* Inventory Control software, comprehensive, timely, accurate. The ARBA point of sale software module that brings the two together. The ability to integrate on line real time inventory control with a total business package: G/L, Payables, Receivables, Payroll, Purchase Order, Budgeting, L/Y Comparisons, Electronic Spread Sheet.

ARBA

ARBA Fine Business Computing Corporation
890 E. Roosevelt Road
Lombard, Illinois 60148
(312) 620-8566

ARBA Register—\$1295.00—Suggested Retail

Dealer Pricing Available



Runs under CP/M ** or MP/M **



* TM Software Dimensions, Inc., Citrus Heights, Ca.
** TM Digital Research, Pacific Grove, Ca.

Your guide to the world of microprocessors.

The Micro-Professor™ - A low cost tool for learning, teaching and prototyping.

Here in one attractive package and at a price of only \$149.00 is a Z80* based microcomputer to lead you step by step to a thorough knowledge of the world of microprocessors.

The Micro-Professor is a complete hardware and software system whose extensive teaching manual gives you detailed schematics and examples of program code. A superb learning tool for students, hobbyists and microprocessor enthusiasts, as well as an excellent teaching aid for instructors of electrical engineering and computer science courses.

But the Micro-Professor is much more than a teaching device. With it you can do breadboarding and prototyping, designing your own custom hardware and software applications with Z80, 8080 and 8085 compatible code.

The standard 2K bytes of RAM is expandable to 4K, and the standard 2K bytes of ROM can be increased to 8K.

All this plus a built-in speaker, a cassette interface, and

sockets to accept optional CTC/PIO. Bus is extendable.

As well as being an exciting learning tool, the Micro-Professor is a great low-cost board for OEM's. Call for details



SSB-MPF Speech Synthesizer Board \$129

A vocabulary of up to 400 words based on the TMS 5200 chip.

EPB-MPF EPROM Programming Board \$169

For all +5V 1KB/2KB/4KB EPROMs. Read/Copy/List/Verify Capability.



BASIC-MPF Tiny Basic \$19

2KB BASIC interpreter with hardware control capability. Machine-code subroutine accessible.

PRT-MPF Printer \$99

A thermal printer with built-in alphanumeric character patterns and Z80 disassembler. 20 characters per line, 0.8 line per second.

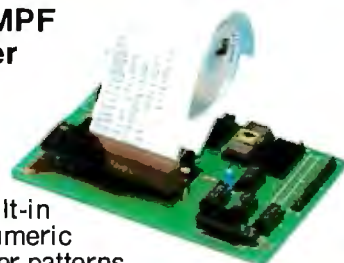

* Z80 is a trademark of Zilog Inc.



Multitech Electronics Inc.

30 day trial period with full refund. 90 day warranty.

Circle 291 on inquiry card.

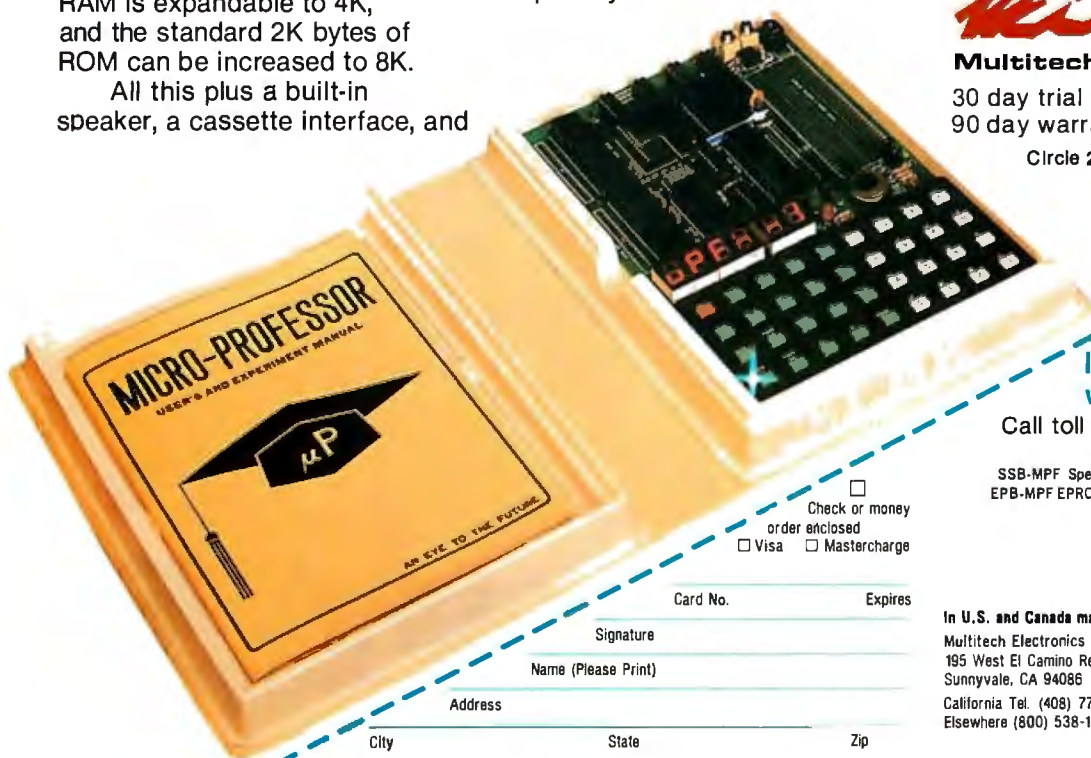

I'm ready to enter the world of microprocessing

Call toll free to order.

	Price	Qty.	Amount
MPF-I Micro-Professor	\$149.00		
SSB-MPF Speech Synthesizer Board	\$129.00		
EPB-MPF EPROM Programming Board	\$169.00		
PRT-MPF Printer	\$ 99.00		
BASIC-MPF	\$ 19.00		
Shipping and Handling	\$ 4.95		4.95
California residents add sales tax.			
TOTAL			

In U.S. and Canada mail to:
Multitech Electronics Inc.
195 West El Camino Real
Sunnyvale, CA 94086
California Tel. (408) 773-8400
Elsewhere (800) 538-1542

Outside of North America mail to:
Multitech Industrial Corporation
977 Min Shen E Road 105
Taipei, Taiwan, ROC
Tel. 02-769-1225
TWX 19162 MULTIC.
23756 MULTIC

Check or money order enclosed
 Visa Mastercharge

Card No. Expires

Signature

Name (Please Print)

Address

City State Zip

primarily on curriculum development, there was no opportunity for a study of the role of students as teachers and the impact of this on the roles of classroom teachers as traditional authority figures and sources of all school learning. This type of situation is becoming quite common; students know more about the computers than their teachers because they have more time to develop and share their expertise. The use of students as teachers should be a serious consideration for teachers, researchers, and curriculum developers as computers continue to spread into the schools.

Computers in the Schools— New York City

The Computers in the Schools Project, conducted by the New York Academy of Sciences in collaboration with New York City School Districts 2, 3, and 9, provides teachers with training and support to teach Logo in their own classrooms. The project involves students in grades two through nine from a full range of socioeconomic backgrounds. Like the second Brookline Project, the computers are located in elementary and middle school classrooms. A major difference is that the teachers have had an extensive training period and each

classroom is assigned a computer for the entire year.

The project began in the summer of 1980 with a three-week training program for 11 teachers and a principal. An expanded training program in the summer of 1981 included eight more teachers from each of the three school districts. During the year, project staff members made weekly visits to each participating classroom. Teachers also attend a monthly seminar held at the New York Academy of Sciences.

Although the project has not yet published any progress reports, the staff believes it has been successful in

For The Best In Price, Selection and Delivery,

Call Now TOLL FREE 800-368-3404

(In VA, Call Collect 703-237-8695)

AMPEX • INTERTEC • TEXAS INSTRUMENTS • GENERAL DATA
COMM. • ANDERSON JACOBSON • C. ITOH • QUME • BEEHIVE •
DATASOUTH • DIABLO • CENTRONICS • NEC • PRENTICE

INTERTEC:

64K DD* **ONLY \$1975**
64K QD* **ONLY \$2350**
64K SD* (96TPI) .. **ONLY \$2750**

*(includes M/Soft BAS
DDS-10 Meg
(Hard Disk) **LY \$3195**

NEC:

7710 \$2196
7715 Call for Special Price
7730 \$2196
7720 Call for Special Price
7725 Call for Special Price
Std. Forms Tractor \$ 200
3510 \$1690

DATASOUTH:

Call
DIABLO: 630-R102 \$1995
630-R110 \$1795
630-R153* \$1745

*(for IBM P.C., Apple II, TRS-80)

630-K104 (KSR) \$2385
620-SPI \$1195

QUME:

Sprint 9, 35 KSR \$1840

Sprint 9, 45RO, Lim. Pan. \$1845
Full Panel \$1969
Sprint 9, 55 F.P.Ex.Mem. \$2186
Sprint 9,55RO, Ltd. Ex.Mem. \$2095
Bi-Dir. Forms Tractor \$ 199

Dialogue 30 \$ 775
Dialogue 80 \$ 939

BEEHIVE: (SMART DISPLAY)

DM5 Call
DM5A Call
DM310 (3101 Emulator) Call

NOTE: IBM and Burroughs compatible terminals available. Please inquire.

C. ITOH

CIT 101 \$1350

TEXAS INSTRUMENTS:

745 Standard \$1390
745 Std. (Recondi) .. Call
810 Basic \$1249
810 Package \$1439
820 Package RO Package . \$1610
820 KSR Package Call
840 RO Basic \$ 795
840 RO Tractor Feed Pkg. . \$1059

ERS

CE STAR: 300 Bd. . \$ 124

QUME:

Data Trak 5 . . . \$300 or 2 for \$549
Data Trak 8 . . . \$525 or 2 for \$999

BISYNC-3780 \$ 769
Wordstar \$ 289
Data Star \$ 199
Mail Merge \$ 99
Spell Guard \$ 229
Plan 80 \$ 249
Super Calc \$ 249
Wordstar (IBM P.C.) \$ 289
Mail Merge (IBM P.C.) . . . \$ 99
d Base II \$ 529
CalcStar \$ 189
SuperSort \$ 186
Nevada Cobol \$ 176

Special! While They Last!

SOROC TERMINALS

IQ 120 **ONLY \$625**
IQ 130 **ONLY \$525**
IQ 140 **ONLY \$989**

In addition, we can make EIA RS232 or RS449 cables to your order, and supply you with ribbons, printer stands, print wheels, thimbles for all printers listed. And many, many more items. CALL NOW.

All items shipped freight collect either motor freight or UPS unless otherwise specified. VISA and MasterCard welcomed; add 3% for credit card purchases. Virginia residents, add 4% Sales Tax. For fastest delivery, send certified check, money order or bank-wire transfer. Sorry, no C.O.D. orders. All equipment is in factory cartons with manufacturers' warranty (honored at our depot.) Prices subject to change without notice. Most items in stock.



TERMINALS TERRIFIC



Terminals Terrific, Incorporated, P.O. Box 216, Merrifield, VA 22116, 800-368-3404 (In VA, Call Collect 703-237-8695).

One Concept 1000 Supports 16 CP/M User Stations



Expandable, Multi-Processor, Multi-User, Multi-Tasking Microcomputer System

Here's computer power from Columbia Data Products that grows as your requirements grow. It's the new Concept 1000 . . . featuring a wide variety of computer resources. Expandable RAM and ROM storage, data communications interfaces, floppy and Winchester disk drives and printers . . . all shared by up to 16 users via a host processor system in a master/satellite configuration. Each user works with a fully-dedicated Z-80A, 64K microprocessor system with dual RS-232 or RS-422 serial ports in a complete CP/M[®] environment. Multi-processing is managed by Digital Research's MP/M[®] and CP/NET operating systems. You can start with the Concept 1000 . . . and stay with it. It grows with you. Contact us for more information on our newest Concept—the 1000.

COLUMBIA

DATA PRODUCTS, INC.

Home Office:
8990 Route 108
Columbia, MD 21045
Telephone 301-992-3400
TWX 710-862-1891

West Coast:
3901 MacArthur Blvd.
Suite 211
Newport Beach, CA 92660
Telephone 714-752-5245
Telex 692 310

Europe:
P.O. Box 1118
4050 Moenchengladbach 1
West Germany
Telephone 021-81-33159
Telex 862 452

90 to 95 percent of the classrooms involved. In a conversation with project coordinator Michael Tempel, he defined "success" in the following terms: "The positive educational benefit was obvious! Kids were engaged in valid intellectual and social processes. You could see them developing. . . . We have seen striking changes in kids' relationships to schools and learning; kids who had not been successful in school got turned on."

Like the second Brookline project, the Computers in the Schools Project found that interaction among students has been a major positive consequence of having Logo in classrooms. Although Tempel stressed that to remain effective the Logo environment requires "measured and periodic input from the teacher," he has been struck by how much work the students do without teacher intervention. The activity "has a real quality of self-sufficiency" for the students.

One important condition of the project has been the insistence that each classroom have at least one computer for an entire year. Tempel believes that access to computers has been a major element in the success of the project. Another condition was that all the teachers involved had to volunteer for the project and take the summer training without additional pay. This helped ensure that teachers had a direct personal stake in the project. Such factors should not be

underestimated when comparing this to other Logo projects or considering it as a model for implementing Logo in other school districts.

When the formal project ends this year, the teachers who have already been trained are expected to carry out future training and support activities on their own. Teachers in each of the three districts will have the responsibility for training and support in their own district. The Logo Learning Center, established by Logo Computer Systems Inc., will function as an informal meeting place, providing a mechanism for teachers to stay in touch, share ideas, and receive additional training.

The future of the Computers in the Schools Project itself involves an ambitious proposal to create a "magnet school" for the three districts in which the students would have access to computers from the earliest grades. With specially trained volunteer teachers, the school would be a focus for Logo-related research and curriculum development. This project has received the support of the three school districts involved and is presently in the proposal-development stage. Since costs for equipment, research, and curriculum development will be far beyond what can be provided by the school system, the New York Academy of Sciences is seeking support from a number of different groups. It hopes to be able to start with a small number of students this fall.

The Lamplighter School Logo Project

The most ambitious Logo project to date was carried out jointly by the MIT Logo Group, Texas Instruments, and the Lamplighter School, a private school in Dallas, Texas. Lamplighter School has 400 students between the ages of 3 and 9. The school has been provided with 50 Texas Instruments Logo systems that are used throughout the grades. The goal of the project is to establish a setting in which student access to computers would not be a limiting factor and to see what students could learn in such circumstances.

The project is now in its third year. A half-time teacher/coordinator oversees the day-to-day workings of the project and provides individual Logo tutorials for every teacher in the school on a biweekly basis. Computers are in every classroom from the nursery school through fourth grade. Every teacher and child is involved to some extent.

On a recent visit to the school, I was struck by just how comfortable the children are with the computers. Two 4-year-old girls were using a computer to construct geometric designs on a screen with square-shaped sprites. (A sprite is a hardware implementation of a turtle, to allow multiple moving objects on the screen.) Nearby, classmates were engaged in more conventional activities: building with blocks, putting together a puzzle, playing with toy

CP/M USERS LOOK OUT: S/S-PASCAL IS FASTER

	Execute (seconds)	Total Size (bytes)
S/S-PASCAL	12.5	1117
PL/I 80 *	14.0	5977
PASCAL MT +*	19.0	3043
PASCAL/Z *	109	3328

AND REQUIRES ONLY 32K OF MEMORY

S/S-PASCAL Version 3.0 for 8080/8085/Z80

Write to get the whole story, or better send \$30.00 for
 — Demo discette with compiler (READ statement not included) and sample programs
 — Tutorial manual (over 100 pages)

DON'T TAKE OUR WORD FOR IT, compile your own programs and test them before buying full compiler

S/S-PASCAL Version 3.0: \$295 - Demo discette: \$30

- Standard PASCAL features plus
- Generates optimized native code
- Compiles directly into .com file
- External assembler subroutines
- Random access files
- 14 digit BCD floating point reals
- Chaining and overlays
- Dynamic strings
- Powerful string manipulation
- Direct access to memory
- Address and size functions
- NEW, DISPOSE, MARK, RELEASE and more . . .

"We answer all inquiries the same day"

Dealer inquiries welcome.

Re: BYTE, September 1981, page 180
 A high level language Benchmark

* CP/M, PL/I 80 TM of Digital Research
 PASCAL MT + TM of MT Microsystems
 PASCAL/Z TM of Ithaca Intersystems

FMS-80. THE TWO DOOR DATA BASE PLUS

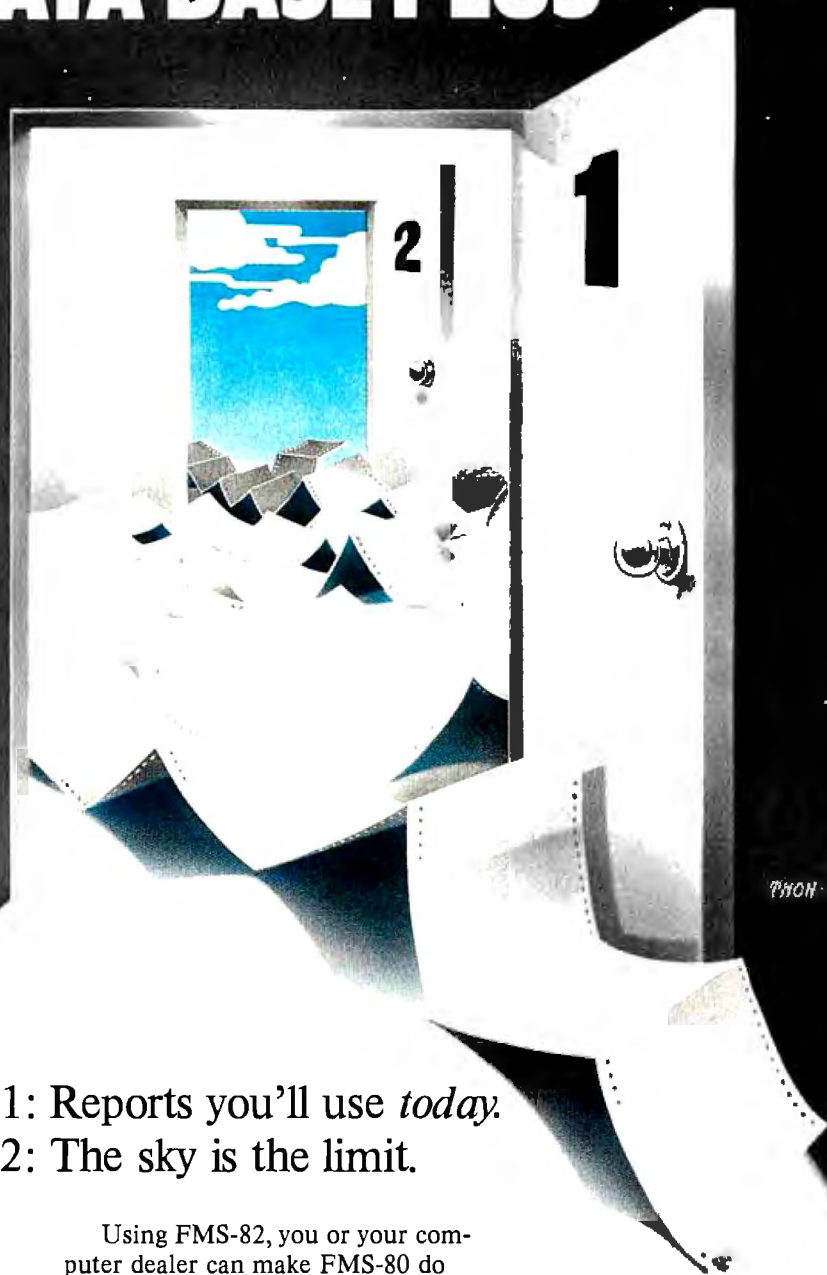

Door # 1: Reports you'll use *today*.
Door # 2: The sky is the limit.

We've split the proven, best-selling FMS-80 micro data base manager into two parts. And we've split the price.

Part one (FMS-81) gives you the essential file and reporting features. You can quickly create programs with input questions a clerk can understand, and with reports a manager can use.

And FMS-81 with its new manual, is so easy to use, you'll be generating reports the first day. FMS-81 sells for \$495.

Part two (FMS-82) has all the fancy stuff. Including an Extended File Maintenance language that lets you perform virtually unlimited manipulation on up to 19 different data files simultaneously.

Using FMS-82, you or your computer dealer can make FMS-80 do *just about anything*. FMS-82 sells for \$495.

Naturally, FMS-82 is fully compatible with all the files and functions you generate with FMS-81.

FMS-81 is so useful, it might seem like you'll never need FMS-82.

But as you expand your use of computers, isn't it nice to know it's there?

The FMS family runs under CP/M, MP/M, CDOS, and Turbodos. Call or write today for a brochure detailing the extensive capabilities of the Two Door Data Base Manager, and the name of your nearest dealer.

You'll be impressed.

Systems Plus, Inc.

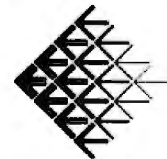

1120 San Antonio Road
Palo Alto, CA 94303
(415) 969-7047

a *djr* product
DJR Associates, Inc.
2 Highland Lane
North Tarrytown,
NY 10591

FMS-80, FMS-81, FMS-82
TM DJR Associates
CP/M, MP/M TM Digital Research
CDOS TM Cromemco
Turbodos TM Software 2000, Inc.

Circle 392 on Inquiry card.

cars, playing house, and finger painting. Computers for these young students are just another way of exploring their world.

The typing ability of the first and second graders is amazing. The students are already writing simple programs, using the keyboard and the Logo screen editor with great dexterity. One second-grade "hacker" had just invented a procedure that simulated the effect of the reset key, clearing the screen and printing "Welcome to Logo!" He also proudly pointed out, "It doesn't erase your procedures!"

In the third grade, several children were clustered around two computers. One of them had made a "secret" animation program that made a number of sprites move continuously in a dynamically unfolding spiral. Three boys were trying to duplicate the procedure on the adjoining computer. Another child was designing a sprite shape for the center of the screen that would look as if it were emitting the spiraling sprites.

Competition, cooperation, communication, problem solving, programming, geometry, and artistry were all happening at once. Meanwhile, the teacher who had introduced the basic idea that all the students were building on was helping another student figure out how to make a sprite move in a circle.

These vignettes should give a sense of the flavor of the school. While some children are occupied with computers, regular school life goes on for others. The class next door may have five computers sitting idle while a geography or reading lesson is being presented much as it would be in any other school. Computers are accepted by the teachers and students as an integral part of the school, but they are not allowed to dominate it.

Some of the anticipated results of the Lamplighter Project have never happened. For example, the students have not used computers for creative writing, despite the availability of a simple screen editor as part of the Logo system. The equipment pro-

vided to the school in the first three years of the project has not included printers, which would be needed to make creative writing a realistic activity. Nor has Logo been integrated into as much of the school's curriculum as had been planned. According to Lamplighter's headmistress Pat Mattingly, "The teachers just don't have enough time for curriculum development in addition to all their other duties." With a few minor exceptions, the research studies that were expected to be part of the project have not materialized. Some unique, exciting, and wonderful things have been happening at the Lamplighter School, but except for the school staff, who usually are too busy to write, study, and reflect on the situation, one gets the feeling that "nobody's watching."

Other Interesting Projects

To round out the picture, I want to mention some other schools at which Logo is being used for research and development. The Cotting School for the physically handicapped in Boston has been the site of a series of projects conducted by Dr. Sylvia Weir of MIT. In these projects, Logo has enabled students with cerebral palsy, previously unable to communicate effectively, to begin to realize their intellectual potential. Of all the Logo projects, this has been the most dramatic in demonstrating Logo's effectiveness for students who previously had not been successful in academic settings. It has also made the most significant progress toward the goal of finding objective ways of determining just what students learn as they engage in Logo activities.

Another Logo project aimed at discovering what students are learning is being conducted by the Center for Children and Technology of Bank Street College in New York City. In this project, students in grades three through six have extensive access to Logo. The research is focusing on students learning problem-solving techniques and on social interaction among students as they work on Logo activities—two areas that have been highlighted, but not carefully studied by other projects.

THE PROGRAMMABLE CUBE™

The Programmable Cube is like the popular physical game: it comes in many colors, you can turn its faces and rotate it, you can scramble it and solve it by moving the faces. It even comes with a complete solver for any scrambled cube. But it has an extra twist: it speaks a language especially designed for cubes through which you can write your own cube programs, either to produce fancy patterns or even to solve a scrambled cube with your own cube-solving strategy.

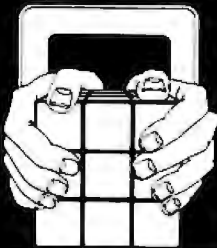

- High resolution graphics, color or black and white, shows all 6 sides and simulates motion.
- Tell it about your scrambled cube—it will lead you through the solution.
- Write your own cube programs: comes with complete programming environment including editor and debugger.
- Available for Apple II® or Apple II Plus®, 48K or 64K. Apple is a Trademark of Apple Computer, Inc.

How to Order:
Send \$34.95,
Check, VISA or
MasterCard to:
Specify 48K or 64K.



METACOMET™
SOFTWARE
P.O. Box 31337, Hartford, CT 06103

Logo Information Sources

Here is a partial listing of organizations that offer Logo training and information:

1. Logo Training Courses and Workshops:

Austin College, Sherman, TX 75090. Contact Prof. Henry Gorman.

Bank Street College, 610 West 112th St., New York, NY 10025. Contact Karen Scheingold.

Lesley College, 29 Everett St., Cambridge, MA 02138. Contact Nancy Roberts.

Logo: The Learning Center, Logo Computer Systems Inc., 989 Avenue of the Americas, New York, NY 10018. Contact Mike Tempel.

Teachers College, Columbia University, Microcomputer Resource Center, 525 West 120th St., New York, NY 10027. Contact Karen Billings.

Technical Education Research Centers, 8 Eliot St., Cambridge, MA 02138. Contact Robert Tinker.

University of Wisconsin—Oshkosh,

Microcomputer Applications Group, Oshkosh, WI 54901. Contact Don Voils.

2. Organizations, Users' Groups, and Newsletters:

Boston Computer Society Logo Users Group, One Center Plaza, Boston, MA 02108.

FOLK, Friends of LISP/Logo and Kids, 436 Arballo Dr., San Francisco, CA 94132.

Friends of the Turtle, POB 1317, Los Altos, CA 94022.

Logo Times, included in 99'er Magazine, POB 5537, Eugene, OR 97405.

LOGOPHILE, Logo Special Interest Group, c/o Higginson, Faculty of Education, Queens University, London, Ontario, K7L 3N6 Canada.

Monadnock Area Logo User's Group, c/o Dan and Molly Watt, Gregg Lake Rd., Antrim, NH 03440.

Young People's Logo Association, 1208 Hillside Dr., Richardson, TX 75081.

A third interesting Logo school project is not a research project at all. At Lincoln-Sudbury Regional High School in Sudbury, Massachusetts, students learn Logo as the introductory computer programming language. Experiences at Lincoln-Sudbury may show the way to those seeking to use Logo with older students.

Conclusions

I will take the risk of drawing a few general conclusions from these very diverse projects.

Logo can be effective for all students in a school setting. In fact, a regular theme of all the projects cited is the success of students who previously had been unsuccessful in school.

Teacher training is critical. At the very least, teachers need to understand the value of exploratory learning and student interaction. Further, at all sites involving Logo in classrooms, teachers have felt the need for

continued support and training. While this need may diminish as teachers become more familiar with computers and Logo, it seems to be a reality for the present.

Teachers and students need resource materials, guidebooks, project suggestions, etc. The more specific the goals, as in the Edinburgh Logo Project or in the physics activities of the Brookline Logo Project, the more specialized and extensive the materials needed.

Student interaction has been a critical and positive element of all classroom-based Logo projects. In each case, students have taken on significant roles as teachers of other students, even as teachers of their own teachers.

In no case has the "full potential of what might be possible" with Logo been realized. It will probably take a lot of time, and many diverse efforts, before the learning potential of Logo can be fully understood and utilized. Whether the goal is to integrate Logo into existing school subjects or to use

IBM

personal computer

UCSD

p-System™ IV.1

A superior implementation of the UCSD p-SYSTEM is available NOW for your IBM Personal Computer.

Network Consulting has added many features that the professional programmer will find useful. These features are not available from any other sources.

- Hard disk support for Corvus, Tall Grass Technology and others
- 25% more floppy storage, without adding or modifying hardware, retaining compatibility with standard IBM diskettes
- Double sided and double sided/double tracking stepping floppy disk drive support
- Up to 800K on each mini-diskette
- RAM disk support (a pseudo-floppy volume that uses up to 512k RAM)
- 8086/87/88 macro assembler
- Extended memory support
- Adaptable system support available for adding custom I/O drivers
- Remote Terminal support
- XON/XOFF flow control for serial printers
- A library of program modules and other utilities
- Disk write verification
- and more!

Standard p-System features include:

- Standard I/O redirection (including command files)
- Dynamic program overlays
- Support for asynchronous processes and concurrency primitives in Pascal
- Fast Pascal p-code compiler
- Fast FORTRAN and Basic p-Code compilers also available
- A powerful screen oriented editor
- A filer for handling both files and volumes
- A Native Code Generator that processes your Pascal, Fortran and Basic programs to convert parts of them to native machine code
- Dynamic runtime binding of separately compiled programs and units
- Turtlegraphics for easy graphics displays
- Print spooler for background printing
- Symbolic debugger

**UCSD p-SYSTEM from
Network Consulting**
The only serious choice for business

TM The Regents of the University of California



Network Consulting Inc.
A106 - 1093 W. Broadway
Vancouver, B.C.
Canada V6H 1E2
(604) 738-3500

Logo to develop entirely new kinds of learning environments, much work remains to be done.

During the past year, the use of Logo in schools has jumped from less than a dozen sites to hundreds. By the end of the coming year, it may involve thousands of classrooms with tens of thousands of students. As we struggle with the task of integrating new forms of learning into old structures, we should be particularly aware of the opportunity to learn from each other and from the limited, but carefully supported, research and development that have already occurred. ■

References

1. The Edinburgh Logo Project, Department of Artificial Intelligence, University of Edinburgh, Forrest Hill, Edinburgh, EH1 2QL Scotland.
du Boulay, B. "Learning Teaching Mathematics." *Mathematics Teaching*, No. 78, March 1977.
du Boulay, B. *Teaching Teachers Mathe-*

matics Through Programming. DAI Research Paper No. 113, 1979.

du Boulay, B. and T. O'Shea. *How to Work the LOGO Machine: A Primer for ELOGO*. DAI Occasional Paper No. 4, 1976.

Howe, J. A. M. and T. O'Shea. "Learning Mathematics Through Logo." *ACM SIGCUE Bulletin*, Vol. 12, No. 1, January 1978.

Howe, J. A. M., T. O'Shea, and F. Plane. *Teaching Mathematics Through Logo Programming: An Evaluation Study*. DAI Research Paper No. 115, September 1979.

2. The Brookline Logo Project, MIT Logo Group, Building 20C, Room 109, Massachusetts Institute of Technology, Cambridge, MA 02139.

Bibliography of Logo Memos. MIT Logo Group.

Papert, Seymour, et al. *Assessment and Documentation of a Children's Computer Laboratory*. Logo Memo 48, MIT Logo Group, 1977.

Papert, Seymour, Andrea diSessa, Daniel Watt, and Sylvia Weir. *Final Report of the Brookline Logo Project: Project Summary and Data Analysis*. Logo Memo 53, MIT Logo Group, 1979.

Watt, Daniel. *Final Report of the Brookline Logo Project: Profiles of Individual Student Work*. Logo Memo 54, MIT Logo Group, 1979.

Watt, Daniel. *A Comparison of the Problem Solving Styles of Two Students Learning Logo*. Proceedings of the National Educational Computing Conference, 1979. (Reprinted in *Creative Computing*, December 1979.)

Watt, Daniel and Sylvia Weir. "Logo: A Computer Environment for Learning Disabled Students." *The Computing Teacher*, Vol. 8, No. 5, May 1981.

3. Computers in the Schools, Bonnie Brownstein, Director, New York Academy of Sciences, 2 East 63rd St., New York, NY 10021.
4. Lamplighter School, Headmistress Pat Mattingly, 11611 Inwood Rd., Dallas, TX 75229.
5. Logo for Handicapped Students. Goldenberg, E. Paul. *Special Technology for Special Children*. Baltimore: University Park Press, 1979.
Papert, Seymour and Sylvia Weir. *Information Prosthetics for the Handicapped*. Logo Memo 51, MIT Logo Group, 1978.
Weir, Sylvia. *Evaluation and Cultivation of Spatial and Linguistic Abilities in Individuals with Cerebral Palsy*. Logo Memo 55, MIT Logo Group, 1980.
6. Center for Children and Technology, Bank Street College, Karen Scheingold, Director, 610 West 112th St., New York, NY 10025.

PICK A SYSTEM!

We're offering you our SB-80 system in either 5 1/4" or 8" disk drives, your choice. Either way your system comes with a full size (12" diagonal) non-glare tiltable green screen with 24 lines by 80 character format. Its multi-character set offers blinking cursor, underlining, reverse video, and half and zero intensity. The movable, detachable keyboard has a numeric pad with cursor control and function keys.

- Single Board Technology ■ CP/M® Operating System
- 4 MHz Z80A CPU ■ 64K 200ns Main Memory
- 8-Inch Dual Density Floppy Drives
- 5 1/4-Inch Dual Density Floppy Drives
- 2-Serial Ports ■ 2-Parallel Ports
- 4-Counter/Timers ■ Expandable

For further information about this limited offer call or write:



Nationwide on-site and depot repair service through the professionals at INDESERV.

®CP/M is a registered trademark of Digital Research, Inc.

Colonial Data Services Corp., 105 Sanford Street, Hamden, Conn. 06514 • (203) 288-2524 • Telex: 956014

LETTER-PERFECT PRINTER DOUBLES AS DATA CRUNCHER.



**Print two ways...correspondence quality and high speed data processing.
Now priced under \$2000!**

The new T-1805 dual purpose serial printer uses a unique 40 x 18 matrix dot pattern for high quality correspondence printing; or, flip a switch, it uses a 7 x 9 matrix for high speed data processing printing. In the high speed mode, it generates reports at time-saving throughput rates reaching 200 lines per minute. In the reduced speed correspondence mode, its pivoting print head lays down overlapping dots to create a letter-perfect character that looks like it came from an office typewriter.

The T-1805 is the latest evolution in the popular and proven T-1000 series of serial printers. As such, the

T-1805 offers the same quality construction, high reliability, ease of operation and operator conveniences. Plus, for the benefit of the office crew, the T-1805 is exceptionally quiet. Its 53 dbA noise level ranks it as the quietest impact printer on the market.

There's much more to tell, so visit or call your Mannesmann Tally sales outlet today.

Mannesmann Tally, 8301 South 180th Street, Kent, WA 98031. Phone (206) 251-5524.

Printers for the long run.

**MANNESMANN
TALLY**



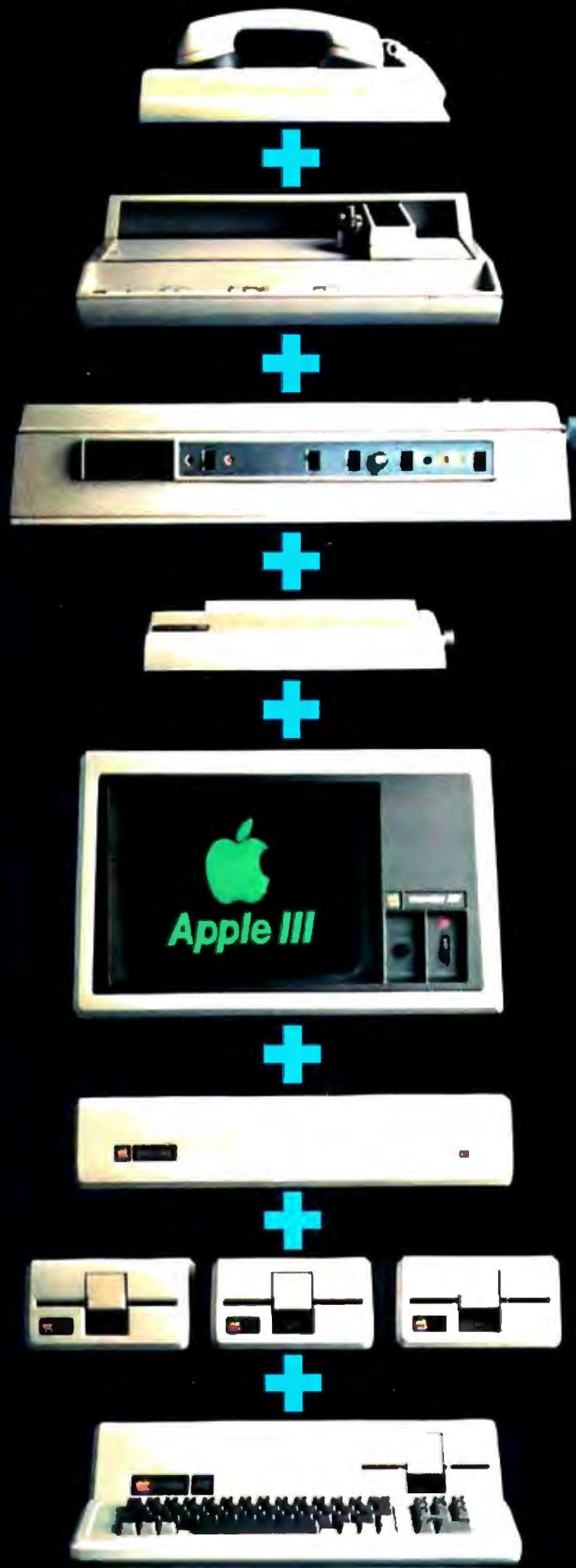

MOST PERSONAL COMPUTERS CAN'T COPE WITH SIMPLE ADDITION.

Because most PC's use their expansion slots for both added memory and peripheral interfaces, you may be forced to choose one or the other. Add memory, lose peripherals. And *vice versa*.

The Apple III was designed with an array of built-in connectors and interfaces that leave you room to grow, even when you upgrade to maximum RAM.

Take a bottoms-up tour of the opposite page, and consider the possibilities.

The Apple III Itself. Its standard 128K RAM is twice what some of the most powerful PC's offer as standard. Upgrade to a maximum 256K RAM, and you've still got four unused expansion slots.

Disk III Drives. Daisy-chain up to three of them with the Apple III's built-in drive, right through a back panel connector, for a total of 560K floppy disk storage.

Our new ProFile™ Mass storage made personal with a very quick, very quiet 5-Mb hard disk. Ideal for software development or data base applications.

Monitor. Shown is our standard Monitor III with its crisp green phosphor display. But the Apple III can drive any popular black and white or color monitor. 16-color graphics capability is standard.

Silentype™ Personal Printer. Very affordable, virtually noiseless, and perfect for rough copy, B&W graphics and quiet offices.

Letter Quality Printer. For professional caliber word processing with Apple Writer III software. The Apple III can drive virtually any printer in any task, from preparing reports to printing forms.

Color Plotter. To make the colorful most of the Apple III's high res graphics in charts, graphs and designs.

Phone Modem. Which, with Access III asynchronous communications software, lets you communicate with other PC's or with mainframes at up to 9600 bps.

Only the Apple III can handle all of the above, all at once, without losing its memory. And even though you may never configure your system just like this, it's important to know how far you can grow. With a couple of OEM Prototyping Cards. Or your own specialized peripherals. Or future technology.

See your authorized Apple dealer for a spec-to-spec comparison of the Apple III and the most muscular new PC's.

You'll find that, even with 256K, most of them just can't stack up.

The personal computer.  **apple**

Call 800-538-9696 (in California, call 800-662-9238) for the authorized Apple dealer nearest you, or for information on our National Accounts Program.
Or write: Apple Computer, Inc., Advertising and Promotion Dept., 20525 Mariani Ave., Cupertino, CA 95014. NOTE: Apple Computer does not currently manufacture or distribute color monitors, graphics plotters or telephone modems. Apple is a registered trademark of Apple Computer Inc.

Designing Computer-Based Microworlds

*Well-designed Logo procedures
can help children grasp ideas of intrinsic interest.*

R. W. Lawler
Le Centre Mondial L'Informatique
et Resources Humaine
24 Rue Clemente Marot
Paris, France 75008

Designing computer applications for education might be called cognitive engineering, for its objective is to shape children's minds. That lofty goal must carry with it a commitment to cognitive science, the study of how knowledge functions and changes in the mind. In light of the profound influence of computers in the schools, designing educational applications without such a commitment would be irresponsible.

I believe that Jean Piaget, the Swiss student of knowledge, formulated the general solution to the problem of how intelligence develops. Although the field of cognitive science has advanced beyond Piaget's innovative theories by revising and extending them, his insights into the nature of learning continue to influence teaching methods. The union of computer microworlds and Piagetian theory is the subject of this article.

Piaget and Education

Central to the work of Piaget is constructivism, the view that the mind incorporates a natural growth of knowledge and that the mind's structure and organization are shaped by interactions among the mind's parts. In *The Science of Education and the Psychology of the Child* (The

Viking Press, 1971), Piaget challenges educators to answer two questions: How does instruction affect what is in the mind? and What remains in the mind from the process of instruction long after the time of instruction has passed? In the same work, Piaget disputes both the effectiveness and the ethical correctness of many of the practices of modern education:

If we desire to form individuals capable of inventive thought and of helping the society of tomorrow to achieve progress, then it is clear that an education which is an active discovery of reality is superior to one that consists merely in providing the young with ready-made wills to will with and ready-made truths to know with.

The Dilemma of Instruction

Given Piaget's view that learning is a primary, natural function of the healthy mind, we might consider instruction in any narrow sense unnecessary. Children (and older students of life as well) learn the lessons of the world, effectively if not cheerfully, because reality is the medium through which important objectives are reached. Nevertheless, in certain situations children often rebel against

the lessons society says they must learn. Thus the educator's ideal of inspiring and nurturing the love of learning frequently is reduced to motivating indifferent or reluctant students to learn what full functioning in our society requires.

Teachers face a dilemma when they try to move children to do schoolwork that is not intrinsically interesting. Children must be induced to undertake the work either by promise of reward or threat of punishment, and in neither case do they focus on the material to be learned. In this sense the work is construed as a bad thing, an obstacle blocking the way to reward or a reason for punishment. Kurt Lewin explores this dilemma in "The Psychological Situations of Reward and Punishment" (*A Dynamic Theory of Personality: Selected Papers of Kurt Lewin*, McGraw-Hill, 1935). The ideas of Piaget and Lewin have led me to state the central problem of education thus: How can we instruct while respecting the self-constructive character of mind?

Computer-Based Microworlds

In *Mindstorms: Children, Computers, and Powerful Ideas* (Basic Books, 1980) Seymour Papert pro-

MICRO

BUSINESS WORLD INC.
Information Line (213) 996-2252
TOLL FREE MAIL ORDER LINES
(800) 423-5886 Outside Calif

SPECIAL OF THE MONTH



HP 41CV
OUR PRICE **\$239.00** *Save 86.00*
MSL 325.00

EXPANSION BOARD
Q STAR
16K RAM BOARD



OUR PRICE **\$99.00** *Save 100.00*
MSL 199.00

MICRO-SCI

APPLE II+ COMPATIBLE DRIVE



W/ CONTROLLER	W/O CONTROLLER
MSL OUR PRICE 549.00 429.00	MSL OUR PRICE 449.00 379.00

Save COMPARE TO APPLE DRIVE **216.00** *Save* COMPARE TO APPLE DRIVE **146.00**

APPLE IS A REG. TRADE MARK OF APPLE COMPUTER

IBM

IBM PERSONAL COMPUTER INCLUDES:



- 2 Drives
- Colour Graphic Board
- 64K Memory

CALL FOR PRICE

*Subject to availability

FRANKLIN 64K ACE 100

APPLE COMPATIBLE INTRODUCTORY OFFER



MSL 1595.00 **Call for Price**

The Franklin ACE 100 is a professional personal computer that is hardware and software compatible with the Apple II+ and includes many features not found on the Apple unit. All programs written for the Apple II will run on the Franklin ACE 100 without modification including those using high and low resolution black and white graphics. The ACE 100 is plug compatible with Apple. All peripherals designed for the Apple II will operate with the ACE 100 without modification.

Franklin ACE 100 Features

- Apple II compatible
- 64K of RAM memory
- Upper and lower case
- Typewriter-style keyboard
- Built-in fan
- Alpha lock shift key
- VisiCalc friendly
- 50 watt power supply
- Built-in fan
- Twelve key numeric pad

LE MONITOR

METAL CABINET SANYO TYPE



9" GRN. PHS. MONITOR
12" GRN. PHS. MONITOR

MSL **OUR PRICE** *Save*
189.00 **\$119.00** 70.00

APPLE II PLUS 48K



CALL FOR PRICE

*Subject to availability

APPLE IS A REG. TRADEMARK OF APPLE COMPUTER

COMPARE OUR COMPUTER

FEATURES	APPLE II	FRANKLIN ACE 100
Computer with 48K RAM Memory	\$1530.00	STD
Microsoft 16K RAM Card (16K RAM Memory)	195.00 (option)	STD
ABT 10 Key Pad	125.00 (option)	STD
Videx Keyboard Enhancer	149.00 (option)	STD
R.H. Electronics Super Fan II (Muffin Fan)	69.00 (option)	STD
TOTAL	\$2068.00	\$1595.00

APPLE IS A REG. TRADE MARK OF APPLE COMPUTER

HP 85

The professional's choice: Hewlett-Packard's HP-85



MSL **OUR PRICE** *Save*
2750.00 **\$1975.00** 775.00

HP 125



OUR PRICE **\$1975.00** *Save 775.00*
MSL 2750.00

DUAL MASTER DRIVE
MSL **OUR PRICE** *Save*
2500.00 1595.00 905.00

XEROX 820

WORD PROCESSING SYSTEM (INCLUDES SOFTWARE)



MSL **OUR PRICE** *Save*
3495.00 **\$2649.00** 846.00

NEC STUDENT SYSTEM 64K



*NEC PC 80001
*NEC PC 8012
*NEC PC 8031
12" Grn. Phs. Video Monitor

MSL **OUR PRICE** *Save*
2839.00 **\$2095.00** 744.00

HP-87



MSL **OUR PRICE** *Save*
2495.00 **\$1749.00** 746.00

Commodore VIC-20



Vic TV Modul \$19.00
Vic Cassette \$69.00
Vic Disk Drive \$ call
Vic 6 Pack program. \$44.00

MSL **OUR PRICE** *Save*
299.00 **\$255.00** 44.00

EPSON



MX 80	MSL 645.00	OUR PRICE 429.00	<i>Save</i> 216.00
MX 80FT	745.00	535.00	210.00
MX 100	995.00	719.00	276.00

Commodore STUDENT SYSTEM



4032 - 32K 40 COL CRT
4940 - DUAL DISK DRIVE

MSL **OUR PRICE** *Save*
2590.00 **\$1978.00** 612.00

RADIO SHACK

48K TRS 80 W/2 DRIVE MOD III



MSL **OUR PRICE** *Save*
2495.00 **\$1799.00** 696.00

1 Year Extended WARRANTY

\$99.00

INQUIRE

SAVINGS SERVICE ELECTION ATISFACTION

WE RESERVE THE RIGHT TO CORRECT TYPOGRAPHICAL ERRORS. THIS AD SUPERCEDES ALL PREVIOUS ADS.

MICRO BUSINESS WORLD WAREHOUSE

18720 Oxnard, #108
Torrance, CA 91356

OUTSIDE CA CALL TOLL FREE 1 (800) 423-5886 IN CA (213) 996-2252

Name (Please print) _____
Address _____
City _____ State _____ Zip _____

Qty	Make	Model	Description	Price	Total

Certified Check or M.O. Allow 2 weeks clearance for personal check
Bank Wire Transfer

CREDIT CARD # _____ Exp Date _____

Signature _____

Tele: 182852
Answer: MICRO T2NA

*California residents add 6% sales tax.
**Add 3% Shipping & Handling - Add 3% surcharge for credit cards. Orders cannot be shipped unless accompanied by payment, including shipping, handling and tax where applicable.

TOTAL ORDER \$ _____
TAX IF APPLICABLE * _____
SHIPPING & HANDLING ** _____
TOTAL ENCLOSED \$ _____

VISA MasterCard

STATUS QUO Presents SPECIAL PRICES

DISK DRIVES

	YOUR COST
XCOMP Hard Disk Drive 10 Mb Formatted	\$3200
SHUGART 851R Dbl Dens Dbl sided 8"	495
APPLE COMPATIBLE MICRO-SCI A2 35 track drive	425
APPLE COMPATIBLE MICRO-SCI A40 40 track drive	399
APPLE COMPATIBLE MICRO-SCI A 70 70 track drive	575
APPLE COMPATIBLE MICRO-SCI Controller for above	100

APPLE PRODUCTS

MICROSOFT Premium Pack	575
MICROSOFT 16K Ram Card	140
MICROSOFT Z80 Card	299
WESPER 16K Ram Wizard Card	95
NOVATION CAT Modem	135
NOVATION D CAT Modem (direct RS-232 connection)	148
NOVATION APPLE CAT II	329
SUP'R'MOD II (converts TV to monitor)	33
RH Super Fan II	55
T.G. Products Joystick	53

SOFTWARE

VISICORP's VISICALC for Apple II	150
MICRO PRO WordStar (Apple II)	195
MICRO PRO WordStar (CP/M)	249
MICRO PRO SuperSort (Apple II)	109
MICRO PRO SuperSort (CP/M)	125
MICRO PRO CalcStar (CP/M)	189
MICRO PRO CalcStar (Apple II)	139
MICRO PRO DataStar (CP/M)	219
MICRO PRO DataStar (Apple II)	199
STONEWARE DB Master	179
IU's Easy Writer 40 Column (Apple II)	89
ASHTON-TATE dBASE II (CP/M)	479
ARTSCI/SOFTAPE Magic Window (Apple II)	79

S-100 PRODUCTS

CALIFORNIA COMPUTER SYSTEMS 2422-Floppy Ctrl CP/M 2.2	323
CALIFORNIA COMPUTER SYSTEMS 2710 4 serial I/O A & T	269
CALIFORNIA COMPUTER SYSTEMS 2065 64K Static Ram A & T	519
CALIFORNIA COMPUTER SYSTEMS 2032 32K Static Ram A & T	621
CALIFORNIA COMPUTER SYSTEMS 2116 16K Static Ram A & T	239
CALIFORNIA COMPUTER SYSTEMS 2720 4 parallel A & T	189
HAYES Micromodem 100	329
HAYES Smartmodem	217
HAYES Chronograph	189

PRINTERS & PRODUCTS

EPSON MX-80 F/T	745
EPSON GRAFTRAX 80	73

MICROCOMPUTER & MONITORS

NEC 8001A Microcomputer w/32K RAM	710
NEC 8012A I/O Unit w/32K, expansion slots	590
NEC 8031A Dual Mini-disk drive unit	710
AMDEK Video 100 (12" B/W)	129
AMDEK Video 300 (High Res Green)	219
SANYO 13" Color	490

CREDIT CARD ORDERS CALL

(800) 227-5414

M-F 9am-5pm PST

All prices are cash prices. Add 3% surcharge when using Master Card, Visa or American Express. California residents add 6% tax. For shipping and handling charges, please add \$2 per item for drives and printers, and add \$10 per item for microcomputer and monitor items. Prices are subject to change without notice.

Make all checks payable to: **STATUS QUO**

(We must allow two weeks for all personal checks to clear so for faster service, please send a money order or cashier's check or order using your credit card.)

STATUS QUO, div. of I.T.A.T. Associates, Inc., 2095 Van Ness Ave., San Francisco, CA 94109. For technical questions or special orders/prices call (415) 474-1007.

Circle 197 on inquiry card.

DEALERS: We purchase excess inventory. Please call us with prices.

poses computer-based microworlds as a general solution to the problem of motivation. One argument for Papert's proposal runs as follows: learning is often a gradual process of familiarization, of stumbling into puzzlements, and resolving them by proposing and testing simple hypotheses in which new problems resemble others already understood. Microworlds are in essence "task domains" or "problem spaces" designed for virtual, streamlined experience. These worlds encompass objects and processes that we can get to know and understand. The appropriation of the knowledge embodied in those experiences is made possible because the microworld does not focus on "problems" to be done but on "neat phenomena"—phenomena that are inherently interesting to observe and interact with.

With neat phenomena, the challenge to the educator is to formulate so clear a presentation of their elements that even a child can grasp their essence. A well-designed computer microworld embodies the simplest model that an expert can imagine as an acceptable entry point to richer knowledge. If a microworld lacks neat phenomena, it provides no accessible power to justify the child's involvement. We can hardly expect children to learn from such experiences until they are personally engaged in other tasks that make the specific knowledge worthwhile as a tool for achieving some objective. This amounts to an appropriate shifting of accountability from students (who have always been criticized for not liking what they *must* learn) to teachers, those who believe that their values and ideas are worth perpetuating.

Computer-based microworlds help tailor instruction more closely to Piaget's idea of the natural mode of learning. I will illustrate this point by presenting two examples of computer-based microworlds.

The POLYSPI Microworld

POLYSPI (from "polyspiral") is a name for a three-line procedure in the Logo language and for the class of de-

Not since Gutenberg invented the printing press...

has there been so much talk about printing!

The Smith-Corona TP-1 Daisy Wheel Printer

\$695⁰⁰

- Microprocessor Electronics
- Serial or Parallel Interface
- Simple, Reliable Mechanism

Act Now: Limited Supply, Low Cost

In the 15th century, a German craftsman and inventor named Johannes Gutenberg originated a method of printing from movable type that was used without significant change until the 20th century.

Today, **Smith Corona**, one of the largest manufacturers of small printers in the world, gives a whole new perspective to printing with their electronic text printer — **TP-1**. Gutenberg would surely approve of the **TP-1**, a microprocessor controlled, high quality **daisy wheel printer**. It produces perfectly formed, executive quality printouts at the speed of 120 words per minute. Typewriter quality printing at dot matrix prices.

Simple, durable and dependable, **TP-1** may be used with word processing systems, microcomputers and most small business systems.

Now, all your letters, documents, forms and reports can have the crisp, professional look you demand — for business or personal use — at an affordable price.

Don't delay. Order your **TP-1** TODAY at the low, low price of **\$695**.

Micro-Printer Marketing offers same day shipping, nationwide service and invites dealer inquiries. Catalogues available. No shipping charges on pre-paid orders.



Additional daisy print wheels \$4.95



Additional ribbons \$2.95

MicroTM Printer Marketing

Circle 266 on Inquiry card.

Call Micro-Printer Marketing

CALL TOLL FREE **1-800-523-9859** MasterCard and Visa Accepted

In PA Call Collect 215 / 433-3366



(1a) POLYSPI 10 60 3

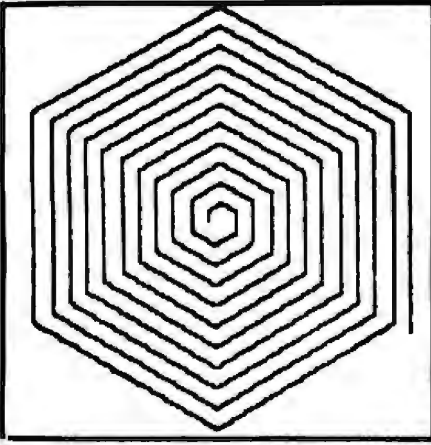

(1b) POLYSPI 10 61 3

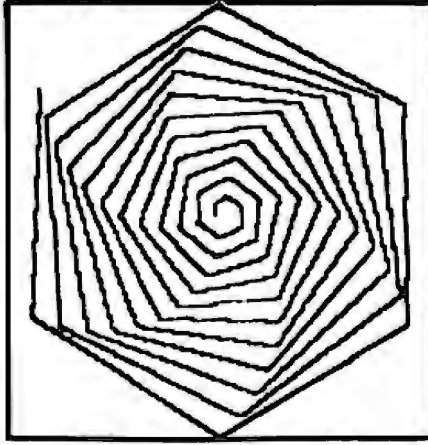

(1c) POLYSPI 10 62 3

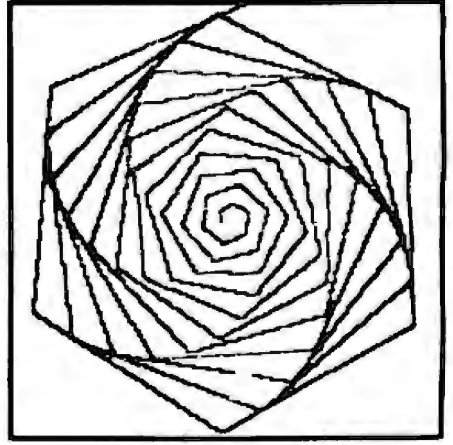

(1d) POLYSPI 10 63 3

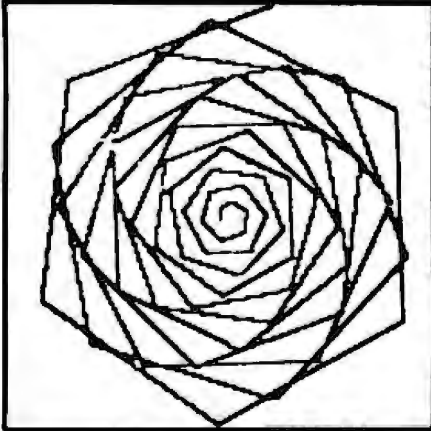

(1e) POLYSPI 10 64 3

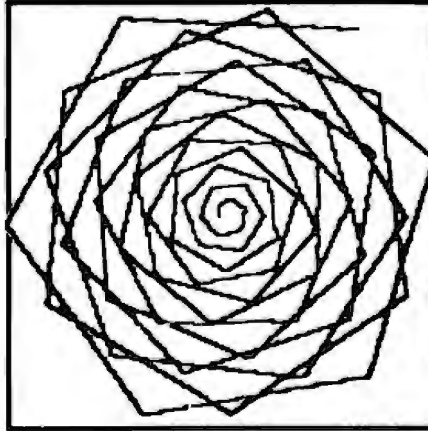

(1f) POLYSPI 10 65 3

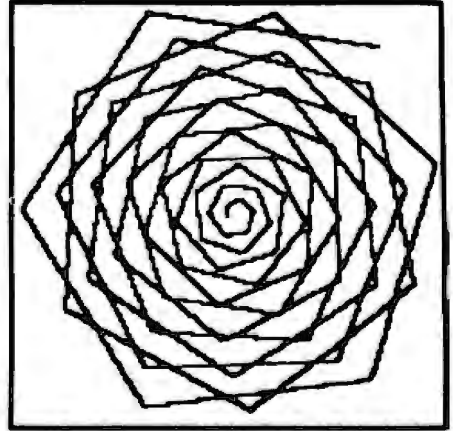

Figures 1a-1f: Polyspiral designs generated by changing one variable of the three in the POLYSPI procedure (shown in listing 1). The procedure's variables are DISTANCE, ANGLE, and CHANGE (in distance). The procedure draws a design by going forward the specified distance, turning at the specified angle, then increasing the distance by the specified change, going forward for the incremented distance at the specified angle, and so on. In this example, the distance variable and the change in distance are held constant. The angle variable is stepped up by one degree in each design. The strikingly different designs show the power of the concept of stepping variables.

signs produced by different executions of that procedure. Figures 1a-1f show some examples of POLYSPI designs. The POLYSPI procedure is stated in listing 1. Some of the designs are pretty, mainly because surprising spiral patterns emerge under certain conditions. The general appeal of POLYSPI designs largely accounts for the adoption of turtle graphics as a subsystem of languages such as Smalltalk, Pascal, and even some implementations of PILOT. The variability of the POLYSPI procedure sometimes permits even a beginner to surprise more expert users (as well as himself) with the discovery of beautiful designs.

The procedure in listing 1 and its designs comprise a microworld. The objects of the microworld are all the designs that the procedure can generate, an engaging and extensive domain for

exploration. More important, the designs are a class of "neat phenomena" whose generation can be made comprehensible with the following small set of ideas. First, the POLYSPI procedure provides a crisp model of variable separation: the three vari-

The POLYSPI microworld reveals the powerful idea of stepping variables.

ables DISTANCE, ANGLE, and CHANGE are each used once, and used differently, in a simple procedure text. Second, the difference in relative potency of the variables (the impact of a unit change on the produced design) is obvious and striking. (ANGLE and then CHANGE are much more potent than DISTANCE.)

The POLYSPI microworld reveals the stepping of variables as a powerful idea. By stepping variables I mean identifying one variable as a dimension of examination and holding all other variables constant while the chosen one is varied incrementally. In short, this microworld provides a clear model of how particular things may be generated through their intersecting dimensions of variation. Piaget judged variable-stepping to be an essential component of formal operational thought. The idea is a powerful one because it is almost universally useful; it is crucial to the process of scientific investigation.

Within the microworlds of turtle geometry, the insights achieved with POLYSPI exploration are easily extended to a related microworld of INSPI designs. The INSPI procedure differs from POLYSPI only in that the

212 for \$695.*



Introducing the 212 Auto-Cat by

300 BAUD is fine for the basics.
But now you can get in the fast lane without getting expensive.

Our engineers have come up with a pair of custom microprocessors, five LSI circuits and a small miracle: the 212 Auto-Cat modem.

And if you've looked around, you know the \$695 price is part of the miracle.

Four times the speed. Half the size. All of the right auto-dial/answer functions.

Your dealer has them right now. No need to waste any more time. See him.



the recognized leader in
personal communications

*Suggested retail price

Circle 305 on Inquiry card.

18664 Oxnard Street, Tarzana, California 91356 • Telephone: (800) 423-5419 and (213) 996-5060

Listing 1: *The POLYSPI procedure, written in Logo. From only three variables—distance, angle, and change in distance—this procedure can generate a remarkable variety of polyspiral designs. The procedure draws by going forward the specified distance, turning at the specified angle, then increasing the distance by the specified change, going forward for the newly incremented distance at the same specified angle, and so on. Some designs drawn by POLYSPI appear in figures 1a-1f.*

```
TO POLYSPI :DISTANCE :ANGLE :CHANGE
FORWARD :DISTANCE
RIGHT :ANGLE
MAKE "DISTANCE :DISTANCE + :CHANGE
POLYSPI :DISTANCE :ANGLE :CHANGE
END
```

change value is applied to the ANGLE variable instead of to the DISTANCE variable. (For a case study of a child's ability to grasp and extend this idea, see my article "Extending a Powerful Idea," in a forthcoming issue of *The Journal of Mathematical Behavior*.)

The BEACH Microworld

The adolescent's initiation to formal thought differs greatly from the preschooler's introduction to reading, yet both learning experiences involve

grasping central representations. What the prereader learns in an alphabetic language is a serial symbolic representation for words that signify the names of objects, actions, and so on. Let me here describe a Logo microworld for learning the alphabetic language. This microworld helped my 3-year-old daughter learn to read with minimal direct instruction.

While previous Logo implementations focused on a single, all-im-

portant agent—the turtle—TI Logo also has sprites. A sprite is a video-display object that has a location, a heading, and a velocity, but no drawing capability. It may be associated with a shape (which it "carries" and which assumes one of 16 colors). The shapes can be easily defined and changed by the Logo user. There may be a maximum of 25 shapes. The importance of a multitude of easily discriminated objects for early language applications cannot be overestimated. TI Logo has a second graphics system, "tile graphics," that is compatible with the sprite graphics system. The static tiles, which may also assume 16 different colors and exhibit modifiable shapes, provide a suitable "background" for the movements of the dynamic sprites. The result is the opportunity to create scenarios that have many moving objects with different shapes and different colors and a static but vivid backdrop. The BEACH microworld permits the creation of such scenarios, as the scenes in photos 1a and 1b illustrate.

Allenbach is putting tomorrow on disks.

The future of the world is written in computer software. And Allenbach disk duplication is making sure that the future is faithfully reproduced. We use our own Allenbach diskettes and state of the art equipment, with electronic surface evaluation of each diskette before use. Copies are 100% verified, track by track, and carry the Allenbach lifetime warranty against defects in workmanship or materials. For information and prices on disks, duplication, and dealer information, please call (800) 854-1515. In California, call (714) 438-2258 collect.



**Allenbach
Industries Inc.**

“Our reputation rests on digits, decimal points, and details. We wouldn't trust them to anything less than Scotch® Brand Data Cartridges.”



**Bill Birkett, Vice President,
Trade Graphics, Inc.,
Livonia, Michigan**

The unique design of a data cartridge provides great reliability, high storage capacity and long tape life. And where could you possibly get better data cartridges than Scotch Brand, made by 3M, the people who invented the data cartridge system itself?

3M controls every step in manufacturing. Top quality magnetic tape and precision components are part of every Scotch Data Cartridge. Over twenty-five years of service to the computer industry assure you of the utmost reliability.

Scotch Data Cartridges are available in miniature DC 100A, the standard-size DC 300A and now, an extra-length DC 300XL with 50% more storage capacity. They are compatible with most cartridge systems including Hewlett-Packard, IBM, NCR, Tektronix and TI.

To find out where you can find Scotch Data Cartridges or virtually any other data recording medium, call toll-free: 800-328-1300. (In Minnesota, call collect: 612-736-9625.) Ask for the Data Recording Products Division.

**If it's worth remembering,
it's worth Scotch
Data Recording Products.**



3M

(1a)



(1b)



Photos 1a-1b: Two scenes from the BEACH microworld. Photo 1a shows a scene with many objects. Photo 1b shows a scene typical of those drawn by a 3-year-old child. The author's daughter learned to read 30 words by exploring the BEACH microworld, which the author and his children created using TI Logo with the Texas Instruments 99/4A microcomputer.

Meaningful Names Ease Learning

Because Logo gives the user great freedom to define and name procedures, appropriate descriptive English words can be used. For example, SUN can be the name of the procedure that creates a yellow ball on the display. The word UP can name the command that increases the value of a sprite's y coordinate. Repeated often enough, UP puts the SUN in the sky above the BEACH. Another word, such as SLOW

or FAST, can set the SUN in motion. Because new procedures are easily defined, the child, a family member, friend, or teacher could even make the SUN ZOOM if the child wishes. Such flexibility permits the microworld to be tailor-made to suit any child. To the extent that the child participates in defining the objects to be part of the world, their attributes, and the actions they are to perform, the microworld is also constructed by

the child herself. My 3-year-old, Peggy, her older siblings, and I chose about 20 objects to populate her world, designed and made shapes to represent them, and wrote the procedures to create and manipulate them. The vocabulary of her BEACH world includes the following:

OBJECTS

BEACH, BIRD, BOAT, BOY, CAR, DOG, FISH, GIRL, HOUSE, JET, KID, MAN, MOON, OAK, PINE, PLANE, PONY, STAR, SUN, TRUCK, VAN, WAGON

ACTIONS

UP, DOWN, MOVE, BACKWARD, FAST, FLY, HALT, SAIL, SHOW, SWIM, TURN, WALK, ZAP, ZOOM, PAINT BLACK, PAINT GREEN, etc.

When Peggy began to play with this computer microworld, she did not recognize any words except "by," and she had no idea what that meant. Her ability to discriminate between letters and name them was undependable and idiosyncratic. She began keying words, copying them letter by letter from a set of 4- by 6-inch cards I had made. Soon she began keying her favorite or most-used words from memory, and later she was able to read those individual words in other contexts. Now she deals with the written language one word at a time (as infants begin to speak with specific signification). To handle sentences (other than "paint some-color-name") or begin phonetic decoding of words, she will need more complex microworlds.

For Peggy, the learning of reading and the learning of writing have been synchronized (as speaking and interpreting speech are for the toddler); she learned to read her 30-word vocabulary by learning first to "write," i.e., key the words on the computer terminal. Writing was an essential part of controlling the computer microworld that engaged her. My role as teacher changed from taskmaster to occasional consultant. I would answer questions Peggy brought me after she had tried to work with the constructed reality of the BEACH microworld, and I helped her when she had problems, but I offered her no lessons beyond the rule that words are keyed letter by letter,

CALL "THE-COMPUTER-LINE"TM FOR ALL YOUR IBM[®] PERSONAL COMPUTER REQUIREMENTS

QUADRAM CORPORATION

QUADBOARD

The ultimate memory board for the IBM featuring:

- fully expandable from 64 to 256K
- parallel port
- asynchronous (RS232) serial port
- clock/calendar

SCALL

MICROFAZER

- buffering from 8 to 64K (4 to 32 pages of text)
- printer and computer independent
- parallel/parallel, serial/serial and parallel/serial available
- compute while you print!

SCALL

INTERFAZER

- Used as:
- Peripheral buffer
 - Multi-User Printer Controller
 - Computer I/O Expander
 - Incompatible Device Interface
 - Peripheral Multiplexer
 - Data Transfer Rate Converter

NEC		INTEGRAL DATA SYSTEMS	
NEC8023A	\$ 489	PRISM 132 COLOR PRINTER	
NEC7710	\$2339	INCLUDING ALL OPTIONS	
EPSON		• 4-COLOR PRINTING	\$1595
EPSON MX80III	\$ 429	• FRICTION FEED	
EPSON MX80FT III	\$ 529	• 200 CPS SPRINT MODE	
EPSON MX100 III	\$ 699		
C-ITOH			
F10 Word Quality Printer			
• 40 CPS Printing			
• Letter quality excellence			
Now Only \$1395			
OLIVETTI	\$1445	Prowriter 120cps	\$469.00

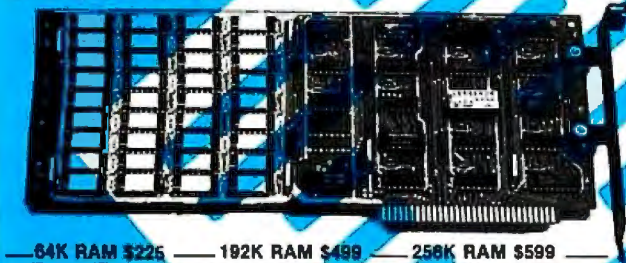

— 64K RAM \$225 — 192K RAM \$499 — 256K RAM \$599 —

TANDON ADD-ON DRIVES FOR IBM			
TMS-100-1	\$225	TMS-100-2	\$285
Single sided		Double sided	

DISKETTES	
SCOTCH WITH PLASTIC LIBRARY CASES (Boxes of 10) (48 Track single-sided double density)	\$26.50
VERBATIM DATALIFE 8S/DD (Boxes of 10)	\$24.95

BUSINESS		ENTERTAINMENT	
WORDSTAR	\$289	GALACTIC ATTACK	\$26
MAILMERGE	\$ 79	ZORK I	\$29
TAX MANAGER	\$199	ZORK II	\$29
256K VISICALC	\$189	DEADLINE	\$39
VISITREND/VISILOT	\$239	**CALL FOR NEW	
VISIDEX	\$189	GAMES AT	
EASY EFFECTIVE ACCOUNTING		UNBEATABLE PRICES**	
SYSTEM	\$389		
SUPERCALC	\$219	T and G JOYSTICKS	\$44.95
SUPERWRITER	\$289	ADAM AND EVE	
		PADDLES	\$29.95
CALL FOR SOFTWARE NOT LISTED			

Davong Systems, Inc.

Description:

The Davong Systems Memory Card is a convenient RAM memory expansion card for use in the IBM Personal Computer.

The Memory Card may be placed in any free system slot. It is completely compatible with all IBM Personal Computer software and hardware, and runs at the same speed as IBM memory products.

Features:

- 64K IC's provide low power consumption and maximum reliability.
- Extended burn-in at elevated temperature.
- Switch-selectable address range.
- Filtered voltage provides low noise.
- Power consumption:

DSI-64K	+5 v. @ 650 ma—max. +5 v. @ 410 ma—typ.	DSI-192K	+5 v. @ 850 ma—max. +5 v. @ 560 ma—typ.
		DSI-256K	+5 v. @ 900 ma—max. +5 v. @ 590 ma—typ.

Hard Disk System for the IBM[®] Personal Computer.

ONLY \$1595.00

Description:

The Davong System's Hard Disk Drive fits conveniently inside the second floppy drive location of the IBM Personal Computer chassis, providing more than 30 times the capacity of a floppy diskette, plus greater speed and reliability.

The DSI-501 System is compatible with IBM software, and supports IBM DOS[®]. The system includes all necessary components and software for installation.

Features:

- 6.4 Mbytes unformatted; 5 Mbytes formatted.
- Winchester technology 5 1/4" disk drive.
- Compatible with IBM software.
- Full software support includes:
 - Installation/configuration program
 - Complete diagnostics
 - Hard disk formatter
- Complete with all components required for installation, including:
 - Disk controller board
 - Power supply
 - Cabling
 - Software to install under IBM DOS disk operating software

12 MEGABYTES STORAGE \$2195.00

TECMAR PRODUCTS	
EXPANSION CHASSIS	\$ 799
TIME MASTER	\$ 89
DEVICE MASTER	\$ 189
SPEECH MASTER	\$ 329
SCRIBE TENDER (Two Serial Ports and One Parallel Port)	\$ 159
SCRIBE MASTER (Three Serial and Three Parallel Ports)	\$ 229
LAB TENDER	\$ 329
LAB MASTER	\$ 829
DIGITAL TO ANALOG CONVERTER	\$ 329
VIDEO DIGITIZER	\$ 289

FOR A COMPLETE EXPLANATION OF ALL TECMAR PRODUCTS
CALL FOR OUR COMPREHENSIVE CATALOG.

MONITORS	
TECO GREEN	\$179
TECO COLOR	\$588
AMDEK COLOR	\$749

CALL OR WRITE FOR OUR IBM CATALOG
IN COLORADO (303) 279-2727

CALL "THE COMPUTER-LINE"TM
1-(800)-525-7877

COMPUTERWORLD INTERNATIONAL, INC.

SUITE 133, P.O. BOX 81, WHEAT RIDGE, COLORADO, U.S.A 80034-0081

TERMS: RETAIL/MAIL ORDER: ADD 1% SHIPPING (MINIMUM \$2.50) UPS GROUND.

WE HONOR ALL MANUFACTURERS WARRANTIES AND EXCHANGE FAULTY GOODS IMMEDIATELY
SPECIALISTS IN APO AND INTERNATIONAL DELIVERIES.

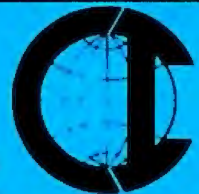

Circle 108 on Inquiry card.

RETAIL: 1019 8TH STREET
GOLDEN, CO 80401

OUR PRICES, SELECTION AND SAME-DAY SHIPPING MAKE US COMPETITIVE.

Red Baron. Home of the Nation's

NEC 8023

Outstanding Graphics, Print
Quality & Performance



144 x 160 dots/inch • Proportional Spacing
• Lower case descenders • N x 9 dot matrix
• 8 character sizes • 5 unique alphabets
• Greek character set • Graphic symbols
• 100 CPS print speed • Bi-directional logic-seeking
• Adjustable tractors • Single-sheet friction feed • Vertical & horizontal tabbing

NEC 8023
Dot Matrix List \$795 **\$Call**

IDS Paper Tiger Prism 80/132

Affordable Color, Speed



Dot Resolution Graphics • 9-wire staggered printhead • Lowercase descenders • Over 150 CPS • Bi-directional, logic-seeking
• 8 character sizes • 80-132 columns
• Hi-res dot graphics • Proportional spacing
• Text Justifications • Optional Color

Prism 80 List \$999 **\$Call**
Prism 132 (Color) List \$2095

NEC Spinwriter 7700 & 3500

Daisy Wheel Quality Leader



High speed, letter quality • 55/35 CPS
• Typewriter quality • Bi-directional printing & proportional spacing • Quiet • OCR quality print • Hi-res plotting/graphing • Quick change ribbon • Optional cut-sheet feeder, horizontal or bidirectional tractors • Prints up to 8 copies.

NEC Spinwriter RO
Serial Parallel 77xx List \$3055 **\$2575**
35xx List \$2290 **\$1975**

Smith Corona TP-1

Daisy Wheel Printer For Under \$900



A real character printer • Standard serial or parallel data interface • Drop-in ribbon • 144 WPM • Various type fonts available • Loads paper like typewriter • Handles single sheets for forms • Compatible with most micro computers

Smith Corona TP-1 List \$895 **\$Call**

The Epson Series High-Quality Printers at a Low Price.



Epson MX80 List \$645 **\$Call**
Epson MX80FT List \$745
MX100 List \$995

Full Line of Epson Accessories

Printer Stands

UNIVERSAL

22" W x 16.75" D x 25.25" H. Black with chrome basket. Kit with easy assembly and mounting instructions.



Printer Stand . . . \$99

MINI STAND (M-OMI-0200) Sturdy plexiglass desk top printer stand made to hold Epson MX-70, MX-80, Centronics 739, or other. Paper feeds from either the floor under the table, or from directly under stand itself.

Mini Printer Stand \$25

Anadex DP-9500A The Quiet Serial Matrix Impact Printer



Up to 200 CPS • Dot addressable graphics • Parallel and serial interfaces standard • Switch selectable protocol • Cartridge ribbon • Foreign character sets • Underlining • 1.5K to 3.5K buffer • Correspondence quality print

Anadex DP-9500A List \$1725 **\$Call**
Anadex DP-9620 List \$1845

Televideo CRT's Price, Performance & Reliability



910 List \$699 **\$600**
925 List \$995 **\$750**
950 List \$1195 **\$970**

Interface Equipment

Complete Stock of Options,
Cables and Accessories.

CCS APPLE SERIAL Interface & Cable . \$150
ORANGE INTERFACE for Apple II
Parallel Interface Board and Cable .. \$110
NOVATION D-CAT
direct connect modem \$180
COMPLETE STOCK OF EPSON
ACCESSORIES \$Call
CUSTOM PRINTER CABLES FOR Apple,
Atari, IBM, TRS-80 (all models) \$Call
HAYES MICROMODEM \$300
PRINTER STANDS: Large \$99
Small \$25
PRINTER RIBBONS—Most Types \$Call

OUR PEOPLE MAKE US EXPERTS.

Largest Computer Printer Inventory.

The Grappler+ Apple Graphics Interface

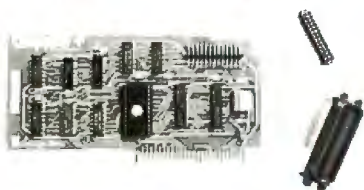

Graphic screen dumps with keyboard commands • Dual Hi-Res Graphics • Inverse graphics • Apple III compatible* • Emphasized graphics • 90° Rotation • Center graphics • Chart recorder mode • Text Screen Dumps and more.

*Requires Software Driver

Grappler+ **\$175**

The Okidata Series Hi-Res & TRS 80 Block Graphics

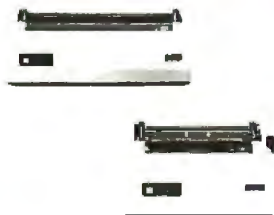

120 CPS • 9 x 9 Matrix • Bidirectional logic seeking printing • Lower case descenders • four print styles • Optional Hi-Res Graphics

Okidata 82A List \$649 **\$480**
Okidata 83A (w/Tractor) . . List \$995 **\$745**

C. Itoh F-10 Low Priced Letter Quality



40 cps • Uses Diablo Standard Printwheels • Built-in word processing functions • Universal power supply • Optional bidirectional tractors • Prints original plus 2 copies • Quick-change cartridge Ribbon

C. Itoh F-10 List \$1995 **\$Call**

Our People, Our Product: Both Are Specialized.

Because our salespeople are printer specialists, they know the capabilities of each printer—and how to match one to your exact need. Red Baron's volume stocking assures a low, low price on a wide array of major brands. We're sure you'll like the product and services you get from Red Baron, and we know you'll love our Customer Benefit Package; an exclusive at Red Baron.



Customer Benefit Package

1. Free Expert Consultation. Before you buy, after you buy. **2. Technical Staff.** Even your most involved questions get quick, helpful answers from our staff of printer technicians. **3. Free Catalog.** Get your informative catalog with printer comparison chart and print samples today! **4. Warranty.** The manufacturer's warranty applies where applicable. **5. Same-Day Shipping.** Your order is shipped the same day when you call before 11:00 a.m. **6. Free MasterCard and Visa.** Call us toll-free and charge your printer to your credit card. **7. We Stock What We Sell.** No bait and switch, no hassle. We make every effort to keep a large stock of our advertised products. **8. APO/FPO Orders Welcome.**

Other Quality Printers at Red Baron

C. Itoh 8510
Prowriter \$ 795 **\$Call**
Diablo 63/6 \$2995 **\$2570**
QUME
Sprint 9/45 \$2475 **\$2150**

Here's How To Order:

Phone orders are welcome; same-day shipment on orders placed before 11:00 a.m. Free use of MasterCard and Visa. COD's accepted. Personal checks require 2 weeks clearance. Manufacturer's warranty included on all equipment. Prices subject to revision.

Call Toll Free For Catalog:

(800) 854-8275
CA, AK, HI (714) 630-3322



Member Better
Business Bureau

1100 N. TUSTIN #207, ANAHEIM, CA 92807

ERG/68000 MINI-SYSTEMS

- Full IEEE 696/S100 compatibility

HARDWARE OPTIONS

- 8MHz or 10 MHz 68000 CPU
- 4-8 RS232 Serial Ports
- 64K STATIC RAM (70 nsec)
- 256K Dynamic RAM, with full parity
- 8" D/D, D/S floppy disk drives
- 5MB-32MB hard disk drives
- Full DMA host adaptor
- 20MB tape streamer
- 10 to 20 slot backplane
- 30 amp power supply

SOFTWARE OPTIONS

- 68KFORTH¹ systems language with MACRO assembler
- Fast Floating Point package
- Motorola's MACSBUG
- IDRIS² operating system with C, PASCAL, FORTRAN 77, 68K-BASIC¹ compilers

Trademark ¹ERG, Inc.
²Whitesmiths

30 day delivery
with valid Purchase Order

OEM prices available
For CPU, Integrated Card Sets
or Systems.



Empirical Research Group, Inc.
P.O. Box 1176
Milton, WA 98354
206-631-4855

left to right, and that a specific symbol meant she should press the Enter key.

I make no claim that computer microworlds can teach all reading skills, nor that this specific BEACH world would appeal to other children in different circumstances. I do, however, see the BEACH microworld as a prototype of the various worlds that others may fashion for small children.

Design Heuristics: Powerful Ideas

A computer microworld should be constructed around a powerful idea, one worth the instructor's time to develop or the student's time to explore. Who decides if an idea is sufficiently powerful? You do, at first, when you design a microworld. Next, the students determine the worth of the microworld as they incorporate the idea into their minds or reject it.

If you need a little guidance when you design a computer-based microworld, Papert (in *Mindstorms*) offers four criteria for powerful ideas: they should be simple, general, useful, and syntonetic. The idea behind a microworld must be formulated as simply as possible; an idea can be powerful only when understood. Even if an idea is embodied in a specific microworld, it will not be useful through extension unless it is general.

Reality dictates the candidates for powerful ideas. Society also declares what ideas are important: if you can't read, for example, a technological society relegates you to subhuman status. But it is your own mind, more than any advice, that can tell you what ideas are powerful. Your own insights enable you to integrate important experiences. An idea is powerful, then, if it gives form to your understanding of life. It follows that you cannot inspire others with an idea unless it has first inspired you.

Interconnection of Knowledge

What Papert labels the "syntonetic" characteristic focuses on how an idea assumes power within the mind of an individual. An idea is powerful for a person if it relates and unifies knowledge gained in diverse experiences.

An idea gains power if it can be reduced to a concrete model that serves as a metaphor for the interpretation of subsequent problems. Such a model helps explain which aspects of new problems must be considered, which may be neglected, and which anomalies must be explained away on a basis of local evidence. Models prove more or less powerful depending on the individual's interests and experiences.

The most essential characteristic of powerful ideas is their relation to the individual's previous knowledge. You can tell students that one situation resembles another, but recognition of such comparisons is more powerful if it is the students' own discovery. They will make the connections between the structures of one idea and another at a level of detail appropriate to their specific prior knowledge and feelings. This internalization is the basis of an idea's power for the individual.

An analogy may help here. If you solder a connection at too low a temperature, you can get mechanical binding but undependable electrical contact. Ideas imposed by instruction are like badly soldered joints. Only the individual has the power to fuse connections between new ideas and his or her own most personal thoughts and feelings. These connections alone can make an idea an important part of how the person sees the world and behaves in it.

Paradoxically, an excellent way to harness the students' understanding for engagement with ideas is to liberate their expressiveness. Because Logo is a vehicle for free exploration, knowledge built from Logo is syntonetic, appropriate to the person, and experienced as an authentic, intimate part of the self. Such is the power of an approach to learning that frees the individual to create within a social context that makes our culture's most powerful ideas accessible.

I/O and Applications Design

An application design negotiates between a specific objective and the potential of the equipment. Computers are general-purpose symbol manipulators, so they can deal

abstractly with an idea. What any computer system can do in an interesting way, however, depends on its input/output (I/O) devices. Look for something special about a machine's I/O to suggest the kinds of neat phenomena the system could exhibit. Consider these examples from previously implemented Logo systems:

- The accessibility of the robot floor-turtle world to a child's physical intervention can lead even a small child into simulating the turtle's actions and into debugging procedures (after fixing a procedure "manually," a child can become more engaged in fixing it symbolically).

- Turtle graphics—whose appeal depends largely on the emergence of patterns from simple procedures that command the drawing of many lines—came into its own only with the general availability of bit-map-based displays.

- Logo on the GTI-3500 had a significant potential for engineering and physics simulations because a hardware-implemented "spin" primitive extended the forward and right primitives of "classical" Logo.

- The TI 99/4A joins together a general-purpose microprocessor (where TI Logo is implemented) with a special-purpose graphics processor that manipulates the sprites that give TI Logo its most striking effects.

As increasingly powerful microprocessors become affordable, the special quality of each will bring new potential for creating engaging microworlds. More powerful microprocessors and graphics slave processors may, for example, bring molecule modeling within reach. Local networks of small machines may permit group simulation of economic and political situations (as in games) that are now too abstract, rule-driven, and theoretical to interest many young people. There will continue to be opportunities for creating microworlds around the most powerful ideas of contemporary science and technology.

Objects in Microworlds

Logo procedures can serve as a

bridge between less precise and more formal systems. The commands of Logo are designed to communicate with a computer and its output devices, but the extension of Logo through procedures whose names are natural-language words can make the objects and actions more comprehensible. This ability to be extended is a key feature for young children.

But Logo is only a quasi-natural language; a Logo procedure must run on a machine. Further, the objects of a Logo microworld are formal; they can be completely defined by a specification of their state variables. One of the simplest of these objects is the Logo screen turtle. Once you have specified the turtle's location, heading, and pen position, there is no more to say about it. The operations of a microworld are also completely specifiable in terms of the effects they have on state variables. The RIGHT and LEFT commands, for example, modify the heading of the turtle but do not affect its location. Given the

object orientation of Logo and the ease of specifying the interaction of state-change operations with state variables, a first criterion for the quality of any Logo implementation (an application microworld or the interpreter itself) is the clear presentation of the state variables to someone using the system. Two examples of representation inadequacies in TI Logo can clarify the point: although the heading of a sprite is a significant state variable, it cannot be determined by inspecting the object's appearance (the shape carried by the sprite) when its velocity is zero; it is impossible to determine visually which sprite is the "current" object, i.e., the one or ones that will respond to the next Logo command. Ideally, the equivalent of a SHOWTURTLE/HIDETURTLE set of commands would show which is the active sprite. Whatever the limitations of a specific Logo implementation, anyone who designs a computer-based microworld should strive to represent all the state vari-

COPIES WITHOUT PROBLEMS:

FAST: Turnaround time in hours and days, not weeks. You get your disks when you need them.

ACCURATE: Each copied track is checked bit by bit. If it doesn't match your original, it isn't shipped.

FLEXIBLE: Standard, double-boot, and copy-resistant formats. 50 copies minimum, no maximum.

REASONABLE: Set-up as low as \$10 per disk. Copying only from 30¢, copying and 3M disk from \$2.00. Other disks and services also available.

RELIABLE: Years of disk duplication experience insures a problem-free shipment on time — time after time.

For all your Apple® compatible copying needs.

THE ALF COPY SERVICE.

ALF

1448 Estes

Denver, CO 80215

[303] 234-0871

PERSONAL COMPUTERS PERSONAL COMPUTERS PERSONAL COMPUTERS

OKIDATA MICROLINE 83A

\$695.00



120 CPS, Bi-directional logic seeking 9x9 dot matrix, full 96 ASCII char. Set with true descenders centronics parallel port and RS232 serial port (up to 1200 Baud) standard, 136 col, includes Okigraph dot addressable graphics, friction feed and removable tractor. 31 lbs., 110 volt standard, 220 volt optional.

	Call for Model & Price
Altos	Call for Model & Price
Amdek Video-300	149.00
Amdek Color-I Monitor	329.00
Amdek Color-II Hi-Resolution 13" Monitor	729.00
Amdek Color-III Monitor	439.00
Atari 400 16K	319.00
Atari 810 Disk Drive	449.00
Atari 850 Interface	169.00
Atari 800 16K	669.00
Daisywriter 2000	1049.00
Diablo 630	2095.00
Epson MX-70	289.00
Epson MX-80 w/Grafrax Plus	439.00
Epson MX-80 FT w/Grafrax Plus	549.00
Epson MX-100 FT Printer w/Grafrax Plus	695.00
Hayes Micromodem II (Apple II)	289.00
Hayes Smartmodem	225.00
IDS 560 Paper Tiger	1099.00
IDS Prism 80 (Color)	1379.00
IDS Prism 132 (Color)	1559.00
Mannesmann Tally MT 1705	1289.00
Mannesmann Tally MT 1802	1499.00
Microtek 16K Ramboard for Atari 800	79.00
Microtek 32K Ramboard for Atari 400 & 800 ..	119.00
Microsoft Soft Card (Z-80)	279.00
Microsoft Soft Card Premium System for Apple	579.00
Microsoft Ramcard 64K for IBM-P.C.	369.00
Microsoft Ramcard 16K for Apple	139.00
NEC 3510 or 3530 Spinwriter	1675.00
NEC 3515 Spinwriter	1695.00
NEC 7710 or 7730 Spinwriter	2295.00
NEC PC-8023 Printer	489.00
NEC JC1201 M(A) - Color 12" Monitor	329.00
NEC GREEN JB1201M - 12" Monitor	169.00

CALL TOLL FREE!
800-343-0873

Okidata Microline - 80 Matrix Printer	329.00
Okidata Microline - 82A	449.00
Okidata Microline - 83A	729.00
Okidata Microline - 84 Parallel	1095.00
Sharp PC-1500 Pocket Computer	239.95
Sharp CE-150 Color Printer/Cassette I/F	199.95
Sharp PC-1211 Pocket Computer	135.95
Sharp CE-122 Printer/Cassette Interface for PC-1211	99.95
Smith-Corona TP-1	649.00
Televideo 910	559.00
Televideo 925	735.00
Televideo 950	929.00
Transtar Model 140	1295.00
Videx Videoterm 80 Column Card for Apple II .	259.00

OMEGA SALES COMPANY

430 PEARL STREET, STOUGHTON, MA 02072

(617) 344-6645 TOLL FREE (800) 343-0873

EPSON MX-100 FT

\$695.00



**OMEGA DELIVERS
FOR LESS**

OKIDATA MICROLINE 83A

OR

EPSON MX-100 FT

YOUR CHOICE

\$695.00

80 CPS, Bi-directional logic seeking 9x9 dot matrix, full 96 ASCII char. Set with true descenders, centronics-style parallel port (RS232 optional), 136 col., includes graftrax plus dot addressable graphics, friction feed and removable tractor feed. 21 lbs., 110 volt only.

Omega carries software by the following companies:

- American Business Systems • Ashton Tate • Dakin 5
- Innovative Software • Micropro • Microsoft
- Sorcim • Stoneware • Visicorp (Personal Software)

Omega carries diskettes (5¼" or 8") by the listed companies:

- Dysan • Maxell • Scotch • Verbatim

Omega carries accessories for the Apple II by the following manufacturers:

- D.C. Hayes • Microsoft • Tymac
- M & R Enterprises • Videx

We carry the complete line of Atari Hardware, Software & Peripherals.

We will try to match or beat any price with similar purchase conditions.

**CALL TOLL
FREE!
800-343-0873**

Stock Shipments Same Day or Next
No Surcharge for Credit Cards
All Equipment Factory Fresh w/MFT Warranty
Prices do not Reflect Shipping Charges
Mass. Residents Please Add 5% Sales Tax

**PRICES ARE SUBJECT TO
CHANGE WITHOUT NOTICE**

OMEGA SALES COMPANY

430 PEARL STREET, STOUGHTON, MA 02072

(617) 344-6645 TOLL FREE (800) 343-0873

ables in a visible, obvious way. Doing so enhances the comprehensibility of the ideas embodied in the objects and their manipulations.

Comments on a New Microworld

One of the objectives of Logo is to put power in the hands of beginning users. Even powerful ideas usually come from striving to reach a simple, down-to-earth objective. To demystify designing a microworld, I would like to present a few comments on some work in process. I wanted to develop an effective way to present some ideas of algebra to a 12-year-old. I remembered a casual comment of a former MIT Logo colleague, Andy diSessa, that one of the most powerful ideas accessible through Logo was embodied in "procedures that output." At the time, I was mystified, even though Andy had explained that his comment was based on the fact that such a procedure was equivalent to a mathematical function. *That* observation came back to me. Algebra is about mathematical functions. Although I couldn't fully appreciate Andy's comment, it focused my attention on a personally comprehensible way of expressing mathematical functions in Logo.

Common mathematical functions assign the value of one variable (call it y) to the value of some expression based on another variable (call it x). Assigning values is just what the MAKE command does. If a superprocedure controlled assigning to y the value of an x -based expression for the domain of possible values of x , it would generate any function expressible in the Logo language. When given two inputs (x, y), the DOT primitive of Apple Logo draws a dot at the screen location of those coordinate values. If the value of x is incremented across the domain of possible x -coordinate values, and y is specified in terms of the value of x , DOT can be used to plot discrete sketches of mathematical functions. A second method of drawing functions is possible. If those "dotted" locations are used as the position coordinates of a SETTURTLE (SETPOSITION) command, the screen turtle will

draw a line-segment approximation to a mathematical function. These are the ideas around which the PLOTTING microworld is constructed. Photos 2a and 2b show examples from the PLOTTING microworld.

How can a person go from common experiences to a new idea by doing something only slightly unusual—but with that small difference providing access to a range of significant

(2a)

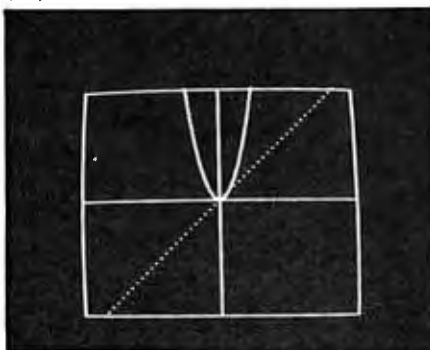

(2b)

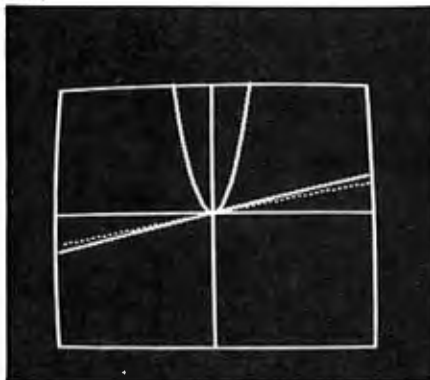

Photos 2a, 2b: Two examples of the PLOTTING microworld. Photo 2a shows the contrast between the straight-line plot of $y=x$ and the parabolic plot of $y=.2x^2$. Photo 2b contrasts the same parabolic plot with a plot of $y=.25x$ (segmented line), an attempt to fit the slope (heavy line) of the parabola at a point. See listing 2 on page 158 for the DOTPLOT procedure from the PLOTTING microworld.

phenomena? Think about what kinds of experiences younger students might have had that could support learning about mathematical functions. Any child who uses Logo for a while learns to define specific variable values using the MAKE primitive; for example:

```
MAKE "MY.NAME "BOB
MAKE "MY.AGE 42
```

The minimal significant complication possible in the specification of a variable is to make its value depend on something else, such as keyboard input. It is common for beginners to write routines such as the greeting below for inclusion in some more ambitious program:

```
TO GREET
PRINT [WHAT'S YOUR NAME ?]
MAKE "WHO READWORD
;accept keyboard input
PRINT (SENTENCE
[GLAD TO MEET YOU,] :WHO)
END
```

We can start with nonarithmetic examples of variables as functions of other variables. They can be simple or complex. Graphs of equations can be viewed as another, more specific form of a familiar kind of relation—a new representation for a familiar idea. The algebraic formulas with which we usually associate the graphs of equations are seen as another description of a correspondence relation, a description that is specific and limited, but very powerful.

Making clear the connection between concrete uses of programming variables and mathematical functions is one justification of a PLOTTING microworld. This idea is one I judge to be powerful. The programming needed to make a Logo PLOTTING subsystem is nearly trivial (see listing 2), but that is precisely the virtue of a powerful language: its expressiveness makes ideas and functions stand clear of accidental complications.

Extending the PLOTTING World

If we look beyond the simple plotting of functions, the intellectual extensions of such a microworld can be simple and striking. Consider these two possibilities. First, when the domain of x is specified with beginning, end, and increment or step-size (to control the grain of the plotted function), the slogan through which continuity is often expressed becomes an almost obvious consequence of the "dotted" representation: "you give me an *epsilon*, and I can give you a *delta* such that whenever the difference between successive values of x



\$150

More than a
Spelling Checker

THE COMPLETE TOOL

The WORD PLUS has many features that SpellStar™ and other competitors leave out. The WORD PLUS finds errors, shows them to you *in context*, and with your consent, automatically corrects them throughout the text. SpellStar does not correct errors.

Versatile The WORD PLUS works with almost any CP/M® based word processor. SpellStar only works with WordStar™.

Accurate The WORD PLUS offers a 45,000 word vocabulary without the compromise of suffix stripping. SpellStar has only 20,000 words.

Convenient The WORD PLUS helps you find the correct spelling by consulting its dictionary. SpellStar gives no such help.

Fast The WORD PLUS proof reads 10,000 words of text in less than two minutes.

Many Extra Features

The WORD PLUS offers automatic hyphenation, text analysis, and fast word counting. Also solves crossword puzzles, locates anagrams and finds rhyming words.

Inexpensive \$150 . . . a low cost for freedom from the anxiety of misspelling.

The WORD PLUS - Clearly the Best Choice.
For more information call Wayne Holder at

**OASIS
SYSTEMS**

714-291-9489

2765 Reynard Way
San Diego, CA 92103

*SpellStar and WordStar are trademarks of MicroPro Intl.
CP/M is a registered trademark of Digital Research, Inc.

BRAINS-MAINFRAMES

SUPERBRAINS



SUPERBRAIN QD 64K

List \$2995 only \$2449



Z-89 48K
List \$2895 only \$2099
Z-90 64K DD 3195
ONLY \$2489

COMPUSTARS

Available to Dealers

NORTH STAR

Minicomputer
Performance

Green Phosphor
Options:
Graphics + CP/M
List \$3,999
Only \$2,989

ADVANTAGE

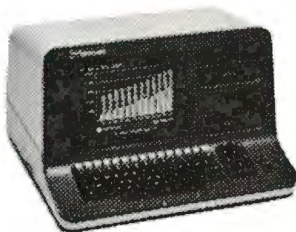

Monitor Green Phosphor \$114

TERMINALS Z-19 \$638
INTERTUBE III Super Smart \$710

EPSON

MX-80 FT. \$598
MX-80 \$474
MX-100 \$749



ANADEX 9501 \$1290
NEC Letter Qual Friction & Tractor call
ZENITH printer Z-25 list 1595 only \$1256
C. Itoh F10 Letter quality \$1449



ATARI 400 List \$399 only \$340
800 List \$899 only \$675

Wonderful Games—Education for your family

Main Frames-S-100 \$200 up
Advanced Micro Digital Superquad Single Board Computer
with Z80 64K and FDC \$749
Dual 68000 CPU S100-Super Fast—Save CALL

AMERICAN SQUARE COMPUTERS is organizing a World Wide Association of Computer Dealers. Open a Store or Start Work Out of Your Home! We Charge NO FRANCHISE FEE! (Our Competitors charge a FRANCHISE FEE of from \$15,000.00 to \$45,000.00.) Be a Winner! Let US help YOU get started MAKING MONEY by HELPING PEOPLE to put COMPUTERS to WORK. Write or Phone today.

TELEVIDEO TERMINALS . . . 910 \$518, . . . 925 \$718

GODBOUT COMPUPRO

Super Sixteen 8085/8088 is the fastest combo 8/16 CPU. LIST \$3904 Special \$2873

SEATTLE'S

16 bit COMPUTER is here! 8 MHz 8086 CPU the fastest S-100 computer! 128K Static RAM, DD Disk Controller, 22-slot Main Frame, 86-DOS, #2 128K
LIST \$4185 ONLY \$3349
#1 As above but 64K LIST . . . \$3190 . . . ONLY 2649

CALIFORNIA COMPUTER 2210A

LIST \$1995 ONLY \$1722
Z80, 64K, I/O, Disk controller + CP/M.
Model 302 is the larger system: 2.4 Mb 8" Z80, 64K, and optional OASIS, CP/M, or MP/M operating system.
LIST \$5295 ONLY \$4674

SYSTEMS GROUP SYSTEM 2800

Runs CP/M or OASIS. Supports single user & multi-user & multi task. Up to 5 megabytes with 8" drives. Optional 10-megabyte hard disk. Optional tape back up #2812 \$5035 ONLY \$3775

TARBELL'S

Empire I&II have two 8" disk drives. The I is single sided, the II is double sided.

FREE Business Software

Empire I LIST \$4888 Only \$3666

We sell The Finest Hardware

AMERICAN



We sell The Finest Software

COMPUTERS

919-889-4577

4167 Kivett Dr.

Jamestown, NC 27282

919-883-1105

LOWEST PRICE · BEST QUALITY

NORTH STAR Horizon 2



2-5¼" Disk Drives
64K Double Density
Factory assem. & tested
Factory guaranteed

A few left
Low Price only
\$2499

**Powerful North Star BASIC Free
Superb for Business & Science**

HORIZON STANDARD IS NOW HRZ-2-64K QUAD

Factory Assembled & Tested	List	Only
Horizon-2-64K-Quad	\$3599	\$2689
Horizon-1-64K-QHD 5	\$5999	\$4559
Horizon RAM ASM..... 32K = \$424 64K = \$594		
Big Sale on Multi-User Time-Sharing ..	call	
English to Basic Translator		\$99
North Star Hard Disk 18 Mb.....	\$5375	\$4568
North Star Time Sharing Multi User ..	call	
Zbasic 2 to 5 times faster!	\$350	call
Secretary Word Processor		\$99
Wordstar Word Processor		\$296
Floating Point Board	\$399	\$339
Oasis Multi-User Software	SAVE	call
CP/M for N* Extra features		\$230
Micro Mike Software	SAVE	call
Ecosoft Accounting MICROSTAT ..		\$265
Pascal-80	\$600	\$515
Extra Precision Basic		\$50
Northwood	\$199	\$179
Mailmanager	\$299	\$224
Infomanager	\$399	\$349
General Ledger	\$499	\$429
Accounts Receivable	\$499	\$429
Accounts Payable	\$499	\$429
Inventory	\$499	\$429
Order Entry	\$499	\$429
PROPAC	\$1499	\$1274
DOS + Basic 5.2		27

DECISION I



"The IBM-360 on the Z-80 & S-100 BUS!"

Sixteen Programs running simultaneously! Free CPM, Microsoft BASIC and WORDSTAR with Complete system!

	LIST	ONLY
DECISION 1 + 65K Static + 8" Disks	\$4375	3377
DECISION 1 + 65K Static + 2- " Disks	4195	3149
DECISION 1 + 65K Static + 5" Disk + 5MB Hard Disk	5990	4784
DECISION 1 3 user 195K Static + 5" Disk + 5MB Hard Disk + MICRONX	8035	6428
DECISION 1—Z-80 + 1/0 = Power	1725	1294

MORROW 8" Disk

Discus 2D + CP/M 600K only \$834
Discus 2 + 2 + CP/M 1.2 MEGA B \$1074
Add Drives 2D = \$599 2 + 2 = \$795
Discus 2D-dual + CP/M Only \$1384
Free Microsoft BASIC from MORROW with Discus system or hard disk



M-26 MORROW Hard Disk
26,000,000 Bytes!!
List \$4495

Only \$3394
Free CPM + BASIC
M-20 List \$4795 .. Only \$3835
M-10 List \$3695 .. Only \$2955
M-5 List \$2495 .. Only \$1994

InterSystems

Z-80A CPU 4 MHz
64K Dynamic RAM
Front Panel

VI/0-1 - with interrupts
FDCII Disk Controller
20 slot motherboard

List \$3795 Only \$2839

Without front panel as above only \$2716
Front Paneless Recommended for Business

Save on Memory and Programs

Systems Memory 64K A&T \$459
Systems Memory 64K Bank \$555
Microangelo \$985

Corvus Hard Disk SAVE
SSM Video BRD VB3 kit \$361
Spectrum Color ASM \$326

Cat Novation Modem \$169
Memory Merchant 16K \$159

Which Computers are Best?—FREE.
Insured Shipping at Low Rates. Call
For Latest Prices, Details. We Beat
Advertised Prices.

Factory Guarantees

Expert Advice

AMERICAN



COMPUTERS

919-889-4577

4167 Kivett Dr.

Jamestown N.C. 27282

919-883-1105

Listing 2: The DOTPLOT procedure, written in Logo. The procedure plots y as a function of x for values of x incremented by CHANGE. Resulting plots appear in photos 2a-2b.

```
TO DOT.PLOT :CHANGE
MAKE "X - 135
PRINT [MAKE "Y A FUNCTION OF :X]
MAKE "FUNCTION READLIST
LABEL "AGAIN IF :X > 135 [STOP]
RUN :FUNCTION
IF NOT OR :Y > 119 :Y < -119 [DOT SE :X :Y]
MAKE "X :X + :CHANGE
GO "AGAIN
END
```

Listing 3: The LJ1 procedure, written in Logo. Using the variables COEFF1, COEFF2, and CHANGE, the procedure draws Lissajous figures like those shown in photos 3b, 3c, and 3e.

```
TO LJ1 :COEFF1 :COEFF2 :CHANGE
MAKE "ANGLE 0
MAKE "FUN1 (SENTENCE [MAKE "X 100 * SIN :COEFF1 * :ANGLE])
MAKE "FUN2 (SENTENCE [MAKE "Y 100 * COS :COEFF2 * :ANGLE])
PENUP RUN :FUN1 RUN :FUN2 SETPOS (SENTENCE :X :Y) PENDOWN
LABEL "AGAIN MAKE "ANGLE :ANGLE + :CHANGE
RUN :FUN1 RUN :FUN2
SETPOS (SENTENCE :X :Y)
GO "AGAIN
END
```



is less than δ , the difference between successive values of y will be less than ϵ ." Second, consider the implications for understanding the differential calculus. When plotting the value of a function, it is simple to save the value of the prior point-couple and calculate the slope of the function. This is an empirical form of differentiation. A micro-world of plotting tools (whose activities could include plotting functions, the empirical derivation of slopes of those functions, and curve

fitting—with the plotting tools—to those empirically derived slopes) could provide a body of practical experience about the relations between functions and their slopes. This experience, for which differential calculus will later provide a theory, will make the calculus easier to appreciate and assimilate.

These ideas may interest a math teacher or a psychologist, but would any child be interested in plotting mathematical functions? Are there any accessible neat phenomena? This

is the most important final question the creator of every microworld must face. The concrete appeal of this microworld must be the creation of appealing (and possibly puzzling) graphic designs. The beauty of turtle-geometry designs derives from the use of repetition and variables in simple procedures. This observation suggests that we look at repeating functions such as those produced by the sine and cosine primitives. Photos 3a-3f show six designs made from combinations of sine and cosine functions. These designs, generically known as Lissajous figures, are my candidates for neat phenomena of the PLOTTING microworld. [Editor's Note: Named for French physicist Jules Lissajous, each of these figures consists of the series of plane curves traced by an object that executes two mutually perpendicular harmonic motions. . . . P.L.] The method of the procedure shown in listing 3 is to calculate a screen location with x as a sine function of an angle value and y as a cosine function of the same angle. The design is made when the turtle draws a line as it moves from one calculated location to the next one. The procedure is stopped manually.

Lissajous figures are similar to POLYSPI designs in general character because they are made of line segments that show natural classes or families of shapes and occasionally emerge as surprisingly beautiful. Like INSPI designs, they are somewhat mysterious to those who think more concretely than formally. Are they

\$\$ READ THIS IF YOU WANT TO SAVE MONEY \$\$ BEST HARDWARE AND SOFTWARE DEALS AVAILABLE!			
APPLE BUSINESS SOFTWARE Visicalc \$189 Versaform \$299 Milestone \$255 Supercalc \$225 DB Master \$185 DB Master Util. Pak \$ 79 Pro Easywriter Combo } Accounting Plus } Call BPI Software } for dBASE II } Best FMS-80, 81, 82 } Prices VISI Series Software } ★ THE LAST ONE ★ The program that writes programs! Special Offer with purchase. Call	Microsoft Products } Corvus Products } Call SVA Products } ★ NEW PRODUCT LINES ★ IBM Software and } Peripherals } Call Atari Software } Best TRS-80 Software } Prices ★ INTRO SPECIAL ★ Basis 108 Computer } Call Videx Visicalc PreBoot } Call ★ SPECIAL ★ MICROSOFT PREMIUM SYSTEM, incl. Microsoft Z-80 Card } All Microsoft 16K Card } for Videx 80 Column Card } Only Videx Soft-Switch } \$ 41 Osborne CP/M Guide } \$625	COMMUNICATIONS Hayes Micromodem II \$275 Hayes Smart Modem \$235 Hayes Chronograph \$225 Novation Apple Cat II \$335 Micro Courier \$210 Pro Z-Term Call PRINTERS & INTERFACES NEC Spinwriter 7710 \$2350 Anadex DP-9501 \$1295	Okidata Microline 83A \$745 CCS Interface Cards Call Qume and Diablo Call MICRO PRO Wordstar \$230 Supersort \$130 Mail Merger \$ 99 Data Star \$230 Spell Star \$130 Calc Star \$130 CP/M 8" Versions Call COMPUTER SYSTEMS Xerox 820 Computer Call Xerox Peripherals Call
APPLE PERIPHERALS Thunderclock \$125 Basis Encoder Board (U/L Case) \$109 Mountain Computer Prod. Call Videx Products Call	★ DISKETTE SPECIALS ★ Maxell MD-1 (Box of 10) \$ 32 Maxell 8" (Box of 10) \$ 41 Verbatim 5 1/4" \$ 29 Verbatim 8" \$ 35	  <p>Minimum order \$100. Cashiers checks and money orders accepted. Add 3% for VISA or MC. Add 3% for shipping/insurance/handling. UPS. No COD. Prices subject to change. Call to verify. Order hours 9-6 PDT, Mon-Fri. Personal checks allow 20 days to clear. All products with full manufacturer's warranty, factory sealed. Call. Residents add 6% sales tax. Apple is a registered trademark of Apple Computer, Inc. All brand names are registered trademarks.</p>	MONITORS NEC Hi-Res 12" Green \$170 NEC Hi-Res 9" Green \$165 NEC RGB 12" Color \$995 Sanyo Monitors Call MISCELLANEOUS Micro Sci Drives Call 16-Bit Apple Card Call TG Joysticks \$ 45 TG Paddles \$ 30 ABT Keypads \$ 99 System Saver Fan \$ 77 Disk Storage Pages (10) \$ 6
 COMMUNI CAL INC.			
1400 GRANT AVE. / NOVATO, CALIFORNIA 94947 IMMEDIATE DELIVERY PHONE ORDERS CALL COLLECT 415-892-7139 or 415-897-1414			



TEAM PLAYERS.

Master/Slaves...

At Advanced Micro Digital, we believe in co-operation between computers and their operators. That's why our new team of S-100 master and slave processors are designed with your team in mind and feature superlative reliability and ease of operation.

Our team captain is SUPER QUAD, a unique multi-function master processor combining 64K of bank selectable RAM, single- and double-density floppy disk controller, system monitor EPROM, Z80A CPU, two serial and two parallel communication ports on a single board. The players consist of one or more SUPER-SLAVES, the latest addition to Advanced Micro Digital's line of superior multi-function S-100 boards.

Each SUPER-SLAVE is a powerful single-board slave processor designed for use with the SUPER QUAD in either network or stand-alone configurations. The outstanding features of the SUPER-SLAVE include:

- A DEDICATED Z80A CPU FOR EACH USER
- IEEE-696 standard conformity
- 4 serial, 2 parallel interface ports
- 2/4K EPROM (monitor)
- 64/128K bank switchable RAM
- One year warranty
- Turbo-DOS™, the state-of-the-art operating system with an advanced failure detection and recovery facility that makes the master-slave network virtually crash-proof.
- Also, for the first time CP/NOS® operating system from Digital Research. Plug as many SUPER-SLAVES into the BUS as you need users.

Your team needs the strong support of the SUPER QUAD/SUPER SLAVE team from Advanced Micro Digital Corporation. The Super System includes SUPER QUAD and CP/M operating system. The shugart SA-1000 or quantum Q2000 hard disks are also supported.



For more information write or call Sales Dept.

12700-B Knott Street • Garden Grove, California 92641 • (714) 891-4004 TELEX 678401 tab ltr

® Registered Trademark of Digital Research Corp.
 * Registered Trademark of Software 2000 Inc.

© Copyright 1981 Advanced Micro Digital Corp.

Circle 9 on Inquiry card.



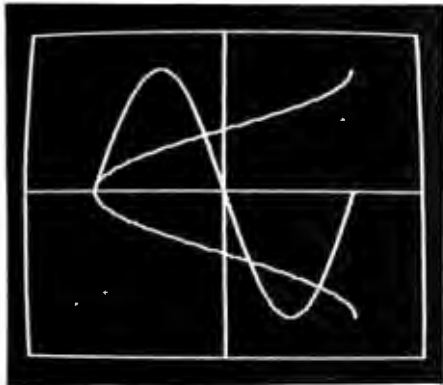

(3a)

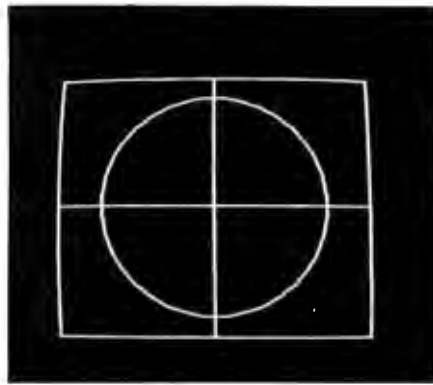

(3b)

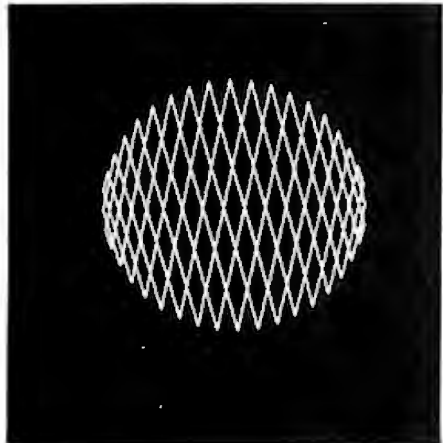

(3c)

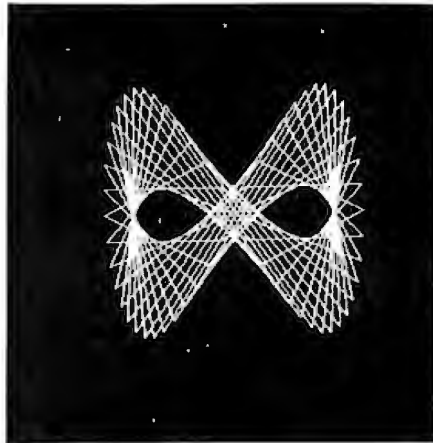

(3d)



(3e)

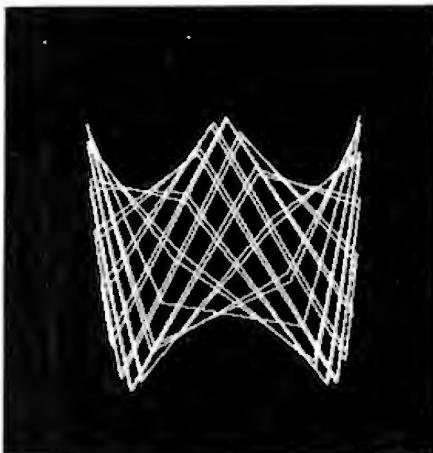

(3f)

Photos 3a-3f: Six more designs from the PLOTTING microworld. The author regards designs made from sine and cosine functions as neat phenomena; i.e., phenomena inherently interesting to observe or interact with. In each design, a procedure calculates a screen location with x as a sine function of an angle value, and y as a cosine function of the same angle. The turtle draws a line by moving from one calculated location to the next.

Photo 3a shows a plot of $y = \sin x$ and $x = \cos y$. The designs in photos 3b, 3c, and 3e were plotted using the LJ1 procedure shown in listing 3, with the following respective sets of values for the three variables (COEFF1, COEFF2, and CHANGE) in the procedure: 1, 1, 1; 77, 23, 9; 1, 2, 84. The design in photo 3d was plotted by a similar procedure that plots cosine against sine, using the values 13, 26, 6. Photo 3f resulted from another similar procedure that plots cosine against cosine, in this case using the values 7, 28, 43.

"neat" enough? Will their appeal be universal? Such questions are clearly impossible for me to answer. If this microworld is of limited interest, perhaps you will have a better idea. More power to you!

The Challenge to Educators

If Piaget's vision that education should involve active discovery of reality is correct and Papert is right in saying that computer-based microworlds provide a solution to the central problem of education, the challenge of education will be more technical in nature than theoretical or ideological.

Clearly, the computer revolution is having a significant impact on education. But that revolution is only worthwhile if it liberates people, which it can by offering educators two remarkable opportunities: with computer technology, teachers will be able to help children expand their love of learning; in turn, teachers will achieve a kind of professional status long denied them. Teachers, programmers, and other microworld designers will be the architects of inner space, proposing ideas and creating tools that will enrich our minds. ■

Acknowledgments

Many people in the extended Logo community have contributed to the ideas of this paper. Seymour Papert's influence is central and obvious. Conversations with people who have worked for or visited Logo Computer Systems in Boston and New York have inspired observations or explanations. Dan Watt's editorial comments have been helpful. The article was revised for publication while the author was a consultant to Le Centre Mondial L'Informatique et Resources Humaine. Thanks to Guy Montpetit for use of the text processor and to the Spencer Foundation for support during a period when these ideas were developing.

References

1. Lawler, R. *One Child's Learning: an Intimate Study*. Unpublished doctoral dissertation. MIT, 1979.
2. Lawler, R. "Some Powerful Ideas." This collection of short pieces is serialized in *Creative Computing*, April, 1982 and following months.
3. Papert, Seymour. "Computer-based Microworlds" in *The Computer in the School: Tutor, Tool, Tutee*. Robert P. Taylor, ed. New York: Teachers College Press, 1980.

Hayes Stack™

Microcomputer Component Systems

At Hayes, we don't believe in second best. Or planned obsolescence. We believe in taking the state of the art to the limit. Our new Smartmodem, for example, is the most sophisticated 300-baud originate/answer modem you can buy. And yet, it is perhaps the easiest-to-use modem ever.

RS-232C Compatible. Smartmodem lets any RS-232C compatible computer or terminal communicate by phone with other computers and time-sharing systems located *anywhere in North America*. You get full and half-duplex operation with both Touch-Tone® and pulse dialing.

Auto-Answer/Dial/Repeat. Smartmodem can answer the phone, dial a number, receive and transmit data, and then hang up the phone—automatically! If desired, Smartmodem will even repeat the last command. You can depend on Smartmodem for completely unattended operation.

Completely Programmable. Smartmodem can be controlled using

any programming language. Over 30 different commands can be written into your programs or entered directly from your keyboard.

Smartmodem also includes several switch-selectable features that let you tailor performance to your exact needs. You can "set it and forget it" for the ultimate in convenience.

Built-in Audio Monitor. Thanks to an internal speaker, you can actually listen to your connection being made. You'll know immediately if the line is busy or if you reached a wrong number—

and you don't even need a phone!

Status at a Glance. Seven LED's indicate Smartmodem's current operating mode: auto-answer, carrier detect, off hook, receive data, send data, terminal ready and modem ready. You're never left in the dark!

Direct-Connect Design. Smartmodem is FCC registered for direct connection to any modular phone jack—there's no acoustic coupler to cause signal loss and distortion.

Smartmodem, Smart Buy. Professional quality features. Versatile performance. A full two-year limited warranty. A suggested retail price of only \$279.

What more could you want? Perhaps the matching Hayes Stack Chronograph, an RS-232C compatible calendar/clock system.

Check out the Smartmodem wherever fine computer products are sold. And don't settle for anything less than Hayes.

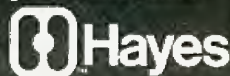

Smartmodem.
The ultimate concept in modems
is now a reality.

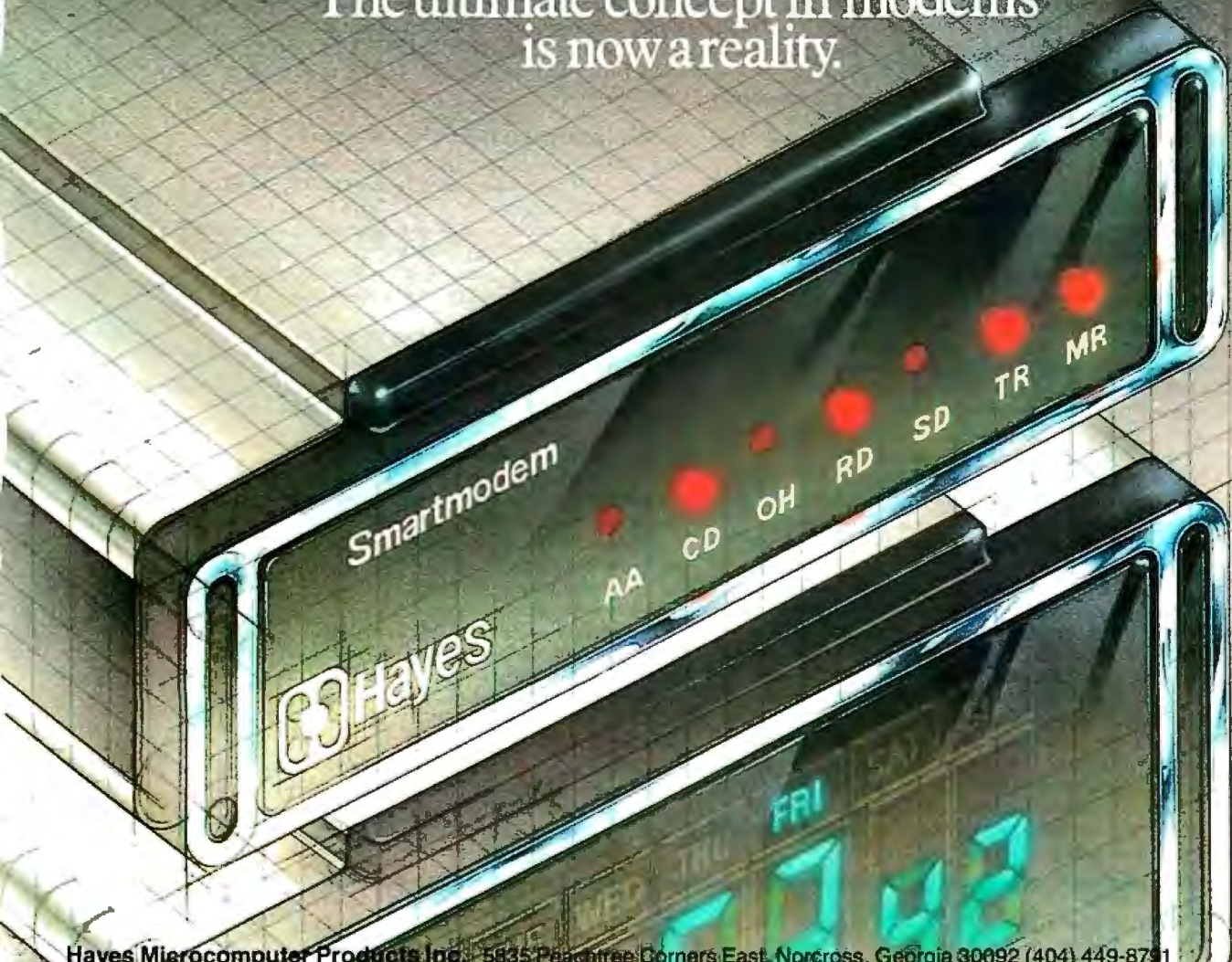

Hayes Microcomputer Products Inc. 5835 Peachtree Corners East, Norcross, Georgia 30092 (404) 449-8751

Hayes Stack is a trademark of Hayes Microcomputer Products, Inc. Sold only in the U.S.A. TM American Telephone and Telegraph © 1981 Hayes Microcomputer Products, Inc.

Introducing **INTEX-TALKER™**

The Professional Voice Quality Text-to-Speech Synthesizer that makes sense



Unlimited Vocabulary

64 Programmable levels of inflection

Built-in 6k text-to-speech algorithm

INTEX-TALKER, the new second generation text-to-speech synthesizer, incorporates all of the features users of earlier synthesizers have requested. Created by Steve Ciarcia, nationally known computer and peripheral equipment designer, INTEX-TALKER provides a new high level of speech intelligibility and voice quality. You've got to hear it to believe it!

INTEX-TALKER translates ASCII characters into speech with an advanced text-to-speech algorithm. Simply type English text and a talk command into your keyboard. User friendly? What could be simpler?

Important Uses of Speech Synthesis

INTEX-TALKER brings a new dimension to interactive computer communications. Available as a stand-alone peripheral or at the board level, INTEX-TALKER provides a real time audio interface for applications in data processing, telecommunications, automation, education or handicapped markets. It can announce data transmitted at high baud rates over telephone lines or serve as an unlimited vocabulary audio interface for telephone transaction applications. Featuring 64 digitally programmable levels of inflection, INTEX-TALKER offers a unique, high fidelity professional voice quality.

Equipped with keyboard, INTEX-TALKER can function as a typewriter for the blind or as a communicator for the vocally impaired. Every ASCII character is recognized (including punctuation) as it is typed and can be echoed automatically.

As a computer-aided educational device, INTEX-TALKER can provide interactive student instruction on literally any subject. For entry level students, INTEX-TALKER can provide a user friendly environment enhancing the learning process and encouraging the development of student familiarity with the computer keyboard.

And with home computers, INTEX-TALKER adds both fun and utility. Computer games come to life. Your computer can now speak instructions, warnings, praise — and it has music and sound effects capabilities, too.

You can easily apply the capabilities of INTEX-TALKER to any of your home computer uses; security, education, or home management.

Easy to Operate

ASCII code is sent to INTEX-TALKER through either the RS232C or parallel interface. The English text is stored in a 750 character buffer until the processor commands it to be automatically translated into electronically synthesized speech. For example: type the ASCII characters spelling "I-N-T-E-X" to cause the word "INTEX" to be spoken on command.

Independent Operation/No Overhead

INTEX-TALKER can also be used as a dedicated controller. It has user expandable memory with 16k ROM and 8k RAM capacity.

With its own 6502 microprocessor and built-in 6k text-to-speech algorithm, INTEX-TALKER operates without overhead. The host computer is free to execute other programs while INTEX-TALKER is speaking.

At Only \$295.00 INTEX-TALKER Offers These Features:

- Phoneme based speech synthesizer chip
- 64 crystal controlled inflection levels - digitally programmable
- 6k text-to-phoneme algorithm
- 750 character buffer
- Full ASCII character set recognition and echo
- Adjustable Baud Rate (75-9600)
- RS232C or Parallel connectors
- X-on/X-off handshaking
- Phoneme access modes
- User expandable memory
- Music and sound effects capability (programming language for notes included)
- Onboard amplifier & power supply $\pm 12V$; +5V
- Spelling output option

Order Now

Call the number below to order or request additional information. Master Charge or Visa accepted. Charge to your credit card or send a check for \$295.00 plus \$4.00 delivery. Add 4% sales tax in Michigan.

Dealer inquires invited.

Intex Micro Systems Corporation
755 West Big Beaver Road - Suite 1717
Troy, Michigan 48084
Telephone: 313/362-4280

Why Logo?

Logo is designed to encourage development of problem-solving skills.

Brian Harvey
Logo Computer Systems Inc.
368 Congress St.
Boston, MA 02210

Logo is a language for learning. That sentence, one of the slogans of the Logo movement, contains a subtle pun. The obvious meaning is that Logo is a language for learning programming; it is designed to make computer programming as easy as possible to understand. But Logo is also a language for learning in general. To put it somewhat grandly, Logo is a language for learning how to think. Its history is rooted strongly in computer-science research, especially in artificial intelligence. But it is also rooted in Jean Piaget's research into how children develop thinking skills.

In a certain sense, all programming languages are the same. That is, if you can solve a problem in one language, you can solve it in another—somehow. What makes languages different is that some types of problems are easier to solve in one language than in another. Language designers decide what kinds of problems their language should do best. They then make design choices in terms of those goals.

About the Author

Brian Harvey is director of the computer center at Lincoln-Sudbury Regional High School, 390 Lincoln Rd., Sudbury, MA 01776. He modified Logo for its PDP-11 minicomputer.

Logo as a Programming Language

Let's postpone for a while the broader educational issues. First, we'll consider Logo simply as a programming language. How is it similar to other languages; how is it different? Syntactic details aside, there are several substantial points of language design through which Logo can be compared to other languages.

Logo is procedural. A programming project in Logo is not written as one huge program. Instead, the problem is divided into small pieces, and a separate *procedure* is written for each piece. In this respect, Logo is like most modern languages. Pascal, APL, LISP, C, and even FORTRAN permit the division of a program into independent procedures. Among the popular general-purpose languages, only BASIC lacks this capability. (The sample Logo programs in this article are written in Apple Logo, a dialect written by Logo Computer Systems Inc. Other versions of Logo will be slightly different in details.)

Consider the Logo program in listing 1a. Even if you don't know anything about Logo, it's probably obvious what this pair of procedures does. Compare it to the BASIC version in listing 1b.

The GOSUB construct in BASIC is weaker than a true procedure capability in several ways. For one thing,

the BASIC subroutine is not an independent program; if line 100 were omitted, the program would "fall into" the subroutine. More important, there is no concept in BASIC of inputs to procedures, like QUESTION and ANSWER in the Logo program. Instead, extra statements must be used to assign values to the variables Q\$ and A\$, explicitly.

This explicit assignment is not simply an inconvenience. It means that the main part of the program has to "know" about the inner workings of the subroutine. In the Logo version, the procedure named QUIZ knows only that the procedure QA has two inputs, a question and an answer. If QA were modified to use different names for the variables, QUIZ would still work. Similarly, although this particular example doesn't show it, Logo procedures can have an *output* that is communicated to the calling procedure. (The DEF statement in BASIC provides a limited version of procedures with outputs; the limitations are that the inputs and outputs must be numbers, and the definition must be a single line without conditional branching.)

Logo is interactive. Like BASIC, but unlike Pascal, Logo lets you type in a command to be carried out *right away*. It's also quick and easy to change one line of a program. Other interactive languages are LISP and

Listing 1: Comparison of Logo and BASIC. Each program asks the same set of three questions and compares the user's response to the author's answer. In the BASIC version (listing 1b), the "questioning" subroutine (lines 1000-1110) is not an independent program. In the Logo version (listing 1a), the procedure QA could stand alone, and might conceivably be used by other programs.

(1a)

```
TO QUIZ
QA [WHAT'S THE BEST MOVIE EVER?] [CASABLANCA]
QA [HOW MUCH IS 2 + 2?] [5]
QA [WHO WROTE "COMPULSORY MISEDUCATION"?] [PAUL GOODMAN]
END
```

```
TO QA :QUESTION :ANSWER
TYPE :QUESTION
TEST EQUALP :ANSWER READLIST
IFTRUE [PRINT [YOU'RE RIGHT!]]
IFFALSE [PRINT SENTENCE [NO, DUMMY, IT'S] :ANSWER]
END
```

(1b)

```
10 Q$ = "WHAT'S THE BEST MOVIE EVER?"
20 A$ = "CASABLANCA"
30 GOSUB 1000
40 Q$ = "HOW MUCH IS 2 + 2?"
50 A$ = "5"
60 GOSUB 1000
70 Q$ = "WHO WROTE 'COMPULSORY MISEDUCATION'?"
80 A$ = "PAUL GOODMAN"
90 GOSUB 1000
100 GOTO 9999
1000 PRINT Q$;
1010 INPUT R$
1020 IF R$ = A$ THEN GOTO 1100
1030 PRINT "NO, DUMMY, IT'S ";A$
1040 RETURN
1100 PRINT "YOU'RE RIGHT!"
1110 RETURN
9999 END.
```

APL; other noninteractive languages are C and FORTRAN.

Whether or not a language is interactive has an effect on its efficiency. In brief, program development is generally faster with an interactive language, but already-written programs generally run faster in a language that is not interactive. The difference has to do with the mechanism by which the computer "understands" your program.

Every computer is built to understand one particular language. This machine language is different for each type of computer. Since machine-language instructions are represented as numbers, they're not easy for people to read. For example, the number 23147265 might mean "add the number in memory location number 147 to the number in memory loca-

tion 265." Programs written in a high-level language, including Logo and the other languages mentioned here, must be translated into machine language before the computer can carry them out. This translation is done by another computer program that comes in one of two flavors: compiler or interpreter.

A Pascal compiler, for example, takes a program written in Pascal and translates (compiles) it into the machine language of whatever computer you're using. The translated program is permanently saved as machine language (probably as a file on your floppy disk). Thereafter, the machine-language program can be executed directly. The compiling process takes a long time. But once it's finished, running the compiled program is very fast because it need

never be compiled again.

A Logo interpreter, on the other hand, does not create a permanent machine-language version of your program. Instead, each Logo statement is translated and executed every time the statement is supposed to be executed. The interpreter does not produce a machine-language representation of your program, but simply carries out the machine-language steps itself. If a Logo statement is to be executed six times, it's translated six times. (Actually, some interpreters, including Apple Logo, save a partial translation of each procedure, so that the second execution is somewhat faster than the first; this process is too complicated to explain in this article.)

Interpreted languages can be interactive. Suppose you want to find the value of 2+2 in Pascal. First, you must use the text-editor part of your Pascal system to write a disk file containing a Pascal program. Then, you run the Pascal compiler, which will translate the program into machine language. Finally, you run the compiled program and your computer types out 4. In an interpreted language like Logo, you can simply type PRINT 2 + 2 to see the same result.

The situation in which interaction is most important is program development. If you are writing a complicated program, it probably won't work right the first time you try it. You'll have to try it, see what goes wrong, change the program, and try again. In order to see what went wrong, you'd like to be able to use interactive debugging. (You stop the program where the error happens and type in commands to examine the values of variables at that moment.) This debugging cycle may be repeated many times before the program finally works completely. Even though a compiler might make the program run faster, an interpreter is likely to make the entire debugging process faster because it's so much easier to find and fix your mistakes. It's only after the program works, and you want to use it every day without modification, that the compiled version is really faster.

IBM PERSONAL COMPUTER USERS

COMPLETE YOUR REFERENCE LIBRARY

Que On Systems

IBM's PERSONAL COMPUTER

Que Corporation's new 300 page book, IBM's PERSONAL COMPUTER describes the hardware, peripherals and IBM's program library. Whether you are an IBM Personal Computer user or prospective buyer, you will discover the significance of IBM's new product to your personal or business applications.

...at computer stores and fine book stores \$14.95



and...

PERSONAL COMPUTER AGE

The Definitive Journal For The IBM Personal Computer User

Keeps you updated monthly with the latest news and applications for your IBM Personal Computer. Featuring: Hardware and Software Reviews — New Product Announcements — Technical Articles — Problem Reporting — Vendor Directory — Classified Ads — Special Interest Columns.

\$18.00/YR.
(12 issues)



BOTH FOR ONLY \$22.95

PERSONAL COMPUTER AGE

For Credit Card Orders, Dial Toll Free
(800) 227-2634 ext. 936
In California
(800) 772-2666 ext. 936

- I Want Everything — PERSONAL COMPUTER AGE and IBM's PERSONAL COMPUTER for \$22.95
- NEW RENEWAL
- Send the Book only for \$14.95
- Just enter my subscription to PERSONAL COMPUTER AGE for \$18.00
- Payment Enclosed

Charge my: VISA MASTER CHARGE

Card # _____

Expiration Date: _____

Authorized Signature _____

Name _____

Address _____

City _____

State _____ Zip _____

PERSONAL COMPUTER AGE P.O. BOX 70725 Pasadena, California 91107 Dept. B1

Butch Brown believed "logic seeking heads" lived in the hippie district.

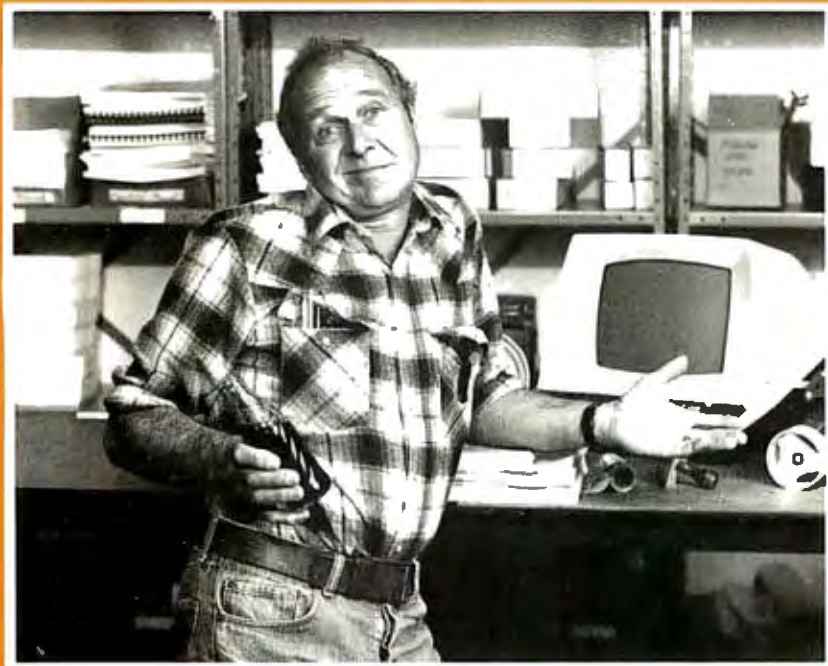

Until he became an Orange Micro Printer Expert.

Printers Can Be Confusing. Sometimes, even the informed personal computer owner is caught short by the mound of technical differences in printers. After one visit to Orange Micro, Butch learned a logic-seeking print head skips over blank spaces and seeks the fastest path to the next printable character—for quick stock record printouts.

We Educate

First. With so many different printers out there with as many different features, we feel a printer education is in order. We take what you already know about computers and explain printers in the same terms. Our current customers seem to like that because of the friends they refer. (Nearly 50% of our business is referral.)

It's Easy To Be An Expert. Orange Micro printer specialists are there to make you feel comfortable with your newfound printer knowledge. And when you decide on the printer right for you, you'll know exactly why you picked it from all the rest. With over 35



popular models to choose from, and a complete selection of cables, options and interface accessories, we have everything you need to get your new printer up and operating in minutes.

We Have The Right Printer For You.

Bring along your toughest printer questions. Our salespeople will answer them honestly and practically. In less time than you'd imagine possible, you'll be a printer expert too! After all, printers are our only business, so we always do a better job at finding the right one for you.

Orange Micro Printer Stores

3150 E. La Palma, Suite 1
Anaheim, CA 92806 (714) 630-3622

13604 Ventura Boulevard
Sherman Oaks, CA 91423 (213) 501-3486

3216 Scott Boulevard
Santa Clara, CA 95051 (408) 980-1213

1104 Van Ness
San Francisco, CA, 94109 (415) 673-0170



Limited Franchise Opportunities Now Available. Call (714) 630-3620

Circle 308 on Inquiry card.

The flexibility and ease of use of an interactive language is particularly valuable in an educational setting. For a student of programming, there often is no production phase—the program is of interest only as long as it doesn't work. When it does work, the student goes on to the next problem. In that sort of environment, the speed advantage of the compiler never materializes. In a business environment, on the other hand, the actual production use of a program is likely to be more important, which makes a compiler more desirable.

Some languages use mixed schemes. BASIC (normally an interpreted language) has compilers that allow the user to give up interaction for efficiency. Some LISP compilers can coexist with interpreters, so that some procedures can be compiled while others are being debugged interactively. Some versions of Pascal are compiled into an intermediate language called p-code, which is then interpreted. FORTH uses a similar system of partial compilation, but the compiler is part of the run-time environment, so single statements can be compiled and run interactively.

Logo is recursive. In a procedural language, one procedure can use another procedure as a *subprocedure* to do part of its work. A language is *recursive* if a procedure can be a subprocedure of itself.

All modern procedural languages allow recursion. Among widely used languages, only FORTRAN allows procedures but not recursion. (BASIC, as was mentioned earlier, has neither.) It may seem as though recursion isn't too important. Why should it be any different from any other use of subprocedures? It's hard to explain in a simple way why recursion is important. The idea behind recursion, though, has profound mathematical importance. By allowing a complicated problem to be described in terms of simpler versions of itself, recursion allows very large problems to be stated in a very compact form.

A well-known example of a problem best solved using recursion is the Tower of Hanoi puzzle. This puzzle

Circle 250 on Inquiry card. →

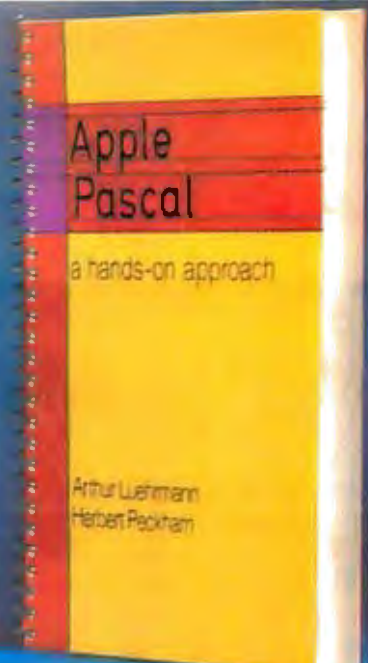
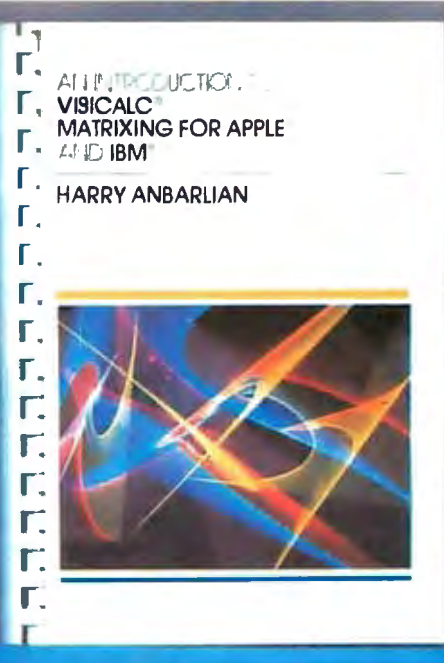

Hardware Helpers

Making the most of your hardware? Here's hands-on programming help from the experts — help you won't find elsewhere — to show you how to get your money's worth ... *plus!* Little or no math is required. And hundreds of detailed program examples and practical exercises make each step easy!

Introduction to VisiCalc® Matrixing
Harry Anbarlian 224 pp., \$22.95
Few VisiCalc users are taking *full* advantage of this extremely powerful planning and forecasting tool. Here at last is the how-to for quickly and simply creating matrixes tailored to your specific needs. From corporate financial planning to managing a stock portfolio, it gives you practical guidance you won't find in the VisiCalc manuals ... or anywhere else in print.

Apple® PASCAL: A Hands-On Approach
Arthur Luehrmann and Herbert Peckham 384 pp., \$16.95
This spiral-bound guide puts the most powerful language a computer can have *at your fingertips*—gives you all the working skills you need to create, run, and debug programs in Pascal on the Apple II or Apple II Plus. Leads you painlessly from fundamentals to data structures, recursion, and other advanced topics.

Hands-on BASIC for the IBM® Personal Computer
Herbert Peckham 352 pp., \$19.95
This authoritative manual demonstrates how hands-on BASIC and the IBM Personal Computer make a perfect match. The book helps you make the most of your IBM Personal Computer — *and* master the useful BASIC language. Plus, it covers applications using graphics and sound.

VisiCalc is a registered trademark of VisiCorp, Inc. Apple is a registered trademark of Apple Computer, Inc. IBM is a registered trademark of International Business Machines.

Also available:



BASIC: A Hands-On Method, 2/e
Herbert Peckham 306 pp., \$14.95
Useful with both time-sharing and personal computers, this expanded second edition of the popular spiral-bound manual stresses hands-on experience to help you quickly become proficient in BASIC programming. Includes new material on string operations.

Programming BASIC with the TI Home Computer
Herbert Peckham 256 pp., \$17.50
Goes far beyond the "Beginner's BASIC" furnished with the TI Home Computer, so you can explore the full range and power of TI BASIC, including color and sound.

Hands-on BASIC with a PET
Herbert Peckham 267 pp., \$15.95
Fully explains in a friendly, relaxed manner exactly how to program Commodore Business Machines' PET Personal Computer using BASIC.

The Elements of Programming Style, 2/e
Brian W. Kernighan and P.J. Plauger 168 pp., \$11.95
This second edition of the classic guide to efficient, effective programming for a wide range of tasks includes a useful set of rules for good programming — and numerous examples.

Available at your bookseller or computer store. Or use coupon for 15-day FREE examination!

McGraw-Hill Book Company
P.O. Box 400, Hightstown, NJ 08520

Please send me the book(s) checked for 15 days on approval.

- Bill me. After 15 days I will pay for the book(s) I keep, plus postage, handling, and local tax, and return any unwanted book(s) postpaid.
- Enclosed is my check/money order (including tax). McGraw-Hill pays postage and handling. I may return unwanted book(s) within 15 days for refund.
- INTRODUCTION TO VISICALC MATRIXING, \$22.95 (001605-4)
- APPLE PASCAL: A HANDS-ON APPROACH, \$16.95 (049171-2)
- HANDS-ON BASIC FOR THE IBM PERSONAL COMPUTER, \$19.95 (049147-0)
- BASIC: A HANDS-ON METHOD, 2/e, \$14.95 (049160-7)
- PROGRAMMING BASIC WITH THE TI HOME COMPUTER, \$17.50 (049156-9)
- HANDS-ON BASIC WITH A PET, \$15.95 (049157-7)
- ELEMENTS OF PROGRAMMING STYLE, 2/e, \$11.95 (034207-5)

Name _____

Address/Apt. _____

City/State/Zip _____

62-U405-2144-3

DECIS

Minicomputer performance in

Multi-user. Multi Tasking. Decision I™ memory management hardware includes a memory map that is similar to the IBM 360® and IBM 370®. It supports up to 16 tasks or 15 users and a supervisor without swapping. And, more with swapping. Each task or user enjoys complete memory protection and dynamic memory allocation. One task may be delegated as a supervisor to privileged system functions forbidden to ordinary tasks or users. Such functions (I/O calls, unauthorized memory access, etc.), will trap to the supervisor. If supervisory functions are not required the system can be configured for turnkey multi-user operation.

Multi-purpose IEEE696/S-100. Decision I utilizes the Morrow Designs IEEE Standard S-100 Wunderbuss®. That means you can configure it to your specific applications. Add a floating point processor, add memory (to a full megabyte), add I/O, add controllers... add boards from dozens of manufacturers. And S-100 has a major advantage over single-board computers: If a board goes down, you simply replace it. And keep running. If you want to expand your system. Add boards and terminals.

An unmatched software base. Decision I runs on the M/OS™ operating system. M/OS supports all system calls source

compatibly with UNIX®. Thus, UNIX programs will compile directly and UNIX documentation is almost totally applicable. Morrow CP/M® has been configured to run under M/OS and communicate with both CP/M and UNIX standard media for maximum portability. Languages available include BASIC, COBOL, FORTRAN, RATFOR, Pascal and C. That means Decision I offers you a software base unmatched in its price/performance arena.

The OEM machine. A basic multi-user system at \$5,225 includes the Decision I, 4 Mhz Z80A-based CPU, sophisticated memory

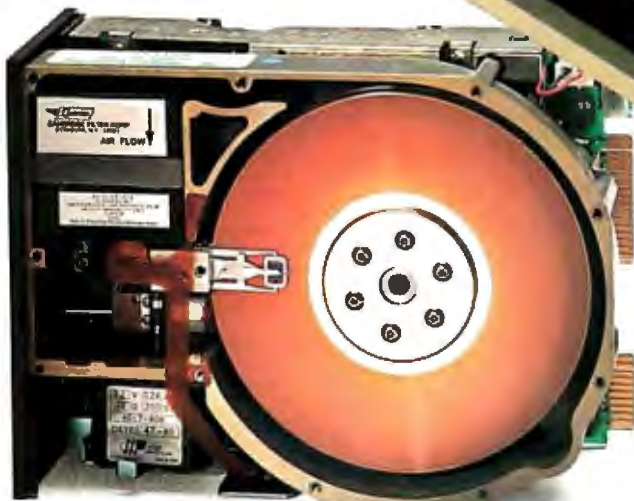

IBM 360 and 370 are trademarks of IBM Corp.
Wunderbuss is a registered trademark of Morrow Designs
Decision I and M/OS are trademarks of Morrow Designs
UNIX is a trademark of Bell Laboratories, Inc.
CP/M is a trademark of Digital Research Corp.

ION 1

a multi-user Microcomputer.



management hardware, CP/M 2.2, M/BASIC 5.2, 3 serial and 2 parallel I/O ports, 14 I/O slots with S-100 connectors, supervisor control in both hardware and software, 128K of RAM and two quad-density disk drives (800K) with DMA controller. Plus, cabinet (either desk-top or rack-mount), and power supply. The same system with 8" floppies and a full Megabyte of formatted storage costs \$5,659. And, we offer OEM pricing.

A better microcomputer. Whether you're building a single or multi-user system, the Decision I offers you a hardware/software combination unmatched in the field. Decision I is not simply an improved 8-bit microcomputer. It's a breakthrough. In both computing power and price.

Systems your way. Morrow Designs' full range of hard and floppy disk memory, add-in memory boards, I/O

boards, controllers and software allow you to configure your system your way...through a single supplier.

The decision is yours. Compare the Decision I, feature-for-feature with mini or microcomputers on the market today. Compare capabilities. Compare flexibility. Compare utility. Then, compare price. We think Decision I will change the way you think about microcomputer systems.

Complete information? See your computer dealer. Or, write Morrow Designs.

LOOK TO MORROW FOR ANSWERS.

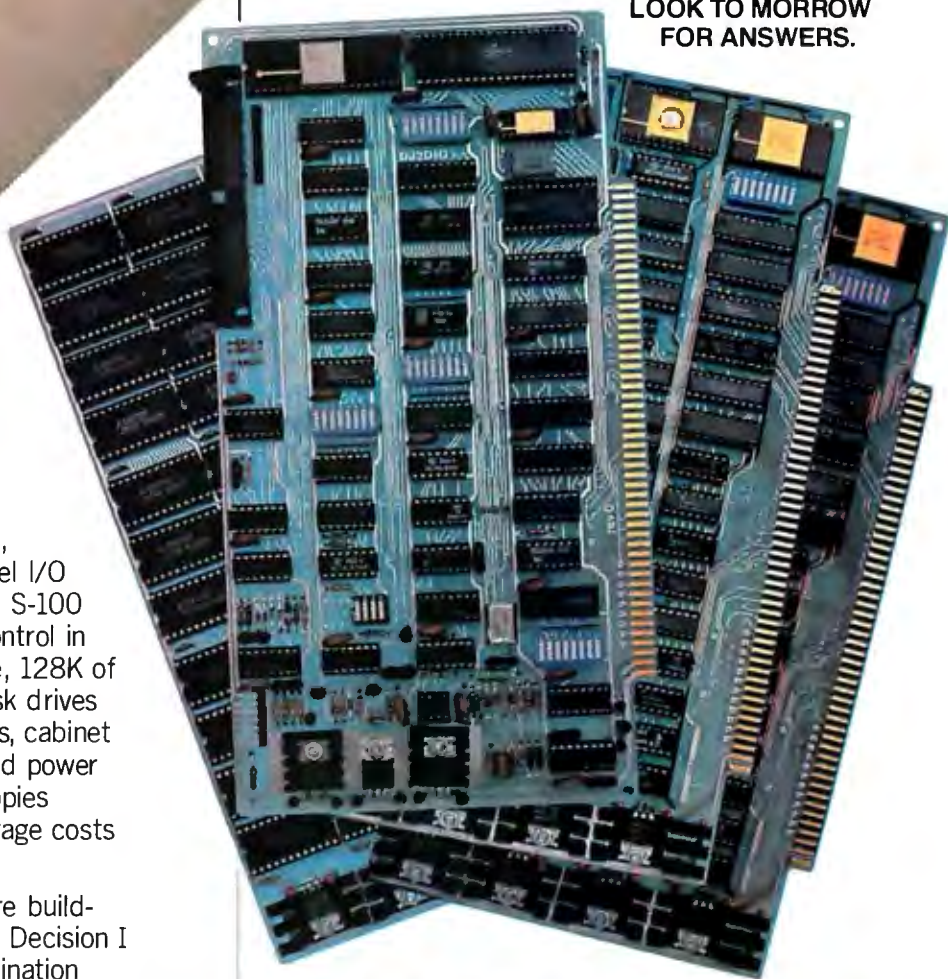

MORROW DESIGNS

5221 Central Avenue, Richmond, CA 94804
(415) 524-2101



Circle 286 on inquiry card.

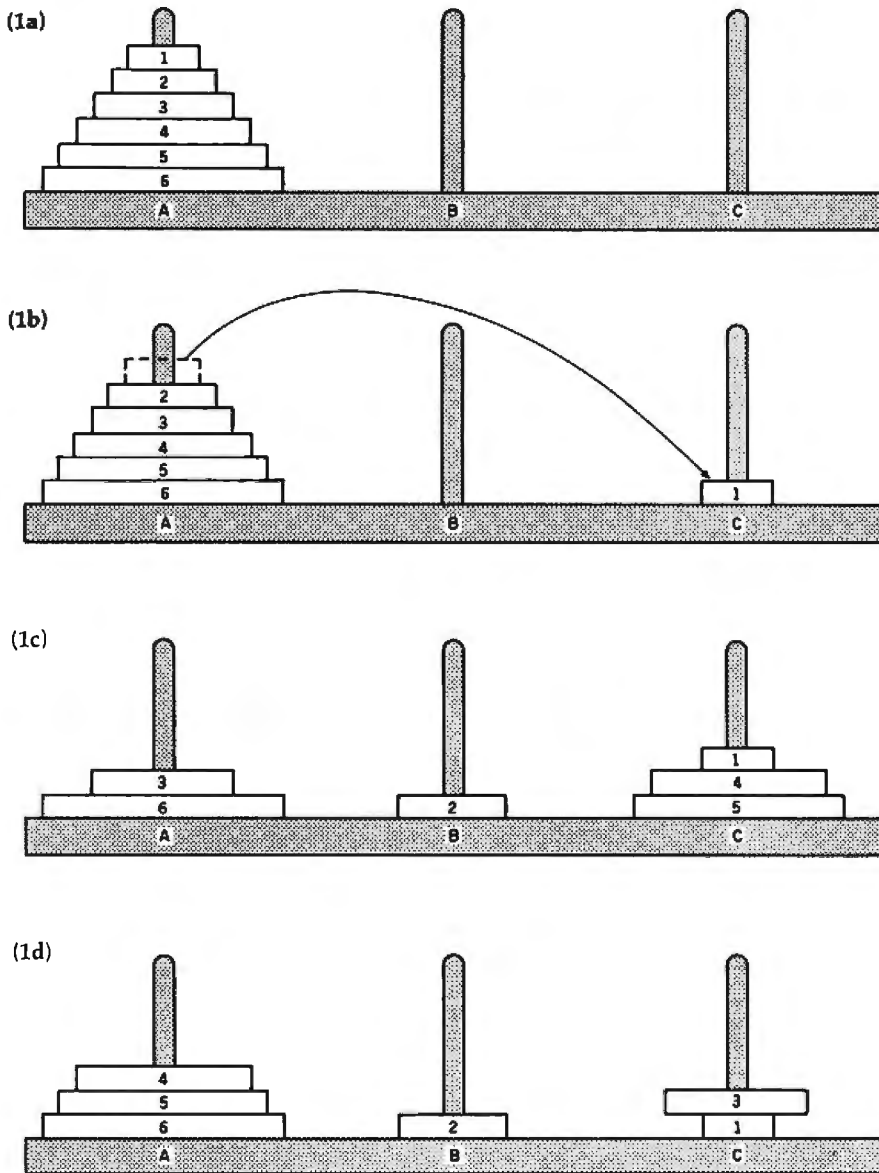

Figure 1: Typical moves in the Tower of Hanoi puzzle. Figure 1a shows the initial position, figure 1b the first move, and figure 1c the position after several moves. Figure 1d shows an illegal situation with a larger disk on a smaller one.

has a number of different-size disks piled initially on one of three pegs, with the smallest at the top. The problem is to move the disks onto a different peg, moving one disk at a time and never moving a disk onto a smaller disk (see figure 1).

To solve this problem, first notice that it's very easy with only two disks (see figure 2a). It's easy to see that we have to get disk 2 onto peg B somehow. To do that, we have to get disk 1 out of the way. Therefore, move disk 1 to peg C, disk 2 to peg B, and disk 1 to peg B.

Now suppose there are six disks (see figure 2b). Again, we have to begin by getting disk 6, the largest one, from peg A to peg B. But now there are five disks in the way, not just one. This provides us with a subproblem: move five disks from peg A to peg C. But this is exactly the Tower of Hanoi puzzle itself with five disks instead of six! The subproblem is a simpler version of the main problem. This calls for the recursive solution shown in listing 2.

In working through this program, bear in mind that each use of the

HANOI procedure has its own, private variables; the value of NUMBER, for example, remains constant throughout any particular use of the procedure, even though there is another use of HANOI with a different value for NUMBER in the middle.

In addition to Logo, many other languages allow recursion (these include Pascal, C, LISP, and APL). The style of Logo, however, encourages the use of recursion more than some other languages. C and Pascal allow recursion but encourage iteration. (Iteration means telling the computer to execute something repeatedly. The FOR . . . NEXT construct in BASIC is an example.) Logo is the other way around: iteration is possible, but recursion is preferred. For many purposes, neither approach is clearly right. Iteration is somewhat simpler for the situations in which it works at all; in some cases like the Tower of Hanoi puzzle, however, nothing but recursion will do.

Until recently, iteration was much more efficient than recursion, both in speed and in the use of memory. A major advance in recent implementations of Logo, including the versions available for the Apple II and the Texas Instruments TI-99/4A microcomputers, is that *tail recursion* is recognized by the interpreter and treated as if it were written as iteration. Tail recursion is the situation in which the recursive use of a procedure is the last thing done in the procedure. In general, it is only tail-recursive programs that could just as easily be done iteratively. The HANOI procedure, for example, is not tail recursive because two recursive procedure calls are in it, only one of which is at the end.

Logo has list processing. Every major programming language has some way to group several pieces of information (numbers, for example) into one large unit. In FORTRAN and BASIC, this mechanism is the array. In Pascal and C, arrays are also used, along with a more complicated grouping called a record in Pascal or a structure in C. In Logo, the main grouping mechanism is called the *list*.

Lists and arrays have two major differences. First, arrays have a fixed

“I’ve been
dying to say
something
and now
I can!”

Now, thanks to TYPE-'N-TALK™ your computer can talk.

This exciting text-to-speech synthesizer gets your computer talking about any subject you choose—from data verification to educational testing and games. And, of course, enhancement of any computerized adventure series.

By adding a voice to your computer, printed matter can be eliminated from the screen. Directions, information and questions can be vocalized, leaving the screen free for other tasks. It's no longer necessary to shrink a dazzling graphic to show the accompanying text. Just let TYPE-'N-TALK™ speak it out.

And now, great new software is available.

TYPE-'N-TALK™ has unlimited vocabulary, an RS-232C interface, and is one of the easiest-to-program speech synthesizers on the market.

TYPE-'N-TALK™ is covered by a limited warranty. Write Votrax for a free copy. 500 Stephenson Highway, Troy, Michigan 48084.

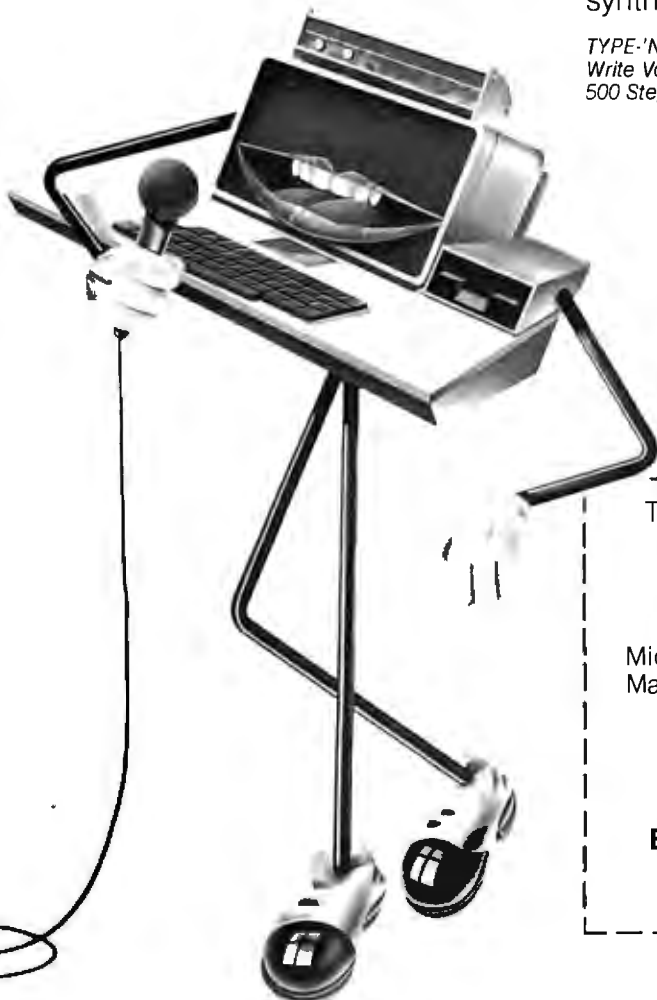

To order, see your local computer retailer or call toll-free

1-800-521-1350

Michigan residents, call (313) 588-0341. MasterCard & Visa accepted. Add sales tax in Michigan and California.

TYPE-'N-TALK™

\$375 Plus \$4 delivery
Educational discount available



© 1982 VOTRAX

Circle 421 on Inquiry card.

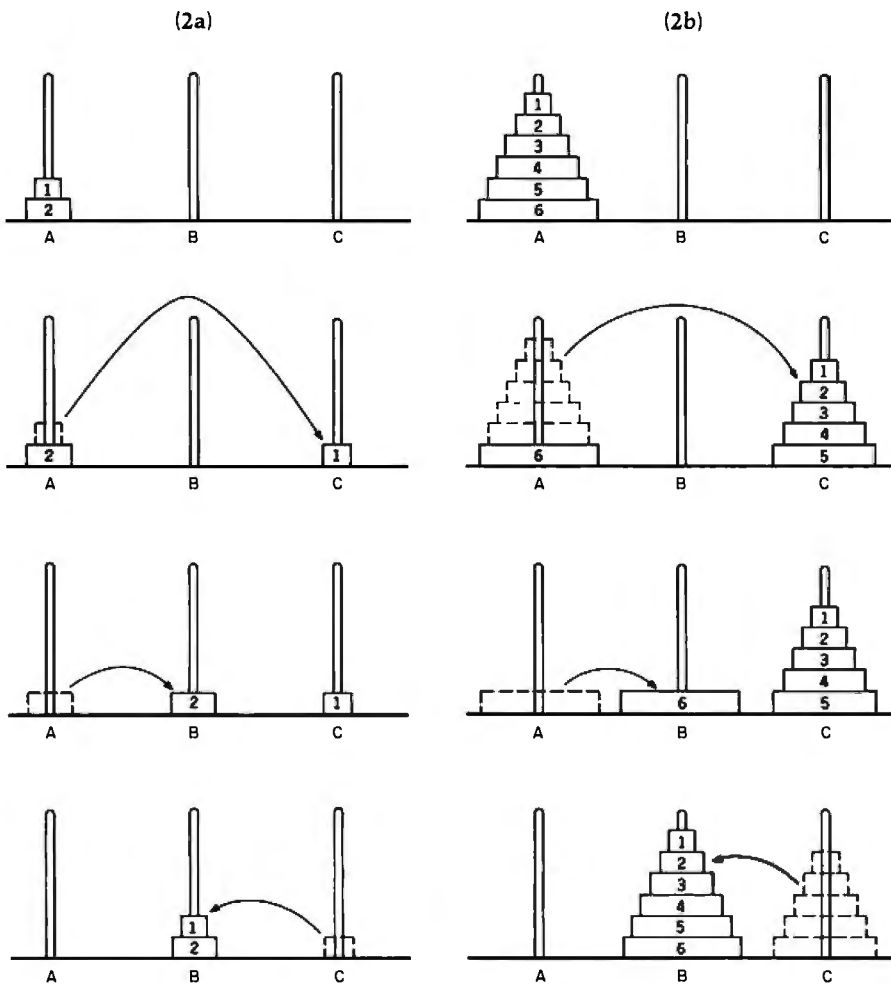

Figure 2: How the puzzle breaks down into simpler subproblems with similar solutions. Figure 2a shows the simplest solution to a puzzle involving only two disks. Figure 2b shows the situation when the same procedure is used on more disks.

Listing 2: General solution to the Tower of Hanoi puzzle in Logo. The program requires four inputs. The variable NUMBER tells the program how many disks to the puzzle; the other three inputs are the names of the pegs. The IF statement detects the trivial subproblem of moving zero disks, for which there is nothing to do.

The solution is found by dividing the problem into a series of simpler subproblems, all of which can be solved by repeating a simple series of moves. First, move all but the bottom disk to the third peg; then, move the bottom disk to the destination peg; and finally, move all but the bottom disk to the destination peg (see figure 2).

```
TO HANOI :NUMBER :FROM :TO :OTHER
IF :NUMBER = 0 [STOP]
HANOI :NUMBER - 1 :FROM :OTHER :TO
PRINT (SENTENCE [MOVE DISK] :NUMBER [FROM PEG] :FROM [TO PEG] :TO)
HANOI :NUMBER - 1 :OTHER :TO :FROM
END
```

```
HANOI 6 "A "B "C
```

size, while lists can become bigger or smaller as a program executes. (There is no equivalent in Logo to BASIC's DIM statement, which is used to specify how big an array will be.) The second difference is that arrays must be uniform. That is, you can have an array of 12 numbers, or an array of strings each 23 characters long, but you can't have an array of some of both. (A Pascal record or C structure can have some of both, but only in one predeclared pattern.) Each element of a Logo list can be any Logo object: a number, a word, or even another list. Thus, the following are examples of lists:

```
[VANILLA CHOCOLATE MOCHA]
```

```
[VANILLA [MINT CHOCOLATE CHIP]
[FUDGE SWIRL]]
```

```
[BANANA 3.14159 [RED BLUE
YELLOW] 2.71828]
```

```
[FLAVORS [VANILLA CHOCOLATE]
SIZES [LARGE SMALL]
OPTIONS [[HOT FUDGE]
[SUGAR CONE]]]
```

The first of these is a list of three words. The second is also a list with three members, but the first is a word and the others are lists. The third example shows that numbers can be included. The last example demonstrates that a list can contain a list that contains a list.

The last example is a special kind of list, called a property list. If this property list were associated with the name ICECREAM, the Logo statement

```
PRINT GPROP "ICECREAM "SIZES
```

would print:

```
LARGE SMALL
```

(GPROP stands for Get PROProperty.) Property lists are a convenient way to group related information. Imagine, for example, a Spacewar game program with several ships, each with a property list. The properties might be the ship's position, velocity, shape, remaining energy, and so on.

The reason that some languages restrict you to using arrays is that, being uniform and of fixed size, they are



Think Now!

Multi-user MP/M™ 8-16* runs 8 bit CP/M® software better than it's ever been run before.

With an **MP/M 8-16** system, your 8 bit programs are . . .

- **BIG**—over 61K! That's over 6K more user space than conventional CP/M 2.2™!
- **FAST**—DMA floppy and hard disks with cache buffering. Solid state memory disks. High speed (8 MHz) CPU's.
- **MULTI-USER**—Programs shine and applications flourish in a multi-user environment designed by the best (Digital Research) to meet the demands of professionals.

Think Ahead!

MP/M 8-16 runs 16 bit CP/M 86™ software, so you can get what's coming!

■ You can **UPGRADE** effortlessly from 8 to 16 bit software (for example, from CBASIC™ to CBASIC 86™) without leaving your programs or data behind. You get complete file compatibility between 8 and 16 bit CP/M. Other systems make you choose between 8 and 16 bits.

MP/M 8-16 systems have two CPUs—one 8 bit, one 16 bit. You get it all. Now. And tomorrow.

■ Even the hardware is upgradable. Our boards are compatible with the IEEE 696 bus (and we've got 20 bus slots!). Our state-of-the-art systems can keep pace with the state-of-the-art. Just add boards.

■ All boards in our **MP/M 8-16** systems are CompuPro's Certified System Components, which includes a two year immediate replacement warranty.

G&G Engineering and CompuPro™ do it best!

MP/M 8-16 systems start at \$8995, terminals not included.

G&G Engineering is an authorized CompuPro systems center. We offer completely integrated CompuPro based systems running CP/M, MP/M, and UNIX.®

Think **G&G** ENGINEERING!

1922 Republic Avenue, San Leandro, California 94577 (415) 895-0798

*MP/M 8-16 is a proprietary implementation of Digital Research's MP/M 86 operating system, configured for CompuPro by G&G Engineering.
CompuPro is a trademark of Godbout Electronics; MP/M 86, CP/M, CP/M 2.2, CP/M 86, CBASIC and CBASIC 86 are trademarks of Digital Research; UNIX is a trademark of Bell Laboratories.

Circle 182 on inquiry card.

more efficient to deal with. The restrictions on arrays mean that if the computer knows where the beginning of some array is located in memory, the location of the *n*th element of the array can be calculated easily, no matter what values the elements actually have.

With a list, the size of each element is variable. Therefore, lists are stored in a more complicated way. As a result, to find the fourteenth element, you have to start with the first one, figure out where the second one is, then figure out where the third one is, etc. Since this is all done automatically by the Logo interpreter, lists aren't hard for the programmer to use, but it's somewhat slower than finding something inside an array.

Among major languages, LISP uses lists much like those in Logo. (In fact, the data structures in Logo are based on those of LISP. LISP's name stands for LISt Processing.) APL uses a data structure that is like lists in that it is not fixed in size, but is like arrays in

that it is uniform in composition. In other words, an APL vector can grow or shrink, but it has to be all numbers or all characters. Pascal and C don't have lists, but they have pointer variables that can be used along with records or structures to build the equivalent of lists. FORTRAN and BASIC don't have dynamic storage allocation—you can't make something bigger in the middle of the program—so there is no way to create lists in them.

Logo is not typed. In BASIC, if you want a variable to contain a character string, you put a dollar sign at the end of its name. If you don't use the dollar sign, the variable must contain a number, not a string. (Some versions of BASIC have a third type: a variable whose name ends with a percent sign contains an integer, or whole number.) In Pascal and C, the *type* of a variable must be given explicitly in a declaration. In FORTRAN, variables can be declared as in Pascal; if a variable isn't declared, its type

depends on the first letter of its name. The letters I through N indicate integer variables.

In Logo, as in LISP and APL, variables are not typed. Any variable can take on any value. The same variable can be an integer at one point in the program and a character string (called a word in Logo) later on.

Originally, variable typing wasn't a matter of language-design philosophy. Variables were typed to make life easier for the people who wrote compilers. Since different machine-language instructions are used, for example, to add integers and to add numbers with fractional parts, it's easier to translate "A+B" into machine language if you know ahead of time whether or not A and B are integers.

More recently, some language designers have taken the position that variable typing is a good thing, apart from implementation issues, because it disciplines the programmer to use a variable for only one purpose. In re-

HONORABLE...

Introducing the Honorable Shell—

OKARA™

A true breakthrough in operational technology for CP/M™ systems. OKARA lets you, the user, create command scripts to replace the boring, repetitive, error-prone keyboard dialogs normally required by CP/M and the programs that run under it. With OKARA the machine presents any personality you design, from simple cryptic commands that do it all to elaborate, hand-holding menus. OKARA is a must for anyone who uses CP/M. And a super-must for system integrators, software developers, office managers, teachers, parents... anyone who sets up CP/M applications for others.

- Fast**—20 to 100 times faster than SUBMIT, SUPERVYZ,* or STOK PILOT.™
- Tiny**—Typically under 3K with all modules loaded, plus 2K for CCP.
- Smart**—You can use it like SUBMIT, or program it to create your own menus or other dialogs.
- Simple**—If you use CP/M, you can learn OKARA in an hour or less.
- Slick**—Provides some enhancements that CP/M has always needed.
- Friendly**—In so many ways. One example, OKARA can page console output from any program or command. No more racing to type a control-S.
- Universal**—Nearly all present and future CP/M applications will run under OKARA without modification.
- Price**—\$150, single copy. \$130, disk only. \$20, manual only. OEM discounts available.
- Formats**—8" single density, 5" Osborne, Apple, Northstar.
- System**—8080, Z80, or 8085 cpu, CP/M 2.2 Operating System. Text editor to create scripts.

KIAI
systems

P.O. Box 11461
Oakland, CA 94611
(415) 654-8671

*OKARA is a trademark of KIAI Systems. SUPERVYZ is a trademark of EPIC Computer Corporation. STOK PILOT is a trademark of STOK Computer Interface. CP/M is a trademark of Digital Research.

Interested in the IBM Personal Computer?

If you're interested in the IBM Personal Computer then you need PC magazine.

PC magazine is the Independent Guide to IBM Personal Computers. Each issue is packed with information for everyone interested in IBM Personal Computers.

PC magazine tells you how to put together the best IBM "PC" system and then how to get the most out of it. Each issue brings you hundreds of colorful pages of evaluations, insights, and straight talk from respected experts—professionals in computer science as well as writers, businessmen, lawyers, educators, and many others.

PC covers software, hardware, applications and most every topic of importance to the thousands of IBM Personal Computer users who read it. To ensure that we give you the information you need, PC includes a special "User-to-User" section, as well as a "PC Wish List", and news about IBM Personal



now. If not fully satisfied when you receive your first copy of PC, simply return your mailing label within 15 days for a full refund.

This is the magazine that tells you all about it.

Computer clubs, events and publications.

For a limited time, you can subscribe to PC at NO RISK and still receive a 25% discount off the newsstand price. Enter your subscription

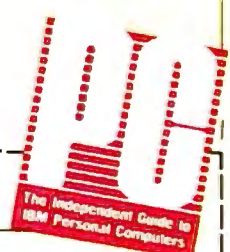

Byte 8

Name _____

Address _____

City _____ State _____ Zip _____

6 issues/\$14.50
 12 issues/\$27.00
 24 issues/\$46.00

Check enclosed
 VISA
 MasterCard
 Bill me

Card # expires _____

I already own an IBM "PC"
 I am thinking about buying one

Send to: Dept. B, PC Magazine
 1528 Irving St., S.F., CA 94122

Listing 3: Logo variables are nontyped. The variable NUMBERS contains whatever the user enters. First, it is examined as a list of words and tested to see if it contains the value DONE; next, it is used as a list of numbers and added.

```
TO ADDLOOP
PRINT [TYPE TWO NUMBERS TO ADD.]
MAKE "NUMBERS READLIST
IF FIRST :NUMBERS = "DONE [STOP]
PRINT SENTENCE [THE SUM IS] (FIRST :NUMBERS) + (LAST :NUMBERS)
ADDLOOP
END
```

jecting typing, the designers of Logo did not mean to encourage the haphazard use of variables for different purposes; rather, they built a procedural language in which variables are attached to a particular procedure, rather than being available to the entire program. This encourages the same discipline in a different way.

As an example in which typed variables are awkward to use, listing 3 illustrates the common problem of writing a program that reads some numbers entered by the user, performs some calculation with them,

and repeats the process until the user signals that there are no more problems to do.

This program has been written so that the user can enter the word DONE when no more numbers are left to add. In a typed language, the numbers would have to be read into a numeric-type variable, not a string-type variable. Entering a nonnumeric word would be an error. FORTRAN programs used to be full of instructions to the user like "type 9999 to indicate that you're done." Pascal programs face the same difficulty.

Logo is extensible. Every computer language has certain built-in, or primitive, operations. Most languages, for example, include arithmetic operations on numbers, and some way to print the results. Procedural languages allow the programmer to create new operations, extending the capability of the language. In that sense, most languages are extensible. But "extensible" is used by language designers in a special sense.

An *extensible* language is one in which user-defined procedures "look like" primitive procedures. This is partly a matter of notation and partly a matter of real power. In most languages, the primitive arithmetic operations can be applied to several different types of variables (integer and real, for example) with appropriate results for each type. In most languages, however, user-defined procedures must specify in their definition one particular type of variable to which they apply. This restriction violates the principle of extensibility.

Extensible languages are particularly valuable for teaching because a teacher can provide language extensions and teach them as if they were primitives. LISP, Logo, APL, and FORTH are extensible, with some minor restrictions in some cases. Logo violates pure extensibility, for example, in that some of the primitive arithmetic operations are represented in infix form (with the operation symbol between the two operands, as in $3 + 2$), while user-defined procedures can be represented only in prefix form (with the operation symbol before the operands, as in $SUM\ 3\ 2$). Almost all Logo primitives are used in prefix form.

As an example of the use of extensibility in Logo, most versions do not have primitive procedures for iterative looping, like the FOR, DO, or WHILE constructs in other languages. But it is very easy to define these procedures, if you want them, so that they look syntactically similar to the IF command that is a Logo primitive.

Logo as a Learning Language

Among respectable languages, you may have noticed two groupings.

WICAT

has the 68000

While others are promising, WICAT Systems for nearly two years has been quietly delivering their complete 68000 computers.

The System 150 is a popular desktop computer with large memory and hard disk, unmatched in price/performance. The System 100 is its expandable software compatible high performance companion.

Concurrent's integral™ database and menuesystem greatly accelerate the development of applications. Full UNIX™ System 3 with no compromises is ready.

Concurrent can discuss your needs and help you select the proper configuration. Please write or call (513) 281-1270.



Motorola 68000, 256K memory, 10MB Winchester disk, 760KB floppy, terminal, system software, choice of Pascal, FORTRAN, C, Assembler, BASIC, COBOL

Single user 150-1 \$ 9,450
 Three users 150-3 \$10,850
 Six users 150-6(512K) . \$12,850

MULTIBUS is a trademark of INTEL Corporation
 UNIX is a trademark of Bell Laboratories
 OPTIONS: graphics, printers, IEEE 488 instrumentations interface, videodisk controllers, A/D boards



Concurrent Corporation
 1870 Madison Road Cincinnati, Ohio 45206

you have one apple... now get a whole bushel

of apple add-ons

from **Vista** COMPUTER
COMPANY,
INC.

Available through your
local computer dealer.

MODEL GB75© Typewriter Interface

Apple to IBM Electronic 50, 60, 75 Typewriters Interface ■ Reads IBM keyboard in parallel with Apple keyboard ■ Supports the IBM code functions using an escape sequence ■ Types at about 13 characters per second ■ Prints from Integer or Applesoft programs ■ Supports the "Control I Number N" parallel line length mode sequence ■ Has switch selectable upper/lower case I/O 60, 66, 78 continuous from feed page lengths, 40+video, 80, 95, 132 character line lengths

Suggested price \$225.00

TIMECARD III©

Multi-function time utility for the APPLE III computer system. Contains the year of the century, the month, the date, the day of week, the hour, the minute, the second. ■ A countdown timer with a range of one millisecond to 999 hours, 59 minutes, 59 seconds, 999 milliseconds ■ Selectable 12 or 24 hour time formats ■ Diagnostic error reporting ■ Fully compatible with the APPLE SOS operating system

Suggested price \$195.00

Circle 418 for Dealers only Circle 419 for OEM's only Circle 420 for all other inquiries

MODEL 150 TYPE AHEAD BUFFER

■ Up to 40 character type ahead capability ■ Enter commands or data while your Apple is processing previous instructions ■ Compatible with all Apple computers, keyboards and software ■ No cuts — no jumpers — no software patches required ■ Includes complete instructions for quick and easy installation

Suggested price \$49.95

A800© FLOPPY DISK CONTROLLER

■ High speed DMA transfer of data (1 micro-second/byte) ■ Documentation provided — includes theory of operation, schematics and diskettes ■ Uses all standard Apple DOS commands (OPEN, CATALOG, LOCK, DELETE, LOAD, etc.) except for INIT which has been improved and enhanced in a Vista format routine ■ Compatible with Apple DOS 3.3, Pascal 1.1 and CP/M 2.2 (with the Z80 soft card by Microsoft) ■ 2K x 8 PROM contains Autoboot functions and all eight-inch

floppy driver code allowing complete compatibility with Apple DOS 3.3

Suggested price \$545.00

PROM DEVELOPMENT SYSTEM©

■ Menu driven program development monitor ■ Programs 2708, 2716, 2532, 2732 and 48016 EPROMS ■ Simulates PROM from RAM 4K ■ Data and address interface for operator location and control ■ Complete user documentation

Suggested price \$495.00

VISION 80

■ Full upper and lower case character with 3 dot descenders ■ 9x10 dot matrix per line U.S. (9x11 Europe) ■ 128 ASCII character set ■ BASIC, FORTRAN and Pascal languages supported ■ Z80™ and CP/M™ compatible ■ Compatible with all standard Apple™ peripherals

Vista COMPUTER
COMPANY,
INC.

■ Shift and lock for upper and lower case ■ Source switches between 40x24 and 80x24 software and hardware ■ Rated #1 video card by Softalk and Call Apple

Suggested price \$325.00

VISION 40

Softscreen programmable character/generator card for the Apple II computer ■ Allows use of DOS tool kit upper/lower case character sets in Apple 40 column mode ■ Permits creation of new alpha/numeric and graphic characters under Am-inatrix ■ Ideal for non-English language applications ■ Compatible with most popular word processing software packages

Suggested price \$195.00

VISION 20

■ Cost effective ■ Compatible with the latest Apple II ■ Complete easy to follow installation guide ■ 120 day warranty ■ Immediate delivery

Suggested price \$29.95

1317 E. Edinger
Santa Ana, CA 92705
(714) 953-0523

©Digital Research, Inc.
©Designed by Burtronix

©Copyright 1981 Vista Computer Company, Inc.
™Apple Computer Company, Inc.

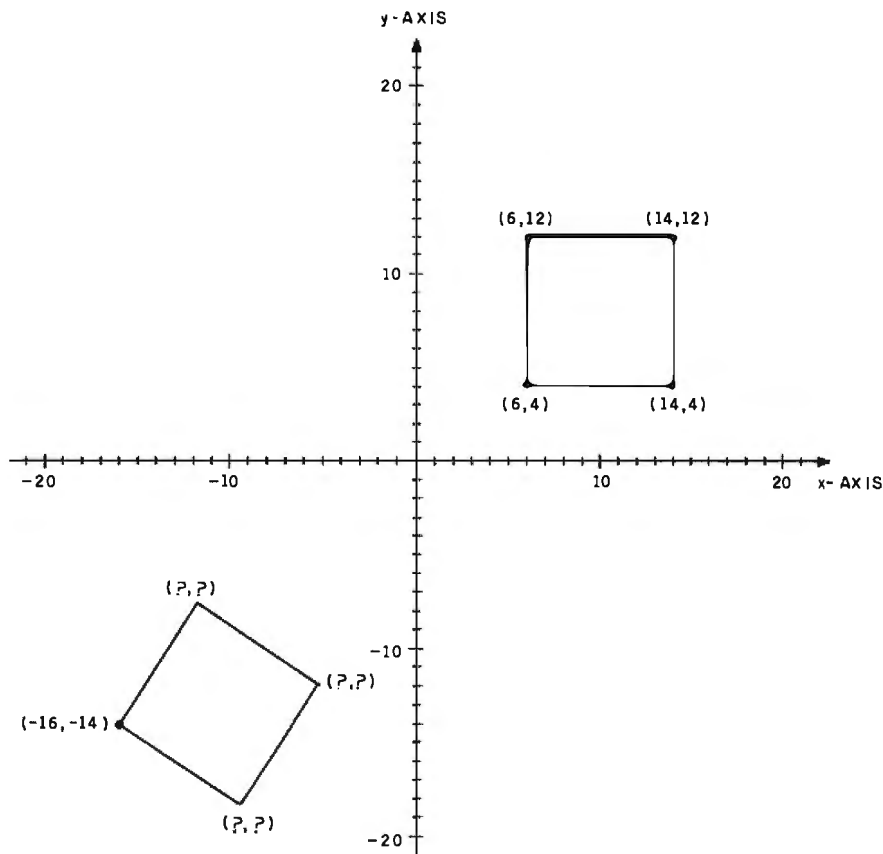

Figure 3: *The difficulties involved in graphics using Cartesian coordinates. A square is simple to draw when its sides are parallel to the axes, but trigonometry is necessary when other orientations are used.*

Logo, LISP, and APL are interpreted, list-oriented, and untyped. Pascal and C are compiled, array-oriented, and typed. (All respectable languages are procedural, by definition.) These groupings reflect historical accidents, implementation convenience, and language-design philosophy. For example, C and Pascal are very similar because they are both derived from an earlier language, ALGOL, that established a style followed by many newer languages.

Compilers have a much easier time with typed languages, while interpreters are just as happy with untyped ones. The list-oriented languages were all invented by people who are primarily mathematicians, rather than computer programmers.

Within each group, though, the differences tend to reflect the particular use each designer had in mind. For example, C is different from Pascal largely because C was designed as a language for systems programming.

In the list-oriented group, LISP was developed for use in artificial-intelligence research, and APL was developed to teach algebra and the mathematical topics, like calculus, that depend on algebra. Logo, though, was developed as a learning language, not for a specific branch of mathematics, but for problem-solving behavior. Logo is meant to appeal particularly to younger students than APL does, although Logo has also been used successfully with college physics students at MIT.

From the point of view of the "pure" computer scientist, Logo is LISP. The developers of Logo, in fact, have been artificial-intelligence researchers for whom LISP is second nature. The differences between the two languages are all based on the specific intent to make Logo particularly useful as a learning language. Logo's special properties from this point of view will be described next.

Logo is "tuned" for interesting applications. Probably the most famous aspect of Logo is the idea of *turtle geometry*. This approach to computer graphics has been added to other languages, such as Pascal and PILOT, but it originated with Logo.

Most approaches to computer graphics are based on Cartesian coordinates (the "x,y" system you learned for graphing equations in high school—see figure 3). In this approach, each line you want to draw is specified in terms of the specific positions of the endpoints, relative to a fixed-coordinate system. Using Cartesian coordinates, it's not too hard to draw an upright square in a known position, but if the square is tilted, its coordinates must be calculated using trigonometry. The power of turtle geometry is that lines are described not in terms of absolute position in a coordinate system, but relative to the position and direction of the turtle, a conceptual animal that moves around the TV screen. In this system, you don't say where the turtle starts or ends, just how far it moves and in what direction:

```
TO SQUARE :LENGTH
REPEAT 4 [FORWARD :LENGTH
          RIGHT 90]
END
```

Other articles in this issue of BYTE explain more about how turtle geometry works (see "A Beginner's Guide to Logo" by Harold Abelson on page 88 and "Introducing Logo to Children" by Cynthia Solomon on page 196). For our purposes, what's important is that the use of this powerful approach makes graphics programming possible for beginners the first time they use the computer.

In the past, computer programming has appealed to only a small number of people because there has been a real lack of problems that are both interesting and easy enough for beginners. Traditional programming courses have been heavy in algebraic problems ("Write a program to solve quadratic equations."). Therefore, they have not attracted people who

BEAUTIFUL PROGRAMMING



WITH THE BRIDGE 3C™ COMPUTER. Develop two programs for the time of one.

Sounds too good to be true? With the new BRIDGE 3C Compiler System you can easily do it! This new fully integrated BRIDGE system is designed for the professional who needs a powerful computer for software development. Our 3C System includes Pascal, C, and . . . a *completely structured* FORTRAN compiler package. What's more, you utilize the full 256 K of memory with MEMDISK™ and overlay linker.

Check the capabilities it offers, and plan to make your work more pleasant and productive with the BRIDGE 3C.

UNIQUE SOFTWARE

- CPM2.2 enhanced by Cache BIOS™ performing disk buffering, and MEMDISK™ virtual disk, speeding operations 4 to 10 times.
- Operating utilities and diagnostics (all source code included).
- Interrupt driven console with type-ahead buffering.
- BMATE™ screen oriented text editor/word processor.
- R80™ RATFOR preprocessor, FORTRAN compiler, true overlay linker and symbolic debugger for fast structured application programming.
- Enhanced FORTRAN library, including. . .
STRLIB™ string manipulations subroutines, system function calls, EASYPACK™ math library including vector and matrix operations, and an extensive scientific library.
- Pascal-Z™ generating efficient ROM-able and reentrant Z-code. Pascal package includes SWAT™ symbolic debugger and overlay linker.
- C compiler generating assembly language source code.

INTEGRATED HARDWARE

InterSystems mainframe including . . .

- Powerful 1 Mbyte memory management system.
- 256 K of memory including parity check (expandable to 1 Mbyte).
- Two serial ports plus four parallel.
- Dual 8" double sided, double density floppy disc drives with DMA disk controller for fast data transfer.
- S-100 Bus follows IEEE 696 standards.
- Complete prioritized interrupt system.
- Choice of Zenith or Televideo terminal.

EXTENSIONS - OPTIONS

- FPP – System calendar, 3 interval timers, one additional serial port, and a 9511 Floating point processor with complete software interface.
- ROM – EPROM development package including programmer and dual port memory for emulating 2716's.
- GRX – High resolution graphics package.
- AD – Hardware and software drivers for 16 channels A-D converters (30kHz throughput) and 4 channels D-A converters.
- MEM – Additional 256 K memory.
- HD – Hard disk drive (30 Mbyte) with interface and all necessary software updates.

And what about support? BRIDGE offers monthly seminars (BRIDGE User Group) plus 90 day hardware warranty and software support, with optional 2-year extension.

If you need a truly professional computer, start thinking about the BRIDGE 3C Compiler System. For complete information and prices, call us at (617) 244-3203 or write today.

3C, MEMDISK, BMATE, R80, STRLIB and EASYPACK are trademarks of BRIDGE Computer Company, Division of Sea Data Corporation
Cache BIOS, SWAT and Pascal-Z are trademarks of Ithaca InterSystems, Inc.

Circle 60 on inquiry card.

 **BRIDGE™**
Computer Company
DIVISION OF SEA DATA CORPORATION
ONE BRIDGE STREET NEWTON, MASS. 02158 U.S.A.

Listing 4: Pig Latin translation via Logo.

```

TO PIGLATIN :SENT
IF EMPTY? :SENT [OUTPUT []]
OUTPUT SENTENCE (PLWORD FIRST :SENT) (PIGLATIN BUTFIRST :SENT)
END

TO PLWORD :WORD
IF VOWEL? FIRST :WORD [OUTPUT WORD :WORD "AY]
OUTPUT PLWORD WORD BUTFIRST :WORD FIRST :WORD
END

TO VOWEL? :LETTER
OUTPUT MEMBERP :LETTER [A E I O U Y]
END
    
```

don't like the traditional mathematics curriculum.

Turtle geometry is not the only special application built into Logo. Another one is language processing. Letters, words, and sentences are a natural hierarchy of Logo objects. (In most programming languages, by contrast, a sentence is not a list of words, but a string of characters. If you want to deal with the words in the sentence, you have to write a complicated program just to look for

spaces in the string to divide the words.) As a simple example, listing 4 is a Logo program to translate a sentence into pig Latin. PLWORD is used as a subprocedure to translate a single word based on this rule: if the word starts with a vowel, add AY at the end. If not, move the first letter to the end and try again.

In the program, WORD and SENTENCE are procedures for joining two objects into a larger object; FIRST and BUTFIRST separate an object into

its component parts. The primitive procedure FIRST, when applied to a sentence, produces the first word of the sentence. When applied to a word, it produces the first letter. No other programming language deals so neatly with this hierarchy of objects in human language.

Logo is user-friendly. A language for learners has to be designed to deal with problems that are less important in a language meant for experienced programmers. For example, when you make a mistake, you should get a detailed, helpful error message. Languages that say things like SYNTAX ERROR or ERROR NUMBER 259 are not encouraging to a beginner. Logo has messages like:

+ DOESN'T LIKE HELLO AS INPUT

This means that you tried to add a nonnumber, the word HELLO, to something. When you see the message

I DON'T KNOW HOW TO FRIST

you have used a procedure, FRIST, that you haven't defined. The message

NOT ENOUGH INPUTS TO MAKE

means that the procedure MAKE needs two inputs, and you gave only one. If the error happens during the execution of a procedure, Logo also prints the name of the procedure and the line containing the error.

Since the beginning of time (in 1954), programming students have been getting confused about common programming statements such as $X=X+1$, a frequently used assignment construct that seems to go against one's algebraic intuition. Pascal's use of $:=$ instead of the unadorned equal sign is somewhat of an improvement, and APL's \leftarrow is even better. Even so, the notation doesn't make it obvious that $X-3$ has an effect very different from $X+3$ or $X-3$, which look very similar. In Logo, the assignment is done this way: MAKE "X :X+1. Although less terse than a single-character symbol for assignment, the word MAKE con-

I-Queue™

... the intelligent buffer that frees your IBM Personal Computer from the time-consuming printing function.

I-Queue accepts data at processor speed (over 4000 characters per second) and sends it to the printer* at whatever speed the printer can accept.

I-Queue can store 16K of RAM, which is approximately 7 pages of average printout (optionally expandable to 65K for storage of 28 average pages). Standard features include complete pagination and formatting capabilities, a reprint buffer, a clock/calendar and many other design enhancements usually found only in sophisticated word processors.

Available direct or from participating PC dealers. Distributor and dealer inquiries invited. For new brochure, write, or call our 800 number.

*Fully compatible with IBM printer and all Centronics interface printers.
IBM Personal Computer is a trademark of IBM.



AVAILABLE FROM STOCK -
WITH CLOCK/CALENDAR &
COMPLETE DEMO PROGRAMS: \$495
65K MEMORY EXPANSION OPTION: \$175

PERIPHEREX inc.
149 Palmer Road
Southbury, CT 06488
800-221-0732 In NY: (212) 961-2103

Welcome to the third dimension

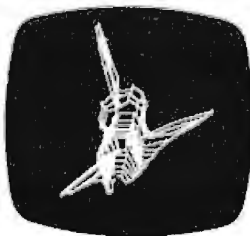
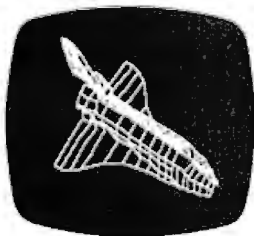

	Apple II*	IBM Personal Computer**
3 Axis Space Tablet (software included)	\$475.00	-
4 Axis Space Tablet (software included)	\$595.00	\$595.00
VISA, MasterCard and C.O.D.'s accepted. CT residents add 7.5% Sales Tax.		
*Minimal Configuration: 48K, Applesoft, DOS 3.3		
**Minimal Configuration: 64K, Game paddle adapter, color/graphics adapter		

Apple and Apple II are Trademarks of Apple Computer, Inc

in computer-aided graphic design.

Introducing The Space Tablet™ from Micro Control Systems. The first three-dimensional spatial digitizer compatible with Apple II™ and IBM Personal Computers.

The Space Tablet lets you interactively record x, y and z coordinates of any object—even one that doesn't really exist—then allows you to manipulate any or all of those coordinates with the push of a button. A fast, practical way to play "what if?" in any design situation.

What's more, specially written software allows you to rotate and rescale drawings instantly—or even compose one drawing from several components. All at a fraction of the price you'd expect to pay.

Applications for The Space Tablet are truly unlimited. Design. Engineering. Architecture. Science. CAD/CAM. Graph reading. And so much more. It can even be used as a two-dimensional digitizer.

Let us help you enter the third dimension in graphic design. Call or write and we'll tell you how The Space Tablet can work for you.

Micro Control Systems, Inc.
230 Hartford Turnpike, Vernon, CT 06066. Phone (203) 643-4897.

MCS

!!!!FANTASTIC PRICES!!!! FROM DIGITAL DIMENSIONS

OKIDATA

ML-80.....	\$359.95
ML-82A.....	\$469.95
*ML-83A.....	\$719.95
*ML-84(parallel).....	\$1,034.95
*ML-84(serial).....	\$1,149.95
OKIGRAF ROMS for 82A or 83A.....	\$69.95
OKIGRAF DISK,(Apple only).....	\$59.95

Interface boards and cables avail.

*Includes Tractor Feed

EPSON

MX-80.....	\$449.95
MX-80 w/graftrax.....	\$472.95
MX-80FT.....	\$559.95
MX-80FT w/grofftrax.....	\$609.95
MX-100.....	\$699.95
GRAFTRAX only.....	\$79.95

Interface boards and cables avail.

SCM-TP 1.....	\$649.95
120 word/min Daisy Wheel, 10 or 12 pitch, serial or parallel interface	

DAISYWRITER 2000.....	\$1,015
Bidirectional 16.5cps, 38k buffer, Centronics, 488, RS232, & C. Loop	

DAISYWRITER 1500.....	\$945
Bidirectional 16.5cps, 4k buffer, (Specify one interface only)	

BEACON II-M 64K S100 System.....	\$2,995
1.2 meg in two 8" disks, includes CPM 2, 2, MBASIC, 4mhz Z80, 2 serial ports & 10 Diskettes - Completely integrated - just add a terminal	

North Star Horizon II 64k.....	\$2,995
quad disks with CPM 2.2 & MBASIC	

TERMINALS

TELEVIDIO 950.....	\$995
TELEVIDIO 925-C.....	\$825

TCS ACCOUNTING SOFTWARE

Payroll, A/R, A/P, G/L each.....	\$65/25
(compiled each).....	\$65/25
Inventory.....	\$100/25
TOTAL Payroll,A/R,A/P,G/L ea....	\$300/25
TOTAL demo's ea.....	\$100
'SIMPLE' Filing system.....	\$150/25
TRSDOS ACCOUNTING each.....	\$175/25
Payroll, A/P, A/R, G/L	

NASHUA DISKETTES

8 inch soft sectored	
SS/SD.....	10/\$25
SS/DD.....	10/\$30
DS/DD.....	10/\$34
8 inch hard sectored (32)	
SS/SD.....	10/\$25
5 1/4 inch	
SS/SD.....	10/\$22
SS/DD.....	10/\$29
DS/DD.....	10/\$31

DIGITAL DIMENSIONS
190 Chapel Road
Manchester, CT 06040
1-800-243-5222
CT Residents Call
203-649-3611

MC/VISA welcome, Allow 2-3 weeks for checks, COD ok w/10% deposit. All prices include UPS ground freight in U.S. All orders shipped w/in 24 hrs. CT residents add 7 1/2% sales tax, CPM is T.M. of Digital Research, Prices subject to chg. w/out notice.

tures up much more vividly the notion that something is being changed, not just used in a calculation.

There are many more ways in which Logo makes explicit things that many languages leave hidden. For example, Logo uses the colon (which Logoites call "dots") to mean "I want the value of this variable"; the same word without the dots names a procedure. In LISP, the notorious parentheses make it possible to distinguish procedure calls from variable references without the dots notation; most other procedural languages simply prohibit using the same word for both purposes. (That solution would be awkward in Logo because some words like WORD are not only popular variable names, but also names of primitive procedures.)

In any case, according to the design philosophy of Logo, the dots notation is a good thing, apart from its technical necessity, because it calls attention to the fact that a variable's value is different from its name; it also points out that a variable is different from a procedure. For example, in the $X=X+1$ situation, the two identical-looking appearances of X have different meanings. The second represents the old *value* of X, whereas the first merely *names* the variable being given a new value. In the Logo version, these two meanings are distinguished by the notation. The first is called "X; the second is called :X.

Another example of a distinction that is explicit in Logo and not in some other languages is the division of procedures into commands and operations. An operation is a procedure that computes some value that becomes the output of the procedure. For example, the arithmetic operations are in this category. A command does not have an output, but instead has an effect: it prints something, moves the turtle, or changes the value of a variable.

The same distinction is made in Pascal, in which operations are called functions and commands are called procedures. FORTRAN calls them functions and subroutines. LISP, APL, and C, however, are less fussy.

C treats all procedures as operations, but allows an operation to be used as if it were a command; the result of the operation is ignored in that case. In LISP and APL, the result of such a "top-level" operation is printed. (In LISP, every procedure has an output and every top-level command prints something. In APL, some procedures don't have output and, therefore, don't print anything.) In Logo, using an operation without a command is considered an error; if you want something printed, you must use the PRINT command.

The use of infix arithmetic in Logo is a concession to the habits of the users. All other Logo procedures are used in prefix form, with the procedure name before the inputs. Arithmetic can also be expressed in prefix form. The two Logo expressions $3 + 2$ and SUM 3 2 are equivalent.

The infix form seems more natural to people accustomed to doing arithmetic outside of the Logo environment. The prefix form, however, is better in some ways. For example, it eliminates the need for precedence of operations (i.e., where division is always done before addition, etc.). Also, it eliminates the need for parentheses to indicate grouping. In LISP, only the prefix forms are used.

Another user-friendly aspect of Logo is its facility for interactive definition of procedures. Early versions of Logo used a line-numbering technique: within each procedure, lines were numbered and could be replaced much as the lines of a BASIC program can be replaced. Current implementations of Logo use a display editor in which special control characters are used to move the cursor around the display screen to change individual characters anywhere in a procedure definition.

Logo has no threshold and no ceiling. This means that Logo is easy enough for anyone to use, but it is powerful enough for any project; it's not a "toy" language. Logo is best known as a language for elementary school children, but it's designed for learners of any age and any level of sophistication.

How young can a Logo learner be?

FDC-I SBC-I SYSTEMASTER®

SYSTEMASTER®

The Next Logical Step

Teletek FDC-I, The First Step

A CPU, floppy disc controller and I/O all on one board. Until SYSTEMASTER® the most powerful IEEE-S-100 board on the market.

Teletek SBC-I, The Second Step

A board designed for use in high performance, multiprocessing systems. SBC-I combines its own CPU, serial and parallel ports, 128K of segmented memory and FIFO.

SYSTEMASTER®, The Next Logical Step

Teletek's newest product — a breakthrough in S-100 board design. SYSTEMASTER® is a complete system. No other boards are required. It doesn't even require a bus!

But, when used with an S-100 bus, SYSTEMASTER® has even more capabilities. You can readily expand to multi-user or multi-processor systems using SYSTEMASTER® as the master board.

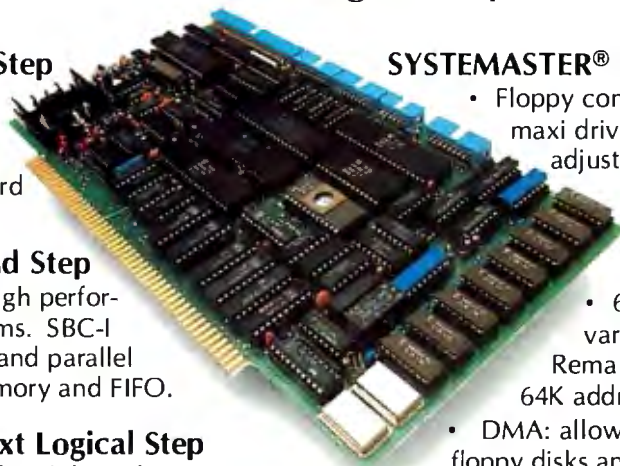

SYSTEMASTER® Features:

- Floppy controller: controls mini and/or maxi drives; variable independently-adjustable pre-write compensation.
- CPU: 4MHz Z80A
- Two RS-232C ports.
- Two full parallel ports.
- 64K bank-selectable memory variable from 32K to 60K. Remaining memory is fixed at top of 64K address space.
- DMA: allows transparent data transfer to floppy disks and other devices without CPU wait states.
- Relocatable EPROM/ROM/PROM: 2K, 4K or 8K with deselect capability.
- Real-time clock.
- Operating systems available: Digital Research or Turbodos.
- Parallel ports may be connected to Teletek's PSC board for RS-422 capability.

TELETEK

9767F Business Park Drive Sacramento, CA 95827 (916) 361-1777

Circle 400 on Inquiry card.



Peachtree



∞ Peach Payroll system

User's Manual



∞ sales invoicing

User's Manual



∞ inventory

User's Manual



∞ accounts receivable

User's Manual



∞ accounts payable

User's Manual



∞ general ledger

User's Manual



Pick a Pak of Peachware™

Peachtree Software™ has long been a leader in the microcomputer software field. Its quality and reliability have made it the standard in business software, and its documentation and ease of operation have made it the choice of users everywhere.

Now there's a new look to Peachtree Software. The look is Peachware™, and it's destined to change the way you think about software.

The Peachware concept is simple: give the user a complete solution to his business software needs. How? The Peachpak™.

In our Peachpaks, we've put together integrated systems of related packages—in accounting or word processing, for example—to give the user the most benefit from his micro in his business functions.

The Peachpak 8 Accounting Series—which includes General Ledger, Accounts Payable, Accounts Receivable, Sales Invoicing, Inventory Control and PeachPay™ payroll—gives you the quick response, accurate results and timely reports you need to maintain complete control of your finances, the lifeblood of your business.

The Peachpak 9 Office Productivity Series is centered on the PeachText™ word processor (formerly Magic Wand®; we've improved it and like the results so much we decided to put our name on it) and includes the PeachCalc™ Electronic Spreadsheet, Spelling Proofreader, Mailing List Manager and Telecommunications. Peachpak 9 extends the Peachware solution to all areas of the electronic office.

That's not all. We've got Peachpaks for different levels of accounting

needs, for vertical applications, even one designed specifically for the Apple II™ computer.

And we have Peachcare™, our own approach to the critical problem of after-sale support and service. It runs the gamut from PeachTax™, a subscription service to keep your PeachPay package updated on changes in tax requirements, to the Peachtree Software Product Center, which offers direct sales and software support to the user.

We're bringing these services to more people every day, both in the United States and abroad, through our network of almost 1,000 dealers and Peachtree Software International, headquartered just outside London. We have more than 40,000 packages installed worldwide, and the number is growing rapidly.

Peachtree Software is picking up its pace to meet the burgeoning needs of micro users. It's part of our effort to make sure that, when it comes time for you to pick your software, you pick the leader. Pick a peach.

Peachpak™ 4 Accounting Series

General Ledger Inventory
Accounts Payable Payroll
Accounts Receivable

Peachpak™ 40 Accounting Series, Apple II Edition

General Ledger Inventory
Accounts Payable Payroll
Accounts Receivable

Peachpak™ 6 Client Accounting Series

Client Posting and Accounting System
Passive Payroll



Peachpak™ 61 Property Management Series
Property Management System
General Ledger

Peachpak™ 71 Sales Tracker (COBOL)

Accounts Receivable and Sales Analysis
Inventory
Order Entry

Peachpak™ 8 Accounting Series

General Ledger
Accounts Payable
Accounts Receivable
Sales Invoicing
Inventory Control
PeachPay™ Payroll System

Peachpak™ 9 Office Productivity Series

PeachText™ Word Processor
Spelling Proofreader
PeachCalc™ Electronic Spreadsheet
Mailing List Manager
Telecommunications

Circle 321 on inquiry card.

Apple II is a trademark of Apple Computer Inc. Peachtree Software, Peachware, Peachpak, PeachPay, PeachText, Magic Wand, PeachCalc, Peachcare and PeachTax are trademarks of Peachtree Software Incorporated, an MSA Company.

Copyright © 1982 Peachtree Software Incorporated, an MSA Company.

Please send me information on Peachware™ by Peachtree Software.

Name: _____

Company: _____

Address: _____

City: _____ State: _____ Zip: _____

I am a: prospective dealer user of software

BY 882

Peachtree Software Incorporated an MSA company
3445 Peachtree Road, N.E. / 8th Floor / Atlanta, Georgia 30326 / (404) 266-0673



Well, very young children might have trouble with typewriter keys and with the spelling of procedure names. Several years ago, however, Radia Perlman at MIT built a series of special keyboards with large buttons labeled with pictures instead of words. With this special hardware, she taught the ideas of turtle geometry to 4-year-olds. This project even included the idea of procedures, with buttons called "start remembering" and "stop remembering" to delimit a procedure definition, and one called "do it" to execute the procedure. Multiple procedures could be

named by using buttons in different colors.

How old can a Logo learner be? Professors Harold Abelson and Andrea diSessa have been using Logo to teach physics to MIT undergraduates. They use Logo simulation programs to demonstrate not only simple Newtonian mechanics but even the general theory of relativity. Their book, *Turtle Geometry: The Computer as a Medium for Exploring Mathematics* (Cambridge, MA: MIT Press, 1981), demonstrates their approach, which has also been used successfully with high school students.

Logo has also been used for a special group of learners, those with severe handicaps. In the past, many children of normal or superior intelligence, but with impaired ability to communicate, have been diagnosed as retarded. Computers can be used with such children both as a communication prosthesis and as a field of interest in which the handicapped learner can exhibit autonomy in pursuing goals. The use of Logo in education for the handicapped is explored in Dr. E. Paul Goldenberg's book *Special Technology for Special Children* (Baltimore: University Park Press, 1979).

Other languages designed with students in mind are BASIC, Pascal, and APL. (I omit PILOT, which was designed not so much for students as for teachers; in its original design, students were supposed to use computer-aided-instruction programs written in PILOT, rather than PILOT itself.) How do these languages compare with Logo in their applicability to education?

BASIC was designed as a modification of FORTRAN for beginners. By far the most important advance in BASIC was its interactive approach. This was much more of a pioneering step than it now seems because people are now accustomed to inexpensive personal computers with this feature. In the early days of BASIC, the only computers were huge, expensive ones. Although timesharing, which allowed several people to use the big computer at once, had recently been invented, many people objected to it because it used the precious time of the huge computers inefficiently. (The response of timesharing advocates was that it was more efficient in the use of human time.) An interactive language was even more time-consuming than timeshared use of the old, compiled languages. For John Kemeny and his colleagues at Dartmouth to move against the general worship of efficiency was very brave.

Besides adding interaction, BASIC removed some of the most difficult parts of FORTRAN. For example, the INPUT and PRINT statements in BASIC don't require a detailed specification of the format in which infor-

LOGICSIM PROFESSIONAL LOGIC SIMULATOR™
E/Z ASSOCIATES, 5589 STARCREST DR., SAN JOSE CA 95123

DISCOVER THE DIFFERENCE

Available now is **LOGICSIM**. The first low-cost CP/M based logic simulator. With capabilities comparable to industry standard simulators; those costing up to \$50,000.

LOGICSIM makes complicated design, test and verification easy. Replaces messy breadboards; fruitless hours on the bench. Lets you focus on your design; not hardware problems.

Nine logic states, ability to simulate TTL/NMOS/CMOS/PMOS logic, three-state, wired-or and transfer gates with propagation delays allows you to verify design, perform spike and race analysis. Macro circuit capability and expandable macro network library plus numerous other features make it a powerful and usable design tool.

Try it now. Send us a check for \$30 and we will mail you a demo copy* of **LOGICSIM** and a User's Manual.

*Please specify 8" IBM 3740/5" APPLE CP/M (13/16 SECTOR)
Introductory price \$276. CP/M based 56k to 64k systems (APPLE's with CP/M card).

For more information, call (408) 578-8096. Or write:
E/Z ASSOCIATES, 5589 Starcrest Dr., San Jose, CA 95123

CP/M, APPLE and LOGICSIM are trademarks of Digital Research Inc
Apple Computer Inc. and E/Z ASSOCIATES, respectively

YOUR

NEC

PC-8001A CPU/32K ... \$725

Authorized Dealer



For NEC products circle Reader Service #47

VIC-20

Commodore\$239

BROTHER DAISYWHEEL

- 16 cps
- Selectric ink cartridge

HR-1P Parallel\$855

HR-1S Serial\$895

TeleVideo

TS-802 Computer Special \$2665

- 950 Terminal Features ● 64K Z 80A 4MHZ, CP/M ®
- Dual floppies, 720K total ● Network expansion

TS-802H\$4990

TVI-910\$575

TVI-925\$725

TVI-950\$915

VIDEO MONITORS



- 12" green monitor, P-31
- 15MHZ
- 80 x 24 character display



BM-12A\$88

- 13" color, composite
- audio/video



- 270 line resolution

BM-1400CL\$249

AMDEK

- 12" green monitor
- Anti-glare filter

AM300G\$137

- 13" RGB

- IBM/Apple/NEC

Color II\$635

JB-1201 NEC 12" green\$159

JC-1201 NEC 13" color, std.\$325

JC-1202 NEC 13" RGB\$755

Z-12G 12" green, Zenith\$115

PRODUCTS FOR APPLE ®

- Add-on Drive for Apple II ® ● 35 Track ● It works
- Identical performance to DiskII ®
 - Burned-in, tested, and re-tested

AP-B2 Was ...\$349 SPECIAL\$315

AP-B1 Drive with DOS, controller, manual

SPECIAL\$425

AP-16 16K Ram Card\$68

V-80 Videx Videoterm w/ Softswitch ...\$258

MS-Z Microsoft Z-80 Softcard\$253

MS-PS Microsoft Premium System\$529

AP-PAR Parallel Printer Card/Cable\$72

DC-2 Hayes Micromodem II\$271

NAT Novation Apple CAT\$325

AP-GR Grappler (specify printer)\$135

AP-M2 Microbuffer II, 16K\$195

For Apple Products circle reader service #49

PRODUCTS FOR IBM

A.S.T. Research Combo Card

- 64K, expandable to 256K
- Includes parallel and serial interfaces
- Suggested list—\$555

MC-064SPSPECIAL\$335

RAM-9 9pcs., 64K RAMs\$95

IB-T1 Tandon drive-1 side\$219

IB-T2 Tandon drive-2 side\$485

IB-T3 Tandon drive-80 track,

2 side, w/ DOS Patch\$595

For IBM products circle reader service #50



BISON PRODUCTS, inc.

MAIL ORDERS:

P.O. Box 9078-184
Van Nuys, CA 91409

WILL CALLS:

16709 Roscoe Boulevard
Sepulveda, CA 91343
(213) 891-5702

Please confirm price and availability
by phone prior to ordering.

We accept VISA and Mastercard.



Shipping additional-\$3 minimum.

Calif. residents add 6% sales tax.

Overseas orders and dealer inquiries accepted.

All merchandise is new and
comes with factory guarantee.

For additional product information, circle reader
service #51

PRINTERS

Epson Prices include Graphtrax Plus

MX-80 III Epson 80 cps\$425

MX-80 F/T III Friction, Tractor, Graphics ...\$535

MX-100 III 80 cps, wide\$692

PC-8023 NEC, 120 cps\$485

OK-82A Oki, U82A, w/ tractor\$460

OK-83A Oki, U83A, w/ tractor\$685

OK-84PS U84, 200 cps, par/serial\$1125

PRO-A Prowriter, parallel\$485

PRO-B Prowriter, parallel/serial\$610

F-10A 40 cps Daisy, parallel\$1395

F-10B 40 cps, serial\$1395

EP-8K SER Microbuffer 8K serial\$115

EP-16K PAR Microbuffer 16K parallel\$125



104/1 5 1/4" soft\$35

104/1D 5 1/4" soft, double density\$42

3480/1 8" soft\$45

3480/2D 8" soft, dsdd\$63

SOFTWARE

MikroPro SOFTWARE

MP-WS8 Word Star, 8"\$250

MP-WSA Word Star, Apple\$192

MP-MM8 Mail Merge, 8"\$ 77

MP-MMA Mail Merge, Apple\$ 63

MP-SS8 Spell Star, 8"\$127

MP-SSA Spell Star, Apple\$105

MP-DS8 Data Star, 8"\$175

MP-SR8 Super Sort, 8"\$127

MP-SRA Super Sort, Apple\$100

MP-SII8 Super Sort II, 8"\$105

MP-CS8 Calc Star, 8"\$149

MICROSOFT

APPLE

Fortran\$165

Basic Compiler*\$315

Cobol*\$595

Z-80 Softcard\$253

Typing Tutor\$17.95

Olympic Decathlon\$24.95

Tasc Applesoft Compiler\$159

*Requires Z-80 Softcard

CP/M®

Basic 80\$299

Basic Compiler\$319

Fortran 80\$369

Cobol 80\$595

Macro 80\$189

mu MATH/mu SIMP\$219

mu LISP/mu STAR\$175

Many additional software packages are available at similar discounts.

SIERRA DATA SCIENCES

S-100 Master/Slave Single Board Computers

Master 4MHZ Z80A\$690

Slave 4MHZ Z80A\$625

CP/M®\$160

BIOS\$100

Manual\$25

Winchester Adaptor\$145

Turbo DOS\$750

For product information on Sierra Data Products circle reader service #48

DISK DRIVES

Q-842 Qume #842 (replaces DT-8)\$480

MI-2D Mitsubishi 8" dsdd\$435

TN-1 Tandon Thin 8" ssdd\$365

TN-2 Tandon Thin 8" dsdd\$445

AB DIGITAL DESIGN LABS

256K BYTE - 128K

WORD DYNAMIC MEMORY

- 4MHZ with Extended DMA

- IEEE696, Multi-Layer

- 1 Year Warranty

S-B810A List\$1245 BISON\$825

B810A-86 For 8086 Systems\$875

STATIC MEMORY SYSTEMS 64K

- 24 Line Addressing
- 200NS, Lower Power CMOS
- Intermix RAM and EPROM
- New Super Low Price

S-ST64 List\$594 BISON\$440

8086 SUPER MICRO SEATTLE MICRO COMPUTER

- 8 MHZ 8086 S-100 SET

- 128K 70NS Static RAM

- DD Disk Controller

- 22 Slot Mainframe

- Cable for 2 8" Drives

- MS-DOS (86-DOS)

- Add Drives and Terminal!

SC-SYS2 System 2 List...\$4185 BISON...\$3450

SC-2/3 8086 2 BRD Set w/DOS

List\$795 BISON\$595

SIGNALMAN MKI 300 BPS MODEM

BISON\$89



- Vertical mount
- Power supply, fan
- Signal extender cable
- Write protect switches on front
- Highest quality construction

BISON\$325

INTELLIGENT PRINTER INTERFACE

Free Your Computer from the
Mundane Task of Printing



Imagine being able to use your computer seconds after beginning an extensive printout.

Visualize your printout with page breaks, page numbering and titles, margins of your choice, indented carryover lines, on any size paper!

Appreciate the time and money you will save by not waiting for your printer.

SooperSpooler, a buffered printer interface, maintains control over your printer while you go on using your computer for more productive activities. Eliminate waiting while your printer pecks through a long document. SooperSpooler accepts information from your computer at up to 3000 characters per second and feeds it to your printer as fast as it can handle it—without using any of your computer's memory or time!

SooperSpooler features include:

- 16K Memory (62K optional)
- Buffer Status Readout
- Space Compression
- Pagination
- Single Sheets
- Headers and Page Numbering
- Indentation on Carryover Lines
- Self Test Routine
- Features also Software Controllable
- Plugs into Most Computer Systems
- ★ 16K Parallel I/O Unit—\$349.00!
- ★ Serial I/O Option—\$95.00
- ★ 46K Memory Option—\$159.00

SooperSpooler™ by Compulink—
The missing link that gives your
microcomputer mainframe printing.

COMPULINK CORPORATION

1840 Industrial Circle
Longmont, CO 80501 (303) 651-2014

Send for brochure
Dealer inquiries welcome
Call for information: 800-525-6705

mation is presented, as FORTRAN does with its FORMAT statement. (As an example, FORTRAN requires the user to specify the number of digits before and after the decimal point in the printed form of a number.) Of the modern languages, only C uses primarily format-directed input and output. Unfortunately, the important ideas of procedures and local variables were also left out of BASIC.

This means that easy problems are very easy to solve in BASIC, but hard problems are close to impossible. Any large BASIC program is bound to be an unreadable maze of GOTOs. The designers of BASIC, after all, intended it as a language for beginners (i.e., Beginner's All-purpose Symbolic Instruction Code). FORTRAN was supposed to be used for more difficult programs.

The advent of personal computers has pushed BASIC into a more extended role, not because it's easy for the programmer, but because it's easy for the computer! The Logo interpreter, like the Pascal compiler, barely fits in an Apple II computer with 64K bytes of memory. BASIC interpreters are used with 8K-byte machines at a much lower cost. The result is that computer magazines are filled with long, complicated BASIC programs that are far from basic in their readability.

Pascal, on the other hand, was designed to include the most advanced ideas of computer science in recent years. Although intended as a first language, it was meant primarily for college students, particularly those interested in computer science as a career. That helps to explain why it is compiled and typed, two strong barriers to the unsophisticated student. Even the simplest Pascal program is rather complicated to write, enter into the computer, and run. That's why, in practice, Pascal is often taught to students who have already used BASIC and FORTRAN.

BASIC and Pascal were both designed to teach computer programming per se. APL was designed to teach mathematics, especially at the high school level. Its inventor, Kenneth Iverson, used it for several years

as a blackboard language without any intention of actually implementing it on a computer. That helps explain his willingness to use special symbols not then found on any actual computer printer. Anything can be drawn on the blackboard!

In its intended use, APL is very powerful. Many computations that require iterative loops and auxiliary variables in other languages can be done in one step in APL. Most people see this power mainly as a matter of terseness; APL is famous (or notorious) for its one-line programs. The real virtue of APL's approach is that it allows the student's attention to be focused on the mathematics of a problem, rather than on the needs of the computer. APL was designed to be used not in a special programming course or a special unit stuck into another math course, but casually throughout an algebra course, just as you'd use a calculator.

Logo's goal is different from all these. It isn't supposed to be an easy introduction to something else, it's not specifically for computer-science majors, and it isn't a tool for teaching the same math curriculum people are already teaching. Instead, it's a door into the territory of the computer as an object for intellectual exploration. To return to the theme stated at the beginning of this article, Logo is for learning learning.

Why Logo?

In his book *Mindstorms: Children, Computers, & Powerful Ideas* (New York: Basic Books, 1980), Seymour Papert says, "It is not true to say that the image of a child's relationship with a computer I shall develop here goes far beyond what is common in today's schools. My image does not go beyond: It goes in the opposite direction." Logo isn't just a programming language; it's also a philosophy of education. Papert's book is the best explanation of that philosophy, but what follows is a briefer summary.

A child learns partly by picking up specific facts and skills. Much of existing formal education is about facts and skills: reading, spelling, and the multiplication table. But a more profound kind of learning is the skill

Peripherals Unlimited...

FANTASTIC PRICES!

OUR FAST SERVICE, PRODUCT SELECTION AND OUR CUSTOMERS' SATISFACTION MAKE US #1.

ZENITH

Z-89-48K	\$2299
Z-90-64K DO	\$2588
Z-19 Terminal	\$777
Z-121 Monitor 12"	\$149

EPSON PRINTERS

MX-70	CALL
MX-80 w/Graphics	CALL
MX-80 FT (Friction + Tractor)	CALL
MX-100 (15" Carriage)	CALL

Call for prices on
Ribbons, Cables and Interfaces

ATARI COMPUTERS

Atari 800 16K	\$669
Atari 400	\$318
Atari Interface Module	\$174
Atari 810 Single Disk	\$444
Atari 815 Dual Disk	TBA
Atari 830 Modem	\$166
Programmer	\$59
Entertainer	\$84
Star Raiders	\$34
16K Mem. Exp. for Atari	\$74
32K Mem. Exp. for Atari	\$114

NEC-PC 8000

Series Microcomputer

PC-8001A Computer w/32K	\$888
PC-8012A w/32K + Exp. Slots	\$588
PC-8031A Dual Mini Disk	\$888
PC-8032A Add-on Mini Disk	\$777

Call for Software Prices

NEC PRINTERS

7710/30 Spinwriter R/O	\$2279
7720 Spinwriter KSR	\$2649
3510/30 Spinwriter R/O	\$1699
3500 Serial Spinwriter	\$1599

NEC DOT MATRIX

PC-8023	\$474
---------	-------

Call for prices on ribbons, etc.

MORE PRINTERS

Anadex 9500/9501	\$1295
Anadex DP-9000	\$1049
Okidata Microline 80A	CALL
Okidata Microline 82A	CALL
Okidata Microline 83A	CALL
Tractor (OKI 80 + 82 only)	\$60
Diablo 630	\$2044

MONITORS

Sanyo 12" GRN Phosphor	\$266
Sanyo 12" Black + White	\$239
Amdek 12" 300 GRN Phosphor	\$149
Amdek 12" Color	\$319
NEC 12" GRN Phosphor	\$164
NEC 12" Color	\$344

**FOR THE LOWEST
PRICE CALL
TOLL FREE
1-800-343-4114**

ORDERING INFORMATION

Our order lines are open 9AM to 6PM EST Monday thru Friday. Phone orders are welcome; same day shipment on orders placed before 10AM. Free use of Mastercard and VISA. Personal checks require 2 weeks clearance. Manufacturer's warranty included on all equipment. Prices subject to revision. C.O.D.'s accepted.

For service, quality and delivery call:

**PERIPHERALS UNLIMITED
(617) 655-7400**

62 N. Main St. • Natick, MA 01760

Solve the Energy Crisis with your own hands

Saving energy and money is as easy as switching light bulbs. This free slide rule calculator from Westinghouse shows you where to begin.

Saving energy is everyone's job. You can make it easier, however, if you take a close look at the lamps you're using now.

With the Westinghouse Energy-Saving Calculator, you can instantly analyze each lamp type's efficiency, and decide exactly which kind of bulb is more efficient in offices, plants, showrooms and display areas. You'll also learn how many watts you save and the annual energy cost savings per lamp.

As an example, if you have fluorescents, substituting our Econ-o-Watt® lamps for standard lamps will have an immediate effect—up to 6 watts per socket, with no appreciable change in light level.

For incandescents, the most efficient way to save, besides direct substitution, is by replacing your system with high pressure sodium lamps. These lamps can save up to 80% of the energy



expended by incandescents, while producing an equivalent light level.

Call toll free 800-631-1259 to get your calculator.

Westinghouse lamp products and programs offer many other savings opportunities that can make the difference in your operating expenses. Call today and learn why the simplest, most straightforward solution to saving energy is taking matters into your own hands.



Westinghouse

Lamp Divisions
Bloomfield, New Jersey 07003

A-9703

of learning itself, which involves the building of mental models of the world, of oneself, and of the learning process. These models are developed through intellectual exploration. That exploration may begin in a weak, haphazard way, but a good learner develops strategies for purposeful exploration. The more one learns, the better the model of learning, and the more able one becomes as a learner.

In this process of growth, it doesn't really matter what particular aspect of the world you explore. In the introduction to *Mindstorms*, Papert mentions that at age 2 he fell in love with automobile gearboxes. When I

was in junior high school, I fell in love with hypnotism. The point about using computers in education is not that everyone must know something about computers, but simply that for many people, computer programming can be the arena for this general process of learning to learn. Because the computer is such a general-purpose machine, it can appeal to many different interests. It can draw pictures, make music, write stories, or move robots.

"I want a job as a computer programmer. Why should I learn Logo, and not something useful like COBOL?" This is a common ques-

tion. There are two possible answers to it. The first is that Logo, as explained earlier, is designed to make explicit many of the fundamental ideas of computer programming. Someone who learns Logo is likely to have a very clear idea of the nature of variables, procedures, and most other programming constructs. So Logo may be a better basis even for learning COBOL than simply starting with COBOL itself. But the second answer is that Logo's purpose isn't to train computer programmers. Logo isn't meant to replace all other programming languages.

Logo is generally associated with

**This person
used to develop
applications for
the Z-80 market
with the best
of them.**



SOFTech
MICROSYSTEMS



Turn your Apple into the world's most versatile personal computer.

The SoftCard™ Solution. SoftCard turns your Apple into two computers. A Z-80 and a 6502. By adding a Z-80 microprocessor and CP/M to your Apple, SoftCard turns your Apple into a CP/M based machine. That means you can access the single largest body of microcomputer software in existence. Two computers in one. And, the advantages of both.

Plug and go. The SoftCard system starts with a Z-80 based circuit card. Just plug it into any slot (except 0) of your Apple. No modifications required. SoftCard supports most of your Apple peripherals, and, in 6502-mode, your Apple is still your Apple.

CP/M for your Apple. You get CP/M on disk with the SoftCard package. It's a powerful and simple-to-use operating system. It supports more software than any other microcomputer operating system. And that's the key to the versatility of the SoftCard/Apple.

BASIC included. A powerful tool, BASIC-80 is included in the SoftCard package. Running under CP/M, ANSI Standard BASIC-80 is the most powerful microcomputer BASIC available. It includes extensive disk I/O statements, error trapping, integer variables, 16-digit precision, extensive EDIT commands and string functions, high and low-res Apple graphics, PRINT USING, CHAIN and COMMON, plus many additional commands. And, it's a BASIC you can compile with Microsoft's BASIC Compiler.

More languages. With SoftCard and CP/M, you can add Microsoft's ANSI Standard COBOL, and FORTRAN, or

Basic Compiler and Assembly Language Development System. All, more powerful tools for your Apple.

Seeing is believing. See the SoftCard in operation at your Microsoft or Apple dealer. We think you'll agree that the SoftCard turns your Apple into the world's most versatile personal computer.

Complete information? It's at your dealer's now. Or, we'll send it to you and include a dealer list. Write us. Call us. Or, circle the reader service card number below.

SoftCard is a trademark of Microsoft. Apple II and Apple II Plus are registered trademarks of Apple Computer. Z-80 is a registered trademark of Zilog, Inc. CP/M is a registered trademark of Digital Research, Inc.

MICROSOFT

CONSUMER PRODUCTS

Microsoft Consumer Products, 10700 Northup Way,
Bellevue, WA 98004 • (206) 828-8080

Circle 277 on inquiry card.

children because most people have a model of the learning process in which children learn and adults don't. This model is unfortunate. Logo can be useful to people of any age, but it will be most useful to you if you approach it in a playful, exploratory way.

It's important to distinguish between the Logo language and any particular implementation of Logo. Some things can't be done in the Apple and Texas Instruments versions of Logo simply because the machines aren't big or fast enough or because the implementation doesn't include some capabilities. For exam-

ple, no microcomputer version of Logo has a good way of storing data on disk, although all versions can store procedures on disk.

The Logo interpreter barely fits in a 64K-byte Apple II, and the implementation favors the features needed for education, not those needed for practical data processing. But in principle, Logo is a good language in which to develop any application because of its interactive debugging and its procedural style.

Do you want to write a video-game program? It'll probably run too slowly in Apple Logo, unless it's a simple one. But it might be worthwhile to

develop it in Logo, playing around with different ideas for your game in an environment that permits quick, easy modification of your program, and then rewrite it later in some other language. The advantage of Logo can be described partly in purely technical terms like "interactive." Another way of looking at it, however, is that Logo encourages the playfulness you need to design the best possible game. If all you want to do is make an exact copy of Asteroids, the benefits of Logo are less important.

In summary: Logo is a LISP-like language, and a laboratory for loose, lifelong learning about learning. ■

**This person used to
develop applications
for the 8086/8088
market with the
best of them.**



SOFTech
MICROSYSTEMS

This person develops applications for the entire market, including the Z-80, 8080, 8086/8088, 6502, LSI-11/PDP-11, 9900, and the M68000 with the best there is.



The UniversalTM Operating System.

Why does this application developer look so happy, you may ask?

Because, unlike others in his field, he's one of the smart ones. He uses the UCSD p-SystemTM from SofTech Microsystems. It's the first truly universal operating system ever developed. It lets him develop an awesome array of high-quality applications. And it's equally at home with an IBM PC, TRS-80TM Model II, Apple II[®], Osborne 1[™], TI Business System 200[™], Zenith Z-89[™], Hewlett-Packard HP-87[™], Philips P-2000[™], the new DEC Professionals[™], or any other micro in the market.

That makes our developer one of the elite. Because he'll never have to worry about locking himself into an operating system that will eventually lock him out of the market.

A Universal Operating System. At last.

Whether it's a Z-80, 8086/8088, M68000, 6502, or you name it, the p-System is portable across any popular microprocessor made anywhere today.

And we don't mean just at the source code level, either. We mean you can develop your program, on any machine, then compile to object code (p-code), and it's totally transportable.

You get it done right the first time. Every time. For any machine.

Now you can design for the whole market.

Once and for all.

The p-System actually enables you to broaden your customer base without significant reinvestment in programming, time and time again. Simply because it's the only OS that runs the same object code programs on all popular 8- and 16-bit microprocessors. No matter who makes them. No matter who uses them.

And that's only the beginning. There's more to the p-System philosophy. Much more.

Take programmer productivity, for example. We know how much work you put into programming, so we understand the importance of streamlining that process. So we saw to it that the p-System allows you to reuse program components, time and time again.

It's been our experience that as much as 50% of the code developed for one application can be reused on others. And you can also create your own library of utilities suited to solving your own unique problems.

Try finding that on some other operating system.

All the tools you need for the job. Any job.

When you write your programs with the p-System, you can use any combination of UCSD Pascal,[™] FORTRAN-77 and BASIC. Each language operating effectively with the others. So you can finally take advantage of the best features of each language—in a single program. And you also get a complete, fully integrated set of software development tools to make your job even simpler. Naturally. Including a screen editor, macro assemblers, and a debugger, as well as add-ons such as TURTLEGRAPHICS, Native Code Generators, and even Print Spoolers.

Our admirers have impeccable credentials.

In case you wondered who else believes in our Universal Operating System, there's the fact that the p-System is licensed by most of the major hardware manufacturers around. Manufacturers like IBM, DEC, TI, HP, Commodore, Osborne, Philips, and Zenith. You know, all those "little guys."

And the p-System's reliability is well-documented. Has been since 1977. And this, coupled with the upward compatibility of source code programs, has given the p-System five years of proven, documented field testing. By the toughest critics in the business.

Given all this, it's easy to see how your productivity can be enhanced.

Now you can develop higher quality applications faster, less expensively, and more dependably than ever before. For a much larger market.

All at the same time.

All on one machine.

All without worrying about some hardware enhancement limiting your business opportunities and leaving you with no other choice than peddling popcorn or ice cream on some lonely street corner.

If you don't believe it just take a look at our Applications Catalog to prove it.

At last, using the p-System, you can design programs once. Once and for all.

SOFTech

MICROSYSTEMS

I hear you, SofTech Microsystems. Please send me a brochure on the p-System, the world's only Universal Operating System. And keep me off the streets.

Please send coupon to:
SofTech Microsystems, 9494 Black Mountain Rd.
San Diego, CA 92126, or call (714) 578-6105

NAME _____ TITLE _____
COMPANY _____
ADDRESS _____
CITY _____ STATE _____ ZIP _____
TELEPHONE _____ EXT. _____

UCSD p-System and UCSD Pascal are trademarks of the Regents of the University of California; Universal Operating System is a trademark of SofTech Microsystems; TRS-80 is a trademark of Tandy Corp.; Apple II is a registered trademark of Apple Computer Inc.; Osborne I is a trademark of Osborne Computer Corp.; Business System 200 is a trademark of Texas Instruments; Z-80 is a trademark of Zenith Corp.; HP-87 is a trademark of Hewlett Packard Inc.; P-2000 is a trademark of Philips Electronics; and Professional is a trademark of Digital Equipment Corp.

Introducing Logo to Children

Teaching Logo requires an awareness of different learning styles.

Cynthia Solomon
80 Ellery St.
Cambridge, MA 02138

As computers continue to enter schools and homes, parents, teachers, and children face the problem of integrating the machines into their lives. For many, computers serve as powerful instruments for personal use and intellectual development. Many Logo researchers see the potential of computers to serve as personal instruments for everyone and have been working toward that goal. In the process, they have focused on developing not only the Logo language, but things to do with the language and ways of thinking and talking about these activities. How people talk about what they are doing, the way they interact with one another, and the way they interact with the computer give rise to a new kind of culture, a computer culture.

Seymour Papert has been the guiding influence in the development of this kind of computer culture. (See *Mindstorms: Children, Computers, & Powerful Ideas* [New York: Basic Books, 1980] for a fuller discussion of

Logo and computer cultures.) Papert created the Logo language for children. Although it had to be simple to learn, it needed a rich and easily expandable vocabulary. It had to reflect some of the important ideas in computer science, such as procedurization, local and global variables, naming, self-referential pro-

For many, computers serve as powerful instruments for personal use and intellectual development.

gramming, etc. These are attributes that a language such as BASIC does not possess. BASIC has a reputation for being easy to learn; it has a small vocabulary of key words. But this initial set of key words is not easily expandable; the programmer cannot create new key words. This sets BASIC apart and makes it *easy to learn but hard to use*. The programmer cannot build procedures, name them, and then use them to build other procedures. The powerful problem-solving strategy of breaking problems into smaller and smaller

parts can only be a paper-and-pencil strategy in a BASIC programming environment. The structure of BASIC does not support this important problem-solving strategy.

Once Logo was developed for children, Papert and his collaborators looked to the computer to provide an environment in which a person could learn by doing and thinking about what they did. A person would actively explore the capabilities of both Logo and the computer by constructing objects and debugging them. The computer would serve as a source or tool for creating interesting mathematical objects that would draw upon a person's intuitive knowledge and that could be used in constructing other objects. One of these objects is the computer-controllable geometric entity, now widely known as a turtle. Exploring the turtle's behavior leads people to draw upon their intuitive geometric knowledge. This knowledge does have a formal aspect as expressed in the area of mathematics known as computational geometry. (See *Turtle Geometry: The Computer as a Medium for Exploring Mathematics* by Harold Abelson and Andrea diSessa [Cambridge, MA: MIT Press, 1981] for an excellent presentation of

About the Author

Cynthia Solomon, formerly vice-president of Logo Computer Systems Inc., participated in the development of Apple Logo. She is currently finishing work toward her doctorate in education from Harvard University.

COMPUTERS

NEC



The low priced system that's big on features. 4 Mhz Z-80A, real time clock, color output, CP/M® compatible, 5 function keys and more.

- PC8001A Computer \$725
- PC8031A Dual Drives \$725
- PC8012A I/O w/32K \$474



TELEVIDEO

Now backed locally by T.A.W. Built-in CRT, detachable keyboard, dual floppys w/750K formatted capacity, 64K, CP/M and more. Special: Telesolutions - Wordstar™ and CalcStar™ w/system \$279.

- 802 \$2696
- 802H \$5049
- 806 (6-user) 10mg. \$5295

NORTHSTAR



New low price on the incredible Advantage™. Your choice GDO5 and BASIC, or GCP/M \$120. Let us burn and test your Advantage™ or Horizon and we'll back it with our own four warranty service.

- Advantage \$2695
- Horizon II 64K Quad \$2595
- Advantage w/5 mg. \$3695



DIGITAL

Turn your VT100 into a CP/M-based personal computer. Your VT100 will retain all of its features including 132 column display, split screen viewing, and smooth scrolling.

- DEC PC Option \$2495
- Rainbow 100 Call
- Professional 300 Call

ZENITH



The all-in-one that's backed by your local Zenith-Heath Service center. Green Screen, CP/M®, Supercalc, and Basic Incl.

- Z-89 w/48K \$2149
- Z-90-82 w/64K \$2395

ALTOS



Our tech's favorite systems - 8" floppys, hard disks, and multi-user under MP/M or Oosls. Call for prices on Altos' new 16-bit systems and 3/4" floppy systems.

- Series 5-15D \$2295
- 8000-10 w/MP/M \$6175
- 8600-20 \$8395

VIEWPOINT



Viewpoint 3A Plus: New Viewpoint emulates Lear Siegler, TeleVideo, or Sorac. We're selling them at a lower price than others charge for older models.

- \$489

TELEVIDEO



- 910 Plus \$579
- 925* \$735
- 950* \$927

*Xtra pg. memory \$30-installed

TERMINALS



- Falco TS-1 (VT52) \$1069
- Falco (VT-100) \$1199
- Zenith Z-19 (VT52) \$689
- Dialogue 80 Amber \$895
- Walker Craig 404 \$599

SOFTWARE

Micropro 6-pack: Wordstar, Mailmerge, CalcStar, Spellstar, DataStar, SuperSon, Retail \$1790 - our price \$889. (Software not warranted for suitability, software sold only with systems.)

SANYO PLUS



Sanyo Plus NEW

From Sanyo, a name recognized for quality and reliability, comes the MDC-1000. We've added a second drive and 3 software packages and are offering the entire integrated system at a price that may even shock the people at Osborne.

An all-in-one Z80A (4MHZ) computer with dual 5 1/4" drives with a total storage capacity of 624K formatted. A 12" green phosphor 24x80 display, and a detached keyboard with 4 special function keys and a 10-key cluster. 1 serial port, 1 parallel port, plus three expansion slots. Free software includes: CP/M 2.2, Sanyo BASIC (a superset of Microsoft Basic), Diagnostics, Utilities, Wordstar, Plannercalc, and a games disk. Integrated, tested and warranted for 100 days (1 year RAM warranty).

No dealers, please.

All for just **\$2295.**

ON SALE



- NEC8023A \$474
- Okidata 82A \$419
- Okidata 83A \$669
- Okidata 84 \$1059
- Epson MX-80* \$444
- Epson MX-100* \$719

HIGH SPEED



- Prism 80 \$779
- Prism 80 "loaded" \$1395
- Prism 132 "loaded" \$1549
- Zenith Z-25 \$1225
- Anadex 9501A \$1369
- MT 1805 \$1645

LETTER QUALITY



- SCM TP-1 \$675
- Daisywriter 1000 \$1111
- NEC 3510 w/trac. \$1975
- NEC 7710 w/trac. \$2499
- EC 7720 \$2695

I/O DEVICES

- Houston Instrument:
 - Hi-Pier DMP-2 \$849
 - Hi-Pier DMP-7/8 \$2057
 - Hi Pod DT-11 \$669
- Hayes Smartmodem \$219
- NEC 12" G Monitor \$169

Scottsdale Systems Ltd.
 6730 E. McDowell Road, Suite 110, Scottsdale, Arizona 85257
(602) 941-5856
 Call 8-5 Mon-Fri.
 (We Export) TWX 910-950-0082 (IMEC SCOT)

SERVICE/ORDERING

INTEGRATION: Prices listed are for new equipment in factory sealed boxes with manufacturer's warranty. We will pretest your equipment, integrate your system, configure your software, provide special cables, etc., for an additional charge. Call for prices.

ORDERING: MAIL ORDER ONLY. Prices listed are for cash. No C.O.D.'s. We sell on a net 20 basis to Fortune 500 companies and Universities (or cash prices). Charge cards add 2%. Prices subject to change, product subject to availability. AZ. residents add 5%. Personal checks take 3 weeks to clear. 0-20% restocking fee for returned merchandise. Shipping extra - products are F.O.B. point of shipment. CP/M and MP/M are registered trademarks of Digital Research.

NSS Offers An Incredible Advantage.



NSS software, written specifically for Northstar's ADVANTAGE™, outperforms any software available for Northstar computer systems. Our fully integrated accounting package includes general ledger, accounts receivable, accounts payable, inventory control and payroll—

the first Northstar payroll package.

Why NSS software? If you're a Northstar dealer, it means greater ease in closing sales of Northstar's computer systems within vertical markets. Or, if you own a Northstar computer, it means greater flexibility and expanded capability for your Northstar as a business tool.

Our vertical market applications, such as those we have developed for tire dealers, are the best on the market. Let the ADVANTAGE™ talk to you with NSS' unique cassette training tapes, demonstration disks and sales kits. NSS also provides dealer seminars and a toll free support hotline.

That's The Incredible Advantage!

Order your Introductory
Dealer Kit NOW
or
CALL TOLL FREE FOR
MORE DETAILS

1-800-722-3446



NATIONAL SOFTWARE
SYSTEMS
P.O. Box 510911
Salt Lake City, Utah 84151

the formal aspects of turtle geometry.) In this kind of a computer culture, people draw upon knowledge acquired in other activities; and they apply what they learn in the Logo culture to many different areas.

My personal contributions toward this goal focus on what is required to encourage the development of computer cultures in the Logo spirit. One of the questions I have considered is: What does a teacher of Logo have to know? There is no one answer to this question. I have seen children teach other children about Logo. Although their knowledge is quite different from the adults who taught them, the children were very successful at sharing with each other a way of thinking and talking about computers. Perhaps I should pose a different question and ask: What are some of the things I think about as I teach people to program?

I see much of my own development as a teacher as acquiring (1) a collection of programming projects that make the power of programming techniques and concepts apparent to beginners; (2) a vocabulary for talking about programming; (3) an awareness of different learning styles and strategies for building on them; and (4) a sensitivity to the kinds of resistances that keep many adults and children from experimenting with mathematical ideas.

A Model for Introducing People to Computers

When I enter a new teaching situation, I have in mind several models of how to introduce people to Logo. I also maintain a willingness to switch from one model to another or even diverge from all of them. My primary goal is for people to do something they could not have done without a computer, but something that is familiar to them (e.g., draw a square or print their name all over the screen). I also want to think toward a next step and how the beginning programmer can build on what happened in the first session in the following one. Flexibility is one of the most powerful ideas in this culture, but to be flexible implies having a model to

THE STRANGE CASE OF THE DISAPPEARING DATA

"Mr. Holmes, Dr. Watson, I'm really glad you made it," said the office manager who had enlisted the services of my friend. "Last night, a big chunk of data disappeared from our computer system. My boss wants to know who was responsible...and fast!"

Holmes began to investigate.

"You would be wise to exonerate all of those in your employ," he concluded just moments later. "No one here is a fiendish database killer. Last night's lightning storm was the villain. It caused a momentary loss of power that destroyed immense portions of your database."

"How can we prevent this in the future?" asked the company president.

"By investing in a Zeus2™ multi-processor system from OSM," said Holmes. "Zeus2 has an integral power supply that will protect your data from momentary power glitches."

"Will it also protect our data from total power failures?" asked the office manager.

"Quite so," answered Holmes. "The uninterruptible power supply allows you to continue operating for up to twenty minutes when power dies, so your workers have ample time to save their critical documents."

"But how do we know Zeus2 will meet our special needs now and in the future?" asked the president.

"Zeus2 is well suited to virtually all multi-user, multi-processing applications," declared Holmes. "It easily accommodates 32 users*--locally or remotely. In addition, its proprietary CP/M™ compatible MUSE™ operating system simplifies programming and allows you to utilize thousands of existing programs."

"With all those features, Zeus2 probably costs too much," snapped the vice president of finance.

"Quite untrue," replied Holmes. "In fact, Zeus2 offers the best price-performance ratios in the industry—with a price-tag so low some deem it criminal."

"But how, dear man," I interjected, "did you deduce that a power glitch was to blame for last night's loss of data?"

"Elementary, my dear Watson," he said, puffing contentedly on his pipe. "Elementary."



For more information on the Zeus2 solution, call or write us today.

OSM

OSM COMPUTER CORPORATION
2364 Walsh Ave., Santa Clara, CA 95051
(408)496-6910 (800)538-5120 TWX: 910-338-2099

© OSM 1982. Zeus2 and MUSE are trademarks of OSM Corp.
CP/M is a trademark of Digital Research Inc.
*16 users standard; 32 users on special order.

Circle 313 on Inquiry card.

The solution: The Zeus2 multi-processor system.

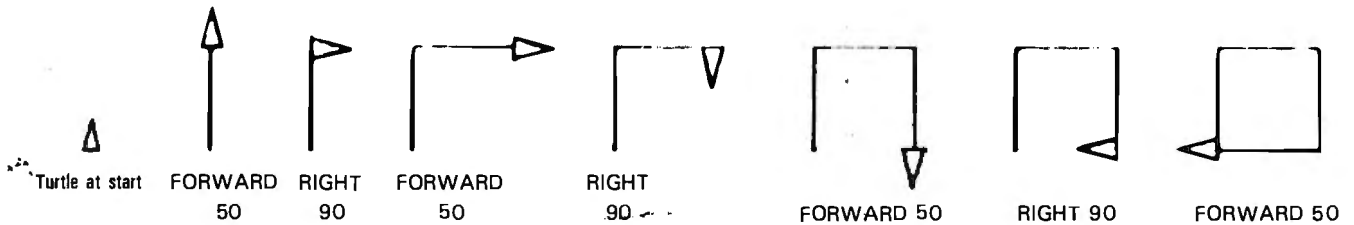

Figure 1: Building a square. With the turtle at the starting point, this sequence of commands will produce a square. These commands can also be turned into a Logo procedure.

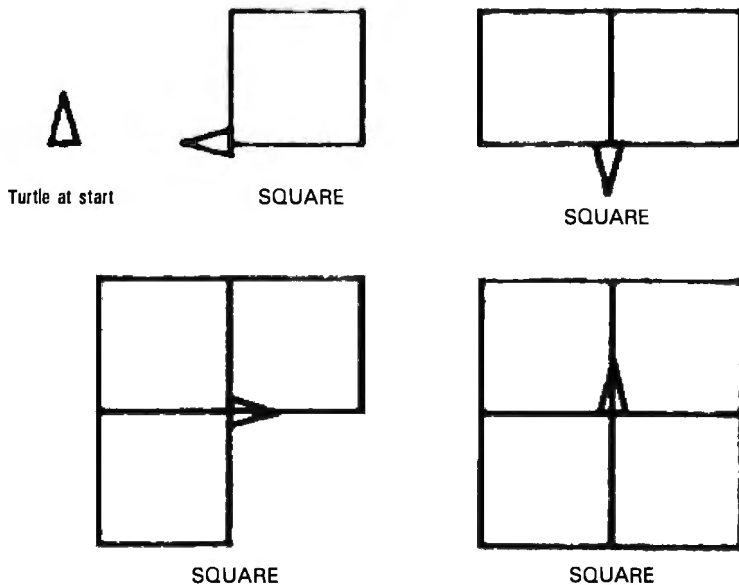

Figure 2: PANES as evolved from SQUARE. The figure is made by repeating the SQUARE procedure four times.

depart from. Thus, I have a model in mind of paths a beginner might take in a first session.

In a first session, I try to convey the following ideas: (1) programming is a process of engaging the computer in conversation using the vocabulary the computer understands; (2) the computer's understanding can be easily expanded; (3) giving meanings to words involves describing a procedure to the computer and giving the procedure a unique name; (4) since procedures created by the programmer can be used like any of Logo's words, they can be incorporated into other procedures; (5) making procedures entails a process of debugging; and (6) pretending to be the computer or the turtle helps in designing and debugging programs.

Thus, in a first session, a person might try out turtle commands like

FORWARD and RIGHT. The student would then make a design (create a procedure), give it a name, enter that name into Logo's active vocabulary, and use that new procedure in the construction of others. The teacher, at the same time, is also learning from this experience by thinking about the effect of different actions on the turtle and, with concrete examples and advice, helping the new Logo programmer arrive at a greater understanding of Logo. The teacher also has a chance to rethink the examples presented to the student and develop new approaches and a deeper understanding of the learning process. (See *Apple Logo: Introduction to Programming through Turtle Graphics* by Cynthia Solomon [Pointe-Claire, Quebec: Logo Computer Systems Inc., 1982], which is included in the Apple Logo package.)

Example of a First Session

Usually, a beginner starts by communicating with a turtle. The student specifies an algorithm in Logo that causes the turtle to draw a geometric design (e.g., a square). This is done relying on intuitive mathematics instead of formula-driven mathematics. That is, the description to the computer is based on how the student would trace out the path of a square if the student had the same limited understanding as the turtle does (e.g., knowing how to move FORWARD or BACK, and turn LEFT or RIGHT). The sequence in figure 1 illustrates the effect of such commands on the turtle. These commands can be named and turned into a procedure that then becomes a part of Logo's working vocabulary:

```
TO SQUARE
FORWARD 50
RIGHT 90
FORWARD 50
RIGHT 90
FORWARD 50
RIGHT 90
FORWARD 50
END
```

The TO informs Logo that a procedure is being created. SQUARE is the name of the procedure. END marks the end of the text of the procedure. Now the programmer might use the SQUARE procedure to produce a new design like the one in figure 2, created by PANES, which follows:

```
TO PANES
SQUARE
SQUARE
SQUARE
SQUARE
END
```

For top quality performance from your computer, use the flexible discs known for memory excellence. Now, buy a specially marked box of 10 Memorex® 5¼" mini flexible discs and we'll send you an additional mini disc FREE.

Features like our uniquely sealed jacket and protective hub ring make our discs last longer. And a soft inner liner cleans the ultra-smooth disc surface while in use. It all adds up to better performance and reliability.

Our proprietary high density media formulation and 100% error-free certification guarantee reliable performance in all single or double density applica-

tions. So for business, word processing, or personal computer applications, Memorex mini discs are sure to do the job. And we back them with a full year warranty to prove it.

So see your local Memorex distributor or dealer or call (800) 538-8200 (In California (408) 987-1893) today. Buy a box of 10 flexible 5¼" mini discs. Then send the coupon in the box to Memorex for your free mini disc. It's that simple.

It's a great way to improve your memory and get a big bonus in computer performance.

MEMOREX
A Burroughs Company

Improve
your memory
by 10%.

Dealer inquiries invited.



Circle 252 on inquiry card.

© 1982 Memorex Corporation
Memorex is a registered trademark of Memorex Corporation.
Offer ends December 31, 1982. Offer good only in U.S.A.

The beginner gets an immediate sense of the relationship between program and goal and rapidly elaborates this into an understanding of the relationships among goals and subgoals, procedures and subprocedures (e.g., the programmer learns that PANES is made by running the SQUARE procedure four times). The beginner is involved in debugging, in learning by doing and thinking about the process. (For example, the pro-

grammer may create a square that doesn't close. Listing the procedure, the student catches a bug in the input to FORWARD when drawing the last side of SQUARE; it should be FORWARD 63, not 36.) The programmer may use anthropomorphism or identification as a debugging aid (e.g., pretending to be the turtle causes a person to walk in the same path as the turtle would, and it also helps to understand the turtle's

behavior). Thus, in a first session, a programmer writes a procedure that then becomes part of Logo's working vocabulary. In doing this, the programmer achieves a sense of the power available to influence the environment and a sense of accomplishment and creativity.

A Model of Learning Styles

I have observed that children take over the computer in different ways. They show different learning styles, different paths into the computer work. Undoubtedly, this bare statement is true for all learning. What is special here is that the flexibility of the computer allows the process to go

In working with computers, many paths lead to the same goal. Moreover, many equally great goals can be pursued.

further and become more explicit. In working with computers, many paths lead to the same goal. Moreover, many equally great goals can be pursued. This gives children the opportunity to express themselves and explore their own intellectual styles.

Although each child has a unique intellectual personality, and the use of the computer allows us to respect it, we do observe some similarities. I shall describe three distinct learning styles that have emerged, not only from my own work with young children, but from work completed by Dan Watt as part of the MIT-Brookline Logo Project.

The first learning style I call the planner. This child might build structured programs from the top level down or from the bottom level up, but always from a coherent formulated plan.

A second learning style is the macro-explorer. This student likes to mess about with subprocedures or building blocks to arrive at a product,

Whitesmiths, Ltd.
is now shipping Pascal Compilers
for 10 (count 'em ten) different
operating system families:

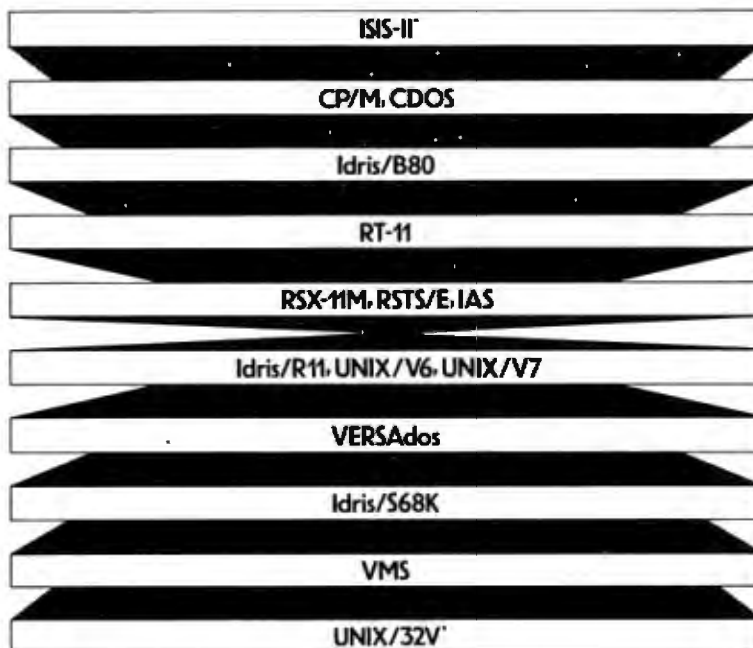

*Available in source form only.

Idris is a trademark of Whitesmiths, Ltd. ■ UNIX is a trademark of Bell Laboratories ■ CP/M is a trademark of Digital Research ■ RSX-11M, RSTS/E, RT-11, LSI-11, VAX, and VMS are trademarks of Digital Equipment Corporation ■ VERSAdos is a trademark of Motorola Inc.

All implementations support the full ISO Pascal (Level 0). All pass the Tasmanian Validation Suite with flying colors.

You can partition your Pascal program into separately maintainable files. You can write library functions to add to the extensive set we give you. And you can mix in modules written in other languages, like assembler or C.

In fact, a C Compiler comes with every Pascal Compiler we sell. Prices start at \$950.00. Write or call.

Distributors: Australia, Fawcett Pty Ltd. P.O.B 224 Hurstville NSW 2220 570-6100
Japan, Advance Data Controls Corp. Chiyoda-ku, Tokyo 03263-0383
United Kingdom, Real Time Systems, Newcastle upon Tyne 0632 733131

Whitesmiths, Ltd.

Parkway Towers, 'B', 485 US Route 1 So., Iselin, New Jersey 08830 (201) 750-9000 Telex: 645592

A Fast, Easy, Inexpensive Approach to Word Processing

NEW

PIE Writer: Word Processing System

Hayden is thinking about your future. We know you're concerned with saving time and money . . . with increasing efficiency and productivity . . . and that is the reason for PIE Writer!

Now you can turn your Apple II into a complete word processing system. PIE Writer, a powerful editor and formatter, offers the versatility and machine efficiency of the larger systems—at a fraction of the cost!

Now all your documents and correspondence—reports, memos, direct mail pieces, even "personalized" form letters—can be composed, edited, formatted, and printed quickly and accurately. Simple keystroke commands let you alter characters, words, sentences, even entire paragraphs!

Take a look at some of PIE Writer's powerful new features:

- Incremental Spacing—adds fractions of space between words for text justification.
- Fast page scrolling.
- Call command—allows access to machine language subroutines.
- Saves formatted output on disk file.
- Works with 40 or 80 column display boards.
- Word Tabbing—cursor stops at beginning of every word, in addition to set stops.
- Tab stops can be saved on file.
- Word Delete—deletes entire words at a time.
- Lower case capabilities.
- Prints **BOLD**.
- Centers.

All this and more . . .
for only \$149.95!

Upgrade your PIE 2.0: Send \$75.00, check or money order, and original disk (at sender's risk) for upgraded version.

Learning to use PIE Writer is as easy as learning to type. There are many user-oriented features, designed for first-time users as well as serious programmers: an easy-to-understand, indexed instruction manual, a carefully designed reference card, an interactive tutorial with each diskette, a "help" screen listing key command descriptions for reference as text is edited, and an easel binder for at-a-glance aid.

If you're looking for high-quality at a low cost, PIE Writer is your best investment. Order yours today! 12009, Standard; 13409, Smarterm, Sup'R'Term, Videx



Available at your local computer store

or order direct;
1-800-631-0856
in New Jersey 201-843-0550, ext. 382

Hayden

Mail Dept. #BY82112 • Hayden Book Company, Inc.
To: 50 Essex Street • Rochelle Park, NJ 07662
Please accept my order and send me the PIE Writer System for the following display board.
Please 40 column 80 column
Check: (#12009) (#13409)
 My money order for \$149.95 is enclosed; or
 Please charge my Visa MasterCard

Name _____
Address _____ Apt. _____
City _____
State _____ Zip _____
MasterCard/Visa# _____ Expires _____
Signature _____

Residents of NJ and CA must add sales tax.

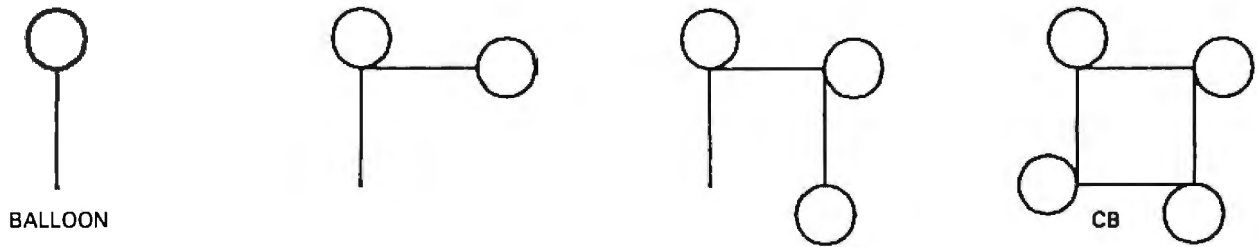

Figure 3: CB as evolved from BALLOON. Using techniques developed to build SQUARE, 6-year-old Janet designed CB from the procedure BALLOON.

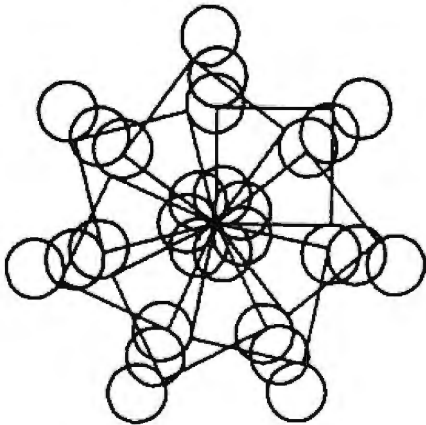

Figure 4: FLOWER, also designed by Janet, is created by using the procedure CB, but turning the turtle 51 degrees and repeating the procedure seven times.

rather than starting out with a specific goal. In this case, the learner is intent on exploring the effect of the particular building block. Therefore, the result is open-ended.

Finally, some learners have to explore their environment on a micro-level before they can establish patterns of planning or directed exploration. These micro-explorers are often the most timid learners, doing such things as assuring themselves that FORWARD 100 is the same as FORWARD 1, FORWARD 9, FORWARD 11, FORWARD 23, and FORWARD 56. Others might exhibit this conservative, gradual exploration by using the same numbers as inputs to FORWARD and RIGHT, or by repeating the same commands over and over.

Any child might use all three of these learning styles. In an initial session, I might try to "plant seeds" for all three. For example, I would encourage a beginning student to drive

the turtle around the screen in a series of direct commands with no goal other than to understand the turtle's behavior. But in the same initial session, I would suggest some concrete goal, such as making the turtle walk in a square or, perhaps, having placed some squares on the screen, I would ask the child to make the turtle touch them. In this, I elicit primarily a micro-explorer style with some hint at a planner style.

I facilitate a macro-explorer style by seizing on something interesting the child has just done and suggesting "teaching" it to the computer. Thus, I encourage the child to form procedures, thereby turning the turtle meanderings into repeatable procedures or building blocks. Using these procedures, the child can create more unanticipated designs.

I would encourage children to follow a planner style of learning by asking them to choose a design from a collection of procedures already familiar to them or by asking them to make a design of their own and use these as procedures. Being sensitive to these styles of learning and their natural intermixing helps to develop strategies for guiding the children. These styles of learning are exhibited by novices to programming in Logo regardless of their age.

Using Procedures

Janet, a 6-year-old, had previously made a square. In constructing CB (see figure 3), she used similar techniques. She made the turtle draw BALLOON and then turn RIGHT 90 repeatedly until it had walked in a complete path and returned to the position and heading it started from.

Janet was not aware of this as a generalization, but her specific experiences led her to believe that these two actions repeated over and over resulted in the turtle making a complete trip, i.e., return to its starting state.

Next, FLOWER (see figure 4) was made by running CB, turning the turtle 51 degrees, and repeating these two actions six more times. Why 51 degrees? Well, Janet just happened to pick that number. Why did 51 have that effect on CB? The answer lies in the fact that turning the turtle 51 degrees seven times results in a total turning of 357 degrees, which is very close to a complete rotation of 360 degrees. In this situation, Janet was satisfied; for her purposes, the design was complete.

A more interesting question is: How did she know to probe the turtle environment in this way? She knew certain facts about turtles and turtle-directed procedures that she had gained from her experiences with the turtle. For example, if the turtle draws something and doesn't return to its starting state, repeat the procedure. Something interesting will happen and eventually the turtle will come back to where it was initially. On the other hand, if the turtle does return to its starting state when it makes a design, change the turtle's heading and run the program again. In other words, Janet did not need the teacher's knowledge about the power of 360 degrees. Rather, she needed the idea of the total turtle trip that, translated into intuitive knowledge, told her to keep repeating an action until the turtle returned to its starting state. Janet's learning style in this project

We're selling Tandon with abandon!

We are overstocked!

Our warehouse runneth over with Tandon Drives.

Help!

Help us clear the decks and help yourself to significant savings on these excellent products.

We've always been high on Tandon. (Even when we're not up to our knees in 'em.) They offer an unsurpassed storage capacity, a very advanced dual-head design, increased throughput - and proven reliability.

So at these prices, you should *definitely* buy a drive. Buy two. Maybe someone you know is having a birthday soon. Buy one for them.

Call immediately. They won't last very long.

Hopefully.

Tandon's TM100 series of 5-inch mini-floppy disk drives all feature Tandon's patented read/write head design. Available in four models:

TM100-1 A single-sided, 40 track, 5.25-inch floppy-disk drive with a storage capacity of 250K bytes unformatted and a track-to-track access time of 5-milliseconds.....209.00

TM100-2 double-sided, 40 track per side, 5.25-inch floppy-disk drive with a storage capacity of 500K bytes unformatted and a track-to-track access time of 5-milliseconds.....275.00

TM100-3 A single-sided, 80 track, 5.25-inch floppy-disk drive with a storage capacity of 500K bytes unformatted and a track-to-track access time of 3-milliseconds.....275.00

TM100-4 A double-sided, 80 track per side, 5.25-inch floppy-disk drive with a storage capacity of 1000K bytes unformatted and a track-to-track access time of 3-milliseconds.....399.00

Tandon's TM848 "Thinline" series of 8-inch floppy-disk drives all feature Tandon's patented read/write head design. The unique "Thinline" design allows two drives to be installed in the same space as a single conventional drive.

Available in two models:

TM848-1 A single-sided, 77 track floppy-disk drive with a storage capacity of 600K bytes single density and 1.2 megabytes capacity double density (IBM format), and a 3-millisecond track-to-track access time..... 420.00

TM848-2 A double-sided, 77 track per side floppy-disk drive with a storage capacity of 1.2 megabytes single density and 2.4 megabyte capacity double density (IBM format), and it has a 3-millisecond track-to-track access time. 515.00

We built a reputation on our prices and your satisfaction.

We guarantee everything for 30 days. If anything is wrong, return the item and we'll make it right. And we'll pay the shipping charges.

We accept Visa and Master Card on all orders; COD orders, up to \$300.00.

Add \$2.00 for standard UPS shipping and handling on orders under 50 lbs; delivered in continental U.S. Call for shipping charges over 50 lbs. Foreign, FPO and APO orders, add 15% for shipping. Californians, please add 6% sales tax.

Prices quoted are for stock on hand and are subject to change without notice.

**Alpha
Byte
COMPUTER
PRODUCTS**

To order or for information call
(213) 706-0333
Modem order line: (213)883-8976

**31245 LA BAYA DRIVE,
WESTLAKE VILLAGE, CA 91362**

DISCOUNT LINE 1-800-528-8960

GUARANTEED LOW PRICES

APPLE CARDS

16K RAM — \$99 Z80 CARD — \$210
Videx Card — \$249 Smart Term — \$269
Graphic Card — \$89 Glock CARD — \$120

ALTOS

8000-2 — \$2675 8000-15 — \$3850

ANADEX

9500 — \$1200 9501 — \$1200

ATARI

400-16K — \$399 800-16K — \$659
410 — \$79 810 — \$429
825 — \$569 850 — \$167

C-IOTH

F-10P — \$1380 F-10S — \$1525

DATASOUTH

DS120 — \$595 DS180 — \$1259

DIABLO

630RO — \$1945 630KSR — \$2475

DISKETTES/BOXES

Elephant — \$20 Scotch — \$25 Dysan — \$35

EPSON WITH GRAPHICS

MX70 — \$289 MX80 — \$429
MX80FT — \$519 MX100 — \$689
GRAPHIC ROM — \$69 RS232 — \$69

HAZELTINE

1500 — \$995 ESPRIT — \$595

LOBO

Apple Drive/Card — \$350/\$50

MODEMS

HAYS — MICROMODEM — \$290
HAYS — SMARTMODEM — \$229
Panfil — 300/1200 (212A) — \$795

MONITORS

Teco-BW — \$99 Teco-Green — \$115
Sanyo-Green — \$249 Color — \$425
Amdek-Green — \$159 Color — \$349

NORTHSTAR

Advantage — \$2995 HR64QD — \$3025

NEC

8023 — \$489 7710 — \$2350

MPI

88G — \$550 99G — \$650

SOROC

120 — \$659 135 — \$689

TELEVIDEO

912 — \$669 950 — \$915

TI

810 — \$1240 820 — \$1795

SOFTWARE

All Major Brands — \$CALL

MOUNTAIN HARDWARE

CPS Card — \$169 Music System — \$429

OKIDATA

M80 — \$320 SL125 — \$3150
M82A — \$450 SL250 — \$4200
M83A — \$699 M84 — \$1059

XEROX

820 — \$2399

ZENITH

Z19 — \$669 Z89 — \$2129

All Prices Subject To Change

EXPOTEK

2723 W. Windrose • Suite 3
Phoenix, Arizona 85029

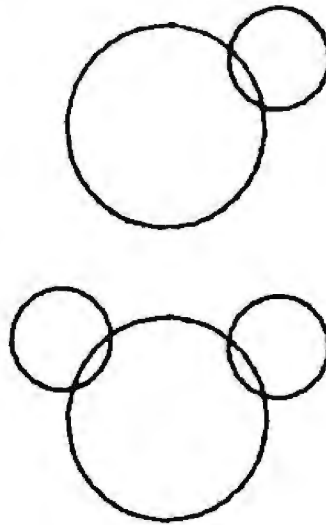

Figure 5: Initial design for the BEAR project. Starting with the design on the top, Lisa added another circle to create an evolving design.

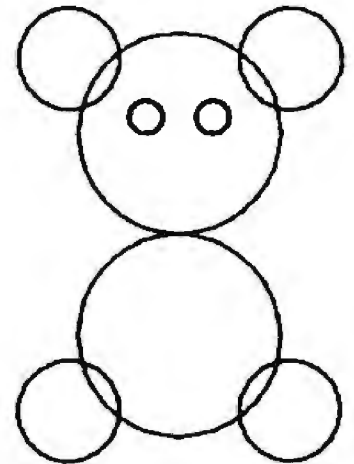

Figure 6: Completed BEAR. Repeating the procedure to create the head, Lisa modified her learning style and created this design.

and many others was that of a macro-explorer.

The BEAR project was initiated by Lisa, an 11-year-old from an inner-city school close to MIT. Lisa approached the project as a micro-explorer. Although she had previously written several procedures, Lisa showed great resistance to using them as building blocks. For example, after constructing a square procedure, she tried to reconstruct a square, as other micro-explorers might, by telling the turtle to move in incremental steps, e.g., FORWARD 11, FORWARD 9, etc.

I asked her to play with circles using CIRCLES or CIRCLEL procedures, which require the radius as input. I encouraged her to try using circles of different sizes. She made the circles shown at the top of figure 5. I then encouraged her to do the same thing on the other side of the larger circle, as shown at the bottom of figure 5. When asked what it reminded her of, she thought it looked like a bear's head. She then added the eyes and used the head for the body (see figure 6). In so doing, I helped her shift modes from micro-explorer to planner.

This project illustrates clearly that many ways can be used to arrive at a

particular goal. Picking a starting state for the turtle influences the construction of the procedure. Whether the job is thought of in terms of sub-procedures or whether the design is first created by the student (whether by the mind's eye or on paper) and the turtle is made to trace the path etched on paper has important consequences in how the project is developed.

If the design is to be taught to the turtle by breaking it up into parts, the programmer has to decide what building blocks are needed. This BEAR has several interesting features. It is made entirely of circles. The head and the body are identical. The project is easily changed to focus only on the head or to create, with minor modifications, a different animal (see figure 7).

Both Lisa and I benefited from this project. She became a more confident problem-solver and tended to move away from her micro-explorer style of probing. She used a powerful mathematical idea, symmetry, in a playful but personally meaningful way, and used it throughout her project. I, on the other hand, added to my collection of programming projects. We both followed our intuition. I was



“THAT WORKS GREAT!”

Planning an on-time, on-budget project has always been hard work. But our new VisiSchedule™ program can help you and your personal computer make short work of it.

The VisiSchedule program is a fast and easy way to control projects, level resources, meet deadlines, and beat cost targets.

The VisiSchedule program instantly shows you the critical path among your project's tasks. It allocates all costs and personnel, and specifies earliest/latest start dates, slack times, holidays, prerequisites and deadlines for each task. And it produces summaries, time charts, and milestone reports for management.

You can actually develop your project as you enter data, investigate tradeoffs between manpower, costs and time. Ask “what if?” ... add, move, slip or change any task, skill level or cost, and the VisiSchedule

program automatically displays the impact of your changes. This makes it a snap to keep schedules and costs current, too.

While the VisiSchedule program does a lot by itself, it can do even more for you when used with other Visi™ programs. That's because they're all inter-related, just like your needs and tasks, to give you a fully integrated solution. For example, automatically transfer the cost data to our VisiTrend/Plot™ program and analyze cause-and-effect relationships. Then instantly plot the results in charts and graphs for better communication.

In addition, our series includes the VisiCalc®, VisiFile™, VisiDex™, VisiPlot™, VisiTerm™

and Desktop/PLAN™ programs.

Ask your retail computer store salesperson for a demonstration of the VisiSchedule program. Discover how easy it is to make short work of planning and budgeting all your work.

**VISI SCHEDULE™ FROM
VISICORP™**
PERSONAL SOFTWARE™



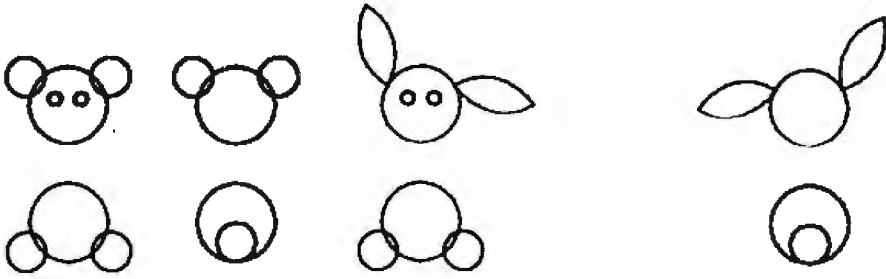

Figure 7: Other animals created by modifying the BEAR procedure.

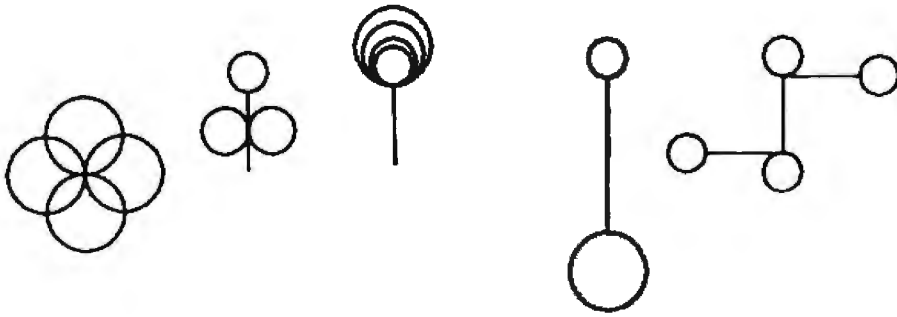

Figure 8: Other designs created by Lisa using Logo.

hopeful that when Lisa used circles as building blocks she would discover some lovely thing to make with them, and she did.

A Model of Teaching and Learning as Debugging

Turtle geometry is but one part of the Logo computer culture. Other

areas of activity have been explored and many more are waiting to be explored. Turtle geometry, however, serves to illustrate key characteristics of the culture, in particular, the idea of exploring an environment and the objects in it by manipulating them through a complex of interactions based on procedural descriptions. By

elaborating the descriptions through debugging (testing procedures in real situations), getting concrete feedback on these actions, and adjusting the initial descriptions to take into account these results, a person's exploration in Logo will be furthered. The process of procedural description and debugging might be seen as a dynamic process of assimilation and accommodation, of making theories and revising them as a result of experience and knowledge, but doing this playfully as an enjoyable activity involving one's whole self.

Conclusions

Sharing in this learning process is a self-empowering experience for all participants. A different way of looking at learning and teaching emerges, one based on the Piagetian idea that even very young children have theories. Thus, teaching and learning are not a matter of being wrong or right, but rather a process of debugging. Learning and teaching are intertwined and become a process of developing debugging aids as knowledge gaps are discovered and filled in. The persons using computers are cast in the role of both student and teacher as they actively participate in development of the computer culture. They contribute to its richness and enrich their own lives. ■

Scratch Pad

The Ultimate Spreadsheet. Never See "Out of Memory" Again.

SuperSoft

P. O. BOX 1628
 CHAMPAIGN, IL 61820
 © (217) 359-2112 TELEX 270365

First In Software Technology.

Logo—A Cultural Glossary

E. Paul Goldenberg
Lincoln-Sudbury Regional High School
390 Lincoln Rd.
Sudbury, MA 01776

For easy access, the terms in this glossary are arranged alphabetically, but this arrangement hides the complex interrelationships of the ideas in the definitions. The groupings on this page were developed to make obvious the relationships between important Logo concepts. You can use it as a map to guide you through the glossary.

The groupings do not represent a true tree structure because some of the terms appear under several different headings. The main concepts are organized into broad categories, with more detailed information listed in outline form under each main heading.

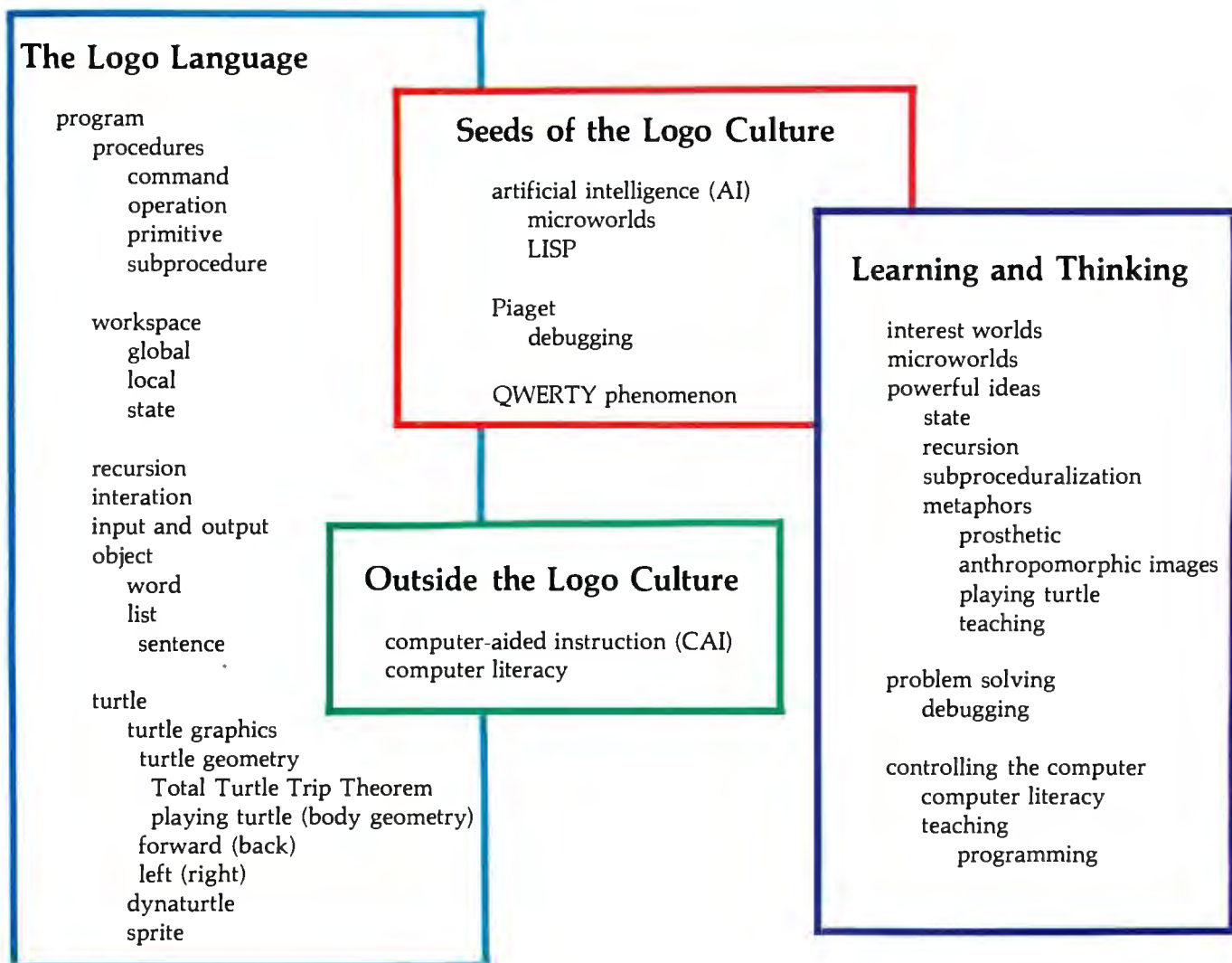

IMAGINE IT...

NOW WITH
**DUAL HI-RES
GRAPHICS**

NEW



CAPTURE IT

Completely Redesigned. Now, the Grappler +.

The original Grappler was the first graphics interface to give you hi-res screen dumps from your keyboard. The new Grappler+ with *Dual Hi-Res Graphics* adds flexibility with a side-by-side printout of page 1 and page 2 graphics.

Interfacing the Grappler+ to a wide range of printers is easy as changing a dip switch. 4K of exclusive firmware makes the Grappler+ the most intelligent, full-featured Apple Printer Interface made. And, the Grappler+ is Apple III compatible.**

The imitations are many, so insist on the #1 Apple Graphics Interface on the market. Insist on the Grappler+. Available now at most Apple dealers.

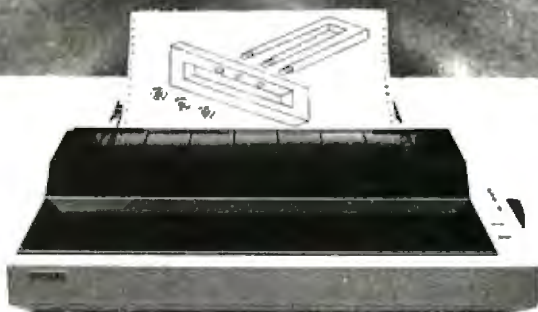

ACTUAL APPLE II PRINTOUT USING GRAPPLER+ AND EPSON MX100

With The
Grappler+
Printer Interface

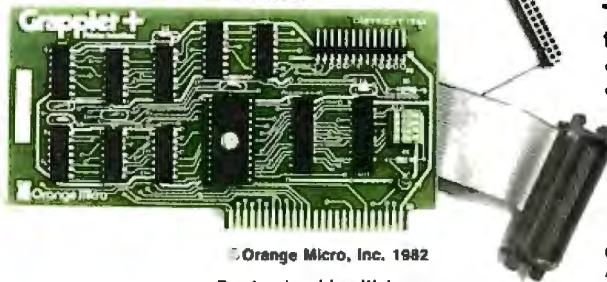

© Orange Micro, Inc. 1982

Foreign Inquiries Welcome
TLX #183511 CSMA

The Grappler+ Features:

- Dual Hi-Res Graphics • Printer Selector Dip Switch • Apple III Compatible* • Graphics Screen Dump • Inverse Graphics • Emphasized Graphics • Double Size Picture • 90° Rotation • Center Graphics • Chart Recorder Mode • Block Graphics • Bell Control • Skip-over-perf • Left and Right Margins • Variable Line Length • Text Screen Dumps.

The Grappler+ works with Pascal and CPM.

The Grappler+ interfaces with the following printers:

- Anadex • Centronics • Datasouth • Epson** • IDS • NEC • C-Itoh • Okidata**

Orange Micro
Inc.

3150 E. La Palma, Suite G
Anaheim, California 92806
(714) 630-3620

Circle 309 on Inquiry card.

CPM is a registered trademark of Digital Research, Inc. Apple II and Apple III are registered trade names of Apple Computer Inc.

*Requires additional software driver.
**Requires graphics upgrade.

This glossary is more cultural than technical partly because the learning philosophy behind Logo is more of a culture than a technique. The Logo technical vocabulary consists, for the most part, of familiar words adopted from general usage to refer to specific Logo metaphors, images, and ideas. Many of the terms and definitions presented here are derived from three books: Seymour Papert's *Mindstorms: Children, Computers, & Powerful Ideas* (New York: Basic Books, 1980); Harold Abelson and Andrea diSessa's *Turtle Geometry: The Computer as a Medium for Exploring Mathematics* (Cambridge, MA: MIT Press, 1981); and my own *Special Technology for Special Children* (Baltimore: University Park Press, 1979). Reference is also made to Brian Harvey's article "Why Logo?" on page 163 in this issue of BYTE.

anthropomorphic images: metaphors in which computers, computer procedures, and objects controlled by computers are thought of as if they were persons. "Anthropomorphic images facilitate the transfer of knowledge from familiar settings to new contexts. For example, the metaphor for what is usually called programming computers' is teaching the turtle a new word." (See Papert, page 59.) Thinking of the machines as (limited) people—and even modeling people's behavior through analogies to machine processes—does not involve treating people like machines. (On this latter point, see the entry on **computer-aided instruction**.)

About the Author

While working with the Logo Group at MIT, E. Paul Goldenberg pioneered in applications of Logo for education and rehabilitation of children with severe communication handicaps. His book *Special Technology for Special Children* presents the philosophy, psychology, and technology behind this work and illustrates it with case histories. He is currently Assistant Professor of Rehabilitation Medicine at Tufts Medical School and will soon be director of the computer department at Lincoln-Sudbury Regional High School.

artificial intelligence (AI): the branch of computer science from which Logo grew. The name of this science derives from its attempts to simulate, using machines, the behavior that is regarded as intelligent in people or animals. If this narrow view of the field was ever true, it no longer is. Cognitive psychology and artificial intelligence together are sometimes referred to as cognitive science. They study such disparate processes as natural-language understanding, visual perception, and knowledge acquisition. Good studies of human information processing frequently require both a careful study of how people perform tasks and serious attempts to build models based on a theory and observations to test the theory. The complexity of these models requires computer simulation.

command: a Logo procedure that performs in some particular way, but does not return a value to its calling procedure. It's analogous to a procedure in Pascal. See also **operation**.

computer-aided instruction (CAI): in the broadest sense, any educational endeavor that is aided by computers. In general, however, CAI means automated worksheets (drill and practice) or electronic tutors (frame-oriented CAI or automated programmed texts). This is very different from the Logo philosophy of using the computer not as the supplier or exerciser/tester of knowledge, but rather as a context within which to use thinking to solve problems of genuine interest.

Programmed learning explicitly models the human as a machine in that the student is being programmed by the computer. Logo learning sees the learner as the agent—actively constructing knowledge. The student takes the teacher's role—teaching the turtle a new word.

computer literacy: often seen as a general (and superficial) experience with computers. This concept is tied to a transitional stage in the spreading

of computer technology. When computers were rarer and more specialized, computer literacy was not an issue (just as no one now worries about electron-microscope literacy). When computers become as common as cars, computer literacy will cease to be an issue.

Literacy has two conventional meanings. The first—being well-read and articulate in one's language—suggests fluency in a particular computer language. Programming is having the ability to express a novel idea in that language. Letting children be programmers, helping them to become fluent at expressing mathematical and logical ideas, is the Logo sense of a thoughtful literacy. (This idea, however, doesn't fit in with the image that the word "literacy" is generally used to convey, a skill that every child must learn in order to be able to cope. It's more like learning a foreign language: a valuable skill for those who choose to learn it, but not an absolute requirement for life or for employability.)

The other conventional meaning of literacy—having minimal reading skills—makes little sense in a society replete with computers. With many computer languages to choose from, what could be considered minimal communication skills? Teaching general familiarity with computers without providing an opportunity to develop good communication skill is a little like having a course teaching people the names of the features of a car without allowing them to learn to drive.

controlling the computer: the issue is one of locus of control. Whereas computers have conventionally been used in education to program the kids—in effect, to control their behavior—the Logo philosophy stresses kids programming computers. It is often said that teaching is the best way to learn. The computer is a highly responsive student and rigidly faithful to its teacher. For students who have had little sense of control in school, this, even apart from the content of the subject they are studying,

CALL "THE COMPUTER-LINE"™

When you call us, you talk to fully qualified computer specialists trained to answer all your questions pertaining to our line of microcomputers. We are renowned for our excellent after sales support and our promptness for delivery. Peace of mind and excellence in service is our pledge to all our customers.

NEC PERSONAL COMPUTER

- PC-8001A Keyboard and processor unit, including 32K Ram, 24KB N-Basic Rom, cassette tape recorder interface, parallel printer interface, display interface. \$749
- PC-8012A Modular expansion unit, including I/O bus extension, diskette adaptor, 32KB Ram, real-time clock, 8 priority interrupt levels, 6 slots for additional boards. \$479
- PC-8023A Dot matrix printer - 100 cps, bidirectional printing, proportional printer. \$499
- PC-8031A Dual diskette unit, including two 163K byte diskette drives, interface cable, enclosure and operating system. \$749

We carry the entire line of NEC/BPI software for the personal computer. Please call or write for information.

CALIFORNIA COMPUTER SYSTEMS

7710 Async. Serial Int.	\$135	CPS Multi-Function Card	\$169
7490 GPIB (IEEE-488) Int.	\$239	The Clock	\$229
7470 Ana. to Dig. Converter	\$ 99	Supertalker	\$159
7711 Async. Serial (Term)	\$135	Music System	\$319
7712 Sync. Serial Int.	\$149	Expansion Chassis	\$599
7721 Apple Parallel Int.	\$109	Romwriter	\$139
Calendar/Clock Module	\$ 99	Ram Plus (32K Board)	\$149
Programmable Timer	\$ 99		

MOUNTAIN HARDWARE

CPS Multi-Function Card	\$169
The Clock	\$229
Supertalker	\$159
Music System	\$319
Expansion Chassis	\$599
Romwriter	\$139
Ram Plus (32K Board)	\$149

PRINTERS

NEC	INTEGRAL DATA SYSTEMS		
Spinwriter 7710/7730	\$2339	PRISM 132 Color printer with all options	
8023A	\$ 489		
EPSON (Graftrax Plus)		• 200 cps Sprint Mode	
MX-80	\$ 429	• 4-color printing	
MX-80FT	\$ 529	• Friction/Tractor feed	\$1595
MX-100	\$ 699		
All Epson and NEC dot matrix printer prices quoted are for immediate delivery inclusive of shipping, insurance and handling charges.		C-ITOH	
		F10 Word Quality Printer	
		• 40 CPS Printing	
		• Letter quality excellence	
		Now Only \$1395	
		Prowriter 120cps	\$469.00

BUSINESS SOFTWARE

VISICORP, INC.	STONEWARE		
Desktop Plan III	\$229	DB Master	\$169
Desktop Plan II	\$189	DB Utility Pack	\$ 69
Visifiles	\$189	MICRO PRO	
Visiplot	\$159	Apple CP/M	
Visitrend/Visiplot	\$229	Word Star	\$219
Visidex	\$189	Super Sort	\$119
Visiterm	\$ 79	Mail Merger	\$ 79
Visicalc 3-3	\$189	Data Star	\$179
Visipak	\$539	Spell Star	\$119
		Calc Star	\$119

APPLE WORD PROCESSING *On line's Sensational*

Screenwriter II	\$89
Call For Continental, Dakin 5, Broderbund, Automated Simulations, Avant-Garde, Edu-Ware, Denver, Howard, Sirius, Sensible, Synergistic Software, Etc.	

CALL FOR PRICES ON

- APPLE II
- FRANKLIN ACE
- BASIS 108
- RANA DRIVES
- TANDON DRIVES
- HARD DISK SYSTEMS

COMPUTE-R-CADE™

WE CARRY THE REVOLUTIONARY GAME ARCADE BOOTH FOR ATARI AND APPLE COMPUTERS! CALL FOR INFORMATION AND PRICING

MICROCOMPUTER BUSINESS INDUSTRIES

Appletime™ Clock Card	\$ 89
VIP™ Card. (The Ultimate graphics interface + cable)	\$99
All other VIP™ Cards	\$CALL

(See advertisement this Byte)

COMPARE!

DRIVES FOR APPLE

WITH CONTROLLER \$429

ADD-ON \$359

Hard Disks + 8" Disks for Apple, TRS-80 \$CALL
Apple Computer Products \$CALL



PRODUCTS • PLEASE CALL OR WRITE FOR CATALOG.

MODEMS

Hayes Micromodem II	\$289	DISKETTES (Boxes of 10)	
Hayes Smartmodem	\$229	Verbatim Datalife	\$ 24-95
Hayes Chronograph	\$199	Verbatim 8"	
Novation Cat	\$145	Double-Side/DD	\$ 39-95
Novation D-Cat Modem	\$165	RAM CARDS	
Novation Apple Cat II	\$339	Davong 16K Card	\$ 89
Novation Auto Cat	\$209	Microsoft 16K Card	\$129

CERMETEK

1200 baud modem	\$CALL	T and G PRODUCTS	
		Game paddles	\$ 29
		Joy Stick	\$ 44
		Selecta-port Expander	\$ 49

MONITORS

Zenith ZVM-121 Phosphor		80 COLUMN CARDS FOR APPLE	
15 MHZ	\$119	Wesper 80 Card	\$259
NEC 1201 Phosphor		Vision 80 Card (Vista)	\$289
20 MHZ	\$179	Videx 80 Card	\$259
NEC 0112 Composite Color	\$335	MISCELLANEOUS APPLE PRODUCTS	
NEC 2112 RGB Color	\$899	Enhancer II	\$ 119
Amdek 300 Phosphor	\$185	Dana Apple Fan	\$ 39
Amdek Composite Color	\$355	Sup R Mod	\$27-95
Amdek IBM Compatible Color	\$749		

IN COLORADO (303) 279-2727

CALL "THE COMPUTER-LINE"™

1-(800)-525-7877

COMPUTERWORLD INTERNATIONAL, INC.

SUITE 133, P.O. BOX 81, WHEAT RIDGE, COLORADO, U.S.A. 80034-0081

TERMS: RETAIL/MAIL ORDER: ADD 1% SHIPPING (MINIMUM \$2.50) - UPS GROUND.

WE HONOR ALL MANUFACTURERS WARRANTIES AND EXCHANGE FAULTY GOODS IMMEDIATELY. SPECIALISTS IN APO AND INTERNATIONAL DELIVERIES.



RETAIL: 1019 8TH STREET
GOLDEN, CO 80401

is a valuable experience. (The importance of being in control is particularly apparent in the Logo work of students with special needs. For more, see *Special Technology for Special Children*.)

debugging: improving the behavior of a program that does not do what you want it to. Logo emphasizes that programs that do not work as desired are merely unfinished, rather than bad finished products. This is in sharp contrast to many school situations in which a task is considered to be over when a particular time has come, rather than when it "works."

In school, a written composition tends to be graded as it stands, rather than debugged. (If the teacher does encourage a student to improve a paper, the effort involved can be prohibitive.) Logo teachers encourage students to love their bugs. If a turtle does not do what you wanted it to, chances are that it does something interesting anyway. The unwanted behavior may lead to new ideas more interesting than the original task. A bug can be neat! It can certainly teach you something . . . study it!

dynaturtle: a dynamic (rather than static) turtle. Whereas a static turtle has a fixed spatial position and heading, a dynaturtle may have a fixed velocity or acceleration. Whereas commands (state-change operators) to a static turtle specify a change in position (e.g., FORWARD 100) or heading (e.g., LEFT 90), a command to a velocity turtle specifies a change in velocity and has an analogy to force. Dynamic turtles can be a flexible laboratory tool for experimentation in physics and mathematics and, like their static cousins, for aesthetics as well.

FORWARD: Logo command to the turtle telling it to move forward in the direction it is heading. This state-change operator takes a single input that says how far (in turtle-steps) forward to move. For example, FORWARD 100 says move forward 100 units; FORWARD :SIDE + 10 says move forward the distance 10 + :SIDE (whatever value the variable :SIDE

happens to have at the moment). The only other turtle-geometric state-change operator dealing with the turtle's position is called BACK. Neither of these change the turtle's heading. See also LEFT.

global: something pertaining to the entire environment being considered. Among variables, global variables are those that can be accessed and changed from any place in a program. Logo encourages the use of local variables—variables that belong to a particular procedure—because they make for more orderly and more debuggable programs.

Another kind of global reference is the Cartesian coordinate system. It is global in that each point is specified in relation to a standard referent (the origin). Points are not specified in relation to each other. For a discussion of the difficulties caused by such a global perspective for graphics representation, see the section of Brian Harvey's article "Why Logo?" on page 178 in this issue of BYTE. Logo's orientation is, in general, toward local references. See local.

input and output: within the Logo culture, we pay more attention to the inputs and outputs of procedures than to traditional issues of hardware. The input to a procedure is thought of as a message that the procedure needs in order to do its job. As an example, FORWARD needs an input telling it how far to move the turtle; PRINT needs to know what to print. Some procedures need more than one input message in order to know what to do. A procedure to draw arbitrary polygons, for example, needs two inputs, one telling it the size of its forward step, and the other telling it the angle to turn at each corner.

The output of a procedure is a message sent back to the procedure that called it. For example, SUM outputs a message that is the sum of its two inputs. A procedure that produces output (see operation) must send its message to a procedure expecting an input. (In this way, output and input are closely linked in Logo.) Hardware aspects of I/O are handled

conveniently for the programmer so she can concentrate on the behavior of the conceptual building blocks (procedures) she is creating without wasting attention on the machine.

interest worlds: areas of special interest in which the computer can be a useful tool, servant, or laboratory. Art, music, geometry, physics, and language have all been extensively developed as interest worlds by various Logo investigators. See also micro-worlds.

iteration: telling the computer to execute something repeatedly. See recursion, which Logo favors as a control structure.

learning: the focus of the Logo environment. What one does for oneself. See teaching.

LEFT: Logo command to the turtle telling it to turn left while remaining in the same location. This state-change operator takes a single input that says how many degrees to turn. For example, LEFT :ANG says turn left :ANG degrees (whatever value the variable :ANG happens to have at the moment). The only other turtle-geometric state-change operator dealing with the turtle's heading is RIGHT. See also FORWARD.

LISP: acronym for LIST Processing. A programming language widely used in artificial-intelligence research, the basis for many of the ideas in Logo.

list: Logo's fundamental data structure. A list is an ordered sequence of arbitrary Logo objects (see object). Since its elements may be either words or other lists (which may themselves contain yet other lists, nested to any level), lists can be used to create very complex data structures. They can represent information trees (decision trees, binary trees, etc.) and unordered sets. Lists are sometimes used in Logo to accomplish the same purposes for which arrays might be used in other languages. (Logo also has other ways of providing access to information that is indexed numerically or with alpha-

WHEN WE ANNOUNCED SAGE II, 8-BIT COMPUTERS BIT THE DUST.



16-BIT, 8 MHZ, 68000 MICROPROCESSOR.

The new Sage II doesn't look exactly awesome. Some folks even mistake it for a disk subsystem.

But the fact is, 8-bit microcomputers don't stand a chance against it. Minicomputers are shaking in their boots. And even a few mainframes are running scared.

Because the Sage II is based on the incredible 68000.

UP TO 512K, NOT COUNTING DRIVES.

With its 24-bit address bus, the Sage II can address 16 megabytes.

The stripped down version features a mere 128K RAM.

On top of that, you can add another 384K of "RAM DISK" (on-board RAM that looks like a super-fast disk to the operating system).

Then come the real disk drives. Your choice of 40 or 80 track, 320K to 1.3 megabyte, 5-1/4". A 10K program loads in half a second.

p-SYSTEM* OPERATING SYSTEM.

This optional, interactive operating system makes it possible to use programs currently running on 8-bit computers.

It supports Pascal, FORTRAN 77, BASIC and 68000 Macro Assembler languages and a host of utility and applications programs.

MORE FOR THE MONEY.

Prices for the Sage II start at just \$3,600 with one disk drive and 128K RAM.

No other computer in history has offered so much performance per unit price.

Call or write us today for the whole story.

195 North Edison Way, Suite 14
Reno, Nevada 89502
(702) 322-6868

* UCSD p-System is a trademark of the Regents of the University of California.

SAGE
COMPUTER TECHNOLOGY

**Right away,
you can see a difference.**



Stop in a store near you. Take a look.
 You'll be instantly taken with some of the features that make the IBM Personal Computer so different.

Like the non-glare screen — easy on the eyes during those number-crunching tasks like payroll and general ledger.

80 characters a line — with upper and lower case letters for a quick and easy read.

And the flexibility of a system that lets *you* move the components around at will.

(To get really comfortable, try the keyboard on your lap and put your feet up.)

Read, compare.

Progress from casual buyer to comparison shopper, you'll want the inside story of the IBM Personal Computer.

Like user memory expandable up to 256KB. And 640K of permanent memory.

(Which not only includes the BASIC language, but diagnostic instructions that automatically check the system every time you turn it on.)

A 16-bit microprocessor that can improve speed and productivity.

A mix of crisp text and high-resolution color graphics on your own TV set — clearly helpful for creating charts to target forecasts and trends.

Or the 10 programmable functions that let you bid goodbye to the tedium of repetitious tasks.

And the list goes on. Which is why we've included a box (at right) that tells all.

There's more than meets the eye.

Some of the best things about the IBM Personal Computer aren't part of the computer.

Like the instruction manuals that help you set up your system and teach you to use it with the greatest of ease.

IBM PERSONAL COMPUTER SPECIFICATIONS

User Memory 16K-256K bytes*	Display Screen High resolution* 80 characters x 25 lines Upper and lower case Green phosphor screen*	Permanent Memory (ROM) 40K bytes*
Microprocessor 16-bit 8088*	Operating Systems DOS, UCSD p-System, CP/M-86*	Color/Graphics <i>Text mode</i> 16 colors* 256 characters and symbols in ROM*
Auxiliary Memory 2 optional internal diskette drives, 5 1/4", 160K bytes or 320K bytes per diskette	Languages BASIC, Pascal, FORTRAN, MACRO Assembler, COBOL	<i>Graphics mode</i> 4-color resolution: 320h x 200v* Black & white resolution: 640h x 200v*
Keyboard 83 keys, 6ft. cord attaches to system unit*	Printer Bidirectional* 80 characters/second 12 character styles, up to 132 characters/line* 9 x 9 character matrix*	Simultaneous graphics & text capability* Communications RS-232-C interface Asynchronous (start/stop) protocol Up to 9600 bits per second

*ADVANCED FEATURES FOR PERSONAL COMPUTERS

And an expanding library of software programs that meet IBM's demanding specifications.

Programs for business. Education. The lab and the home. Programs that make the IBM Personal Computer *your* tool for modern times.

See for yourself.

The quality, power and performance of the IBM Personal Computer are what you'd expect from IBM. The price isn't.

So stop in and take a look.

Visit an authorized IBM Personal Computer dealer. For a store near you, (or for information from IBM about quantity purchases) call (800) 447-4700.

In Illinois, (800) 322-4400 or Hawaii, (800) 447-0890.

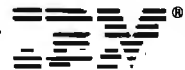

The IBM Personal Computer A tool for modern times

*UCSD p-System is a trademark of the Regents of the University of California. CP/M-86 is a trademark of Digital Research, Inc.

betic labels. Some Logo implementations have array-handling primitives.) The simplest elements of lists are words.

local: something that has meaning only in the specific context in which it is being used. A local variable is one whose name has a value only within the procedure in which it is defined. Most variables used in Logo are local. The turtle's perspective on its turtle-moves is also a strictly local one. It does not know where it is (with respect, say, to a globally defined origin). In the grand scheme of things, it doesn't need to know where it is. It only needs to know how to move with respect to itself. "The turtle can forget about the rest of the plane when drawing a circle and deal only with the small part of the plane that surrounds its current position.

"By contrast, $x^2 + y^2 = r^2$ relies on a large-scale, global coordinate system to define its properties. And defining a circle to be the set of points equidistant from some fixed point is

just as global. . . . The turtle representation does not need to make reference to that 'faraway' special point, the center." (See Abelson and diSessa, page 14.) This local view of movement in space is not only easier to use for simple mathematical ideas, but lends itself quite beautifully to extensions into very fancy math; calculus and limits immediately come to mind. See **global**.

Logo: not an acronym. Derived from the Greek word for "word" or "thought." The name was coined by Wallace Feurzeig at Bolt Beranek and Newman Inc., one of the collaborators in the development of the language.

metaphor: Logo learning makes considerable use of metaphor and pays particular attention to which metaphors are chosen. Is a computer a tutor, a student, a pair of eyeglasses, or a screwdriver? Is a variable name the name by which we refer to a particular value, or the

name of a box in which we find whatever we find? Are procedures little folks with specific jobs to do? Are robot turtles literate but literal-minded pets? It is not that Logo learners have particular metaphors that are different from those of others—some people find the little-people model of procedures useful, while others find it irritating—but that the use of metaphor is such a natural part of Logo learning.

microworlds: as used by Logophiles, a microworld is a well-defined, but limited, learning environment in which interesting things happen and in which there are important ideas to be learned. A microworld can have other microworlds within it. For example, within the microworld of turtle graphics, one can define a smaller microworld consisting of all the designs that can be drawn with a POLYSPI procedure. (See R. W. Lawler's "Designing Computer-Based Microworlds" on page 138 in this issue.)

The concept of microworlds is borrowed from artificial-intelligence research. It's very difficult to simulate intelligent behavior in general, but by restricting our attention to a very small area we can begin to find elements that can be modeled. Thus, the concept of microworlds is a useful source of interesting programming projects.

The most famous AI microworld is the blocks world, in which the computer controls a robot arm that can manipulate small blocks. You can tell the computer things like "Put the red block on top of the small green block," or ask questions like "Are any green blocks under a red block?" This is a microworld of the English language (among other things) in that it must understand the vocabulary, syntax, and semantics of sentences pertaining to the moving of blocks. It is also a microworld of structural stability, in that it must understand what physical maneuvers are possible with stackable blocks. One cannot, for example, realistically pick up the bottom block in a stack of eight without dropping others. Similarly, one can place a pyramidal block on a

INVESTMENT ANALYSIS FROM CENTENNIAL

CENTENNIAL SOFTWARE / 410 17TH ST. SUITE 1375 / DENVER, CO 80202 / (303) 595-9193

STOCK-FOCUS
Find out how low is low and how high is high. Using capital structure and performance data, Stock-focus objectively calculates the underlying value of a stock. The system was first developed by the management science department of a major money center bank, and is now in use by investment advisors, trust companies and brokerage houses. On your screen, Stock-focus will plot an estimate of lowest value, highest value and the current price. You then decide what to buy, sell or hold.

REAL-FOCUS
Exhaustively analyze potential real estate investments using the Wharton School's approach to real estate analysis. In minutes you can project profit, costs, and IRR for any project over a 10 year period. Real-focus accounts for amortization, debt, income, operating expenses, taxes, depreciation, and cash flows for both after-tax holding and the results of sale. With Real-focus you can analyze any potential investment from a single building project to a complex time-phased planned unit development.

THE FOCUS TECHNIQUE
FOCUS is CENTENNIAL SOFTWARE's new approach to Program Architecture, providing a natural interaction between microcomputers and users. It provides worksheet style input screens, free access to all program segments, and the ability to combine individual results files for portfolio analysis. You also receive a usable reference manual, menu helps, a program glossary, multiple report formats and spooling. With our FOCUS technique even the most complex programs are versatile and easy to use.

COMPUTER	MEMORY-K	REAL-FOCUS	STOCK-FOCUS
IBM PC	64	\$179.00	\$189.00
Apple (plus) II	32/48	149.00	159.00
TRS-80 I	32/48	149.00	159.00
TRS-80 II	64	179.00	189.00
TRS-80 III	32/48	149.00	159.00

ALL PROGRAMS IN DISK BASIC
IBM is a trademark of IBM. Apple is a trademark of Apple Computer Corp. TRS-80 is a trademark of Tandy Corporation.

ORDER NOW! FILL IN OR CALL 800-525-2003 (Toll Free)

PROGRAM NAME _____ COMPUTER _____ MEMORY _____

NAME _____ PHONE # _____

ADDRESS _____

ACCOUNT # _____ EXP. DATE _____

"Only VR Data can offer you a Winchester Hard Disk Drive for your IBM Personal Computer..."



...with the same level of excellence and state-of-the-art technology you'd expect from IBM."

Warren Rosenkranz, President, VR Data

We are tremendously impressed with the IBM Personal Computer. When we set out to increase its capability with our exclusive,

OTHER QUALITY PRODUCTS FROM VR DATA

Winchester Hard Disks

6.3 Megabytes
9.6 Megabytes
19.0 Megabytes

2x 6.3 Megabytes
2x 9.6 Megabytes
2x 19.0 Megabytes

Memory Boards with Error Correction

64 Kbytes 192 Kbytes
128 Kbytes

In The Queue

D-Con Direct connect
internal modem
The Echo
Winchester Backup

totally compatible Winchester Hard Disk Drive and Memory Board, we dedicated ourselves to making the very finest products possible. Some very knowledgeable dealers and users say we've totally succeeded. See for yourself!!

As with our Winchester Hard Disk Drive, all our designs are tested, re-tested and "burned in." We're so sure of our quality control that we offer an unconditional 120 day extended warranty covering full costs of parts and labor on all VR Data products.

Insist on the best.
Ask for us by name.

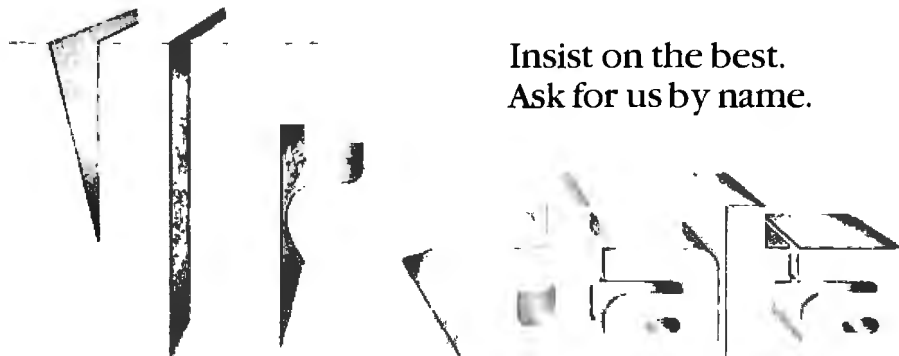

777 Henderson Boulevard N-6 Folcroft, PA 19032 800-345-8102

MICROCOMPUTER EXCELLENCE SINCE 1972

FOR TRS-80 MODEL I OR III IBM PERSONAL COMPUTER

- ★ **MORE SPEED**
10-20 times faster than interpreted BASIC.
- ★ **MORE ROOM**
Very compact compiled code plus VIRTUAL MEMORY makes your RAM act larger. Variable number of block buffers, 31-char. unique wordnames use only 4 bytes in header!
- ★ **MORE INSTRUCTIONS**
Add YOUR commands to its 79-STANDARD-plus instruction set!
Far more complete than most Forths: single & double precision, arrays, string-handling, clock, graphics, (IBM low-res. gives 16-color or 200-line display).
- ★ **MORE EASE**
Excellent full-screen Editor, structured & modular programming
Word search utility
THE NOTEPAD letter writer
Optimized for your TRS-80 or IBM with keyboard repeats, upper/lower case display driver, full ASCII.
- ★ **MORE POWER**
Forth operating system
Concurrent Interpreter AND compiler
VIRTUAL I/O for video and printer, disk and tape (10-Megabyte hard disk available)
Full 8080 or 8088 Assembler aboard
(Z80 Assembler also available for TRS-80)
Intermix 35- to 80-track disk drives
IBM can read, write and run M.3 Disks
M.3 disks can read, write and run M.1 disks

MMS FORTH

THE PROFESSIONAL FORTH SYSTEM FOR TRS-80 & IBM PC

(Thousands of systems in use)

MMSFORTH Disk System (requires 1 disk drive, 32K RAM)
V2.0 Radio Shack TRS-80 Model I or III . . . \$129.95*
V2.1 IBM Personal Computer, (80-col. screen) . . . \$249.95*

AND MMS GIVES IT PROFESSIONAL SUPPORT

Source code provided
MMSFORTH Newsletter
Many demo programs aboard
MMSFORTH User Groups
Inexpensive upgrades to latest version
Programming staff can provide advice, modifications and custom programs, to fit YOUR needs

MMSFORTH UTILITIES DISKETTE: includes FLOATING POINT MATH (BASIC ROM routines plus Complex numbers, Rectangular-Polar ~~COORDINATE~~ conversions, Degrees mode, more), (TRS-80) a full Forth-style Z80 ASSEMBLER plus a powerful CROSS-REFERENCER to list Forth words by block and line; plus all on one diskette (requires MMSFORTH V2.0, 1 drive & 32K RAM) . . . \$39.95*

FORTHCOM: communications package provides RS-232 driver, dumb terminal mode, transfer of FORTH blocks, and host mode to operate a remote TRS-80 (requires MMSFORTH V2.0, 1 drive & 32K RAM) . . . \$39.95*

THE DATAHANDLER: a very sophisticated database management system operable by non-programmers (requires MMSFORTH V2.0, 1 drive & 32K RAM) . . . \$59.95*

FORTHWRITE: fast, powerful Word Processor w/easy keystrokes, Help screens, manual & demo files. Full proportional w/abs, outdenting, include other blocks, documents & keyboard inputs—ideal for form letters (requires MMSFORTH V2.0, 2 drives & 48K RAM) . . . \$175.00*

MMSFORTH GAMES DISKETTE: real-time graphics & board games w/source code. Includes BREAKFORTH, CRASH-FORTH, CRYPTOQUOTE, FREEWAY (TRS-80), OHELLO & TICTACFORTH (requires MMSFORTH V2.0, 1 drive & 32K RAM) . . . \$39.95*

Other MMSFORTH products under development

FORTH BOOKS AVAILABLE

MMSFORTH USERS MANUAL - w/o Appendices . . . \$17.50*
STARTING FORTH - best! . . . \$15.95*
THREADED INTERPRETIVE LANGUAGES - advanced analysis of FORTH internals . . . \$18.95*
PROGRAM DESIGN & CONSTRUCTION - intro. to structured programming, good for Forth . . . \$13.95*
FORTH -79 STANDARD MANUAL - official reference to 79-STANDARD word set, etc . . . \$13.95*
FORTH SPECIAL ISSUE, BYTE Magazine (Aug. 1980) - A collector's item for Forth users and beginners . . . \$4.00*

* ORDERING INFORMATION: Software prices include manuals and require signing of a single computer license for one-person support. Describe your Hardware. Add \$2.00 S/H plus \$3.00 per MMSFORTH and \$1.00 per additional book; Mass. orders add 5% tax. Foreign orders add 20% UPS COD. VISA & MIC accepted; no unpaid purchase orders, please

Send SASE for free MMSFORTH information
Good dealers sought

Get MMSFORTH products from your
computer dealer or

**MILLER MICROCOMPUTER
SERVICES (B8)**

61 Lake Shore Road, Natick, MA 01760
(617) 653-6136

cube, but not a cube on a pointy block.

object: the naturalness with which Logo passes data messages back and forth among procedures (see **input and output**), and the ubiquity of anthropomorphic images for those procedures, makes the metaphor of object manipulation very appealing for what tends to be called data processing elsewhere. Logo has two kinds of data objects, words and lists. (Some implementations also provide arrays.) Though procedures are generally known as the active elements in a workspace, they can also be manipulated (created, edited, destroyed, or passed back and forth) by other procedures. Therefore, Logo's procedures are also frequently referred to as objects, especially when one is referring to the contents of the workspace. Finally, "object" retains all of its conventional meanings in addition to the technical sense mentioned already. Thus, we speak of procedures as manipulating objects, whether the objects are words printed on the screen or turtles doing a dance on the floor.

operation: a Logo procedure that computes a value and returns that value to the calling procedure. (It is analogous to what Pascal calls a function.) The value can be any Logo object—a number, word, or list. See also **command**.

Piaget: Jean Piaget, one of the great thinkers of our time, realized the value of looking at a wrong answer and trying to understand it (see **debugging**). He was a keen observer of children and recognized that every learner (in particular, each infant and child) takes an active role in his or her own development. For each wrong answer a child came up with (e.g., the 4-year-old stating confidently that trees make the wind blow), he asked the question: *Why that particular wrong answer? What is the logic in the child's thinking that leads to that kind of explanation?*

In this sense, he saw these wrong answers not as random movements in the absence of the right answer, but

as the result of bugs in a program that does give mostly the right answer. The frequent focus of attention on Piaget's stages is a bit of a red herring. Although he has described these stages discretely, it is their contents—the form that thinking takes at various developmental levels, the *logic* of it—and not the stages themselves, or the age at which they appear, that are the real importance of Piaget's theory.

Evidence of the influence of Piagetian thinking (if not each of Piaget's specific notions about thinking) pervades the Logo culture. Our interest in debugging, the metaphor of objects, and the assimilation of computer technical ideas into familiar contexts (e.g., anthropomorphization or playing turtle) all reflect that influence.

playing turtle: pretending to be the turtle and walking through a turtle-graphics procedure as the turtle might see it. This process can make fairly difficult geometric constructions transparent to young children with little or no formal training in geometry. Playing turtle, though, refers as much to the thinking through of a procedure before programming it as to walking through an existing procedure.

By way of example, some 10-year-olds were trying to figure out how to teach the turtle to make a circle. I suggested they play turtle. They concluded that if all they could tell the turtle was to go FORWARD and to turn, it would have to go just a little bit forward, turn a little, go a little bit forward again, turn a little again, and so on. After one kid had made it around the circle (one of the instructions was "keep doing that until you get back to the beginning"), they were convinced they had the right idea. To help them with the details, I reminded them of the Total Turtle Trip Theorem and again encouraged them to play turtle. They began to reason out the details of how much to turn, how many times to repeat the process, and how big they wanted to make each step.

powerful ideas: Seymour Papert com-

INTRODUCING THE:



SPECIAL INTRODUCTORY OFFER!

WITH CP/M™ OPERATING SYSTEM \$2,695

A Briefcase Size Computer with Full Size Abilities!

Standard Features

- 4 MHZ Z80 PROCESSOR
- 64K LOW POWER RAM
- 1.2 MBYTE ON DUAL 8" FLOPPIES
- COMPACT SIZE: 5½" X 19" X 19"
- LIGHT WEIGHT - ONLY 30 LBS
- 4 RS-232 SERIAL PORTS
- ENVIRONMENTAL PACKAGING
- SWITCHING POWER SUPPLY



This Is Not a Personal Computer!

THE EXEC-JR IS A TRUE BUSINESS COMPUTER WITH CAPABILITIES TO HANDLE THE TOUGH JOBS.

SERIAL PORTS CAN BE USED FOR TERMINALS, PRINTERS OR MODEMS.

Expansion Options

- 192K BYTE RAM MEMORY
- MULTI-USER
- DUAL SIDED DRIVES (2.4 MBYTE)
- FIXED DISK INTERFACE WITH 11, 35, OR 70 MBYTE FIXED DISK
- MP/M™

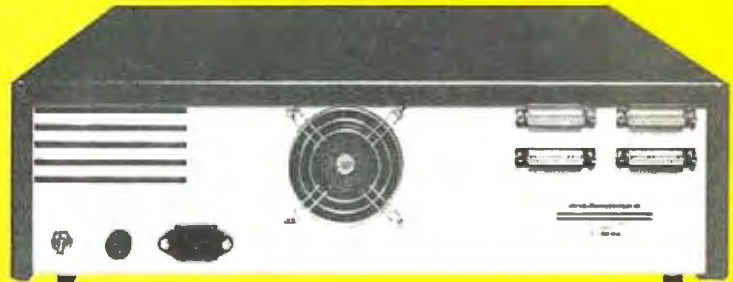

Affordable Expansion

2.4 MBYTE
ON DUAL SIDED DRIVES
ONLY \$375

64K RAM Expansion
FOR A TOTAL OF 128K BYTE
ONLY \$149

128K RAM Expansion
FOR A TOTAL OF 192K BYTE
ONLY \$298

As a closing thought consider this . . .

Who else offers a small computer with:

192K BYTE RAM, 2.4 MBYTE on Floppies; 4 Serial Terminal Interfaces, Multi-User Capability and CP/M™ Operating System for \$3,368.

CUSTOM COMPUTER SYSTEMS INC.
AN INNOVATIVE LEADER IN PROCESSING SYSTEMS

Presented By

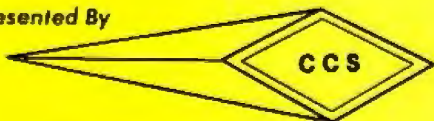

PRICE AND AVAILABILITY SUBJECT TO CHANGE WITHOUT NOTICE.
REPRESENTATIVE INQUIRIES WELCOME.
MP/M AND CP/M ARE TRADEMARKS OF DIGITAL RESEARCH, INC.

7250 COMMERCE CIRCLE EAST • FRIDLEY, MINNESOTA 55432 • PHONE (612) 574-9493

**Chances are,
you've already purchased
two-thirds of our digital,
programmable
oscilloscope.**



Apple II, Apple II Plus, Disk II and Silentype are trademarks of Apple Computers, Inc. Epson MX-80 is a trademark of Epson America, Inc.

Now for \$995 you can have the rest.

In a word, the Model 85 aScope™ is a dual channel, DC to 50 MHz, fully programmable, digital memory oscilloscope designed to operate with any Apple II™ or Apple II Plus™ equipped with Disk II™ and display, 48K memory and DOS 3.3.

But don't let aScope's remarkably low price deceive you. Because in about 80 percent of all design or test applications where this sort of instrument would be used, aScope will perform on par with systems in the \$15,000+ category. (Something we feel comfortable saying, having spent a number of years working in research and development for one of the world's leading suppliers of those \$15,000 instruments.)

Still, we recognize it's a somewhat extraordinary promise.



system. But frankly, we suspect you are probably as intrigued as you could be on the basis of one advertisement.

So we'll proceed with a few action recommendations designed to accommodate anyone from the casually curious to the virtually convinced.

First, you should call 800-547-4445. That will provide you with an aScope data sheet and an opportunity to determine whether you'd like to invest \$10 in our comprehensive aScope demonstration disk.

Or simply yield to your initial impulse and order the system, safe in the knowledge that (a) you may use the system for fifteen days, and if not satisfied, return it, and b) NWIS system engineers stand ready to assist you with any questions you may

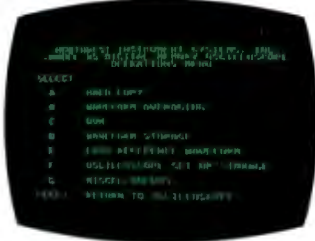

Single key operations menu. All sub-menus provide complete prompting.

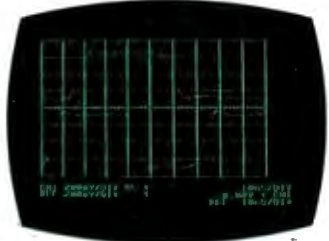

Interchange waveform modes from disk into Channel 2 for comparison with active signal on Channel 1.



Cross-cursor indicates point where aScope™ digital-voltmeter (DVM) is calculating waveform voltage for display at bottom of screen.

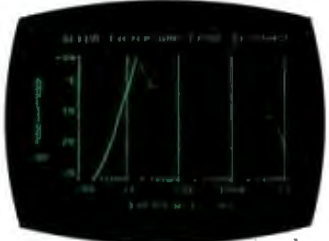

example co-resident program; this case designed to plot an amplitude response curve for an active filter.

So, perhaps before telling you what aScope can do, we ought to tell you how it does it so inexpensively.

Essentially what we've done is depart radically from the existing instrumentation architecture upon which all currently available digital programmable oscilloscope systems are dependent. It simply doesn't make sense to combine a stand-alone

Bandwidth: DC to > 50 MHz equivalent time digitizing (-3dB) DC to > 10 KHz resolvable with real-time digitizing (-3dB)
Resolution: 8 bits (1 part in 256)
Range: 10ns/division to 20s/division
Sensitivity: 5mV/division to 5V/division
Input Impedance: 1MΩ and 20pF

programmable oscilloscope with a controller when to a great extent the micro-computer circuitry and capabilities of one are already available in the other. So we didn't combine, we integrated. Making the aScope a peripheral part of the computer. Supplying only what was necessary to make the computer a high-performance instrument. An instrument capable of things until now assumed impossible for

anywhere near its price.

Things like what, you wonder?

Well naturally, since aScope is fully programmable you may configure a setup, define the analysis of the acquired data you desire and produce an end result display in whatever form is most productive. Many frequently performed routines are already part of aScope's software. However, because no two engineers' needs are exactly the same, the system's architecture was designed to accommodate considerable user modification via co-resident BASIC or assembly language programs.

In addition, aScope will average waveforms. Store a waveform on disk in binary or text form. Store instrument control settings for future automated setup. Or load and display reference waveforms.

aScope is also equipped to deliver waveform voltage readings utilizing a cursor-controlled digital voltmeter. And to generate hard copies via an Epson MX-80™ or Silentype™ printer.

Space permitting, we could go on about the menu-driven commands and other user-sensitive features we've built into this

have regarding aScope capabilities and applications.

The \$995 Model 85 aScope. We admit the performance it delivers for the money is so remarkable, it may initially strike you as unbelievable. However, when you recall all the breakthrough products this industry has seen over the last decade, sounding unbelievable at first is practically a tradition.



NORTHWEST INSTRUMENT SYSTEMS, INC.



P.O. Box 1309
 Beaverton, Oregon
 97075

compares the Total Turtle Trip Theorem to "its Euclidean counterpart: (at least in the context of Logo computers), the Total Turtle Trip Theorem is more powerful: The child can actually use it. Second, it is more general: It applies to squares and curves as well as to triangles. Third, it is more intelligible: Its proof is easy to grasp. And it is more personal: You can 'walk it through,' and it is a model for the general habit of relating mathematics to personal knowledge." (See Papert, page 76.) An idea that can be used in a variety of personally meaningful contexts, that can be thought through, and that is a model for clear thinking is certainly powerful. Other powerful ideas are state, recursion, and subproceduralization.

primitives: the built-in procedures of Logo. Since Logo encourages programmers to build their own procedures as chunks of larger projects, it is useful to have a term to refer to the indivisible chunks that Logo provides initially.

problem solving: a skill that is at the core of Logo's "curriculum." Most traditional math instruction is about already-solved problems; the student memorizes someone else's techniques. Only recently have people understood that real mathematicians do something very different; they don't just study old problems, they solve new ones. Professor George Polya at Stanford University has been a pioneer in studying the techniques that good mathematicians bring to bear on new problems. Many ideas that are part of the Logo programming style parallel Polya's mathematical ideas. Most important, the use of procedures as building blocks for more complex procedures (as opposed to writing one huge program without a layered structure) parallels Polya's strategy of dividing a large problem into smaller pieces.

procedures: the conceptual building blocks of Logo programs. Logo users start with a vocabulary of primitive (built-in) procedures, and use them to

teach Logo new vocabulary that can then be used in all the ways that primitives are used.

program: the Logo use of "program" is much more like the television use of it than of the usual computer use. A program is the whole show and may consist of a host of songs and dances, skits, acts, and routines. (But the word "routine" is not routinely used by Logophiles to mean a part of a computer program.) A person writes procedures. The top-level procedure runs a program that may be quite simple or may involve the use of several subprocedures. If it makes use of subprocedures, this top-level procedure may be referred to as a super-procedure.

programming: consider the following metaphors for programming: teaching turtle a new word; communicating with the turtle; translating from English to French or Logo; or being fluent enough in a language to express oneself easily.

prosthetic: one metaphor for the computer. As an artificial arm may help an amputee manipulate objects, so may an artificial piano player help one manipulate music. Because it is a versatile tool it can provide access to a large variety of inaccessible spaces and activities. The computer's use in musical composition and performance, graphics production (e.g., the special effects in a slew of recent television advertisements and in movies like *Star Wars*), and other areas are all extensions of human abilities—but extensions without which we are severely disabled in areas we now take for granted. It is merely a sociological and technological artifact that we regard as handicapped people who lack certain other abilities we take for granted. (For more on computers as aids to communication and autonomy for special education or rehabilitation, see *Special Technology for Special Children*.)

QWERTY phenomenon: Papert uses this term to refer to traditions that dig

BYTEWRITER

DAISY WHEEL PRINTER

LETTER QUALITY PRINTER AND TYPEWRITER IN ONE PACKAGE

The BYTEWRITER is a new Olivetti Praxis 30 electronic typewriter with a micro-processor controlled driver added internally.



\$795
plus shipping

Dealer
Inquiries
Invited

FEATURES

- Underlining • 10, 12, or 15 characters per inch switch selectable • 2nd keyboard with foreign grammar symbols switch selectable • Changeable type daisy wheel
- Centronics-compatible parallel input operates with TRS-80, Apple, Osborne, IBM and others • Cartridge ribbon • Typewriter operation with nothing to disconnect
- Service from any Olivetti dealer • Self test program built in.

BYTEWRITER

125 NORTHVIEW RD., ITHACA, N.Y. 14850
(607) 272-1132

Praxis 30 is a trademark of Olivetti Corp.
TRS-80 is a trademark of Tandy Corp.
BYTEWRITER is a trademark of Williams Laboratories.

POPULAR COMPUTING is making computing more popular . . . and simple . . . and enjoyable! Month after month after month.

Here it is! A magazine that provides the computer news, how-to's, and feature articles necessary for you to keep abreast of how computers do, and will, affect your work and your play. Best of all, it's delivered in plain language, without technical razzmatazz and jargon.

POPULAR COMPUTING is so exciting, so important, so informative, that everyone will fully understand what's really happening. Every issue is enriched with dollar-saving product reviews, special news briefs, and feature articles by famous contributors (like Isaac Asimov).

POPULAR COMPUTING is a magazine that must be read to be truly relished. That's why we've mounted a . . .

SPECIAL INTRODUCTORY OFFER

that enables you to try POPULAR COMPUTING at **NO RISK** whatsoever.

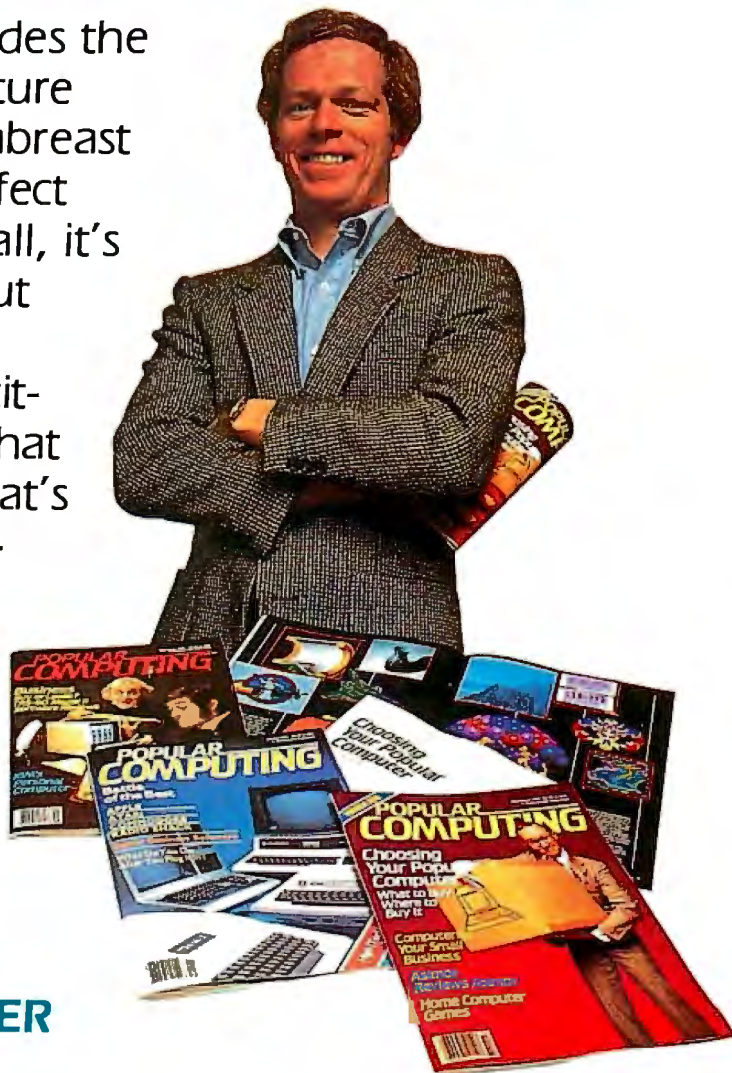

POPULAR COMPUTING

P.O. Box 307
Martinsville, NJ
08836



SUPER SAVINGS FOR ME...I'm enclosing my check or credit card number to take advantage of this super introductory offer of 12 issues for only \$11.97 saving me \$3.03 on the basic rate of \$15.00—and saving me \$18.03 off the newsstand rate of \$30.00. If my 30-day review of your first issue doesn't 100% please me, I may cancel my subscription and you will promptly refund ALL my money or give me a FULL credit on my charge card marked below:

Mail Today to: **POPULAR COMPUTING** P.O. Box 307 Martinsville, NJ 08836

Bill me at \$12.97 Check Enclosed for \$11.97 7B82

Charge \$11.97 to: Visa Mastercard

Card No. _____

Signature _____ Expires _____

(Please Print) _____

Address _____

City _____ State _____ Zip _____

Please allow six to eight weeks for processing

themselves in after their original purpose, presumably a good one, has become obsolete. The name derives from the six top left-hand letters on a standard typewriter keyboard. This arrangement of keys was chosen to slow down a typist so that the early manual typewriters would not readily jam. Attempts to convert to a more optimal arrangement of keys have routinely failed as people were used to doing things the old way. So, too, much of the curriculum survives primarily because it is familiar and not because it makes much current sense.

recursion: a recursive definition defines a procedure or function in terms of itself. For example, a recursive definition of "factorial" states that $0! = 1$ and that $n! = n * (n-1)!$ (See recursion.) A Logo program based on this definition might look like this:

```
TO FACTORIAL :N
IF :N = 0 OUTPUT 1
OUTPUT :N * FACTORIAL (:N - 1)
```

A nonrecursive definition might say something like:

$$n! = n * (n-1) * (n-2) * (n-3) * \dots * 3 * 2 * 1.$$

(Compare the structures by writing the latter in BASIC.) Both definitions and programs work, of course, but which definition one chooses affects how one programs. In the case of "factorial," both definitions are easy to implement, but sometimes recursion is the only way. For more on recursion, see the section of Brian Harvey's article on page 166 in this issue of BYTE.

sentence: in Logo, a sentence is a list of words. Logo provides tools to manipulate the words of a sentence. In most programming languages, one uses character strings instead of sentences; an English sentence becomes simply a bunch of symbols, some of which are letters and some of which are spaces. But those computer languages don't help the programmer divide this uniform character string

into words. Logo's approach is an example of the microworld influence in programming.

sprite: animation of graphics has long been a high priority in Logo implementations, but only recently have small computers gained the power to handle animations well (except, of course, for animations written efficiently in assembly language). Sprites may be thought of as screen objects with a defined appearance (color, shape, size, etc.) and a velocity. Both of these can be changed according to the wishes of the programmer. They "live" on different layers of the screen, as if they are on plastic overlays. Thus, a sprite defined as a picture of an elephant may roam through a forest of trees, passing behind some and in front of others. The Logo programmer does not have to attend to the hiding of lines when one sprite is partially occluded by another—that is handled automatically. In this way, complex animations involving three-dimensional interactions of several screen objects can be as simple as drawing the objects and instructing each on how it should move.

state: the relevant properties of something. For example, the state of the turtle includes its position and the direction in which it's pointing, but doesn't include any of its past history (such as the distance it has traveled). The criterion of relevance here is that the turtle's future behavior, in response to some Logo program, depends only on its current state and not on its past. (Of course, the turtle's state does reflect where it has been, but tells only part of the history and not all of it.) The isolation of only the important aspects of a situation is a valuable debugging tool.

subprocedures: Logo encourages students to deal with large problems by dividing them into subprocedures. In a "long, featureless set of instructions it is hard to see and trap a bug. By working with small parts, however, bugs can be confined and more easily trapped, figured out." (See Papert,

Investigate Robotics



built with the same operating technology as large industrial robots

\$2400

complete with 32" high robotic arm • power pack • controller card • cables • manual • tool kit

- Use with any RS-232C computer port or modem
 - Rigid 1/4" open aluminum construction
 - Six powerful DC Servo gear motors
 - Digital ohoppers on all axes
 - Controller card with Intel® 8748 CPU
 - Built-in self test program
 - Reach: 22.5" maximum
 - Grasp: 2"
 - Lift: 16 oz. at extension
- "Hands-on-Introduction to ROBOTICS, The Manual for XR-1" may be purchased separately @ \$20.00 ea. p.p.

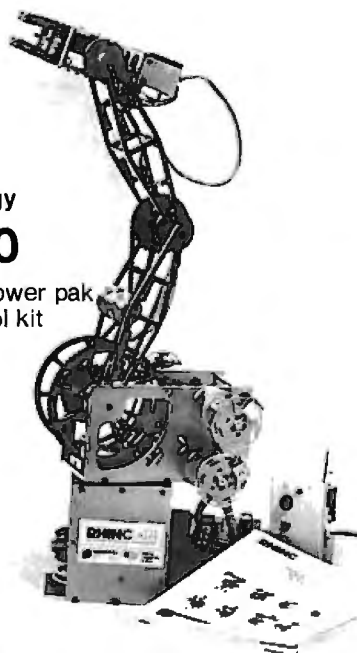

Immediate delivery. Shipped F.O.B. Champaign, IL (IL residents please add 5% sales tax) Price & specifications may be altered without notice. Dealer/Rep. inquiries invited.



Sandhu Machine Design, Inc., Dept. B-1
308 S. State, Champaign, IL 61820
217/352-8485

IBM COMPATIBLE BOARDS

BY **ZOBEX**

256 K MEMORY WITH PARITY
Limited time only! **\$598** ~~\$998~~

HARD DISC SUBSYSTEM FOR
IBM AND S-100 \$2495

HA62 IBM BUS HARD DISK INTERFACE FOR WD-1000
4SP 4 SERIAL PORTS FOR IBM
PB PROTOTYPING BOARD FOR IBM
EB EXTENDER BOARD FOR IBM

S-100 BOARDS

ZOBEX CPU
Z-80A CPU WITH 4 SERIAL AND 3 PARALLEL PORTS

ZOBEX DDFDC
DOUBLE DENSITY DISK CONTROLLER

ZMS-100
64K RAM

HDCI
S-100 HARD DISK INTERFACE FOR WD-1000

ZOBEX

7343 J. RONSON RD.
SAN DIEGO, CA. 92111

(714) 571-6971

ZOBEX is trademark of ZOBEX CORPORATION
IBM is trademark of International Business Machines Corporation

MODEM \$129⁹⁵

No other acoustic modem gives you all these features at this low price.

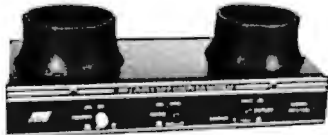

The MFJ-1232 Acoustic Modem gives you a combination of features, quality and performance that others can't match at this price.

0-300 Baud, Bell 103 compatible. Originate/Answer. Half/full duplex. RS-232, TTL, CMOS level compatible. Use any computer. Cassette tape recorder ports save data for reloading or retransmission. 6 pole active filter handles weak signals. Carrier detect LED indicates adequate signal strength for data recognition. Quality "muffs" gives good acoustic coupling, isolates external noise for reliable data transfer. Crystal controlled. "ON" LED. Aluminum cabinet. 110 VAC or 9 volt batteries. 9x1 1/2x4 in.

Apple II, II Plus: software and cable for modem, MFJ-1231, \$39.95. Plugs into game port. No serial board needed.

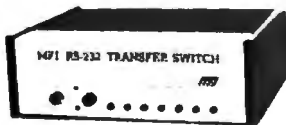

It's like having an extra port

\$79⁹⁵

MFJ-1240 RS-232 TRANSFER SWITCH. Switches computer between 2 peripherals (printer, terminal, modem, etc.). Like having extra port. Push button switches 10 lines (pins 2,3,4,5,6,8,11,15,17,20). Change plug or cable to substitute other lines. Push button reverses transmit-receive lines. LEDs monitor pins 2,3,4,5,6,8,20. PC board eliminates wiring, crosstalk, line interference. 3 RS-232 25 pin connectors. 7x2x6 in.

\$99⁹⁵ MFJ-1108 AC POWER CENTER. Adds convenience, prevents data loss, head bounce, equipment damage. Relay latches power off during power transients. Multi-filters isolate equipment, eliminate interaction, noise, hash. Varistors suppress spikes. 3 isolated, switched socket pairs. One unswitched for clock, etc. Lighted power, reset switch. Pop-out fuse. 3 wire, 6 ft. cord. 15A, 125V, 1875 watts. Aluminum case. Black. 18x2 3/4x2 in. **MFJ-1107, \$79.95.** Like 1108 less relay. 8 sockets, 2 unswitched. Other models available, write for free specification sheet.

Order from MFJ and try it. If not delighted, return within 30 days for refund (less shipping). One year unconditional guarantee. Order yours today. Call toll free 800-647-1800. Charge VISA, MC. Or mail check, money order. Add \$4.00 each for shipping and handling.

CALL TOLL FREE ... 800-647-1800

Call 601-323-5869 in MS, outside continental USA

MFJ ENTERPRISES, INCORPORATED

921 Louisville Road, Starkville, MS 39759

page 102.) Logo's subprocedures are more than what one sees in carefully subroutinized BASIC. They become extensions to the language and can have meaningful names (see powerful ideas). For more on the distinction between subroutines and subprocedures, see the section of Brian Harvey's article on page 163 in this issue of BYTE.

teaching: what a person does to a computer. See learning.

Total Turtle Trip Theorem: when a turtle wanders over a path and ends up heading in the same direction as when it started, its total turning is an integer multiple of 360 degrees. Some special cases follow. If it wanders over a simple closed curve (a closed path that does not cross itself, like a polygon, a circle, or the outline of a pond), it turns through exactly 360 degrees. To figure out how much to turn at each point of a five-pointed star, play turtle (remember to end up heading the same way you started). How many full rotations do you make while walking over the star shape? (Two.) Therefore, you have turned 2*360 degrees in all. How much at each corner? (A fifth of that.) Repeating [FORWARD 100 LEFT 200] enough times makes another kind of star. How many points does it have? What about the star made by turning 80 degrees at each corner? See also turtle geometry.

turtle: (1) a computer-controlled robot that has position and heading, each of which can be changed independently of the other. It is significant that these two components of the turtle's state are independent. Cars and trucks (and their remote-control toy versions) do not have independent control of heading and motion. Their inability to make sharp corners (no matter how good the turning radius) limits their usefulness in artistic and mathematical realms. Also, because the interaction complicates thinking about their behavior, it is difficult to write programs to control them in any realms; (2) a graphic representation (typically, a pointy isosceles triangle) of such a physical

robot; (3) a creature that lots of people love even though the beast rarely does anything in anyone's presence.

turtle geometry: a genuinely new mathematics based on turtle movements. It emphasizes transformations in local space rather than relationships to a fixed global referent. See local, Total Turtle Trip Theorem, and playing turtle in this glossary. For more about the mathematics at a college or advanced high school level, see Abelson and diSessa's book.

turtle graphics: the graphics you know and love—the graphics command system that has crept into several other computer languages (I've seen it in some Pascal implementations and even a version of BASIC) originated with Logo. See FORWARD, Logo, and turtle.

word: the simplest form in which Logo stores data, a word is an unbroken string of characters (typically alphanumeric, but capable of being constructed to contain any characters including spaces or control characters, when that is desired). Words can be concatenated into larger words, dissected into parts, and used as elements of lists. Numbers, single characters, and character strings are all treated as words by Logo.

workspace: a Logo workspace may be thought of quite concretely as if it were a kitchen, basement, or art-studio workspace: a place where one can set out one's materials and begin to work. The Logo workspace contains all the procedures and data objects the programmer is currently using, which can be saved in whole or in part on files for use at a later date. Retrieving the contents of a file places its contents into the workspace, as does defining a new procedure or data object. Pictures or text that are on the screen are not part of the computer's internal workspace any more than pictures drawn by a robot turtle on the floor are part of that workspace. (Nevertheless, many implementations of Logo make it possible to save screen graphics on a file and retrieve that file to the screen.)■

PRESENTING: THE NO NONSENSE BOARDS.

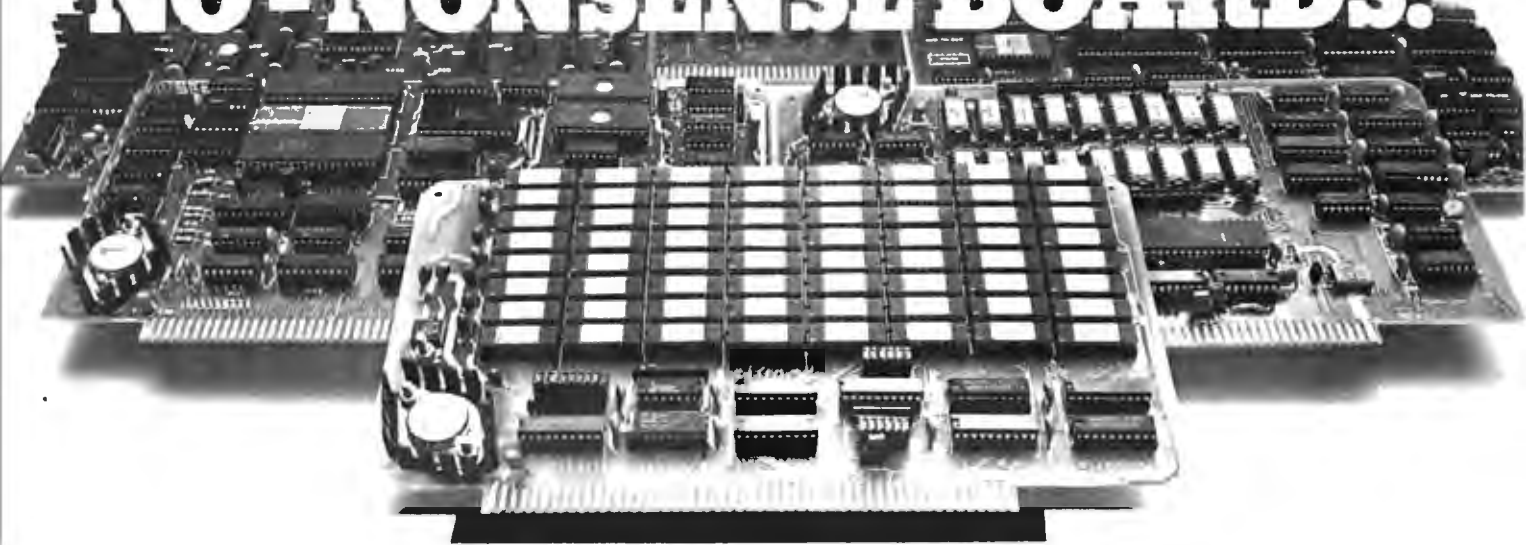

The RAM67

Our RAM67 static RAM offers low power for cool operation and high reliability. It is the first S100 memory of its size to offer battery back up. The RAM67 will run without wait-states with any present S100 bus CPU.

Advanced static RAM67 features:

- Low power CMOS RAM
- 100 ns access time
- No wait states with our 10 MHz

Lightning One™

- 8/16 bit operation
- Phantom disable
- Battery back up option

If you need high performance and high reliability at an affordable price, the RAM67 is the memory for you.

128K RAM \$1495.00
Battery back-up option \$100.00

The Lightning One

The *Lightning One* is the fastest S100 CPU board presently available. The 8086 processor with its two co-processors, the 8087 and 8089, provide exceptional data manipulation, numeric processing and I/O handling capability.

The Lightning One features:

- 8086 or 8088 16 bit processor
- 4,5,8, or 10 MHz jumper selectable operation
- Optional 8087 and 8089 co-processors
- Onboard monitor with diagnostics
- 9 vectored interrupts expandable to 65

When you need mini-computer performance at micro-computer prices, the *Lightning One* should be your choice. Benchmarks available. Prices start at \$395.00

Other LDP Products

In addition to the RAM67 and *Lightning One*, Lomas Data Products offers the following fine products:

HAZITALL System Support

2 serial ports, 2 parallel ports, clock/calendar, 9511 or 9512 math support (option), hard disk controller host interface A & T, \$325.00

LDP72 Floppy Disk Controller

Single or double density operation, single or double sided disks, controls both 8" and 5 1/4" floppy drives, digital data separator for adjustment free reliable operation A & T, \$274.95



For 16 bit computing on the S100 bus,
come to the leader...



LOMAS DATA PRODUCTS, INC.

729 Farm Road, Marlboro, Massachusetts 01752 ☐ Telephone: 617-481-2822

LDP128/256K Dynamic RAM

An advanced dynamic RAM with static like performance. An ideal choice for large memory configurations where cost is an important consideration. No DMA, or reset restrictions A & T, 128K \$795.00, 256K \$1395.00

LDP88 8088 CPU Board

Ideal for inexpensive systems requiring the processing power of a 16 bit instruction set. The LDP88 has up to 8K of on-board EPROM, 1K bytes of RAM, 1 serial RS232 port, 9 vectored interrupts, 5 MHz operation. Useable as a single board 8088 processor A & T, \$349.95

Software Available

CP/M-86*

Full track buffered BIOS, memory disk support, double density format \$300.00

MP/M-86*

Full MP/M-86 implementation, hard disk and floppy disk support, plus memory drive. 1, 2 and 5 user configurations.

MS-DOS**

The IBM Personal Computer operating system, includes macro assembler \$250.00

Other software:

BASIC86, BASCOM86, FORTRAN86, C, FORTH.

*CP/M-86 & MP/M-86 trademark of Digital Research.

**MS-DOS trademark of Microsoft.

Lightning One trademark of Lomas Data Products, Inc.

Dealer and O.E.M. inquiries invited.

Logo for the Apple II, the TI-99/4A, and the TRS-80 Color Computer

Each version of Logo suits a particular audience.

Gregg Williams
Senior Editor

Of all the languages we have covered in our annual August language issues, Logo is the only one you could probably find in computer stores along with the corresponding issue of BYTE. Versions of APL, Pascal, LISP, and FORTH have become available in the time since those language issues were published (we're still waiting for Smalltalk), but Logo

is available *now*. Better still, the versions of Logo available now are probably better implementations than were their counterparts when *they* came out.

In this article I will compare four versions of Logo: *TI Logo* for the Texas Instruments TI-99/4 and TI-99/4A and *Apple Logo*, *Krell Logo*, and *Terrapin Logo*, all for the Apple

II and Apple II Plus computers. A fifth version of Logo, *Color Logo* from Radio Shack for the TRS-80 Color Computer, was released just as I finished writing this article. It is reviewed separately in the text box on page 247. For the sake of convenience throughout this article, TI-99/4A will also refer to the TI-99/4, and Apple II will refer to both that and the Apple II Plus. And because Terrapin and Krell Logos are basically the same implementation, I will usually refer to them both at the same time as Terrapin/Krell. I will review the products in alphabetical order.

Common Features

I won't presume to write any kind of tutorial on elementary Logo programming (for that, see the other Logo articles in this issue), but I thought I'd start this review by looking at some of the features common to Apple, Terrapin/Krell, and TI Logo.

The cornerstone of Logo is the concept of the *turtle*. The turtle is a triangular object on the video display that can be given simple commands (like FORWARD 50, PENUP, RIGHT 90). Since it carries a "pen" that can draw lines when in PENDOWN mode, commands given to the turtle result in line drawings on the video display.

At a Glance

Name

Apple Logo

Type

Programming language

Distributor

Apple Computer Inc.
20525 Mariani Ave.
Cupertino, CA 95014
(408) 996-1010

Manufacturer

Logo Computer Systems Inc.
222 Brunswick Blvd.
Pointe Claire, Quebec
Canada H9R 1A6
(514) 694-2885

Price

\$175

Authors

Jim Davis, Gary Drescher, Ed Hardebeck,
Stephen Hain, Tom Polucci, Brian Silverman,
and other members of the LCSI staff

Format

5¼-inch floppy disk

Language Used

6502 machine language

Computer Needed

Apple II or Apple II Plus with a 16K-byte
memory card

Software Included

Two Logo disks (copy protected)

Documentation

Apple Logo: An Introduction to Program-
ming through Turtle Graphics, 153 pages;
Apple Logo: Reference Manual, 186 pages

Audience

Anyone interested in Logo

Give your system some NEC, and watch its performance soar.

NEC's crisp, clear, high-performance JC1202 RGB color monitor, an industry standard. Also available: the JC1201 composite video version.

NEC's classic green monitor, (JB1201), one of computing's performance legends. Non-glare screen, easy on the eye. And the checkbook.



The impressive new NEC dot matrix printer. Parallel interface, 100 cps, 2K buffer, pin or friction feed. Stunning performance and versatility in the hottest new peripheral of the year.

Peripherals from NEC can make almost any computer system better.

Owners of Apple®, Radio Shack®, Atari®, IBM®, and many other personal computers will find their equipment to be compatible with NEC's famous monitors, as well as our highly-featured new PC-8023A dot matrix printer. (Some configurations may require a different interface.)

Ask your dealer for a demonstration.

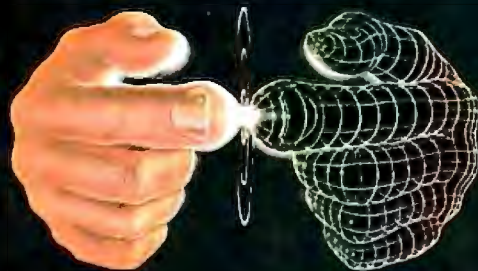

**Productivity
at your fingertips**

NEC

**NEC Home Electronics (USA)
Personal Computer Division**

1401 Estes Avenue
Elk Grove Village, IL 60007

How to make work like a

First, neatly cut out the "370" label.

Now, when nobody's looking, nonchalantly tape it to your terminal, just under the "IBM," as if it really belonged there.

Then wait for your chance and quickly slip a dBASE II™ disk into your main drive.

That's it.

Your IBM Personal Computer is now ready to run a relational database system, the kind that IBM put on their mainframes last year.

And you're ready with more data handling power than you would have dreamed possible before dBASE II.

You'll wonder how you managed without it.

You'll find that dBASE II, because it's a relational database management system (DBMS), starts where file handling programs leave off.

dBASE II handles multiple databases and simplifies everything from accounting to department staffing to monitoring rainfall on the Upper Volta.

With a word or two, you CREATE databases, APPEND new data instantly, UPDATE, MODIFY and REPLACE fields, records and entire databases. Organize months worth of data in minutes with the built-in REPORT. Do sub-field and multi-field searches, then DISPLAY some or all of the data for any condition you want to apply.

And you've just begun to tap the power of dBASE II.

Easy to look at, easy to use.

Input screens and output forms couldn't be easier—just "paint" your format on the CRT and what you see is what you'll get.



You can do automatic calculations on fields, records and databases, accurate to 10 digits.

And you can use dBASE II interactively for answers right now. Or save your instructions, then repeat **everything** with two words: DO Manhours, DO ProjectX, DO whatever has to be done.

Use dBASE II to help make your choice:

If you've got a 96k IBM PC, send us \$700 and we'll send you a copy of dBASE II to use free for 30 days.

e your micro mainframe.



Instead of just poring over a manual, run it and make sure that it does what you need done.

Then if you find it isn't right for you, send it back and we'll return your money, no questions asked.

But if you do that, you'll have to remove that label. Because nothing short of a mainframe works like dBASE II.

Call (213) 204-5570 today or drop by your local computer store for the rest of the story.

Ashton-Tate, 9929 Jefferson Blvd., Culver City, CA 90230.

Ashton-Tate

©1982 Ashton-Tate
CP/M is a registered trademark of Digital Research

Apple Logo and the P6A Problem

In an unusual combination of circumstances, Apple Logo may not work on your Apple. Here's why, and here's what you can do about it.

When the Apple Language System with Apple Pascal was first introduced, everyone had to replace the P5 and P6 ROMs (read-only memory chips) on their Apple disk-controller cards with the new P5A and P6A ROMs (this is what allows the Apple disk to store information in the denser 16-sector format). There was actually a bug in the P6A ROM so small that no software ran incorrectly because of it. Apple started supplying the corrected P6A and didn't worry about the few people who had the older P6A ROM. This was a reasonable thing to do since the change didn't make any difference, right?

Wrong. Some two years later, the company that did the copy-protection scheme for Apple Logo found that the protected Logo disk wouldn't boot on some Apples. It eventually discovered that the bug in the older P6A ROM was the culprit.

When Apple Computer Inc. was told, it decided to solve the problem by instructing all its authorized dealers to give, free of charge, a P6A ROM to anyone who can prove he has an Apple disk drive. (The easiest way to prove that is to take the disk-controller card in to the dealer.) Dealers will be reimbursed by Apple, so they should be glad to give you the P6A ROM even if you didn't buy your computer there. If you have any trouble doing this, contact Apple Computer Inc. at (408) 996-1010.

drawings. Both can draw in the six Apple II colors (black, white, green, violet, orange, and blue) and in a "color" called "reverse," which reverses the part of the high-resolution screen it passes over according to a fixed set of rules known to most Apple users. The Apple Logo turtle can also be given an erasing pen that draws in the color of the video-display background. Because the Apple II maintains separate text and graphics screens, you can switch between the two at any time with control keys that display text only, split text and graphics, and graphics only (the keys used are different for the two Apple Logos, but they perform the same function). An example of a program that uses turtle graphics is given in listing 1; the drawing it produces is shown in photo 1.

The TI turtle is, in contrast, rather limited in that its implementation restricts the amount of drawing it can do before it "runs out of ink." The TI-99/4A does not have a graphics mode

(Terrapin Inc. also sells an actual robot turtle that can be controlled from the Apple II and Terrapin Logo—it's a two-wheeled object about half the size of a basketball,

and it can draw on large sheets of paper placed under it.)

Terrapin/Krell and Apple Logo use the Apple high-resolution graphics screen to display the turtle and its

NEW! Lowest Prices Anywhere . . .

SMITH

CORONA

—TP1



\$639.

**LETTER QUALITY
ELECTRONIC TEXT PRINTER**

An advanced microprocessor controlled daisy wheel printer — Fully formed letter quality printing — Speed—120 words per minute — Simple — Reliable — User "friendly" operator controls — Available with parallel or serial data interface — 10 or 12 characters per inch — Six fonts for each pitch — Handles single sheets or continuous forms up to 5 parts — Tractor optional — Noise level — 63 dB or better — 117 VAC or 240 VAC — 50/60 Hz.

**We'll
beat
any
price!**

IBM PC INTERNAL

**FLOPPY
DRIVES**



\$249.

**ONE SIDED 160-K
SOFTWARE
COMPATIBLE WITH
IBM PC-DOS**

Also Available 2 sided 320-K . . . \$329.00. Tested, assembled, burned-in and re-tested before shipping. Ask about our external drives.

To Order, Write . . . or Call Toll Free: 800-523-1449. in PA (215) 644-6341

Terms of sale: bank wire transfer, certified or cashier's check, or money order. Please include telephone number with order. PA residents add 6% sales tax. Advertised price is for pre-paid orders. FOB shipping point. Price subject to change without notice. Manufacturer's warranty only.

SPECTRA MARKETING

600 Swedesford Rd. Berwyn, PA 19312

CMC SuperSystems™

SuperFive,™ SuperTen™ and now Super20™

CMC International introduced the first microcomputer offering the speed and capacity of Winchester hard disk technology in an affordable, attractive desktop unit. First was the SuperFive a 6.4 megabyte hard disk with a floppy drive for loading programs or for backing up data from the hard disk. Then came the SuperTen with a 12.8 megabyte hard disk, and an add-on hard disk subsystem, the Targa.

Now CMC has introduced the incredible Super20, featuring 19 megabytes of hard disk storage in a 5 1/4" hard disk. It's offered at a list price of \$7695, the best price/performance ratio in the industry.

And now the SuperFive and SuperTen are even more affordable, with a suggested list price of only \$5995 for the SuperFive and \$6995 for the SuperTen. Microsoft Basic 80 is included.

CMC's SuperFive, SuperTen and Super20 support wide applications under their standard CP/M operating system with unexcelled system utilities.



First of all, we make it extremely reliable with extensive testing and by using the most reliable storage technology and components available.

Next, we offer it in different capacities, like 6.4, 12.8 and 19 megabytes, with a choice of 350 or 700 Kb floppy backup.

Then, we offer options including 220v, 50hz for international markets.

CMC then offers a module swap program in the unlikely event you'd ever need it to get back up and running — rapidly. And third party maintenance service nationwide, soon available in Canada.

Finally, CMC offers its SuperSystems with two RS232C ports, 64k RAM, two Z-80 processors operating at 4 MHz, a screen format of 25 lines x 80 characters, full ASCII keyboard and numeric keypad and cursor controls, graphics capability, reverse video, lower case descenders, and a battery-operated real time clock. Floppy disk versions also available.

There's a variety of compatible software including Basic compiler, Fortran, Cobol, Pascal and PL/1 80. Applications software, too, like dBasell, Accounting Plus, Wordstar and other Micropro products.

As an integrated system, CMC's SuperSystems provide both data processing and word processing capa-

bilities to meet the needs of a small business or a large corporation. Our systems are already part of Fortune 500 companies, and small businesses, too, speeding up information processing.

CMC's SuperSystems communicate with other systems, too, with optional software.

CMC didn't stop there.

CMC INTERNATIONAL

A Division of Computer Marketing Corporation

11058 Main • Suite 220 • Bellevue, WA 98004 • Phone (206) 453-9777 • Telex: 152556 SEATAC

Call Toll-Free 1-800-426-2963

For information or to buy your SuperSystem, see your local CMC dealer today or contact:

Compu Data
1 Bala Cynwyd Plaza
Bala Cynwyd, PA 19004
(215) 667-6843
Circle 78 on Inquiry card.

Diversified Data
8043 W. 82nd
Indianapolis, IN 46278
(317) 253-5878

Input SRL
Chile 1830
1227 Buenos Aires, Argentina
Telex: 9191 FINCO

Featherbed (Pty.) Ltd.
415 Commissioner St.
1st Floor
Johannesburg, S.A.
618-4728
Telex: 80310 S.A.

Dialog Computer Treuhan
Seeburgstrasse 18
6002 Luzern
Switzerland
Telex: 72227 DCL

Software Control
2101 N. Aurelius Rd.
Holt, MI 48842
(517) 694-4142

Big sale on K's!

16K... \$149.95

32K... \$199.95

48K... \$249.95

64K... \$299.95

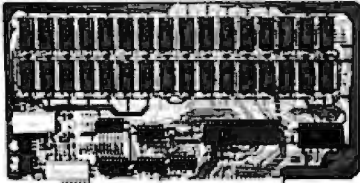

New JAWS-IB

The Ultrabyte Memory Board

Due to the tremendous success of our JAWS I, we were able to make a special purchase of first-quality components at below-cost prices for JAWS-IB. And we are sharing our cost saving with you. But don't be surprised if the next time you see this ad the prices have gone up substantially. Better yet, order now, and get the best memory on the market at the best price on the market.

ONE CHIP DOES IT ALL

Jaws-IB is the Rolls-Royce of all the \$100 dynamic boards. Its heart is Intel's single chip 64K dynamic RAM controller. Eliminates high-current logic parts... delay lines... massive heat sinks... unreliable trick circuits. JAWS-IB solves all these problems.

LOOK WHAT JAWS-IB OFFERS YOU

Hidden refresh... fast performance... low power consumption... latched data outputs... 200 NS 4116 RAM's... on-board crystal... RAM Jumper selectable on 8K boundaries... fully socketed... solder mask on both sides of board... phantom line... designed for 8080, 8085, and Z80 bus signals... works in Explorer, Sol, Horizon, as well as all other well-designed \$100 computers.

10-DAY MONEY-BACK TRIAL: Try a fully wired and tested board for 10 days — then either keep it, return it for kit, or simply return it in working condition.

Continental U.S.A. Credit Card Buyers Outside Connecticut:
TO ORDER CALL TOLL FREE 800-243-7428
 From Connecticut Or For Assistance:
 (203) 354-9375

Please send the items checked below:

JAWS-IB kit:

- 16K..... \$149.95*
- 32K..... \$199.95*
- 48K..... \$249.95*
- 64K..... \$299.95*

JAWS-IB Fully Assembled, wired & Tested:

- 16K..... \$179.95*
- 32K..... \$239.95*
- 48K..... \$299.95*
- 64K..... \$359.95*

EXPANSION KIT, 16K RAM Module, to expand JAWS-IB in 16K blocks up to 64K. \$59.95

*All prices plus \$2 postage and insurance (\$4.00 Canada). Connecticut residents add sales tax.

Total enclosed: \$ _____

- Personal Check Money Order or Cashier's Check
- VISA Master Card (Bank No.)

Acct. No. _____ Exp. Date _____

Signature _____

Print Name _____

Address _____

State _____ Zip _____

NETRONICS R&D Ltd.
 333 Litchfield Road, New Milford, CT 06776

Listing 1: A set of Logo procedures using turtle graphics. The main procedure, called 4.BUGS, traces a figure from recreational mathematics: four bugs that, starting in the corners of a square, move in the direction of the bug clockwise to them (as illustrated on our cover). This version is in Apple Logo. The resulting drawing is shown in photo 1.

```

TO MOVEBUG :N
; []
; [THIS MOVES BUG IN TOWARD THE NEXT BUG CLOCKWISE]
; [FROM BUG N. IT ALSO DRAWS A LINE FROM]
; [THE BUG'S STARTING CORNER TO ITS CURRENT]
; [POSITION TO ADD COLOR TO THE DRAWING]
; []
(LCAL "BUG.N "BUG.M "CORNER.N)
MAKE "BUG.N (WORD "BUG :N)
SETPC :N + 1
; []
; [PUT TURTLE TO CURRENT BUG POSITION]
PENUP
SETPOS LIST (GPROP :BUG.N "XVAL) (GPROP :BUG.N "YVAL)
PENDOWN
; []
; [POINT TURTLE TOWARD NEXT BUG'S PRESENT POSITION]
MAKE "M (:N + 1)
IF :M > 4 [MAKE "M 1]
MAKE "BUG.M (WORD "BUG :M)
SETHEADING TOWARDS LIST (GPROP :BUG.M "XVAL) (GPROP :BUG.M "YVAL)
; []
; [MOVE TURTLE AND RECORD NEW POSITION AS]
; [BELONGING TO BUG N]
FORWARD :LEN ; [LEN IS A GLOBAL VARIABLE]
PPROP :BUG.N "XVAL XCOR
PPROP :BUG.N "YVAL YCOR
; []
; [MOVE TURTLE TO STARTING CORNER, DRAWING LINE]
MAKE "CORNER.N (WORD "CORNER :N)
SETPOS LIST (GPROP :CORNER.N "XVAL) (GPROP :CORNER.N "YVAL)
END

TO BIGSQ :SZ
; []
; [THIS DRAWS A SQUARE OF LENGTH :SZ WITH THE]
; [CURRENT TURTLE POSITION AS CENTER. AT THE]
; [END, THE TURTLE'S POSITION IS UNCHANGED,]
; [BUT THE PEN IS DOWN]
; []
PENUP
HALFSQ :SZ / 2
PENDOWN
REPEAT 4 [FORWARD :SZ RIGHT 90]
PENUP
HALFSQ :SZ / 2
PENDOWN
; []
END

TO HALFSQ :SZ
; []
; [THIS DRAWS TWO SIDES OF A SQUARE -- THE PEN]
; [MAY BE UP OR DOWN]
; []
REPEAT 2 [FORWARD :SZ RIGHT 90]
; []
END
  
```

Listing 1 continued on page 238

Software Breakthrough...

NEW QUIKPRO + PLUS WRITES PROGRAMS FOR YOU IN MINUTES ON YOUR Micro

Technical Review
by Wayne Hepburn

QUIKPRO + PLUS is a new breakthrough in software for microcomputers from ICR-FutureSoft.

Until now, whenever you wanted a new separate program in BASIC (Microsoft Basic/MBasic/Basic 80/Oasis Basic), you had to spend a lot of dollars for it, or a lot of hours creating it (if you have the know-how). That's all in the past now.

Anybody who can turn on a computer can write a program, quickly, with this new **Quikpro + Plus** software which generates programs for you. **Quikpro + Plus** is the invention of Joseph Tamargo of Florida. His brilliant approach to program writing allows you to tap the real power and speed of your microcomputer, and it is about time this happened.

I interviewed him to find out more about **Quikpro + Plus** and pass this valuable information to you. He told me "The best part of this software is that it gives you a separate custom program every time you use it. The resulting program is produced, error-free, in BASIC (Microsoft Basic/MBasic/Basic 80/Oasis Basic, as appropriate to your system) for you by **Quikpro + Plus**. What's more, you can list your new program, look at it, see what makes it tick, and modify it as you wish."

You can also, customize, enhance, alter, and even copy the programs you create with **Quikpro + Plus**. This is because programs created by **Quikpro + Plus** are structured, easy to follow, and include many REMARKS statements right in the program listing. I don't know of any other software with the flexibility and ease of use I found in **Quikpro + Plus**.

HUNDREDS OF APPLICATIONS...

For Education, Business, Hobby, Home, Science, Personal, etc. a partial list includes programs like these: Financial Forecasting, Expense Planning, Data Access and Retrieval, Modeling, Record Keeping of all kinds, Statistical Data Banks, and much, much more. **Quikpro + Plus** cuts the time it takes to generate a new custom program down to a few minutes. That's true. I saw a

letter from a user who created a separate program in Basic within fifteen minutes after reading the clear, simple, complete Documentation & Operating Manual for **Quikpro + Plus**. The software will generate File Handling and Data Entry Programs in a file format, drawn right on the screen by user. Programs created by **Quikpro + Plus** produce standard ASCII Data Files allowing data to be easily accessed by other programs, other micro's, and even main frames.

HOW IT WORKS...

The operation of **Quikpro + Plus** is simple and easy. On your screen you answer questions which appear in plain English. The answers generate error-free Filing & Data Entry Programs for you...instantly. This completely eliminates the tedious and time consuming development you normally go through to write a program. Since the instructions are right on the screen you don't need any programming skills to operate **Quikpro + Plus**. Quickly, you get a fully independent new program ready to run on your system. After you create the new program you can remove **Quikpro + Plus** and stick it on the shelf until the next time you create a custom program.

PRINTS REPORTS & MANUALS...

There is a full report printing capability put into your new separate program by **Quikpro + Plus**. You can even print out in formats different from the File Format you used without altering the Record Data. Or you can selectively print portions of Files or selected fields from selected Records. Just about anything you want can be reported out from the Data Base associated with the new custom program you wrote.

PERFORMS CALCULATIONS...

You can perform all manner of computations among various fields in each record. You can selectively calculate and print resulting data only, or Data Base and results, or alter Records by calculation results, and so forth. The possibilities seem unlimited. And keep in mind that the power and features I am talking about end up in the separate new custom program **Quikpro + Plus** writes for you.

This software is ready to ship immediately

and you can start writing programs the day you get in. In fact, ICR-FutureSoft guarantees your satisfaction or you can return it for a full refund in ten days after delivery. How's that for confidence? Mr. Tamargo said "There isn't any risk to us...our product works like it's supposed to work and users are very well satisfied. We are glad to guarantee satisfaction."

You get **Quikpro + Plus** by mail or phone directly from ICR-FutureSoft. Just write them, or call their Toll-Free phones and specify your model and version requirements from the list that follows:

For CP/M with Microsoft Basic \$259
(same as MBASIC/Basic 80)

APPLE • INTERTEC • NORTH STAR • OSBORNE • XEROX 820 • HEATH/ZENITH • CROMEMCO • ALTOS • RADIO SHACK TRS80 • or any system reading CP/M 8" Single or Double Density.

For MS/DOS Operating System \$259
IBM/PC • WANG

For TRS/DOS Operating System
Radio Shack TRS80 Mod I, III \$149
Radio Shack TRS80 Mod II, 16 \$189

For ATARI Microsoft Basic \$189

For OASIS Operating System \$349
ALTOS • COMPUCORP • CROMEMCO • DELTA PROD • DIGITAL GROUP • DIGITAL MICROSYSTEMS • DYNABYTE • GODBOUT • IBC INDEX • INTERSYSTEMS • NORTH STAR • ONYX • SD SYSTEMS • TRS80 II • VECTOR GRAPHIC • VORIMEX

Send check or money order (Florida residents add 5% tax) to ICR-FutureSoft, Box 1446-BG, Orange Park, FL 32073 or if you have Visa or Mastercard, Call **Free** 24 hours daily, seven days a week...

1-800-824-7888 ask for Operator #722
California 1-800-852-7777 Operator #722
Hawaii/Alaska 1-800-824-7919 Op #722

Operators cannot give technical help, accept orders only. Technical support call 1-904-269-1918.

Software Dealers can handle this software. Contact ICR-FutureSoft Customer Service at 1-904-269-1918 or write.

We Have It!
..at the best prices

DISK SPECIAL
MEMOREX 3401 5 1/4"
SINGLE SIDED, SINGLE DENSITY
 1 Box 10 Boxes
\$22.95 \$20.95

We have a complete inventory including soft sectored, hard sectored and special formats. Even if your part number is not listed, **WE STOCK IT IF THEY MAKE IT.**

Call for quantity pricing

— MAXELL —

MD1] 5 1/4" SINGLE SIDED \$32.95
 MH1] SINGLE OR DBL. DENSITY

MD2] 5 1/4" DOUBLE SIDED \$48.95
 MH2] SINGLE OR DBL. DENSITY

MD1 DD-5 1/4"SS, QUAD DENSITY \$44.95
 MD2 DD-5 1/4"DS, QUAD DENSITY \$54.95

FD1] 8" SINGLE SIDED \$43.95
 FH1] SINGLE OR DBL. DENSITY

FD2] 8" DOUBLE SIDED \$56.95
 FH2] SINGLE OR DBL. DENSITY

— MEMOREX —

3481] 5 1/4" SINGLE SIDED
 3483] SINGLE OR DBL. DENSITY \$28.95
 3485] w/HUBRING

3491] 5 1/4" DOUBLE SIDED
 3493] SINGLE OR DBL. DENSITY \$36.95
 w/HUBRING

3504] 5 1/4"SS, QUAD DENSITY \$37.95
 3501] 5 1/4"DS, QUAD DENSITY \$51.95

3062] 8" SINGLE SIDED \$26.95
 3015] SINGLE DENSITY

3090 -8" SNG. SIDE, DBL. DENSITY \$35.95
 3104 -8" DBL. SIDE, DBL. DENSITY \$41.95

— SCOTCH —

744] 5 1/4" SINGLE SIDED,
 SNG. DENS. w/HUBRING \$28.95

744D] 5 1/4" SINGLE SIDED,
 DBL. DENS. w/HUBRING \$33.95

745] 5 1/4" DOUBLE SIDED,
 DBL. DENS. w/HUBRING \$40.95

740-8" SNG. SIDE, SNG. DENSITY \$29.95

741-8" SNG. SIDE, DBL. DENSITY \$37.95

743-8" DBL. SIDE, DBL. DENSITY \$47.95

HEAD CLEANING KITS, 5 1/4" OR 8" . . . \$22.95

Minimum shipping charge-\$3.00 Shipped UPS. All offers subject to withdrawal without notice. advertised prices reflect a 2% cash discount (orders prepaid prior to shipment). C.O.D.'s and credit card orders are 2% higher

Mini Micro Mart, Inc.
 BOX 3002F Syracuse, N.Y. 13220
 315-422-2056
 TWX 710-541-0431
 WRITE FOR FREE CATALOG

Listing 1 continued:

```
TO ADDPROPS :N :LIST
; []
; [THIS SETS UP THE WORDS BUG1 THROUGH BUG4]
; [AND CORNER1 THROUGH CORNER4 WITH TWO]
; [PROPERTIES EACH -- XVAL AND YVAL]
; []
```

```
LOCAL "NAME1
LOCAL "NAME2
MAKE "NAME1 WORD "BUG :N
MAKE "NAME2 WORD "CORNER :N
PPROP :NAME1 "XVAL FIRST :LIST
PPROP :NAME2 "XVAL FIRST :LIST
PPROP :NAME1 "YVAL LAST :LIST
PPROP :NAME2 "YVAL LAST :LIST
; []
END
```

```
TO; :N
END
```

```
TO SETPROPS
; []
; [FILL PROPERTY LISTS OF BUG1 - BUG4, CORNER1 - CORNER4]
ADDPROPS 1 LIST (- 1 *:BIGUNIT) :BIGUNIT
ADDPROPS 2 LIST :BIGUNIT :BIGUNIT
ADDPROPS 3 LIST :BIGUNIT (- 1 *:BIGUNIT)
ADDPROPS 4 LIST (- 1 *:BIGUNIT) (- 1 *:BIGUNIT)
; []
END
```

```
TO 4.BUGS :LEN :TIMES
; []
; [THIS DRAWS THE CLASSIC SPIRAL CREATED BY]
; [THE MOTION OF 4 BUGS, EACH STARTING AT ONE CORNER]
; [OF A SQUARE AND FOLLOWING THE BUG CLOCKWISE]
; [TO IT]
; []
FULLSCREEN
HIDETURTLE
MAKE "BIGUNIT 100
BIGSQ (2 *:BIGUNIT)
; []
SETPROPS
REPEAT :TIMES [MOVEBUG 1 MOVEBUG 2 MOVEBUG 3 MOVEBUG 4]
END
```

of video display, but it does have re-definable characters called *tiles* (more on them later). The lines drawn by the turtle are actually redefined tiles. Because only 192 of the 256 tiles are available for redefinition (64 store the TI-99/4A character set) and there are far more than 192 characters on the graphics part of the video display, a design can easily cover more tiles than are available. The limitation of the TI turtle is offset by the availability of colorful *sprites* on the TI-99/4A computer. All three Logos have a full complement of turtle commands; see reference list on page 280 for details.

Another traditional feature of Logo

is a set of list-manipulating words. Although most of the publicity about Logo emphasizes its graphics and its suitability for education, Logo is also a fairly powerful list-manipulation language with distinct similarities to LISP (the granddaddy of artificial-intelligence languages). As an example, listing 2 shows a set of Logo procedures that sorts a list of words. Apple Logo and Terrapin/Krell Logo are roughly equal in their list-processing abilities, but TI Logo has some definite deficiencies; these will be discussed in a later section.

All five Logos also have some number-processing capabilities. TI Logo

IT'S TIME KIDS STARTED USING STRONG LANGUAGE.



It does all this interactively. For instance, if you accidentally type "foreword," instead of forward, Apple Logo responds with "I don't know how to foreword."

There is no such thing as a mistake with Apple Logo, only logical statements telling you what needs to be done to make the program work. So the student programs the computer. Not the computer the student.

And as you learn, Apple Logo learns with you. So whether you're a student of 5 or 55, you'll always be challenged — but not overwhelmed.

Apple Logo runs on the Apple II with 64K. And it comes from Apple, the leading personal computer company in education — with the largest library of courseware at all levels.

Apple Logo. It can make getting to know a computer the most positive of learning experiences.

Your kids will swear by it.

The personal computer.



We encourage it.

Because now the most powerful educational language is available on the Apple Personal Computer.

Presenting Apple Logo.

It's not just a programming language for computers, but a learning language for people.

Enough so that anyone, working with Apple Logo, can easily learn the programming principles once reserved for college courses.

Apple Logo encourages you to break problems into small steps, and then shows you how to make those steps automatic.

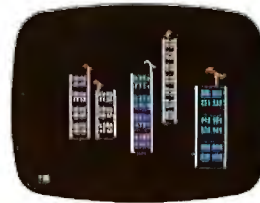

For more information, call (800) 538-9696. In California, call (800) 662-9238. Or write: Apple Computer Inc., 20525 Mariani Avenue, Cupertino, CA 95014. Apple® Logo is a product of Logo Computer Systems, Inc., 222 Brunswick Boulevard, Point-Claire, Quebec, Canada H9R1A6.

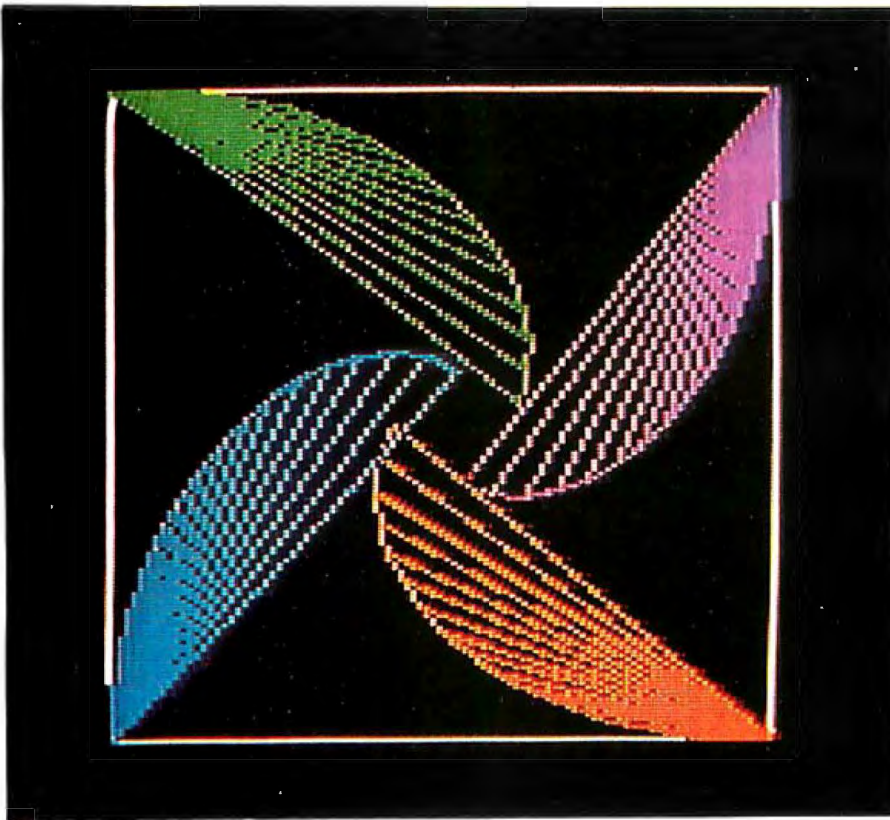

Photo 1: A drawing made using turtle graphics and an Apple II computer. The procedure, called 4.BUGS, is given in listing 1. Each curved line is the actual path of the bug; the straight lines to the corner were drawn to add color to the photo.

and Radio Shack Color Logo are limited to integers between $-32,768$ and $32,767$, while Apple Logo and Terrapin/Krell Logo use both integers and floating-point numbers. The Apple-based Logos are as useful for arithmetic computation as any BASIC. In addition to the four basic

TI Logo and Radio Shack Color Logo are both limited to integer arithmetic, while Apple Logo and Terrapin/Krell Logo use floating-point arithmetic.

arithmetic operators, the Apple-based versions offer the sine, cosine, and arctangent functions, rounding and truncating (to integer) functions, and a square root function.

All five Logos have editors that allow Logo procedures to be created and edited. The Apple Logo and Terrapin/Krell Logo editors are very similar, although I like the Terrapin/Krell version a little more because of a slightly more convenient arrangement of function keys. Apple Logo gives you a simple line-at-a-time, no-editing way to type in procedures; this is probably intended for young children who might get confused by the power of the regular editor. (Terrapin/Krell Logo offers a similar procedure on its Utility Disk.) The TI and Radio Shack versions have less sophisticated editors. All the editors except the Radio Shack one work in a way that is somewhat annoying to experienced users. For example, you are always in a kind of insert mode—when you type characters, they are inserted at the cursor location and all other characters on that line are moved to the right. You must use a specific keystroke to delete a character or a line. In any case, the editors in each Logo are easy to learn and are not, in themselves, worthy of more discussion here.

(One additional editing feature of the Apple-based Logos is the ability to reproduce the last line typed in when not in the editor. The line ap-

At a Glance

Name

Krell Logo

Type

Programming language

Manufacturer

Krell Software Corporation
1320 Stony Brook Rd.
Stony Brook, NY 11790
(516) 751-5139

Price

\$149.95

Authors

Leigh Klotz Jr., Patrick Sobalvarro, and Stephen Hain

Format

5¼-inch floppy disk

Language Used

6502 machine language

Computer Needed

Apple II or Apple II Plus with 16K-byte memory card (will not work on Apple III)

Software Included

Two copies of MIT Logo (copy protected), Utilities Disk (with utilities from MIT and Krell), Alice in Logoland disk

Documentation

Logo for the Apple II: Technical Manual, by Harold Abelson and Leigh Klotz Jr., 57 pages; poster-sized summary sheet for Krell Logo; Logo for the Apple II, by Harold Abelson, 228 pages; Alice in Logoland Primer*; 1-year (5-issue) subscription to The Logo and Educational Computing Journal*; Teacher's Manual*

Audience

Anyone interested in Logo

* refers to materials stated as part of the package but not seen by the reviewer; Krell says it will send all missing materials to earlier purchasers of Krell Logo.

STARBYTE

THE LITTLE BIG ONE

...SMALL ON SIZE BIG ON STORAGE



- ★ A powerful processing board with expandable disk storage capability.
- ★ Special design features enhance its operation under CP/M™†
- ★ Ready to out perform many computers twice its size.

Starbyte offers power, versatility, and speed at a size and price you can afford. Starbyte utilizes the Zilog Z80A microprocessor family, 128K of RAM, and a Western Digital Floppy Disk Controller, all combined on a single board. To further bolster its power, Starbyte incorporates the Western Digital "smart" Hard Disk Controller allowing for more than 10 megabytes of storage.

Features of All Systems:

- Extensive CBIOS
- 4 megahertz Z80A (no wait states)
- 128K RAM
- 2 serial ports
- 1 Centronics parallel port
- CP/M™ compatible
- Track buffer for rapid floppy disk access
- 5¼" double-sided, double-density, double-track density, floppy disk drives
- 5¼" 6 or 12 megabyte hard disk drive

† TM of Digital Research

Individual System Features:

- Starbyte SBC I:** Includes one 96TPI 5¼" floppy and a 6.4 meg hard disk and controllers.
- Starbyte SBC II:** Includes one 5¼" 96TPI floppy and one 12.8 meg 5¼" hard disk with controllers.
- Starbyte SBC III:** Includes two 96TPI slimline floppies and one 6.4 meg 5¼" hard disk with controllers.
- Starbyte SBC IV:** Includes two 96TPI slimline floppies and one 12.8 meg 5¼" hard disk with controllers.

asap
computer
products, inc.

1198 E. Willow St.
Signal Hill, CA 90806
(800) 421-7701
(213) 595-6431 (714) 891-2663

ASAP COMPUTER PRODUCTS LTD.
116 Viceroy Road, D-12 Concord, Ontario
L4K1A9 Canada (416) 738-0500 (800) 268-1996



Listing 2: A set of Logo procedures that will sort a list of words. This version is written in Terrapin/Krell Logo and is used as a benchmark. The empty brackets on several lines were placed there automatically by the Terrapin/Krell Logo editor. Due to space limitations, the slightly different versions that run on the Apple and TI-99/4 will not be given here.

```

TO STR.GR.THAN :FIRST :SECOND
; []
; (READ THIS NAME AS "STRING-GREATER-THAN")
; []
; THIS RETURNS A TRUE OR FALSE VALUE DEPENDING
; ON WHICH OF TWO WORDS, :FIRST OR :SECOND
; ALPHABETICALLY PRECEDES THE OTHER
; []
IF :FIRST = :SECOND OUTPUT "FALSE
IF :FIRST = " OUTPUT "FALSE
IF :SECOND = " OUTPUT "TRUE
MAKE "CHAR1 FIRST :FIRST
MAKE "CHAR2 FIRST :SECOND
IF ASCII:CHAR1 > ASCII :CHAR2 OUTPUT "TRUE
IF ASCII:CHAR1 < ASCII :CHAR2 OUTPUT "FALSE
OUTPUT STR.GR.THAN BUTFIRST :FIRST BUTFIRST :SECOND
END

TO INSERT :WORD :LIST
; []
; THIS INSERTS :WORD ALPHABETICALLY INTO
; AN ALREADY SORTED :LIST; THIS RETURNS
; A NEW LIST THAT CONTAINS ALL OF :WORD
; AND :LIST, NEITHER OF WHICH IS CHANGED.
; []
IF NOT STR.GR.THAN :WORD FIRST :LIST THEN OUTPUT FPUT :WORD :LIST
IF STR.GR.THAN :WORD LAST :LIST THEN OUTPUT LPUT :WORD :LIST
OUTPUT FPUT FIRST :LIST INSERT :WORD BUTFIRST :LIST
END

TO SORT :LIST
; []
; THIS RETURNS A SORTED LIST THAT HAS THE
; SAME CONTENTS AS THE UNSORTED :LIST
; []
IF :LIST = [] OUTPUT []
TEST BUTFIRST :LIST = []
IF TRUE OUTPUT :LIST
IF FALSE OUTPUT INSERT FIRST :LIST SORT BUTFIRST :LIST
END

```

appears on the screen and can then be modified with a handful of keys that are used for editing outside the Logo editor. This is very useful when the same thing or slightly different versions of it need to be executed repeatedly.)

One feature common to all the Logo implementations covered here has to do with Logo source code. Although Logo is supposed to make using the computer as easy as possible, none of the implementations discussed here allows Logo procedures to be typed in (or printed out) with the indentations and statement

groupings that make a structured language more readable. For example, a REPEAT statement with several statements in the body of the repeat loop must put all the statements on one line. They cannot be placed one statement per line (as can be done in Pascal, for example) because these implementations use a carriage return to denote the end of a completed Logo command. This is an unfortunate fact we will have to live with for now; perhaps later versions of Logo will remedy the situation.

Two final notes concern the Apple-based versions of Logo. Because the

language uses the 16K-byte memory card (the Apple Language Card or its equivalent), neither Apple Logo nor Terrapin/Krell Logo will run on an Apple III under Apple II emulation mode. In addition, Apple Logo may not load on a few Apple IIs. See the text box Apple Logo and the P6A Problem on page 234 for more details.

Apple Logo

Apple Logo's greatest strength is its advanced programming commands. *Package-related commands* allow you to group together selected procedures and variables and manipulate them by a given name; among other things, the package of items can be saved, erased, or hidden from view (or *buried*) in Logo. For example:

```
PACKAGE "PKG1 [PROC1 PROC2
          PROC3]
```

defines the package PKG1 to be the three procedures named above. You can then save just these items to a disk file named GWPKG1 with:

```
SAVE "GWPKG1 "PKG1
```

You can erase all the above items from the workspace with:

```
ERALL "PKG1
```

In addition, you can hide them from view with:

```
BURY "PKG1
```

After they are buried, the procedures are available for use, but they do not show up in any list of the workspace contents and they cannot be erased accidentally. The availability of packages makes workspace manipulation much easier (especially when you want to save, delete, or otherwise manipulate only part of the workspace), and the BURY feature allows you to customize the Logo workspace for a particular application and "lock" those features into Logo where they cannot be seen or altered by the nontechnical user.

(Another Apple Logo feature, the STARTUP file, allows you to create a

Text continued on page 250

COMPUTER WAREHOUSE

CALL TOLL FREE 1-800-528-1054

INTERNATIONAL DEALER INQUIRIES INVITED

ATARI

Special 32K 800 System
800 w/32K. recorder, PacMan
OR star raiders, joysticks . **Call**
Above w/48K **Call**

800 (16K) **\$670**
400 **Call**
810 Disk Drive **\$440**
825 Printer **\$590**
850 Interface **\$170**
410 Recorder **\$ 75**
830 Modem **\$155**

16K Memory **\$60**
32K Memory **\$90**
80 Column Board **Call**

DISK DRIVES

Lobo
Apple 1st Drive **\$400**
Apple 2nd Drive **\$350**

Percom
Atari D/D Drives. **Call**

PRINTERS

C. Itoh
F-10 — Parallel **Call**
F-10 — Serial **Call**
55CPS — Series **Call**
Prowriter **Call**
Tractors for star writer **\$147**

Comrex
CR-1-S **Call**
CR-1-P **Call**
CR-1-Q **Call**

Datasouth
DS 180 **\$1260**

Diablo
630 RO w/Tractors **\$2260**
630 RO wo/Tractors **\$2050**
630KSR wo/Tractors **\$2435**

Epson
MX-80 **Call**
MX-80 F/T **Call**
MX-100 **Call**

Integral Data Systems
Prism 80 **Call**
Prism 132 **Call**

NEC
PC-8023A **Call**
3510 **\$1680**
7710 **Call**
7720 **Call**

Okidata
Microline 80 **\$305**
Microline 82-A **\$400**
Microline 83-A **\$650**
Microline 84 **Call**

Tally
1805/1802 **\$1555**
1605/1602 **\$1325**

Texas Instruments
810 Basic **Call**

MONITORS

Zenith
12" Green Screen **\$115**

Amdek
Video 100 **Call**
Video 300 **Call**
Color I **Call**
Color II **Call**
Color III **Call**

Comrex
13" RGB Color **\$460**

FREE SHIPPING
on
all U.P.S. shipments

SPECIAL WORD PROCESSING SYSTEM

Televideo 802, NEC 3510 w/Tractors,
WordStar, CalcStar **\$4900**

VIDEO TERMINALS

Adds
Viewpoint **\$499**

Altos
Altos I **Call**

Soroc
IQ 120 **Call**
IQ 130 **Call**
IQ 135 **Call**
IQ 140 **Call**

Televideo
910 C **\$570**
912 C **\$675**
920 C **\$735**
925 C **\$730**
950 C **\$915**

Zenith
Z-19 **\$680**

DISKETTS

Elephant
5 1/4" 0. Sector (100) **\$215**

Maxell
5 1/4" 0. or 10. Sector
(100) **\$250**

SOFTWARE

WordStar **\$295**
Mailmerge **\$100**
SpellStar **\$160**
DataStar **\$240**
CalcStar **\$220**

COMPUTERS

Altos
ACS 8000-15 **\$3850**
ACS 8000-2
w/CPM* **\$2650**
Series 15D **Call**
Series 5-5D **Call**

California Computer
Systems **Call**
Dynabyte **Call**
NEC **Call**

Northstar
Advantage **Call**
Horizon II 64K QD **\$2625**

Sanyo **Call**

Televideo Systems
TS-802 **Call**
TS-802H **Call**

Zenith
Z-90 64K w/CPM* **\$2385**

MODEMS

Novation
CAT **\$140**
D-CAT **\$155**
Apple Cat II **\$349**
Auto Cat **\$235**

MOUNTAIN HARDWARE

All products. **Call**



2222 E. Indian School Rd. • Phoenix, Arizona 85016
Order Line: 1-800-528-1054

Other Information: 602-954-6109



Store Hours: Mon.-Fri. 10-5 MST Saturday 9-1 MST

Prices reflect 3% cash discount. Product shipped in factory cartons with manufacturers warranty.

Personal checks & All Credit Union checks will delay shipping two weeks
Prices & availability subject to change without notice

New from Quality Computer Services

BIG BLUE SuperCharges

your IBM Personal Computer
with over 35% more power and throughput
than a standard 4MHz Z80 system!

ALL FOR
ONLY
\$595.00

Here's what BIG BLUE includes:

- Dual Access I/O
- Allows for Dual Processing
- Serial port and parallel port
- Ability to run existing CP/M-80 programs
- Z80B microprocessor running at 5.5 MHz
- 64K memory
- Hard disk interface
- Calendar clock

BIG BLUE gives your IBM PC more memory capacity and expandability

Plug in BIG BLUE and get a computer-within-a-computer

BIG BLUE, an auxiliary processor PC board for your IBM Personal Computer, lets you run thousands of programs written for the CP/M operating systems.

CP/M has been around since 1975, and contains some of the most sophisticated, proven programs ever written.

The immense library includes time managers, spreadsheet manipulators, and office packages. Languages contained are BASIC, ALGOL, FORTRAN, C, PASCAL, COBOL, PILOT, and many others.

Edit and format text.
Check spelling and indexes. Discover the ease of word processing.

Enjoy games such as Chess, Adventure, and Star Trek.

Let your imagination run wild!
Put **BIG BLUE** to the test.

AVAILABLE SOON! UNIVERSAL DISK CONTROLLER

- For 5¼" and 8" FLOPPY DISKS
- Single Density/Double Density
 - Single Side/Double Side

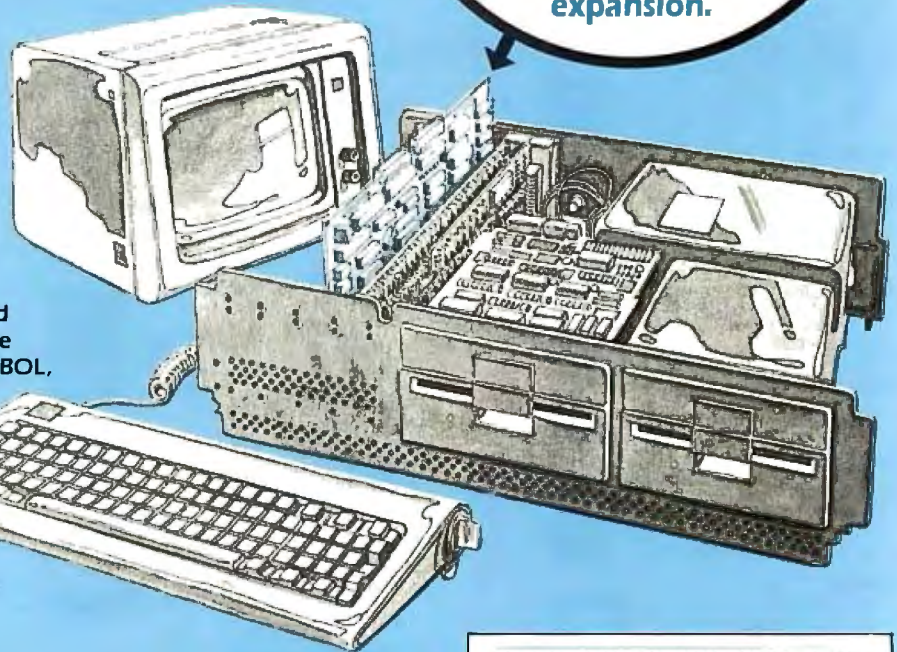

The
all-on-one board
all in one slot

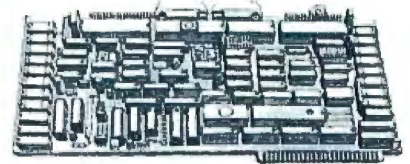

still leaves you
room for
expansion.

Quantity discounts
available. Dealer and OEM
inquiries invited.

WARRANTY

One full year on all parts
and workmanship.

BIG BLUE is a registered trademark of Q.C.S.
IBM is a registered trademark of IBM Corp.
Z80 is a registered trademark of Zilog, Inc.
CP/M is a registered trademark of Digital Research.

QCS
Quality Computer Services
INC

Quality Computer Services
178 Main Street
Metuchen, New Jersey 08840
201/548-2135

Circle 344 on Inquiry card.

Quality Computer Services presents..

Hard Disk Systems

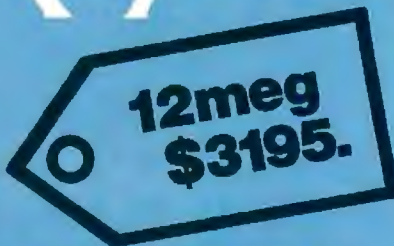

For TRS®, Apple®, Heath®, S-100, IBM.....
6,12,20,40 and 80 Megabyte systems

Completely assembled and tested subsystem including:

- Switching power supply
- Winchester drive
- Host adapter card
- Sealed case
- Expansion

The enclosure, controller and power supply have been designed to allow for future backup hardware or increased storage

- Software
- Auto attach CP/M*
- Hard disk utilities
- Real time clock

- Formatting program
Assigns alternate sectors for any weak sectors detected during formatting assuring the lowest possible error rate

- Warranty: The system has a full one year warranty on all parts and workmanship
- Also available: attach for TRSDOS, OASIS®, Apple DOS
- Optional 5¼" floppy (shown)



See local dealer
or call:
Quality Computer
Services
178 Main Street
Meluchen, New Jersey
201-548-2135

QCS
Quality Computer Services Inc.

* Quantity discounts available. Distributor, Dealer and OEM inquiries invited.

*OASIS is a trademark of Phase One Systems, CP/M is trademark of Digital Research
Circle 344 on Inquiry card.

Toll free number: 800 631 5944

8086-SUPER MICRO.



Superfast in its class and ready to run.

Computer Benchmarks—All systems running the same BASIC program.

Manufacture-Model	Class	Operating System	Language (Type*)	Run Time (Seconds)
IBM 3033	Mainframe	VS2-10RVYL	Stanford BASIC	10
Seattle Computer System 2	Micro	MS-DOS	Microsoft BASIC (C)	33
Digital Equipment PDP 11/70	Mini	n/a	BASIC (I)	45
Prime 550	Mainframe	PRIMOS	BASIC V16.4 (I)	63
Digital Equipment PDP-10	Mainframe	TOPS-10	BASIC (I)	65
IBM System 34	Mainframe	Release 05	BASIC (I)	129
TEI System 48	Micro	MAGIC 1.0	Microsoft BASIC (C)	178
Hewlett-Packard HP3000	Mini	Time Share	BASIC (I)	250
Seattle Computer System 2	Micro	MS-DOS	Microsoft BASIC (I)	310
Alpha Micro AM-100/T	Micro	AMOS 4.3a	Alpha BASIC (SC)	317
Digital Equipment PDP 11/45	Mini	n/a	BASIC (I)	330
Data General NOVA 3	Mini	Time Share	BASIC 5.32	517
Ohio Scientific C4-P	Micro	OS65D 3.2	Level 1 BASIC (I)	680
North Star Floating Point	Micro	NSDOS	NorthStar BASIC (I)	685
Radio Shack TRS-80 II	Micro	TRSDOS 1.2	BASIC (I)	792
Apple II+	Micro	DOS 3.2	Applesoft II (I)	960
Cromemco System 3	Micro	CDOS	32K BASIC (I)	1074
Commodore Pet 2001	Micro	n/a	Microsoft BASIC (I)	1374
IBM 5100	Micro	n/a	BASIC (I)	1951
Vector MZ	Micro	n/a	Micropolis BASIC (I)	2251

*C = Compiler; I = Interpreter. Times (except for Seattle Computer) taken from August 1981 issue of Interface Age.

The Seattle Computer System 2 is the fastest micro on the block. In fact, System 2 outperforms many minis and mainframes.

Even the big boys such as: IBM System 34, Prime 550, and Hewlett-Packard HP 3000 are left in the dust when System 2 starts running.

The speedy System 2 consists of 8 Mhz. 8086 CPU set, 128K of 85 nsec. static RAM, double-density disk controller, 22-slot constant voltage mainframe, a cable for two 8" drives, and MS-DOS operating system (also called 86-DOS, IBM PC-DOS, Lifeboat SB-86).

High-level languages like Microsoft's Basic, Pascal, Fortran, Cobol are available now for your application programs.

System 2 comes fully assembled, tested and ready to run with the addition of disk drives (that we can supply) and terminal.

Call (206) 575-1830 for the location of your nearest System 2 dealer.

Dealer inquiries welcome.



1114 Industry Drive, Seattle, Washington 98188

Radio Shack Color Logo



A spiral drawn with Color Logo turtle graphics. Note that text and graphics can be mixed on the same screen. The oblong object at the end of the spiral trail is the Color Logo turtle.

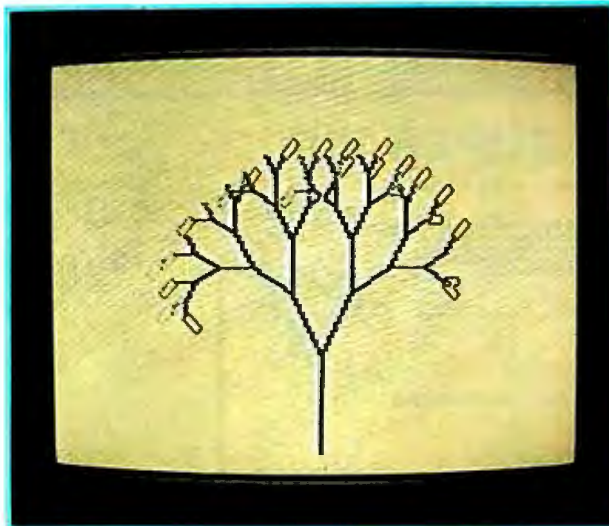

Multiple turtles in Color Logo. Here, multiple turtles are simultaneously drawing the branches of a tree shape. (Some turtle shapes are smeared because they were in motion when the photo was taken.)

As this review was going to press, we received a preliminary version of Color Logo for the TRS-80 Color Computer. Although it would be unwise to do an in-depth review of a product before it is entirely finished, I will give you an overview of the product in its current form. (The language itself is finished, but the authors, Larry Kheriaty and George Gerhold of Micro Pi, are changing it where possible in response to the reactions of people who are critiquing it.)

Two factors influence the structure of Color Logo, which is radically different from the other Logos being reviewed here. The first factor is the absence of any connection to MIT, which had a direct hand in the other Logos. The second factor is the limited memory size of the TRS-80 Color Computer—it has a maximum of 32K bytes, which must accommodate both the Logo language and a usable workspace. (The version that we received is on a 5¼-inch floppy disk. The language will also be available on cassette and ROM cartridge. Since the cartridge version does not occupy any of the memory space, it will give Color Logo a larger workspace than is otherwise possible. The cartridge version will run on either a 16K-byte or a 32K-byte machine, but the disk and

cassette versions require a 32K-byte machine.)

Because of the influences mentioned above, Color Logo is quite different from the other Logos reviewed here. It is intended for use by children, which is reflected in its limitation to turtle graphics. In other words, Color Logo supports turtle graphics (more on this later) but does not include any string- or list-manipulating words. In fact, all you can do outside turtle graphics is print a character string or number at the current location of the turtle.

Color Logo is radically different from the other Logos.

Color Logo has four modes: break, doodle, edit, and run. Break mode is a "central" mode from which you read and save files and go to the edit and run modes; all modes return to the break mode when the red Break button is pressed. All Logo statements and procedures are run from the run mode, through which turtle graphics appear (see above left photo). Edit mode allows you to create or change all the procedures in the workspace (all the procedures are in one workspace). Doo-

dle mode, entered from run mode with a name that later becomes the name of the pattern about to be drawn, allows younger children to create turtle graphics with predefined one-key commands (Color Logo provides a keyboard overlay that identifies the keys). When doodle mode is exited, the pattern can be redrawn in run mode by executing the name given earlier.

The turtle graphics of Color Logo are on a 192 by 256 grid, although the actual resolution of the graphics is 192 by 128. The turtle and background can be one of four colors, and you can choose one of two 4-color sets (you cannot, however, mix the sets). This seems to be equivalent to medium-resolution graphics PMODE 3 in TRS-80 Color Computer Extended BASIC.

The most interesting feature of Color Logo is its ability to create multiple (up to 255) turtles and have them send messages to each other (see above right photo). A new turtle is created by a HATCH command and then given an identification number, a procedure name to start executing, and an optional list of parameters to the procedure. The newly created turtle has the same shape, heading, and location as the turtle that created it, and it exists until the procedure calling it finishes or until a

Continued on page 250



Katie Newman,
Service Rep.

"DISCOUNT PRICING ON QUALITY PRODUCTS"

ORDER TOLL-FREE! 1-800-854-2833

NEW SUPER VIC



CALL

16K RAM
40 Col. Output

VIC HARDWARE

Vic Datasette	64
Vic Disk Drive	489
Vic Graphic Printer	329
Vic 8K Memory Expander	49
Vic 16K Memory Expander	98
Vic 24K Memory Expander	179
Vic Modem	99
3 Slot Expansion (Mini-Mother)	59
RS232C Terminal Interface	43
IEEE-488 Interface	84
Super Expander	49
Programmers Aid Cartridge	44
Vic Mon.	43
Programmers Reference Guide	14
Introduction to Basic Programming	18
Vic Term	9
Prog. Charc. Set/Game Ed.	11
Joysticks/Paddles (pair)	19
Light Pen by Simtec	129
Monitor Cables	12
PROM Simulator	199
40/80 Col. Card	199
Epson MX-70 (Configured for Vic)	CALL

CALL FOR FREE CATALOG



VIC 20

VIC SOFTWARE ON CARTRIDGE

Spiderman	36
Robot Blasters	30
Meteor Run	36
Sattelites & Meteors	36
Amok	29
Alien Blitz	29
Renaissance (Othello)	36
Aline	19
Cosmic Kamakazi	19
Vic Avengers	21
Super Slot	21
Super Alien	19
Super Lander	21
Draw Poker	20
Midnight Drive	21

NEW

Radar Rat Race	23
Adventure Land Adventure	29
Pirate Cove Adventure	29
Mission Impossible Adventure	29
The Count Adventure	29
Voodoo Castle Adventure	29
Sargon II (Chess)	33

ON TAPE

Vic Term A	15
Vi Calc	11
Vi Check	18
Vi Cat	18
Amok	14
Alien Blitz	18
Sky Math	11
Space Division	11
Vic Math Improvement (Grades 1-6)	49
B-1 Nuclear Bomber	12
Nuke War	13
Planet Miners	12
Lords of Karma	15
Vic Games (3 on 1)	19
Household Finance Pack (4 on 2)	26
Home Inventory (2 Programs on 1 Tape)	12
Recreational/Educational Pack I (2 on 1)	12
Recreational/Educational Pack II (2 on 1)	12
Car Cost (2 on 1)	12
*Needs 3K	
**Needs 8K	

COMMODORE CBM 8032

\$1038

HARDWARE

4016 Pet	739
4032 Pet	949
Super Pet	1489
CBM 8032	1095
CBM 8096	1395
4022 Dot Matrix Printer	589
4040 Dual Disk Drives (1 meg)	939
8050 Dual Disk Drives (1 meg)	1248
8250 Dual Disk Drives (2 meg)	1489
2031 Single Disk Drive	1599
8300P Letter Quality Printer	699
8023 136 Col. Dot Matrix	379
8096 64K Mem Board (CBM)	65
C2 N Recorder	795
The Soft Box by SSE Run CP/M	CALL
Smart Modem™ by Hayes	2699
D9090 Winchester Hard Disk (7.5 MB)	2195
D9060 Winchester Hard Disk (5.0 MB)	

CALL FOR LATEST PRODUCTS

SOFTWARE

Software Encyclopedia	9
TCL Pascal Version 1.6	139
Assembler Development	79
Integer Basic Compiler	119
CMAR Record Handler	109
UCSD Pascal (without board)	139
Petspeed BASIC Compiler	219
OZZ-8050	299
OZZ-4040	259
Wordcraft 80	296
Wordcraft 40-9"	219
Wordcraft 40-12"	219
Wordcraft 8096	296
Professional Tax Prep Sys.	599
Personal Tax Calc	55
Professional Tax (Off-season)	219
Professional Tax Update	369
Dow Jones PMS (80 col. RS232)	119
BPI A/R	299
BPI General Ledger	299
BPI Job Cost	299
BPI Inventory	299
BPI Payroll	299
Legal Time Accounting	449
Medical Acc. System	449
Atlas 1200 Service & Mainten	453
Titan Job Cost System	448
Freight Rating and Invoice	448
I.R.M.A.	379

COMMODORE 64 CALL FOR BEST PRICE

The Commodore 64 is a compact unit (will fit into briefcase). Full size typewriter keyboard, high res. color, this computer is the major breakthrough you've been waiting for.

- 64K Built in RAM • CP/M option
- Upper/lower case • Graphics characters
- TV interface • Music synthesizer
- 40 col. color display • "Smart" peripherals
- Cartridge game slot

The Commodore 64 can use the VIC or CBM/Pet Accessories.

Hewlett
Packard



- Computers
 - Plotters
 - Calculators
- Call For Prices

Circle 103



Computer Specialties goal is to become the premier dealer of products made for your IBM P/C. In keeping with that idea — we are now offering a free IBM personal computer catalog, featuring hardware & software made for the IBM personal computer. Please call for details.

ACCESSORIES APPARAT

Prom Blaster	129
Clock Calendar	109
Combo Card	239
AST	
MC-064 SP (64K Combo Card)	469
MC-128 SP (128K Combo Card)	639
MC-192 SP (192K Combo Card)	799
MC-256 SP (256K Combo Card)	979
(All Above Include Asynch & Parallel Ports)	
64K Mem	335
128K Mem	499
192K Mem	669
256K Mem	799

CHRISLIN INDUSTRIES

192K Mem Board	629
256K Mem Board	689
512K (with Serial RS232)	995

DAVONG

DSI-501 SMB Winchester Drive	1595
DSI 64K Mem Card	CALL
DSI 192K Mem Card	CALL
DSI 256K Mem Card	CALL

MACROLINK

64K Memory Card	369
128K Memory Card	519
192K Memory Card	659
256K Memory Card	729

QUADRAM

Quadboard 64K	495
Quadboard 256K	795
(Quadboard includes memory, clock/calendar, Parallel Printer I/O, Asynch RS232)	
Parallel Interface Card (B' Cable)	129
Time Clock (Clock/Calendar W/Software)	129

SEATTLE COMPUTER

64K Ram + Board	389
128K Ram + Board	529
192K Ram + Board	689
256K Ram + Board	799
(All Ram + Boards Include RS-232 Serial Port)	

TANDON

TM 100-1 5 1/4" Floppy Drive	CALL
------------------------------	------

XEDEX

Baby Blue	599
Run CP/M-80	

MONITORS & MISC.

Amdek Color II	769
Electro Home RGB	CALL
Joystick	47
Modems	CALL

SOFTWARE

Everest Explorer by Acorn	17
Money Manager by Acorn	29
CP/M-86 by CompuView	299
Vedit by CompuView	123
VCOM by CompuView	69
Fastscreen by CompuView	73
JANUS-86 by CompuView	CALL
The Programmer	369
Super Calc by Sorcim	219
CP/M-86 by Digital Research	279
The Organizer by Conceptual Instr.	209
C Basic by Digital Research	259
Software from Digital Marketing	CALL
Zork I, Zork II by Infocom	29
Deadline by Infocom	39
Easy Writer II by IUS	289
Easy Speller by IUS	158
Easy Filer by IUS	349
Volks Writer by Lifetree	149
Basic-80 by Microsoft	297
Basic Compiler by Microsoft	335
Fortran-80 by Microsoft	419
M/Sort by Microsoft	159
Easy by Denver Software	569
Home Accounting by Continental	129
Visicalc (Std) by Visicorp	169
Visicalc (256K) by Visicorp	199
Mathematic by ISM	69
Total Info. Management by Innovative	389
Logon by Ferox	129

You don't have to join a club and pay dues for a comprehensive catalog of IBM P/C Accessories and Software — ours is FREE!

BASIS 108

The Alternative

- 6502 and Z80 Microprocessors
- 64K RAM, expandable to 128K
- RGB and Composite Video Output
- Selectable 80 or 40 column text display
- High Resolution Graphics: 6 colors, 280x 92 or 280x160 with four lines of text
- 8 bit Parallel I/O • RS-232c Serial I/O
- Detached Keyboard: All standard keyboard functions, Upper/Lower case characters, Numeric keypad, Cursor block, and 15 Programmable special function keys
- 5 1/4" floppy disk drives
- Six Apple compatible slots for plug-in peripherals • Game paddle I/O

APPLE SOFTWARE

Bus. Pkgs by Continental	199 ea.
DB Master by Stoneware	169
Desktop Plan by Visicorp	189
Wordstar	199
Magic Window by Art-Sci	88
Peach Tree Accting Pkgs	CALL
Personal Filing System	95
Screen Writer II (formerly Super Scribe II)	99
TASC by Microsoft	159
The Last One	449
Visifile	199
Visicalc	189
Visidex	189
Visischedule	239
Visitrend/Visiplot	199

Entertainment

Alkemstone	34
Apple Panic	24
Castle Wolfenstein	24
Gorgon	35
Olympic Decathlon	24
Time Zone	79
Softporn	29
Complete Selection... in Stock	CALL

CALL! FOR COMPLETE SELECTION

**FRANKLIN CALL
ACE 100
NEC**

NEC PRINTER
PC-8001 A
NEC I/O Unit
NEC add on Dual Drive
NEC Green Screen

Call For
Total System
Price and
SAVE!!!

Call for Bill Jones and ask Bill for a free NEC catalog... and the lowest prices possible.

ATARI* 800 16K \$669

Atari 400 w/16K	319	Full-View 80	279
410 Recorder	79	32K by Microtek	139
810 Disk Drive	439	Light Pen by Syntek	129
850 Interface	159		

We offer a huge selection of software (the latest) and hardware (the greatest). Call toll free and receive our full product catalog just for your Atari!



FOURTH

ACCESSORIES

(Note: The hardware and software listed here is compatible with Apple, Basis 108, and the Franklin ACE-100).

Disk Drive W/Cntr by Fourth	479
Disk Drive W/O by Fourth	369
Videoterm by Videx	259
16K Card by Microsoft	249
Z-80 Card by Microsoft	119
AIO II by SSM	189
CCS Multifunction	159
Micro Sci Drives	CALL
Rana Sys. Drives	CALL
32K by Saturn	169
Numeric Keypad (23 Key)	119
Signalman Modem	79
Micro Modem II	278
Soooper Spooler	CALL
RGB Card	159
Enhancer II	124
Metacard	895
Joystick by T.G.	46
App-L-Cache 256K	CALL
Versacard	169
Vista Vision 80	CALL
Vista 8" Drives/Cntrls	CALL
In Fone by Novation	CALL
Microbuffer II 16K	199
Microbuffer II 32K	239
The Mill by Stellation	319
Expansion Chassis by Mtn	559
Data Ed Hi Res Color	499
Synergy Card by Spies	169
Appli-Card by Personal Comptr. Products	CALL
Chronograph by Hayes	190
Keyboard Enhancer II by Videx	124
Microbuffer II by Practical Peripherals	CALL
32K RAM (incl. Software) by Saturn	209
Lowercase for Apple	29
Numeric Keypad (23 Key) by Keyboard	119
Sup R Mod (TV Interface)	35
Music System W/Software by Mtn. Hardware	299
Expansion Chassis by Mtn. Hardware	559
The Clock by Mtn. Hardware	219
D-Cat Modem by Novation	169
Corvus Hard Disk	CALL
Corvus Mirror	CALL
A/D * D/A (no cable) by Mtn.	269
Supertalker SD200 by Mtn.	154
8" Disk Controller by SVA	349
The Grappler by Orange Micro	124
Versawriter Digitizer	209

*APPLE IS A REGISTERED TRADEMARK

LANGUAGE COMPATIBLE

JUST \$69⁰⁰

PARALLEL INTERFACE CARD

GREAT FOR EPSON AND OTHER GRAPHIC PRINTERS
2 YEAR WARRANTY
INCLUDES CABLE
ONLY \$69

5 1/4" DISKS
SINGLE SIDED
DOUBLE DENSITY
2 YR. WARRANTY
INCLUDES LIBRARY CASE!
NOW \$35

FREE SHIPPING*
(with prepaid cash orders)

ORDER TOLL FREE! 1-800-854-2833

PRINTERS in stock MAJOR BRANDS

CALL FOR BEST PRICE & FAST SERVICE

C. ITOH PROWRITER

120 CPS F/T

- OKIDATA • QUME •
- ANADIX • DIABLO •

TRANSTAR 140

DAISY 1350

40 CPS

IDS PRISM

80 OR 132 CALL

**MX-100
MX-80 F/T
MX-80**
with new graphics

TO ORDER: Phone orders invited using Visa, MasterCard or bank wire transfers. Visa and MC service charge of 2%. Mail orders may send charge card number (include expiration date), cashiers check, money order, or personal check (allow 10 business days for personal or company checks to clear). Please add 3% (\$5.00 minimum) for UPS shipping, handling, and insurance. APO and FPO include 5% (\$7.00 minimum) for postage. Calif. residents add 6% sales tax. Please include phone number on all orders.

FOREIGN ORDERS include 1% handling — shipped air FREIGHT COLLECT only. Credit cards not accepted on foreign orders. All equipment is in factory cartons with manufacturer warranty. Opened products not returnable. Restocking fee to returned merchandise. Equipment subject to price change and availability. Retail prices differ from mail order prices. WE SHIP THE SAME DAY ON MOST ORDERS!
*Excludes certain printers & monitors & foreign orders.

MAIL TO: 1251 BROADWAY EL CAJON, CA. 92021 (714) 579-0330

At a Glance

Name

TRS-80 Color Logo

Type

Programming language

Manufacturer

Radio Shack, Education Division
400 Atrium, One Tandy Center
Fort Worth, TX 76102
(817) 390-3302

Price

Disk version, \$99
Program pack version (not yet available)

Authors

George Gerhold and Larry Kheriaty

Format

Disk (available third quarter, 1982)
Program pack (read-only memory cartridge, available January, 1983)

Language Used

6809 assembly language

Computer Needed

Disk version, TRS-80 Color Computer with 32K-byte memory and disk drive
Program pack version, TRS-80 Color Computer with 16K-byte memory

Software Included

Disk version: one floppy disk containing the Color Logo language
one disk with sample programs

Documentation

Language reference manual and teacher's guide

Audience

Elementary school children, with some application to upper grades

because there may not be enough available memory with which to fix it. It has to do with the method Color Logo uses to draw lines. For example, if you say:

```
HOME  
RIGHT 30  
FORWARD 20
```

you will get a line that is 30 degrees from the vertical. (Color Logo does not accept multiple commands per line.) If, however, you say

```
HOME  
RIGHT 30  
REPEAT 20 (FORWARD 1)
```

you will get a line that is 45 degrees from the vertical. The reason for this is that Color Logo, like other Logos, can plot an adjacent dot in only one of eight directions (the eight points of a compass); unlike other Logos, however, Color Logo does not remember where the theoretical point is in relation to the plotted point. The result is that executing FORWARD 1 twenty times will force the turtle to draw a line on one of the eight points of the compass (depending on the true heading of the turtle and which point it's nearest to). This property of the preliminary version of Color Logo I looked at is unfortunate, since it creates a discrepancy between what you think Logo should do and what it actually does. Still, such a simplification is understandable given the complexity of Logo and the limited memory space of the TRS-80 Color Computer; if this behavior is in the finished product, I'll certainly understand.

In general, this looks like a nice Logo for children. As always, you should check the product's capabilities against its intended use and audience. Radio Shack plans to have Color Logo in its stores by September 1982. ■

VANISH statement is called with its number. Color Logo processes one statement from each turtle, then repeats the process, thus giving the illusion that all the turtles are executing their programs simultaneously. Turtles can send and receive "mail," but the mail is limited to a single integer value between -32,768 and 32,767. Radio Shack claims in a press release that, with Color Logo, "Anyone from the preschool child to the computer scientist can investigate the principles of structured thinking (and programming), multitasking, interprocess communications, modular programming, parameter passing, local and global variables, and looping and recursion." Although about half of the above subjects can be taught with the language, I think that some of the claims are extravagant for a Logo that can only pass single-integer "messages."

The disk version of Color Logo saves a maximum of 16 Logo workspaces, each of which is referred to by a letter from A to P. While this seems quite simplistic to most of us, it is exactly right for its intended audience, young children. I assume that the cartridge and cassette versions will use a similar mechanism.

Two more Color Logo features deserve mention. One is the inclusion of a WHILE statement that allows a list of items to be done as long as a given condition evaluates to a nonzero ("true") value. The other is the ability to redefine the turtle's shape under program control. This can be used to change the turtle's default shape (an odd, elongated capsule shape) or even to perform some limited animation by rapidly redefining the turtle shape.

Although some bugs will be fixed in the final version, one deserves mention

Text continued from page 242:

"turnkey" system. If a Logo file named STARTUP is on your data disk when you first boot up Logo, that file is automatically loaded into the Logo workspace. If a Logo variable named STARTUP has a value that is a list, that list is executed after loading the startup file. In this way, a nontechnical user can follow the standard Logo booting procedure and end up with a customized workspace running a certain program.)

Property lists are lists of characteristics that can be associated with a given Logo variable. For example, you may have a number of words that describe geometric shapes: TRIANGLE, SQUARE, PENTAGON. You can then give each of these words two properties, NUM.OF.SIDES and INTERIOR.ANGLE, and assign values to them. Using the name SQUARE as an example, you would first add the properties and their values to the

property list associated with SQUARE:

```
PPROP "SQUARE "NUM.OF.SIDES 4  
PPROP "SQUARE "INTERIOR.ANGLE  
90
```

You can then print out the property list of SQUARE (the computer's responses are in italics):

```
SHOW PLIST "SQUARE  
[INTERIOR.ANGLE 90 NUM.OF.SIDES  
4]
```

OKIDATA MICROLINE 84

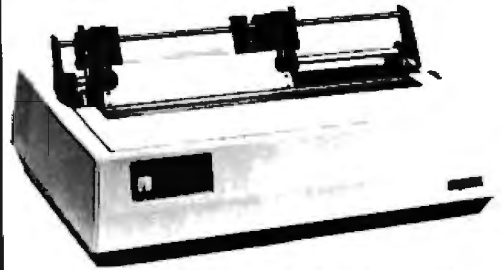

Parallel—\$1094.88 UPS DELIVERED
RS-232C—\$1224.88 UPS DELIVERED

- 200 cps, bi-directional, logic-seeking
- 16 1/4" carriage w/friction & tractor feed
- Near letter-quality proportional print in all sizes & modes (50 cps)
- Dot-addressable graphics standard

Okidata Printers

MICROLINE 80	\$349.88
MICROLINE 82A	\$449.88
MICROLINE 83A	\$719.88

Smith-Corona Printer

TP-1 DAISY WHEEL PRINTER	\$689.88
10 or 12 cpi, parallel or RS-232C	

IDS Printers

IDS PRISM 80 w/Sprint Mode, Dot Plot, and Cut Sheet Guide	\$999.88
IDS PRISM 132 includes all the above plus 4-color graphics	\$1699.88

NEC Printers

NEC PC 8023A-C	\$509.88
NEC 3510/3530 Spinwriter (Parallel or RS-232C) 35cps	\$1904.88
NEC 7710/7730 Spinwriter (Parallel or RS-232C) 55cps	\$2559.88

C.Itoh Printers

C.ITOH PRO WRITER (Parallel)	\$509.88
C.ITOH PRO WRITER (RS-232C)	\$664.88
C.ITOH PRO WRITER II (Parallel)	\$739.88
C.ITOH PRO WRITER II (RS-232C)	\$799.88
C.ITOH F-10/40 STAR WRITER Daisy Wheel (Parallel or RS-232C) 40cps ..	\$1494.88
C.ITOH F-10/55 STAR WRITER Daisy Wheel (Parallel or RS-232C) 55 cps ..	\$1799.88

Cables and interfaces available for APPLE ATAR, CBM/PET, IBM PC, OSBORNE, & TRS-80.

Orders & Information:
CALL (603)-673-8857

ORDERS ONLY: CALL (800)-343-0726

No Hidden Charges

No surcharge for credit cards—No charge for UPS shipping—Stock shipments next day
 All equipment shipped factory fresh with manufacturer's warranty—We accept CODs (Sorry, no open POs or foreign orders)

Prices subject to change

HIGH TECHNOLOGY AT AFFORDABLE PRICES

THE BOTTOM LINE

ELM STREET, MILFORD NH 03055-0423

August 1982 © BYTE Publications Inc 251

At a Glance

Name

Terrapin Logo

Type

Programming language

Manufacturer

Terrapin Inc.
 678 Massachusetts Ave., #205
 Cambridge, MA 02139
 (617) 492-8816

Price

\$149.95

Authors

Leigh Klotz Jr., Patrick Sobalvarro, Stephen Hain

Format

5 1/4-inch floppy disk

Language Used

6502 machine language

Computer Needed

Apple II or Apple II Plus with 48K bytes of memory and 16K memory card

Software Included

One Logo Language Disk (copy protected; backup available for \$15), one Utilities Disk (with utilities from MIT and Terrapin)

Documentation

Terrapin Logo Tutorial, 86 pages (draft version); Logo for the Apple II: Technical Manual, by Harold Abelson and Leigh Klotz Jr., 55 pages

Audience

Anyone interested in Logo

or you can get the value of a given property:

```
SHOW GPROP "SQUARE
"NUM.OF.SIDES
```

4

Note that the word **SQUARE** can be either a variable with a value or a procedure with a definition; its property list is connected to but not the same as the word itself. Property lists can be useful in certain list-manipulating applications. (By the way, it would not be very hard to make a set of Logo procedures that do the same thing for most of the other Logos; Harold Abelson does this—he calls them *association lists*—in his two books, *Apple Logo* and *Logo for the Apple II.*)

CATCH and **THROW** are two unlikely Logo commands that allow a given condition to cause the execution of a list of commands. Normally, there's nothing special about that—an **IF** statement will do the same thing—but in this case, the triggering condition may be a Logo error. If so, a Logo program can intercept the usual Logo response to that error and substitute a user-specified response; this allows a program to recover from specified errors instead of ending.

Apple Logo contains a number of useful commands that are not in the other Logos reviewed here. Although most of them can be defined by the

user, it is nice to have them available automatically. Examples of such commands are **COUNT** (which returns the number of items in a list), **ITEM** (which returns the *n*th item of a list), and numerous predicate words that return a value of "TRUE" or "FALSE" depending on the logical value of whatever is being tested (**EMPTY**, **KEYP**, **WORDP**, and others). Apple Logo also lets you redefine the primitive operations supplied with the language; although most people won't need to do this, it's nice to be able to.

Several other features are worth mentioning. One characteristic of all Logos is that any named variable becomes global to the workspace (and so has the same value within any procedure in it) unless the name is an argument to a procedure (these are called *dummy arguments* in other computer languages). Apple Logo has added a **LOCAL** statement that restricts the domain of any variable named by it to the procedure that uses the **LOCAL** statement and any procedures it calls. This often helps prevent hard-to-find program errors resulting from unsuspected interaction between variables.

Users of Apple Logo will probably be able to buy a peripheral board for the Apple that will give it sprites (colored, moving images of varying shapes—see the discussion on sprites in the section on TI Logo, below).

North Star's Advantage over IBM and Apple is easy to see.

The North Star ADVANTAGE desktop computer has higher precision graphics, better software, and greater disk capacity than the IBM Personal Computer or the Apple III. Plus, nationwide on-site service and free business graphics software. See it for yourself. Then check the price. You'll see how easy it is to own the North Star ADVANTAGE. For the name of the North Star dealer nearest you, call today.

CALL TOLL FREE
1-800-447-4700
(ILLINOIS 1-800-322-4400)



FOLLOW THE STAR
NorthStar™

14440 Catalina Street, San Leandro, California 94577

Logo Computer Systems Inc. (which created Apple Logo) showed me a prototype of a sprite board that the company plans to market by the end of 1982. Multiple sprites will be able to move on screen at a time, and they will be able to draw lines, just as a turtle can. (TI Logo sprites do not draw lines.) Once this happens, TI Logo will lose one of its main advantages over the versions of Logo for the Apple II. (At this writing, we have no details on availability or price.)

Apple Logo: Problems

I found one bug in Apple Logo and several things I didn't like. The bug occurred as follows:

```
SHOW SENTENCE - 5 3
[- 5 3]
SHOW SENTENCE + 5 3
[8]
```

Apple Logo should have returned `[5 3]`. The error occurs in the parsing of the phrase `+ 5 3` and has nothing to do with the `SENTENCE` command itself. Apple Logo shows a certain resemblance to LISP in allowing an operator-number-number construct for the operations of addition, subtraction, multiplication, and division. So Apple Logo behaves as follows:

```
PRINT + 5 3
8
PRINT / 12 4
3
```

It seems that something in the parsing algorithm cannot distinguish between `+ 5 3` and `+ 5 3`. Although this is definitely an error, it probably will not occur in normal programming because people do not usually place plus signs before positive numbers.

A command I don't like is the Apple Logo `IF` statement. In Terrapin/Krell Logo, an `IF` statement looks like this:

```
IF :RES0 THEN MAKE "RES :RES - 1
ELSE MAKE "RES :RES + 1
```

In Apple Logo, this becomes:

```
IF :RES0 [MAKE "RES :RES - 1] [MAKE
"RES :RES + 1]
```

At a Glance

Name
TI Logo

Type
Programming language

Manufacturer
Texas Instruments Customer Relations
POB 53
Lubbock, TX 79408
(800) 858-4565

Price
\$129.95

Author
Jointly developed by Texas Instruments
Corporate Engineering Center and the
MIT Logo Group

Format
Command Module (read-only memory cartridge)

Language Used
9900 machine language

Computer Needed
Texas Instruments TI-99/4 or TI-99/4A with
32K-byte memory expansion option and
either cassette recorder or floppy disk

Software Included
One Command Module containing TI
Logo; a cassette and floppy disk contain-
ing TI Logo demonstration programs

Documentation
TI Logo, 83 pages; booklet of documenta-
tion for the demonstration programs

Audience
Anyone interested in Logo

ming practice, and I am amazed and horrified to find that Apple Logo does not provide for them (all the other Logos except the TRS-80 Logo do).

There is, however, a way around the lack of comments in Apple Logo. Simply define a short procedure that takes a list as an input and does nothing with it:

```
TO ; :ARG  
END
```

This defines the Logo procedure “;” which will “eat” any list that comes directly after it. You can now add comments to a program by putting brackets around them and a semi-colon and a space just before the opening bracket:

```
TO DUMMY.PROGRAM  
; [THIS COMMENT WILL BE  
  IGNORED]  
END
```

This method, however, may have speed and program-size side effects because the comments are actually a part of the procedure and are executed every time the procedure is executed. As for the necessity of putting brackets around things—you’re getting used to that by now, aren’t you?

Terrapin/Krell Logo

Both Terrapin Inc. and Krell Software Corporation are licensed to distribute MIT Logo, a version of Logo developed by the Logo Group of the Massachusetts Institute of Technology. (This implementation was created by Leigh Klotz Jr., Patrick Sobalvarro, and Stephen Hain under the direction of Harold Abelson.) Though the language is the same for both companies’ versions, the materials supplied with each version differ. The main differences are as follows: Krell Logo includes a second (copy-protected) Logo disk, a set of introductory programs called “Alice in Logoland,” a program called INSTANT.LOGO.TUTOR, a nice reference-guide wall poster, and a copy of *Logo for the Apple II*, by Harold Abelson. Terrapin Logo includes only one Logo disk (you can buy an extra one for \$15), a copy of *Logo for the Apple II: Technical*

In Apple Logo, both the THEN and the ELSE clauses of the IF statements are actually lists. If the expression evaluated is true, the first list is executed; if it is false, the second list is executed. This particular syntax seems arbitrary to me, and it might seem rather cryptic to someone who has not dealt with computers before. In addition, if you write an IF statement without the brackets, you get an error message that is unrelated to the IF statement or the absence of brackets. This makes the debugging process longer. Given the apparent Apple Logo philosophy of tailoring the system to the nontechnical user, I’m surprised the IF statement was implemented this way.

Apple Logo seems to enjoy making inputs to certain commands into lists. For example, the commands SETPOS, TOWARDS, IFTRUE, and IFFALSE require their arguments to be made into lists. Given, say, variables XVAL and YVAL that have numeric values, in Terrapin/Krell Logo, you would say:

```
SETHEADING TOWARDS :XVAL  
:YVAL
```

However, Apple Logo requires you to make a list of the :XVAL :YVAL pair. So the Apple Logo version has to be:

```
SETHEADING TOWARDS LIST :XVAL  
:YVAL
```

The word LIST has to precede the values of XVAL and YVAL because the TOWARDS command requires as input a list with two numbers in it. (You can’t simply say [:XVAL :YVAL] because brackets prevent the evaluation of :XVAL and :YVAL.) Like the use of the IF statement, the use of brackets (or any other list-making words) seems to me arbitrary, cryptic, and error inducing.

I am amazed and horrified to find that Apple Logo does not provide for comments in Logo programs.

Finally, there is an omission in the Apple Logo system that I find quite inexcusable—Apple Logo has no provision for putting comments in Logo programs. According to someone at Logo Computer Systems Inc., comments were not allowed because they caused procedures to take up too much space. I find this a rather weak excuse for a language that purports to teach good programming habits and make programming easy for beginners. Making comments in programs, regardless of the language used, is one of the cornerstones of good program-



Mainframe- Quality Software for Microcomputers

ISE is an international consortium of the world's leading consulting and software firms.

Our specialized products and services are distributed throughout the world by these ISE affiliates:

In U.S.:
ISE-USA
350 West Sagamore Parkway
West Lafayette, IN 47906
Tel: (317) 463-2581
TWX: 810-342-1881

In France:
ISE-CEGOS
Tour Chenonceaux
204, Rond-Point du Pont de Sèvres
92516 Boulogne Billancourt Cedex
Tel: 620-61-04

In Germany:
ISE-ADV/ORG GERMANY
Lothstr. 19
D-8000 Munich 40
Tel: 089-192 071/4

In Norway:
ISE-DATEMA NORWAY
ST. Halvards gt. 77
Oslo 6 Norway
Tel: (02) 670880

In Sweden:
ISE-DATEMA SWEDEN
Box 1056
Huvudstagan 1
171 21 Solna

In Switzerland and Austria:
ISE-ADV/ORG SWITZERLAND
Morgartenstrasse 6
CH-6003 Luzern
Tel: 041-23 23 60/61

In the UK and Ireland:
ISE-PACTEL
Rochester House
33 Greycoat Street
London SW1P2QF
Tel: 01-828 7744

Elsewhere:
ISE-INTERNATIONAL
350 West Sagamore Parkway
West Lafayette, IN 47906
Tel: (317) 463-4561
TWX: 810-342-1881

Visit us at booth #603, Software/Expo National in Chicago.

Listing 3: An example of the TRACE function tracing the execution of the Logo phrase STR.GR.THAN "IT "IS.

```
TRACING ON
EXECUTING STR.GR.THAN IT IS
IF :FIRST = :SECOND OUTPUT "FALSE
IF :FIRST = " OUTPUT "FALSE
IF :SECOND = " OUTPUT "TRUE
MAKE "CHAR1 FIRST :FIRST
MAKE "CHAR2 FIRST :SECOND
IF ASCII :CHAR1 > ASCII :CHAR2 OUTPUT "TRUE
IF ASCII :CHAR1 < ASCII :CHAR2 OUTPUT "FALSE
OUTPUT STR.GR.THAN BUTFIRST :FIRST BUTFIRST :SECOND
EXECUTING STR.GR.THAN T S
IF :FIRST = :SECOND OUTPUT "FALSE
IF :FIRST = " OUTPUT "FALSE
IF :SECOND = " OUTPUT "TRUE
MAKE "CHAR1 FIRST :FIRST
MAKE "CHAR2 FIRST :SECOND
IF ASCII :CHAR1 > ASCII :CHAR2 OUTPUT "TRUE
ENDING STR.GR.THAN
ENDING STR.GR.THAN
RESULT: TRUE
```

Manual, and a copy of the *Terrapin Logo Language Tutorial*, by Deborah Tater and Patrick Sobalvarro.

Your choice of the Krell or Terrapin version of MIT Logo will depend on your own preferences. On one hand, Terrapin now employs one of the persons who implemented MIT Logo and consults with another (Leigh Klotz Jr. and Patrick Sobalvarro, respectively). Terrapin will offer revised versions of Terrapin Logo for \$20; also, if you find an error in Terrapin Logo during the 90-day warranty period and Terrapin has corrected it, you will receive the revision containing the correction free. The tutorial book by Tater and Sobalvarro is very good. Although it is geared for the novice, it does a very good job of introducing some advanced Logo concepts. Finally, Terrapin may be offering a version of its Logo that implements sprites (more on that below).

I found the programs supplied by Krell competent but simplistic; however, the "Alice" programs might be of interest to children. Krell also offers more support materials, though many of them were not available at press time and so could not be evaluated. Abelson's excellent tutorial book is geared to the beginning, nontechnical user. I prefer the Terrapin version, largely because of

its superior technical support and the availability of a sprite version. However, the Krell version offers slightly more materials for the money.

Although both Terrapin/Krell Logo and Apple Logo can be used easily by *any* prospective user, adult and child alike, the differences between them seem to indicate different company perceptions of the intended Logo user. Each version makes a certain class of things easier to do. Although Apple Logo has a richer set of commands, it is delivered to the user as a sealed "black box" that you can't tinker with; in addition, certain features (like the STARTUP file, buried packages, and the necessity of deleting a disk file before it can be resaved under the same name) seem to point toward making the finished application as user-proof as possible. On the other hand, Terrapin/Krell Logo seems to be oriented toward the more knowledgeable user, who doesn't need that extra level of protection. The following paragraphs describe the features of Terrapin/Krell Logo that support this point of view.

The pair of program debugging commands TRACE and NOTRACE is easily the most important feature of Terrapin/Krell Logo. After TRACE has been executed, Logo executes a procedure one line at a time (showing each line as it executes) and waits for

Data base management: Check out the essentials.

CHECKLIST

Before You Buy A DBMS Check These 10 Essential Aspects.

- 1. **Data Integrity:** Does it protect against data corruption, erroneous data entry, and unauthorized relationships?
- 2. **Physical Data Protection:** Are recovery and restart capabilities provided? Can you roll the data base back to a previous state?
- 3. **Data Security:** Does it provide separate "read" and "write" access controls? Down to the item level? Is data encryption provided?
- 4. **Data Independence:** Can the data base structure be modified without changing previous programs?
- 5. **Performance:** Can you tune performance by controlling physical storage? Can you eliminate data redundancy? Are variable length records and data compression provided? Are response times acceptable for large data bases?
- 6. **Multi-User:** Does it support concurrent multi-user access with passive and active locking at the record level?
- 7. **Ease of Use:** Can many-to-many and recursive relationships be directly defined? Can programs be written in any major programming language? Are instructions short and simple? Is quality documentation available?
- 8. **Query Report System:** Can ad hoc queries be easily made with non-procedural, English-like statements? Are sophisticated reports available from pre-defined queries? Are nested queries supported?
- 9. **Portability:** Does the DBMS run under CP/M™, MP/M, CP/M-86, MP/M-86, PC DOS™, UNIX™? On Z80™, 8086, 8088, 68000, and PDP-11™? Does it run with COBOL, Pascal, FORTRAN, PL-1, BASIC and C?
- 10. **Support:** Are professional training, regular product updates, enhancements, and professional consulting all available?



Professionals know the difference.

ISE is an international consortium of the world's leading consulting and software firms, representing over 5,000 professionals around the world.

If you can't answer "YES" to these questions, send for our comprehensive booklet, "How to Evaluate and Select a Data Base Management System."

MAIL TO: Your local ISE affiliate.

Name _____ Title _____

Company _____

Address _____

City _____ State _____ Zip _____

Phone _____ (area code) _____ (ext.) _____

Z80 is a registered trademark of Zilog; PDP-11 of Digital Equipment Corp; CP/M of Digital Research; UNIX of Western Electric; PC DOS of IBM. 4B302

Filename	Description
ANIMAL	a guessing game about animals that shows Logo's list-manipulating features
INSTANT	a program that lets small children draw pictures using the turtle and one-letter commands
DYNATRACK	a program that introduces a dynaturtle—a turtle that moves according to the laws of Newtonian physics
FID	a file utility program
MUSIC	a set of Logo procedures that plays music through the Apple speaker
SHAPE.EDIT	a program that allows you to change the shape of the Logo graphics turtle
ASSEMBLER	procedures that allow you to define Logo procedures in terms of 6502 assembly-language code
TCL *	a set of Logo procedures that allows a Terrapin turtle robot to be controlled from Terrapin Logo
PSAVE *	a procedure that lets you save only part of the Logo workspace
CURSOR *	added procedures related to the text cursor and text output
TEXTEDIT *	procedures that let you use the Logo editor as a text editor
TEACH *	a procedure that lets you enter procedures without using the Logo editor (for smaller children)
ARCS *	procedures for drawing arcs and circles
INSTANT.LOGO.TUTOR **	a program that calls up basic information about Logo when the word MENU is executed
KRELLSHAPES.AUX **	a procedure that allows you to change the turtle to any one of 25 predefined shapes
PSR, PCB, DOT.LINE, SFD, CIRCLE **	miscellaneous graphics words
LENGTH, XFL, IXL, XNE **	miscellaneous list-manipulating words

Table 1: A list of the major files on the Terrapin/Krell Logo Utilities Disk and their function. Files marked with one asterisk are provided with Terrapin Logo only; files marked with two asterisks are provided with Krell Logo only.

a keypress before executing the next statement. Listing 3 shows an example of executing a Logo statement when the TRACE function is active. In preparing for this review, I wrote several programs and transferred them to all three Logo systems; I can't tell you how much I missed the TRACE function on the three systems that don't have it.

Another convenient feature of Terrapin/Krell Logo is the DOS command, which lets you interact with the Apple DOS (disk operating system). For example, you can rename a file from Logo like this:

```
DOS [RENAME GERBIL.LOGO,
GERBILWARS.LOGO]
```

The DOS commands this works with are BLOAD, BRUN, BSAVE, CATALOG, DELETE, LOCK, MON, NOMON, RENAME, UNLOCK, and VERIFY.

Terrapin/Krell Logo includes a Logo 6502 assembly-language assem-

bler and sufficient information on the Logo internal structure to make it useful. This is the single feature of Terrapin/Krell Logo that best illustrates its "open-software" as opposed to Apple Logo's "closed-software" philosophy. With the Terrapin/Krell Logo Assembler, you can

Sprites are easily the most important feature of TI Logo.

do a lot of things that can't be done with Apple Logo—anything that requires assembly language or interfacing to the outside world. For example, an assembly-language program to generate a variable-pitched tone through the Apple speaker can be interfaced to Logo and used to create a music-playing program written in Logo.

Assembly-language routines can also be used to connect Logo to, say, a nonstandard printer card, a real-time clock, or a tone generator connected through the Apple game paddles. (*Logo for the Apple II: Technical Manual* also includes a two-page list of useful memory addresses and routine entry points as part of an entire chapter on how to write assembly-language routines for Terrapin/Krell Logo and how to use the Logo Assembler.)

The Utilities Disk is another important feature of Terrapin/Krell Logo. It contains the assembler as well as several other useful sets of procedures. Table 1 gives a list of the major files on that floppy disk. Both Terrapin and Krell have put on their Utilities Disks several files that have been created by members of their staffs; each are not, of course, available on the Utilities Disk supplied by the other company.

A special variable called SAVEMOD can be changed to allow using the Terrapin/Krell Logo editor as a text editor. (Without this change, the editor would try to execute the contents of the file.) Some procedures on the Utilities Disk make reading, writing, and printing arbitrary text files easier. The SAVEMOD variable is also useful in making self-starting files (files that, after being loaded into the Logo workspace, automatically execute one or more phrases of Logo).

Terrapin/Krell Logo will work with Steve Ciarcia's sprite board for the Apple (see Ciarcia's column in this issue for details). It is possible that Terrapin will also create a new version of Logo that will integrate sprite and turtle graphics on the same screen and allow sprites to be given movement that is independent of the executing procedure; however, this had not been decided at the time this was written. As with the sprite board for Apple Logo, the availability of one from Terrapin would negate the presence of sprites as one of the primary advantages of TI Logo.

TI Logo: Features

Although people at Texas Instruments worked with people at MIT to create TI Logo, this Logo is not as



Photo 2: Priority in TI Logo sprites. The sprite with the lower number (a truck) appears to be on top of the sprite with the higher number (a box).

similar to the Apple-based Logos as they are to each other. Some of the differences will make TI Logo the best system for some people, but most of them, in my opinion, will severely limit TI Logo's usefulness. I'll consider the features of TI Logo first, then its limitations.

Sprites are easily the most important feature of TI Logo. They are colored video images (up to 16 dots wide by 16 dots high) that are an inherent part of the TI-99/4A. The TI-99/4A has 32 sprites built into it, and each sprite can be given a shape, color, and position on the video display (independent of the text being displayed); in addition, the sprites have an inherent priority of display among themselves, so that when two sprite images intersect, one sprite appears to be on top of the other (see photo 2). This priority is automatically maintained by video circuitry inside the TI-99/4A.

TI Logo adds some features to the hardware-inherent features of sprites. Sprites (like turtles) can be given a heading, but, unlike turtles, they can also be given a velocity. In other words, sprites move in a straight line at a given speed *without slowing down the running program* until they are told to change their behavior; in fact, they also move even when no

program is running. The reference list, which includes all the sprite commands, shows TI Logo's superiority over the Apple-based Logos in this respect. However, sprites are unlike turtles in that they cannot draw lines.

Closely related to sprites are sprite shapes. Five are defined by name: PLANE, TRUCK, ROCKET, BALL, and BOX. (Because sprite shapes are called by number, these are actually variables with the values 1 through 5.) Sprites can also be given one of 16 colors, and the attributes of shape, color, heading, and speed can be assigned to a sprite by the following Logo commands.

```
TELL SPRITE 2
(makes sprite 2 "listen" to the
  commands that follow)
CARRY :BALL
(gives it the predefined "ball" shape)
CARRY 4
(does the same as CARRY :BALL)
SETCOLOR :RUST
(gives it an orange-brown color)
SETCOLOR 8
(does the same as SETCOLOR :RUST)
SETHEADING 90
(makes it point to the right)
SETSPEED 48
(starts it moving at a speed of 48)
```

Note that the *number* of the sprite (in this case, *sprite 2*) and the *shape* of

Sinclair Owners...

Expand Yourself! I/O Capability for Your ZX-80, ZX-81.

■ **8 Port I/O Board**
Special adapter cable mates to Sinclair edge connector.
Feed-thru accepts Sinclair 16K memory module.
Buffered address lines.
Separate power supply.
I/O command with one line of BASIC.
8-Port bus. I/O \$109

■ **A/D and D/A**
Special cable connects to micro developments I/O bus.
2 channels; A/D, 0-5V input—
D/A, 0-5V output. AD \$97

■ **Clock**
16-pin ribbon cable connects to micro developments I/O bus.
Switchable 0.1 or 1 sec resolution.
Manual or computer control.
Beeper. SC \$75

Educational documentation, applications applications, programs are provided with each board. All programs run on 1K RAM. \$5.00 handling charge on all orders.

■ **CALL TOLL FREE**
800-227-1617
operator 641
(CA, 800-772-3545)
operator 641

These numbers are for credit card orders only.
For information, write us at:

Box 1140
2000 Center Street
Berkeley, CA 94704

micro developments

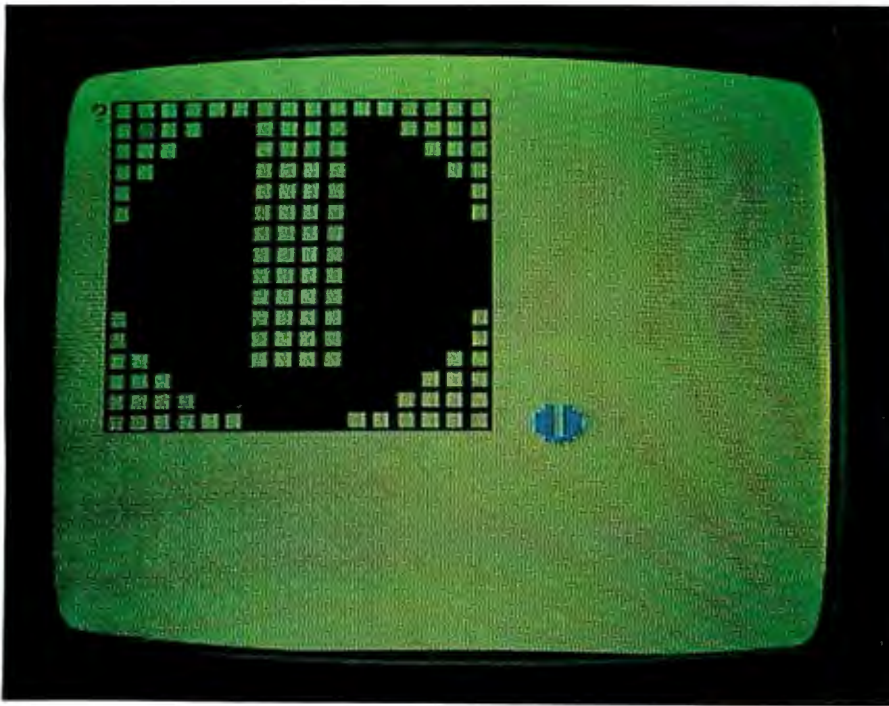

Photo 3: The MAKESHAPE procedure in TI Logo. When MAKESHAPE *n* is executed, sprite shape *n* is displayed in enlarged form and is available for editing. The graphics cursor, a blinking box, can be moved to any box with arrow keys; when the cursor leaves a box, the box can be left either filled in or empty. Any sprites carrying that shape immediately assume that shape, as can be seen by the small sprite of the same shape on screen.

the sprite (in this case, *shape 4*) are different.

New sprite shapes (numbered from 0 to 25) can be created (or existing sprite shapes can be redefined) with the MAKESHAPE command. For example, to redefine shape 4, the ball, type:

MAKESHAPE 4

An enlarged version of the ball appears in a 16 by 16 grid with a blinking square denoting the graphics cursor. A square is cleared when an arrow key is pressed and filled when the TI-99/4A function key (or TI-99/4 shift key) is pressed (see photo 3). Although this scheme certainly works, it is hard to go across a complicated shape without accidentally changing it; it would be nice if the graphics cursor had a nondestructive mode that allowed it to move without changing the shape underneath it. When the Back key is pressed, the modified shape (in this example) becomes shape 4. (Unfortunately, there is no way to exit the shape-making process and leave the shape as it was before editing began.)

Tiles are TI's nontechnical name for characters, which are patterns in an 8 by 8 grid. (Interestingly enough, certain TI Logo commands like MAKECHAR and PRINTCHAR refer to them as characters, while the documentation and some other commands—TELL TILE *n* and PUTTILE—refer to them as tiles.) There are 256 tiles available in the system, 64 of which are used for the TI Logo character set. Any tile can be redefined with the MAKECHAR command, which works like the MAKESHAPE command described above.

Tiles can also, to a certain extent, be given a different color. Tiles are grouped by ascending tile number in sets of 8, and a tile can be given one of 16 colors by using the SETCOLOR command:

```
TELL TILE 78
SETCOLOR :LEMON
(or SETCOLOR 11)
```

These commands will cause the letter N (which is tile 78) to change to a cer-

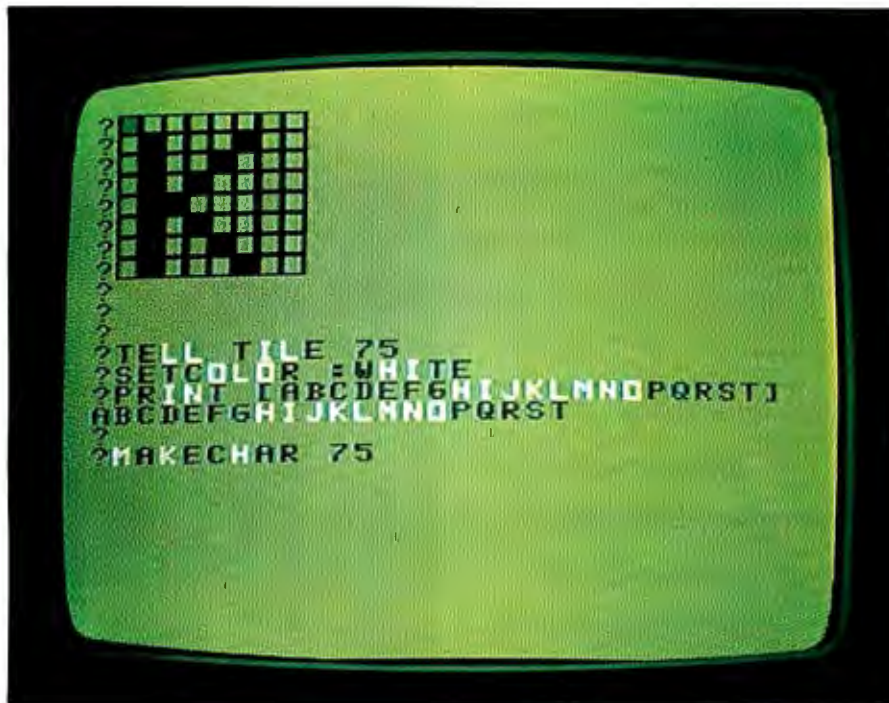

Photo 4: Tile recoloration and redefinition. As this photo illustrates, both the shape and color of a tile (character) can be changed. Notice that changing the color of a single tile also changes the color of the other seven tiles in the same group.

Fit Right in



Of course Percom diskette drives for the IBM Personal Computer fit right in. They fit right outside your Personal Computer, too. And they're fully compatible, providing the same full double-density storage capacity.

But just as important, Percom diskette drives also fit the same high standards set by IBM.

At Percom we've been making disk storage systems since 1977. We build quality, high-performance disk drive systems. From proven design through quality inspections that include 100% two-day operational tests. And Percom dealer support ensures competent after-sale service.

So expect more from Percom. You won't be disappointed.

Percom disk drives for the IBM Personal Computer are available in 40-track single- and dual-head models, and 80-track single-head models. Call or visit your independent IBM Personal Computer dealer — and fit right in with Percom. For the names of dealers carrying Percom products for your Personal Computer call toll-free 1-800-527-1222.

PRICES AND SPECIFICATIONS SUBJECT TO CHANGE WITHOUT NOTICE.



PERCOM DATA COMPANY, INC.

11220 PAGEMILL RD. • DALLAS, TX 75243 • (214) 340-7081

IBM and IBM PERSONAL COMPUTER are trademarks of International Business Machines, Inc.

PERCOM is a trademark of Percom Data Company, Inc.



Minimum system requirements are an IBM System Unit with 16 Kbytes of RAM and 5 1/4" Diskette Drive Adapter. Drive models supported depend on DOS used. An optional cable available from Percom is required for external (add-on) drives.

Yes ... I'd like to know more about Percom diskette drives for my IBM Personal Computer. Rush me free literature.

Send to: PERCOM DATA COMPANY, Inc., Dept. 2-B01
11220 Pagemill Road, Dallas, Texas 75243

name _____

street _____

city _____ state _____

zip _____ phone number _____

I intend to add a hard-disk system to my computer yes no.
MAIL TODAY!

Main/Frames

Main/Frames

from
\$200

- 30 Models of Enclosures
- Assembled and tested
- Quasi-Coax Motherboards
- Power Supply
- Card cage and guides
- Fan, line, cord, fuse, power & reset switches

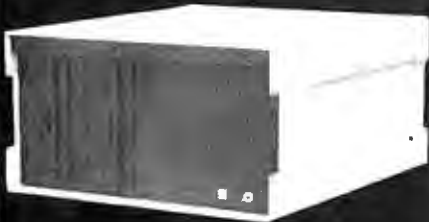

8" Floppy Main/Frame



8" Disc Enclosure



Phase/80 8" Floppy Mainframe



Phase/80 Desk + Mainframe

Write or call for our brochure which includes our application note: "Building Computers — A Recipe"

INTEGRAND

8620 Roosevelt Ave. • Visalia, CA 93291
209/733-9288

We accept BankAmericard/Visa and MasterCard

Apple Logo system:	
Apple II Plus with 48K bytes of memory	\$1530.00
Apple Language Card	195.00
Disk controller card and one floppy disk	645.00
RF modulator (approximate price)	40.00
Apple Logo	175.00
	<hr/>
	\$2585.00

Terrapin/Krell Logo system:	
Apple II Plus with 48K bytes of memory	\$1530.00
Apple Language Card	195.00
Disk controller card and one floppy disk	645.00
RF modulator (approximate price)	40.00
Terrapin/Krell Logo	149.95
	<hr/>
	\$2559.95

Disk-based TI Logo system:	
TI-99/4A computer (includes RF modulator)	\$450.00
PHP1200 Peripheral Expansion Box	249.95
PHP1260 Memory Expansion Card	299.95
PHP1240 Disk Controller Card	249.95
PHP1250 Expansion Box Disk Drive	399.95
PHM3040 TI Logo cartridge	129.95
	<hr/>
	\$1779.75

Cassette-based TI Logo system:	
TI-99/4A computer (includes RF modulator)	\$450.00
PHP2200 Memory Expansion	399.95
cassette recorder (approximate price)	50.00
PHM3040 TI Logo cartridge	129.95
	<hr/>
	\$1029.90

Table 2: Comparative prices of Logo systems. The table shows the list prices of Logo systems based on Apple Logo, Terrapin/Krell Logo, TI Logo with a floppy disk, and TI Logo with a cassette recorder, respectively. These comparisons assume that a color television (not included in the prices) will be used for video display.

tain shade of yellow. However, all the other tiles in its group (the letters H through O) will also be changed to that color; photo 4 shows an example of this.

Given that the Apple-based Logos will probably have sprites available, the low cost of a TI-based Logo system is one of its biggest advantages. Table 2 shows the comparative costs of four Logo systems: two Apple-based Logos and two TI-based Logos, one supporting a floppy disk, and one supporting a cassette recorder. Schools wanting to buy multiple Logo systems will be particularly interested in the cassette-based TI Logo systems; however, the low cost of a cassette-based system is offset somewhat by the unending difficulties of working with cassette tapes.

The price advantage of a TI Logo system is impressive—about \$700 be-

tween the Apple-based Logos and a disk-based TI Logo, and over \$1500 between the Apple-based Logos and a cassette-based TI Logo. (The price difference may actually be greater—some dealers discount the TI product line significantly, while it is increasingly difficult to buy Apple IIs at a discount.) In fact, even including the color television sets, you can almost buy two cassette-based TI Logo systems for the price of one Apple-based Logo system. Granted, other factors will influence your decision: the computer (if any) you own, the needs and characteristics of the intended users, and the other intended uses (if any) of the computer.

TI Logo: Problems

Unfortunately, there are several things wrong with TI Logo. Most of these problems won't matter for cer-

Are you looking for a DATA BASE?



THE BEST DATA BASE SYSTEM

GBS

IS READY TO DO **YOUR** JOB

GBS™	\$300
QUICK GEN™	\$125
REPORT GEN™	\$150
MENU GEN™	\$ 75
CONVERT	\$ 60

IF YOU AREN'T A PROGRAMMER . . .

. . . our program generator, **QUICK GEN**, is ready to help you. With **QUICK GEN** almost anyone — even those unsophisticated about computers — may generate powerful business programs. In a short time, you can create a program and a data file that allows an operator, using menu choices, to selectively . . .

review records add records
edit records delete records
update records print out records

QUICK GEN guides you through the following easy steps. When you finish, you will have created a **GBS** program and a data file.

1. Create a screen of labels and headings using a full-screen editor
2. Define data fields, including type and format
3. Position data fields on the display by moving the cursor
4. Write equations that perform calculations on the displayed data

Also of help to the non-programmer is our report generator **REPORT GEN**. With it you may create programs that can produce a wide range of customized reports. Check out these features of **REPORT GEN**:

Complete file printout
Summary printout to your specifications
One line per record, or Multiple lines per record
Print from up to three related files
Compute subtotals and totals

Finally, there is **MENU GEN**. It ties all of your programs together and permits an operator to work exclusively from menus. **QUICK GEN**, **REPORT GEN**, and **MENU GEN** all require **GBS** to operate.

IF YOU ARE A PROGRAMMER . . .

. . . you need **GBS**. It is a powerful, fully programmable, relational database management system. You can access 3 different files simultaneously, and work with as many files as you need within a single program. Use one-to-one, one-to-many, or many-to-one relationships. **GBS** allows data files to span four disk drives. Up to ten indexes may be used simultaneously with each data file, and they are automatically updated when records are added or indexed fields are changed.

GBS uses disk space well by compressing screens and program tables, and by requiring only 24K of disk space to index a data file of 5000 records. When you run applications, **GBS** need not be available on disk, thus freeing often valuable disk space and avoiding tedious overlays of program code.

When you program **GBS**, all the tools are immediately available. You may program and test without requiring an outside editor, assembler, or compiler. Thus, changes may be made and tested in seconds.

You program **GBS** by making table entries using a full screen editor. The tabular structure allows **GBS** to execute your applications and those created using the **GENERATOR** programs extremely rapidly.

You may construct screens with a full screen editor. Later, your programs will display these screens with a single instruction. You may use subroutines to shorten and organize your programs. The fields in a record may be referenced like an array. And for those learning to use **GBS**, there are valuable **HELPS** available on call.

START USING GBS NOW.

GBS is up and running on most popular CP/M* based computers, like those made by Apple, Tandy, Xerox, Sharp, NEC, Osborne, Televideo, Hewlett Packard, Vector, Toshiba, Altos, and more.

If you are now using an older, slower data base management system, you can move up to the power of **GBS** and adapt your current data files with the help of our optional utility **CONVERT**.

You can order **GBS** with confidence because **we guarantee it!** If **GBS** isn't all we say it is, and more, simply return it within 30 days for a full refund. This offer is for a limited time only, so please act immediately. Discuss these terms with your local computer store manager — he may be a participating **GBS** dealer.

Call Today

Contact us today for additional information or to take advantage of our special 30-day Money Back Guarantee.

GBS — it's the best business decision you can make, for today and for the future.

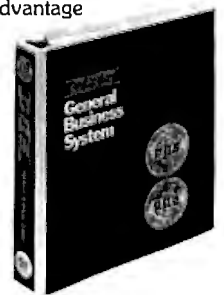

QUALITY SOFTWARE

6660 Reseda Blvd., Suite 107
Reseda, CA 91335 (213) 344-6599

*CP/M is a registered trademark of Digital Research.

tain users, but they will be very important to others. You should ask yourself how important these problems are to you.

One problem I want to mention, keyboard layout, should be attributed to the TI-99/4A computer rather than TI Logo itself; and two others, turtle drawing behavior and slowness of execution, are probably attributable to the computer as well. The poor layout of the TI-99/4 and TI-99/4A keyboards is well known and does not need to be amplified here. The latter keyboard is improved in that it has true typewriter keys instead of button-type keys, but one knowledgeable TI Logo observer says that the TI-99/4A keyboard is more difficult to use for Logo than the TI-99/4's.

In any case, the TI-99/4A keyboard still infuriates anyone with any keyboard skills. (This would be less of a problem for children who do not know how to type, but it would put them at a disadvantage when using other keyboards.) Two often-used

keys, the backspace and double-quotes (") keys, use a poorly placed FCTN key. The FCTN key is below the right shift key; backspace is FCTN-3 and the double-quotes key is FCTN-P. In addition, some FCTN keys that are active within the TI Logo editor are inactive outside it, while others are active in both places. This leads you to try certain FCTN keys to see if they accomplish a given editing task; not only do they not, but they aren't truly inactive, either—they leave funny-shaped graphics characters (FCTN-4, when used outside the editor, is an example of this).

I also blame the slowness of TI Logo (see the section on benchmarks later) on the computer itself, although I am not completely sure of this. All I know is that TI BASIC is also very slow (even though the TI-99/4A uses a 16-bit 9900 processor) and that the machine has a reputation for being slow.

The fact that the TI Logo turtle "runs out of ink" rather quickly is due

to the decision to implement the lines the turtle draws with tiles (see the section labeled "Common Features," page 230). I do not know of any dot-graphics mode available on the TI-99/4A, which leads me to believe that this was the only way to create turtle graphics; the limitation is the fault of the machine itself and not the implementation of TI Logo.

Two other problems with TI Logo concern the language itself. One, some moderately serious problems with the TI Logo printed documentation, will be covered more fully in a later section. The other, integer-only arithmetic, has been mentioned in the "Common Features" section. Being limited to integer arithmetic would not be a disadvantage for simple Logo applications (the beginning Logo programs of children, for instance). Floating-point numbers are often useful, if not necessary, for many fairly simple applications; for example, the Apple-based Logos can draw arcs and circles with greater control because of the availability of floating-point numbers.

TI Logo: Undocumented Features

Through experimentation and conversations with various people in the TI Logo community, I found several Logo commands that are in TI Logo but are not documented. The fundamental list-manipulating commands FPUT and LPUT work, as do several predicate words—NUMBER?, THING?, and WORD? (for definitions, see the words NUMBERP, THINGP, and WORDP in the reference list).

Another command that I was told about and later confirmed, DEBUG, toggles an internal trace mode between on and off states. When the trace mode is on and a procedure is executed, any error condition causes the procedure to pause (rather than simply end) with a prompt telling you what level you are at. You can then execute statements from the keyboard to determine (and perhaps correct) what is wrong, then type CONTINUE to continue execution.

TI Logo: Implementation Errors and Poor Design Decisions

In this section, I am going to cover some of the more serious errors in TI



microShell™ conducts your CP/M™ computer with more power than ever before!

What is MicroShell?

- A normal CP/M program which adds a powerful set of commands to all programs running under CP/M.

What will MicroShell do?

- Automatic Disk and User Management - Finds your programs from another drive or user number - automatically! Save time and precious disk space.
- Powerful Redirection Capability - Send screen output to a file or printer. Send printer output to a file. Take program input from a file instead of the keyboard.
- Much More - Multiple commands on a line, more powerful and faster "submit" capability, user-definable prompt and many more features.

Dealers - MicroShell gives you:

- A user-friendly interface to the computer.
- Automatic execution of an application program at startup.
- Self-running demonstrations of your favorite software packages.

Will MicroShell run on my computer?

- Requires CP/M 2.2. Available on 8" and 5" disks (North Star, Heath, Apple-CP/M, Osborne, SuperBrain and IBM-PC w/Baby Blue).

CP/M - TM Digital Research, UNIX - TM Bell Labs, Wordstar - TM MicroPro, Baby Blue - TM Xedex, dBase - TM Ashton Tate.

Give me some examples!

- Run Wordstar or dBase II from any disk drive or user area.
- Save the screen from a program for later use or to edit into a report. Save printer output in a file.
- Put commands into a file and have MicroShell supply them to the program from the file.
- Change MicroShell's prompt to sound the bell on your terminal when a program is done!

Software Developers - MicroShell gives you:

- A powerful UNIX-like development environment for CP/M with some features that even UNIX doesn't have!
- The Ability to collect the output of a program in a file and ease the documentation chore.

Call or Write Today!

**NEW
GENERATION
SYSTEMS, inc.**

2153 Golf Course Drive
Reston, Virginia 22091
Phone: (703) 478-9143

ORDER LINE 800-368-3359

First, the *IBM Personal Computer*, The Next Step . . .

Tecmar

The **TECMAR** Expansion series is the first and only, complete line of expansion options available for the IBM Personal Computer.

Now totaling over twenty-five separate options, the **TECMAR** series gives you the broadest range of expansion available for your IBM Personal Computer.



SYSTEM EXPANSION with a complete Expansion Chassis providing six additional system slots, a separate power supply and styling that complements the IBM system.

MEMORY EXPANSION in 64K, 128K, 192K and 256K Byte increments of Dynamic RAM with parity, 32K Bytes of Static RAM, 32K Bytes of CMOS RAM with battery backup, or up to 128K Bytes of Read Only Memory.

PRACTICAL EXPANSION with two Serial ports and one Parallel port on a single board, or a Time of Day calendar with battery backup, a Voice Synthesizer with vocabulary in ROM and phoneme speech generation, even a BSR X10™ device controller for lights and appliances.

DISK EXPANSION through the addition of a five or ten megabyte Winchester disk. The disk options come enclosed in the **TECMAR** Expansion Chassis, providing additional expansion slots as well as Winchester disk storage. This approach assures you of unmatched system expandability for nearly any application.

FUNCTIONAL EXPANSION is also available with **TECMAR** Speed Disk™ and print Spooling Software that give new functionality to memory options.

UNMATCHED EXPANSION for the serious IBM Personal Computer user through these and the many other **TECMAR** Expansion products available through participating **COMPUTERLAND** stores, and other fine computer retailers nationwide.

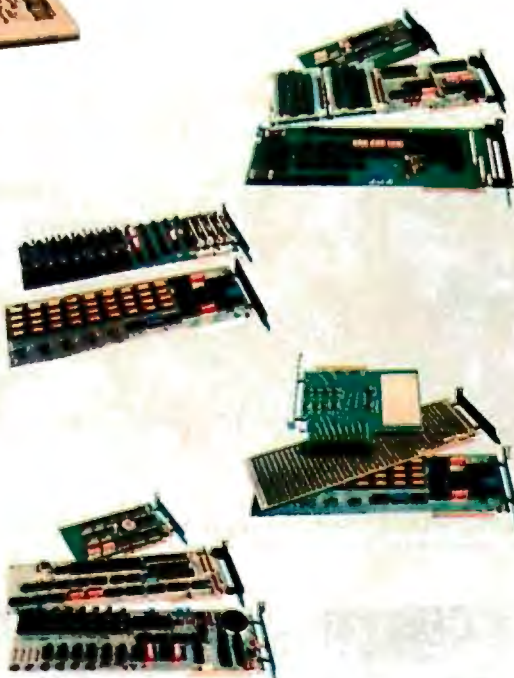

LABORATORY/INDUSTRIAL EXPANSION through an IEEE 488 interface, the Lab Tender with an 8 bit A/D and D/A, or the Lab Master for 12 bit A/D and D/A, a two axis Stepper Motor Controller, or the Parallel Digital-In/Digital-Out Base Board™, Video Digitization with Video VanGogh™.

DEVELOPMENT EXPANSION using an E+EEPROM programmer, Protozoa prototyping boards or a **TECMAR** Extender card.

NEW PRODUCTS are currently under development with many soon to be announced. At present shipping 26 unique IBM add-on products, we are still looking for needs to meet. If you have an need for a new product for the IBM Personal Computer, and would like to ask us about it, give a call on our Product Input Hotline at (216) 464-8317.

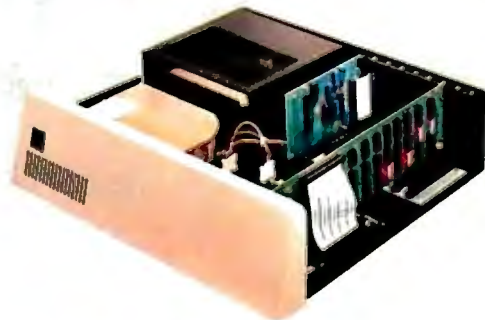

For IBM Personal Computer Expansion, TAKE THE NEXT STEP . . .

Tecmar Inc.

Circle 398 on inquiry card.

PERSONAL COMPUTER PRODUCTS DIVISION
23600 Mercantile Road, Cleveland, Ohio 44122
Telephone: (216) 464-7410 Telex: 241735

Listing 4: Two memory-filling procedures. FILLMEMORY fills memory by creating an infinitely nesting procedure that prints out its current depth. FILLPROC creates short empty procedures of equal length under program control. Listing 4a shows the version used by Terrapin/Krell Logo, while listing 4b shows the version used by TI Logo. The procedure MAKEQQ must be executed once before the TI Logo memory-filling procedures will work.

(4a)

```
TO FILLMEMORY :N
  PRINT1 [AT LEVEL] PRINT :N
  FILLMEMORY :N + 1
  PRINT1 [SECOND TIME AT LEVEL] PRINT :N
END
```

```
TO FILLPROC :N
  PRINT1 [AT LEVEL] PRINT :N
  MAKE "PROCNAME WORD "P :N
  DEFINE :PROCNAME [[]]
  FILLPROC :N + 1
END
```

(4b)

```
TO MAKEQQ
  MAKE "QQ "1234567890ABCDEFGHIJKLMNPOQRSTUVWXYZ
END
```

```
TO FILLMEMORY :N
  TYPE [AT LEVEL] PRINT :N
  FILLMEMORY :N + 1
  TYPE [SECOND TIME AT LEVEL] PRINT :N
END
```

```
TO PICK :N :WORD
  IF :N = 1 THEN OUTPUT FIRST :WORD
  OUTPUT PICK :N - 1 BUTFIRST :WORD
END
```

```
TO FILLPROC :N
  TYPE [AT LEVEL] PRINT :N
  MAKE "PROCNAME WORD "P PICK :N :QQ
  DEFINE :PROCNAME [[]]
  FILLPROC :N + 1
END
```

Logo itself. Some of these can be called *poor design decisions*—in other words, the people who designed TI Logo decided to implement a feature in a way that resulted in an awkward situation that could have been averted. At least one of these is an *implementation error*—a “bug” in the program that shouldn’t be there. Several errors that I discuss below could be called either poor design decisions or implementation errors, depending on your point of view.

The word/number dichotomy: TI Logo regards words and numbers as noninterchangeable items (in the Apple-based Logos, numbers *are* words). This changes the behavior of several Logo words. For example, the Apple-based Logo will behave as follows:

```
MAKE "NUM1 14
(make NUM1 equal to 14)
MAKE "VAR1 WORD "XXX :NUM1
(make VAR1 equal to the string XXX
followed by the value of NUM1)
PRINT :VAR1
(print the value of VAR1)
XXX14
```

However, TI Logo will not do this. Instead, it returns the message:

```
WORD DOESN'T LIKE 14 AS INPUT
```



**Saturn Navigator
now A2-3D1 licensed!**

Yes, SubLOGIC's A2-3DA Saturn Navigator is now available as a complete package, incorporating all of the graphic routines necessary for a successful flight from earth to Saturn. If you've been looking for a realistic 3D space flight simulation, this is the one for you. / For the Apple II plus or Apple II with Applesoft ROM. 48K. \$34.95.

See your dealer!

subLOGIC
Communications Corp.
713 Edgebrook Drive
Champaign, IL 61820
(217) 359-8482

*Apple is the registered trademark of Apple Computer Inc.

People can be trained to know how computers work. But we've trained QDP to know how people work.

Wed, Jun 30, 1982

11:56 AM

QDP COMPUTER SYSTEMS

SYSTEM UTILITIES

CP - COPY PROGRAM
 CD - RECONFIGURE SYSTEM
 ST - SYSTEM STATUS REPORT
 MM - MAP OF MEMORY USE
 ID - INITIALIZE DISKETTE

BUSINESS APPLICATIONS

AR - ACCOUNTS RECEIVABLE
 AP - ACCOUNTS PAYABLE
 PR - PAYROLL
 IN - INVENTORY
 GL - GENERAL LEDGER

WORD PROCESSING

WP - WORD PROCESSOR
 SP - SPELLING DICTIONARY
 MP - MAILING PROGRAM

UTILITIES & MENUES

HE - HELP PROGRAM
 TT - SET DATE & TIME
 BH - BACKUP HARD DISK
 RH - RESTORE HARD DISK
 CH - COMMUNICATIONS
 M2 - MENU # 2

FINANCIAL MENU

FM - FINANCIAL MODELING

Enter Selection:



QDP 100H
 10 MB (Formatted)
 HARD DISK

QDP 100
 2.4 MB (Formatted)
 FLOPPY

Introducing QDP's "user-friendly" computer system.

And other new QDP simplicities that make QDP easiest to sell, install, and use.

Simply pressing one key will start the user off right with QDP. Up comes a user-friendly menu (now standard on all QDP computers) and even untrained operators have access to the full power of QDP to do whatever job they select. Users never have to see QDP's operating system.

If help is needed to understand a QDP program or system function, QDP has an on-line "HELP" system. Ask for help, and QDP delivers definitions, examples, documentation and explanations. New items? Add them to QDP's user-library function.

Our software warns users of many impending problems before they happen. A built-in SYSTEM STATUS program monitors performance of the electronics and drive systems. This way QDP helps

assure a profit-generating reliable system that has all these features as standard equipment:

- One-year, on-site warranty service performed by the Installation & Service Engineering Division of General Electric Company—with more than 50 service locations nationwide.
- Proprietary "caché memory" system which makes QDP one of the fastest microcomputers available today.
- Unique system configuration program that allows users to easily modify operating system parameters via a menu-driven program.
- Best user-friendly implementation of a CP/M compatible operating system on the market — competitors, after two years, are finally trying to catch up.

- Z80 (4-6 MHZ), IEEE 696 (S-100) — CP/M, MP/M compatible operating system.

- CBASIC language.

- Excellent user documentation and reference manuals.

And these options:

- Multi-user timesharing systems.
 - Hard Disk sub systems.
 - Memory disk to allow from 64K to 2MB of silicon memory to be accessed as a disk drive for extremely fast disk operations.
 - Software Languages: COBOL, FORTRAN, C, PASCAL, and Microsoft BASIC.
 - 16 bit version available this fall.
- Write or call for complete information.

CBASIC, CP/M and MP/M are registered trademarks of Digital Research Corp.
 Z80 is a registered trademark of Zilog Corp.



Quasar Data Products

10330 Brecksville Road, Cleveland, Ohio 44141
 216/526-0838 Telex 241596

Circle 343 on Inquiry card.

The 9600 BAUD MODEM For \$315.
**INTRODUCING
THE LCM100***

FLEXIBLE.

The LCM 100 goes wherever you want it to go, because it eliminates the use of expensive RS-232 cables between your computer and other data communication equipment at up to 9600 BAUD, while utilizing in-place power lines on site.

ECONOMICAL.

The LCM 100 saves you money, as a result, because you can put the terminal where it's needed, quickly and efficiently.

EFFICIENT.

The LCM 100 goes where the action is, so instead of tearing up an office, and the staff, to make room for cables and construction, all you do

is plug it in and it is ready to go to work. No muss. No fuss.

RESPONSIVE.

The LCM 100 is ready to expand, when you are. Just un-plug it, move it to its new location, and a new

communications link is operational. Simple. Easy. Cost effective.

INVENTORY CONSCIOUS.

The LCM 100 is so versatile, you probably won't need as many terminals as you had planned. You can move it easily, use it anywhere you want and match the job to the person quickly. It will just seem as if you have lots more on-the-job.

PEACEFUL.

Enjoy the sound of silence, with the chattering computer and the patter of the printer tucked away in a closet somewhere. Your staff will appreciate the reduction of noise pollution, more than likely with a significant increase in productivity.

COMPUTER SITE TERMINAL SITE

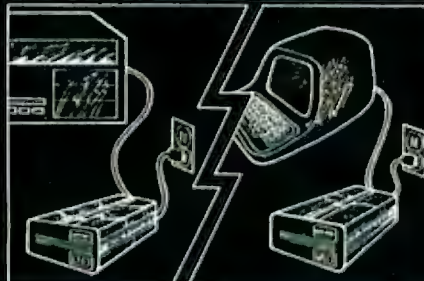

*Line Carrier Modem



**THE LCM-100:
WHAT EVERY OFFICE WILL BE USING TOMORROW.
PUT THE FUTURE IN YOURS TODAY!**

DEALER INQUIRIES INVITED, ASK ABOUT OUR
SPECIAL DEALER PACKAGE, ORDERS AND
INQUIRIES CALL 1-800-426-8075 ALASKA,
HAWAII AND WASHINGTON STATE CALL COLLECT



COMMUNICATIONS RESEARCH CORPORATION
1720-130TH AVENUE N.E. BELLEVUE, WASHINGTON 98005 (206) 881-9550
A SUBSIDIARY OF ENERGY SCIENCES CORPORATION

Several TI Logo commands—WORD, FIRST, BUTFIRST, LAST, and BUTLAST—behave as shown above. This causes a lot of problems when you are trying to create words during program execution. In the benchmark program FILLPROC, I wanted to create a series of procedures, P1, P2, P3, and so on. I did this easily in the Apple-based Logos (see listing 4a), but I had to create the procedure names differently in the TI Logo version (listing 4b).

A "hole" in the instruction set: The TI Logo version of the FILLPROC procedure is also different from the Apple-based Logo versions in that TI Logo has a "hole" in its instruction set. Like the Apple versions, TI Logo has a command to convert a character to its numeric equivalent (CHARNUM in TI Logo), but (unlike the Apple versions' CHAR) there is no command to convert a number to its character equivalent. If there had been, I could have replaced the phrase

```
WORD "P PICK :N :QQ
```

in the TI Logo version with the phrase

```
WORD "P CHAR :N
```

and deleted the procedure PICK and the variable QQ.

An unexplained irregularity in the evaluation of Logo phrases: Another design decision is an odd algorithm for evaluating Logo phrases. This results in a bug I found when transferring the STR.GR.THAN procedure (see listing 2) from Terrapin/Krell Logo to TI Logo. Using a slightly different example, the Apple-based Logos had no problem with the phrase

```
PRINT ASCII "B > ASCII "A
TRUE
```

The TI Logo version (which uses CHARNUM in place of ASCII) acts as follows:

```
PRINT CHARNUM "B > CHARNUM "A
>DOESN'T LIKE B AS INPUT
```

After some experimentation, I found that TI Logo returns the correct value of TRUE given the command

```
PRINT (CHARNUM "B ) >
CHARNUM "A
```

It seems that TI Logo scans an expression from right to left (which is okay in itself) and evaluates CHARNUM "A to a value of 66. It then tries to make the comparison "B > 66 and returns the above error message. The parentheses in the corrected version force the evaluation of CHARNUM "B before the greater-than comparison is made. I am at a loss to explain why this happens. At first, I thought TI Logo evaluates expressions strictly right to left without any idea of

operator precedence, but several experiments with the arithmetic operators FIRST, BUTFIRST, and WORD showed that TI Logo *does* evaluate certain operations before others.

Now we get to a realm in which the problems can be blamed on either poor design decisions or implementation errors. I think they are outright errors because they are different from the internal models I (and most people) have of Logo. Another reason for calling them errors is that they are not pointed out in the documentation.

Our New 2000 Series Solves Them...5 Ways!

1. EASE OF DATA ENTRY

Enter data into your personal computer by simply marking standard cards with a pencil. No special training needed. The 2000 Series even reads pre-printed data and punched holes.

2. USER FRIENDLY DESIGN

The 2000 comes with 2 different interfaces: an intelligent interface for the Apple and an RS-232C. Both models simplify user software by converting card data easily to one of 4 different modes, or any combination of them: ASCII, Card Image, Quick Program and Self Programming. Makes your programming tasks quick and easy.

3. AUTOMATIC FEED

The 2000 Series reads up to 60 cards per minute, automatically! Just load the feeder tray and the 2000 does the rest. Cards can vary in length from 5 to 12 inches, and each one can contain up to 128 columns of data.

4. LOW COST

The cost, including a choice of interfaces, is only \$1595. Compare that to keypunch or computer terminals, plus the expense of operating them.

5. RELIABLE OPTICAL SENSOR

State-of-the-art fibre optics "read" each card reliably and accurately, with a single, long-lasting bulb providing the light source.

So, to quickly solve your data entry problems, put in your order now for a new 2000 Series. It's ideal for education, medical, business, and a host of other computer applications.

And remember... whatever your needs, Chatsworth Data still offers the industry's largest selection of card readers. Write or phone for complete details...today!



20710 Lassen Street Chatsworth, California 91311 Phone: (213) 341-9200

You can count on—
MICRO Express

apple computer

Hayes Micromodem II	\$ 289
Z80 Card Microsoft	\$ 298
16K RAM Card	\$ 99
Enhancer II	\$ 124
Videx 80 Col. Card	\$ 265
Station II	\$ 105
MicroScl Drive	\$ 399

SOFTWARE

Visicalc.	\$ 199
Visifile.	\$ 215
Visidex	\$ 199
Visiplot	\$ 175
Visitrend.	\$ 245
Desktop Plan II	\$ 199
BPI Accounting	\$ 299
Wordstar.	\$ 269
DB Master	\$ 159
Easywriter	\$ 129
Datadex	\$ 135

ATARI

Atari 800, 16K.	\$ 679
Atari400, 16K.	\$ 329
Other Atari products	CALL

NEC

PC-8001 A Computer.	\$ 799
PC-8012A I/O.	\$ 495
PC-8031 A Disk Drives.	\$ 799

• **MONITORS** •

Zenith, Green.	\$ 115
NEC, Green	\$ 175
NEC, Color.	\$ 349
AMDEK, RGB Color.	\$ 750

• **PRINTERS** •

MX 80.	\$ 450
MX 100.	\$ 750
NEC 8023	\$ 525
Diablo 630	\$2299

• **CORVUS** •

5 MB Hard Disk.	\$2595
10 MB Hard Disk.	\$4345
20 MB Hard Disk.	\$5245

TCS ACCOUNTING SOFTWARE

GL, AR, AP, Payroll8", CP/M	\$69EA
ALL 4	\$ 235
Inventory, 8" CP/M.	\$ 199

TOP QUALITY ATHANA DISKETTES

5" SS/SD	\$2.15
5" SS/DD	\$2.30
5" DS/DD	\$2.99
5" DS/SD	\$2.50
8" SS/SD	\$3.19
8" SS/DD	\$3.30
8" DS/DD	\$3.30

Hard pack & bulk available. 100% Guaranteed!

Dealer Inquiries Invited

Price includes 3% cash, prepaid discount. Money Orders or Cashier Checks. Personal checks allow 3 weeks to clear. We accept VISA & Master Charge. NO COD. Prices subject to change. Calif. residents add appropriate sales tax. FREE DELIVERY ON PREPAID ORDERS.

MAIL ORDER SALES

MICRO Express

P.O. Box 21418
San Jose, CA 95151-1418
408-274-1217

You find out about them when programs don't work, and it takes a long time to find the error because your internal model of Logo behavior suggests you look elsewhere for the error.

The absence of an empty string: I found this decision/error while debugging the TI Logo version of the procedure STR.GR.THAN, which determines whether one string is alphabetically greater than another (see listing 2). The procedure is recursive, and one ending condition is the empty string—a string (word) with zero characters in it. In other words, the Apple-based Logos work like this:

```
MAKE "STRING "AD
(makes the variable STRING equal to AD)
PRINT :STRING
AD
(print the value of STRING)
MAKE "STRING BUTFIRST :STRING
(make the variable STRING equal to all the characters but the first of the value of STRING)
PRINT :STRING
D
(STRING is now one character long)
MAKE "STRING BUTFIRST :STRING
PRINT :STRING
```

(nothing is printed because STRING is zero characters long)
PRINT :STRING = "
(is the value of STRING the empty string?)
TRUE
(yes, it is)

TI Logo works the same as above, with the following exception:

```
PRINT :STRING
(we're starting in the middle here)
D
(the current value of STRING)
MAKE "STRING BUTFIRST :STRING
PRINT :STRING
D
(what's wrong here?)
PRINT :STRING = "D
TRUE
PRINT (BUTFIRST "D ) = "D
TRUE
(BUTFIRST of a single-letter word is the word itself!)
```

TI Logo string-manipulating procedures have to be written with the knowledge in mind that BUTFIRST of a single-character word is the word itself. Unfortunately, the documenta-

tion doesn't tell you anything about this. Is this an implementation error or a poor design decision? You tell me.

The odd behavior of numbers enclosed by brackets: Another decision/error is that TI Logo, unlike the Apple-based Logos, incorrectly parses lists that include negative numbers. Apple Logo does the following:

```
PRINT FIRST [-2 4 -3]
-2
PRINT LAST [-2 4 -3]
-3
```

TI Logo does the following:

```
PRINT FIRST [-2 4 -3]
-
PRINT LAST [-2 4 -3]
3
```

Again, you have to know about this kind of behavior before you program in TI Logo, and it's not documented in the reference material. What's more, this situation makes programming in TI Logo more difficult. To create a list with negative numbers in it, you have to use the commands SENTENCE, FPUT, and LPUT and place the negative numbers inside parentheses:

```
MAKE "NUMLIST (SENTENCE
(-2) 4 (-3))
PRINT :NUMLIST
-2 4 -3
PRINT FIRST :NUMLIST
-2
```

Problems with the TI Logo editor: One of the things I don't like about the TI Logo editor (the same applies to the sprite- and tile-making procedures) is that there is no way to exit the editor while leaving the procedure as it was before editing started. The Apple-based Logos have this ability (Control-C to exit with the changed procedure, Control-G to exit with the unchanged procedure), but TI Logo has one key only—the Back key. The contents of the editor at that time, like it or not, become the definition of that procedure.

Two other undocumented problems in the TI Logo editor may cause you to make errors. First, if you hit the Back key and the procedure being

THE PRICE SLASHER!

PRINTERS

OKIDATA 80A	\$ 360
OKIDATA 82A	539
OKIDATA 83A	749
OKIDATA 84	1,099
OKIDATA 84S	1,149
EPSON MX70	349
EPSON MX80	470
EPSON MX80FT	569
EPSON MX100FT	729
NEC 3510/3530	1,750
NEC 7710/7730	2,350
NEC 8023 W/TRACTORS	589
DIABLO 630	1,995
ANADIX 9501	1,295
IDS PRISM	CALL

MONITORS/TERMINALS

AMDEK 12" GREEN	\$ 169
AMDEK 13" COLOR	379
AMDEK COLOR II	769
TELEVIDEO 910	575
TELEVIDEO 912	695
TELEVIDEO 925	729
TELEVIDEO 950	925
NEC 12" COLOR	325

MODEMS

NOVATION CAT	\$ 145
NOVATION D CAT	155
NOVATION AUTO CAT	209
NOVATION APPLE CAT	299

ACCESSORIES

*16 K MEMORY CARD	\$ 75
*32 K MEMORY CARD	139
*16/32 EXPANDABLE MEMORY CARD	119
*UPPER/LOWER CASE ROM	19
*SERIAL I/O CARD	99
*PARALLEL INTERFACE CARD	69
*PROM-IT™ EPROM	99
EPSON RS 232 INTERFACE BOARD	64
EPSON RS 232 INTERFACE W/2K	98
EPSON IEEE 488 INTERFACE BOARD	49
EPSON TS 80 EXP INTERFACE CABLE	29
*TYMAC PARALLEL INTERFACE W/GRAPH	99
*GRAPPLER PARALLEL INTERFACE W/GRAPH	125
OKIGRAPH OPTION FOR 82A/83A	69
GRAFTRAC II	69
*Z 80 SOFTCARD BY MICROSOFT	289

Note: *for APPLE

DISKETTES (per box of 10)

MAXELL 8" SS-SD	\$ 40
MAXELL 5-1/4" SS-SD	31
3M 8" SS-SD	31
3M 5-1/4" SS-SD	29

FREE CATALOG



mail
comp

APPLE® SOFTWARE

VISICALC	\$ 185
VISIFILE	185
VISIPILOT	155
VISITREND/VISIPILOT	225
VISITERM	75
VISIDEX	185
VISISCHEDULE	235
DESK TOP PLAN II	185
VISIPACK	549
*WORDSTAR	195
*SPELLSTAR	125
*DATASTAR	192
*MAILMERGE	80
*SUPERSORT	125
*CALCSTAR	129
OLYMPIC DECATHALON	25
BASIC COMPILER	315
FORTRAN 80	165
COBOL 80	595
TASC	159
SELECT W P BY SELECT	359
SUPERCALC BY SORCIM	195

Note: *Requires Z80 Card by Microsoft

CP/M® SOFTWARE

SUPERCALC BY SORCIM	\$ 195
WORDSTAR	289
CALCSTAR	189
DATASTAR	225
SUPERSORT	169
MAILMERGE	80
SPELLSTAR	149
BASIC 80	299
BASIC COMPILER	319
COBOL 80	595
FORTRAN 80	369
MACRO 80	169
mv/MATH/mv/SIMP 80	219
mv/LISP/mv/STAR 80	175
PL/1-80 BY DIGITAL RESEARCH	435
ACCOUNTING PLUS	CALL

XEROX 820	CALL
ALTOS 8000-2	20% OFF

Note: *Apple is a registered trademark of Apple Computer, Inc.
*CP/M is a registered trademark of Digital Research.

HOW TO ORDER

We accept phone orders using Visa/Mastercard (add 2% service charge), Bank Wire Transfer, Cashier's or Certified Check, Money Order, or Personal Check (allow ten days to clear). Unless prepaid with cash, please add 3% for shipping, handling and insurance (minimum \$5.00). California residents add 6% sales tax. We accept CODs. All equipment is new and complete with manufacturer's warranty. PLUS, we guarantee everything for 30 days. If anything is wrong, return it and we'll make it right. And, of course, we'll pay the shipping charges. All equipment is subject to price change and availability, without notice.

Mailcomp, Inc.
8380 Miramar Road, Suite 200
San Diego, CA 92126
Call Collect: 714-578-1033

THE ULTIMATE CORDLESS PHONE

- Have you ever felt "tied down" to the phone in your office, or at home . . . expecting that important call?
- How many times have you made a mad dash for the phone . . . only to find it's stopped ringing?
- And what about those occasions when you were simply too far away to hear it ring?

Compare Our Price and Quality

Only \$189⁰⁰

(includes shipping & insurance)

INTERSTATE PHONE REMOVES THE CORD

. . . and you have **freedom of phone movement** like never before! Your phone goes where you go! Take it from room to room — anywhere in your office. Take a break in the patio, pool or garden. Work way out in the garage, basement or driveway. The Interstate Phone is there at your side.

EXTENDED RANGE

Here is truly the ultimate in cordless phones. The Interstate Phone has unbelievable sound fidelity - with an extended range of up to 600 feet. The entire unit — 10.5 ounces — attaches lightly and easily to a belt, or slips into a pocket. Yet you can receive or place calls to any corner of the world.

YOU OWN IT

The Interstate Phone is wholly independent of the phone company. Even its installation. FCC registered and U.S. Government approved for direct connection to any existing phone jack. Installation and monthly charges are eliminated.

STILL MORE FEATURES

The Interstate Phone unit includes everything you need: Phone • base station • compatibility with all rotary or pushbutton systems • easy installation with standard phonejacks.



MEMORY SYSTEM

The last number called is stored in the memory and is **automatically redialed** — just push **one** button - great to reach forever busy numbers — saves redialing a string of codes.

BATTERY RECHARGING CORD

Still another Interstate Phone **exclusive!** A great new way to keep your phone charged — with no need to return it to its base unit. A **charge cord** is provided, to plug into any AC outlet in the house. Which means the base can be tucked permanently out of sight AND the phone is anywhere you want it — being charged.

GUARANTEE satisfaction is completely guaranteed! Use the Interstate Phone for 15 days in your office, or home. Not pleased? You owe nothing — not even an explanation. Just return for complete, prompt refund. Please note: Equipment used for business purposes is tax deductible. You have everything to gain, and nothing to lose (in fact, you'll wonder how you ever got along without one).

YES The Cordless telephone is the sound answer for me
Please send me _____ units at only \$189.00 each
(California residents, please add 6% sales tax)
Total \$ _____ enclosed.

NAME _____

ADDRESS _____

CITY _____ STATE _____ ZIP _____

SEND TO: INTERSTATE TELEPHONE
18210 Sherman Way, Reseda, Ca 91335

edited doesn't end with an END statement, TI Logo returns to the main Logo screen with a different prompt, a ">" instead of a "?", and you are still defining the procedure. Whatever you type at the keyboard (until you type an END statement) will be added to the definition of the procedure you thought you had finished. Of course, this causes some interesting errors when you try to execute the procedure. (In TI's defense, I must point out that each new procedure is automatically given an END statement when it is first edited; however, it is possible to erase the END statement during editing.)

The second problem occurs if you type in the dummy arguments when you begin editing a new procedure. For example, if you type in

```
TO ADDTWO :NUM1 :NUM2
```

from the main Logo screen, you are placed in the editor with the following information already there:

```
TO ADDTWO  
END
```

The TI Logo editor ignores the two dummy arguments, :NUM1 and :NUM2. If you define ADDTWO not realizing that it has no arguments, you will certainly get a confusing error message when you try to execute it.

A TI Logo system error: The last thing I have to report is definitely an implementation error; it occurs when you run the procedure FILLPROC (see listing 4b). The Apple-based Logos stop and report an error message when the memory space is full. TI Logo behavior is erratic. Sometimes it sends the extremely appropriate message CHOKED! and the TI Logo crashes—it does not respond to keyboard input, and the computer has to be turned off and on again. Other times it crashes without the CHOKED! message or (correctly) returns with the message OUT OF SPACE AT LEVEL 57, LINE 2 OF PICK. (I have been told that the CHOKED! message occurs only when the workspace is full and TI Logo can't find enough free memory to print the error message.)

Again, I want to say that these

One of the great masters?

Although the Datasouth DS180 matrix printer may not exactly rate as a work of art, our customers have a *very* high opinion of its value. Over the past year, we have shipped thousands of DS180 printers to customers throughout the world. Many of our sales now come in the form of repeat business—a strong testimonial to the acceptance of a product.

The success of the DS180 in a very competitive market did not happen by accident; rather through our sensitivity to the needs of the industry. This sensitivity we carry through research and development, production and quality control and finally, to after sales support and service.

Recently we introduced new enhancements to make the DS180 printer even more versatile. Dot addressable raster scan graphics produces output of computer generated charts, maps and graphs at a resolution of 75 x 72 dots per inch. Variable horizontal pitch selection allows printing at 10, 12 or 16.5 characters per inch plus double wide printing at 5, 6 or 8.25 characters per inch. The expanded 2K FIFO print buffer handles a full CRT screen dump at up to 9600 baud without delaying the host system. We also offer transparent mode for isolating communications problems, and for APL users, the dual ASCII/APL character set option.

Check our list of features and we think you will agree that the DS180 offers the most complete performance package in matrix printers.

DS180 PRINTER STANDARD FEATURES

- Microprocessor Control
- 180 CPS Print Speed
- Bidirectional Logic Seeking
- 1000 Character Buffer (Expandable)
- 9x7 Dot Matrix
- Expanded Characters
- Adjustable Printhead: 1-6 Copies
- 96 ASCII Character Set
- Cartridge Ribbon
- 132 Column Print Width
- Tractor Feed (Front or Bottom)
- Non Volatile Format Retention
- Top of Form
- Horizontal Tabs
- Vertical Tabs
- Perforation Skip Over
- Auto Line Feed
- 6/8 LPI
- Auto End of Line Carriage Return
- 5 IPS Paper Slow
- Parallel and Serial Interfaces
- 110-9600 Baud Communications
- Terminal Status Indicators
- Audio Alarm
- Self Test
- X-on, X-off
- Paper Out Detection

OPTIONAL FEATURES

- Compressed Print—10, 12, 16.5 cpi
- High Resolution Dot—Addressable Graphics
- 2k Expanded Print Buffer
- APL ASCII Character Set



The DS180 is available nationwide through our network of sales/service distributors.

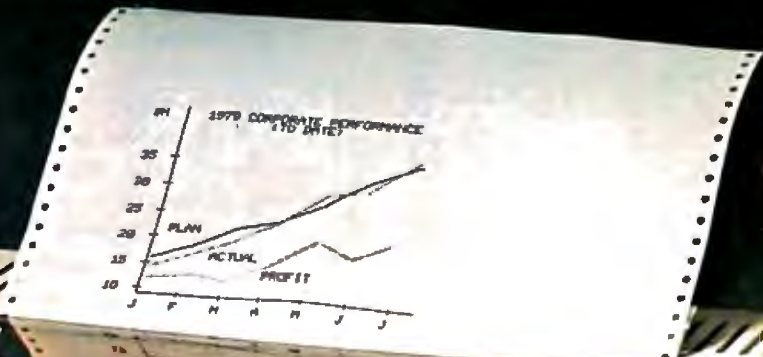

Now Available Nationwide Through Participating COMPUTERLAND Stores



Circle 136 on Inquiry card.

datasouth
computer corporation
 P.O. Box 240947 • Charlotte, NC 28224 • 704/523-8500

Call for MTI's late price reductions.

Ask about our "QED" discounts.
VISA and MasterCard orders accepted.

	MTI Price
VIDEO TERMINALS	
VT100 DECscope	\$ 1595
VT 18X Computing option	2395
VT101 DECscope	1215
VT 131 DECscope	1785
VT 132 DECscope	1995
ADM 3A (dumb terminal)	595
ADM 5 (dumb with visual attributes) ..	645
ADM 31 (two page buffer)	1095
ADM 21, 24, 32, 36, 42	*
Hazeltine Esprit	645
Hazeltine Executive 80 Model 20	1495
Hazeltine Executive 80 Model 30	1715
1410 (Hazeltine dumb terminal)	575
1421 (Consul 580 & ADM 3A comp.) ..	595
1500 (dumb terminal)	825
1520 (buffered, printer port)	1105
RETRO-GRAPHICS TERMINALS	
VT 100 with graphics pkg.	3250
VT 125 (DEC graphics)	3280
ADM 3A with graphics pkg.	1795
ADM 5 with graphics pkg.	1845
300 BAUD TELEPRINTERS	
LA 34-AA DECwriter IV	1095
LA 36 DECwriter II	1095
Diablo 630 RO	2295
Diablo 630 KSR	2695
Diablo 1650 KSR	2635
TI 743 (portable)	1190
TI 745 (port/built-in coupler)	1485
TI 765 (port/bubble/b.i. coupler)	2595
600 BAUD TELEPRINTERS	
Epson MX-80	645
TI 825 KSR impact	1570
TI 825 KSR pkg.	1795
1200 BAUD TELEPRINTERS	
Epson MX-100	995
LA 120 RA (receive only)	2095
LA 120 AA DECwriter III	2295
TI 783 (portable)	1645
TI 785 (port/built-in coupler)	2270
TI 787 (port/internal modem)	2595
TI 810 RO impact	1545
TI 810 RO pkg.	1795
TI 820 RO impact	1850
TI 820 RO pkg.	2025
TI 820 KSR impact	2025
TI 820 KSR pkg.	2195
Lear Siegler 310 ballistic	1945
2400 BAUD	
Dataproducts M200 (2400 baud)	2910
DATAPRODUCTS LINE PRINTERS	
8300 (300 LPM band)	5455
8600 (600 LPM band)	6930
81000 (1000 LPM band)	11330
8P1500 (1500 LPM band)	19700
ACOUSTIC COUPLERS	
A/J A242-A (300 baud orig.)	242
A/J 247 (300 baud orig.)	315
Vadic VA 3413 (300/1200 orig.)	845
Vadic VA 3434 (1200 baud orig.)	845
MODEMS	
GDC 103A3 (300 baud Bell)	395
GDC 2025/T (1200 baud Bell)	565
VA 3212 (Bell 212A comp.)	825
VA 103 (300 baud modemphone)	235
VA 3451 (orig/ans triple modem)	885
VA 3455 (1200 baud orig/ans.)	770
VA 2450 (Bell 201 comp.)	725
CASSETTE STORAGE SYSTEMS	
Techtran 816 (store/forward)	735
Techtran 817 (store/for/speed up)	915
Techtran 818 (editing)	1225
Techtran 822 (dual)	1640
FLOPPY DISK SYSTEMS	
Techtran 950 (store/forward)	1395
Techtran 951 (editing)	1995

* Please call for quote.



Applications Specialists & Distributors
Computer Terminals, Peripherals & Systems

New York:
516/621-6200, 212/767-0677, 518/449-5959
Outside N. Y. S.: 800/645-6530
New Jersey: 201/227-5552
Ohio: 216/464-6688

poor design decisions and implementation errors may or may not be important to your application; for example, many simple applications will not do any string or list manipulation. Also, the price differential between a TI Logo and an Apple-based Logo system may make you willing to work around the idiosyncrasies of the TI Logo system.

TI Logo: Perspective

Before I finished this article, I talked with Mr. Donald P. Bynum, Division Manager of the Personal Computer Division of Texas Instruments. He was very receptive to the criticisms I made, and he told me how TI is improving its Logo. He was aware of the documentation problem and said that TI was in the process of writing a more complete tutorial book about TI Logo that would be supplied with later versions of the product. In addition, TI is publishing a book/software combination called the *TI Logo Curriculum Guide*, which should be available separately by the time you read this. The price of this product is steep (\$49.95), but it contains extensive teacher-oriented material on using Logo at various grade levels as well as a disk and two cassettes of Logo programs for pre-school children. The book also contains an 84-page appendix called the *TI Logo Reference Guide*, which fully explains each TI Logo command and gives an example of its use. This reference guide may later be available separately.

Mr. Bynum also told me about a second version of TI Logo that will be available before the end of the year. This version will include such enhancements as music capability, double-size sprites, a workspace almost twice as large as that of the first version, more extensive documentation, and the ability to print procedures via the RS-232C port. In addition, the new version will no longer "hang up" when it runs out of workspace, and BUTFIRST of a single-letter word will be an empty word. (All other criticisms given here will still be valid.) These improvements will correct many of the current faults of TI Logo.

Listing 5: Examples of error messages in three versions of Logo. Listings 5a, 5b, and 5c show the error messages for identical errors made in Apple Logo, Terrapin/Krell Logo, and TI Logo during execution of the FILLMEMORY procedure (see listings 4a and 4b).

(5a)

Apple Logo:
OUT OF SPACE IN FILLMEMORY
FILLMEMORY :N + 1

(5b)

Terrapin/Krell Logo:
NO STORAGE LEFTI, IN LINE
PRINT1 (AT LEVEL) PRINT :N
AT LEVEL 114 OF FILLMEMORY

(5c)

TI Logo
OUT OF SPACE
AT LEVEL 46 LINE 1 OF FILLMEMORY

Error Handling

One of the most impressive things about all five Logos is the clarity of their error messages. Unlike the usual vague or cryptic error messages (like SYNTAX ERROR or OM ERROR or ERROR 24), the Logos give you messages like *TELL ME HOW TO xxxx* (when you try to execute an undefined procedure), *YOU TRIED TO DIVIDE BY ZERO, FILE IS THE WRONG TYPE*, and *xxxx DOESN'T LIKE yyyy AS INPUT*. Such error messages are made easier by the interpreted nature of Logo (compiled languages usually give less specific error messages). People used to working with computers can get by with poorer error messages, but good error messages are especially important in systems that will be used by beginners and nontechnical people.

However, the Logo systems give different levels of information with the error messages. I created the same error situations in the Apple- and TI-based Logos and recorded the error messages given; see listing 5. Terrapin/Krell Logo gives more detailed error messages than Apple Logo (again, a reflection of the intended user). TI Logo error messages are

Microcomputer Business Industries Corporation

presents

Two Practical Peripherals For Your Apple™ II

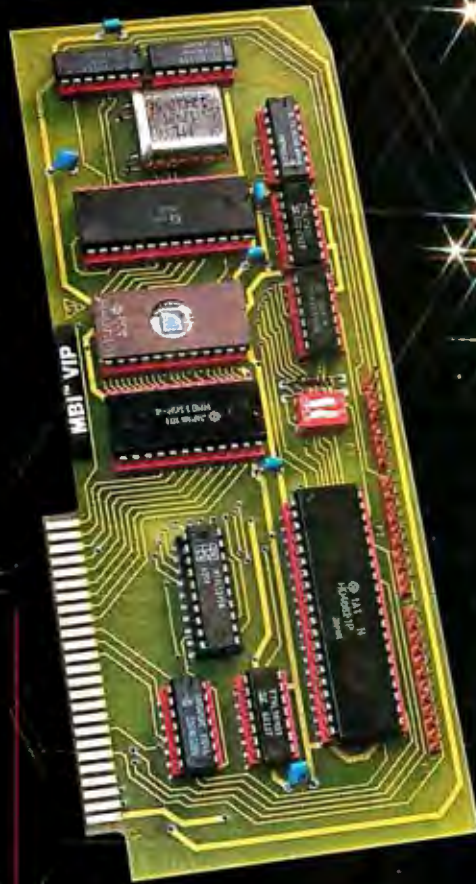

*Recommended
Retail Price

Appletime™ Clock Card

\$9900*

- Fully Mountain Computer Software compatible
- Disk included with all software
- Includes Datebook™ - a complete desk calendar
- Time of day
- International time-keeping ability
- Calendar date
- Recharging battery backup
- Day of week
- Complete software formatting
- Program timer
- Offset time/date/day readout

VIP™ Card - "Versatile Interface Peripheral"

(Available for EPSON, NEC, C-ITOH, IDS PRISM, OKIDATA and other graphic printers soon.)

VIP™ G- The Ultimate Graphics Card

\$11900*

- A Centronics Parallel Interface and Cable featuring:
- Text and graphics screen dump routine
- Graphics with inverse & emphasized modes

- Enlarged picture mode
- Variable line length with left & right margins
- Block graphics
- 90° picture rotation
- Chart Recorder Mode
- Upgradable to VIP™ G+

VIP™ G+

- has all the features of the VIP™ G plus:
- A serial port with full RS232 capability
- Software baud rate control from 140 to 9600 baud

\$14900*

VIP™ P

- an Interface card featuring:
- Two parallel ports
- Upgradable to VIP™ SP

\$11900*

VIP™ SP

- an Interface card featuring:
- Two parallel ports
- One serial port

\$14900*

VIP™ Graphics Diskette

\$1995*

for the person who already owns a parallel interface and cable. Features:

- Full VIP™ I software capabilities
- Plus side-by-side twin picture capability
- Self-documentation



Microcomputer Business Industries Corporation

Suite 200 • 1019 8th Street

Golden, Colorado 80401

(303) 279-8438

TWX: 910-934-0191

National and international
dealer inquiries welcome.

complete but not as easy to use because they give the number of the line in error instead of displaying the line itself.

Documentation

Taking the Logos in alphabetical order again, we start with Apple Logo. The documentation for Apple Logo is in two volumes, both in the half-page spiral-bound format of all the Apple Computer Inc. documentation. (Instead of the metal spiral binding used in all Apple documentation to date, the spiral binding here is plastic; perhaps this is just new packaging, but it might be in deference to young children using the documentation—a nice change, in any case.) The first book, *Apple Logo: Introduction to Programming through Turtle Graphics*, by Cynthia J. Solomon, is the kind of step-by-step, gentle introduction to Logo needed by anyone using a computer for the first time. The book, which is 153 pages long, uses turtle-related projects to cover procedures, file storage and retrieval, the Logo editor, variables, recursion, and most of the graphics-related commands. The subjects covered are explained in an easily understandable way. The book is laid out in a pleasing format that includes many screen shots (to illustrate the turtle's behavior in the examples given); most pages have a wide left margin that gives you a place to write notes (if you're the kind of person who writes in books).

Apple Logo: Reference Manual, by Laurence J. Davidson, is the one book I read cover to cover. It's 186 pages long and covers all aspects of the Apple Logo package. I found it to be comprehensive, well organized, and easy to read.

Terrapin Logo is documented by two books, *The Terrapin Logo Language Tutorial*, by Deborah Tater and Patrick Sobalvarro, and *Logo for the Apple II: Technical Manual*, by Harold Abelson and Leigh Klotz Jr. These two books roughly correspond to the Apple Logo counterparts; the former is the tutorial book, and the latter is the reference manual. In comparison to the Apple Logo manuals, what the Terrapin manuals lack in

“polish,” they make up for in content. The writing style of the tutorial book is not as calculatedly simple as its Apple Logo counterpart, but it is written in a friendly, conversational way. I think that, again, this is because Apple Logo is intended for a less technical (perhaps younger) audience. In contrast to the Apple Logo tutorial book, *The Terrapin Logo Language Tutorial* covers a larger subset of the Logo world: it includes sections on words, lists, and debugging. Appendix III, which explains rather well the concept of *tail recursion*, is particularly well done. (Tail recursion usually occurs when the last thing a recursive procedure does is call itself. When this occurs, Logo can treat the

At first, the idea of doing Logo benchmarks seemed almost sacrilegious, like trying to benchmark sunsets. Still, old habits die hard. . . .

procedure as iterative instead of recursive, thus saving a lot of memory and allowing Logo to function more efficiently.)

Logo for the Apple II, by Harold Abelson (published by BYTE Books), is supplied with Krell Logo in place of the Terrapin tutorial book. It is easily the best tutorial book (for people who don't need the gentle approach of the Apple Logo tutorial book) of the three Apple-based tutorial books. It comes the closest of the three to covering the *entire* Logo instruction set in a tutorial manner. It also has plenty of drawings and charts as well as spiral binding and wide margins on each page.

Logo for the Apple II: Technical Manual is the reference work for both Terrapin and Krell Logos. Its description of individual Logo commands is very terse (as opposed to the Apple Logo documentation, which gives a longer definition and several examples for each word), which may be a problem for some users. However, the manual does devote an entire

chapter to the assembler and its use with Terrapin/Krell Logo; this chapter includes a lot of information on the internal structure of Terrapin/Krell Logo, something that Apple Logo does not do.

An 83-page book called the *TI Logo User's Manual* (by Diane R. Musha and other members of the TI Learning Center) is the only documentation available for TI Logo. The first 64 pages are tutorial and cover the TI Logo editor, saving and loading files to cassette or floppy disk, procedures, variables, the turtle, and the special features of TI Logo—sprites and tiles. A 9-page appendix lists and briefly defines all the predefined words in TI Logo; however, I found the definitions of HOME and SETSPEED to be incorrect and also found several basic Logo words (see page 262) that work in TI Logo but that are missing from the appendix. I think it is safe to say that any user will have to buy a supplementary textbook on Logo to get full use of TI Logo; the TI Logo documentation just doesn't tell you all you need to know about the language.

A Few Benchmarks

I don't want to give the impression that I have conducted an exhaustive set of benchmarks for the five Logos—I haven't. At first, the idea of doing Logo benchmarks seemed almost sacrilegious, like trying to benchmark sunsets. Still, old habits die hard, and I *did* try to measure two things—the size of a Logo workspace and the speed of execution of a sample Logo program.

Since the Apple-based Logos measure workspace size in *nodes*, the size of their workspaces can be easily compared. A node is a unit of memory within Logo and is implemented in the Apple versions as 5 bytes. The versions I worked with gave Apple Logo (version 1.5) as having 2818 nodes and Terrapin/Krell Logo (version 1.0) as having 2288 nodes; both measurements were taken with an empty workspace. Although the Apple Logo figure will probably remain the same, Terrapin will be selling revised versions of Terrapin Logo that may have more node space. Still,

PERSYST ADD-IN PRODUCTS

When Only The Very Best Will Do!

You wanted the very best... that's why you waited for the IBM® Personal Computer. Now you're ready to expand your system and again, you want the very best.

The best is here... PERSYST'S growing family of IBM compatible add-in products.

MEMORY EXPANSION—Implemented with socketed high-speed dynamic RAMs, the memory is designed for easy expansion and is available in four configurations—64K, 128K, 192K, and 256K bytes. Field expansion kits are available in 64K increments. PERSYST'S memory features parity checking and error reporting, switch selectable addressing on any 64K boundary and complete compatibility with IBM hardware and software.

COMMUNICATIONS—PERSYST'S asynchronous communications board is available in single or dual channel configurations. Both channels support programmable Baud rates ranging from 50 to 19,200 Baud; 5, 6, 7, or 8-BIT characters with 1, 1½ or 2 stop bits; even, odd or no parity bit generation and detection; fully prioritized interrupt system; full modem support, full duplex operation; and double buffering to eliminate the need for precise synchronization.

DUAL FUNCTION—The PERSYST FLEX-COMM Series multi-function board provides two asynchronous communications lines, and a parallel printer port all on a single circuit board. The FLEX-COMM Series is available in 5 different configurations, all field upgradeable to a fully populated board.

MULTIFUNCTION—Incorporating all the features of PERSYST'S memory, communications, and printer options, the

SPECTRUM Series multi-function board provides 64K to 256K of field expandable memory, two asynchronous communications lines, and a parallel printer port all on a single, full length circuit board. The SPECTRUM Series is available in 24 different configurations, all field upgradeable to a fully populated board.

All PERSYST boards are thoroughly tested and burned-in at elevated temperatures for increased reliability. IBM-like documentation is included, as is a one-year, return to factory warranty.

Don't settle for less... insist on PERSYST. See the expanding line of PERSYST products at your local PERSYST dealer or contact:

PERSYST, INC.

22957 La Cadena
Laguna Hills, CA 92653
(714) 859-8871

® IBM is a trademark of International Business Machine Corp.



All PERSYST products now available through:

SAD Systems, Inc., 23891 Via Farricante, Mission Viejo, CA 92691, (714) 768-2913

Our Name Means a Great Deal

consumer computers
MAIL ORDER 8338 Center Drive, La Mesa, CA 92041

Toll Free ORDERS ONLY 800-854-6654
CALIFORNIA & INFORMATION (714) 698-8088

★ 15 Day No Risk Policy

★ Serving people everywhere since 1977

★ We accept all major credit cards.
★ We will try to meet or beat any currently advertised price.

★ Most Orders Shipped Within 24 Hours
★ Free Shipping* (Pre-Paid Cash Orders)



NEC

IBM

COMPATIBLE ACCESSORIES

Commodore

BASIS 108

VIC-20

NEW **PC-8000**

The serious fun machine for living, learning, working and playing. Please call for details.

IBM compatible software

NEW!

"THE COMMODORE 64 COULD BE THE MICRO-COMPUTER INDUSTRY'S OUTSTANDING NEW PRODUCT INTRODUCING SINCE THE BIRTH OF THIS INDUSTRY!"
— Shearson/American Express

COMMODORE 64

The Commodore 64 is a compact unit that can even fit into a briefcase. Complete with these features:

- Full size typewriter keyboard
- Full ASCII character set
- Upper and lower case
- High resolution color graphics
- 40 column video display
- 64K RAM under memory (standard)
- CP/M operating system option
- TV modulator interface
- Game cartridge slot
- Music Synthesizer
- Smart peripherals

PLEASE CALL US FOR MORE DETAILS

The Alternative

FEATURES

- Apple II Compatibility in both peripheral cards and software
- 6502 and Z-80 CPUs
- 64K RAM, expandable to 128K
- RGB and Composite Video Output
- Selectable 80 or 40 column display
- High Resolution Graphics: 6 colors, 280 x 192 with four lines of text
- 6 bit Parallel I/O interface
- TS-232C Serial I/O interface
- Detachable Keyboard: All standard ASCII characters and keyboard functions, upper/lower case, and a numeric keypad, cursor control block, and 15 programmable special function keys
- Built-in hardware for mounting two 5 1/4 inch mini-floppy disk drives
- Six Apple II compatible slots for plug in peripheral cards
- Game paddle I/O

PLEASE CALL US FOR MORE DETAILS

The Friendly Computer

\$244⁵⁰

VIC 20 Personal Computer 244⁵⁰
VIC 1540 Single Disk Drive 489⁵⁰
Datasette Cassette I/O unit 65⁵⁰
Joystick Controller 10⁵⁰
VIC 15 15 Graphics Printer 329⁵⁰
VIC Super Expander 54⁵⁰
3K Ram Cartridge 34⁵⁰
8K Ram Cartridge 49⁵⁰
16K Ram Cartridge 99⁵⁰
VIC IEEE 488 Interface 79⁵⁰
VIC RS-232C Terminal Interface 59⁵⁰

PC-8001A Microcomputer (32K) CALL
PC-8012A I/O unit, 32K, 7 slots 489⁵⁰
FDC I/O port 139⁵⁰
NEC 8023 Printer 489⁵⁰
32K Memory Add-on card 169⁵⁰
PenTec 2 port RS-232 card 165⁵⁰
PenTec Wedge Expansion w/32K 489⁵⁰
RGB to Composite Video Converter 89⁵⁰

NEC PC-8001 Software

NEC CP/M Operating System 125⁵⁰
FORTRAN by Microsoft 349⁵⁰
General Accounting System 249⁵⁰
Accounts Receivable System 249⁵⁰
Inventory Control System 249⁵⁰
Payroll System 249⁵⁰
Job Cost System 249⁵⁰
Sales/Word Processing w/speller 349⁵⁰
Report Manager 149⁵⁰
Games Pack 1 Alien, Space War 29⁵⁰
Games Pack 2 UFO Galaxian, Bomber 29⁵⁰
WordStar by Micropro 299⁵⁰
DataStar by Micropro 249⁵⁰
Mailmerge for NEC Wordstar 109⁵⁰
Speller by Micropro 169⁵⁰
Supersort by Micropro 169⁵⁰
Basic-80 Compiler by Micropro 349⁵⁰
Basic-80 by Microsoft 319⁵⁰
Cobol-80 by Microsoft 849⁵⁰
Rascal NEC DOS 139⁵⁰
Term II Communications Pkg. 149⁵⁰
FileFax System 149⁵⁰
Protran (converts TRS-80 software) 99⁵⁰
KFS80 ISAM Package 139⁵⁰

Micro Software and Accessories available

84K memory card by Microsoft 379⁵⁰
128K memory card by 499⁵⁰
192K memory card by 659⁵⁰
256K memory card by 799⁵⁰
64K ram chip upgrade kit 169⁵⁰
Serial Async. Comm. card w/1 port 129⁵⁰
Serial Async. card with 2 ports 249⁵⁰
Clock Calendar card 105⁵⁰
Combo Card by Apparatus 235⁵⁰
IBM Joysticks 55⁵⁰
Expansion Chassis 119⁵⁰
Baby Blue Z-80/64K & CP/M CALL
Percom mini-floppy drives (add-on) CALL
Tandon TM 100 mini-floppy drives CALL

IBM compatible software

Continental Home Accountant Plus 129⁵⁰
T.I.M. III by Innovative 349⁵⁰
SuperCalc 239⁵⁰
SuperWriter 259⁵⁰
Easywriter II 269⁵⁰
Easy Speller 149⁵⁰
Easy Filer 279⁵⁰

MicroPro

WordStar 299⁵⁰
MailMerge 129⁵⁰

VISI-CORP

VisiCalc (Standard) 159⁵⁰
VisiCalc/256K 199⁵⁰
VisiTrends/256K 239⁵⁰
VisiFile 199⁵⁰
VisiPlus 199⁵⁰
Desktop Plan I 249⁵⁰

FRANKLIN 64

The Franklin ACE 100 is a professional personal computer that is hardware and software compatible with the Apple II and includes many features not found on the Apple unit. All programs written for the Apple II will run on the ACE 100 without modification including those using high and low resolution black and white graphics. The ACE 100 is plug compatible with Apple. All peripherals that operate in the Apple II will operate in the ACE 100 without modification.

FRANKLIN ACE 100 FEATURES

- Apple II Compatible
- 64K RAM User memory
- Upper and lower case
- Typewriter style keyboard
- Twelve key numeric pad
- Alpha lock shift key
- VisiCalc friendly
- 50 watt power supply
- Built In Fan

PLEASE CALL US FOR MORE DETAILS

8032 Computer with 32K 1079⁵⁰
8050 Dual mini-disk 1 Mb system 1265⁵⁰
8250 Dual mini-disk 2 Mb system 1749⁵⁰
4022 Dot Matrix Printer 559⁵⁰
4040 Dual Disk drive system 979⁵⁰
18K and 32K Pet Computers CALL
The SUPER Pet 1599⁵⁰
Winchester Hard Disk Systems CALL
Voice Synthesizer CBM/PET 319⁵⁰
300 Baud Acoustic Modem 249⁵⁰

umc UMI SOFTWARE for VIC 20

VicCalc - Viable Calculator (T) 11⁵⁰
VicCat - Viable Catalog (BK) (T) CALL
VicCheck - Checkbook Mgt. (BK) (T) 19⁵⁰
ViTerm - Dumb Terminal (T) 16⁵⁰
Basic Programmers I/O ROM 27⁵⁰
Spiders of Mars (C) 29⁵⁰
AMOK (C) 31⁵⁰
AMOK (T) 31⁵⁰
Meteor Run (C) 36⁵⁰
Alien Blitz (C) 32⁵⁰
Alien Blitz (T) 36⁵⁰
Simon (T) 7⁵⁰
Kidlike Checkers (T) 7⁵⁰
3-D Maze (T) 11⁵⁰
Raceway (T) 11⁵⁰
Kosmic Kamikaze (BK/T) 20⁵⁰
Kiddle Pak (4 Tapes) 31⁵⁰
Super Four I (4 Tapes) 39⁵⁰
The Alien (BK/T) 19⁵⁰
Renaissance-Cthello (C) 39⁵⁰
SkyMath (BK/T) 12⁵⁰
LongDrive (BK/T) 12⁵⁰
SpaceDiv (BK/T) 12⁵⁰
Super Hangman (BK/T) 17⁵⁰
T = Tapes, C = Cartridge, BK = 3K expansion

TERMINALS

ADDS

Viewpoint, A1 679⁵⁰
Viewpoint, A2 699⁵⁰
Viewpoint, A3 699⁵⁰

TeleVideo

910C 699⁵⁰
912C 799⁵⁰
925C 799⁵⁰
930C 899⁵⁰

S-100 BOARDS CLEARANCE

64K Dynamic Memory Card (200 ns) 449⁵⁰
5-100 12 Slot Mainframe (C/8em) 379⁵⁰
Z-80 4MHz CPU Card w/monitor ROM 209⁵⁰
2 Parallel/2 Serial Port I/O 199⁵⁰

SSM

Z-80 4MHz CPU Card (CBZ, A&T) 339⁵⁰
V83 80x24 5-100 Video Card, A&T 349⁵⁰
V83 80x48 5-100 Video Card, A&T 389⁵⁰
Expandable 64K Dynamic Memory Kit 189⁵⁰

CBM/PET SOFTWARE

Tax Preparation System 329⁵⁰
Medical Accounting System 399⁵⁰
Legal Time Accounting System 289⁵⁰
General Ledger 289⁵⁰
VisiCalc for CBM 189⁵⁰
Ozz Information Wizard for CBM 299⁵⁰
Wordcraft 80 Word Proc for CBM 299⁵⁰
Personal Tax Calculator for CBM 55⁵⁰
Dow Jones Portfolio Mgt. for CBM 119⁵⁰
Info Retrieval & Mgt. Aid for CBM 399⁵⁰
BPI General Ledger for CBM 299⁵⁰
BPI Accounts Receivable for CBM 299⁵⁰

We carry the complete line of CBM Hardware & Software at great prices.

NEW SANYO computer

Novation

Novation Cal acoustic modem 169⁵⁰
Novation D-Cal direct connect 149⁵⁰
Novation Apple Cal 319⁵⁰

Hayes

Hayes Stack Smartmodem 149⁵⁰
Hayes Stack Chronograph 189⁵⁰
Hayes Apple Micromodem II 89⁵⁰

Universal Data Systems
Direct Connect Modems

100 LP Orig./Ans. 300 baud 189⁵⁰
100 LP Orig./Auto ans. 300 baud 199⁵⁰
200 LP Orig./Ans. 1200 baud 229⁵⁰
200 LP Orig./Auto ans. 1200 baud 249⁵⁰

DISKETTES

Dyan 5 1/4" (Soft, 10 or 16 sectors) 109⁵⁰
Dyan 5" Sgl. Den./Sgl. Sided 109⁵⁰
Verbatim 5 1/4" (Soft, 10 or 16 sect.) 109⁵⁰
Verbatim 5" Sgl. Den./Sgl. Sided 109⁵⁰
Scotch 3M 5 1/4" (Soft, 10 or 16 Sect.) 109⁵⁰
Same as above in quantity of 100 249⁵⁰
Scotch 3M 5" Diskettes all types CALL
Scotch 3M Drive Head Cleaning Kit (5" & 7") 29⁵⁰

MODEMS

Anchor Automation Signmaster Mark I 99⁵⁰

Novation

Novation Cal acoustic modem 169⁵⁰
Novation D-Cal direct connect 149⁵⁰
Novation Apple Cal 319⁵⁰

Hayes

Hayes Stack Smartmodem 149⁵⁰
Hayes Stack Chronograph 189⁵⁰
Hayes Apple Micromodem II 89⁵⁰

consumer computers

We Bring Prices Down to Earth

ORDER TOLL FREE 800-854-6654
CALIFORNIA & INFORMATION (714) 698-8088

Ordering Information: Phone orders using VISA, MASTERCARD, AMERICAN EXPRESS, CARTE BLANCHE and bank funds wire transfer. Send cashiers or certified check, money order or personal check (allow 10 days to clear). Unless prepaid with cash please add 5% for shipping, handling and insurance (minimum \$50.00). Educational institutions and corporations please send for written quotations. All equipment is subject to price change and availability without notice. All equipment is new and complete with manufacturer warranty, (usually 90 days). We will not honor prices which are typographical errors. C.O.D. orders require a 20% cash deposit in advance. If you not completely satisfied return product in 15 days for a refund (only with original container and unutilized warranty card). All other returns subject to a restocking fee. Please call for more details.

Send orders to: 8338 Center Drive, La Mesa, CA 92041

DISKETTES

Dyan 5 1/4" (Soft, 10 or 16 sectors) 109⁵⁰
Dyan 5" Sgl. Den./Sgl. Sided 109⁵⁰
Verbatim 5 1/4" (Soft, 10 or 16 sect.) 109⁵⁰
Verbatim 5" Sgl. Den./Sgl. Sided 109⁵⁰
Scotch 3M 5 1/4" (Soft, 10 or 16 Sect.) 109⁵⁰
Same as above in quantity of 100 249⁵⁰
Scotch 3M 5" Diskettes all types CALL
Scotch 3M Drive Head Cleaning Kit (5" & 7") 29⁵⁰

Buy From Us and Save Your Green

consumer computers

MAIL ORDER 5336 Center Drive
La Mesa, CA 92041

Toll Free **800-854-6654**
CALIFORNIA & INFORMATION (714) 698-8088

★ 15 Day No Risk Policy

★ We accept all major credit cards.
★ We will try to meet or beat any currently advertised price.

★ Most Orders Shipped Within 24 Hours

★ Free Shipping* (Pre-Paid Cash Orders)



★ Serving people everywhere since 1977

16K RamBoard FOR APPLE II



\$50.00 KIT

ASSEMBLED & TESTED \$69.00

SOFTWARE



VisiCalc	185**
VisiCalc Templates (New)	CALL
VisiFile (Data Base Manager)	165**
Visi Trend/VisiPlot	199**
Visi Schedule (New)	239**
VisiTerm	89**
VisiDex	185**
Desktop Plan II	185**



Tax Preparer	119**
Real Estate Analyzer	119**
Creative Financing	119**



WordStar	189**
MailMerge	79**
Spell Star	115**
DataStar	189**
CalcStar	115**
Supersort II	115**
WordStar Customization Notes	289**



MICROSOFT SOFTCARD PREMIUM SYSTEM
(Includes: SoftCard, RAMCard, Videx Videoterm 80 Col., Softswitch, Osborne CIM User Guide) List 755** only 659**

Microsoft TASC Applesoft Compiler	149**
Fortran 80	69**
A.L.D.S.	69**
Basic Compiler	289**
Cobol-80	499**
Time Manager	129**

CP/M Software

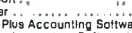

WordStar	289**
Supersort II	189**
MailMerge	109**
DataStar	239**
SpellStar	189**
CalcStar	235**



BASIC 80	289**
BASIC Compiler	369**
Fortran 80	369**
Cobol 80	569**
Macro 80	179**
My Math/My SIMP	215**
My Lists/My STAR	189**

d BASE II	499**
PLAN 80	249**
QBASIC	119**
PASCAL MT - Ver. 5.5	399**
Spellguard	299**
PASCAL Z	329**
SUPERCALC	229**

APPLE II COMPATIBLE Accessories



Hayes Micromodem II	289**
Hayes Smartmodem	245**
Hayes Chromograph	189**



Novation Apple Cat modem	319**
Expansion-Mod.	39**
Handset	29**
85R X-10 control interface mod.	19**
Touch-Tone Firmware	CALL



Videx VideoTerm 80 column card	245**
Videx Keyboard Enhancer I (orig.)	75**
Videx Keyboard Enhancer II	129**



Z-80 SoftCard by Microsoft	289**
16K RamCard by Microsoft	165**
ThunderClock/Calendar card	189**
Smarterm 80 column card	289**



Corvus Winchester 5 Mb Disk	295**
Corvus Winchester 10 Mb Disk	429**
Corvus Winchester 20 Mb Disk	519**
Mirror Back-Up	699**



CPS Multi-Function Card	189**
Music System (16 voices)	299**
A/D + D/A interface	279**
Expansion Chassis (8 slots)	589**
Clock/Calendar card	229**
SuperTalker SD 200	149**
Romplus + card	129**
Keyboard Filter ROM for Romplus	49**
CopyRom for Romplus	49**
RomWriter card	149**
RamPlus 32K ram add-on (w/16K)	149**



Sorrento Valley Associates

SVA 2 + 2 Spl. Den. 8" Disk Cont.	CALL
SVA 2ZX4 Megabyte 8" Disk Cont.	CALL
Apple Cache 256K by SVA	CALL



Forth (Apple compatible) Drives	CALL
IEEE 488 Interface by SSM	369**
Vision-80 Col. card by Vista	255**
Prom Development System by Vista	355**
8" Disk Drives by Vista	CALL
Adwar Video Processor Mod	CALL
Videodeck Apple Interface	475**
Echo II Speech Synthesizer	219**
The Milli 8008 Processor	319**
Symtec Lightpen	219**
The Milli 8008 Processor	319**
Lazer Lower Case Adapter	59**
Houston Inst. Graphics Plotter	CALL
16K Ram Board by CCI in kit form	59**
SYNERGY Multi-Card	CALL
Prometheus VarsaCard	219**
ALF 3 voice Music Card	179**
ALF 6 voice Music Card	149**
JoySticks by Keyboard Co.	44**
23 Key Numeric Keyboard by Versawriter	115**
Versawriter Digitizer Table	249**
Grappier Printer Interfaces	139**
MicroBuffer II 32K (specify print)	289**
Microbuffer II 16K (specify print)	249**
8K Serial Buffer Card for Epson	149**
16K Parallel Buffer IIF for Epson	149**
Sup-R-Fan	45**
Sup-R-Terminal 80 column card	299**



MICRO SCI APPLE II COMPATIBLE DISK DRIVES

A2 with controller	469**
A2 w/o controller	369**
A4 with controller	479**
A4 without controller	369**
A7D with controller	589**
A7D without controller	489**

Clearance Sale!



Clearance
Up To **40% OFF!**
This Offer Good While Supplies Last

Asynchronous Serial Card (7710A)	139**
Synchronous Serial Card (7712A)	99**
Centronics Printer Card (7728A)	89**
Cable for Prism/Tigers to 7728A	29**
Parallel I/O Card (7720A)	89**
Calendar/Clock Card (7424A)	79**
Arithmetic Process (7811C)	269**
Programmable Timer Card (7440A)	60**
3 1/2" Digit BCC A/D Converter	80**
GPB (IEEE 488) Card (7490A)	169**
12K ROM/PROM Card (7114A)	59**
Extender Card (7520A)	19**

HARDWARE from APPLE COMPUTER

SAVE UP TO 50% Clearance Sale

Parallel Printer Card	99**
Hi-Speed Serial Card	99**
Centronics Printer Card	119**

We have more items too... Please Call Us.

APPLE II SPECIAL DELIVERY SOFTWARE

Clearance Special Save over 50% OFF!

Pascal Animation Tools	37**
PSORT Pascal disk file sort	42**
Formulex	37**
Goodspell	30**
Plan 80	92**
Order Tracking System	25**
VisiCalc Real Estate Templates	32**
Hand Holding Basic	50**
Supersort	17**
Pilot Animation Tools	37**
Topographic Mapping	32**
Bridge Tutor	20**
Bridge Tutor Extended	20**
Musicomp music composition	22**
Artist Designer	32**
Galactic Wars	17**
Utopia Graphics Tablet System	22**
Diet Analysis	79**
Stepwise Multiple Regression	32**

APPLE II GAMES

SOFTWARE CLEARANCE

We are reducing our inventory of software at incredible savings to you. Hurry we have a limited supply.

ANY GAME ONLY \$15.00

Galactic Trader (Broderbund)	15**
Galactic Revolution (Broderbund)	15**
Galaxy Wars (Broderbund)	15**
Tawala's Last Redoubt	15**
Golden Mountain (Broderbund)	15**
Space Invaders (Cosmos Mission)	15**
Head-On	15**
Shuffleboard	15**
Microchess	15**
Bridge Partner	15**
Monty Plays Scrabble	15**
Monty Plays Monopoly	15**
Rainbow Writer	15**
Checker King	15**
Gammon Gambler	15**
Fastgammon	15**
Battleship Commander	15**
Bright Pen/Light pen	15**
Both Barrels	15**

PRINTERS



DP-9501 w/2K buffer	1149**
---------------------	--------



F-1040 CPS (parallel)	1399**
F-1040 CPS (serial)	1450**
ProWriter 8510 10" (parallel)	469**
ProWriter 8510 10" (serial)	579**
ProWriter II 1550 15" (parallel)	699**
ProWriter II 1550 15" (serial)	749**



MX-80 T Type II w/graphics	CALL
MX-80 FIT Type II w/graphics	CALL
MX-82 FIT Type III w/graphics	CALL
MX-100 Type III w/graphics	CALL
Epson Gratrix 80 ROM	59**



Prism 80 without color option	1049**
Prism 80 with color	1289**
Prism 132 with color	1689**
Apple Prism color software	99**



8023 Impact Dot Matrix	489**
351033CPS serial	1749**
3530 33 CPS centronics parallel	1749**
Bi-directional tractor for 3500's	229**
771055CPS serial	2349**
7730 55 CPS centronics parallel	2349**
Tractor for 7700 series	229**



Okidata Microline 80 (10 dot quan.)	319**
Okidata 82A w/tractor, 80 col.	489**
Okidata 82A w/tractor, 132 col.	725**
Okidata 84A 132 col. serial	1189**
Okidata 64A 132col. parallel	1029**



Smith Corona Printer parallel	689**
-------------------------------	-------

MONITORS



Amdek Video 300 12" Hi-Res Green	169**
Amdek Video 100 12" B&W	129**
Amdek Color 13" Color w/audio	379**
Amdek Color II Hi-Res RGB monitor	769**
Amdek Apple II DVM RGB card	169**



NEC 9" Hi-Res Green monitor	179**
NEC 12" Hi-Res Green monitor	169**
NEC 12" Composite Color monitor	349**
NEC 12" Hi-Res RGB Color monitor	799**



Sanyo 9" B&W	189**
Sanyo 9" Green monitor	179**
Sanyo 12" B&W	189**
Sanyo 12" Green (New case style)	269**
Sanyo 13" Color Monitor	369**



Zenith 13" Green monitor	118**
--------------------------	-------

ATARI



Atari 800 (16K)	679**
Atari 800 w/32K	789**
Atari 400 (16K)	329**
819 580 Column Card for 800	299**
410 Program Recorder	79**
810 Disk Drive	429**
850 Interface Module	189**
Epson cable for 850 module	34**
Atari Joystick (pair)	20**
Axlon Ramtracem 32K module	169**
Atari 16K Module by Microtek	89**

ATARI Software

EDU-PAK Educational 14 Tape Series	149**
VisiCalc for Atari (D)	189**
Word Processor (D)	119**
Personal Finance Management (D)	47**
Dow Jones Investment Evaluator (D)	69**
Microsoft Basic (D)	69**
Macro Assembler & Text Editor (D)	69**
Conversational French (T)	49**
Conversational German (T)	49**
Conversational Italian (T)	49**
Conversational Spanish (T)	49**
Pac-Man (cartridge)	34**
Centipede (cartridge)	34**
Asteroids (cartridge)	34**
Missile Command (cartridge)	34**
Star Raiders (cartridge)	39**
Space Invaders (cartridge)	34**
Caverns of Mars (disk)	34**
Assembler/Editor (cartridge)	49**

We carry all ATARI software and hardware.



Control Everything in your Home

BSR Ultrasonic Command Console	99**
BSR Appliance Module	19**
BSR Lamp Module	17**
BSR Timer Module	69**

SUPPLIES

Orange AC Surge Protector 5	119**
Lemon AC Line Filter	59**
Executive Library Case 5 1/4"	24**
Cablewicks Cables (all sizes)	CALL
Prismag cover for Apple II	24**
5 1/4" Disk Bank Storage Box	5**
8" Disk Bank Storage Box	8**

GENERAL RIBBON PRODUCTS

NEC Multi-Strike Ribbon	8**
NEC Black Fabric Ribbon	8**
Qume Multi-Strike Ribbon	4**
Qume Black Fabric Ribbon	4**
Dual Multi-Strike Ribbon	8**
Diablo Black Fabric Ribbon	8**
Anadex DP-9500 Cartr. Ribbon	14**
IBM 805-102 24 Pin Ribbon	3**
Paper Tiger Black Nylon Ribbon	3**
Epson MX70/80 Cartridge Ribbon	12**
Epson MX100 Cartridge Ribbon	24**

DUST COVERS

Disk II Only	8**
Apple II & Drive	12**
Apple Dual Disk Cover	7**
Apple II Computer	18**
Epson MX-80 Cover	11**
Sanyo 9" Monitor cover	11**
Atari 800	8**
Televideo Terminal	8**
Amdek 12" B&W	10**
NEC 12" & NTSC Color	14**
Diablo 80-RO Printer	19**
NEC RGB Color Monitor	8**
Epson MX-100 Cover	14**

Procedure Executed	Level Reached by the Computer Running:		
	Apple Logo	Terrapin/Krell Logo	TI Logo
FILLMEMORY	228	114	46
FILLPROC	236	271	29

Table 3: Workspace size of the three implementations of Logo as indicated by the FILLMEMORY and FILLPROC procedures. See the section on benchmarks for details (see listings 4a and 4b on page 264).

the Apple-based Logos are within 20 percent of each other in workspace size.

It is more difficult to compare the Apple-based Logos to TI Logo because the latter does not have a command that returns the workspace size. So I created and ran two procedures that filled memory, thinking that the numbers they returned would be proportional to the relative sizes of the workspaces. (I chose to do a second procedure to confirm the results of the first; with only one procedure, I would have no way of telling whether the assumption that the

numbers are proportional to the workspace sizes is valid.) The first procedure, FILLMEMORY (see listing 4a and 4b), fills memory by running an infinitely deep recursive procedure and printing out its current recursion level; the level at which the procedure runs out of memory should be proportional to the workspace size. (The second PRINT statement in FILLMEMORY is used to keep tail recursion, which would prevent true recursion, from happening.)

The second procedure, FILLPROC (see listings 4a and 4b), fills memory by creating a series of empty pro-

cedures, P1, P2, P3, and so on; the Logo word DEFINE is used to create new procedures under program control. As described in the last section on TI Logo, the version of FILLPROC had to be implemented differently because of the TI Logo instruction set.

The results of these two tests are given in table 3. The performance of all the Logos on FILLPROC is rather puzzling. Terrapin/Krell Logo (in comparison to Apple Logo) seems to do worse on FILLMEMORY and better on FILLPROC. These numbers should be discarded in favor of the node figures discussed above. In both cases, though, TI Logo did much more poorly than the Apple-based Logos, although I would hesitate to give a percentage figure based on these figures. TI Logo requires 48K bytes of memory (16K bytes in the TI-99/4A itself and 32K bytes in an expansion box), and according to a source at TI, the TI Logo cartridge takes up only a small area of memory itself. Thus the amount of free memory available to TI Logo is roughly equal to that of the Apple-based Logos; I don't think we can attribute the reduced TI Logo capacity to the available memory in the machine.

The other set of benchmarks tests the Logos' overall speed performance running a program that relies heavily on recursion (which most Logo programs do) and list manipulation. I used the SORT procedure of listing 2 to sort two lists: first, the list [LOGO IS AN INTERESTING LANGUAGE FOR PICTURE DRAWING, LIST MANIPULATION, AND EDUCATION]; and second, [Z Y X W V U T S R Q P O N M L K J I H G F E D C B A]. The timing results of these benchmark programs, given in table 4, show that Apple Logo is about 10 percent faster than Terrapin/Krell Logo, which will not be noticeable in most situations. TI Logo, however, is slower than the Apple-based Logos by a factor of two.

Which Logo Is Right for You?

If you skipped the rest of this article to read this section, you're out of luck—the answer to the above question is more in the body of this article

Text continued on page 288

Announcing Expanded Disk Storage For IBM Personal Computers

**Simple plug-in installation
no additional electronics or wiring required.**

Internal Drive:

- Single sided with 168K bytes IBM format \$215
- Double sided with 336K bytes IBM format \$385
- Double sided with 650K bytes IBM format \$570
- Two double sided drives with 1.3M bytes IBM format \$1140

External Drives: (Includes drive, power supply, cabinet and cable)

- Single sided with 168K bytes IBM format \$315
(Maximum two drives externally)
- Double sided with 336K bytes IBM format \$485
(Maximum two drives externally)
- Double sided with 650K bytes IBM format \$670
(Maximum two drives externally)

Drives are IBM compatibility tested with a 90-day warranty.
For more information, call or write:

I² INTERFACE, INC.
7630 Alabama Ave., Unit 3
Canoga Park, CA 91304
(213) 341-7914

Quantity and dealer discounts available upon request.

The new DMS-86 makes any terminal a 16-bit computer network station.



Slimmer than a telephone book, the hot new DMS-86 turns any terminal into a HiNet™ Local Area Network station. So now, a HiNet network can run 8 and 16-bit software simultaneously. Pay only for the power you 1—exactly where you need it. HiNet is a complete hardware/ware local area network—flexible, inexpensive, fast—and from a single source.

The DMS-86 is perfect for financial modeling, MRP, scientific analysis, or word processing—any processor-intensive application. Its large internal memory acts like a “pseudo-disk,” providing up to 1MB RAM and super-fast access to frequently used data in “working memory.”

The CP/M®-based DMS-86 combines an 8086 processor (and optional 8087 co-processor) with 1KByte network buffer and from 256K to 1MB RAM, three RS-232C serial ports, an 8-bit bidirectional parallel port, and the HiNet networking port.

Bring 16-bit response to your favorite terminal. Check out HiNet and the small but mighty DMS-86.



Digital Microsystems ™
Because man was not meant to work alone.

1840 Embarcadero, Oakland, CA 94606 (415) 532-3686, TWX 910-366-7310 Extel House, East Harding St., London EC4P-4HB 01-353-1080 Telex 23721

CP/M® is a registered trademark of Digital Research, Inc.

Circle 145 on Inquiry card.

Test drive the Victor desktop computer designed for systems.

Like a high performance automobile, the Victor desktop business computer needs to be put to the test to be really appreciated. Here's why:

The computer dilemma.

Systems houses today face a basic dilemma when it comes to selecting a computer.

The so-called "personal" computers on the market are like "economy" cars. They're relatively inexpensive but have limited power and capacity.

And the larger mini computers offer more power and speed, like a luxury car, but are, of course, more expensive.

Victor has a solution to that dilemma.

The Victor 9000 Business Computer is retail priced under \$5,000. If you sell computer systems, quantity purchase agreements will let you be very aggressive.

The Victor gives your systems the kind of memory and storage capacity advanced applications demand. Much more than comparably priced machines.

And the Victor display screen has double the resolution and

capacity of its competitors. You can display a full 132-column report and still be perfectly readable. Is that important to your system? Ask any programmer.

Experience where it counts.

But those are only the technical advantages of the Victor 9000. Equally important is Victor's 65 years of experience in solving business problems. And Victor's 50 branch offices throughout the country providing fast service and total support.

Software tools to keep you growing.

Victor supplies CP/M-86 and MS DOS with every machine. Runtime support for Basic, Cobol, Fortran and Pascal is no extra cost. The Victor 9000 has the tools you need to do the job right.

The Victor 9000. It's a desktop system computer designed to be a "cut above" the rest. Whether you sell complete systems, or are just looking for the best computer to support your software, call your Victor OEM specialist or mail the coupon today.

Great visibility – 800x400 pixels – graphics – 80x25 characters (soft-loaded) green phosphor-anti-glare – bit mapped.

Design for comfort – display screen tilts 0°-11° and swivels ±42° to suit the operator.

Power under the hood – 8088 – 5Mhz-2 RS232 ports – 2 parallel ports – CODEC4 bus slots.

Fuel for thought – CP/M-86 – MS-DOS – CBASIC – Basic – 86-MS-Pascal-CIS-COBOL MS-Fortran – MS-COBOL – Multiplan – VictorWriter

Ease of handling – up to 103 keys – capacity switches – sculptured – soft-loaded – 6 foot cord

Compact efficiency – 302 square inch foot print – all components separate – organize it yourself

Excellent mileage – The Victor Business Computer takes your system further for less money, Test drive it and compare.

VICTOR®

Serving American business for 65 years.

VICTOR® BUSINESS PRODUCTS

Subsidiary of Kidde, Inc.
KIDDE

Change the way you solve business problems. Get in touch with Victor at (800) 621-5559. In Illinois (800) 972-5858. We're open 24 hours a day, 7 days a week. Call now or mail this coupon.

NAME _____

TITLE _____

FIRM _____

STREET _____

CITY _____

STATE _____ ZIP _____

PHONE _____
AREA CODE _____

Mail to: Victor Business Products
P.O. Box 1135, Glenview, IL 60025 BY 8/82

Reference list: A comparison of Apple, Terrapin/Krell, and TI Logo nongraphics and graphics-related commands.

Notes

1. This list does not include the 16 color names (RED, BLUE, ORANGE, and so on) used by TI Logo, nor does it include the two-letter abbreviations available for some Logo commands.
2. Words that perform the same function but have different names are listed alphabetically by first name.
3. An asterisk beside a command denotes that, in Apple Logo, the action of the word can be limited by inclusion of an optional package name; in this case, only objects "contained" in that package are affected.
4. These descriptions are not intended to be complete definitions of individual commands. A thorough understanding of Logo is necessary to understand some of them.

Nongraphics Commands

Command	Description	Apple Logo	Terrapin/Krell Logo	TI Logo
+, -, */	adds, subtracts, multiplies, divides two numbers (integers only in TI Logo)	x	x	x
=	returns true value if two objects are equal to each other	x	x	x
<, >	does less-than or greater-than comparison on two numbers (integers only in TI Logo)	x	x	x
:	used to get the value of a variable name	x	x	x
;	used to mark the rest of the line as comments		x	x
"	used to prevent evaluation of the word that follows	x	x	x
ALLOF	returns a value of true if all inputs are true (Apple Logo uses AND; TI Logo uses BOTH)	x	x	x
ANYOF	returns true value if any of its inputs is true (Apple Logo uses OR; TI Logo uses EITHER)	x	x	x
ARCTAN	returns the arctangent of its input (Terrapin/Krell uses ATAN)	x	x	
ASCII	returns the ASCII value of the character input (TI Logo uses CHARNUM)	x	x	x
BEEP	starts a tone			x
BURY	isolates a group of procedures from the rest of the Logo workspace	x		
BUTFIRST	returns all but first letter/item of a word/list	x	x	x
BUTLAST	returns all but last letter/item of a word/list	x	x	x
BUTTONP	returns true value if specified paddle button is depressed (Terrapin/Krell Logo uses PADDLEBUTTON)	x	x	
BYE	leaves Logo			x
CALL	assigns a value to a name (Apple Logo uses NAME)	x		x
CATALOG	displays names of all files on current disk	x	x	
CATCH	user-defined error-trapping word	x		
CHAR	returns character with a given numeric value	x	x	
CLEARTEXT	clears all text from screen and puts cursor at beginning of first text line	x	x	
CLEARINPUT	clears character buffer		x	
CO	resumes execution of a procedure after a pause (Terrapin/Krell Logo can also use CONTINUE; TI Logo uses CONTINUE only)	x	x	x
CONTENTS	prints all the active names in the workspace (Apple and Terrapin/Krell Logo use .CONTENTS)	x	x	x
CONTINUE	continues a procedure that has been paused			x
COPYDEF	copies a procedure definition into a new name	x		
COS	returns the cosine of a given input (in degrees)	x	x	
COUNT	returns the number of elements in a list	x		
DEBUG	toggles debug state of computer; when on, the computer does an automatic pause when an error condition occurs			x
DEFINE	allows a new procedure to be defined under program control (without entering Edit mode)	x	x	x
DEFINEDP	returns true value if its input is the name of a defined procedure	x		
DISK	returns drive, slot, and volume number of current disk	x		
DIFFERENCE	returns the difference of two numbers			x
DOS	allows Logo to execute an Apple DOS command		x	
EDIT	allows editing of an existing procedure	x	x	x
EDNS *	allows editing of a group of variable definitions (stands for "edit names")	x		
ELSE	marks action taken if the conditional expression of an IF statement is false (Apple Logo uses brackets in place of ELSE keyword)	x	x	x
EMPTYP	returns true value if object named is an empty list or word	x		
END	signals the end of a procedure	x	x	x
EQUALP	returns true value if two objects are equal (TI Logo uses IS)	x		
ERALL *	erases all objects (Terrapin/Krell Logo uses ERASE ALL)	x	x	
ERASE	deletes the named procedure from the workspace (Apple Logo can delete multiple procedures)	x	x	x
ERASEFILE	erases a file from the disk	x	x	
ERASEPICT	erases a graphics image from the disk		x	
ERN	erases a list of variables from the workspace (Terrapin/Krell Logo uses ERNAME, which erases only one variable; ERN stands for "erase name")	x	x	

SUPER MICRO COMPUTERS

from \$2,395.00



CI-MWS03-SB — LSI 11/2 computer workstation. LSI 11/2 CPU, 64KB Memory, power supply, KEV 11, in 16 slot rack mountable chassis. 2 port serial I/O. CRT terminal. 1 mega byte floppy disk system. Desktop workstation **\$7,795.00**

CI-MWS23-MB — LSI 11/23 computer workstation. LSI 11/23 CPU, MMU, 256KB Memory, power supply, in 16 slot rack mountable chassis. CRT terminal. 10 mega byte cartridge disk system. 4 port serial I/O. Desktop workstation **\$11,295.00**

CI-103 DESKTOP COMPUTER — Complete computer system enclosed within a VT103 video terminal with LSI 11/2 and 64KB Memory **\$3,295.00**
With LSI 11/23 and 256KB Memory **\$4,995.00**



CI-1103LK — LSI 11/2 CPU, 64KB Memory, power supply, KEV 11 in 16 slot rack mountable chassis **\$2,395.00**



CI-11/23 AC — LSI 11/23 CPU, MMU, 256KB Memory, power supply, in 16 slot rack mountable chassis **\$3,795.00**

CI9448-96 — 96 mega byte cartridge disk system with controller. 80 mega bytes fixed and 16 mega bytes removable **\$10,500.00**

CI-1220 — Dual drive, double density, double sided, 2MB capacity floppy plus DMA LSI 11 controller **\$2,795.00**

DON'T ASK WHY WE CHARGE SO LITTLE, ASK WHY THEY CHARGE SO MUCH.



Chrislin Industries, Inc.

31352 Via Colinas • Westlake Village, CA 91362 • 213-991-2254

TWX 910-494-1253 (CHRISLIN WKVG)

LSI II is a trademark of Digital Equipment Corp.

Nongraphics Commands

		Apple Logo	Terrapin/Krell Logo	TI Logo
ERNS *	erases a list of variables from the workspace (stands for "erase names")	x		
ERPS *	erases a list of procedures from the workspace (stands for "erase procedures")	x		
ERROR	prints out information explaining the most recent error	x		
FIRST	returns the first letter/item of a word/list	x	x	x
FPUT	makes an object the new first element of an existing list	x	x	x
GOODBYE	reinitializes Logo; all previous work is lost		x	
GO	goto statement for use within a Logo procedure	x	x	x
GPROP	returns the value of a certain property of a variable	x		
GREATER	returns true value if the first of the two numbers is greater than the other			x
IF	signals the beginning of an <i>if...then...else</i> construct in Logo	x	x	x
IFF	states the action to be taken if a previous test is false (Apple and Terrapin/Krell Logo also use IFFALSE)	x	x	x
IFT	states the action to be taken if a previous test is true (Apple and Terrapin/Krell Logo also use IFTRUE)	x	x	x
INT	returns the integer portion of a number (Terrapin/Krell Logo uses INTEGER)	x	x	
IS	returns true value if two items are equal			x
ITEM	returns the <i>n</i> th item in a list	x		
KEYP	returns true value if a key has been pressed but not yet read (Terrapin/Krell and TI Logos use RC?)	x	x	x
LABEL	within a procedure, used to mark the destination of a goto statement (TI and Terrapin/Krell Logo use the label name and a colon only)	x	x	x
LAST	returns the last letter/item of a word/list	x	x	x
LESS	returns true value if the first of two numbers is less than the second			x
LIST	makes a list from a series of items	x	x	
LISTP	returns true value if the variable named is a defined list (Terrapin/Krell Logo uses LIST?)	x	x	
LOAD	loads the contents of a disk file into the Logo workspace (TI Logo uses RECALL, Terrapin/Krell Logo uses READ)	x	x	x
LOCAL	declares a variable as local to the enclosing procedure without making it the argument of the procedure	x		
LPUT	makes an object the new last element of an existing list	x	x	x
MAKE	assigns a name to a value	x	x	x
MEMBERP	returns true value if the given object is an element of the given list	x		
NAMEP	returns true value if the given name has a value	x		
NOBEEP	turns off the tone started by BEEP			x
NODES	returns the number of free nodes in the system (Terrapin/Krell Logo uses .NODES)	x	x	
NOT	inverts a logical value	x	x	x
NOTRACE	turns off tracing feature		x	
NUMBERP	returns true value if its input is a number (Terrapin/Krell and TI Logo use NUMBER?)	x	x	x
OUTDEV	directs output to a device connected to Logo through an Apple peripheral card (Apple Logo uses .PRINTER)	x	x	
OUTPUT	causes a procedure to end and return a value to its caller	x	x	x
PA *	prints all procedures and names in the workspace (Apple Logo uses POALL; Terrapin/Krell Logo uses PRINTOUT ALL)	x	x	x
PACKAGE	puts a list of procedures into a named package	x		
PADDLE	returns the numeric value associated with a paddle (TI Logo uses JOY)	x	x	x
PAUSE	suspends execution of an executing procedure and allows user to interact with Logo from the keyboard (TI Logo uses the Aid key)	x	x	x
PKGALL	puts everything not already in a package into a named package	x		
PLIST	returns the property list of an object	x		
PN *	prints all the names in the workspace (Apple Logo uses PONS; Terrapin/Krell Logo uses PRINTOUT NAMES)	x	x	x
PO	prints a given procedure (Apple Logo can print several procedures; Terrapin/Krell Logo also uses PRINTOUT)	x	x	x
POPS *	prints the definitions of all procedures (Terrapin/Krell Logo uses PRINTOUT PROCEDURES)	x	x	
POTS *	prints all the procedure names in the workspace (TI Logo uses PP; POTS stands for "print out titles")	x	x	x
PPS *	prints all the property lists (stands for "print out properties")	x		
PRIMITIVEP	returns true value if the object is a Logo primitive	x		
PRINT	prints what follows and begins a new line	x	x	x
PRINT1	prints what follows without beginning a new line (TI and Apple Logos use TYPE)	x	x	x
PRINTCHAR	prints the character with a given number value			x
PRODUCT	calculates the product of two numbers	x		x
QUOTIENT	calculates the integer portion of the quotient of two numbers	x	x	x
RANDOM	generates a random number between 0 and <i>n</i> (TI Logo always generates an integer between 0 and 9)	x	x	x



The First solution to the Pascal dilemma.

Pascal is unbeatable for large, complex programs.

Its structure and readability help you write reliable, maintainable code.

But when it comes to debugging, most Pascals are no help at all. And no matter which version you use, you're faced with a dilemma: stick to the "standard" subset, and forgo some of your machine's best features. Or use all the power of your compiler and hardware, but end up with a program that's difficult to move to another environment.

Introducing PascalSET™ Software Engineering Tools

PascalSET is a source code preprocessor that adds three much-needed facilities to virtually any Pascal system:

PMacro™

Lets you define extensions to Pascal, which are expanded (before compilation) into the appropriate code sequence. So you can use nonstandard language features without sacrificing portability. In fact, using PMacro's conditional expansion capability, you can create one version of your source program that produces the correct code for several different versions of Pascal.

PTrace™

Slashes debugging time by generating a complete execution trace—of any program, in any environment. Procedure entries and exits are recorded, along with values of selected variables. Tracing can be turned on and off by program events, and a profiling feature identifies "most used" code to guide optimization efforts.

PAdapt™

Adds a variety of Ada-style extensions to Pascal, including handling of exception conditions (such as bad input), explicit closure of conditionals and loops to improve structure ("END IF"; "END WHILE"; etc.), and specification of procedure parameters as input-only, output-only, or input/output.

PascalSET runs on virtually any system supporting standard Pascal. PMacro, PTrace, and PAdapt are also available as separate tools.

If you're involved in large-scale system or application development, PascalSET can give you a big productivity boost—for a minimal investment.

Call or write for details today.

Tell me more about PascalSET for my system.

Computer _____

Compiler _____ (Supplied by _____)

Name _____

Company _____

Street _____

City _____ State _____ Zip _____

Phone () _____

First Systems Corporation
865 Manhattan Beach Blvd.
Manhattan Beach, CA 90266
(800) 722-8679
in California: (213) 546-5581

BY8



**First Systems
Corporation™**

Products for productivity.

Circle 176 on Inquiry card.

©1982 First Systems Corporation

Nongraphics Commands

		Apple Logo	Terrapin/Krell Logo	TI Logo
RANDOMIZE	randomizes the values of all future calls to RANDOM; RANDOMIZE <i>n</i> sets up a repeatable set of values		x	
READCHAR	waits for a keypress, returns its numeric value (Terrapin/Krell Logo uses READCHARACTER)	x	x	x
READLINE	takes all data typed in up to a carriage return and stores it as a list (Apple Logo uses READLIST; Terrapin/Krell Logo uses REQUEST)	x	x	x
READPICT	reads a picture file from the disk		x	
RECYCLE	performs a garbage collection to regroup unused nodes into one area (Terrapin/Krell Logo uses .GCOLL)	x	x	
REMAINDER	returns the remainder of a division operation	x	x	
REMPROP	removes a property from an object	x		
REPARSE	re-analyzes procedures in a workspace after other procedures have been erased	x		
REPEAT	executes a list a given number of times	x	x	x
RERANDOM	causes the RANDOM function to behave in a reproducible way (Terrapin/Krell Logo uses RANDOMIZE)	x	x	
ROUND	returns the input number rounded to the nearest integer	x	x	
RUN	executes the actions specified in a list	x	x	x
SAVE *	stores data or procedures on disk (TI Logo can also store to a cassette tape; Terrapin/Krell Logo can save entire workspace only)	x	x	x
SAVEPICT	saves the current graphics image on disk		x	
SENTENCE	joins two or more inputs (words or lists) into a list	x	x	x
SETDISK	specifies drive, slot, and volume number of active disk	x		
SHOW	prints the given object followed by a carriage return	x		
SIN	returns the sine of a given input (in degrees)	x	x	
SQRT	returns the square root of a given input	x	x	
STOP	stops a procedure	x	x	x
SUM	returns the sum of two numbers (Apple Logo can take more than two inputs)	x		x
TEST	evaluates a condition, influences execution of subsequent IFFALSE or IFTRUE command	x	x	x
TEXT	returns a list that contains the contents of a procedure	x	x	x
THEN	marks action taken if the conditional expression of an IF statement is true (Apple Logo uses brackets in place of THEN keyword)	x	x	x
THING	returns the value of the input object	x	x	
THING?	returns true value if input object has a value		x	x
THROW	user-defined error-trapping word	x		
TO	begins the definition of a procedure	x	x	x
TOPLEVEL	aborts all executing procedures (Apple Logo uses THROW "TOPLEVEL")	x	x	
TRACE	causes Logo to single-step through execution of all following Logo procedures until NOTRACE is executed		x	
TRACEBACK	if a program is paused, this command shows the user the nesting of procedures to get to the point at which the program is paused; a debugging aid			x
UNBURY	cancels the effect of a previous BURY command	x		
WAIT	pauses the program for a specified time	x		x
WORD	joins two numbers/words to make a single number/word	x	x	x
WORDP	returns true value if its input is a word (Terrapin/Krell and TI Logo use WORD?)	x	x	x
.BPT	exits to the Apple monitor	x	x	
.CALL	transfers control to a user-supplied machine-language subroutine		x	
.CONTENTS	outputs a list of information about all the items in the workspace	x		
.DEPOSIT	"pokes" a value from 0 to 255 in a specified memory location	x	x	
.EXAMINE	"peeks" the 8-bit value in a specified memory location	x	x	

Graphics-related commands

BACK	moves the turtle backward	x	x	x
BACKGROUND	(Apple Logo) returns the color number of the current background	x		
BACKGROUND	(Terrapin/Krell Logo) sets the background to a given color (Apple Logo uses SETBG; TI Logo uses COLORBACKGROUND)	x	x	x
BACKGROUND	(TI Logo) names the background of the screen as object being talked to			x
CARRY	tells a sprite which object to carry (LOOKLIKE is a synonym in TI Logo)			x
CLEAN	clears the screen of turtle graphics but doesn't move the turtle (Terrapin/Krell Logo uses CLEARSCREEN)	x	x	
CLEARSCREEN	changes video display to turtle graphics screen, clears screen, and initializes turtle (TI Logo uses TELL TURTLE; Terrapin/Krell Logo uses DRAW)	x	x	x
CLEARTEXT	clears the text screen (TI Logo uses CLEARSCREEN)	x	x	x
COLOR	returns the color number of the sprite currently being talked to			x
CURSOR	(Apple Logo) returns the position of the cursor	x		
CURSOR	(Terrapin/Krell Logo) puts the text cursor at the given location (Apple Logo uses SETCURSOR)	x	x	

IT'S CRISP. IT'S CLEAR. IT'S COMPATIBLE.



Amdek's Video-300 green phosphor monitor is the easy-reading choice for almost any system — including IBM and Apple.

Everything about our 12" Video-300 monitor was designed to be easy. Easy to read. Easy to use. And easy to match up with practically any computer or word processing system, including the popular Apple and IBM personal computers. So it's easy to see why you should choose Video-300 for your text display needs.

Amdek's Video-300 monitor features:

- Non-glare screen to eliminate distracting reflections
- P-31 green phosphor display for no-strain viewing
- 80 x 24 character display
- 18MHz band width 900 lines (center) resolution
- Built-in carrying handle for portability
- Light-weight, industrial-grade cabinetry (only 17 lbs.)
- UL, FCC approved
- Full one-year warranty covering parts and labor

So ask your dealer about Video-300 — part of Amdek's complete line of color, green phosphor and black and white monitors. Then match Video-300's performance and price against any other display monitor. For quality and value, you'll choose Amdek.

AMDEK

Amdek Corporation, 2420 E. Oakton St., Suite E, Arlington Heights, IL 60005. (312) 364-1180 • TLX: 25-4786

Graphics-related Commands		Apple Logo	Terrapin/Krell Logo	TI Logo
DOT	puts a dot at the indicated point on the turtle graphics screen	x		x
DRAW	clears the graphics screen, makes the turtle visible, and puts it in the center of the screen		x	
EACH	allows a set of commands to be applied to each of a group of sprites, in turn			x
FENCE	tells turtle to draw without wraparound—gives error message if turtle tries to plot offscreen (Terrapin/Krell Logo uses NOWRAP)	x	x	
FORWARD	moves the turtle forward	x	x	x
FREEZE	stops all sprite movement			x
FULLSCREEN	devotes entire screen to graphics (no text lines at bottom)	x	x	
HEADING	returns the heading number of the active sprite or turtle	x	x	x
HIDETURTLE	makes the triangular turtle shape disappear	x	x	x
HOME	tells active turtle or sprite to go to center of screen	x	x	x
LEFT	turns turtle or sprite left a given number of degrees	x	x	x
MAKECHAR	allows user to redefine the shape of a given character (tile)			x
MAKESHAPE	allows user to redefine the shape of a given sprite			x
NODRAW	returns the entire video display to display of text (Apple Logo uses TEXTSCREEN; TI Logo uses NOTURTLE)	x	x	x
NUMBEROF	allows user to check current value of a system variable (color, speed, etc.)			x
PEN	returns values for pen type and color	x		
PENCOLOR	(Apple Logo) returns value of pen color	x		
PENCOLOR	(Terrapin/Krell Logo) sets the current turtle pen color (Apple Logo uses SETPC)		x	
PENDOWN	makes the turtle pen ready to draw a line	x	x	x
PENERASE	makes the turtle pen ready to erase a line	x		x
PENREVERSE	makes the turtle pen ready to reverse a line (draws if line isn't there, erases if it is; Terrapin/Krell Logo must use PENCOLOR 6 to get same effect)			
PENUP	makes the turtle pen inactive	x	x	x
POS	returns the position of the turtle (TI Logo uses WHERE)	x		x
PUTTILE	places a given tile (character) at a given location			x
RIGHT	turns a turtle or sprite right a given number of degrees	x	x	x
SCRUNCH	returns the current horizontal-to-vertical aspect ratio for output to the video screen	x		
SETCOLOR	tells a sprite, tile (character), background, or the turtle's pen what color to be			x
SETHEADING	gives the active sprite or turtle a given heading	x	x	x
SETPEN	sets color and type of turtle pen	x		
SETPOS	moves the turtle to a new position (TI Logo uses SXY, which can also move sprites; Terrapin/Krell uses SETXY)	x	x	x
SETSCRUNCH	sets a new horizontal-to-vertical video display aspect ratio (Terrapin/Krell Logo uses .ASPECT)	x	x	
SETSPEED	gives the active sprite a given speed			x
SETX,SETY	moves turtle to given x- or y-coordinate, other coordinate unchanged (TI Logo uses SX and SY, which can also move sprites)	x	x	x
SHAPE	returns the shape number of the active sprite			x
SHOWNP	returns true value if turtle is visible	x		
SHOWTURTLE	makes the triangular turtle shape appear	x	x	x
SPEED	returns the speed value of the active sprite			x
SPLITSCREEN	removes bottom area of graphics screen for text area	x	x	
SPRITE	optional word used with TELL to name a given sprite as the object being talked to			x
SV	sets the x- and y-velocity of the active sprite			x
SXV,SYV	gives the active sprite a new x- or y-velocity			x
TELL	used to activate a sprite, group of sprites, tile (character), background, or turtle to respond to future commands			x
THAW	restores sprite movement after FREEZE command			x
TILE	used with TELL to make a given tile active			x
TOWARDS	returns heading value turtle would have if it were pointing toward a given position	x	x	
TURTLE	used with TELL to make the turtle active			x
TURTLESTATE	returns pen position, turtle status, background color, and pen color		x	
WHO	gives the type and number of the active object (tile, sprite, turtle, etc.)			x
WINDOW	allows the turtle to plot offscreen (although the plotting can never be seen)	x		
WRAP	causes the turtle to appear on the opposite side of the screen if it attempts to go offscreen	x	x	
XCOR,YCOR	returns the x- or y-coordinate of the active sprite or turtle	x	x	x
XVEL,YVEL	returns the x- or y-velocity of the active sprite			x
YOURNUMBER	returns the number of the active sprite			x

AND NOW... A 32-BIT CAD/CAM SYSTEM FOR UNDER \$80,000

Last year Auto-trol Technology Corporation shipped the industry's first 32-bit turnkey CAD/CAM system. Now we are introducing the first 32-bit CAD/CAM system for under \$80,000... the Advanced Graphics Workstation (AGW).

For the smaller user...a low cost, high performance system.

The AGW is a full function, 32-bit computer...at an affordable price. With its own 32-bit processor and powerful virtual operating system, each AGW has the necessary performance to run Auto-trol's state-of-the-art 3-D engineering design, analysis and manufacturing software. And with FORTRAN and PASCAL compilers, it's an excellent development and engineering tool, as well as a complete CAD/CAM system...all for under \$80,000.

For the larger user...high speed networks and communications.

For companies with larger requirements, the AGW can communicate with a variety of mainframes. And it's the only CAD/CAM system that provides the power and flexibility of a high speed local area network. This 12 Mhz network provides the necessary levels of interactivity required for CAD/CAM applications and reduces overall systems costs through effective sharing of resources on the network.

For all users...unlimited growth at affordable prices.

AGW's may operate as stand-alone systems or be linked to over 100 other AGW's via our high performance network. Therefore, any company can install this system and have the confidence that as their needs grow...so can their system...be it from one to two to one hundred users.

Auto-trol and the VAX...our other low cost CAD/CAM solution.

Our mechanical design and manufacturing software was introduced on Digital Equipment Corporation's widely used VAX series of 32-bit computers. To meet your needs, a VAX processor can be purchased as part of a turnkey system supplied by Auto-trol. Or, our software and widely acclaimed CC-80 workstation can be added to your installed VAX giving you another high performance entry into CAD/CAM for under \$80,000.

For more information call Bob Michaels Toll-Free 1-800-525-8741.

Auto-trol®
Technology Corporation

A glimpse into the future of
CAD/CAM...today.



Test # (see caption)	Time to Execute, in Seconds, When Running:		
	Apple Logo	Terrapin/Krell Logo	TI Logo
Test 1	6.2	7.0	14.9
Test 2	4.5	5.0	N/A

Table 4: Timing benchmarks of three implementations of Logo. The program being timed in test 1 is the Logo command SORT (LOGO IS AN INTERESTING LANGUAGE FOR PICTURE DRAWING, LIST MANIPULATION, AND EDUCATION). The program being timed in test 2 is SORT [Z Y X W V U T S R Q P O N M L K J I H G F E D C B A]. See listing 2 for the definition of SORT. The N/A under TI Logo for test 2 refers to the fact that TI Logo did not finish this test; it gave the error message OUT OF SPACE AT LEVEL 23 LINE 1 OF SORT. The times, given in seconds, are accurate to two significant digits. Also, the comments were taken out of the procedures before the benchmarks were run.

Text continued from page 278:

than it is here. All the Apple- and TI-based versions of Logo are products of higher caliber than what we're used to seeing in the microcomputer software industry.

If you don't already have a computer, then your choice of computer will be influenced by such questions as: How much money do I have to spend? What things other than Logo do I want to do with this computer? What kind of person will be using Logo? and Do they have any special needs that would influence my choice? If you already have an Apple computer and don't know which version of Logo to buy, your choice will be influenced by the individual features of each version and how they

relate to the intended users and programmers. (My own opinion is that Apple Logo is better for situations involving nontechnical users and that Terrapin Logo is oriented more toward the sophisticated programmer.)

Conclusions

Apple Logo is a very well done implementation of Logo. It contains some advanced features (such as property lists and packages) as well as extremely good documentation and features that are oriented toward usage by children or adults who don't have technical backgrounds. Several features—including its unnecessary use of Logo command inputs in list

form and its lack of provision for comments—are not consistent with this orientation and may cause non-technical users some problems at first. A sprite board will probably be available from the implementers of Apple Logo, Logo Computer Systems Inc.

Terrapin/Krell Logo is also very well done. It includes such advantages as a Utilities Disk with useful programs, a 6502 assembler, and the ability to interface Terrapin/Krell Logo with assembly-language routines. It has a program-tracing function that is *very* useful during debugging, and its editor and error messages are slightly better than those of Apple Logo. The documentation is very good, and a sprite board (probably cheaper than Apple Logo's but with somewhat different features) will be available. Your choice of Krell or Terrapin Logo will depend on the factors mentioned in the text of this article.

TI Logo is a good implementation of Logo, but it is not as good as the Apple versions. Its advantages are its low cost, sprites, and tiles; disadvantages include a smaller workspace and slower execution than in the Apple-based Logos, poor keyboard layout, and some irregularities in the system caused by poor design decisions. ■

Expand your IBM PC...

256K IBM PC RAM EXPANSION BOARD

Model No. ADS 5001
with parity upgraded
at 64K intervals

SUGGESTED LIST PRICE

- W/64K RAM \$380.00
- W/128K RAM 655.00
- W/192K RAM 795.00
- W/256K RAM 995.00

Distributor and Dealer Inquiries welcome

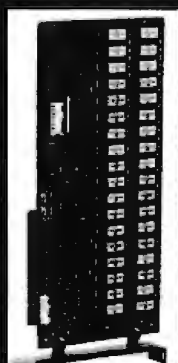

ADS 8001 DOT MATRIX PRINTER

PRINT FEATURES

Print Speed: 120 CPS

Characters: 8 sizes, 5 different alphabets, upper/lower case descenders

Print Width: 8 in. max., Form Width: 4.5 in. to 10 in.

Print Mode: 9x9 exceptional quality with proportional spacing

Graphics: 144x144 dots/in. square and block graphic in ROMs

Print Head: 9 pins, heavy duty designed with air-cooled fins

Number of Columns: 136 max.

Print Direction: Bidirectional logic seeking

Form: Folded/Single sheet

Form Feed: Tractor and friction, bidirectional

Number of Copies: Original plus 3

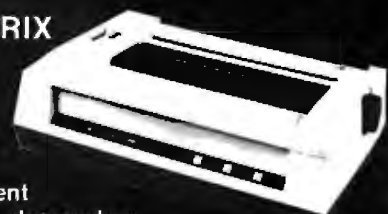

ANTEX DATA SYSTEMS

A Division of International Antex, Inc.

2630 California Street, Mountain View, California 94040

(415) 941-7914

TWX 910-373-8500 "INTERAX PTVY"

UL Listed

A General-Purpose I/O Board for the TRS-80 Models I and III

The system bus is described, and plans are presented for an interface board with 24 lines of discrete input/output.

William Barden Jr.
28122 Orsola
Mission Viejo, CA 92692

Several months ago (June 1982 BYTE, page 260) I described a general-purpose input/output (I/O) board for the TRS-80 Color Computer. This month I'll describe its counterpart, a general-purpose I/O board for the TRS-80 Model I and Model III. As I imagine that few of you have both a Color Computer and a Model I or III and perhaps some did not read the earlier article, I'll give you the details on the logic of the board, even though it is very similar to the Color Computer version. I'll also describe the internal workings of the Model I/III system bus, which is quite a bit different from the Color Computer bus. And I'll give you the story on the slight differences between the Model I and III buses in the way the external I/O is connected.

The System Bus

It's true the Model I/III system bus

About the Author

William Barden Jr. has written numerous books on microcomputer design and programming, including *Microcomputer Math*.

is closely related to the Z80 microprocessor signals, although the Z80's manufacturer, Zilog, might not speak of it in mixed company. To describe the Model I/III system bus, therefore, I have to start with the Z80 signals.

Figure 1 on page 292 shows a general block diagram of the TRS-80 Model I system bus. In the following discussion, I'll talk about the Model I bus and then describe the Model III bus, which has some embellishments.

Model I bus. The Z80 has 16 address lines, labeled A15 through A0, most significant to least significant. The address lines are used to address RAM (random-access read/write memory), ROM (read-only memory), and I/O devices. The 16 address lines allow the Z80 to address 64K bytes of memory and 256 I/O devices.

Perhaps I'd better explain that the Z80 can use both memory-mapped and input/output-mapped I/O. Input/output-mapped I/O means that the Z80 has separate instructions (IN and OUT) for input/output, allowing

all of the 64K-byte addresses to be used for memory if the system designer chooses. Input/output is specified by certain control signals that inform an external I/O device when an IN or OUT machine-language instruction, rather than a "memory-reference" instruction, is being executed.

Memory-mapped I/O is used in computers based on chips like the 6502 and 6809. A portion of the 64K-byte address space is dedicated to I/O addresses, and there are no control signals to indicate that input/output is being performed. To the processor, an input/output operation looks just like reading or writing data into memory. Of course, the system designer allocates certain addresses to memory and certain addresses to input/output devices, and the programmer works with this allocation in mind at all times.

The Models I and III were designed with both memory-mapped I/O and input/output-mapped I/O, as shown in figure 2. The keyboard, for exam-

Text continued on page 294

S-100 Boards from S. C. Digital

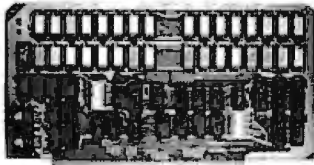

256K DYNAMIC RAM

features: **Model 256KE**
 • 16 or 24 bit address. • 8/16 bit wide data • Transparent refresh with unlimited OMA, immune to Wait States, halts, resets. • Fast access time 180nsec from Smemr or Psync high, will run with Z80, Z8000 to 6mhz, 8080, 8085, 8086 to 8mhz without Wait States. • Accepts 4116, 4164's.

64K DYNAMIC RAM 'Uniselect: 2'

features: **Model 64KUS**
 • 16 or 24 bit address. • 8 bit data. • Bank select by SW settable port, bits in two blocks. • Two 32kb (128kb) addressing. • Transparent refresh - same as M:256KE. • Fast access time - 220nsec, will run with Z80, Z8000 to 4mhz, 8080, 8085, 8086, 8088 to 5mhz without Wait States. • Can be configured to various multiusers OS's. • Expandable to 256KB using 4164's.

32K STATIC RAM 'Uniselect: 3'

features: **Model 32KUS**
 • Fully Static using 2k by 8 MOS chips. • 16 or 24 bit address. • 8/16 bit wide data. • Bank Select by port and bit in 32K block. • Two 16K block addressing with window capability in 2k increments. • EPROM can be mixed with RAM. • Fast access - 250nsec from address valid - will run with Z80, Z8000 to 4mhz, 8080, 8085, 8088, 8086 to 68000 to 8mhz without Wait States. • Provision for Battery Backup.

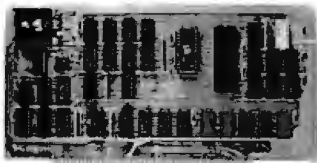

Z80 CPU Board

features: **Model CPU1 Z80**
 • 2 or 4mhz clock. • Jump on Reset. • 8 levels of prioritized vectored interrupts.

I/O, Memory Interface 'Interface: 1'

features: **Model 3SPC**
 • 3 serials using UART, RS-232C or 20ma current loop. • 1 Parallel I/O with hand shakes. • 4k Ram, 4k EPROM (not supplied). • Built in Kansas City Audio Cassette interface. • Baud rate generator from 19.2kbaud to 110 baud.

2K Z80 Monitor Program

available for M:3SPC

features: many routines including breaker points, cassette record and play back . . . etc. Comes in 2 EPROMs and 1K RAM.

All boards conform to IEEE696/S100 specifications, fully socketed, screened legends, masks, Gold contacts. Guaranteed One Full year.

Model	Prices	with	
256KE	\$795	256KB	AGT
256KE-12B	\$535	128KB	AGT
64KUS-64	\$395	64KB (4164's)	AGT
64KUS	\$395	64KB (4116's)	AGT
64KUS-16	\$285	16KB	AGT
32KUS	\$369	32KB with CMOS	AGT
32KUS-16	\$259	16KB with CMOS	AGT
32KUS-N	\$149	no memory	AGT
CPU1-Z80	\$219	with interrupt	AGT
CPU1-Z80-K	\$149	no interrupt	Kit
3SPC	\$229	with cassette	AGT
3SPC-KC	\$159	with cassette	Kit
2K Monitor	\$ 55	with 1K Ram	

Delivery is within 3 working days. MC, Visa or COO orders accepted. Illinois residents add 5 1/4% sales tax.

D.E.M. & DEALER PRICING AVAILABLE

S. C. DIGITAL

P.O. Box 906
 1240 N. Highland Ave., Suite #4
 Aurora, Illinois 60507
 Phone: (312) 897-7749

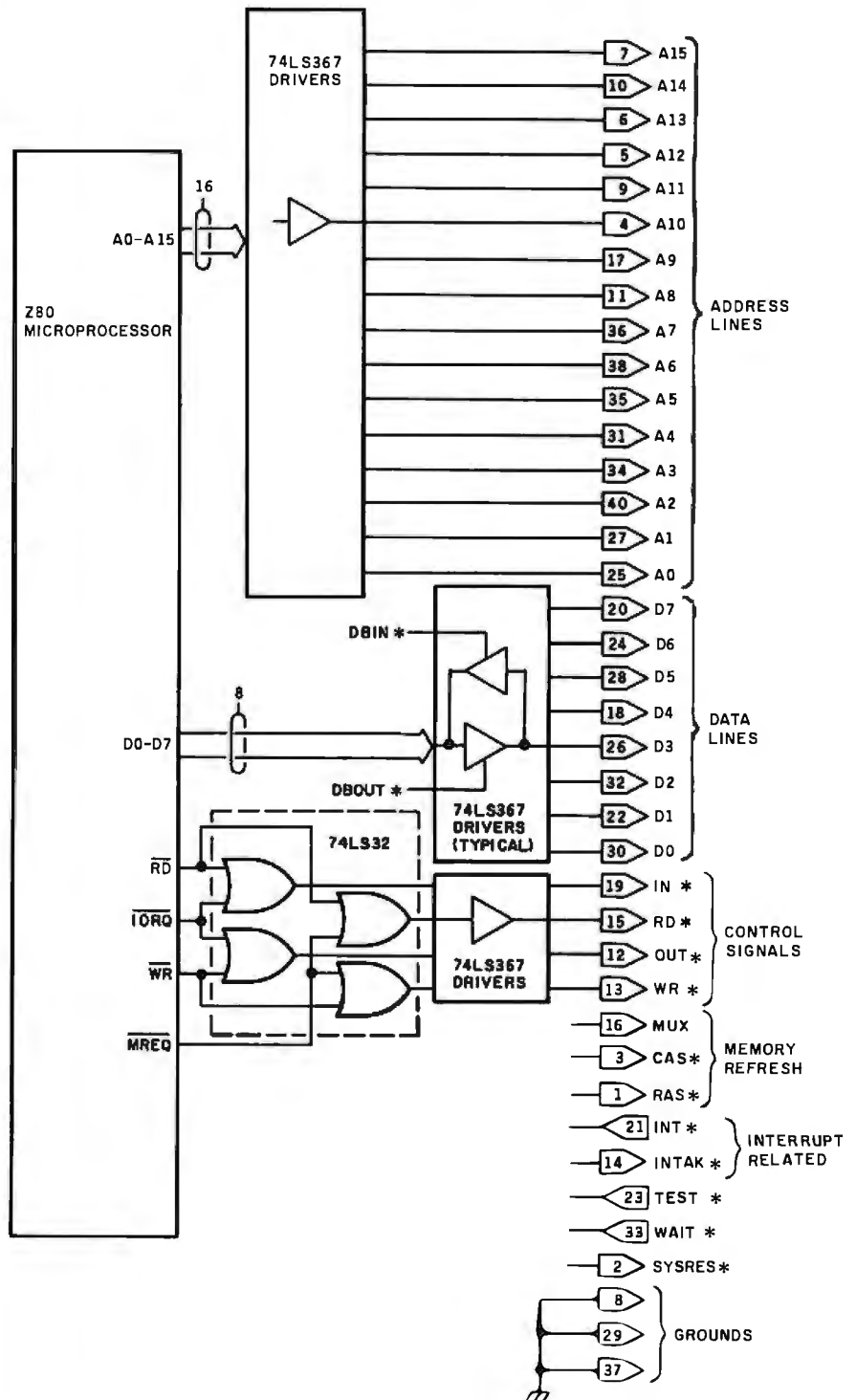
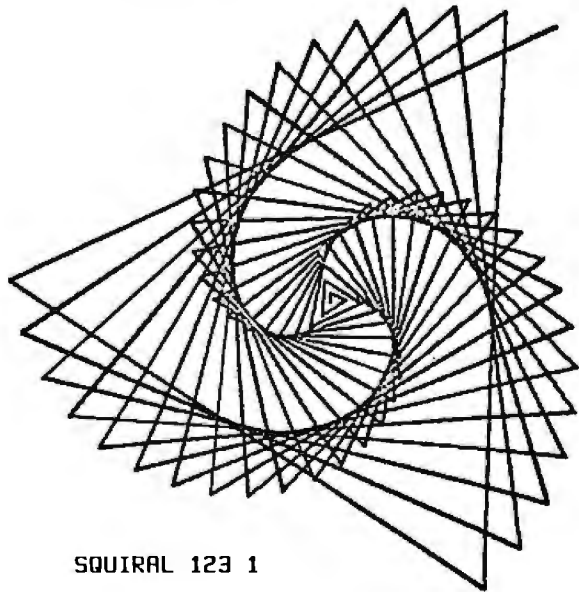

Figure 1: The system bus for the Model I is made up of 40 lines, very closely related to Z80 signals. Sixteen are address lines, eight are data bus lines, four are control signals for external devices, and the remainder are related to memory refresh, interrupt operations, and miscellaneous functions.

The Logo Language is Here for the Apple II

```
TO SQUIRAL :ANGLE :DISTANCE
  IF :DISTANCE > 200 THEN STOP
  FORWARD :DISTANCE
  RIGHT :ANGLE
  SQUIRAL :ANGLE :DISTANCE + 3
END
```



SQUIRAL 123 1

Terrapin, the Turtle Company, brings you the Terrapin Logo Language for the Apple II with Turtle graphics, now ready for immediate delivery.

The Terrapin Logo language is a sophisticated and powerful language that is easy for anyone to use. Although originally intended for children, the Logo language is one that the most advanced programmers will enjoy using too. It includes many features common to artificial intelligence research languages permitting programs of great power to be written quickly and easily. Writing comparable programs in other languages is usually much more difficult and time consuming.

The Turtle graphics is fun and easy. With simple commands such as FORWARD, RIGHT, and PENUP you can draw in six hi-res colors. In just a few short sessions you can learn to create figures more complex than the one above whether you know how to program or not.

But the Terrapin Logo language is more than just a graphics language. It supports:

- list structure, allowing easy manipulation of words (strings) and lists
- user defined procedures which can be used exactly as if they were part of the language.
- fully integrated screen editor for procedures and text
- floating point and integer arithmetic
- a total of 120 primitives (commands) including 30 graphics commands
- recursion
- assembly-language interface capability

The Terrapin Logo language was developed by the Artificial Intelligence lab at the Massachusetts Institute of Technology. Terrapin is now authorized by MIT to distribute the results of its 12 years of research to you. To provide quality support for the language, Terrapin has assembled a team that includes two of the three authors who developed the Logo language for the Apple II at MIT, as well as Dr. Feurzeig, an originator of the Logo language.

Every copy of the Terrapin Logo language comes with complete documentation. To run the language, a 48K Apple II with a 16K RAM card or a language card, and one disk drive is required.

Terrapin also offers the robot Turtle, and the following books: *Turtle Geometry*, *Special Technology for Special Children*, *Mindstorms*, *Katie & the Computer*, and *Logo for the Apple II* from Byte Books.

Suggested retail price: \$149.95

To order or for more information, call or write:



Terrapin, Inc.

380 Green Street
Cambridge, MA 02139
(617) 492-8816

In Canada:
SES Computing, Inc.
(416) 366-4242

Dealer Inquiries invited.

Best prices anywhere We beat 'em all!

—COMPUTERS—

ALTOS—List.....	Less 20%
NorthStar HORIZON HRZ-2-QD..	\$ 2685
ADVANTAGE.....	\$2985
TeleVideo Computer Systems ...	Call
SUPERBRAIN 64K DD.....	1995
64K QD.....	2395
DSS-10 Meg. H D.	2895
CROMEMCO CS-1.....	3195
CS2.....	3549
CS-3.....	5595
ZH.....	7995
ZENITH Z-90 w/DRIVE.....	2299
Z-89.....	2099

—TERMINALS—

TeleVideo 910C.....	569
912C.....	659
920C.....	719
925.....	719
950.....	915
OKIDATA Microline 80.....	329
Microline 82A.....	469
Microline 83A.....	739
Microline 84.....	Call For Price

C.ITO Call For Price

SOROC IQ 130.....	585
IQ 135.....	719
IQ 140.....	995
HAZELTINE 1420.....	589
1500.....	845
1510.....	1029
ZENITH Z19.....	689

—PRINTERS—

CENTRONICS 739-1 (parallel).....	499
739-3 (RS232C).....	599
704-11 (parallel).....	1569
704-9 (RS232C).....	1519
TI 810 Basic.....	1289
810 Full.....	1549
820 RO Basic.....	1545
NEC 7710 (RS 232).....	2295
3510.....	Call
QUME 9-45 Full Option.....	2125
9-45 Limited.....	2099
Diablo 630 RO.....	2049
PRISM 80.....	895
132 w/color.....	1495
Epson MX-80.....	441
MX-80 FT.....	548
MX-100.....	745

—DISK SYSTEMS—

MORROW Discus 2D.....	835
Dual Discus 2D.....	1385
Discus 2 + 2.....	1069
M5 5Meg. Hard Disk.....	1949
M10. 10 Meg. H D.....	2995
M 26, 26 Meg. H D.....	3349
Decision I.....	1339
CORVUS 5 Meg. Hard Disk.....	2555
10 Meg. Hard Disk.....	3955
20 Meg. Hard Disk.....	4755

Prices are for prepaid orders only, and reflect a cash discount. Charge card orders are slightly higher.

Computers Wholesale

Box 91 Brewerton, N.Y. 13029
315-472-3055

Most items in stock for immediate delivery. Factory sealed cartons. w/full factory warranty. NYS residents add appropriate sales tax. Prices do not include shipping. C.O.D. orders require 25% deposit. Prices subject to change without notice.

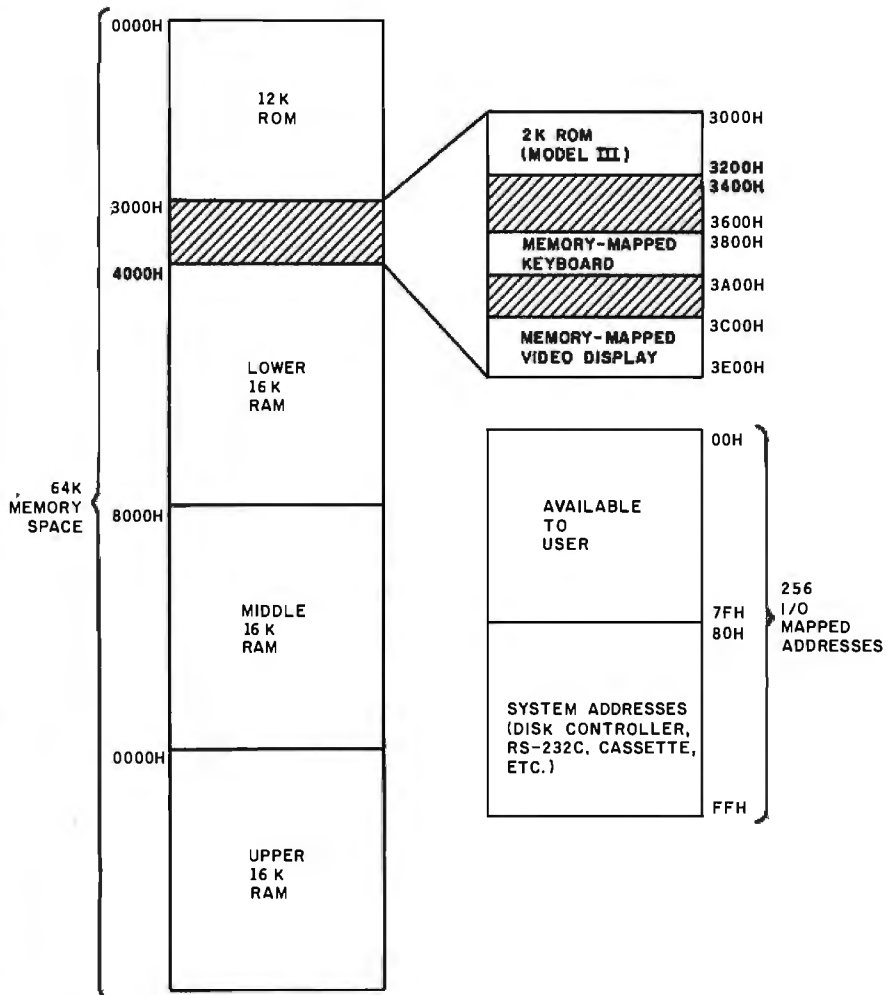

Figure 2: The Models I and III have 64K bytes of addressing space. Some system devices are memory-mapped and use dedicated addresses within the 64K bytes. Other system devices use the I/O-mapped addresses hexadecimal 0 through FF.

Text continued from page 291:

ple, is memory-mapped at memory locations hexadecimal 3801 through 3880; the cassette is I/O-mapped at hexadecimal location FF. I/O-mapped operations use separate IN or OUT instructions with I/O addresses of hexadecimal 0 through FF; these I/O ports are completely separate from the 64K-byte memory.

The 16 address lines are buffered by 74LS367 bus drivers to provide higher fan-out; they go out to all parts of the Model I, including the external 40-pin connector for the system bus. The address lines are unidirectional, that is, they are outputs only from the Z80.

Back to the Z80 signals. The next largest set of signals is the data bus,

which is Z80 signals D7 through D0, most significant through least significant. The data bus is used to pass all data going between Z80 registers and memory and between Z80 registers and I/O devices.

Unlike the address bus, the data bus is bidirectional, permitting 8-bit transfers in both directions. Two sets of 74LS367 bus drivers are used, one controlled by a "data bus out" signal DBOU*, and the other controlled by a "data bus in" signal DBIN*. (The asterisk is used in all Model I/III circuit discussions to indicate "active low.") The data bus lines also go to the 40-pin system bus connector on the Model I.

Looking at the Z80 once again, you

Someday, in the comfort of your home, you'll be able to shop and bank electronically, read instantly updated newswires, analyze the performance of a stock that interests you, send electronic mail across the country, then play Bridge with three strangers in LA, Chicago and Dallas.



Welcome to someday.

Someday is today with the CompuServe Information Service. CompuServe is available through a local phone call in most major U.S. cities. It connects almost any brand or type of personal computer or terminal with our big mainframe computers and data bases. All you need to get started is an inexpensive telephone coupler and easy-to-use software.

CompuServe's basic service costs only \$5.00 per hour, billed in minute increments to your charge card.

The CompuServe Information Service is available at many computer stores across the country. Check with your favorite computer center or contact CompuServe.

Welcome to someday.

CompuServe

Information Service Division, 5000 Arlington Centre Blvd.
Columbus, Ohio 43220 (614) 457-8650

An H&R Block Company

Circle 91 on Inquiry card.

THIS IS A TELEVIDEO TERMINAL;
 THE SIMILARLY-PRICED
 TERMINAL ON THE RIGHT IS NOT.
 WHICH WOULD YOU RATHER READ ALL DAY?



Unretouched photos—identical condition
 Screens not actual size

Which would you

Our competitor on the right claims high resolution. But what about that glare? The washed-out background? And the black and white screen? It's enough to give you a headache.

The TeleVideo terminal on the other hand, with its finer character dot matrix, sharper background contrast, and a black-on-green non-glare Panasonic screen, is much easier on the eyes.

Obviously.

Every TeleVideo terminal has just four basic modules. Each module is the best that can be made.

Every screen, keyboard switch, power supply and video module on every TeleVideo terminal is identical. For the same high reliability. And same ease of service.

None of our competitors can say that.

If you order 200 terminals today, we can ship them tomorrow. If you order 500, we can still ship them tomorrow.

And if you order 1,000, well, maybe you'll have to wait a day or two.



The 920C



The 910 PLUS

We put our terminals through five bad days so you'll never have even one bad day.

Our terminals are designed to withstand heat up to

THIS IS NOT A TELEVIDEO TERMINAL.
THE SIMILARLY-PRICED
TERMINAL ON THE LEFT IS
WHICH WOULD YOU RATHER READ ALL DAY?

rather read all day?

155°F and shocks that simulate being tossed in the back of a truck. And before any terminal reaches you, every major component goes through a five day series of thermal and power-on cycling tests.

The result?

The highest reliability rate in our industry.

TeleVideo sells 50% more terminals a month than our nearest competitor.

Three years ago, TeleVideo shipped its first terminal. Today, we're the number one

Boston 617/668-6891; New York/New Jersey 201/267-8805;

The 910



independent terminal supplier.

One reason is because our advantages are clearly visible.

8 hours a day.

For more information call, toll-free, 800-538-8725. (In California, call 408-745-7760.) Or call your nearest TeleVideo sales office.

The 925



The 950



 **TeleVideo®**

All TeleVideo terminals can be serviced by your nearest GE Instrumentation and Communication Equipment Service Center.

Circle 401 on inquiry card.

United Kingdom West End Surrey 44-9905-6464.



**BUILT IN AMERICA.
SEATS FIVE ADULTS
IN COMFORT.
ENGINEERED FOR ROOM
AND RIDE.
FWD HANDLING.
AND IT'LL BE GREAT
FOR YOUR BUSINESS.**

1983 Renault *Alliance*



coming soon from . . .

RENAULT
American Motors 

We build the American Fleet

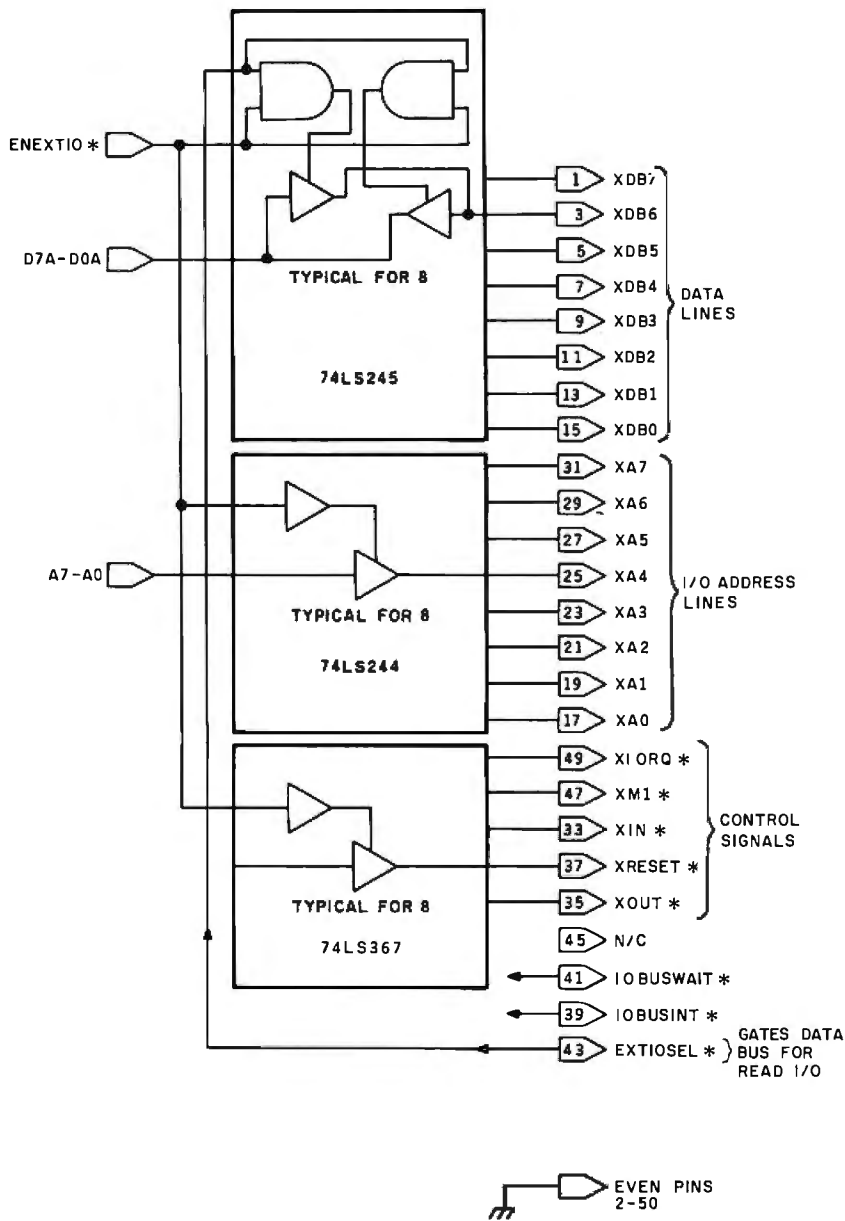

Figure 3: The system bus for the Model III is similar to the Model I system bus. Only eight address lines are brought out, however, and the address, data, and control lines are enabled by an "external I/O" signal, which must be set under program control.

find two sets of control signals: $\overline{\text{IORQ}}$ and $\overline{\text{WR}}/\overline{\text{RD}}$. Signal $\overline{\text{MREQ}}$ (the bar indicates a Z80 "active low" signal) is used to indicate that a memory operation is in effect and that there is a valid memory address on address lines A15 through A0. $\overline{\text{MREQ}}$ is used with $\overline{\text{RD}}$ to read data from ROM or RAM and with $\overline{\text{MREQ}}$ and $\overline{\text{WR}}$ to write data to ROM or RAM. $\overline{\text{MREQ}}$ is also used for memory-mapped I/O devices, such as the keyboard.

Signal $\overline{\text{IORQ}}$ is used to indicate

that an IN or OUT instruction is being executed and that there is an I/O address on address lines D7 through D0. $\overline{\text{IORQ}}$ is used with $\overline{\text{RD}}$ to read data into the Z80's A register from an external I/O device and to write data from the A register to an external I/O device. $\overline{\text{IORQ}}$ is the primary signal used for all types of I/O-mapped input/output.

The signals brought out on the system I/O bus, however, are not $\overline{\text{MREQ}}$, $\overline{\text{IORQ}}$, $\overline{\text{WR}}$, and $\overline{\text{RD}}$. The $\overline{\text{RD}}^*$ signal is active (low) when $\overline{\text{RD}}$

and $\overline{\text{MREQ}}$ are active (during a memory read). The $\overline{\text{WR}}^*$ signal is active (low) when $\overline{\text{WR}}$ and $\overline{\text{MREQ}}$ are active (during a memory write). The $\overline{\text{IN}}^*$ signal is active (low) when $\overline{\text{IORQ}}$ and $\overline{\text{RD}}$ are active (input). The $\overline{\text{OUT}}^*$ signal is active (low) when $\overline{\text{IORQ}}$ and $\overline{\text{WR}}$ are active (output). Then, these signals are partially encoded for external memory or input/output.

Other memory-related signals brought out on the system bus for "memory refresh" are MUX, CAS^* , and RAS^* . These three signals control memory refresh for the dynamic RAM chips used in the Model I and III. Since they're not used in external I/O, I'll omit any further details.

Other signals brought out on the Model I bus include INT^* , INTAK^* , TEST^* , WAIT^* , and SYSRES^* .

INT^* is an input and provides an external I/O interrupt. INTAK^* is an "interrupt acknowledge" signal that indicates the Z80 received the interrupt.

TEST^* is a signal that disables all data bus, address bus, and control signals; it is rarely used in Model I operations.

WAIT^* is an input signal used to interface slow memory or I/O devices and is not ordinarily used. It dates from the time when memories were significantly slower than the microprocessor.

SYSRES^* is an output signal that indicates power-up or reset (by the RESET button). It, like all of the signals with an asterisk suffix, is active low.

Model III system bus. Figure 3 shows a general block diagram of the Model III system bus, which differs from the Model I system bus in that it is more isolated from the internal processor signals. Only eight address lines are brought out, and a special "enable" signal gates the data, address, and control lines to the outside world.

The main enable signal is ENEXTIO^* , which means enable external I/O. This signal is generated by 1 bit of a 5-bit latch with port address hexadecimal EC. When this bit is a 1, signal ENEXTIO^* goes low, enabling the 74LS245 (XDB7 through XDB0),

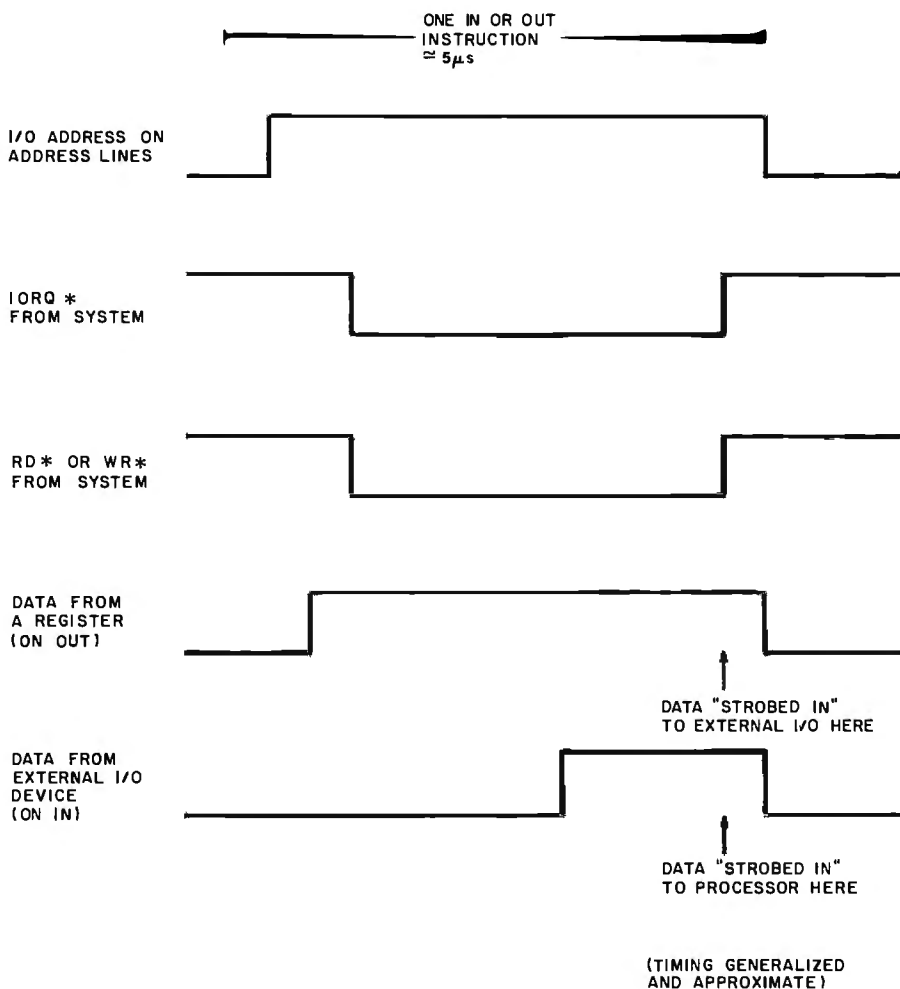

Figure 4: External I/O operations use an I/O address on the address bus, the IORQ* signal, and the RD* or WR* signal to effect 8-bit data transfers to and from the external I/O device.

the 74LS244 (XA7 through XA0), and the 74LS367 (control lines). If the ENEXTIO* bit is a 0, all of these lines are in the high-impedance (disconnected) state.

The XIORQ*, XM1*, IOBUSWAIT*, XRESET*, XOUT*, and XIN* control lines have the same functions as their Model I counterparts—WAIT*, SYSRES*, OUT*, and IN*. (IORQ* and M1* replace the encoded INTACK*.)

The IOBUSINT* is similar to INT* in the Model I, except that an enable signal, ENIOBUSINT (enable I/O bus interrupt), is used to determine when an external interrupt will be recognized from the outside world. ENIOBUSINT is made active by writing a 1 to bit 3 of port address hexadecimal E0. I won't discuss the external interrupts in this article, as

they make an interesting subject all by themselves.

The eight address lines are also logically equivalent to their Model I counterparts; they are XA7 through XA0.

The eight data bus lines XDB7 through XDB0 have a slightly different gating scheme on the Model I from that on the Model III. Instead of two sets of buffers enabled by RD* or WR*, as in the Model I, there is one bus driver, a 74LS245. The main enable signal for this chip is ENEXTIO*, as I've already mentioned. Also involved, though, is signal EXTIOSEL*. When EXTIOSEL* is a 1, the 74LS245 routes lines D7A through D0A to the external bus connector. When EXTIOSEL* is a 0, the 74LS245 routes lines from the external bus to lines D7A through D0A. EXTIOSEL* is

normally high, allowing writes to an external I/O device to be made by simply turning on ENEXTIO* (address hexadecimal EC) and performing a Z80 OUT instruction (or a BASIC OUT). If a read of an external device is to be done, however, external logic must bring down signal EXTIOSEL* at the proper time.

General Scheme for External I/O

The general scheme for Model I external I/O is fairly simple.

Output operation. The procedure for a write of 8 bits to an external device is as follows:

1. The 8-bit value to be written (0 through 255) is put into the A register in the Z80.
2. A machine-language OUT instruction with an address of 0 through 255 is executed.

The equivalent in BASIC is:

```
100 OUT XX,V
```

where XX is the I/O address and V is the value of 0 through 255.

Executing the machine-language or BASIC OUT puts the address of the I/O device on address lines A7 through A0 and enables the OUT* signal. The external I/O device decodes the address lines when it receives the OUT* signal. If the external I/O device recognizes its address, it strobes in the data that is present on the data bus lines. The entire process is shown in figure 4.

Output for the Model III is identical, except that the external I/O lines must first be enabled by setting bit 4 of address hexadecimal EC to enable signal ENEXTIO*.

Input operation. Input for the Model I is the following:

1. A machine-language IN or a BASIC INP instruction is executed, with an address of 0 through 255.
2. Data from the input/output device is read into the A register or into the BASIC variable specified. The BASIC equivalent is 100 A=INP(XX).

Chances are, when you bought your first disk drive, it was an Apple. Now that you're ready for a second, take a look at Quentin.

Our Apple*-Mate™ 5¼" Disk Drive is fully software transparent with Apple's DOS 3.3 operating system in full and half track operation.

Add it to your present drive for greater capacity and faster access. Just plug it in and go to work.

And the Apple-Mate has these High Performance advantages:

ON TRACK HEAD SEEK

A precision lead screw positions the head onto the correct track. Time-consuming retries and disk-to-disk copying errors are virtually eliminated.

SIEMENS† DISK DRIVE

The apple-beige unit is built around the highly reliable

Siemens system with over 10,000 lifetime hours. Shielded connecting cable also attached.

LONG TERM DEPENDABILITY

MTBF (Mean Time Between Failures)—8,500 power-on hours, and the unit has a one-year warranty.

COUNT ON QUENTIN FOR QUALITY

Quentin Research was building disk systems for the computer industry when Apple was a little bud on the big computer tree. We're known for product reliability and stand behind every system we sell you.

But the best news may be the price—only \$335.00 (40 tracks).

A special introductory offer when you order Apple-Mate directly from us.

So when you're ready to boost the juice on your Apple, add-on the Quentin Apple-Mate.

To order: Check, money order, Visa or Mastercard number. Calif. residents add 6% sales tax. Allow one week delivery.



19355 Business Center Drive
Northridge, California 91324
(213) 701-1006

MORE JUICE FOR YOUR APPLE®



**Special
Introductory
Price:
\$335.00**



© Apple is a registered trademark of Apple Computer, Inc.
†Siemens is a trademark of Siemens Corporation.
*Apple-Mate is a trademark of Quentin Research, Inc.,
which does not manufacture Apple computers.

Circle 345 on inquiry card.



Oryx software Quality Discount

GUARANTEED LOWEST PRICES! We will match any advertised price. Just show us the ad.

APPLE

Art Sci Magic Window	\$ 79
Dos Boss	22
Utility City	25
Apple Panic	25
Teacher Plus	35
Continental CPA acctg. module ea.	210
Depreciation planner	335
Datamost Real Est. Analysis	110
Datasoft Micropainter	30

Denver Software

Financial partner	\$219
Pascal Tutor	108
Pascal Programmer	108
Duosoft Business Planner	265
Edu-ware compu-matic	32

Ellis Computing

Nevada Cobol	\$169
Nevada Pilot	129
Nevada Edit	99
Application pkg. ea.	22

Hayden Software

Datagraph	\$ 39
Histogram	25
Applesoft Compiler 3.2	180
Apple ple Series ea.	109

Howard Software

Real Estate Analyzer	\$145
Tax preparer B2	127
Tax preparer state: CA, NY/NJ/IL	60

IUS

Datadex	\$125
Easywriter	162
Easymover	88
Easyjack (Combo)	262
Easymailer	162

Microfocus

Cis Cobol Std.	\$775
Forms-2	175

MicroPro

Wordstar	\$229
Mailmerge	85
Calcstar	145
Spellstar	145

Games

Sargon II	\$ 25
Zork I or II	32
Deadline	32
Crossword Magic	18

Misc.

Mathemagic	\$ 80
Spellguard	267
Edit 6502	82
Locksmith	90
Super Screen II	108
A-stat 79	140
Mailing list	48
G.O.C. I full Acctg. system	1,800
Stoneware DB Master	179

Muse Software

Super Text II	\$125
Address book	43
Form letter	87
Data Plot	52

And Many More

CP/M

MicroPro

Wordstar	\$235
Mailmerge	95
Calcstar	199
Spellstar	160
Supersort I	170

Microsoft

Basic 80	\$285
Basic Compiler	325
Fortran 80	345
Cobol 80	570
Macro 80	140

Peachtree

General Ledger	\$399
Accounts Receivables	399
Accounts Payables	399
Inventory	399
Payroll	399
Property Management	799
CPA Client Write-up	799

Star Computer System

G/L, A/R, A/P or Pay.	\$350
Legal Times Billing	845
Property Management	845

Sorcim

Supercalc	\$225
Trans 86	115
Act	155

Supersoft

Diagnostic I	\$ 48
Diagnostic II	83
Disk Doctor	84
Fortran	215
C Compiler	175

TCS

GL, A/R, A/P, or Pay.	\$ 79
All modules above	265
Module Compiler	98
Inventory	95

Ashton - Tate

D Base II	\$595
-----------	-------

Byrom Software

BSTAM	\$160
BSTMS	160

Digital Research

Pascal MT+	
MAC	\$ 85
SID (8080 Debugger)	65
ZSID (Z80 Debugger)	90
CP/M 2.2	149
C Basic 2	97
PL/1-80	449

And Many More

IBM PC

Wordstar	\$285
Mailmerge	95
Eastwriter II	299
Easispeller	149
Crosstalk	129
DataBase Manager	170
Mailing List	85
Vedit	165
CP/M 86	295
Write-on	110
Move It	125
Spellguard	247
East (Exec. Acctg. Sys.)	625

Accessories/ Hardware

Boards

Co Processors 88 card (Ap. II)	\$795
Softcard (Z80 CP/M Ap. II)	298
CPS Multifunction	178
Mountain A/D + D/A	289
CCS 12K ROM/PROM	89
CCS A/D Converter	98
CCS Serial Asynch	149
Applescope (your Apple as an Oscilloscope)	595
Videx Enhancer I	149
K & D Enhancer	115
Dan Paymar Lower case	27
ALS Smarterm	379
ALS Z-card	269
Percom Doubler II	167
Bit 3 Full View 80 (AT800)	299
Bit 3 32K Memory (AT400/800)	159
BTAD DS-1 (64K, Z80, CPM for IBM PC)	599
Datamac 64K (IBM PC)	399
Videx Micromodem Chip	25
Xadex Baby Blue (IBM PC)	550
Quadram Deluxe Board (IBM PC)	495
Quadram 128K Ram (IBM PC)	495
Microfazer 8K Printer Buffer	135
Versacard	218

Computers

Commodore/Atari/NEC/
Xerox

Call for Price Information

Monitors

Amdak Video 300	\$217
Amdak RGB Color	750
NEC 12" Hiras Green	175
Sanyo 12" Hiras Green	220
TECO TM - 12 GX Green	147
TECO RGB 13"	525

Modems

Novation Apple-Cat II	\$350
Hayes Smartmodem	235
Micromodem II	319
Chronograph	199

Printers

Anadex 9500 Series	\$1,580
Epson	\$Call
Diablo 630	2,200
NEC 3530	1,890
NEC 8023A	525
Okidata Microline 82A	535
Okidata Microline 83A	790
Prism 80 (w/ 4 options)	1,177
Prism 132 (w/ 4 options)	1,785
Smith-Corona TP-1	750

Disk Drives

Rana Elite 1 (Ap. II)	\$339
Rana Controller (Ap. II)	110
Micro Sci A35 (Ap. II)	399
Micro Sci A40 (Ap. II)	385
Micro Sci A70	540
Micro Sci Controller (Ap. II)	90
Tandon TM-100-1	299
Tandon TM-100-2	389

And Many More

One Stop Shopping at
Guaranteed Lowest Prices

When the machine-language IN or BASIC INP is executed, the address of the I/O device is sent to the address bus lines A7 through A0. Signal OUT* goes low, indicating to the external I/O logic that an I/O address is present on the address lines. If the address is decoded as the address of the I/O device, it responds by gating the 8 bits of data onto the data bus.

Input for the Model III is identical, except that the external I/O logic must also bring down signal EXTIOSEL* so that the 74LS245 bus driver switches direction, routing the data to the processor.

I/O addresses. The I/O port address used must be in the range of 0 through 127 because I/O addresses 128 through 255 are dedicated-system addresses in Models I and III. There are many addresses not used in the higher range, but it's prudent to stay below 128 to avoid conflict. External I/O can be done without full address-decoding logic.

A General-Purpose I/O Board

The circuit shown in figure 5 is a general-purpose input/output (GPIO) board that connects to the Model I or III system bus. It provides 24 I/O lines that can be either inputs or outputs. The lines can be used to drive relays for input or output as shown in the figure, to implement digital-to-analog or analog-to-digital converters, or for a variety of other applications. I'll describe how the circuit works, give you some construction hints, and then show you typical uses in driving an LED (light-emitting diode) display and detecting a remote input.

The GPIO board uses an Intel 8255 Programmable Peripheral Interface, which is essentially a programmable controller. The mode that I am using in this implementation connects lines PA7 through PA0 and PB7 through PB0 as outputs and lines PC7 through PC0 as inputs.

The interface to the Model I or III consists of the eight data bus lines, three address lines, the IN* and OUT* lines, and in the case of the Model III, the EXTIOSEL* line. The IOBUSINT* line is also implemented but won't be described in this article.

Write for our Free Catalog

ORDER TOLL FREE - Outside WI - 1-800-826-2322

- Please:**
- Wisconsin residents - add 5% sales tax
 - Add \$3.50 for shipping per software and small items. Call regarding others.
 - Foreign - add 15% handling charge. Shipping extra.

- We welcome:**
- Visa, Mastercharge (Add 4%)
 - Checks (Allow 1-2 weeks for clearing)
 - COD (Add \$1.50 per shipment)

For technical information & in Wisconsin: 715-848-2322

Oryx Software • 205 Scott St., Dept. AG • P.O. Box 1961
Wausau, WI 54401



Build your own computer for \$79.95



The Sinclair ZX81 personal computer kit

Imagine building your own computer for only \$79.95!

That's exactly what you can do with the ZX81 kit. It comes with all the parts you need and complete diagrams and instructions for putting it together. All you have to supply is soldering iron, solder, and a screwdriver. Plus, of course, a little bit of work.

But you get a lot more than several hours of kit-building fun. You also get a surprisingly powerful personal computer. The ZX81 hooks up to any TV for a 32-character by 24-line display (we provide the connecting cables). You can also use a standard cassette recorder to store your programs (again, we provide the cables).

Most important, you get a BASIC programming language that's powerful enough to challenge and interest the most experienced programmers. The ZX81 can handle multidimensional string and numerical arrays. It has full mathematical functions accurate to eight decimal places. Single-key entry for every command. Syntax error detection, debugging codes, and easy editing. Plus features that are ideal for creating games, such as 20 graphic symbols, continuous

display, and random number generator.

The ZX81 can be expanded too. You can increase the memory from 1K to 16K with our Memory Module for \$49.95. And you get a comprehensive manual that completely documents the capabilities of the ZX81, and teaches programming from the ground up.

In short, you get all the features that have made the Sinclair ZX81 the fastest selling personal computer in the world. And you get the satisfaction and fun of building it yourself.

A few years ago, this kind of computer power was simply unavailable to the individual. Even today, most personal computers are too expensive to buy for personal use.

But the ZX81 kit can be yours for only \$79.95. Take advantage of this unique offer today. To order, send the coupon along with a check or money order. Or for faster delivery, call our toll-free number and use your MasterCard or VISA.

To order call toll free: 800-543-3000.

Ask for operator #509. In Ohio call: 800-582-1364; in Canada call: 513-729-4300. Ask for operator #509. Phones open 24 hours a day, 7 days a week. Have your

MasterCard or VISA ready.

These numbers are for orders only. If you just want information, please write: Sinclair Research Ltd., 2 Sinclair Plaza, Nashua, NH 03061.

AD CODE 08BYOK	MAIL TO: Sinclair Research Ltd., One Sinclair Plaza, Nashua, NH 03061.		
	PRICE*	QTY.	AMOUNT
ZX81 Kit	\$79.95		
16K Memory Module	\$49.95		
Shipping and Handling	\$4.95		\$4.95
*U.S. dollars	TOTAL		
Name			
Address			
City		State	Zip

Sinclair technology is also available in Timex/Sinclair computers under a license from Sinclair Research Ltd.

sinclair



Now you don't have to decide between a personal computer and a VT100 terminal.



Digital's introduced a personal computing option which can turn a VT100 terminal into a personal computer that uses the CP/M® operating system.

It's called Digital's Personal Computing Option. You can purchase just the option, or you can buy the complete terminal/computing package called the VT180.

Either represents significant advantages over the choices available to you now. For now, you can provide access to a large computer and personal computing at the same terminal.

More than that, you save the additional cost of putting personal computers and terminals side by side on the top of a desk.

With the CP/M operating system Digital's personal computing terminal will run the literally hundreds of programs available for it. Including word processing, mailing lists, financial modeling, statistics, even data base communications—in addition to the many more being specially edited for this terminal.



And by virtue of the fact that Digital's personal computing terminal is VT100-based, you get all the features that people buy VT100s for in the first place. Features like smooth scrolling with up to 132 columns display, split-screen viewing, double-height and width characters, and reverse video.

Plus a reputation that's second to none in the industry. Plus Digital's service, on-site, anywhere in the world.

All of this should make great sense when you're confronted with the choice of terminals or personal computers.

Because now you can pick one and get both.

See your Digital dealer for more information or write: **Digital Equipment Corporation, Terminals Product Group**, 2 Mt. Royal Avenue, UPI-5, Marlboro, MA 01752. Telephone toll-free 800-225-9378 (outside the continental U.S. or in Massachusetts call 617-480-4077) between 8:30am and 5:00pm Eastern time. In Europe: 12 Av. des Morgines, CH-1213 Petit-Lancy/Geneva. In Canada: Digital Equipment of Canada, Ltd.

digital

Circle 143 on Inquiry card.

CP/M® is a registered trademark of Digital Research, Inc.

CASH FLOW PROBLEMS?



IT'S NICE TO KNOW SOMEONE WHO HAS THE SOLUTION.



MicroAge is your Solution Store . . . that means at MicroAge Computer Stores we have a wide selection of time-saving computerized business systems designed specifically to solve the daily cash flow problems every businessman faces.

MicroAge has computerized business systems that

quickly and affordably allow you to regain control of your critical accounts receivable . . . at last making it possible for you to carry out effective collection procedures on a consistent basis. MicroAge has accounts receivable program packages to automatically display and update account information; prepare trial balance including a balance-due and delinquency aging

report, and take care of dozens of other tasks that eat into your time and profit!

Computerized business systems from the MicroAge Computer Store are available in the \$5,000 to \$15,000 range, to suit the individual budget of your small business or professional practice. MicroAge backs up every system with personalized service, warranty service and repair, installation, systems consulting, even customer training. Visit the MicroAge Computer Store in your area soon with your business problems, and let us help you with the solution.

MicroAge.
COMPUTER STORE
"The Solution Store" SM

VISIT THE STORE IN YOUR AREA:

El Paso, Texas
(915) 594-3349

Tucson, Arizona
(602) 790-8959

Albuquerque, New Mexico
(505) 883-0955

Pleasant Hill, California
(415) 680-1489

Aurora, Colorado
(303) 696-6950

Rochester, New York
(716) 244-9000

Hurst, Texas
(817) 284-3413

Salina, Kansas
(913) 823-7596

Orland Park, Illinois
(312) 349-8080

Milwaukee, Wisconsin
(414) 257-1100

Mountain View, California
(415) 964-7063

Scottsdale, Arizona
(602) 941-8794

Anchorage, Alaska
(907) 279-6688

San Diego, California
(714) 278-0623

Richardson, Texas
(214) 234-5955

Minneapolis, Minnesota
(612) 338-1777

Omaha, Nebraska
(402) 339-7441

Phoenix, Arizona
(602) 265-0065

Columbus, Ohio
(614) 868-1550

Indianapolis, Indiana
(317) 849-5161

Portland, Oregon
(503) 256-4713

Norwalk, Connecticut
(203) 846-0851

St. Louis, Missouri
(314) 567-7644

Oklahoma City, Oklahoma
(405) 728-1837

Houston, Texas
(713) 440-7547

W. Palm Beach, Florida
(305) 683-5779

Toronto, Canada
(416) 467-5551

Houston, Texas
(713) 270-9647

Wilmington, Delaware
(302) 658-3884

Allentown, Pennsylvania
(215) 434-4301

FOR FRANCHISE OPPORTUNITY INFORMATION CALL (602) 968-3168

Number	Type	+5 V	GND
IC1	74LS32	14	7
IC2	8255	26	7
IC3	74LS240	20	10
IC4	74LS240	20	10
IC5	74LS240	20	10

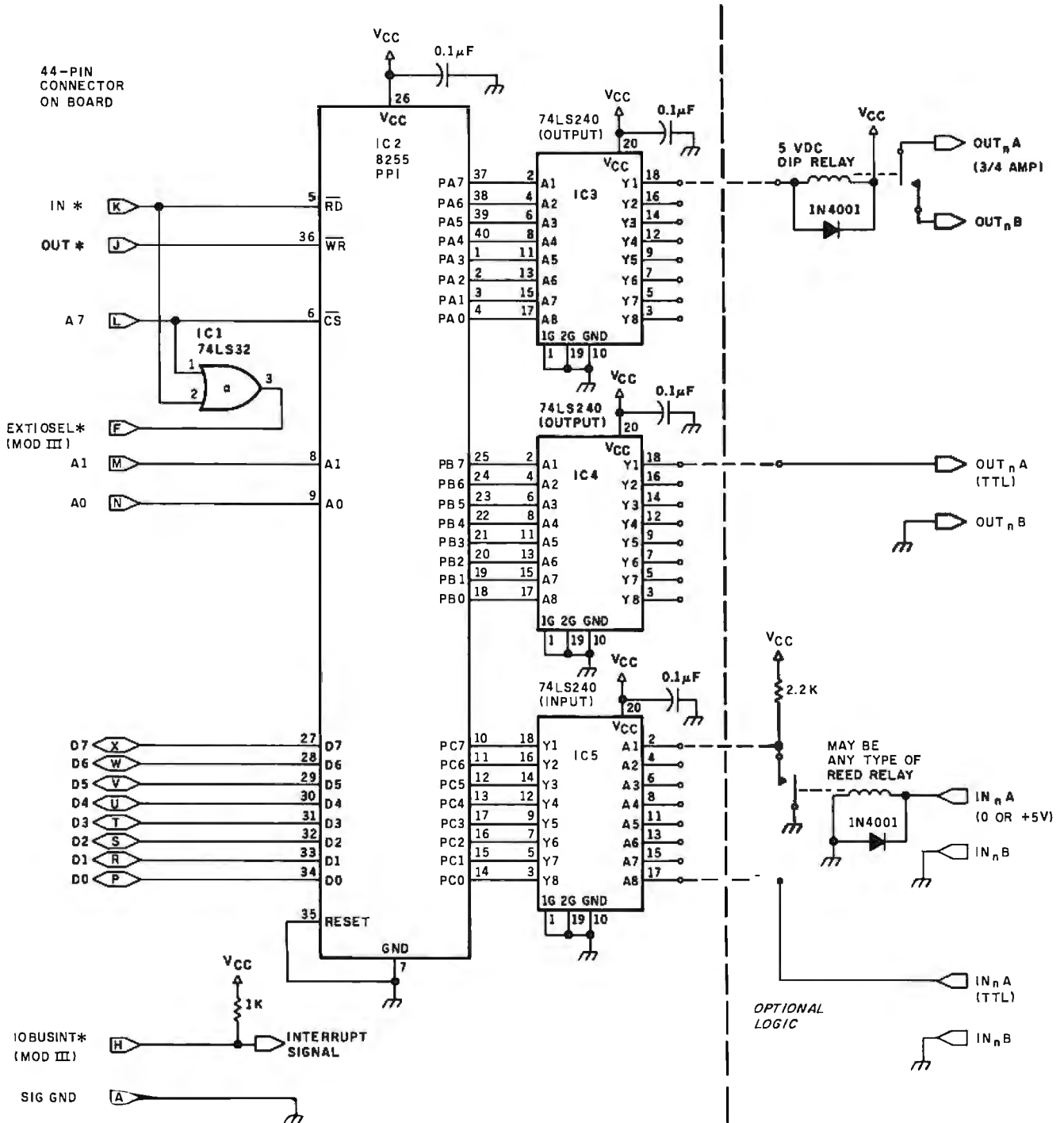
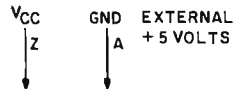
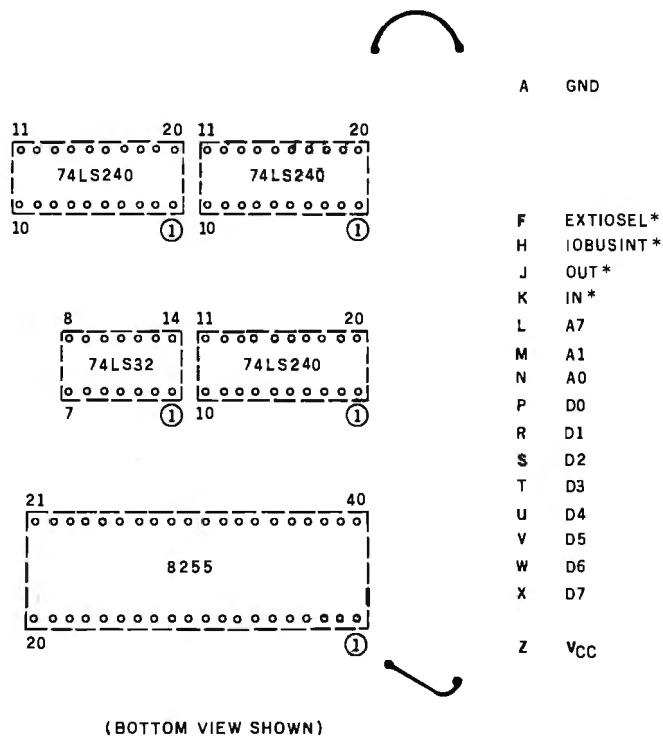

Figure 5: The GPIO board for the Model I and III uses an Intel 8255 Programmable Peripheral Interface chip as a 24-line controller. Sixteen of the lines are outputs and control 74LS240 drivers. Eight of the lines are inputs.



(BOTTOM VIEW SHOWN)

Figure 6: The GPIO is built on a standard prototype board using wire-wrap IC sockets.

The address of the GPIO is any four sets of addresses in the lower I/O address range of 0 through 127. For convenience, you can look upon the addresses as 0, 1, 2, and 3, but the board will respond to any address with bit 7 equal to 0, ignoring bits 2 through 6. Address binary 01111100, for example, will be decoded the same as address 0.

The address of the latch associated with the PA lines (see figure 5) is address 0. Outputting data to address 0 will store the data pattern in the output and set the lines accordingly. The address of the latch associated with the PB lines is address 1. An identical type of output can be done for this latch. Address 2 controls the PC lines. Inputting data from this address will read the state of the eight lines.

The last address of the GPIO is address 3 (address binary xxxxx11). This is the address of an internal control register in the 8255. Outputting a control word to address 3 configures the 8255. To get the configuration I've described, output a decimal 137. This needs to be done only once, at

the beginning of any power-up sequence.

The normal sequence of events for using the GPIO is shown here:

```

100 'BASIC DRIVER FOR GPIO
110 OUT 236,16 'Model III only
120 OUT 3,137 'setup 8255
130 OUT 0,XX 'output to
    PA7-PA0
140 OUT 1,XX 'output to
    PB7-PB0
150 A=INP(2) 'read PC7-PC0

```

The first command sets the Model III EXTIOSEL*. (An important point: This command must be done at the start of any entry to a BASIC program and after any CLS command. When in doubt, issue another EXTIOSEL*.) The OUT 3,137 command sets the 8255 to the proper I/O configuration. The next two commands output a byte to the two output ports. The next command reads in the configuration of the PC7 through PC0 lines.

The 8255 lines are connected to three 74LS240 line-driver chips. These chips provide up to 10 milli-

amps (mA) of 5-volt (V) source current or 40 mA of 0-V sink current. The top two chips are connected as output drivers, and the bottom is an input driver.

GPIO Construction

The board is assembled on a Radio Shack prototype board (276-154). The board has a 44-pin connector on one end that mates with a Radio Shack plug (276-1551). The board will be identical for both the Model I and III version, but the cable for the plug will be different.

Socket mounting and wiring. Mount five sockets on the board, as shown in figure 6. I used wire-wrap sockets for this version. You may use solder-type sockets if you prefer, as there are not a great many interconnections. The sockets should straddle the two etches that represent the V_{CC} (+5 V) and GND buses. Solder opposing socket pins to hold the sockets to the board. Connect 0.1-μfd disk capacitors to the V_{CC} and GND buses close to each integrated-circuit (IC) socket.

The pins are numbered as shown in the figure and correspond to the connector pin numbering. Use pin A as GND and solder a short wire to the GND bus as shown. Use the pin Z, which is on the opposite end of the plug, as V_{CC} and solder as shown.

Wrap the sockets as shown in table 1. Figure 6 shows the bottom view of the board with correct pin numbering. CON-F, CON-M, etc., shown in table 1, relate to the pins labeled F, M, etc., in figure 6.

Checking the board wiring. After you've wired the board, check the wiring before plugging in any ICs. Two common pins fit nicely into the IC socket holes, as shown in figure 7.

Cable fabrication. If the wiring checks out, you're ready to fabricate the cable. There are two cables, one for the Model I and one for the Model III, as shown in figure 8. Two wires go from the 44-pin connector end of the cable to a +5 V supply, as shown in figure 9.

At one end of the cable, use the Radio Shack 44-pin connector. Solder the connections.

Condor database obsoletes compilers!

Condor relational database management system makes your personal/business computer far simpler to use and much more useful to own... for less money... than other software.

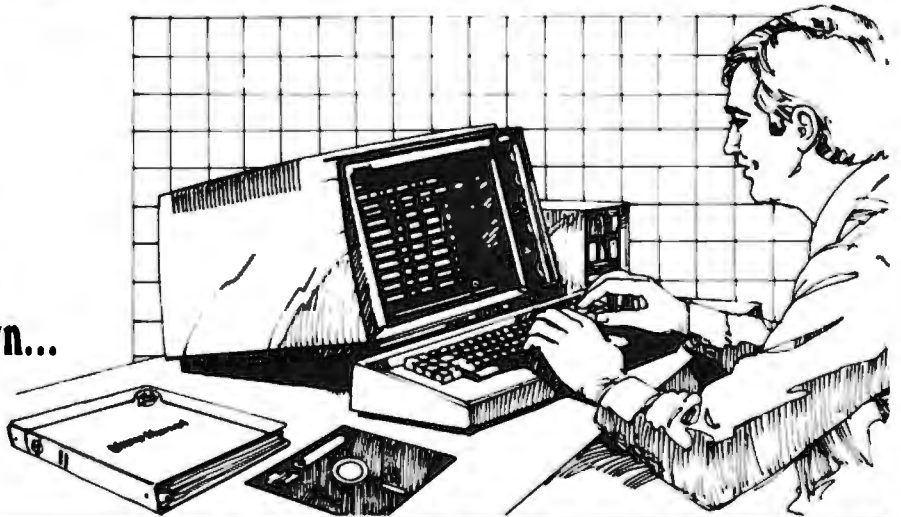

Plain English, no computerese.

Condor relational database management is a complete development and operation system. It eliminates BASIC, PL/1, COBOL, FORTRAN, or other compilers in almost every case. It allows you to deal directly with your information without complex code words. In plain English, *it lets you manage your business instead of your data.*

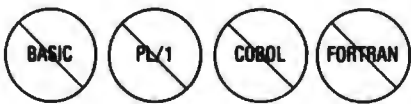

Save 90%. Because no complex programming is needed, Condor saves up to 90% of the cost of program writing and testing! You also eliminate costly and time-consuming programmer "talent searches."

State-of-the-art relational format.

Condor makes traditional programming approaches using compilers *obsolete*. Features such as SORT, DEFINE, ENTER, POST AND REORG permit rapid database creation, access, control, monitoring and manipulation. For instance (by using the JOIN command), you can combine the information contained in two large file cabinets—such as "Purchases" and "Labor Cost"—

into a single file—in one operation. To do the same task, ordinary software usually requires substantial reprogramming.

Easiest to learn and use.

Independent evaluators rate Condor more "user-friendly" than any other personal/business computer database system. After a brief study of the manual, you start building a database *within 15 or 20 minutes.*



In fact, Condor has allowed many hundreds of first-time users to produce and process their own management reports.

Only \$295 for entry level.

Condor's three-level modular design provides *full upward compatibility*, up to the most powerful software of its kind in the industry. The entry level Condor I features database file development and management; entry, update,

and posting; inquiry and report writing capabilities; and complete operations aids. And as information needs grow, you can easily upgrade to Condor III for writing highly complex reports and fast-query indexing.



Guaranteed to do more work, more easily for greater savings.

Put Condor to the test. Experience its power and versatility firsthand...how it puts you in direct touch with your data, while eliminating complex programming. You must agree that Condor saves you time, work and money...or return it within 30 days for a complete and prompt refund (at participating dealers only).

Questions? See Condor at your local software dealer, write to P.O. Box 8318, Ann Arbor, MI 48107, or call **(313) 769-3988.**

condor
COMPUTER CORPORATION

P.O. Box 8318, Ann Arbor, MI 48107

The Industry Standard...Selected by Major Dealers, Distributors and Manufacturers.

Fancy Shmancy

Elaborate microprocessor development systems cost a lot of money, and they can close off your engineering options by locking you into just one or two kinds of chips. Sound familiar? Well, read on—we've got a better idea.

Use your desktop computer; anything that will run CP/M* is fine. With our microprocessor cross-assemblers you can produce software for eleven of the most popular chip families, and more are on the way.

In two years on the market, our cross-assemblers have gained a reputation for quality, performance, and reliability. Hundreds of industrial R&D labs and several major semiconductor houses have found these products a fast, cost-effective way to develop their microprocessor software. We invite you to join them.

CP/M CROSS-ASSEMBLERS

Extremely fast absolute assemblers, running under CP/M. Generate object file (Intel hex or Motorola S-record format) and listing from standard assembly language for the target processors listed. Features include comprehensive syntax checking, listing control, nested conditional assembly, and insertion of external source files. All versions listed have been thoroughly field-tested and are available now.

XASM05	6805
XASM09	6809
XASM18	1802
XASM48	8048/41
XASM51	8051
XASM65	6502
XASM68	6800/01
NEW!	XASM75 NEC 7500
	XASMF8 F8/3870
NEW!	XASMZ8 Z8
	XASM400 COP400

Assemblers \$200.00 each
except XASM75 \$500.00

Visa and Mastercard accepted. We ship on 8" single-density and Softcard + 5.25" diskettes. Ask us about other formats. OEM INQUIRIES INVITED.

*Trademark of Digital Research
+ Trademark of Microsoft



**AVOCET
SYSTEMS INC.**

804 S. STATE ST., DOVER, DEL. 19901
302-734-0151
BY82

FROM	TO	SIGNAL
CON-K	8255-5	IN*/ \overline{I}
CON-J	8255-36	OUT*/ \overline{R}
CON-L	8255-6	A7/ $\overline{}$
255-6	74LS32-1	A7/ $\overline{}$
255-5	74LS32-2	IN*/ \overline{RD}
CON-F	74LS32-3	EXTIOSEL*
CON-M	8255-8	A1
CON-N	8255-9	A0
CON-X	8255-27	D7
-W	-28	D6
-V	-29	D5
-U	-30	D4
-T	-31	D3
-S	-32	D2
-R	-33	D1
-P	-34	D0
CON-H	1-k Ω resistor	IOBUSINT*
1-k Ω resistor	V _{cc}	IOBUSINT*
8255-35	8255-7	RESET
CON-Z	V _{cc} bus	V _{cc}
CON-A	GND bus	GND
8255-37	74LS240-2	PA7
-38	-4	6
-39	-6	5
-40	-8	4
-1	-11	3
-2	-13	2
-3	-15	1
-4	-17	0
8255-25	74LS240-2	PB7
-24	-4	6
-23	-6	5
-22	-8	4
-21	-11	3
-20	-13	2
-19	-15	1
-18	-17	0
8255-10	74LS240-18	PC7
-11	-16	6
-12	-14	5
-13	-12	4
-17	-9	3
-16	-7	2
-15	-5	1
-14	-3	0
TO V _{cc} BUS:	TO GND BUS:	
74LS32-14	74LS32-7	
8255-26	8255-7	
74LS240-20 (3)	74LS240-1 (3)	
	74LS240-19 (3)	
	74LS240-10 (3)	

0.1 μ F CAPACITORS BETWEEN:

V_{cc} and GND pins near IC sockets (5)

Table 1: GPIO board wiring list. (CON-A, CON-F, CON-H, etc., are connection points in figure 6.)

THE Prompt-Doc[®] MANUAL MAKER

You know better user manuals sell more software, but how do you make better user manuals? How do you identify just the right details to motivate prospective

users to buy? How do you organize these details into a sequence that makes sense to first-time users while it provides ongoing reference to veterans? How do you format and package a manual so it's attractive enough to get attention yet clear enough to be readily understood?

And, how do you do all this at a pace that keeps up with your product release schedule? The Prompt-Doc[®] Manual Maker is the answer.

Introducing Computer-assisted Writing

Imagine a software product that prompts you through the process of planning, outlining and writing a user manual and even supplies boilerplate introductory and transitional text. Envision reducing your user manual preparation process to this:

1. Identify manual, select boilerplate chapter files from menu, review visual table of contents (VTOC) for chapters
2. Edit chapter VTOCs to tailor sequence and terminology to your product needs
3. Pause while computer modifies boilerplate chapters to match edited VTOCs and builds a skeletal manual in preformatted Wordstar[®] files
4. Use Wordstar[®] to edit the skeletal manual into a working draft, supplying product details as prompted
5. Tell computer to purge prompts and instructions from working draft, and build new Table of Contents; publish review draft
6. Review the draft for accuracy and usability; revise, polish and publish as instructed by documentation

Compared to your current process that may sound more like a software maker's dream than a real product. It's a dream all right. A dream come true called the Prompt-Doc[®] Manual Maker--the only product of its kind.

Consider These Benefits

Improved productivity--with Prompt-Doc[®] you can gain as much as 40% on typical manual writing jobs

Project control--with prestructured modular chapters, writing tasks can be segmented without losing continuity

Manual uniformity--by product, by product line, by company

Quality assurance--the boilerplate files help assure completeness and usability; the Prompt-Doc[®] User Manual guides publishing

Proven performance--based on the Prompt-Doc[®] methodology, the structures and outlines have been proven in myriad applications for the past four years; now we've tailored it specifically for the commercial software vendor

Reasonable Price

\$245 for software and manual, \$45 for manual only. This product will begin paying for itself the minute you start using it and continue making you money each time you publish a manual. What could be more reasonable?

CP/M[®] Compatible; Uses Wordstar[®]

Now available for use with Wordstar[®] on the Apple[®] II and III with the Softcard[®] and on the Xerox 820.

Use The Coupon Now

You know a better way to make better manuals can enhance your competitive position. Why wait another minute? Complete the coupon now and mail it to Context, Inc., Attention Prompt-Doc[®], 833 West Colorado Avenue, Colorado Springs, CO 80905. Or, if you'd rather not wait for the mail, call (303) 471-9875.



context

The Prompt-Doc[®] Company

Not affiliated with Context Management Systems of Torrance, CA. Prompt-Doc is a registered trademark of Context, Inc. Apple, Apple II and Apple III are registered trademarks of Apple Computer Inc. Softcard is a registered trademark of Microsoft Corporation. CP/M is a registered trademark of Digital Research, Inc. Wordstar is a registered trademark of Micro-Pro International Corporation.

I need the Prompt-Doc Manual Maker now! Send a copy to:

Name _____ Telephone (____) _____
Address _____

- Send manual only.
 My check is enclosed for \$_____. UPS C.O.D.
 You may charge my _____ VISA _____ Master Card
Account # _____
Amount \$ _____ Expiration Date _____

Signature _____
 I need more information. Send it to the address above.

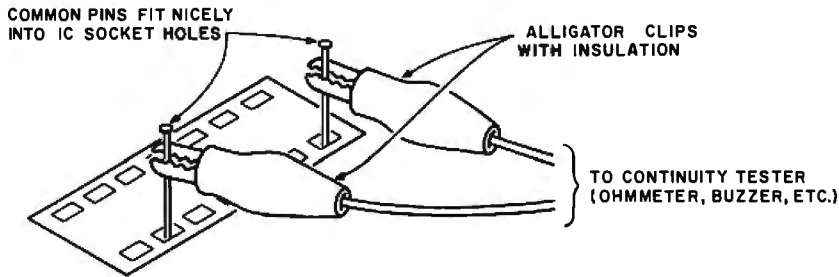
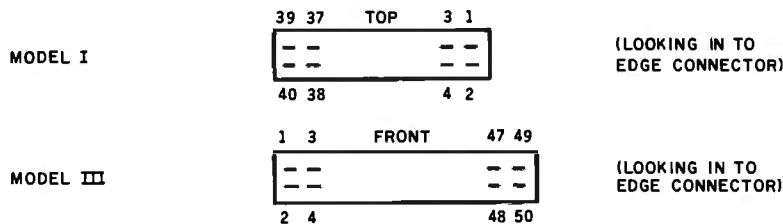

Figure 7: After GPIO board fabrication, the wiring connections should be checked out. Two common pins and a continuity tester or ohmmeter facilitate checkout.

PROTOTYPE BOARD CONNECTOR PIN	MODEL I PIN	MODEL III PIN	PROTOTYPE BOARD SIGNAL (PIN)
K	19	33	IN *
J	12	35	OUT *
L	36	31	A7
M	27	19	A1
N	25	17	A0
X	20	15	D7
W	24	13	D6
V	28	11	D5
U	18	9	D4
T	26	7	D3
S	32	5	D2
R	22	3	D1
P	30	1	D0
A	8	8	SIGNAL GROUND
A	(TO EXTERNAL GROUND)		SIGNAL GROUND
Z	(TO EXTERNAL +5 VDC)		VCC
H	21	39	IOBUSINT *
F	NC	43	EXTIOSEL *



NC= NO CONNECTION

Figure 8: Cable wire list and edge connector orientation.

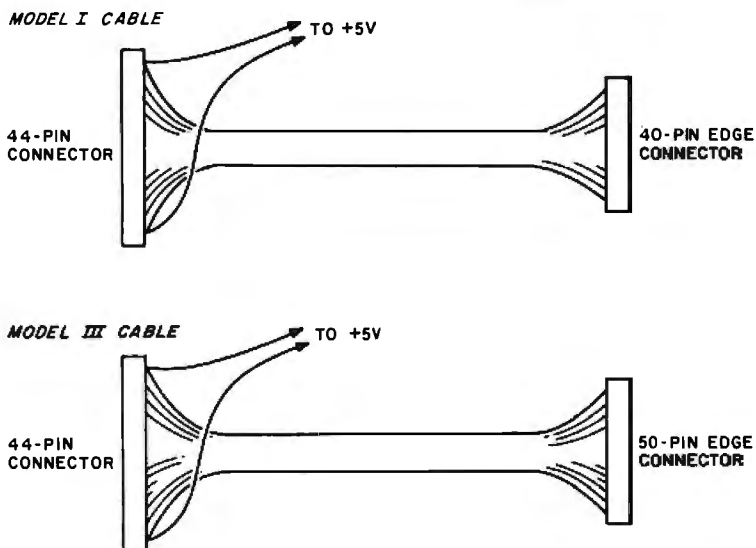

Figure 9: The cable for the Model I is different from the Model III version. The Model I version uses a 40-pin edge connector, while the Model III version uses a 50-pin edge connector. Both versions use a 44-pin connector for the prototype board.

CALL YOUR LOCAL DYSAN OFFICE

- CA: Los Angeles (213) 907-1803
Orange County (714) 851-9462
Sacramento (916) 966-8037
San Francisco/Sunnyvale (408) 727-9552
- DC: Washington (703) 356-6441
- GA: Atlanta *(404) 952-0919
- IL: Chicago (312) 882-8176
(800) 323-5609
- MA: Boston (617) 273-5955
*(617) 229-2800
- MI: Detroit (313) 525-8240
- MN: Minneapolis *(612) 814-7199
- MO: St. Louis (314) 434-4011
- NY: New York (212) 687-7122
- OH: Cleveland (216) 333-3725
- PA: Pittsburgh (412) 261-0406
Philadelphia (609) 939-4762
- TX: Dallas/Ft. Worth *(817) 261-5312
- WA: Seattle (206) 455-4725

*Includes OEM Sales

Dysan Diskettes are also available from all ComputerLand Stores, Sears Business Systems Centers, and many independent computer outlets nationwide.

For the location of the Dysan sales outlet nearest you, contact Dysan at: (408) 988-3472
Toll Free: (800) 538-8133
Telex: 171551 DYSAN SNTA
TWX: 910-338-2144



Circle 154 on Inquiry card.

WHAT IS THE TRUE COST OF A DISKETTE?

If you said at least \$186.50*, you're probably close.

Confused? It's simple. The minimum cost of a one-sided, single density 8" diskette equals the purchase price plus the cost of the time to fully load the data onto the disc*. The adjacent diagram tells the story. As you can see, the purchase price of a diskette is a small fraction of the total cost of ownership. So why not pay a few cents more for the best diskette available?

That's where Dysan's quality comes in. Dysan diskettes and mini-diskettes are manufactured to the toughest quality standards in the industry. Every diskette is tested between the tracks as well as on the tracks to insure you 100% error-free recording over the entire disc surface. Dysan quality protects your investment of \$186.50.

You know how costly time and data losses can be should your "bargain" diskette be faulty. Every penny you think you save on the purchase of magnetic media could cost you dearly. Why take the risk when you can have Dysan?



dysan
Dysan
CORPORATION

Our Media Is Our Message™

5201 Patrick Henry Drive
Santa Clara, CA 95050

*\$4.00 represents Dysan's suggested retail price for a one-sided, single density 8" diskette, packaged ten to a box. Minimum total cost of ownership = \$186.50

*\$182.50 represents the cost of data loading (approximately 22 hours at 11,106 keystrokes/hour at a labor cost of \$8.23/hour), based on 1981 Data Entry Management Association (DEMA) National Averages.



The UniFLEX™ Operating System extracts



every last drop

from the 8 bit 6809 microprocessor allowing it to outperform many 16 bit systems

With the UniFLEX™ Operating System, the 8 bit 6809 microprocessor can perform as well as larger CPUs in a multi-user, multi-tasking environment.

Independently developed from the ground up, UniFLEX™ closely models the features found in the UNIX™ Operating System. And in two years of use, UniFLEX™ has proven the abilities of the 6809 to perform large system functions when incorporated into a properly designed mainframe.

Some of the features supported include:

- full multi-user, multi-tasking capabilities
- hierarchical file systems
- device independent I/O
- four Gigabyte disk capacities
- full file protection
- inter-task communication via pipes
- I/O redirection
- task swapping for efficient memory usage
- full random-access files
- comprehensive shell command language
- foreground-background jobs
- electronic mail and printer spooling
- system accounting facilities

The support software currently available for use under UniFLEX™ is extensive.

A sampling of the programs available includes:

- native C compiler (full implementation)
- native Pascal compiler
- FORTRAN 77 ANSI Subset compiler
- COBOL compiler with ISAM files, Report Writer & Sort/Merge
- Extended BASIC interpreter
- Extended BASIC precompiler
- text editing and processing software
- enhanced printer spooler
- variety of absolute and relocatable assemblers
- debug and diagnostic packages

Technical Systems Consultants, Inc. also offers a line of single user FLEX™ software products for 6800 and 6809 processors. For those having an absolute need for a 16 bit processor, UniFLEX™ will be available through OEM licensing arrangements for the 68000 microprocessor. Please call or write for additional information on individual products or OEM licensing arrangements.

UNIX™ is a trademark of Bell Laboratories.
FLEX™ and UniFLEX™ are trademarks of Technical Systems Consultants, Inc.

 technical systems
consultants, inc.

111 Providence Road
Chapel Hill, North Carolina 27514
(919) 493-1451

Listing 1: Demonstration program for output and input for the Model III. Delete line 110 for the Model I version.

```

100 'DEMO MODEL III PROGRAM FOR OUTPUT AND INPUT
105 CLS
110 OUT 236,16
120 OUT 3,137
140 PRINT @512+32,INP(2)
150 OUT 0,0
160 GOSUB 1000
170 OUT 0,255
180 GOSUB 1000
190 GOTO 140
1000 FOR I=0 TO 100
1010 NEXT I
1020 RETURN

```

At the other end, use a 40-pin edge connector (Radio Shack 276-1558) for the Model I or a 50-pin edge connector for the Model III. Be sure to use the numbering shown in figure 8 for the edge connectors. The Model III connector uses the reverse numbering from the Model I connector! Connections may be made using ribbon cable (and forcing the ribbon cable onto the connector) or by simply soldering 24-gauge stranded copper wire to the connector pins.

If you are using individual wires, use cable ties to band the wire together into a single cable.

Testing the GPIO. When you have "buzzed out" the cable, plug in the ICs, connect the cable to the board, and connect the power-supply leads to the +5 V supply. (Do not plug the cable into the computer at this point.) Make a "smoke test" by momentarily touching the chips. The 8255 should be warm but not hot.

Turn off all power and plug the other end of the cable into the Model I or III. The proper orientation is shown in figure 10.

Execute the BASIC program shown in listing 1. (Eliminate line 110 for the Model I version of the board.) This program "toggles" the outputs of PA7 through PA0 at a low speed rate and also reads lines PC7 through PC0.

Carefully test the outputs of the first 74LS240 by the method shown in figure 11. Of course, you may use a voltmeter, logic probe, or 'scope if you have one. You should see the output change from 0 V to +4 V or so and back again.

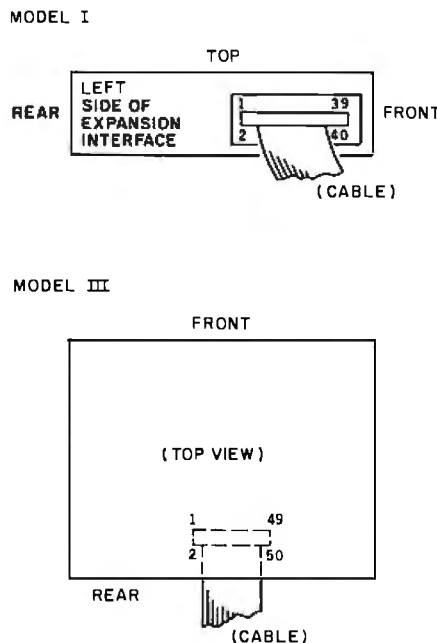

Figure 10: Cable connection to the Model I or III.

Inputs may be grounded by connecting the input pins of the third 74LS240 to ground. You should see a 128, 64, 32, 16, 8, 4, 2, or 1 value displayed on the screen, corresponding to the bit position of the pin grounded. The PB7 through PB0 outputs may be tested by substituting "OUT 1,0" and "OUT 1,255" for lines 150 and 170, respectively.

Typical Applications

To give you some flavor of how the GPIO board may be used, I've implemented a seven-segment LED display driver as shown in figure 12. The LED display used is a Radio Shack

CHOOSE...

An Apple Desk



A compact Bi-Level desk ideal for the Apple computer system. This 42" x 29½" desk comes with a shelf to hold two Apple disk drives. The top shelf for your TV or monitor and manuals can also have an optional paper slot to accommodate a printer. It is shown here with the optional Corvis shelf which will hold one Corvis disk drive. The Corvis shelf is available on the 52" x 29½" version of the Apple desk.

A Universal Micro Desk



The Universal Micro desk accommodates the S-100 type microcomputers. The desk is available in four sizes: 17.75 inch, 19.06 inch, and 20.75 inch wide openings with 24 inch front-to-rear mounting space. The fourth size is a 20.75 inch wide opening with a 26.50 inch front-to-rear mounting space.

A Mini Rack



Mini racks and mini micro racks have standard venting, cable cut outs and adjustable RETMA rails. Choose a stand alone bay or a 48", 60", or 72" desk model in a variety of colors and wood tones. A custom rack is available for the Cromemco.

A Printer Stand



The Universal printer stand fits the:

Centronics 700's	Diablo 1600's & 2300's
Dec LA 34	T.I. 810 & 820
NEC Spinwriter	Okidata Slimline
Lear Siegler 300's	Anadex 9500's

Delivery in days on most styles in stock. Dealers inquiries invited.

**ELECTRONIC SYSTEMS
FURNITURE
COMPANY**

17129 S. Kingsview Avenue
Carson, California 90746
Telephone: (213)538-9601

AUG. SPECIAL SALE ON PREPAID ORDERS
 (CHARGE CARDS, C.O.D. OR P.O.'S NOT AVAILABLE)
MUST MENTION AD FOR SPECIAL PRICES
EXPANSION KIT FOR SSM-PB-1 BY EXTEK PROGRAMS
 2732, 2732 A & 2764. CP/M SOFTWARE DISC
 INCLUDED.
 KIT \$105.95, A & T \$119.95



CALIFORNIA COMPUTER SYSTEMS

\$100

2032 32K STATIC RAM A & T. 200 NSEC	\$468.00
2065 64K DYNAMIC RAM A & T.	\$351.00
2200 S-100 MAIN FRAM A & T	\$500.00
2422A FLOPPY DISC WITH CP/M 2.2"	\$329.95
2810A Z80 CPU A & T	\$249.95
2710A 4 SERIAL I/O A & T.	\$291.95
2710A 2 SERIAL, 2 PARALLEL A & T	\$305.95
2720A 4 PARALLEL A & T	\$214.95
PROTO BOARDS WW.	\$39.95

APPLE PRODUCTS

7114A 12K ROM/PROM	\$99.95
7424A CALENDAR/CLOCK.	\$106.95
7440A PROGRAMMABLE TIMER.	\$98.50
7470A A TO D CONVERTER	\$105.95
7490A GPIB (IE 488) INTERFACE	\$182.00
7710A ASYNC SERIAL.	\$125.95
7712A SYNC SERIAL.	\$153.95
7720A PARALLEL STANDARD	\$105.00
7720B PARALLEL CENTRONICS.	\$105.00
7811B ARITHMETIC PROCESSOR W/DISC	\$342.95
7811C ARITHMETIC PROCESSOR W/ROM	\$342.95
7520A EXTENDER	\$23.50
7300A APPLE CLIP.	\$8.00



MICROCOMPUTER PRODUCTS

\$100 PRODUCTS

CB-2 Z80 PROCESSOR BOARD		
KIT	\$198.95, A & T	\$269.95
VBIC 64 x 16 VIDEO, PCBD		\$32.95
KIT	\$153.95, A & T	\$199.95
VB3 80 CHARACTER VIDEO 4MHZ		
KIT	\$345.95, A & T	\$425.95
I04 2 PARALLEL, 2 SERIAL, PCBD		\$32.95
KIT	\$155.95, A & T	\$194.95
PB-1 2708, 2716 PROGRAMMER BOARD		
KIT	\$135.95, A & T	\$185.95

APPLE PRODUCTS

A10 - II SERIAL/PARALLEL INTERFACE		
A & T		\$178.00
AS10 SERIAL I/O		
A & T		\$97.95
AP10 PARALLEL I/O W/O CABLES		
A & T		\$87.95



WAMECO INC.

BOARDS WITH MIKOS PARTS

MEM-3 32K STATIC RAM, PCBD	\$36.95	
KIT LESS RAM	\$95.95, A & T	\$135.95
CPU-2 Z80 PROCESSOR, PCBD	\$32.95	
KIT LESS ROM	\$109.95, A & T	\$149.95
CRT-1 36 OR 24 x 80 VIDEO BOARD, PCBD	\$38.95	
KIT	\$249.95, A & T	\$299.95
FPB-1 FRONT PANEL, PCBD	\$48.50	
KIT	\$144.95, A & T	\$184.95
MEM-4 65K RAM/ROM BOARD, PCBD	\$38.95	
KIT LESS MEMORY	\$99.95, A & T	LESS MEMORY \$129.95

MIKOS

MONDAY-FRIDAY, 8:00 TO 12:00, 1:00 TO 5:30
 THURSDAYS, 8:00 TO 9:00 P.M.

(415) 728-9121

P.O. BOX 955 • EL GRANADA, CA 94018

PLEASE SEND FOR IC XISTOR AND COMPUTER PARTS LIST
 VISA or MASTERCHARGE. Send account number, interbank number
 expiration date and sign your order. Approx. postage will be added.
 Orders with check or money order will be sent post paid in U.S. If you are
 not a regular customer, please use charge, cashiers check or postal
 money order. Otherwise there will be a two-week delay for checks to
 clear. Calif. residents add 6% tax. Money back 30-day guarantee. We
 cannot accept returned IC's that have been soldered to. Prices subject to
 change without notice. \$20.00 minimum order. \$2.00 service charge on
 orders less than \$20.00

TESTING OUTPUTS

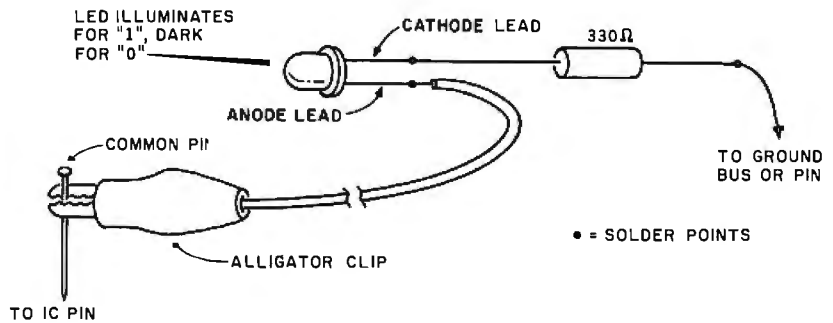

TESTING INPUTS

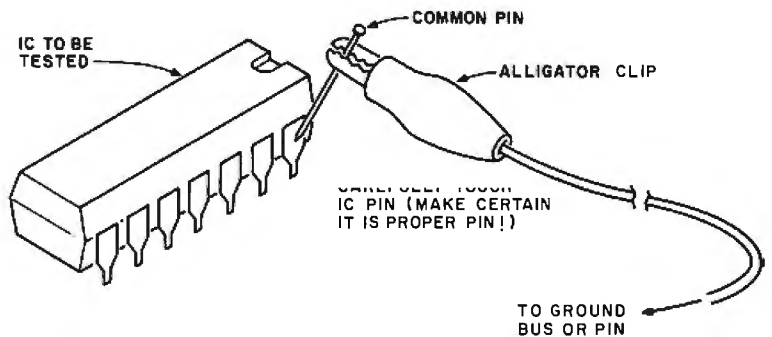

Figure 11: After building the GPIO, the 24 lines may be tested easily by a LED/resistor tester for outputs and by grounding inputs.

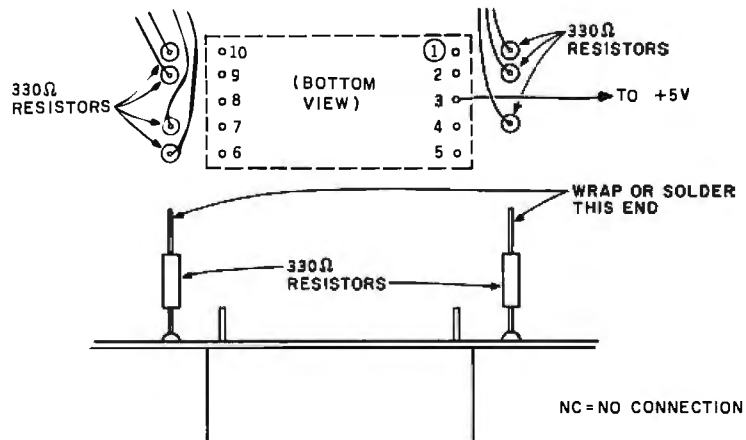
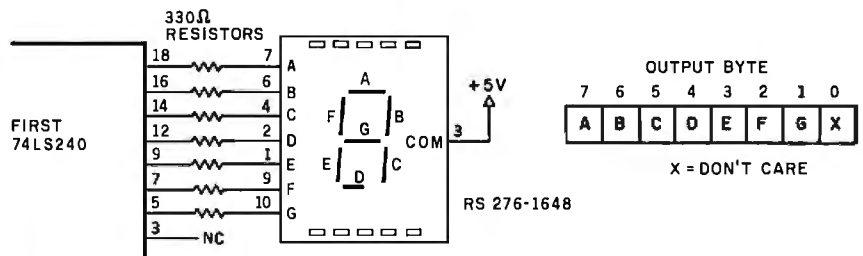

Figure 12: Sample LED driver application for the GPIO. The seven segments of the LED display are driven by seven output lines from the 74LS240. LED segments turn on when the lines are at 0 volts.

COMMUNICATIONS SOFTWARE \$30

DATA COMMUNICATIONS EVERYONE CAN AFFORD!

INTERNATIONAL SOFTWARE ALLIANCE IS PROVIDING THIS PROMOTIONAL OFFER TO END USERS BECAUSE WE BELIEVE THAT WHEN YOU USE **E-LYNC** YOU WILL BE SO PLEASED WITH THE EASE OF OPERATION THAT YOU'LL WANT TO ORDER OUR FULL FEATURED VERSION **LYNC**. **E-LYNC** WORKS JUST LIKE **LYNC** BUT DOESN'T HAVE ALL THE ADVANCED FEATURES OF **LYNC**.

E-LYNC is a powerful data communications program that can be used to transfer data or program files between computers or to connect to time-sharing systems. **E-LYNC** allows you to transfer any and all types of files from CP/M to CP/M, CP/M to IBM PC DOS, or IBM PC DOS to IBM PC DOS. **E-LYNC** will support baud rates up to 9600 on a cable hook up.

[**E-LYNC**] MODE: Can transfer data or program files between CP/M systems, between PC DOS systems, and between an IBM PC and a CP/M system running **E-LYNC** or **LYNC**. When transferring files **E-LYNC** uses field proven error detection and re-try protocol, sure to get your files across noisy phone lines or temporary disconnections. When in [**LYNC**] mode, both computer operators are in an immediate message mode and may type messages back and forth.

[**E-TERM**]INAL MODE: Terminal mode will allow you to connect your computer with time-sharing systems such as Source, Micronet, or CompuServe.

LYNC The full featured version is offered at \$125 and includes all of the features of **E-LYNC** plus:

[**LYNC**] MODE: Fetch files from another computer system; Use wild card names in send and fetch routines; View local and remote directories; Log onto local and remote drives.

[**TERM**]INAL MODE: The terminal mode in the full featured version of **LYNC** will allow you to buffer incoming data to the capacity of your memory and write the data to disk. Additional features of the terminal mode include: Send files to time share systems; Receive files from time share systems; Send files to other computers not running **LYNC**; Load files from other computers not running **LYNC**; Choice of full duplex or half duplex mode; plus other features.

LICENSING: **E-LYNC** is licensed on a per user basis. If you intend to use **E-LYNC** to communicate with another person, they must also purchase **E-LYNC**. **E-LYNC** for the IBM PC is written in 8088 Assembly Language. If you intend to communicate with a CP/M system you will also need the CP/M version of **E-LYNC**. ISA has both versions of **E-LYNC** available. **E-LYNC** can be upgraded to **LYNC** for \$95.

TERMS: Money Order, Check, C.O.D., MC or VISA. First Class Postage included. UPS Blue add \$2. C.O.D. add \$3. California Res. add 6%. Overseas add \$5.

DISK FORMATS: 8" Standard, 5" Vector Graphic, IBM PC DOS, TRS 80 Mod II w/CP/M, North Star, Cromenco, Superbrain 3.0 DOS or later.

PHONE ORDER DESK: (805) 966-3077 10am to 2pm PST Monday-Friday.

ISA IS NOW ACCEPTING PROGRAMS FROM SOFTWARE AUTHORS



INTERNATIONAL SOFTWARE ALLIANCE

1835 MISSION RIDGE
SANTA BARBARA, CA 93103

E-LYNC, **LYNC** are trademarks of Midnight Software

CP/M is a trademark of Digital Research

IBM PC DOS is a trademark of IBM



Protect yourself against the high cost of static

Electrostatic discharge, in addition to causing problems like the one above, can damage delicate electronic control and logic circuits. It takes so little voltage that you might not even feel the spark.

As little as 500 volts can send erroneous data, alter "memory", write incorrect data on a disk, or cause printers to run wild, throwing paper into the room. All of which means expensive service calls and even more expensive system down time.

Only 500 volts, yet you can easily generate over 12,000 volts of static charge just walking across a carpet. Even on a vinyl floor, 4000 volts is not uncommon.

The solution is simple

3M Brand Static Control Floor Mats can create an inexpensive "island of protection" around your delicate electronic equipment harmlessly draining the static charge from operators and other personnel.

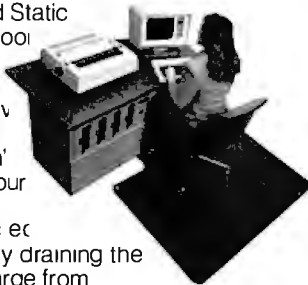

For as little as the cost of a single static-related service call, you can say goodbye to all these problems.

3M Brand Static Control Floor Mats come in hard mats for easy movement of castered chairs, and soft mats for comfortable standing.

For information about how you can purchase 3M Static Control Floor Mats, call toll free

1-800-328-1300

(In Minnesota, call collect 612-736-9625.)

Ask for the Data Recording Products Division.



Listing 2: Demonstration program for the LED driver.

```

90 ' DEMO MODEL I PROGRAM FOR 7-SEGMENT LED OUTPUT
100 OUT 3,137
105 INPUT V
110 OUT 0,0
120 GOSUB 1000
130 OUT 0,V
140 GOSUB 1000
150 IF INKEY$="" THEN GOTO 110 ELSE GOTO 105
1000 FOR I=0 TO 1000
1010 NEXT I
1020 RETURN
    
```

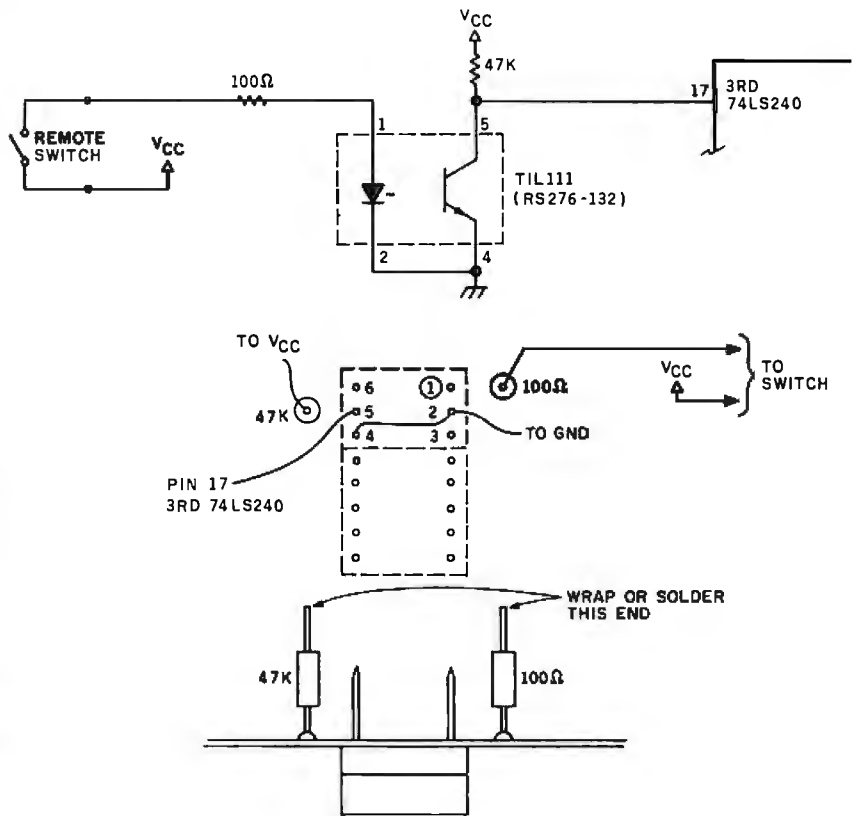

Figure 13: Sample optoisolator application for the GPIO. A remote switch lights the LED contained within the optoisolator. This turns on the phototransistor, bringing the collector to a 0 level.

276-1648, but any similar common-anode display may be used.

Wire the display as shown in figure 12. The 330-ohm resistors may be stood on end and wire-wrapped on the free end. The current-limiting resistors are connected to the first 74LS240 as shown in the figure.

The Model I BASIC program

shown in listing 2 will drive the LED display and illuminate any combination of the seven segments. Insert a "95 OUT 246,16" for the Model III version.

A second application is a remote sensor. Although I've used just one input, up to eight could be used in the GPIO configuration I'm using. The

LANIER'S TRIAL OFFER / TRIAL OFFER



EZ-1™ Word Processor
Prices start at \$5995.*

TypeMaster™ Word Processor
Prices start at \$7995.*

PUT THEM TO WORK FOR YOU.

You can learn a lot about word processors from ads and brochures.

You can find out even more from sales representatives.

But still, there's only one way to get a realistic idea of how much a word processor can do for you: try it out on your own work.

In your own office. With your own people.

And now, Lanier has two Trial Offers that let you do just that.

EZ-1 OR TYPEMASTER. PICK ONE.

The EZ-1. It does so much more than typical display word processors, from typing to checking spelling to letting you write your own programs, we call it a work processor.

The TypeMaster. No Problem® typing that's so efficient, it does the work of three ordinary electric typewriters. In the space of one.

We'll help you pick the one that's right for your office.

TWO COMPLETE TRIAL OFFERS.**

Naturally, we want you to see all our word processors can do.

To make sure of that, we'll set up the equipment. We'll train someone

from your office. We'll even let you try the software that's best for you.

And after a couple weeks of getting work back faster, getting letter-perfect pages, and getting all-around increased productivity, you'll never want to go back to the old way. Especially with prices this low: starting at only \$5995 for the EZ-1, only \$7995 for the TypeMaster. They're the best values in the business.

Send us this coupon to set up an immediate appointment. Or call (800) 241-1706. Except in Alaska and Hawaii. In Georgia, call collect (404) 321-1244.

*Prices start at \$5995—EZ-1, \$7995—TypeMaster. Systems include single disc drive and letter-quality printer. Software not included.

**Trial charges may be partially applied to your word processor purchase.

©1982 Lanier Business Products, Inc.

Mail to:
Lanier Business Products, Inc.
1700 Chantilly Drive N.E., Atlanta, GA 30324

July '82 Byte 4 81 B G2

Name Title

Phone Best time to call

Firm

Address County

City State Zip

LANIER®

Makers of the EZ-1™ Work Processor,
No Problem® Typewriter, No Problem Shared System™ and TypeMaster™

THE ~~\$595*~~ \$549.90 SMART TERMINAL

The Heath 19 Smart Video Terminal gives you all the important professional features you want in a terminal, all for under \$600.* You get the flexibility you need for high-speed data entry, editing, inquiry and transaction processing. It's designed to be the backbone of your system with heavy-duty features that withstand the rigors of daily use.

Standard RS-232C interfacing makes the 19 compatible with DEC VT-52 and most computer systems. And with the 19, you get the friendly advice and expert service that makes Heath/Zenith a strong partner for you.

Sold through Heathkit Electronic Centers† nationwide (see your white pages for locations). Stop in today for a demonstration of the Heath 19 Smart Video Terminal. If you can't get to a store, send for the latest Heathkit® Catalog. Write Heath Co., Dept. 334-924, Benton Harbor, MI 49022.

HEATH/ZENITH

Your strong partner

Completely addressable blinking cursor lets you edit anywhere on screen.

Reverse video by character lets you emphasize words, phrases or paragraphs.

High resolution CRT gives you sharp, easy-to-read image, reduces eye-strain.

Z-80 microprocessor-control makes the 19 capable of multitude of high-speed functions. It's the only terminal with ROM source code readily available.

Complete ASCII character set including upper case, lower case with descenders, and special graphic symbols.

80 character by 24 line format, plus 25th line for operator messages and prompts.

Professional quality keyboard, standard typewriter layout, 72 keys, including 12 special function keys.

Insert and delete character or line plus erase to end of line and end of screen make the 19 ideal for sophisticated editors like WORD-STAR.

Cursor and special functions are accessible by keyboard or computer, using either DEC VT-52 or ANSI Standard protocols.

Keypad in calculator format permits fast, easy entry of numeric data.



*In kit form, F.O.B. Benton Harbor, MI. Also available the completely assembled Zenith Z-19 at \$895. Prices and specifications are subject to change without notice.

†Heath Company and Veritechnology Electronics Corporation are wholly-owned subsidiaries of Zenith Radio Corporation. The Heathkit Electronic Centers are operated by Veritechnology Electronics Corporation.

Listing 3: Demonstration program for optoisolator input.

```

100 DEMO MODEL I PROGRAM FOR OPTO ISOLATOR INPUT
110 OUT 3,137
120 PRINT INP(2)
130 GOTO 120
    
```

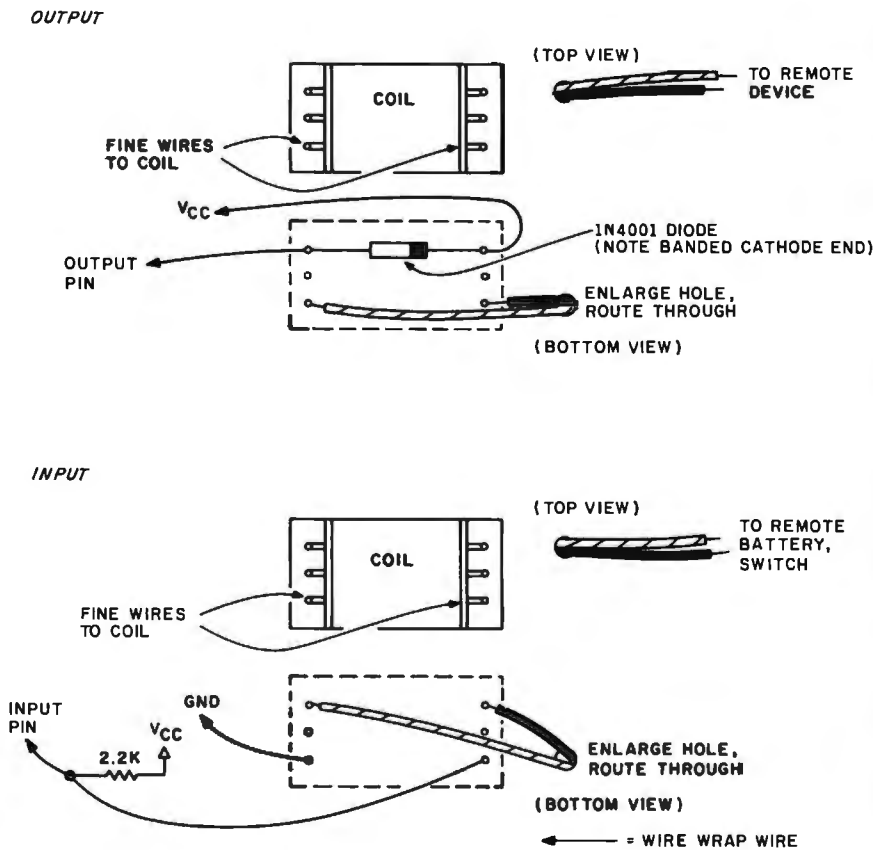

Figure 14: Physical layout of the Radio Shack DIP (dual-inline package) relays. The relays may be used for both input and output.

remote sensor uses a Radio Shack optoisolator IC. The optoisolator contains an infrared LED and phototransistor in one package, as shown in figure 13. Remote-switch closure lights the LED and causes the transistor to conduct, bringing the input line to pin 17 of the 74LS240 down to 0.

The optoisolator is a "current-driven" device, allowing the connecting line to be any length as long as the current is sufficient to light the LED and cause the phototransistor to saturate. The optoisolator eliminates the noise problem associated with TTL (transistor-transistor logic) inputs.

The wiring diagram for the remote sensor is shown in figure 13. Again, the resistors may be positioned on end. Use the program shown in listing 3 (Model I) or listing 1 (Model III) to test the optoisolator action.

A third application uses relay input or output. The physical layout for both input and output is shown in figure 14. Radio Shack 275 through 228 relays (22.5 mA) are used and may be mounted on the board as shown. These relays will handle up to 0.75 ampere (A) on their contacts and can be used to drive a load larger than the 10 or 40 mA output of the 74LS240. ■

PASS

FAIL

MOD II CP/M® IQ QUIZ

Does your TRS-80 Mod II:

Yes No

- transfer files from TRSDOS to CP/M?
- store 596 K bytes on a floppy disk?
- talk to a Cameo cartridge disk system?
- talk to a Corvus Winchester disk system?
- support XON/XOFF, ETX/ACK and clear-to-send serial printer protocols?
- talk to double sided floppy drives?
- give you access to hundreds of applications programs?
- give you a choice of a dozen or more languages?
- run the best documented, best supported CP/M available?

If you answered no to any of these questions, raise your Mod II's IQ with

P&T CP/M® 2

Contact us, and we'll send you details on how to expand your Mod II's horizons.

Price (FOB Goleta)
 \$185 for standard P&T CP/M® 2
 \$250 for P&T CP/M® 2 for Corvus or Cameo hard disk drives.



PICKLES & TROUT

P.O. BOX 1206, GOLETA, CA 93116
 (805) 685-4641

CP/M is a registered trademark of Digital Research.
 TRS-80 is a trademark of Tandy Corporation.



FORMULA INTERNATIONAL INC.

12603 CRENSHAW BOULEVARD • HAWTHORNE, CALIFORNIA 90250 • (213) 973-1921



Introducing THE Pineapple



48K Color Computer Kit

Easy to assemble! All components are clearly silk screened on the circuit board. Kit includes predrilled double sided PC Board, all integrated circuits, sockets, professional high-impact plastic casing, keyboards, connectors and switching power supply.

Features

- Numeric key pad
- Game paddle jacks on both sides
- Speaker volume control on the back.

\$645⁰⁰
per kit
No C.O.D. orders

Dealer inquiries invited.

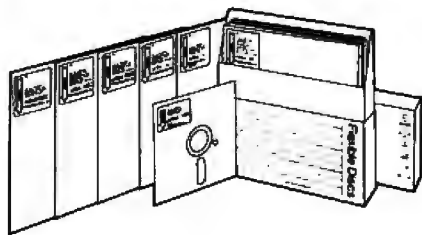

For Data Reliability—Memorex Flexible Discs

ALL for these LOW PRICES:

1-9	10-99	100-499
\$2.45	\$2.15	\$2.00

500 & up
call for info.

5 1/4" Flexible Disc Sale

Why buy other brands when you can buy MEMOREX disc for much less and backed by 1 year factory warranty.

5 1/4 Single Sided, Double Density, Soft Sector
 5 1/4 Single Sided, Double Density, 10 Hard Sector
 5 1/4 Single Sided, Double Density, 16 Hard Sector

Circle 178 on inquiry card.

The Logo Journal

News and Views of the Logo Community

Learning Physics from a Dynaturtle	<i>Andrea A. diSessa and Barbara Y. White</i>	324
Logo Music	<i>Jeanne Bamberger</i>	325
Leading Fish to Water	<i>Dr. William Higginson</i>	328
Logo Project PROKOP	<i>Heinz-Dieter Boecker and Gerhard Fischer</i>	329
The Group of the Turtle	<i>Dr. Uri Leron</i>	330
The Lamplighter Project	<i>Henry Gorman Jr.</i>	331
Logo Research at Bank Street College	<i>Jan Jewson and Roy D. Pea</i>	332
Young People's Logo Association	<i>James H. Muller</i>	333
Logo Update	<i>Phil Lemmons</i>	334

Learning Physics from a Dynaturtle

Andrea A. diSessa and Barbara Y. White
 The Division for Study
 and Research in Education
 Massachusetts Institute of Technology
 Cambridge, MA 02139

The Logo turtle has proved a remarkably good microworld in which students can experience and learn mathematics painlessly while pursuing personally satisfying activities. To see if a similar idea could work for physics, author diSessa created a dynamic turtle, *dynaturtle* for short, which obeys Newton's Laws of motion. A dynaturtle remains at rest or travels at a uniform velocity in a straight line except when acted on by forces. The forces are little pushes, or kicks, specified by the student via the keyboard. Depending upon their direction, kicks can cause the dynaturtle to speed up, slow down, or change direction. (Although a dynaturtle doesn't presently come built in to Logo, the language makes it extremely easy to add one.)

Experience with elementary school students proved that even simple activities with the dynaturtle (such as driving it to intercept a target) were, indeed, both motivating and instructive. For example, the students had an apparently deep-seated misconception that things always go in the direction you push them. In reality, as Newton showed and a dynaturtle exemplifies, a push merely adds to the existing momentum of an object and typically only deflects it.

When the students translated this belief about force and motion into a strategy for hitting the target, as shown in figure 1, they would inevitably miss the target. With time and practice, the feedback from the microworld allowed the students to gain a better understanding of how forces should affect the motion of an object. Subsequent work with univer-

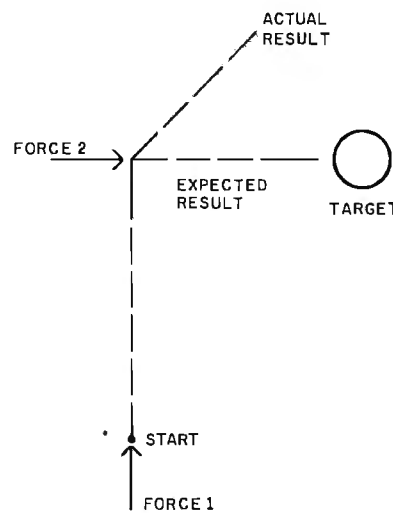

Figure 1: Dynaturtle helps students gain a better understanding of how force affects a moving object.

sity physics students showed misconceptions and patterns of learning similar to those held by the elementary school students. This accords with recent research that shows how little conventional instruction affects intuitive beliefs concerning the laws of physics.

Dynaturtle, like the original Logo turtle, is a tool for students and teachers alike. Various researchers have and are creating materials for using a dynaturtle in the context of a programming experience for elementary school students (including handicapped students, as a replacement for the usual kinesthetic experiences through which we develop physical intuition).

To aid in teaching physics, author White has developed a "curriculum"

in the form of a series of games using the dynaturtle. The idea is that with particular goals and problem situations, the games will focus students' attention on difficulties in their conceptions about force and motion and thus, step by step, lead them to a solid understanding of the problem.

White's curriculum began with a detailed study of the many kinds of difficulties high school students have with fundamental force and motion problems. She concentrated on the simplest qualitative ideas where "formula cranking" will not help. Thereafter, she developed the series of games and also devised a set of problems to assess changes in the students' level of understanding. In a controlled experiment, the games proved strikingly successful at eliminating basic misconceptions and at improving overall understanding. This finding is an encouraging indication that such game-like activities can be used not only for entertainment, but also for solving significant pedagogical problems. ■

References

1. diSessa, A. "Unlearning Aristotelian Physics: A Study of Knowledge-Based Learning," *Cognitive Science*, Vol. 6 No. 1, 1982.
2. Papert, S., Watt, D., diSessa, A., and Weir, S. *Final Report of the Brookline Logo Project, Part II: Project Summary and Data Analysis*. Memo 545, AI Lab, MIT, Cambridge, MA, 1979.
3. White, B. Y. *Designing Computer Games to Facilitate Learning*. Technical Report AI-TR-619, AI Lab, MIT, Cambridge, MA, 1981.
4. White, B. Y. "Sources of Difficulty in Understanding Newtonian Dynamics." Submitted to *Cognitive Science*.

Logo Music

Jeanne Bamberger
The Division for Study
and Research in Education
Massachusetts Institute of Technology
Cambridge, MA 02139

Logo music has been quietly evolving over the past 10 years within the larger Logo environment. Logo music was first implemented on the PDP-10 with the help of Terry Winograd, using a digital music-box peripheral designed by Marvin Minsky. The present version of Logo music, completed last year, was built by Leigh Klotz and Hal Abelson as a special version of Logo for the Apple II.

Logo music uses an ALF synthesizer board for sound generation connected to a simple stereo amplifier and two speakers. With the full capabilities of Logo itself (except for graphics), together with the ALF board, there are six operative voices, a six-octave range, eight parameters available for user manipulation of the sound envelope, two percussion sounds, and almost immediate response time between typed commands and resulting sound. Altogether this makes quite a powerful system for interactive, composition-like projects.

In the spirit of Logo, the music language has been designed to be as intuitive as possible while at the same time lending itself to serious, almost endlessly expanding musical projects. The system is sufficiently flexible and powerful to be appropriate for beginning or more advanced music students of any age. It can be used as "scratch paper" for musically sophisticated composers who wish to experiment with musical design through procedural descriptions.

The system is also useful as an additional medium (along with turtle geometry, for instance) within which to develop procedural thinking, prob-

lem-solving skills, new applications for general arithmetic functions, and concepts concerning speed and distance relations.

Logo music contrasts with other educational computer-music programs in two fundamental ways: (1) based on our ongoing research into musical cognition, we have tried to develop an environment that builds on students' intuitive musical knowledge rather than simply computerizing traditional music instruction, and (2) we have tried to exploit the poten-

tial of the computer for truly interactive, real-time experimenting.

For example, we have made it easy for students to design higher-level procedural descriptions of musical relations. For example, the notion of meter is not taken as given but as something to be generated procedurally by the students themselves. The structure of the major scale (or, indeed, tonality) need not be simply taken for granted but rather can be *constructed* as a procedure that chooses from the complete pitch col-

```
TO REPNUM :NUM :TIMES
  IF :TIMES = 0 STOP
  PRINT :NUM
  REPNUM :NUM :TIMES - 1
```

```
TO BEAT :DUR :TIMES
  IF :TIMES = 0 STOP
  BOOM :DUR
  BEAT :DUR :TIMES - 1
```

```
TO UPPITCH :PITCH :INCREMENT
  IF :PITCH > 12 STOP
  PLAY :PITCH 6
  UPPITCH :PITCH + :INCREMENT :INCREMENT
```

```
TO SQUIRAL :SIDE :INCREMENT
  IF :SIDE > 200 STOP
  FORWARD :SIDE RIGHT 90
  SQUIRAL :SIDE + :INCREMENT :INCREMENT
```

```
REPNUM 10 6
10
10
10
10
10
10
```

```
BEAT 10 6 ( ♩ = 10)
```



```
BEAT 5 6
```



```
UPPITCH 0 2 ( ♩ = 6)
```

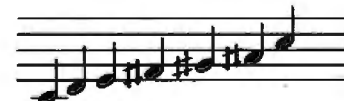

```
UPPITCH 0 4
```



```
SQUIRAL 1 5
```



Figure 1: Four Logo procedures with the same structure produce different effects.

ATARI HOME COMPUTERS



ATARI 800	ATARI 400
16K ... \$649	16K ... \$269
32K ... \$729	32K ... \$389
48K ... \$769	48K ... \$489

410 Recorder	\$76.00
810 Disc Drive	\$449.00
822 Printer	\$269.00
825 Printer	\$589.00
830 Modem	\$159.00
820 Printer	\$259.00
850 Interface	\$169.00
New DOS 2 System	\$29.00
CX30 Paddle	\$18.00
CX40 Joy Stick	\$18.00
CX853 16K RAM	\$77.95
Microtek 16K RAM	\$74.95
Microtek 32K RAM	\$119.95
Ramdisk (128K)	\$429.95
Intec 48K Board	\$219.95
Intec 32K	\$119.95
One year extended warranty	\$70.00
481 Entertainer	\$69.00
482 Educator	\$130.00
483 Programmer	\$49.00
484 Communicator	\$344.00

ATARI HOME COMPUTER PROGRAMS

HOME OFFICE	
CX404 ATARI Word Processor	\$119.00
CX8102 Calculator	\$29.00
CX412 Dow Jones Investment Evaluator	\$99.00
CX4109 Graph It Joystick optional	\$17.00
CX4104 Mailing List	\$20.00
CX4115 Mortgage & Loan Analysis	\$13.00
CX4103 Statistics I	\$20.00
CX8107 Stock Analysis	\$20.00
CXL4015 TeleLink I	\$23.00
HOME STUDY	
CX4101 An Invitation to Programming I	\$20.00
CX4106 An Invitation to Programming 2	\$23.00
CX4117 An Invitation to Programming 3	\$23.00
CX4107 Biorhythm	\$13.00
Conversational Languages (ea.)	\$46.00
CX4121 Energy Czar	\$13.00
CX4114 European Countries & Capitals	\$13.00
CX4108 Hangman, Joystick optional	\$13.00
CX4102 Kingdom	\$13.00
CXL 4007 Music Composer	\$34.00
CX4123 Scram, uses joystick	\$20.00
CX4112 States & Capitals	\$13.00
CX4110 Touch Typing	\$20.00
HOME ENTERTAINMENT	
PAC MAN	\$35.00
CENTIPEDE	\$35.00
CAVERNS OF MARS	\$32.00
CXL4013 Asteroids	\$29.00
CXL4004 Basketball	\$27.00
CX4105 Blackjack	\$13.00
CXL4009 Computer Chess	\$29.00
CXL4012 Missile Command	\$29.00
CXL4008 Space Invaders	\$29.00
CXL4011 Star Raiders	\$39.00
CXL4006 Super Breakout	\$29.00
CXL4010 3-D Tic-Tac-Toe	\$27.00
CXL4005 Video Easel	\$24.00
PROGRAMMING LANGUAGES AND AIDS	
CXL4003 Assembler Editor	\$47.00
CXL4002 ATARI BASIC	\$47.00
CX8126 ATARI Microsoft BASIC	\$70.00
CXL 4018 PILOT	\$72.00
CX405 PILOT (Educational)	\$105.00

Visicalc	\$189.00
Letterperfect (Word Processor)	\$109.00
Data Soft Textwizzard	\$89.00
Canyon Climber	\$24.00
Tumble Bug	\$24.00
Shoot Arcade	\$24.00
Pacific Coast	\$24.00
Bishops Square	\$24.00
Micro Painter	\$27.00

ATARI PROGRAM EXCHANGE:

Eastern Front '41	\$25.50
Avalanche	\$15.50
Outlaw	\$15.50
747 Landing Simulation	\$15.50
Babel	\$15.50
Dog Daze	\$15.50
Downhill	\$15.50
Attack!	\$15.50
Blackjack-Casino	\$15.50
Reversi II	\$15.50
Domination	\$15.50
Solitaire	\$15.50
Disk Fixer	\$15.50
Supersort	\$15.50
Data Management	\$15.50
Chameleon	\$15.50
Instedit	\$15.50
Insomnia	\$15.50
My First Alphabet	\$25.50
Mapware	\$18.00
Number Blast	\$11.50
Family Cash Flow	\$15.50
Weekly Planner	\$15.50
Bowler's Data Base	\$13.00
Banner Generator	\$11.50
Crystal Software	
Bermuda Fantasy	\$26.00
Beneath Pyramids	\$20.00
Galactic Quest	\$26.00
House of Usher	\$20.00
Forgotten Island	\$26.00
Haunted Palace	\$33.00
Compumax (Acct. Rec., Gen. Ledger, Inventory, Payroll, ea.)	\$110.00
Synapse	
File Manager 800	\$79.95
Dodge Racer	\$19.00
Chicken	\$24.00
Slime	\$24.00
Nautilus	\$24.00
Disk Manager	\$24.00
Fort Apocalypse	\$24.00
Assembler	\$39.00
Protector	\$24.00
EXPY (Automated Simulation)	
Ricochet	\$14.50
Crush, Crumble & Chomp	\$24.00
Star Warrior	\$29.00
Rescue at Rigel	\$24.00
Datstones	\$16.00
OnLine	
Jaw Breaker	\$27.00
MousKATTACK	\$31.00
Invasion Orion	\$18.50
Mission Asteroid	\$22.00
The Next Step	\$34.00
Softporn	\$27.00
Wizard & Princess	\$29.00
Arcade Plus	
Ghost Hunter (cassette)	\$24.00
Ghost Hunter (disk)	\$30.00
K-Byte	
K-BYTE Crazy Shoot Out (ROM)	\$39.00
K-DOS	\$69.00
K-Razy Kritters	\$39.00
K-Star Patrol	\$39.00
K-Razy Antiks	\$39.00
Stick Stand	\$6.99

Texas Instruments



TI-99/4A \$299

PHA2100 R F Modulator	\$29.00
PHP1600 Telephone Coupler	\$179.00
PHP1200 Peripheral Expansion Box	\$199.00
PHP1220 RS 232 Card	\$143.00
PHP1240 Disk Controller	\$199.00
PHP1250 Disk Drive	\$319.00
PHP1100 Wired Remote Controllers (pair)	\$31.00
PHP1260 32K RAM	\$229.00
PHP Printer Solid State	\$319.00
PHM3006 Home Financial Decisions	\$26.00
PHM3013 Personal Record Keeping	\$43.00
PHD5001 Mailing List	\$60.00
PHD5021 Checkbook Manager	\$18.00
PHM3008 Video Chess	\$60.00
PHM3010 Physical Fitness	\$26.00
PHM3009 Football	\$26.00
PHM3018 Video Games I	\$26.00
PHM3024 Indoor Soccer	\$26.00
PHM3025 Mind Challengers	\$22.00
PHM3031 The Attack	\$35.00
PHM3032 Blast	\$22.00
PHM3033 Blackjack and Poker	\$22.00
PHM3034 Hustle	\$22.00
PHM3036 Zero Zap	\$18.00
PHM3037 Hangman	\$18.00
PHM3038 Connect Four	\$16.00
PHM3039 Yahtzee	\$22.00
Tombstone City 21st Century	\$34.00
Munch Man	\$34.00
T I INVADERS	\$34.00
CAR WARS	\$34.00

Printers

Smith Corona TP1	\$699.00
Centronics 739-1	\$519.00
Centronics 739-3	\$619.00
Diablo 630 Special	\$1799.00
Epson	
MX80 w/Graftrax	\$449.00
MX80FT III	\$Call
MX100	\$Call
NEC	
8023	\$549.00
7710/7730	\$2399.00
3510/3530	\$1789.00
Okidata	
82A	\$499.00
83A	\$749.00
84	\$1129.00
Citoh Starwriter	
F10-40 CPS	\$1469.00
F10-55 CPS	\$Call
Prowriter	\$499.00
Talley	
8024-L	\$1629.00
IDS	
Prism	\$Call
MPC Apple Parallel Board & Cable	\$69.00
2 Meter RS232-RS232	\$29.95
Cables Available For Most Interfacing Purposes	

Computer Covers

ATTRACTIVE DUST COVERS FOR YOUR COMPUTER AND DISK DRIVE

Atari 400	\$6.99	Commodore VIC-20	\$6.99
Atari 800	\$6.99	Commodore 8032	\$14.99
Atari 810	\$6.99	Commodore	
All Atari Covers are Beige.		8050/4040	\$10.99
		All Commodore covers are Royal Blue.	

Most software for Atari 400/800 available on cassette or disk.

computer mail order west

CALL TOLL FREE **800-648-3311**

IN NEVADA, CALL (702) 588-5654

P.O. BOX 6689, STATE LINE, NEVADA 89449



HP-85 \$1899

HP-86	\$Call
HP-87	\$1769.00
HP-125	\$1999.00
HP-85 16K Memory Module	\$169.00
5 1/4" Dual Master Disc Drive	\$1769.00
Hard Disk w/Floppy	\$4349.00
Hard Disk	\$3440.00
"Sweet Lips" Plotter	\$1149.00
80 Column Printer	\$799.00
87 CP/M	\$399.00
87 128K Memory	\$610.00
87 Visicalc	\$205.00

HP-41CV Calculator \$239.00

41C	\$189.00
11C	New Low Price \$79.00
12C	\$114.00
34C	\$114.00
38C	\$114.00
HP-41 Printer	\$340.00

HPIL CALCULATOR PERIPHERALS

IL Modul	\$104.00
Digital Cassette	\$449.00
Printer/Plotter	\$419.00
Card Reader	\$164.00
Optical Wand	\$99.00

NEC

8001-A	\$749.00
8031	\$749.00
8012	\$549.00
Accounts Receivable	\$295.00
Word Processing	\$395.00
General Accounting	\$295.00
Inventory Control	\$295.00
Job Cost	\$295.00

Maxell Disks

MD I (box of 10)	\$36.00
MD II (box of 10)	\$46.00
MFD I (8")	\$44.00
MFD II (8" Double Density)	\$54.00
Syncom (box of 10)	\$29.00

Apple

Call for availability and prices on all Apple computers and peripherals.

Televideo

910	\$579.00
912C	\$699.00
920C	\$749.00
925C	\$749.00
950	\$939.00

Call for computers

802	\$Call
802H	\$Call
816	\$Call
806	\$Call

commodore BUSINESS MACHINES



CBM 8032 \$1039

SOFTWARE	
Word Pro 5 Plus \$319.00
Word Pro 4 Plus \$299.00
Word Pro 3 Plus \$199.00
Commodore Tax Package \$589.00
Visicalc \$189.00
Medical Billing \$449.00
The Source \$89.00
OZZ Information System \$289.00
Dow Jones Portfolio \$129.00
Pascal \$239.00
Legal Time Accounting \$449.00
Word Craft 80 \$289.00
Power \$79.00
Socket-2 Me \$20.00
Jinsam \$Call
MAGIS *Call
CPA \$Call
Real Estate Package \$Call
The Manager \$209.00
Softrom \$129.00
BPI Inventory Control \$319.00
BPI Job Costing \$319.00
BPI Payroll \$319.00
BPI General Ledger \$329.00
Creative I SAM \$79.00
Creative General Ledger \$229.00
Creative Accounts Receivable \$229.00
Creative Inventory \$229.00

4032	\$969.00
4016	\$769.00
8096 Upgrade Kit	\$369.00
Super Pet	\$1599.00
2031	\$529.00
8250 Doubled Sided Disk Drive	\$1699.00
D9060 5 Megabyte Hard Disk	\$2399.00
D9090 7.5 Megabyte Hard Disk	\$2699.00
8050	\$1299.00
4040	\$969.00
8300 (Letter Quality)	\$1799.00
8023	\$769.00
4022	\$499.00
Pet to IEEE Cable	\$37.00
IEEE to IEEE Cable	\$46.00
Tractor Feed for 8300	\$240.00

VIC 20 \$239 VIC 64 Call

VIC 6 Pack Program	\$44.00
VIC 1530 Commodore Datassette	\$69.00
VIC 1540 Disk Drive	\$499.00
VIC 1515 VIC Graphic Printer	\$339.00
VIC 1210 3K Memory Expander	\$32.00
VIC 110 8K Memory Expander	\$53.00
16K VIC Expansion	\$99.00
VIC 1011 RS232C Terminal Interface	\$43.00
VIC 112 VIC IEEE-488 Interface	\$86.00
VIC 1211 VIC 20 Super Expander	\$53.00
VT 232 VicTerm I Terminal Emulator	\$9.00
VIC 1212 Programmers Aid Cartridge	\$45.00
VIC 1213 VICMON Machine Language Monitor	\$45.00
VIC 1901 VIC AVENGERS	\$23.00
VIC 1904 SUPERSLOT	\$23.00
VIC 1906 SUPER ALIEN	\$23.00
VIC 1907 SUPER LANDER	\$23.00
VIC 1908 DRAW POKER	\$23.00
VIC 1909 MIDNIGHT DRIVE	\$23.00
VIC 1910 RADAR RAT RACE	\$23.00

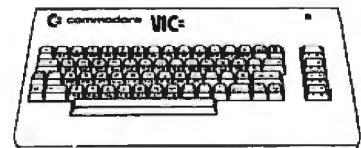

Terminal	\$13.00
Un Word	\$13.00
Grafix Menagerie	\$11.00
VIC PICS	\$15.00
Ticker Tape	\$13.00
Banner Headliner	\$13.00
RS 232	\$39.00
VT 106A Recreation Pack A	\$44.00
VT 107A Home Calculation Pack A	\$44.00
VT 164 Programmable Character/Gamegraphics	\$12.00
Household Finance	\$27.00
VIC Games	\$19.00
VIC Home Inventory	\$13.00
VIC Rec/Ed II	\$13.00
VL 101 Introduction to Computing	\$19.00
VL 102 Introduction to BASIC Programming	\$19.00
VM110 VIC 20 Programmers Reference Guide	\$15.00

In-stock items shipped same day you call. No risk, no deposit on C.O.D. orders. Pre-paid orders receive free shipping within the continental United States with no waiting period for certified checks or money orders. All prices shown are cash prices. Add 3% for Mastercard and Visa. NV and PA residents add sales tax. All items subject to availability and price change.

Monitors

BMC 12" Green	\$85.00
Amdak	
300G	\$169.00
Color I	\$339.00
Color II	\$699.00
Color III	\$429.00
TI 10" Color	\$349.00
Zenith 9" (Green)	\$119.00

Modems

Hayes	
Smart	\$239.00
Chronograph	\$199.00
Micromodem II	\$279.00
Micromodem 100	\$309.00
Novation Auto	\$239.00
D Cat	\$169.00
Cat	\$159.00
Anchor Modem	\$79.00

Nev. & Pa. residents add sales tax.

computer mail order east

CALL TOLL FREE **800-233-8950**

INTERNATIONAL CALLS AND IN PA. CALL (717) 327-9575
477 E. THIRD ST., WILLIAMSPORT, PA 17701

lection as a special case but one that can be generalized. Further, we have taken multiple descriptions to be a central tool in creative learning. Thus students work at different levels of musical structure and with varying units of description. Tunes can be built using whole, preprogrammed figures, and melodies can be transformed and regrouped by manipulating pitch only (with rhythm given) or rhythm only (with pitch given). Or coherent structures can be designed using procedural relations as the operative entities—sequence, intervalic relations, texture,

and harmony. Procedural design becomes, then, a kind of model for developing musical thinking, for the development of active, informed listening to real music, and the basis for building musical structure itself.

In this process new modes of description and new musical insights emerge. Consider, for example, what happens when Logo musical experiments are juxtaposed with Logo experiments in other media.

In the examples of figure 1 we see the *same* procedure producing quite *different* effects as a result of the actors they are talking to: PRINT,

BOOM, PLAY, FORWARD (TURTLE). The procedures, then, including the notion of recursion, can be seen as organized actions of a particular sort. Their meanings as *apprehended* are, on one hand, entirely different, but on the other can be seen to share common underlying, dynamic structures. Experiments of this sort can help students to *gain* new insights into familiar phenomena, to expand their understanding of these phenomena, and to develop powerful tools that can serve as "things to think with." ■

Leading Fish to Water

Early Observations on the Use of Logo

Dr. William Higginson, Chairman
Science, Technology, and Mathematics
Faculty of Education
Queen's University
Kingston, Ontario
Canada K7L 3N6

Since August 1981, the Faculty of Education at Queen's University has, through the kind permission of Professor Harold Abelson, been a test site for the MIT version of Logo for the Apple computer. For six months, using a prototype of the system now distributed commercially by Terrapin and Krell, a small group of faculty members, graduate students, local teachers, and interested members of the community has spent time using the Logo facilities of the Instructional Computing Laboratory, which has five Apple II Plus computers.

The Logo learners varied in age from 6 up (several people worked with their own children) and the class size ranged from 1 to 15. Although no systematic study was carried out (our

first intention was to familiarize ourselves with the system), there appears to be a consensus on a number of issues. Perhaps the two most important have to do with the potential of Logo and the likelihood of this potential being realized in schools. Briefly stated, our enthusiasm for the language started out high and has continued to grow, but we are not optimistic about the chances of an authentic version of Logo reaching the average classroom.

We cannot fail to be impressed by the quality of the work done by Seymour Papert and his colleagues. The claims made in *Mindstorms*, for example, are ambitious and ones about which a cautious observer would tend to be skeptical. Our feeling, however, at least at this early stage in our work, is that these claims are substantially sound.

Logo appears to touch something quite fundamental in children's learning procedures irrespective of the

"school ability" of the child. The speed at which the group of self-confident 10-year-olds in my afternoon enrichment class grasps ideas is, however, particularly impressive. Negative numbers and Cartesian coordinates, for instance, get gobbled up in a two-minute discussion of SETXY. The unforced way in which powerful ideas emerge from the turtle geometry microworld is in stark contrast to the struggles of traditional teaching. The old riposte "you can lead a horse to Euclid but you can't make him think" did not seem to apply. The naturalness of the children's responses to questions that emerged from Logo situations made me feel that I was bringing not horses (or cats) to this educational pond, but fish.

It seems, then, that Logo is not just the best educational software on the market at the moment (not, in itself particularly high praise), but a new type of educational resource with enormous potential for developing

About the Author

Dr. Higginson is also editor of *Logophile*, the newsletter of the Logo Special Interest Group of the Educational Computing Organization of Ontario.

the social, aesthetic, emotional, and intellectual abilities of learners. I wish that the availability of such a powerful tool would, by itself, imply an improvement in the quality of education of the average child. Unfortunately, a realistic assessment of the situation indicates that such a result is not very likely. One basic problem lies in the absence of what is known in the Third-World context as "secondary infrastructure." At the first or developmental level, excellent work has been done, and at the third or field level, there is a great need for a resource such as Logo. Yet between these two levels, where a substantial group of well-trained and experienced consultants and teacher educators is essential, there is an almost total void. It will be the rare classroom teacher who will be able to get assistance from anyone who has had any degree of experience with the use of Logo. Resource materials such as Abelson and diSessa's excellent *Turtle Geometry* are simply out of reach of most teachers without regular and sustained assistance. It seems unlikely that this assistance is going to be available to more than a small per-

centage of teachers.

A second and probably greater barrier to the implementation of an authentic version of Logo in schools is the nature of the underlying philosophy of the language. Logo is child-centered and, at least on the surface, unstructured and nonhierarchical. Many teachers at present feel pressured to have formal, hierarchical and content-centered curricula. There is, however, much more structure to Logo than meets the eye; students are free to roam wherever they choose *within* the boundaries established by the rich and highly structured Logo environment.

Logo no doubt will be used, but the form of Logo that will evolve in many cases will have little in common with Papert's original vision. Just as educational psychologists in North America ignored the inherent contradictions between neobehaviorism and the child-development theories of Piaget, curriculum writers will see no difficulties in the creation of turtle geometry workbooks to teach basic mathematics in a highly formalized way.

At another level, however, the

"degree of guidance" problem is difficult to cope with. The questions of what sort of assistance is best for which children under what circumstances are not likely to find any quick or widely agreed upon answer. Nor will any of the widespread problems that face classroom teachers automatically disappear with the introduction of Logo. In the long run, languages like Logo may prove to be a help with children who are emotionally disturbed or educationally handicapped, but that remains to be seen.

To say these things is not to disagree with Papert. For teachers who feel comfortable with mathematical ideas like recursion and symmetry and who have some freedom of choice in curriculum matters, Logo is likely to be, at least in the short run, a powerful educational tool. (The value of long-term use of Logo is a more open question. I am aware of no extended studies of children using Logo.) For the other group of teachers a great deal of work must be done before they can realistically be expected to use the power of this most attractive language. ■

Logo Project PROKOP

Heinz-Dieter Boecker and Gerhard Fischer
Research Group on Man-Machine
Communication
Department of Computer Science
Azenbergstrasse 12
D-7000 Stuttgart
West Germany

The Logo research project in Darmstadt, West Germany, started in 1974 and ended in late 1979. It was a large project conducted by an interdisciplinary group of up to seven researchers and supported by the federal government.

Work started after an evaluation study of computer uses in schools which concluded that the most promising way to use computers was not

CAI (computer-aided instruction) but to give the computer to the student as a tool.

Empirical work was considered important right from the beginning and the project installed several terminals connected to a DEC PDP-10 at a local high school (later on, personal Logo machines from General Turtle were added). Of the different approaches tried in the project, only the work

done by the two authors will be surveyed in the following description. Other approaches involved different kinds of experimental classes and students of different ages.

We worked with high school students from 15 to 18 years old. Our main concern was to teach problem solving in the context of an interesting environment. We taught several experimental classes over periods

ranging from 18 months to 2 years. We considered the long duration important so the students would have time to get beyond the stage of solving trivial problems or fighting with the technical problems of the system.

We used Logo quite differently compared to other Logo projects. Although turtle geometry was one of our projects, our main concern was using Logo as a full list-processing language that makes possible projects of nontrivial complexity. Seen from this perspective, Logo is a version of LISP that is oriented toward the non-expert user.

We have developed extensive curriculum material that we tested with the students and have carefully documented (including a very detailed documentation of the programs) in five volumes covering non-numerical mathematics, linguistics, computer science, artificial intelligence, and games. The publications

are in German and can be ordered at the following address: Hessisches Institut fuer Bildungsplanung and Schulentwicklung, Bodenstedstrasse 7, D-6200 Wiesbaden, West Germany.

The theory of our work was based not only on Piaget's research but also on problem-solving work from Polya and Newell and Simon. We made some efforts to teach cognitive abilities (e.g., planning, abstraction, generalization, and understanding) by doing projects in the above areas.

We made a big effort to integrate our work with the students' other activities and interests. It seems to us that many Logo projects failed to achieve this integration. We felt we had to build bridges between the innovative strategies of the Logo work and the other interests of students and teachers. One of our goals was to create a place for this work in German schools, and we were in favor of

establishing a new discipline of computer science (not just an imitation of the university subject) in German high schools.

We tried to use the existing expertise in German schools, which was in BASIC programming, and showed how to practice a functional, procedure-oriented style of programming with some versions of BASIC.

Our more theoretical work included among other things the development of a theory for the construction of learning environments through the creation of entry points, transient objects, and microworlds.

The last two topics are described in two English papers by the authors published in the proceedings of the International Federation for Information Processing world conference on "Computers and Education," Lausanne, 1981. These two papers also give references to our other related work. ■

The Group of the Turtle

Dr. Uri Leron
Computers in Education Laboratory
The School of Education
Haifa University
Haifa, Israel 31999

When observing children working with the Logo language, it is obvious that a lot of group theory goes on. This project investigates the place of group theory in Logo work from three points of view: mathematical, computational, and educational. [Editor's Note: Group theory is a branch of mathematics that deals with the study of mathematical groups. In common terms, a mathematical group is a collection of objects (such as members) and operations (such as addition) such that the result of every operation is another object in the group. The set of actions carried out by the Logo turtle form a

mathematical group, called "the group of the turtle" in this article. The article refers to a set of studies of the ways that children who learn Logo learn about the properties of mathematical groups.]

Mathematically, myself and my colleagues want to make explicit the group-theory concepts and structures that are implicit in Logo. This forms a bridge between Logo and standard mathematics and prepares the ground for the later stages. The basic object here is the turtle group, generated by the turtle operations FORWARD, BACK, RIGHT, and LEFT with all possible inputs. (Adjoining the PEN

and ERASER commands to the group raises interesting issues.) Here are, in brief, some more group-theory concepts that we have observed in the children's work (accompanied by their Logo counterparts):

- products and decompositions (paths traced by the turtle)
- inverses (opposite operation)
- the order of a group element (the number of repetitions to close a path)
- conjugacy (transparent operations and procedures)
- subgroups (limiting oneself to only a special subset of allowable inputs)

- free groups (this is where the Logo procedures live)
- homomorphism (the relation between Logo procedures and their products)

For example, the fact that the path drawn by REPEAT 5 [FORWARD 50 RIGHT 144] closes is reflected in the group by the relation $(F_{50} \times R_{144})^5 = I$ (the identity element); that is, by the fact that the group element $F_{50} \times R_{144}$ has order 5.

Computationally, we try to bring these concepts to the fore by implementing a special-purpose set of primitives to encourage explorations

in the turtle group. This is related to Seymour Papert's notion of micro-worlds. For example, the procedure FIND.ORDER takes a list of turtle commands as input, repeats this list until the path closes, and outputs the number of repetitions.

Educationally, we plan to observe children of various ages (as well as adults) working with a group-theory-speaking turtle and see to what extent informal learning of these concepts does occur.

This work may be extended in many ways. Here are two. First, different turtles give rise to different turtle groups (see diSessa's dynaturtles,

in Papert's *Mindstorms* and see page 324 in this issue), and it is interesting to explore the collection of groups that can be naturally represented as turtle groups for some turtles. Second, the method of implementing a special-purpose vocabulary may be applicable in many areas. This is probably the Logo analog of the notion of courseware development in more standard computer applications. It helps direct the explorations of the children working in Logo to specific subject-matter areas, without sacrificing the spirit of spontaneous and meaningful learning. ■

The Lamplighter Project

Henry Gorman Jr.
 Psychology Department, Box 1584
 Austin College
 Sherman, TX 75090

Typically, when researchers wish to determine the effectiveness of an educational method, they design a program, randomly assign students to either that program or a control group, administer a test instrument specifically designed to measure performance from the program, and then express surprise that the students in the control group do not perform as well as the students in the special program.

Many advocates of the use of computers in education have been among the most flagrant with such techniques. The research literature overflows with such studies where, for example, after six months of intensive drill on addition, students' addition skills improve. Perhaps such teaching to specific test questions has an appropriate place in education, but it is much more important that students learn how to think, how to solve problems, and how to learn. One of the objectives of the Lamplighter

project was to determine if Logo could be used by students to learn better thinking, problem-solving, and learning skills.

It is, of course, a simple matter to assess addition skills. By comparison, it is quite complicated to measure thinking, problem-solving, or learning skills. No one test and no single study can do more than begin to explore these skills and changes in them that result when children use Logo.

I used a test called rule learning, taken from cognitive psychology. In rule learning, students are shown a series of pictures, usually with one of several shapes shaded in one of several colors, with the size of the shapes shown either small, medium, or large (comparatively) and with either one, two, or three exact replicas of the shape present. For example, a picture might show three small, red triangles or one large, blue circle. In rule learning, students are told which features to pay attention to, e.g., a problem

might have red and circle as relevant features, and students would be told to pay attention to them. Students are then required to learn what combination of those relevant features satisfies the binary rule chosen by the experimenter. For red and circle relevant, the possible rules are conjunction (only pictures of red circles obey the rule), disjunction (pictures of any red shape and of any circle obey the rule), conditional (pictures of red circles and of all nonred shapes fit the rule "if red, then circle; if not red, then any shape"), and biconditional (pictures of red circles and of nonred, noncircular shapes fit the rule "if red, then circle; if not red, then not circle").

To solve a rule-learning task, students have to be able to symbolically manipulate the features, ignore irrelevant features, process information from current pictures, and combine that information with their memories from previous pictures. For third

SUPERBRAIN II



Intertec Data Systems' new SuperBrain II has all the features of the former SuperBrain, plus:

- Impressive Graphics capability
- Below-the-line descenders and reverse video
- Faster, enhanced disk operating system
- Battery operated real-time clock
- Microsoft Basic at no extra charge

- NEW** SUPERBRAIN II Jr. . . . \$1,895
350K Disk—64K RAM
- NEW** SUPERBRAIN II OD. . . \$2,275
700K Disk—64K RAM
- NEW** SUPERBRAIN II SD. . . \$2,655
1.5 MB Disk—64K RAM
- 10 MB HARD DISK . . . \$2,995
(Includes Interface Cable)

NEW STARGRAPH. . . \$3,890 \$ Call
Includes 350K Disk—64K RAM.
Emulates Tektronix™ 4010
Graphics Terminal,
Supports SAS-Graph and all
Tektronix Plot 10 Software

All Micro Pro™ Software
50% Off List

	List	Cost
WordStar.	\$ 495	\$ 257
MailMerge.	\$ 150	\$ 78
CalcStar.	\$ 295	\$ 153

Call for Similar Discounts on
Other Micro Lines & Printers

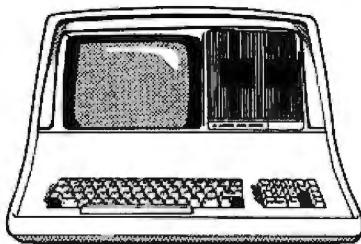

90 Day Money Back Guarantee*
120 Day Extended Warranty**

Ordering Information: Money Orders, Cashier Checks or Bank Wires Welcome. Personal or Company Checks, allow 15 days to clear. Surface Freight Standard F.O.B. Origin. Include your telephone number. No COD's, please. Prices are subject to change without notice. Order desk hours are 9 to 5 CST.

CALL OR WRITE
(214) 931-9069

WESTSTAR MICRO

16990 Dallas Parkway • Suite 151
Dallas, Texas 75248

SuperBrain is a Registered Trademark of Intertec Data Systems. Tektronix is a Registered Trademark of Tektronix. * Refunds are Pro-rated. ** Extended Warranty offered by WestStar.

The Logo Journal

graders, the conjunctive and disjunctive rules are fairly simple because the students experience forms of these rules in their everyday lives. The conditional rule is much more difficult for them, and the biconditional is harder still.

Students in the Lamplighter School third grade were randomly assigned to one of three homerooms which had two Texas Instruments computers. Five more computers were located in the shared space between the three rooms. After homeroom, students went on to classes with each of the third-grade teachers. Two of the third-grade homeroom teachers elected to ensure that each pupil received one half hour of Logo a week and the other teacher set a one-hour-a-week minimum for her students.

This difference existed from the start of the school year through the last week in April when students from all three classes were given the task of learning the conditional rule. The students from the one-hour Logo homeroom performed significantly better than the other two groups and better than even a sixth-grade level.

What is most important about these results is that the children were not taught to the test. Rather their extra Logo sessions improved a more general problem-solving skill. It would be premature to take this one study as conclusive evidence that Logo improves all thinking. The results should be taken to encourage similar studies with other measures of thinking and other groups of people. ■

Logo Research at Bank Street College

Jan Jewson and Roy D. Pea
The Center for Children and Technology
Bank Street College of Education
610 West 112 St.
New York, NY 10025

Microcomputers are being used in many schools throughout the United States in the belief that they have important educational potential for children. However, little research indicates what children learn from working with microcomputers, how they learn to work with the technology, and in what ways such skills relate to other academically relevant skills. We are particularly interested in the educational possibilities for children who learn to program microcomputers with Logo. Among the organizations funding the Center's research are the Spencer Foundation, the Xerox Foundation, and the International Paper Company Foundation.

Our research is concerned with revealing how children acquire computer programming skills and how the use of microcomputers in classrooms may relate to other cognitive and social skills. Research supported by the Spencer Foundation is being conducted in two classrooms (one of 8- and 9-year-olds and another of 11- and 12-year-olds) of the Children's School at Bank Street College of Education. The children are learning to program with Logo, and in each classroom they have access to six microcomputers. They can work alone or together as active programmers of their own projects.

We are investigating a number of specific questions concerning

children's experience with Logo. One set of studies addresses the relationship between computer programming and problem-solving skills. It has been widely assumed that computer programming experience will enhance problem-solving abilities (Papert, 1980) because of the modular character of the work and the necessity of using debugging processes. However, this assumption has never been systematically tested. Therefore, one aim of our research is to examine relationships between the degree of Logo programming expertise and problem-solving and planning skills through longitudinal studies. This will enable us to determine the impact of Logo programming skill development.

As part of this investigation of the

development of children's programming abilities, we will document the growth of knowledge about Logo as a language as well as knowledge of computers. Our work on Logo programming expertise will center on case studies of changes in children's knowledge of Logo over time in relation to the use of their knowledge to achieve project goals.

We are also investigating the social context of microcomputer use in classrooms. It has been observed in several different educational contexts that children seem to collaborate and teach each other more when they work with microcomputers. One study which we have completed indicates that children talk more to each other about problems they are

doing when they work with the microcomputers, as opposed to other classroom work. Both the occurrence and quality of the interaction when children work together are of interest to us because we believe collaborative work to be an important learning context.

In addition, we are documenting the process by which the teachers incorporate microcomputers and the use of Logo into their classrooms. This work will be useful for addressing key questions concerning the best ways of using microcomputers with children in school. The research is intended to clarify our basic understanding of planning, problem solving, and peer interaction in classrooms for this relatively new domain. ■

Young People's Logo Association

James H. Muller
Young People's Logo Association
1208 Hillside Drive
Richardson, TX 75081

And this is the way to educate children: the instinctive way of mothers. There should be no effort to teach children to think, to have ideas. Only to lift them and urge them into dynamic activity. The voice of dynamic sound, not the words of understanding. Damn understanding. Gestures and touch, and expression of face, not theory. Never have ideas about children—and never have ideas FOR them.

—Fantasia of the Unconscious and Psychoanalysis and the Unconscious
D. H. Lawrence

This quote from D. H. Lawrence is what the Young People's Logo Association is all about. But at the time of our founding, in summer 1981, no

one was thinking about Lawrence's statement. We thought we could just buy a few TI-99/4 Logo systems and let my son, Larry, and his friends enjoy having a young people's users' group and software exchange. We soon started writing a newsletter.

We also wanted disabled individuals to enjoy the fruits of the computer revolution. We were dismayed to find so little information available on computer applications for the disabled but pleased to learn of the experimental success in this field with Logo.

We soon developed into a small group of teachers, media specialists, and journalists who wanted young people and the disabled to participate fully in the world of computers. We have come to believe that Logo and turtle graphics can open this world to both groups.

At first we thought we would be corresponding with children who were already using Logo in their classes. We were surprised when our publicity generated interest from all over the world and from people using all types of computers. When I brought home an Atari 800 system, we had another surprise. The young people immediately began to ask whether Logo could run on the Atari, and whether the Atari graphics could be duplicated in Logo. We then began to look at the differences between the Atari 800 and the TI-99/4. From that point, the imagination, curiosity, and energy of the young people took over and became infectious.

Logo and the Young

When people learned about the international membership of the association, they wanted to see chapters



GOTCHA COVERED

If you're looking for computer terminal desks and work stations, CF&A has "gotcha covered". Not with just a desk or two, but with a full line of modular, integrated computer furniture. From our 24" x 26" Classic Series terminal stand to our 72" x 32" DR Series console with left or right-mounted twin RETMA enclosures...and everything in between. Like Microshelves, Datashelves, Apple or IBM desks, printer stands, media stands, turntables, returns, drawers, doors, color selections...the list goes on and on. You also get durable construction, competitive prices, quick delivery, and friendly service. Call or write for more information. We're the straight shooters. We're Computer Furniture and Accessories. We've "gotcha covered".

CF&A

**Computer Furniture and
Accessories, Inc.
515 West 132nd Street
Gardena, CA 90248
(213) 327-7710**

The Logo Journal

formed in schools around the United States and around the world. As our group grew, members wanted to learn about all kinds of computers and languages. A reporter asked why we called our organization a Logo association when it was obvious that we were doing much more. But nothing can be "much more" than Logo. A well-structured, procedural language, Logo lets young people start with what they know—their own everyday language. Logo lets you define a problem in its simplest components and then reassemble the components in a procedure for solving the problem with a computer. Using turtle graphics, people learn to "play" the computer, creating their own language through Logo. In the process, they not only gain valuable experience in problem solving and decision making, but also develop confidence and self-esteem.

Young people see the computer for what it is—a tool of the mind. Just as they don't blame the pencil for a mistake in writing, they don't blame the computer for a mistake in programming. Indeed, young people don't view their errors as mistakes but as bugs to be defined and eliminated.

Logo introduces problems to children in a way that makes them eager to learn. Children are, in Lawrence's words, lifted and urged into dynamic activity. You can see the dynamic power of Logo in the eyes of a 6-year-old as he sees *his* procedures run correctly for the first time. You can see the power in the

concentration of a hyperactive child still working over the keyboard after an hour of programming.

Logo and the Disabled

Logo can be equally powerful in the service of the physically and mentally handicapped. Personal computing is a whole new world for these people, and Logo can help them build confidence, self-reliance, and dignity. Logo creates opportunities for education, communication, productive employment, and significant contributions to society. Logo provides outlets for creativity and imagination.

The YPLA has members throughout the United States and in many other countries. Young people 18 and under can receive our newsletter, *Turtle News*, at no charge. We ask adults in North America to contribute \$25 per year to receive *Turtle News* plus the *Logo Newsletter*, which is oriented toward adults. The requested contribution for international membership is \$40. Our software exchange disks and tapes are available at \$10 each or at no charge when exchanged for a working program.

We have active local chapters in Texas and others on the way in California, Minnesota, Delaware, Pennsylvania, Florida, Virginia, and elsewhere. Local chapters will offer competitions, achievement levels, badges, T-shirts, and all the other elements necessary to give children a sense of belonging to an organization of their own. ■

Logo Update

Phil Lemmons
Consulting Editor

This report provides recent news from Logo projects and classes around the United States and Canada. Far from assessing the status of Logo in American and Canadian education, the report merely hopes to

capture something of the character and spirit of the people who are teaching Logo or guiding Logo projects. Logo projects and programs exist from coast to coast: from the Microcomputer Resource Center at

TEST-FLY A \$20 MILLION JET ON AN APPLE? YES. WITH MICROSPEED.

At the Bethesda Naval Research Center, they've discovered the power of MicroSPEED. The Navy's engineers use this remarkable hardware/software combination to "fly" an advanced fighter aircraft in *real time*—even making vertical landings on a simulated carrier deck. A "crash" is merely another learning experience, and an opportunity to modify the research aircraft—inside the Apple—to improve tomorrow's combat planes.

Surprised that such a sophisticated task is possible on the Apple? So were the Navy's officials, and many others who have discovered...

THE MICROSPEED DIFFERENCE This extraordinary Language System exploits the real potential of the microcomputer for the first time. The difference between MicroSPEED and other programming languages is that with MicroSPEED, there is virtually *no limit* to what you can achieve. It may well be the ultimate language for the Apple II and III (and soon the IBM Personal Computer). MicroSPEED literally combines the performance of a *minicomputer* with an exhaustive set of user-friendly capabilities: hard-

ware math processing, fast hi-res graphics and text, turtle graphics, print formatting, two text editors, unlimited data types, and incredible FORTH extensibility—all at speeds up to 100 times faster than Basic.

USER-FRIENDLY, EASY-TO-LEARN Starting with simple commands that are comfortable even for non-programmers, MicroSPEED extends and builds, allowing you to create your own tailored application languages. The capability of your computer will grow exponentially, as you work in an active partnership with the machine, exploring and developing new problem-solving facilities—creating, correcting, refining your increasingly powerful system.

DEMANDING JOBS AT LOW COST Developed by a team of standout computer professionals, MicroSPEED has been put to the test in fields as diverse as medicine, the stock market, oceanography, and the arts. In even the most challenging applications, MicroSPEED users have been unanimous in their praise of the System and manual. Typical comments are:

"Very high marks,"

Thomas Tosch Phd., Tosch Information Management.

"The more I use MicroSPEED, the more I love it,"

James L. Hockenhull, University of Washington.

"Great!...A joy to use,"

Henry Harris, Mission Designer, Cal Tech's Jet Propulsion Lab.

"If you plan to use the Apple or IBM Personal Computer for *any* demanding task, then we built MicroSPEED for you,"

Sam Cottrell, President of Applied Analytics.

MicroSPEED requires the Apple or IBM Personal Computer with single-disk. MicroSPEED II includes 2 MHz math processor. MicroSPEED II+ includes 4 MHz math processor.

Applied Analytics Incorporated

8910 Brookridge Drive

Upper Marlboro, Maryland 20772 (301) 627-6650

I'm interested! My computer is: _____

Please send me:

_____ MicroSPEED II, \$495.00 _____ 160 Page Manual, \$15.00

_____ MicroSPEED II+, \$645.00 _____ Detailed Information

Name: _____

Company: _____

Address: _____

MicroSPEED 
APPLE IS A TRADEMARK OF APPLE COMPUTER INC.



Teachers College at Columbia University in New York, to the Marin Computer Center in Corte Madera, California. Telephone calls to participants in many Logo activities invariably found people enthusiastic about Logo and its future. It was seldom necessary to ask questions after saying something like, "Tell me what you're doing with Logo." Explanations and anecdotes came pouring out. What follows is only a sampling.

East Aurora High School Erie County, New York

Dan Rolfler teaches in the mathematics department at East Aurora High School. Last February and March, the school offered an enrichment program called "EastOz." This program provided learning experiences for children on six Saturday mornings.

Texas Instruments lent the school six TI-99/4 computers. Forty students took part. Separate classes were held for grades 2-5 and 6-8. Children were taught problem solving and organized thinking. "You see different children solve the same problem in different ways," Rolfler says. "It's exciting to watch the kids. Logo is the best means I've seen for discovery-method learning."

While the younger children needed more class time, the children from fourth grade up "took off on their own," Rolfler reports. "What Papert suggested really does happen." Rolfler also noted the tremendous educational potential of Logo in the home.

Besides the program for students, East Aurora High School has a computer-literacy course for teachers that introduces them to both Logo and BASIC. Furthermore, the Erie County Board of Cooperative Educational Services is considering using Logo in curriculum development work.

Eastside Alternative School Eugene, Oregon

Tim Riordan teaches Logo at the Eastside Alternative School and expresses few reservations about the

language. "It's real fantastic in terms of developing analytical thinking and problem-solving skills," he says. "The graphics approach appeals to kids' interests, both girls' and boys'." Riordan also commented, "There's no limit. Kids as young as third grade can work with the idea of variables and can use recursion and develop things that are ongoing."

Riordan offered an example of the kind of abstract thought developed by children using Logo. When a math teacher described a circle as having no sides, a 10-year-old student in a Logo class remarked that a circle could be thought of as an infinity of very small sides. Logo had enabled that child to internalize the concept of the infinitesimal, so important later in calculus.

Riordan is also optimistic about Logo's surviving any imposition of curriculum standards. "I see no reason," he says, "why you couldn't put all of junior high geometry in Logo classes."

The Eastside Alternative Logo effort teaches 75 children from first to sixth grade. There is one 45-minute Logo period every day for three weeks. Some parents have taken the Logo class with their children.

Hamilton-Wenham School District Hamilton, Massachusetts

Pat Ruane, curriculum coordinator for the Hamilton-Wenham School District in Hamilton, Massachusetts, reports that the district has been experimenting with Logo for one year. As a result, it has decided to focus its Logo program beginning in the third grade in three different schools. Classes for sixth graders, junior high students, and a formal Logo programming course for adults have been set up.

One of the third-grade programs has three Apples circulating among three classrooms. The machines are in use all day, and every child has lots of time with a machine. For children in the program, using computers has already become second nature.

Some of the children first developed an interest in computers in first and second grade while using the school's Big Traks—robot-like, programmable toy vehicles. Programming more than one Big Trak, coordinating the movements in what the school calls "Big Trak Ballet," required children to plan carefully. Highlights of Big Trak Ballet include programming vehicles to mirror each other's movements or to arrive simultaneously at the same place after leaving different origins at different distances.

As for the Logo program itself, Ruane sees students receiving more benefits than just an early introduction to programming. Because they share machines, the children gain important social experience. They are grouped heterogeneously and their interaction leads to increased mutual respect.

Children also learn general thinking skills, especially how to analyze problems. Third-grade teachers say that the children who excel with Logo are not necessarily those who do well on traditional mathematics tests. This suggests that traditional measures of ability in mathematics overemphasize computation.

Logo also provides benefits for teachers. According to Ruane, there is "a different relationship between teacher and learner. Teachers ask, 'Can I still engage as a learner?' This changes teachers' views of teaching. Logo has opened up the whole question of how mathematics should be taught."

As for other educational software now on the market, Ruane says, "I would as soon throw out all our other software and just use Logo."

Falk School Pittsburgh University Pittsburgh, Pennsylvania

Sharon Lesgold is curriculum developer for a Logo demonstration class in the Falk School, a laboratory school at Pittsburgh University. The program has 49 children aged 5 to 8 using Terrapin Logo for the Apple.

The children, some from the Pittsburgh urban area and some the children of faculty, share a total of three machines in a connected suite of several large rooms.

Lesgold describes the Pittsburgh program as "very developmental. Not much real programming yet. The children are mostly drawing pictures." Each child has use of a computer for 30 minutes a week.

Lesgold has altered the Logo commands somewhat, notably making turtle steps 10 times as big as usual. Also, instead of describing a movement in degrees, the children use directional terms—north for the top of the screen, south for the bottom, etc. The children find these terms easier to use, partly because the directional references in the Logo course are consistent with the children's parallel introduction to map skills. Lesgold comments, "The kids understand the power of Logo and how to use it."

A summer day camp is planned for children from first to sixth grade, with the majority in the fourth and fifth grades. The camp will offer 4 computers for a class of 20 children, with 1 teacher and 1 aide. Lesgold hopes that the increased computer time will make it possible for children to learn to write procedures. The summer instruction will be more structured than that given during the school year. Children will have more definite tasks to do.

**The Young People's Logo Association
Richardson, Texas**

Jim Muller of the YPLA reports that the group is developing a version of Apple Logo that incorporates a single-keystroke language for the physically disabled. (See page 333 for a report by Muller on YPLA.) The enhanced Logo will present a menu of words and phrases and convenient means to construct sentences from them and print the results. Toggle switches and gravity switches will replace standard keys and make using the computer easier.

FREE
with software purchase—
One CPM Handbook

FREE WITH EVERY WORDSTAR—MICROPRO WORDSTAR TRAINING GUIDE

DISCOUNT SOFTWARE

Ad#27

ULTIMATE SOFTWARE PLAN

We'll match any advertised price on any item that we carry. And if you find a lower price on what you bought within 30 days of buying it, just show us the ad and we'll refund the difference. It's that simple.

Combine our price protection with the availability of full professional support and our automatic update service and you have the Ultimate Software Plan. It's a convenient, uncomplicated, logical way to get your software.

✓ (New items or new prices)
CP/M users: specify disk systems and formats. Most formats available.

<p>CP/M</p> <p>ARTIFICIAL INTELLIGENCE* Medical(PAS-3)... \$849/\$40 Dental (PAS-3)... \$849/\$40</p> <p>ASYST DESIGN*/FRONTIER Prof Time Accounting... \$549/\$40 General Subroutine... \$269/\$40 Application Utilities... \$439/\$40</p> <p>COMPUTER PATHWAYS* Pearl (level 1)... \$ 99/\$25 Pearl (level 2)... \$299/\$40 Pearl (level 3)... \$ 90/\$15</p> <p>DIGITAL RESEARCH* CP/M 2.2 NorthStar... \$149/\$25 TRS-80 Model II (P + T)... \$159/\$35 Micropolis... \$169/\$25 PL/I-80... \$459/\$35 BT-80... \$179/\$30 Mac... \$ 85/\$15 Sid... \$ 65/\$15 Z Sid... \$ 90/\$15 Tex... \$ 50/\$10 DeSpool... \$459/\$35 CB-80... \$ 99/\$20</p> <p>FOX & GELLER ✓ Quickscreen... \$135/\$na ✓ Quickcode... \$285/\$na ✓ dutil... \$ 65/\$na</p> <p>GRAHAM-DORIAN* General Ledger... \$ 729/\$40 Acct Receivable... \$ 729/\$40 Acct Payable... \$ 729/\$40 Job Costing... \$ 729/\$40 Payroll II... \$ 729/\$40 Inventory II... \$ 729/\$40 Payroll... \$493/\$40 Inventory... \$493/\$40 Cash Register... \$493/\$40 Apartment Mgt... \$493/\$40</p> <p>MICRO-AP* S-Basic... \$269/\$25 Selector IV... \$295/\$35 Selector V... \$495/\$50</p> <p>MICRO DATA BASE SYSTEMS* HDBS... \$269/\$35 MDBS... \$ 795/\$40 DRS or QRS or RTL... \$269/\$10 MDBS PKG... \$1295/\$60</p> <p>MICROPRO* WordStar... \$319/\$60 Customization Notes... \$429/\$na Mail-Merge... \$109/\$25 WordStar/Mail-Merge... \$419/\$85 DataStar... \$249/\$60 WordMaster... \$119/\$40 SuperSort I... \$199/\$40 Spell Star... \$175/\$40 CalcStar... \$259/\$na</p> <p>MICROSOFT* Basic-80... \$ 298 Basic Compiler... \$329 Fortran-80... \$349 Cobol-80... \$629 M-Sort... \$175 Macro-80... \$144 Edit-80... \$ 84 MuSimp/MuMath... \$224 MuLisp-80... \$174 Multi Plan... Call Manager Series... Call</p> <p>ORGANIC SOFTWARE* TextWriter III... \$111/\$25 DateBook II... \$269/\$25 Milestone... \$269/\$30</p> <p>OSBORNE* General Ledger... \$ 59/\$20 Acct Rec/Acct Pay... \$ 59/\$20</p>	<p>Payroll w/Cost... \$ 59/\$20 All 3... \$129/\$60 All 3 + CBASIC-2... \$199/\$75 Enhanced Osborne... \$269/\$60</p> <p>PEACHTREE* General Ledger... \$399/\$40 Acct Receivable... \$399/\$40 Acct Payable... \$399/\$40 Payroll... \$399/\$40 Inventory... \$399/\$40 Surveyor... \$399/\$40 Property Mgt... \$799/\$40 CPA Client Write-up... \$799/\$40 P5 Version... Add \$129 MagCalc... \$269/\$25 ✓ "Peach Pak" Series 4... \$1195/\$na Other... less 10%</p> <p>STAR COMPUTER SYSTEMS G/L, A/R, A/P, Pay... \$ 359 All 4... \$1129 Legal Time & Billing... \$ 849 Property Mngmt... \$ 849</p> <p>STRUCTURED SYSTEMS* Business Packages, Call for Price</p> <p>SORCIM* SuperCalc... \$269/\$na Trans 86... \$115 Act... \$157</p> <p>SUPERSOFT* ✓ Ada... \$224/\$na Diagnostic I... \$ 49/\$20 Diagnostic II... \$ 84/\$20 Disk Doctor... \$ 84/\$20 Forth (8080 or Z80)... \$149/\$30 Fortran... \$219/\$30 Fortran w/Ratfor... \$289/\$35 C Compiler... \$174/\$20 Star Edit... \$189/\$30 ✓ Scratch pad... \$174/\$15 ✓ Statsgraph... \$174/\$15 ✓ Dataview... \$174/\$20 Other... less 10%</p> <p>SYSTEMS PLUS ✓ 1 Module... \$425/\$na ✓ 4 Modules... \$1395/\$na ✓ All 8... \$3400/\$na</p> <p>TCS* GL or AR or A/P or Pay... \$ 79/\$25 All 4... \$269/\$99 Compiled each... \$ 99/\$25 Inventory... \$ 99/\$25</p> <p>UNICORN* Mince... \$149/\$25 Scribble... \$149/\$25 Both... \$249/\$50</p> <p>WHITESMITHS* "C" Compiler... \$600/\$30 Pascal (incl "C")... \$850/\$45</p> <p>"PASCAL" Pascal/MT + Pkg... \$429/\$30 Compiler... \$315 Sp Prog... \$175 Pascal/Z... \$349/\$30 Pascal/UCSD 4.0... \$670/\$50 Pascal/M... \$355/\$20</p> <p>"DATA BASE" FMS-80... \$649/\$45 dBASE II... \$595/\$50 Condor II... \$899/\$50</p> <p>"WORD PROCESSING" WordSearch... \$179/\$50 SpellGuard... \$229/\$25 VTS/80... \$259/\$65 Magic Wand... \$289/\$45 Magic Spell... \$269/\$25 Spell Binder... \$349/\$45 Select... \$495/\$na</p>	<p>The Word... \$ 65/\$na ✓ The Word Plus... \$145/\$na ✓ Palantier-I (WP)... \$385/\$na</p> <p>"COMMUNICATIONS" ✓ Ascorn... \$149/\$15 ✓ BSTAM... \$149/\$na ✓ BSTMS... \$149/\$na ✓ Crosstalk... \$139/\$na ✓ Move-it... \$ 89/\$na</p> <p>"OTHER GOODIES" Micro Plan... \$419/\$na Plan 80... \$269/\$30 Target... \$189/\$30 Tiny "C"... \$ 89/\$50 Tiny "C" Compiler... \$229/\$50 Nevada Cobol... \$179/\$25 MicroStat... \$224/\$25 Vedit... \$130/\$15 MiniModel... \$449/\$50 StatPak... \$449/\$40 Micro B+... \$229/\$20 Raid... \$224/\$35 String/80... \$ 84/\$20 String/80 (source)... \$279/\$na ISIS CP/M Utility... \$199/\$50 Lynx... \$199/\$20 Supervyz... \$ 95/\$na CP/M Power... \$ 75/\$na Mathe Magic... \$ 95/\$na ✓ CIS COBOL... \$765/\$na ✓ ZIP... \$129/\$12</p> <p>APPLE II®</p> <p>INFO UNLIMITED* EasyWriter (Prof)... \$159 Datedex... \$129 EasyMailier (Prof)... \$129 Other... less 15%</p> <p>MICROSOFT* Softcard (Z-80 CP/M)... \$298 Fortran... \$179 Cobol... \$499 Tasc... \$139</p> <p>MICROPRO* Wordstar... \$269 MailMerge... \$ 99 Wordstar/MailMerge... \$349 SuperSort I... \$159 Spellstar... \$129</p> <p>PERSONAL SOFTWARE/VISICORP* Visicalc 3.3... \$199 Desktop/Plan II... \$199 Visiterm... \$ 90 Visidex... \$199 Visiplot... \$180 Visitrend/Visiplot... \$259 Visifile... \$169 ✓ Visischedule... \$259</p> <p>PEACHTREE* G/L, A/R, A/P, Pay or Inventory (each)... \$224/\$40 ✓ Peach Pak... \$795 ✓ Systems Plus Accounting Plus II, G/L, AR, AP, or Inventory (each)... \$385/\$na (Needs G/L to run)</p> <p>"OTHER GOODIES" Micro Courier... \$219 Super-Text II... \$127 Data Factory... \$134 DB Master... \$184</p> <p>16-BIT SOFTWARE</p> <p>8086 SOFTWARE ✓ Supercalc... \$269 ✓ Wordstar (ISMPCL)... \$289/\$na Call for others</p>
--	---	--

CALL TOLL FREE VISA • MASTERCARD

U.S. 1-800-421-4003 • CALIF. 1-800-252-4092 • LOS ANGELES 1-213-837-5141

Outside Continental U.S.—add \$10 plus Air Parcel Post + Add \$3.50 postage and handling per each item + California residents add 6% sales tax + Allow 2 weeks on checks. C.O.D. \$3.00 extra + Prices subject to change without notice. All items subject to availability + ® —Mfgs. Trademark. Blue Label \$3.00 additional per item.

THE DISCOUNT SOFTWARE GROUP
6520 Selma Ave. Suite 309 • Los Angeles, Ca. 90028 • (213) 837-5141
Int'l TELEX 499-0446 DISCSOFT LSA • USA TELEX 194-634 (Attn: 499-0446)
TWX 910-321-3597 (Attn: 499-0446)

The Logo Journal

Jack Kishpaugh, who finished near the top in the Johns Hopkins competition for computer applications for the handicapped, is using Logo to develop a utility disk for the severely disabled. Kishpaugh, himself disabled, is trying to reduce the number of key-strokes required for successful communication from the usual range of 200-300 to only 20-25.

The YPLA is also beginning to investigate the use of voice input and is seeking ways to interface voice-recognition systems with the Logo language.

As for instruction in Logo, the YPLA tries to help elementary school children learn fundamental programming concepts like interrelationships among blocks of data. Muller notes that "Logo also helps children develop good social relationships." At least two children work on each project, and as a result, children get a greater sense of accomplishment on

completing a project.

Muller expects tremendous growth in the exploitation of Logo's powerful list-processing capabilities. The most obvious application is in the language arts. Logo's features make it relatively easy to develop word games and language exercises. He also believes that the use of Logo will expand in many other directions.

Austin College Sherman, Texas

Dr. Henry Gorman, whose report on the Lamplighter Project appears on page 331 of this issue, uses Logo in his Principles of Learning class at Austin College. The class has four TI-99/4s that are used most of the day for Logo. Each of the 40 college psychology students uses Logo in working with 1 student between the ages of 7 and 14. Thirty-nine of the college students were enthusiastic about Logo.

Celeste Alexander, one of Dr. Gorman's college psychology students, describes her experience with a young Logo pupil this way: "After the first day we worked nearly exclusively with sprites. He liked everything to be put into a program." Of her own reaction to Logo and to learning to use a computer, Alexander says, "I found my first apprehensions dissolved and I realized I could not only run or manage this computer, but also understand what I was doing."

Janet Truska, another of Dr. Gorman's students, also had good results to report. "I was concerned as to whether my student would enjoy it or not," she says. "After we worked with it a while, he began to enjoy it, as did I, and we both found it to be a very rewarding learning experience."

This summer, Austin College is offering a continuing education course in Logo. Students range from the second grade to the twelfth, divided into

DATAFACE D101: APPLE II™ IN ONE

URNS YOUR OLYMPIA ES101 OR REMINGTON 210 TYPEWRITER INTO A LETTER QUALITY PRINTER FOR THE APPLE II COMPUTER



The Dataface D101 Apple II™ Interface Card gives you a letter quality printer while allowing the full use of your office electronic typewriter. The D101 requires only one card, the cable is included. Installation—simply plug in! No jumpers to set and no soldering necessary.

Suggested retail price \$349.50.
Dealer Inquiries Invited.

*Apple II is a trademark of Apple Computers, Inc.

FOR OTHER COMPUTERS USE THE GRQ-11
Interfaces to the Olympia ES100, ES101, ES105 and Remington 210, 220 electronic typewriter.

DATAFACE INC.

2372 A WALSH AVENUE, SANTA CLARA, CA 95050
TELEPHONE (408) 727-6704

The Logo Journal

four classes with a three-year age span. The college may offer a Logo course for parents at night this fall.

Ponderosa Elementary School Cherry Creek School District Aurora, Colorado

Jim Wilborn, who is active in the Logo program at Ponderosa Elementary School, says that the school is now using seven TI-99/4s with Logo. Since October 1981, pairs of children have had access to TI-99/4s, with each session lasting 15 minutes. The students show enthusiasm for Logo, battling for additional time at the Logo keyboard, but also sharing ideas. The students are developing improved skills in general problem solving, logical-sequential organization, and spelling. Many of the children who are doing well are "surprises." More than 25 teachers are cooperating in the program and working hard with the computers.

This summer the Cherry Creek School District is offering a Logo program for gifted and talented students. Each student sometimes faces specific challenges, such as making a sprite carry his or her initials across the video screen.

Lexington Public Schools Lexington, Massachusetts

Beth Lowd of the resource center at Lexington Public Schools serves as a consultant to teachers using Logo. She reports that the use of Logo in Lexington is not a separate program in itself. Several teachers have begun to use computers with children of different ages. One sixth-grade classroom has had a Logo computer all year, as has one fourth-grade teacher.

The Lexington Schools see Logo primarily as part of the computer-literacy curriculum. Lowd describes Logo as both "a wonderful first programming experience" and "a very good tool for the child who hasn't been able to succeed in some areas."

While Logo is taught as a programming language, the children are also allowed to explore. Teachers use a checklist in connection with teaching

Logo, but generally children learn a new feature of the language when they need that feature to achieve a desired effect. Children also trade a great deal of information. Part of the driving force in the sharing sessions is the children's desire to show their peers what they can do.

Next fall, the schools hope to have all fifth graders using Logo. If plans work out, the Lexington schools will provide each child eight whole-class lessons on Logo, with more than one hour a week using the computer. One Apple will be available for every two or three classes.

Driscoll School Brookline, Massachusetts

Driscoll School is training all fourth and fifth graders in the use of Logo. The training emphasizes programming and uses Apples and Terapin Logo. Pairs of students get a half hour each week of computer time and use the computers all year long.

Joyce Tobias of Driscoll School reports that Logo instruction in the fourth and fifth grades has been successful enough to warrant writing a curriculum for the fifth and sixth grades to continue Logo classes. Each student in the existing Logo classes must achieve specific goals, first achieving each goal with help and later doing it alone. Boys and girls are showing equal interest in Logo.

Some children have passed graphics and gone into full-scale programming. Tobias reports that "one student is writing a Logo program that tutors other students in the use of Logo." Another boy is writing simulations, including one program that simulates taking a trip across the United States.

Queen's University Kingston, Ontario

Dr. William Higginson of Queen's University in Kingston, Ontario, says that about 15 schools in eastern Ontario are using Logo (see page 328). Interest in Logo is running high. The Educational Computing Organization of Ontario gave a conference in May

Best Prices!

**hp HEWLETT
PACKARD**
HP-85
or
HP-125
CP/M based.
\$1979
Your Choice



NEW HP-87... \$1889

5 1/4" DUAL MASTER DISK DRIVE	\$1595
HP-7470 PLOTTER	\$1245
5 MEG. WINCHESTER HARD DISK	\$3599
5 MEG. WIN. w/5 1/4" DD, SD FLOPPY	\$4399

APPLE II PLUS 48K	CALL
APPLE III 128K	CALL
NEC PC8001A 32K	\$749
NEC PC8031 DUAL DISK	\$749
SHARP PC1500 POCKET COMPUTER	\$225
SHARP CE150 FOUR COLOR PRINTER	\$185
SMITH-CORONA DAISY-WHL. PRINTR.	\$695

TI CALCULATORS—TI-55 II	\$36
TIP BUSINESS ANALYSIS II	\$36
TIP-58C	\$79
TIP-59	\$169
TIP-100C	\$149

HP-41CV \$237 HP-41C \$189

w/Five times more memory List. \$325

HP-41CV PRINTER	\$289
HP-41CV OPTICAL WAND	\$99
HP-41CV CARD READER	\$165
HP-821060A HP-IL MODULE	\$99
HP-82161A DIGITAL CASSETTE DRIVE	\$419
HP-82162A IL PRINTER	\$375
HP-41C/CV EXT. FUNC. MEM. MOD.	\$62.75
HP-41C/CV EXTENDED MEM. MOD.	\$62.75
HP TIME MODULE	\$62.75
HP-11C	\$105
HP-12C	\$115

ATARI® 800 \$659



ATARI
NEW LOW PRICE

ATARI 400 \$298

ATARI 16K MEMORY MODULE	\$75.00
ATARI 823 80 COL. IMPACT PRNTR.	\$565
ATARI 410 PROGRAM. RECORDER	\$79
ATARI 810 DISK DRIVE	\$419

—APPLE OWNERS

APPLE II CP/M® Conversion Special
Included MicroSoft Softcard, (a board with Z-80, with MicroSoft BASIC and CP/M® included). MicroSoft's buffered 16K RAM board, the VIDEX VIDEOTERM 80 Column board, with a soft video switch and inverse video.

All for only, **\$599.** (Limited time only)

**Lowest prices on CCS & SSM
APPLE Interface Boards!**

**Special prices on VisiCalc®
and other VisiCorp Software**
(Formerly Personal Software)

Personal Computer Systems (315) 478-6800
All prices are subject to change without notice.
P.O. Box 1033
Syracuse, N.Y. 13201
Prices do not include shipping

that drew 1400 participants. The program included 14 sessions on Logo.

Queen's University now offers a continuing education course to introduce school teachers to Logo. Classes meet one night a week for seven weeks. The university is also developing a diploma program in educational computing. "Logo would probably be

a significant part of that program," Dr. Higginson says.

**Microcomputer Resource Center
Teachers College
Columbia University
New York, New York**

Ursula Wolz reports that Teachers

College is training teachers in Logo. Training in the field is taking place in New Jersey, New York's Westchester County, and New York City.

Also a month-long Logo course at Teachers College provides a two-week introduction to the programming language followed by a two-week practicum with an experienced teacher of Logo.

While Wolz believes that the use of Logo is an important part of education, she stresses that in order to be successful, teachers must have a good understanding of the developmental education concepts behind Logo. She believes it is equally important for teachers to have a strong working knowledge of Logo, noting that "teaching children Logo without really knowing Logo yourself would be like trying to teach Shakespeare without having read the plays."

The Teachers College Microcomputer Resource Center and the Department of Communications and Computing together offer an internship program for teachers. Teachers College also has Logo classes at its Center for the Gifted (classes are not restricted to the gifted). Wolz says one of the most exciting things about working with Logo is "seeing kids in their third or fourth session who have gone significantly beyond rudimentary Logo." She also enjoys seeing children sharing information and "working problems through as a group." Teachers College uses both TI-99/4s and Apples in teaching Logo.

A Final Note

Most of the people interviewed for this report did have one complaint about current Logo classes and projects: a shortage of machines and machine time for children. Under the circumstances, it is remarkable that so many early users and teachers are so enthusiastic about Logo. When we look back a few years from now, we will probably wonder how the pioneers in this field did so much with so little. ■

*This advertisement is neither an offer to sell nor a solicitation of offers to buy these securities.
The offer is made only by the Prospectus.*

June 4, 1982

625,000 SHARES BPI SYSTEMS, INC.

COMMON STOCK
(\$0.01 Par Value)

PRICE \$12 PER SHARE

*Copies of the Prospectus may be obtained in any State only from each of the
several Underwriters as may lawfully offer these securities in such State.*

Wertheim & Co., Inc.

Bache Halsey Stuart Shields <small>Incorporated</small>	Bear, Stearns & Co.	Blyth Eastman Paine Webber <small>Incorporated</small>
Dillon, Read & Co. Inc.	Donaldson, Lufkin & Jenrette <small>Securities Corporation</small>	Drexel Burnham Lambert <small>Incorporated</small>
Goldman, Sachs & Co.	Kidder, Peabody & Co. <small>Incorporated</small>	Lazard Frères & Co.
Lehman Brothers Kuhn Loeb <small>Incorporated</small>		L. F. Rothschild, Unterberg, Towbin
Shearson/American Express Inc.		Smith Barney, Harris Upham & Co. <small>Incorporated</small>
Warburg Paribas Becker <small>A. G. Becker</small>		Dean Witter Reynolds Inc.
Alex. Brown & Sons	F. Eberstadt & Co., Inc.	A. G. Edwards & Sons, Inc.
Hambrecht & Quist		Ladenburg, Thalmann & Co. Inc.
Moseley, Hallgarten, Estabrook & Weeden Inc.		Oppenheimer & Co., Inc.
Rothschild Inc.	Thomson McKinnon Securities Inc.	Tucker, Anthony & R. L. Day, Inc.

For serious business microcomputing, only one operating system exactly fits.

Whether you're in business and do microcomputing, or in computing and sell to business, you'll like OASIS.* Not a hobby or scientific system warmed-over for business use, OASIS is the only operating system designed from the ground up for business.

SERIOUS BUSINESS COMES IN ALL SIZES.

Whatever your business need, OASIS has the operating system to match: 8-bit or 16-, single-user or the multi-user system that professionals tell us makes micros run like minis. And that's even truer now with new OASIS-16.** (OASIS exact business fit #1: choice.)

ANY SYSTEM IS ONLY AS GOOD AS THE

PROGRAMS IT RUNS.

The acid test for any business operating system is the application software available to run on it. There's plenty for OASIS—for nearly any job.

And it's top quality, too, because our integrated tools are top quality—and there are more of them. Like a high-level BASIC Interpreter/Compiler/Editor/Debugger; ISAM/Keyed/Direct/Sequential Files; a smart Print Spooler; Automatic Record Locking (OASIS exclusives!); plus COBOL & 'C' Languages. These tools are mandatory for high-quality business application program development—ask any developer. (OASIS exact business fit #2: high-quality application software.)

OASIS is custom-fitted to manufacturers' hardware so application software developed to run on one OASIS equipped machine can also run on others—and is upwardly compatible from 8-bit OASIS Single-User to Multi-User, on up to OASIS-16. This kind of ap.....y is exclusive

Device independence allows various printers and terminals to be used—with no modification to application

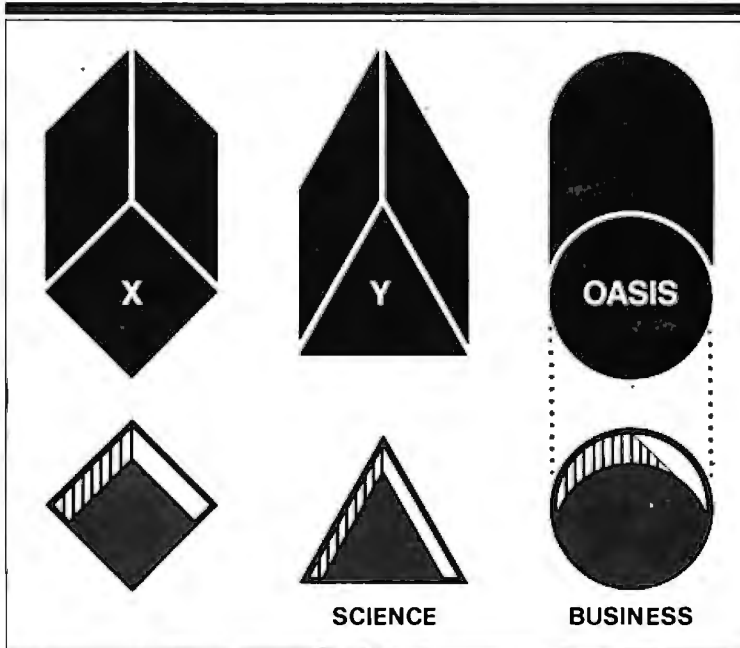

available, type 'HELP' and the command function title—OASIS displays the syntax and options available.

And it's all in your language—not computerese. (OASIS exact business fit #5: user-friendliness.)

AND, AND, AND...

Some of the best, most extensive documentation in the industry; a packed Application Software Directory; multi-level training; direct telephone support; worldwide sales & service; options like CONTROL Relational Data Base Management System and MASTERPLAN Financial Modeling Package; OASIS has it all. (OASIS exact business fits #6 through #12.)

Now you know why there's no reason to struggle trying to put a square peg in a round hole. For serious business microcomputing,

there is one operating system that exactly fits: OASIS. Call or write us today for details.

* For Z80.

** For 8086, 68000, Z8000, LSI-11, & others.

software: OASIS system software compensates for differences. (OASIS exact business fit #3: portability.)

ACCURATE DATA & A SECURE SYSTEM REDUCE BUSINESS RISKS.

Data integrity—a challenge for any multi-user system—is insured by OASIS File & Automatic Record Locking. With it, normally all users can view a record at the same time. BUT, if the record is being updated by one user, other users are automatically denied access until the update is complete. That means data is always accurate and up-to-date. And it's still another OASIS exclusive.

For system security, there's OASIS Logon, Password & Privilege Level. User Accounting keeps track of who used the system, when. (OASIS exact business fit #4: data integrity/system security.)

A FRIENDLY SYSTEM IS GOOD BUSINESS.

For user-friendliness, OASIS sets new standards. Example: the EXEC Job Control Language is so smart it walks users through their applications—and around the operating system.

With our 'HELP' feature, if you are unsure of the functions and options

OASIS

■ STRICTLY BUSINESS -

PHASE ONE SYSTEMS, INC.

7700 Edgewater Drive, Suite 830
Oakland, CA 94621-3051
Telephone 415/562-8085 TWX 910-366-7139

I'm serious about my business—please send me:

- OASIS-16 Manual, \$75
- OASIS Manual, \$60
- Free Application Software Directory and put me on your mailing list.

(Add \$3 for shipping. California residents add sales tax.)

Name _____

St. (No Box #) _____

City _____ State _____ Zip _____

Check enclosed UPS C.O.D.

VISA Mastercharge

Card No. _____ Exp. date _____

Signature _____

Semidisk, Software Tools, the BDOS Blues, Power, and LISPs

A veteran computer user voices his opinions.

Jerry Pournelle
c/o BYTE Publications
POB 372
Hancock, NH 03449

First we had M-Drive, or Warp Drive, the Godbout/G & G Engineering system that tricks your 8085/8088 into thinking memory is a disk. Now we have Semidisk, which does the same thing and will work with any CP/M 2.2 system; unlike Godbout's M-Drive, Semidisk doesn't require a DMA (direct memory access) disk controller.

Semidisk comes in big chunks—512K bytes is standard, with a full megabyte on special order—and works with the S-100 bus. The firm says it'll have Semidisk available for the TRS-80 Model II and the IBM Personal Computer. I know Semidisk works with an S-100, either 8085 or Z80, because we have it running. We got it only yesterday; full report next month. So far it works fine and is comparable in speed to M-Drive. If you do a lot of programming with

long compilations and assemblies, once you try either Semidisk or M-Drive you'll wonder how you ever lived without it.

Software Tools is one of those books you can't do without if you're serious about learning to program.

Software Tools

Not too long after Ezekial, my friend who happens to be a Z80 computer, came to live here at Chaos Manor, my (alas, late) mad friend Mac Lean brought me a book: *Software Tools* by Brian W. Kernighan and P. J. Plauger. Those were the days when I insisted I was monumentally uninterested in learning to be a

programmer. "I only want to *use* the machines," I insisted. "I don't care how programs work."

"You'll want to learn," Mac Lean said. "So here's a painless way to get started. Read it. Hell, you know one of the authors."

It happened that I already admired Bill Plauger's work as a science fiction writer. Even so, I was reluctant to get started. Wisely, Mac Lean insisted—one of the many great favors he did for me and one of the countless reasons I'll continue to miss him for a long time.

(My wife says not to worry: sure as anything, some night I'll fall asleep at the keyboard, and in the morning, there'll be a disk file with a long diatribe on some totally unexpected subject, complete with telltale mad similes and the like. I can hardly wait.)

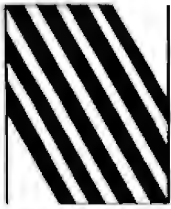

NEECO



Commodore Computer

VIC 20 Personal Computer	\$ 299.95
VIC 1515 Graphic Printer	\$ 395.00
CBM 4016	\$ 995.00
CBM 4032	\$1295.00
CBM 8032	\$1495.00
CBM SuperPet 9000	\$1995.00
CBM 8050 Dual Disk Drive	\$1795.00
CBM 4040 Dual Disk Drive	\$1295.00
CBM 2031 Single Disk Drive	\$ 695.00
CBM 4022 Tractor Printer	\$ 795.00
CBM 8010 IEEE Modem	\$ 279.00
CBM Datasette	\$ 74.95
CBM-IEEE Interface Cable	\$ 39.95
IEEE-IEEE Interface Cable	\$ 49.95



Professional Software for CBM Computers

WordPro™ — a Family of CBM Word Processing Programs

WordPro 2 Plus	\$ 199.95
WordPro 3 Plus	\$ 295.00
WordPro 4 Plus	\$ 450.00
WordPro 5 Plus (for CBM 8096)	\$ 450.00
The Administrator (Data Base for CBM)	\$ 650.00
Power™ (Programmer's Utility ROM)	\$ 89.95
InfoPro™ (Data Base for CBM)	\$ 295.00



Atari

Atari 400 16K	\$ 399.00
Atari 800 16K (incl. BASIC cartridge)	\$ 899.00
Atari 410 Recorder	\$ 99.95
Atari 810 Disk Drive	\$ 599.95
Atari 822 Thermal Printer	\$ 299.95

Amdak Monitors

Video 100G	\$ 179.00
Video 300G	\$ 200.00
Color 1	\$ 449.00
Color 2	\$ 999.00

CMD Mupet

MC-800A Mupet Controller	\$ 995.00
(Multi-User Controller for CBM Computers)	
CM-100 Channel Module Printer Module	\$ 350.00

Qume

Sprint 9/45	\$2495.00
Tractor Option	\$ 210.00

Epson Printers

MX-70	\$ 299.95
MX-80 w/Graphtrax	\$ 645.00
MX-80 FT	\$ 745.00
MX-100 FT	\$ 945.00
INTERFACE CARDS	
8141 RS-232 Interface Board	\$ 75.00
8145 RS-232 Interface Board w/2K Buffer	\$ 149.00
8151 RS-232 Interface Board w/X/ON-X/OFF	\$ 170.00
8161 IEEE Interface Board	\$ 55.00
8131 Apple Interface Card	\$ 85.00
8232 Apple Interface Cable	\$ 35.00
8220 TRS-80 Cable	\$ 35.00

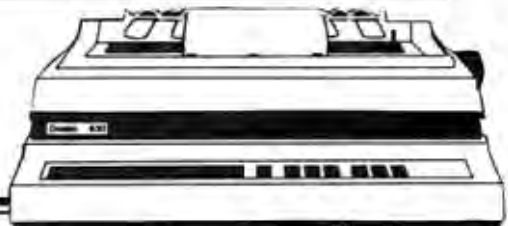

Diablo 630 Printer

Diablo 630	\$2710.00
Tractor Option	\$ 350.00

NEC Spinwriter Printer

NEC 7730	\$3085.00
NEC 7710	\$3085.00
NEC 7720	\$3610.00
NEC 3510	\$2290.00
NEC 3500RD	\$1895.00
Tractor Feed Options are available	

*WordPro, POWER, & InfoPro are registered trademarks of Professional Software Inc.

CALL FOR OUR 70 PAGE CATALOG FOR COMPLETE PRODUCT LINE AND PRICE LISTINGS.

WE WILL MATCH SOME ADVERTISED PRICES ON CERTAIN PRODUCTS LISTED UNDER SIMILAR "IN STOCK" CONDITIONS.



NEECO

679 Highland Ave.
Needham, MA 02194

(617) 449-1760
TELEX: 951021

MON-FRI 9:00 - 5:30 E.S.T.



MASTERCARD *UISA

Software Tools is one of those books you can't do without if you're serious about learning to program. As Kernighan and Plauger say many times, you learn to write good programs by reading and studying good programs; and they show you a book full of them. The original edition of the book presents RATFOR (rational FORTRAN), an attempt to make a good language out of FORTRAN by adding conditional statements such as UNTIL, WHILE, CASE, and other requirements of structured programs. Way back in the book, they also give you a RATFOR precompiler that takes programs using the RATFOR

conventions and turns them into reasonable FORTRAN.

The book is full of illustrative programs, and most of them are quite useful. The programs fit together into a set of "software tools," mostly for text processing, but also include a macro instruction expander and other items useful for programmers. Kernighan and Plauger's text editor is a bit out of date, but there's a lot in there that I thirsted for the instant I began to read the book.

There's a problem, though. Although I learned a bit about FORTRAN in the old days (1960s) and have Microsoft FORTRAN for my

Z80, FORTRAN isn't really a very good language for microcomputers. Its string-handling capabilities are ghastly. There's no BEGIN. . .END construct to let you do several things following IF. . .THEN. The dreaded FORMAT statement doesn't make sense for today's input/output (I/O), and FORTRAN was really designed to work with 80-column lines, preferably from cards (so was Pascal; more on that later). The structure of FORTRAN, even with RATFOR, doesn't really encourage writing readable programs. It seemed to me that FORTRAN was a language whose time had passed, and I wasn't willing to in-

Farewell to the Florida panther.

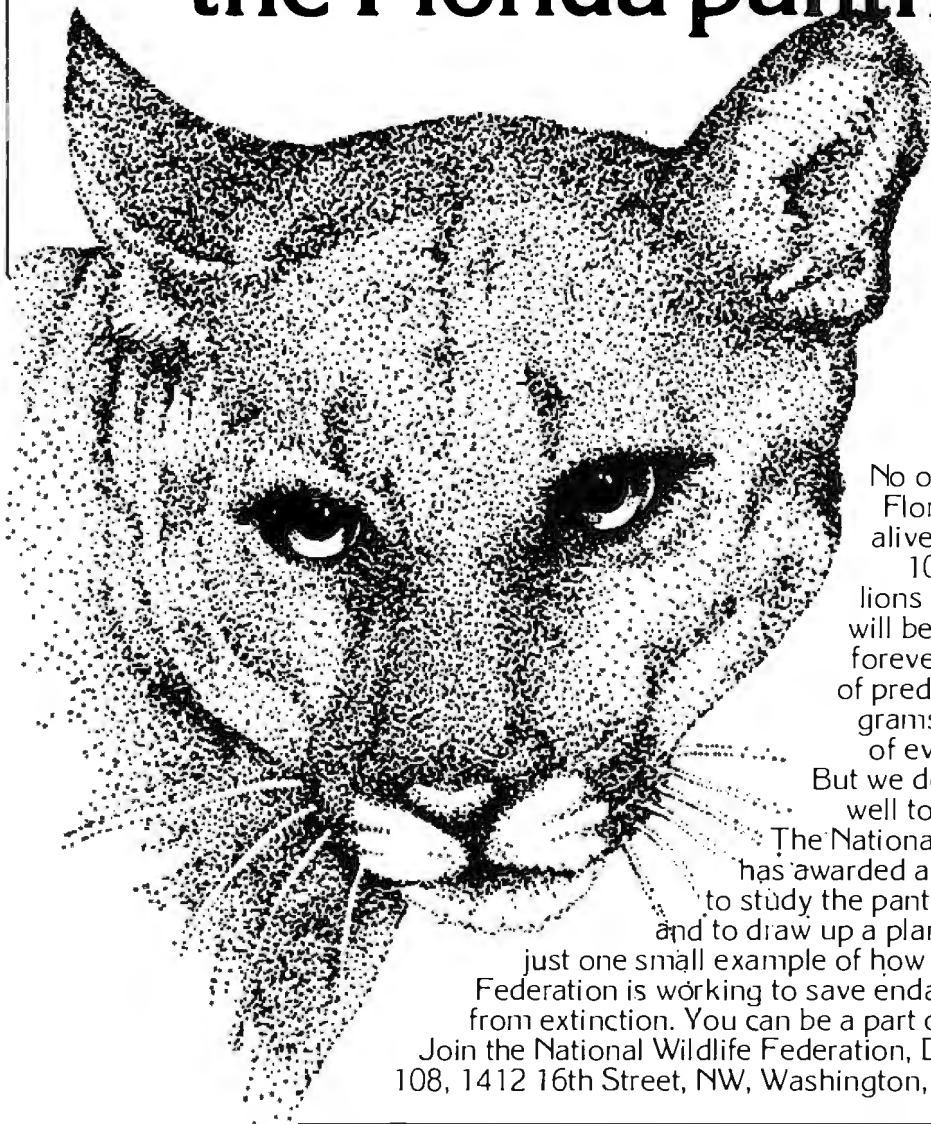

No one knows how many Florida panthers are still alive. Perhaps fewer than 100. If these mountain lions die, another creature will be gone from the earth forever . . . the victim, first, of predator elimination programs, and more recently, of ever-shrinking habitat.

But we don't have to bid farewell to the Florida panther.

The National Wildlife Federation has awarded a grant to researchers to study the panther and its future . . . and to draw up a plan for saving it. That's

just one small example of how the National Wildlife Federation is working to save endangered species from extinction. You can be a part of the effort.

Join the National Wildlife Federation, Department 108, 1412 16th Street, NW, Washington, DC 20036.



SPECIAL SALE!!

**MOST ECONOMICAL SOURCE TO BUY FLOPPY DRIVES — FROM ONE OF THE LARGEST DEALERS IN THE WORLD! NOW YOU CAN BUY TANDON, QUME, TEAC, SHUGART, MPI, SIEMENS, REMEX, YANKEE, APPLE, EPSON, DEC, CDC, CIPHER, NEC, TALLY, ALTOS, ATARI, DATAPRODUCTS, IBM AND MORE . . .
 . . . AT LOW COST!! IMMEDIATE SHIPPING!!**

Add-on Drive for Apple II, 100% compatible (runs 3.2 & 3.3 DOS). Includes cable/cabinet . . . \$339.00

5MB Tandon Winchester (TM602) & Controller/Cables/Software to run DOS 3.3 for Apple II Computer \$1795.00
Same system with 10MB Tandon Winchester 1995.00

IBM MEMORIES - 100% IBM Compatible Memories

64K \$269.00 128K \$499.00 192K \$599.00 256K 699.00 512K 1299.00 Immediate Delivery

QUME DISK DRIVES

DT-5 5 1/4" double sided, dual density drive, ANSI compatible, 500KB unformatted capacity, 48 TPI, 35 or 40 cylinders, 70 or 80 tracks **\$279.00**
DT-8 8" double sided, dual density, IBM compatible, 1.2MB/disk capacity (IBM format), 48 TPI, 77 cylinders, 154 tracks **479.00**

SHUGART

SA400 5 1/4" single/dual density, 250KB capacity, 48 TPI, 40 tracks, 1 head, 10 sectors/track **215.00**
SA450 5 1/4" single/dual density, 500KB capacity, 48 TPI, 40 tracks, 2 heads **269.00**
SA800/801 8" single/dual density, 800KB capacity, 48 TPI, 77 tracks, 1 R/W head, 32/16/8 sectors/track **379.00**
SA850/851 8" double sided, dual density floppy drive, 1.6 MB capacity, 48 TPI, 154 tracks, 32 sectors/track **535.00**

TEAC

FD50A Single sided, 5 1/4" floppy disk **199.00**
FD50B Double sided, 5 1/4" double density, floppy disk **299.00**
FD50E 80 tracks, 96 TPI, 5 1/4" floppy drive **299.00**
FD50F 160 tracks, 96 TPI, 5 1/4" double sided, floppy drive **399.00**

TANDON DISK DRIVES

TM100-1* 5 1/4" single sided, 250KB unformatted capacity, 48 TPI, 40 tracks **215.00**
TM100-2* 5 1/4" double sided, Northstar/Cromenco/TRS-80 compatible, 500KB unformatted capacity, 48 TPI, 80 tracks **279.00**
TM100-3* 5 1/4" single sided, 500KB unformatted capacity, 96/100 TPI, 80 tracks **279.00**
TM100-4* 5 1/4" double sided, Zenith/Heath/etc. compatible, 100KB unformatted capacity, 96/100 TPI, 160 tracks **399.00**
TM848-1 Thinline 8" drive, single sided, 8MB unformatted capacity, 48 TPI, 77 tracks **499.00**
TM848-2 Thinline 8" drive, double sided, 1.6MB unformatted capacity, 48 TPI, 154 tracks **549.00**
TM602 5MB Winchester drive, 6.4MB unformatted capacity, 254 TPI, 153 cylinders, 612 tracks, 2 platters, 4 recording heads, 3600 RPM **1025.00**
TM603 10MB Winchester drive, 9.5MB unformatted capacity, 254 TPI, 153 cylinders, 918 tracks, 3 platters, 6 heads **1170.00**

*Disk Drives for IBM PC.

SPECIAL on S-100 Bus computer — YANKEE 800 S-100 Bus, Z-80 microprocessor, 4MHz crystal, complete turnkey computer \$2999.00
PDS-2300 16 bit computer, faster than any 16 bit machine, LSI 11/23 with CPU board 256KB memory, CRT terminal, DLV11-J board, power supply, two (2) 8" floppy drives with cabinet, complete turnkey system **8900.00**
PDS-300 LSI 11/23 memory, 256KB dual wide board **850.00**
PDS-400 PDP 11 memory, 256KB dual wide board **850.00**

**ALL FLOPPY DRIVES & DEC MEMORIES REPAIRED AT LOW COST . . .
 . . . AND QUICK TURNAROUND**

FRANCHISE INQUIRIES WELCOME

Prices subject to change without notice.

PDS INC.

**PERSONAL COMPUTERS
 2630-H Walnut Ave.
 Tustin, CA 92680**

**TOLL-FREE TELEPHONE NUMBERS
 Outside California:**

(800) 854-8428

Inside California:

(714) 730-7207

(408) 257-8413

vest a lot of time in getting it running properly on Ezekial.

Neither was Mac Lean, and thus I read Kernighan and Plauger but never actually ran their programs. When the CP/M Users' Group put out the tools found in the book on one of the Group's disks, we made an abortive attempt to get FORTRAN running because this was, after all, back in the dark ages when there weren't many modern languages for microcomputers. You couldn't get C, and the only Pascal was the old version of UCSD (my son Alex, who's a senior there, pronounces that "Scud")

Pascal. There was no LISP, Wordstar didn't exist, and a microcomputer version of PL/I was only a gleam in Digital Research's eye. There wasn't even an affordable FORTH. As I said, the dark ages. So we seriously considered RATFOR as the language to learn; but we had trouble hooking it into CP/M, and about then we became enamoured of Pascal, there being promised a number of microcomputer versions "real soon now." Thus, although I did try to get RATFOR going a couple of times, nothing useful came of it.

That disturbed me because the idea

of "software tools" is a very good one. If you take a number of tasks, such as finding text patterns in files or archiving files, and build programs to accomplish these tasks in modular blocks, not only do you have useful programs, but you also have a number of procedures, subroutines, and functions you can lift out and put into other programs. You can incorporate the code into the source or keep the "tools" compiled in relocatable machine language for linking in. That way you don't have to reinvent the wheel every month or so.

It all sounded great, especially back then when I had more time just to play around. Every now and then I'd read *Software Tools* with a sigh of regret that I'd never got the tools running.

That's all changed now.

Now Unicorn Systems has formed a Software Tools Users' Group and, more to the point, will sell you the whole box of tools carefully rigged to run with CP/M. The firm also furnishes a lot of documents, including a tutorial.

Unicorn Systems has even put a Unix-like shell around CP/M. For example, if you want to use the FIND tool to scan the file SYSTEM.TXT for all instances of the word LOBO, you type:

```
FIND < SYSTEM.TXT LOBO
```

and all lines in the file SYSTEM.TXT containing the word LOBO will appear on the console. Note the <, which indicates input source. If you type:

```
FIND < SYSTEM.TXT LOBO
> FOO.DAT
```

then the program would create file FOO.DAT and put the output into it. Very convenient, and there's a whole raft of Unix-like extensions and features built into the shell. It would take most of the column to describe them all.

In addition to the tools and the shell that make CP/M friendlier, you get a spelling program and, of course, RATFOR, including the source code,

★ ★ ★ FEATURING 8 and 16 BIT S-100 SYSTEMS ★ ★ ★

WE OFFER A WIDE RANGE OF CRTs, PRINTERS, GRAPHICS EQUIPMENT, SOFTWARE FOR ALL SYSTEMS. EACH SYSTEM IS COMPLETELY TESTED, INTEGRATED AND READY FOR PLUG-IN OPERATION WHEN YOU RECEIVE IT. WE TAILOR & CONFIGURE SYSTEMS TO MEET YOUR BUDGET AND NEEDS. WE WELCOME YOUR REQUEST FOR TECHNICAL INFO BY PHONE OR LETTER.

GRAPHICS SYSTEM: Architects • Designers • Engineers • Create & store own designs. Create arrays. Zoom, windows. Completely interactive. Easy to edit. Powerful and fast. Package includes software + MicroAngelo Graphics Subsystem + M9900 16 bit, S-100 w/dual 8" floppies, + HI PAD Digitizer + Plotter \$10,200.

CROMEMCO: *New dual processor 68000/Z80 systems w/256K-512K memory.*
SYSTEM CS3D5E: Dual processor, 512K RAM, two 8" floppies \$8,495.
SYSTEM CS3HD5E: w/one 8" floppy, one 5MB hard disk \$10,620.
 System I, II, & III can be easily upgraded to 68000.

NEW SYSTEMS FROM IMS 2 yr. warranty on boards! SX systems w/8" or 5¼" drives, optional 10, 20 or 40MB Winchester, built-in tape back-up, multi-user capability (TURBODOS or MP/M). Z-80, S-100 bus. On site service for NY tri-state area.

TURBODOS: Spectacularly FAST CP/M® Compatible Multi-user Operating System. Cuts link/edit time in half. Z80 Code interrupt driven. Up to 6X faster than CP/M; up to 35% increased disk capacity. For IMS & CCS systems.

CALIFORNIA COMPUTER SYSTEMS 2210A High quality, low price. Z80 CPU, 1 serial port, disk controller w/CP/M 2.2 64K RAM \$1,775.
 Add our Max Box w/dual Shugarts and IMS I/O w/2 serial, 1 parallel.

LOMAS DATA 8086 SYSTEM: Complete Lomas card set in TEI 12 slot mainframe, 86-DOS, dual Shugart 801s, Televideo 912, assembled & tested \$4,599. Options: 8087 add \$600; 8089 add \$100.

SEATTLE 8086 SYSTEMS Featuring 86-DOS, the IBM PC Operating System.
 System I: 8MHZ CPU set w/1 serial, 1 parallel I/O (additional I/O option) 64KB 16 bit Static RAM, Tarbell DD controller, TEI 22 slot mainframe w/constant voltage transformer \$2,695 System II: with 128K Static RAM \$3,550.
 Interfaced to dual Shugarts 801 \$1,275. or dual QUME DT-8 \$1,680.

GODBOUT: New CPU 86/87 includes Intel 80130 operating system firmware w/iRMX Kernel. Complete GODBOUT line at discount prices.

MAX BOX DISK DRIVE SUBSYSTEM mfg by John D. Owens Assoc. Dual drive cabinet w/regulated power supply, fan, complete internal cabling. Will hold Shugart, Qumes, Tandons and/or 8" Winchester, horizontally mounted. Excellent design and engineering. 17½ x 5½ x 22. Attractive buff color.
 W/2 Shugart 801 \$1,275 W/2 QUME DT-8 dble sided drives \$1,680.

Prices subject to change without notice Write or call for free catalogue

JOHN D. OWENS Associates, Inc.
 12 Schubert Street, Staten Island, New York 10305
 212 448-6283 212 448-2913 212 448-6298

which is written in RATFOR. With the Unicorn package and a FORTRAN compiler, you could write a lot of awfully useful programs.

The Unicorn package is a class act: a thick loose-leaf binder full of fairly well organized information and 2 plastic boxes that contain 15, count them, 15 disks of software tools and sources. Incidentally, the system *will not* run on CP/M 1.4; you *must* be using 2.0 or a later version.

A few years ago I'd have been slaving for a chance at something like this. So, when at the West Coast Computer Faire, Deborah Sherrer, the principal author of most of this, gave me the choice of carrying the package home on an airplane or having it mailed to me, I chose to carry it, bulky as it all was, rather than chance losing it. But, alas, the excitement turned out to be residual; when I got home, I didn't do much with it and haven't yet.

And that's sad. Unicorn Systems has gone to a lot of work to produce something useful, well packaged, well documented, and bug free, and to try to write it up so that beginners can understand it. It succeeded too. Companies like it ought to get all the encouragement this profession can give them, and I hope it sells a lot of its packages. Lord knows Unicorn Systems is charging no more than a fair price. But. . .

The problem is that I still think both RATFOR and FORTRAN are languages whose time has passed, especially for microcomputers. Thus, while the Unicorn package plus Kernighan and Plauger are terrific for teaching RATFOR, I can't recommend spending much time learning it. It's outdated.

And so, I fear, are most of the software tools. The Kernighan and Plauger editor beats the daylights out of CP/M's ED, but then what doesn't? ED is only a little better than a Selectric II typewriter. The Software Tools editor was great in its day, but it's line-oriented, not full screen, and anyone who's using a line-oriented editor in this day and age probably chases down geese to get the makings for fountain pens. Some of the other tools, like FIND,

are useful; but ye gods, FIND.COM is a 29K-byte file, and it doesn't run very fast, either. Ditto for most of the other tools: too big, too cumbersome, too slow—and written in the wrong language.

If you really want to use Unicorn's Software Tools—and they are indeed useful foundations to build on—then you probably want them in a language you speak, not in FORTRAN.

Software Tools in Pascal

Which brings me to a mild conflict of interest, so I want to make sure

you all understand a possible bias on my part.

In my judgment, Unicorn has done a great job, and I really encourage it. But if you want the Software Tools, my recommendation is that you build your own set in Pascal or C. Kernighan and Plauger have put out *Software Tools in Pascal*, a book functionally identical to the original (all the old programs are in it, except, of course, the RATFOR compiler). My son Alex has put together a disk of the first couple of chapters' worth of the programs together with the primitives and inclusion files needed

★ ★ ★ SYSTEMS INTEGRATION SPECIALISTS ★ ★ ★

<p>IBM 3270 USERS - Teletype Model 45 Cluster controllers, terminals, printers. Bisync or SNA/SDLC protocol. Up to 32 devices on one cluster at 9600 baud. Cost effective! Fast delivery!</p> <p>HOUSTON INSTRUMENTS PLOTTERS Standard & Intelligent models w/surface of 8½" x 11" to 11" x 17". DMP-2 ... \$ 935. DMP-3 ... \$1,195. DMP-4 ... \$1,295. DMP-5 ... \$1,455. DMP-6 ... \$1,685. DMP-7 ... \$1,865.</p> <p>HAYES MICRO MODEM 100 ... \$359. Smartmodem. \$251. Chronograph. \$224.</p> <p>EPSON MX 80 \$475. MX80 FT ... \$575. MX 100 ... \$725. RS232 ... \$ 70. 2K BUFFER ... \$140.</p> <p>PER SCI: Model 299B & 277 with or without cabinet & power supply.</p> <p>TEI MAINFRAMES, S-100 MCS 112 ... \$620. MCS 122 ... \$745. RM 12 ... \$655. RM 22 ... \$790.</p> <p>TARBELL Z80 CPU \$395. New I/O card 4S + 2P \$347. Double Density Controller \$435.</p> <p>PMMIS-100 Modem \$385. Compatible w/telex & Twx. 51 to 600 baud. On board pulse dialer.</p> <p>KONAN SMC-100 hard disk controller. S-100, 2400MB control \$1,469.</p> <p>CORVUS HARD DISK SYSTEMS 6.7MB ... \$3,005. 11.3MB ... \$4,655. 20.5MB \$5,595.</p> <p>TELETYPE Model 4320 AAK \$1,140. Model 43ASR, 8 level, 1" tape ... \$2,595.</p> <p>MEMORY MERCHANT 64K RAM \$716.</p> <p>dBASEII demo package \$ 75. dBASE complete software \$595.</p>	<p style="text-align: center; font-weight: bold;">IBM PC USERS</p> <p>BABY BLUE: Z-80B, 64K RAM substitutes for IBM memory card in IBM PC. Will run Z80, CP/M[®] software ... \$600. w/Wordstar & Mail Merge totally configured for IBM keyboard \$980.</p> <p>SEATTLE COMPUTER RAM PLUS 64K RAM + BD \$418. 128K RAM + BD \$594. 192K RAM + BD \$770. 256K RAM + BD \$942. 64K Chip Kit \$176. Each RAM card has an RS232 serial port which uses IBM supplied software. Boards socketed for easy upgrade.</p> <p>8080/8086 EMULATOR runs CP/M[®] on IBM PC. All I/O runs at operating system speed \$200.</p> <p>AMDEK COLOR II MONITOR. \$810.</p> <p>MICROSOFT RAMDrive for IBM PC Expands physical memory AND implements RAMDrive which allows high speed access to files normally stored on diskette 64K \$420. 128K \$590. 192K \$760. 256K \$930.</p> <p>IDS PRISM COLOR 132 columns \$1,795. Enhanced 560 w/software selectable colors; high speed printing to 200 cps. PRISM 80 \$1,615. PRISM 80 BLACK \$1,255.</p> <p>3M SCOTCH DISKETTES FOR IBM PC 744 ss/sd \$ 26.</p> <p>MICROANGELO GRAPHICS SUBSYSTEM W/LIGHT PEN ... \$2,300. Without light pen \$1,930. Graphics card alone \$ 975. Screenware Pak II or TEKEM ... \$ 350. Color systems from 4 to 256 colors. Basic color system (4 colors) ... \$2,330.</p> <p>COMMUNICATIONS SOFTWARE Micro to terminal to micro to mainframe to modem. HAWKEYE GRAFIX Source Code ... \$500 Object Code ... \$75.</p>
---	---

WE EXPORT Overseas Callers: TWX 710 588 2844
Phone 212 448-6298 or Cable: OWENSASSOC

JOHN D. OWENS Associates, Inc.

SEE OUR AD ON FACING PAGE

LOGO

© M.I.T.

\$99
NO FRILLS
for Apple II®

NO FRILLS PAK

1. Two copies of Krells LOGO for Apple II*
2. Utility Disk with M.I.T.'s valuable demo programs including Dynatrack
3. The official M.I.T. technical manual LOGO FOR APPLE II by I. Abelson & L. Klotz
 No Frills Turtle Price \$99.00



LOGO
FRILLS ONLY

FRILLS FOR LOGO / Support Pak for:
 M.I.T. LOGO, KRELL & TERRAPIN INC.

1. Krell utility disk
2. Alice in LOGOLAND
3. LOGO for Apple II - by H. Abelson
4. Alice in Logoland Primer
5. Comprehensive wall chart
6. LOGO & Educational Computing Journal

\$89.95

COMBINATION

BOTH FOR \$149.95
NO FRILLS LOGO AND
ALL THE FRILLS COMBO
FOR APPLE II* \$149.95



KRELL®
SOFTWARE CORP.

The state of the art in educational computing
 1320 Stony Brook Road / Stony Brook NY 11790
 Telephone 516-751-5139

*Trademarks of Apple Comp. Corp., Terrapin Inc.
 PROGRAMS AVAILABLE FOR THE TRS-80, APPLE II, PET & ATARI
 N.Y.S. residents add sales tax

to get the Tools running under either Sorcim's Pascal M or Digital Research's Pascal/MT+. He's added the introductory programs from Peter Grogono's book *Programming in Pascal* (Addison-Wesley, rev. ed., 1980), and then he and Barry Workman ganged up to induce me to add my own comments. The result, called the Pascal Introduction Package, isn't anywhere near as complete as what Unicorn Systems furnishes. If you want *all* the Software Tools to run in Pascal, you'll have to type in a number of them yourself; but that's the way I recommend you go, because with the Workman package you learn a language you can build your own tools with.

However, Unicorn does give you a nifty CP/M shell you can use to get the feel of Unix, and of course, there are all the tools and some interesting extensions already compiled and ready for use. If you do plan to use FORTRAN in the future, the Unicorn deal is the best bargain in town.

The Hollerith Card Blues

A while back I mentioned that FORTRAN expects its input from 80-column cards. If you use Unicorn Systems' package of Software Tools on text files created by WRITE, Wordstar, or Magic Wand, then what the Tools think is a line can cause some pretty strange results. Alas, it's true for many other languages. We will regret the legacy of the Hollerith card for a very long time.

Take Pascal as an example. ISO (International Standards Organization) Pascal has no strings at all. Most implementations put in strings as an extension, but they do it in a way that cripples the language. Pascal M and Pascal/MT+ follow the UCSD Pascal system in which the longest string possible is 255 characters. There's nothing you can do about it because these Pascal implementations store the string length as a single byte put in front of the string. The input situation is even worse: microcomputer versions of Pascal can't grab lines longer than 255 characters, and, indeed, the implementations I'm familiar with truncate line inputs to

80-character lines unless you explicitly tell them differently.

None of this is a problem for text processing if you're using a line-oriented editor with each line 80 characters long terminated by a NEWLINE (which in ASCII is also a problem because that's two characters not one, but we'll leave that for another time). Suppose, however, you want a modern full-screen editor, one which leaves the line lengths variable and marks only the ends of paragraphs. For example, one like WRITE, the editor I use. What now?

Well, of course you can get around that, and Alex shows how in his Pascal Introduction Package. He gives you two ways. Neither is very elegant, but we don't know any elegant methods. One way is to get your input one character at a time, which works fine but slows things down a lot. The other is through a small machine-language program that "standardizes" your text files by making a copy with paragraphs broken up into lines of 80 characters or less, using different characters to mark the (artificial) line endings from those used to mark paragraph endings. This grabs WRITE, Electric Pencil, and Magic Wand files and runs about as fast as CP/M's PIP. The various Pascal tools run *much* faster on files passed through this filter because the programs can now get their input by "lines."

Or you can shelve it all and learn C, or even Digital Research's CB-80 (the compiling version of CBASIC). We've done a few preliminary comparisons of CB-80 and Pascal, and they're closer than I expected on both speed and final program code size. We're doing some experiments on that, and we'll have the results in a few weeks.

One reason Alex didn't try CB-80 sooner was that CB-80 had a ghastly license agreement that required you to pay \$2000 a year *upfront* before you could sell programs compiled with the language; but the company dropped that some time ago.

CB-80 has some terrific advantages for text processing: it can read a "line" of up to 31,000 characters in length, yet you don't have to dedicate

the power package

the Hard Power of **68000**

from the Soft-Support of **UNIX™**



system 83

multi-user multi-tasking

The System 83/ provides the ultimate link between UNIX and the 68000 microprocessor on the IEEE 696/S-100 bus. The resulting blend is a multi-user, multi-tasking computer with incredible power and versatility.

THE SOFT POWER OF UNIX

The UNIX operating system is versatile, simple and productive. Its built-in file system of highly uniformed sets and subsets of directories are arranged in a hierarchical tree-like structure. The Berkeley c-shell has been added to enhance communication between you and the operating system. A unique record lock-out system has been implemented to prevent more than one user from accessing the same record in a multi-

user / multi-tasking environment. Now, with the 68000's 32-bit internal architecture, Unix becomes state of the art on the DUAL System 83/.

THE HARDWARE

An On-Board Memory Management Unit and a scatter-loading technique are used to allow efficient processing for multiple users performing multiple tasks. An interrupt-driven DMA disk controller speeds the system's throughput with up to 80MB's of Winchester storage. An intelligent interrupt-driven I/O controller (with a 256 Byte FIFO buffer on input, and a DMA channel on output) takes the strain off the CPU for I/O, and eliminates any danger of lost

characters. The 20-slot bus allows for expansion; • up to 3.3 MB's of directly addressable RAM • Multiple SIO4-DMA boards add four users per slot • Other S-100 peripheral cards may be added for system flexibility.

DUAL DELIVERS

The Dual System 83/ hardware has been designed from the ground up with the Bell UNIX operating system in mind. The System 83/ is no engineering pipe-dream; we've been shipping the power package since February 1982. So, if you've been looking for the missing link between UNIX and the 68000, search no further. For technical information, or a quotation, please call or write to:

DUAL SYSTEMS CORPORATION

Circle 152 on Inquiry card.

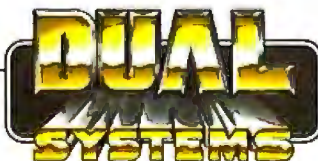

system reliability / system integrity

*UNIX is a trademark of Bell Laboratories and is supported on the Dual System 83 by UNISOFT.

OEM and Dealer pricing is available.

2530 San Pablo Avenue • Berkeley • CA 94702 • (415) 549-3854 • 172029 SPX

Sales representatives in most metropolitan areas.

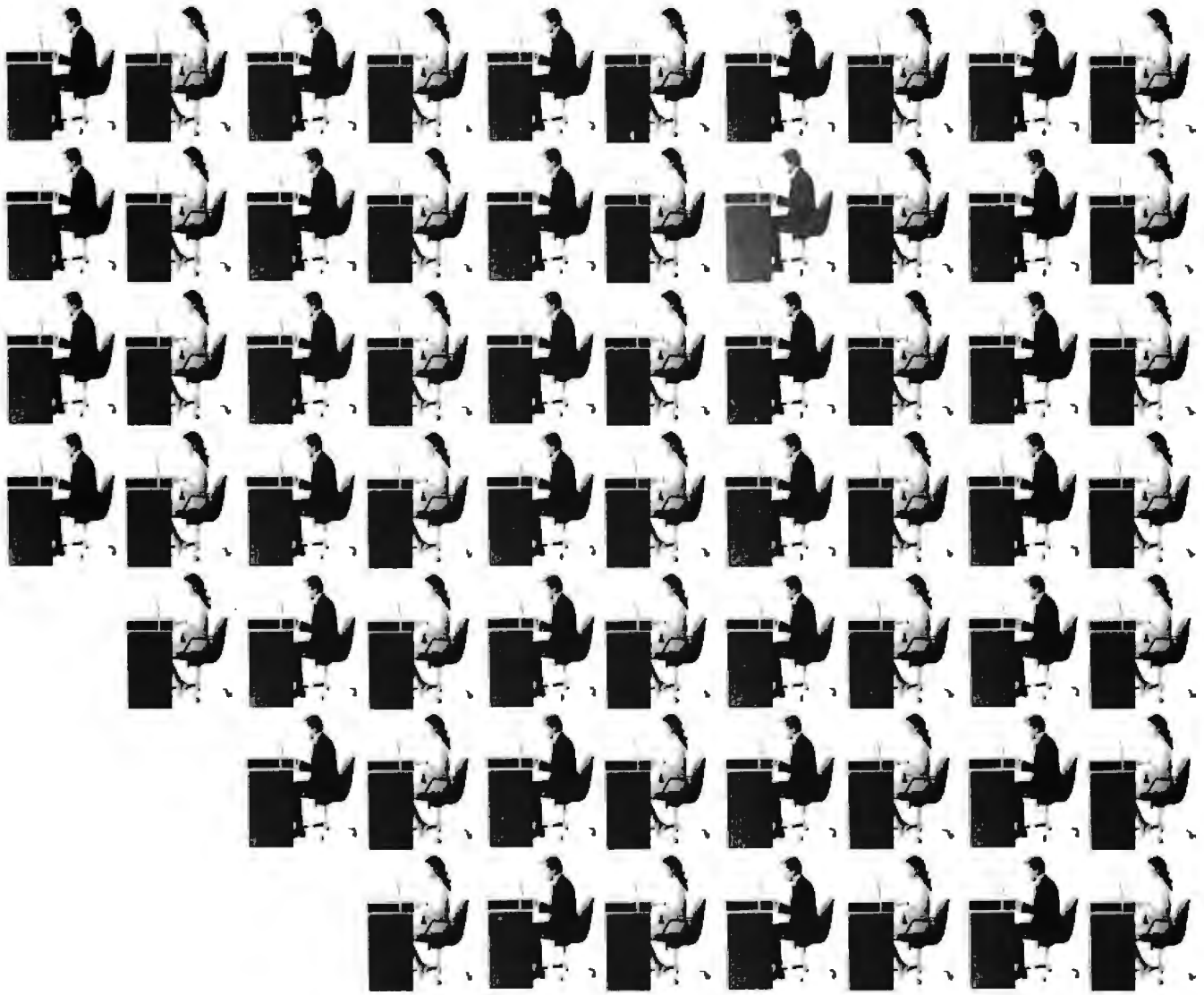

0 to 60 without shifting

Alpha Micro introduces its 68000-based line of systems.

A line that provides a growth path from a one-terminal system to a system that supports over 60 terminals.

And it's growth that doesn't sacrifice your software investment because software developed for our one-user system can run on our 60-user system.

The AM-1000. A 10 MB, multi-user system that fits on a desk.

Alpha Micro's 68000-based product line begins with the AM-1000. A desktop business system that supports two users and a printer, offers 10 MB of storage, and provides 128 KB of memory. And with its 32-bit capability, the AM-1000 offers you the kind of performance not available from 8- and 16-bit systems. In other words, it outperforms most of the currently available small business systems.

The price? Under \$10,000.

From micro to mini to mainframe with one product line.

Alpha Micro 68000-based computers move from the micro through the mini and even the mainframe categories. You can go from a one-user system with 128 KB of memory and 10 MB of disk storage to a 60-user

ALPHA MICRO 68000-BASED SERIES OF SYSTEMS

MODELS	DISK STORAGE		MEMORY		SERIAL I/O		SOFTWARE		OPERATING SYSTEM
	STD	MAX	STD	MAX	STD	MAX	STD	OPT	
1. AM-1000F (all floppy)	1 6MB	40MB	128KB	256KB	3	3	A	B	AMOS*
2. AM-1000W (winchester choice of floppy or VCR backup)	10MB	40MB	128KB	256KB	3	3	A	B	AMOS*
3. AM-1042 (winchester)	32MB	2.4GB	512KB	3MB	2	26	A	B	AMOS*
4. AM-1062 (winchester)	60MB	2.4GB	512KB	8MB	2	68	A	B	AMOS*

A AlphaBASIC* AlphaPASCAL* AlphaLISP** AMOS* Macro-assembler, Word Processing, 150 subroutines, utilities and diagnostics

*Available 1st quarter, 1982.

B Programming languages FORTRAN and COBOL, in addition to over 100 AlphaBASIC* turnkey applications are available from third-party sources.

system with 3 MB of memory and 2.4 gigabytes of disk storage.

A product line that starts so small and grows so large simplifies programming and technical support efforts.

If your business needs a computer, you need Alpha Micro.

The Alpha Micro 68000-based line is the latest, most competitive technology.

- Performance — The Alpha Micro 68000-based product line has the speed and versatility of the very latest and most powerful micro-processor chip.
- Software — The Alpha Micro Operating System...AMOS...is standard throughout the product line. That means software developed for the smallest system can run on the largest system. And AMOS is power-

ful. Its multi-user, multi-tasking and timesharing. Its device independence allows virtually any standard terminal or printer to be easily integrated into any Alpha Micro system. You choose the exact configuration that meets your needs and your budget.

Finally, AMOS is proven and field-tested, running on over 7000 Alpha Micro systems installed since 1977.

- Service — International service and support.
- Cost — For all these reasons and more, Alpha Micro products offer you an outstanding price/performance ratio.

alpha micro

17881 Sky Park North, Irvine, CA 92713

software.



Find out more about Alpha Micro.

It makes sense to find out more about the 68000-based line from Alpha Micro. Call Alpha Micro at (800) 854-8406. In California, call collect (714) 641-0386. Or fill out and send us the coupon.

- Send the name of my nearest Alpha Micro Dealer.
- I'm interested in becoming an Alpha Micro Dealer.

Name _____
 Title _____ Phone _____
 Organization _____
 Address _____
 City _____ State _____ Zip _____

What's Better Than Basic?

BASIC B+™ IS!

Delphic Systems has merged its Z80 BASIC with FairCom's MICRO B+™ to produce BASIC B+™, the first all purpose interpreter featuring a B-TREE file structure implemented using NEW commands. No more messy CALLs or difficult assembly language interfacing! Instead, use the following BASIC B+™ functions to manage an index without ever reorganizing the file:

BOPEN	BCLOSE	NEWB
KILLB	FINDB	GETB
NEXB	PREVB	STATS

In addition, BASIC B+™ was written using Z80 code in order to minimize size and enhance speed performance.

Features & Requirements

- Search a 10,000 entry index in one second
- No index reorganization needed
- Uses fast and compact Z80 code
- CP/M®
- 12 Digit precision
- Program Chaining
- Read only file protection
- Sequential and random files

BASIC B+™

with documentation

\$325.00

Delphic Systems

2260 Compton Avenue
St. Louis, MO 63104
314/773-6753

Coming Next
INVENTORY B+™

VISA MasterCard
MICRO B+™ is a Trademark of FairCom

an enormous buffer to do that. CB-80 takes care of that dynamically, so that all you must have is enough free memory to put the string in. The program then grabs everything up to and including the carriage return and ignores the linefeed character at the end. Now that the licensing of CB-80 is rational, I predict a rash of text-processing programs using it.

I showed this column to Tony Pietsch, and he got another brainstorm: a way to overlay WRITE so that it will put out text in any format you like, including lines of 64 or 80 characters terminated by a cr-lf (carriage return-linefeed) pair. I wouldn't be surprised to have that in a couple of weeks; when Tony gets to working, he works hard.

Good Stuff at Low Cost

The idea of software tools has wide appeal, and I presume that the Kernighan and Plauger book was responsible for Walt Bilofsky's naming his company The Software Toolworks. From the address I know that he's a neighbor, but in fact I never met him until the West Coast Computer Faire.

Bilofsky began by filling a much-needed niche as supplier of programs to the Heath market (he later converted them to CP/M), and it shows: many of his programs run best with a Z-19 terminal, and some, like his graphics package, won't run without one. (Lately, though, he's gotten heavily into programs for the Osborne 1.)

Bilofsky sells a wide range of programs, all at low cost (generally under \$50). All the ones I've tried are excellent. His Ed-a-Sketch for the Z-19 (and the Osborne 1), for example, will let you draw and save all kinds of fancy stuff. His PIE full-screen editor (also only for the Z-19 terminal), while no Magic Wand or WRITE, is certainly more than worth the \$29.95 he charges. I haven't tried his spelling checker (\$49.95 with 50,000-word dictionary equivalent; it runs on the Osborne 1), but if it works as well as his other software does, it has to be a bargain.

He'll also sell you Eliza, that rather stupid psychiatrist program, for \$24.95 (CP/M or Osborne). You'll

get tired of Eliza pretty quickly, but it is a nice thing to have next time someone asks you to demonstrate your computer at a party.

There are also games (including Mychess for the Osborne), a LISP interpreter, a C compiler, and more to the point of this column, languages, including RATFOR for Microsoft FORTRAN (keyed to the *Software Tools* book). I somewhat prefer Zolman's BDS C (B. D. Software C), if for no other reasons than the extensive documentation and library utilities that come with the BDS package. But the Software Toolworks program compiles to 8080 assembly language, meaning that you can get in and hand-optimize important loops if you need to. It's fast, and I may well end up writing some operating utilities in it.

Things have been a bit hectic here at Chaos Manor, so we haven't had a chance to try all of Bilofsky's programs; but we've tested several, and all work as advertised. I strongly recommend his philosophy and approach. By all means get his catalog; for sound programs at very reasonable costs, Software Toolworks is hard to beat.

One Strange Bug

I can't think of anywhere else to put this. If you don't use CBASIC, you can skip this section.

I've written my Journal program in CBASIC. It compiles fine on Ezekial, who runs CP/M 1.4 at 2 MHz. But when I tried to compile the exact same program on the Godbout 8085/8088 (running at 6 MHz), I got the goofiest errors you have ever seen. Things like "BDOS ERROR ON X: Bad Sector," and no, the "X" is *not* a misprint. And sometimes the compiler would just keep running: it would reach the end of the program and start right over again. Transfer the disk down to Zeke and no problems; put it in the Godbout and get nutty error messages or infinite loops.

Eventually I solved the problem. First, on a Godbout 8085 running CP/M 2.2x at 6 MHz, the END statement to terminate a CBASIC program is *not* optional. Always include it; it helps the compiler find the end.

IBM PC

192K RS232 SERIAL

\$499

...what's the catch?

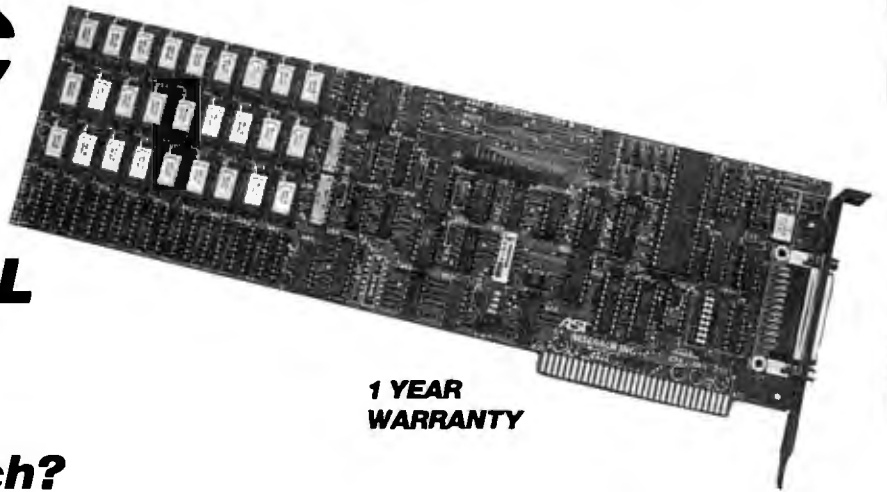

**1 YEAR
WARRANTY**

Take a good look. This is the face of things to come. On one board in one slot, you get 192k of additional memory and a serial printer port. If you look close you will see the board has room to expand to 256k. You can even add another parallel port. And if that is not enough, by the time you read this we will have added another useful option — a real time clock.

IBM DIDN'T MAKE IT SIMPLE

Well that's good, because simple usually means limitations, and so far we have not found a lot of limitations. It is hard to pick IBM cards when you have only five slots. Now lets see. If you want graphics and color you buy one board. And if you want a printer port you buy another. Or you buy a monitor adapter and you get a printer port on the same board. When you want to add serial communication it's another board. Add some memory at 64k per board. Wait a minute. Thats two plus one, plus one, plus one more, minus one if you don't want graphics — HELP!! Your PC is now a mass of boards and you still want to do more. Not only that, but you now have spent so much money on boards you may have to compromise somewhere else in your system.

A QUICK SURVEY

We decided the answer was a board that could do several jobs and use a single slot. First we called IBM to find out what kinds of boards and accessories are sold in what percentages. Wrong question. You would have thought we had asked what was on the missing 18 minutes of the Watergate tapes, because that's what we got — a long silent pause. The official answer was "that information is not available to non-IBM people." So we started calling dealers and asking them. Turns out that about 85% of the systems they sell have the monitor board with the printer port. The next most popular item is the asynchronous serial board, and then memory. Almost all of the salesmen we talked to tried to tell us we didn't want IBM 64k memory boards, and they would be happy to sell any num-

ber of aftermarket boards for prices ranging from \$795 to \$1195. A.C. Nielsen would be proud.

HOW IT'S DONE

Land. Printed circuit area is called land. If you have enough land, and you are real clever in how you use it, you can "grow" everything you want on one board. In this case we have enough land to do all the popular things. First 192k. This combined with the 64k in the PC gives you 265k. Just the right number. Count 'em. Nine per row of 64k bit chips so you get parity checking. Our board comes standard with an RS232-C serial port. All of the good things like solder masking, silk screening of parts locations, and of course gold plated connectors are standard. Each board is tested and burned in.

For an additional \$50 you can get a second printer port. You choose, either serial or parallel. On the little land we have left we are adding a real time clock which you can have for \$50. You can put in your own row of chips to increase the memory to 256k, but we won't warranty your row of chips. For \$100 we will add them to the board, test, burn in, and warranty them.

AN OFFER YOU SHOULDN'T REFUSE

One of the best things you can use the PC for is a spreadsheet program like Visicalc. That's how we figured out exactly how much this board cost us to build and how much to sell it for. Then we discovered Supercalc. All the things we liked about Visicalc are in it, and all the things we did not like are corrected. It addresses all the memory (256k), and in fact will address 512k if you have it. Now the offer. If you buy the package from us, the board and Supercalc, it will only cost you \$675. Look around. You don't have to take our word for it. But you should. The offer is only good if you buy them both at the same time.

FALLS LIKE A ROCK

Clever design, mass production, and the fact that we do it all on one

board is how you get so much for so little. We sell direct to you. No dealer or distributor profits are added on. And guess what else. If the prices of the most expensive components, the memory chips comes down, we will reduce our prices even more. Be sure to give us a call before you buy, you might be in for a pleasant surprise.

SATISFACTION GUARANTEED

Our warranty is 1 year parts and labor. We include the schematics with each board. We also sell diagnostics on diskette for \$10. We will repair any board returned for warranty repairs within 48 hours of receipt or we will give you a new board. And to top it off, if for any reason you are not satisfied, you may return the board to us within 30 days for a full refund. Period.

192k and Serial Port \$495
100k more, add \$100
Second printer port \$50
Real time clock \$50

California residents add 6% Sales Tax.

SHIPMENT

By UPS. We pay the freight.

PAYMENT

Cash, cashiers check, or money order. Visa and Mastercard accepted. Personal checks will require two weeks to clear.

TO ORDER

Outside California (800) 421-7103
California (213) 870-3718

QUBIE' DISTRIBUTING

1703 Stewart Street
Santa Monica, CA 90404

Second, always end the program with no fewer than five carriage return/linefeed pairs. You *must* have at least one at the end of the program, or it won't compile at all. But for my fast machine, it turns out that if one carriage return/linefeed pair is good, more's better, and about five keep the errors away. I haven't a clue as to why this works, but it does.

Them Old BDOS Blues

I suppose I don't have to say that all in all I like CP/M; but there are times when I grow very weary of its flaws. It gets particularly annoying when there might be a hardware

problem. "BDOS ERROR ON B: Bad Sector" (BDOS stands for basic disk operating system) isn't very informative when you know you can get that message because of any one of a dozen reasons.

I suppose one reason CP/M hasn't annoyed me as much as it does most people is that I've always had Tony Pietsch's protective software. Ezekial, for example, has a very large PROM (programmable read-only memory) monitor that looks at everything and has complete diagnostic messages. Thus when I forget and leave Zeke's drive doors open and try to save something, he says, "PLEASE CLOSE

DRIVE DOOR." When I close the doors, he goes on as if there'd never been a problem.

Unfortunately, the CBIOS (customized basic input/output system) supplied by Bill Godbout with his 8085/8088 isn't anywhere *near* that friendly, as I found out while doing my taxes. I was entering stuff into my journal, which is a CBASIC program, and my wife called me to dinner. I didn't expect to be long—during tax time at Chaos Manor *everyone* avoids me—so I opened the drive doors and left the Godbout running. When I returned I made some more entries, then tried to save the enlarged

ANNOUNCING...

80 Columns for the ATARI® 800

The FULL-VIEW 80

Display Card combines the best of two worlds — 80-column capability with normal ATARI 40-column/graphics mode. 80-column mode provides upper and lower case characters with full descenders.

Add the **32K MEMORY PLUS** with the FULL-VIEW 80 to achieve a 48K, 80-column system. The 32K MEMORY PLUS card operates with both the ATARI 400 and ATARI 800.

The ATARI FULL-VIEW 80 and 32K MEMORY PLUS join the family of APPLE products currently available from Bit 3

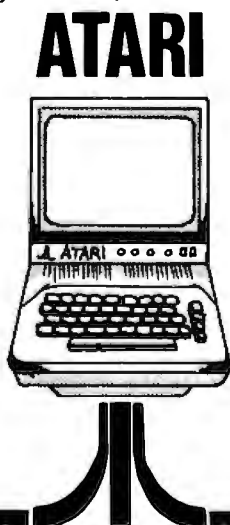

FULL-VIEW 80-
80 x 24 display for the APPLE II and APPLE II PLUS supplies upper and lower case with full descenders, line drawing graphics, and shift key detector for typewriter-like operation.

DUAL-COMM PLUS

Two independent serial I/O ports for the APPLE II combines features of APPLE High Speed Serial Card and APPLE Communications Card in one card. Baud rates range from 50 to 19,200. Great with the FULL-VIEW 80 and a modem.

MEMORY PLUS-

16K addition to increase your 48K APPLE to 64K.



Contact your ATARI or APPLE dealer or Bit 3 for more information.

ATARI PRODUCTS:

Full-View 80	\$349.00
32K Memory Plus	\$179.00

APPLE PRODUCTS:

Full-View 80	\$295.00
Dual-Comm Plus	\$239.00
Memory Plus	\$149.00

ATARI is a registered trademark of ATARI, Inc.; FULL-VIEW 80 and MEMORY PLUS are registered trademarks of BIT 3; APPLE II is a registered trademark of Apple Computer, Inc.



8120 Penn Avenue South, Suite 548
Minneapolis, Minnesota 55431
(612) 881-6955





AMERICAN

SMALL BUSINESS COMPUTERS

118 SO. MILL ST
PRYOR, OK 74361
(918) 825-4844

ALL PRICES ARE CASH DISCOUNTED 3%. C.O.D. AND CHARGE ORDERS ARE 3% MORE.
RETAIL LOCATION: 447 S. WOOD, PRYOR, OKLAHOMA 74361

TRS-80 MODEL III

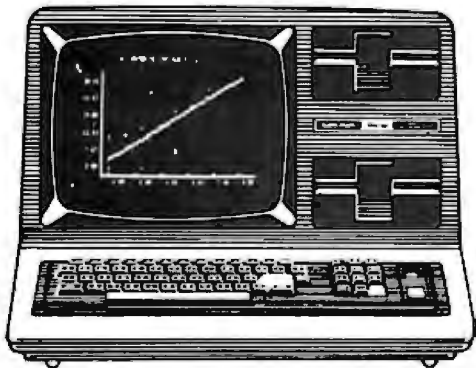

16K.....\$825

48K.....\$849

48K 1 DRIVE.....\$1499

48K 2 DRIVE.....\$1749

RS-232 (INSTALLED).....\$92.00

CASSETTE.....\$55.00

THERE'S NO SECRET

There's no secret as to why we can sell TRS-80 computer equipment for less. Low overhead — that's the reason — pure, simple and straight! As everyone knows, Radio Shack is a huge corporation...with huge expenses. We are able to buy the bare-bones computers from Radio Shack. To these computers, we add our own memory chips, disk drives, cables, etc. The result is a computer system which is equal to, or in many cases, superior to the one you would get from Radio Shack in both price and performance capabilities. There is one thing that you don't get from Radio Shack — their 90 day warranty. What you get in its place is the exclusive 180 days American Small Business Computer's Warranty. So...if you like the Radio Shack computer, but don't like the price...CHECK US OUT!!!

American Small Business Computers is not an authorized Radio Shack Dealer. We do not offer a Radio Shack 90 Day Warranty on our computers. Instead, we offer the American Small Business Computers 180 Day Warranty. If you have a problem with your computer, return it to us for about 48 hours. If we can't fix it, we'll replace it!

918-825-4844

CP/M® Users: Access IBM with ReformatTter™

ReformatTter conversion software lets you *read* and *write* IBM 3740 diskettes* on your CP/M or MP/M system.

ReformatTter is ideal for CP/M users who want

- Access to large system data bases
- Distributed data processing
- Offline program development
- Database conversion

With ReformatTter, you have the ability to

- Bidirectionally transfer complete files between CP/M and IBM
- Automatically handle ASCII/EBCDIC code conversion
- Display and alter IBM 3740 directory and data

Enjoy the same advantages of main-frame access that other ReformatTter users have. Customers like Upjohn, M&M/Mars, The United Nations, Arthur Young & Co., Sandia Labs, FMC Corp., and Stanford University all use ReformatTter. So can you.

Other versions of ReformatTter conversion software include

CP/M ↔ DEC (RT 11)

TRSDOS Mod. II ↔ CP/M

TRSDOS Mod. II ↔ DEC (RT 11)

Order ReformatTter today for only \$249.

*IBM 3740 basic data exchange format. ReformatTter requires one 8" floppy drive.

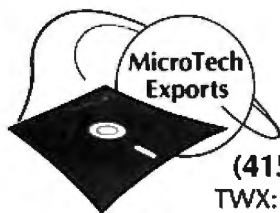

(415) 324-9114

TWX: 910-370-7457

467 Hamilton Av., Suite 2, Palo Alto, CA 94301

CP/M is a reg. trademark of Digital Research

Please send complete information on the following versions of ReformatTter _____

- Please send ReformatTter CP/M ↔ IBM. My check for \$249 (plus 6 1/2% tax for Cal. res.)
 Charge to my Visa Mastercard

Signature _____

Name _____

Company _____

Street _____

City _____

State _____ Zip _____

Mail to MicroTech Exports, Inc.
 467 Hamilton Av., Suite 2, Palo Alto, CA 94301

file. Like an idiot, I used the same filename that I'd used before. And, alas, I hadn't closed the drive doors.

"BDOS ERROR ON A: Select Error," it said to me. "Bah," I replied. "It's an open drive door." And unthinkingly I closed the drive door. Whereupon it proceeded to completely clobber my file and thoroughly crash the system.

Fortunately, I'd thought of that one long ago when I wrote the Journal program: the actual entries are in files called "JORNL-21" and the like, while the first thing the program tries to write is a summary file called "JRSUM-21" that contains only summary stuff like the number of entries and heading data. It's easy enough to recreate the JRSUM file and thereby save the data in the JORNL file. But it's still infuriating to have to do it.

"You've had it too easy," Tony said. "You're used to my software."

"I know that," I said. "But what do I do now?"

"Well, I've done a new CBIOS for the Godbout. . . ."

Meaning that open drive doors no longer crash my system. I'm encouraging Tony to send a copy of the new CBIOS to Bill Godbout so others can have that benefit also. I hope he'll do it. The only problem is that he doesn't want to maintain the thing and answer hundreds of questions from users.

He's also taken care of the problem of open doors in WRITE (Writers' Really Incredible Text Editor), which he keeps improving monthly. With WRITE, you can leave the drive doors open, change disks, put in full disks, and put in disks with bad media, and WRITE still recovers.

Or tries to. The problem is that Tony can't be responsible for your CBIOS, and if that's not well written, there may not be anything the program can do.

There are only three error messages in CP/M: "Select Error," meaning that the system can't find the drive it's trying to write to; "Bad Sector," meaning that it can't perform whatever operation it's trying to do, like read or write a sector; and "R/O," which means that the directory doesn't match the bit map. That may

be because you didn't press Control-C after changing disks, but "R/O" sometimes means either the disk or the directory is full.

None of these errors should be fatal. With careful study of CP/M you *ought* to be able to return control to your program. Tony catches stupid errors, such as open doors and the like, in the CBIOS, and the people at Sorcim told him how to let programs recover from other BDOS errors. Unfortunately, most programmers don't know enough about CP/M to catch stupid errors, and CP/M documentation, including all the books I've seen on the subject, isn't helpful.

The trick—which is *not* supported by Digital Research and, in fact, is specifically forbidden in the CP/M documentation—is absurdly simple. In CP/M, location 00 has a jump instruction, and the address of the "warm start" (the place in memory you go to do the equivalent of Control-C) is in locations 001 and 002. The Digital Research documents say that this *must* be left unchanged; but in fact, CP/M 1.4 and 2.2 *never* call that location unless there is a BDOS ERROR.

All of which means that a clever programmer can snatch that warm-start location, store it, and put the address of an error-trap routine into locations 001 and 002. On exiting the program, you put the warm-start address back. If none of this makes any sense to you, don't worry about it. What I'm doing is giving out some underground information for those who can make use of it. I repeat, this is not supported by Digital, and there are no guarantees that future releases of CP/M (or MP/M) will be compatible with this recovery method.

Also, if your CBIOS is incompetently done, then clever programmers can't compensate. Alas, there is more than one incompetent CBIOS floating around. There are even companies that won't give you the source code of your CBIOS. If you've been unfortunate enough to get yours from one of those companies, you have my sympathy and advice, which is to think again before dealing with a company that withholds vital infor-

THE FORTH SOURCE™



FORTH DISKS WITH DOCUMENTATION

	PRICE
fig-FORTH Model and Source Listing, with printed Installation Manual and Source Listing.	
<input type="checkbox"/> APPLE II, 5¼	<input type="checkbox"/> 8080/Z80®, 8
<input type="checkbox"/> 8086/8088, 8	<input type="checkbox"/> H89/Z89, 5¼
<input type="checkbox"/> APPLE II/III + by MicroMotion. Version 2. FORTH-79 Standard, editor, assembler, 200 pg manual, 5¼	\$65.00
<input type="checkbox"/> APPLE II/III + COMBO 1 by MicroMotion. Version 2. All of the above plus floating point and HiRes Turtle graphics, 5¼	100.00
<input type="checkbox"/> APPLE II by Kuntze. fig-FORTH editor, assembler, source listing and screens, 5¼	140.00
<input type="checkbox"/> APPLE II by Kuntze. fig-FORTH editor, assembler, source listing and screens, 5¼	90.00
<input type="checkbox"/> ATARI® by Pink Noise Studio. fig-FORTH, editor, assembler, missile graphics, sound and handle drivers, 5¼	90.00
<input type="checkbox"/> CP/M by MicroMotion. Version 2.x. FORTH-79 Standard, editor, assembler 200 pg manual, 8, 5¼	90.00
<input type="checkbox"/> CP/M Combo 1 by MicroMotion. 2.x. All of the above plus floating point, 8 or 5¼	100.00
<input type="checkbox"/> CROMEMCO® by Inner Access fig-FORTH editor, assembler, 5¼ or 8	140.00
<input type="checkbox"/> H89/Z89 by Haydon. fig-FORTH Stand Alone, source, editor, assembler & tutorial on disk, 5¼	100.00
<input type="checkbox"/> H89/Z89 by Haydon. fig-FORTH, CP/M®, source, editor, assembler, & tutorial on disk, 5¼	250.00
<input type="checkbox"/> HP-85 by Lange fig-FORTH, editor & assembler, 5¼	175.00
<input type="checkbox"/> IBM® PC/FORTH by Laboratory Microsystems. fig-FORTH, editor and assembler. Manual, 5¼	90.00
<input type="checkbox"/> IBM-Floating Point by Laboratory Microsystems. Requires PC/FORTH. Specify software or for AMD 9511, AMD 9512 or Intel 8087, 5¼	100.00
<input type="checkbox"/> PET® by FSS. fig-FORTH editor & assembler, 5¼	90.00
<input type="checkbox"/> PET® with floating point, strings, disk I/O, 5¼	150.00
<input type="checkbox"/> TRS-80/1 by Nautilus Systems. fig-FORTH, editor and assembler, 5¼	100.00
<input type="checkbox"/> TRS-80/1 or III by Miller Microcomputer Services. MMSFORTH, FORTH-79 subset, editor, assembler, dbl-precision, arrays, utilities & applications. 210 pg. manual, 5¼	90.00
<input type="checkbox"/> 6800 by Talbot Microsystems. fig-FORTH, editor, assembler, disk I/O, FLEX® 5¼ or 8	130.00
<input type="checkbox"/> 6809 by Talbot Microsystems. fig-FORTH, editor, assembler, disk I/O, FLEX® 5¼ or 8	100.00
<input type="checkbox"/> 6809 Enhanced 2nd screen editor, tutorial, tools and utilities, macroassembler, FLEX, 8 or 5¼	100.00
<input type="checkbox"/> Z80 by Laboratory Microsystems. Editor and assembler, CP/M, 8	250.00
<input type="checkbox"/> Z80, floating point, requires Z80 above, 8	50.00
<input type="checkbox"/> Z80, AMD 9511 support, requires Z80 above, 8	150.00
<input type="checkbox"/> 8086/88 by Laboratory Microsystems. Editor, assembler, CP/M-86®, 8	100.00
<input type="checkbox"/> 8086/88 with floating point, CP/M-86, 8	200.00
<input type="checkbox"/> 8086/88 with AMD 9511 support CP/M-86, 8	200.00

CROSS COMPILER DISKS

Allows extending, modifying and compiling for speed and memory savings, can also produce ROMable code.

<input type="checkbox"/> CP/M 200.00	<input type="checkbox"/> IBM* 300.00
<input type="checkbox"/> H89/Z89 200.00	<input type="checkbox"/> 8086* 300.00
<input type="checkbox"/> TRS80/1 200.00	<input type="checkbox"/> Z80* 200.00
<input type="checkbox"/> Northstar 200.00	<input type="checkbox"/> 6809 350.00

* Requires FORTH disk

MVP-FORTH PRODUCTS

MVP-FORTH is a public domain product which contains a FORTH kernal, FORTH-79 Standard Required Word Set, vocabulary for STARTING FORTH, editor, assembler and utilities.	
<input type="checkbox"/> MVP-FORTH Programmer's Kit including disk with documentation, ALL ABOUT FORTH, and STARTING FORTH (specify computer)	\$100.00
<input type="checkbox"/> MVP-FORTH Disk with documentation (specify computer)	75.00
<input type="checkbox"/> ALL ABOUT FORTH by Haydon. A complete annotated glossary of FORTH with latest functional definitions implementations, examples, and discussion of common dialects. 230 pp.	20.00
<input type="checkbox"/> MVP-FORTH Cross Compiler Disk and documentation (Specify computer)	200.00
<input type="checkbox"/> MVP-FORTH Programming Aids. Disk and manual, decompiler, subroutine decompiler, callfinder and translator. (Specify computer)	150.00

FORTH MANUALS, GUIDES, & DOCUMENTS

<input type="checkbox"/> "FORTH Encyclopedia" by Baker and Derick. A complete programmer's manual to fig-FORTH with FORTH-79 references. Flow Charted	25.00
<input type="checkbox"/> "Starting FORTH" by Brodie. Prentice Hall. Best user's manual available. (soft cover)	16.00
<input type="checkbox"/> "Starting FORTH" (hard cover)	20.00
<input type="checkbox"/> "METAFORTH" by Cassady. Cross compiler with 8080 code.	30.00

Proceedings of Technical Conferences

<input type="checkbox"/> "1980 FORML" (FORTH Modification Laboratory)	25.00
<input type="checkbox"/> "1981 FORML" Two Volume Set	40.00
<input type="checkbox"/> "1981 Rochester University"	25.00
<input type="checkbox"/> "Systems Guide to fig-FORTH"	25.00
<input type="checkbox"/> "Using FORTH"	25.00
<input type="checkbox"/> "A FORTH Primer"	25.00
<input type="checkbox"/> "Caltech FORTH Manual"	12.00
<input type="checkbox"/> "Threaded Interpretive Languages"	20.00
<input type="checkbox"/> "Invitation to FORTH"	20.00
<input type="checkbox"/> "PDP-11 FORTH User's Manual"	20.00
<input type="checkbox"/> "AIM FORTH User's Manual"	12.00
<input type="checkbox"/> "APPLE® (MicroMotion) User's Manual"	20.00
<input type="checkbox"/> "CP/M® (MicroMotion) User's Manual"	20.00
<input type="checkbox"/> "TRS-80® MMSFORTH User's Manual"	18.50
<input type="checkbox"/> "FORTH-79 Standard"	15.00
<input type="checkbox"/> "Tiny Pascal in fig-FORTH"	10.00
<input type="checkbox"/> "FORTH-79 Standard Conversion"	10.00

INSTALLATION DOCUMENTS

<input type="checkbox"/> Installation Manual for fig-FORTH, contains FORTH model, glossary, memory map, and instructions	\$15.00
<input type="checkbox"/> Source Listings of fig-FORTH, for specific CPU's and computers. The above installation manual is required for implementation. Each	15.00

<input type="checkbox"/> 1802	<input type="checkbox"/> 6502	<input type="checkbox"/> 6800	<input type="checkbox"/> AlphaMicro
<input type="checkbox"/> 8080	<input type="checkbox"/> 8086/88	<input type="checkbox"/> 9900	<input type="checkbox"/> APPLE II®
<input type="checkbox"/> PACE	<input type="checkbox"/> 6809	<input type="checkbox"/> NOVA	<input type="checkbox"/> PDP-11/LSI/11

ORDERS ONLY (415) 961-4103

DEALER & AUTHOR INQUIRIES INVITED

Ordering Information: Check, Money Order (payable to MOUNTAIN VIEW PRESS, INC.), VISA, MasterCard or COD's accepted. No billing or unpaid PO's. California residents add sales tax. Shipping costs in US included in price. Foreign orders, pay in US funds on US bank, include for handling and shipping by Air: \$5.00 for each item under \$25.00, \$10.00 for each item between \$25.00 and \$99.00 and \$20.00 for each item over \$100.00. Minimum order \$10.00. All prices and products subject to change or withdrawal without notice. Single system and/or single user license agreement required on some products.

Specializing in the FORTH Language
MOUNTAIN VIEW PRESS, INC.

PO BOX 4656

MOUNTAIN VIEW, CA 94040

(415) 961-4103

mation. The CBIOS matches your particular hardware to the general CP/M operating system, and if it isn't well done—or if you can't modify it—then you can be in big trouble.

The potential for error recovery is inherent in CP/M because the bit map, which tells precisely where the various chunks of your file are hidden, and the directory are right there together. Both are updated quickly and efficiently each time you go Control-C, or each time your program makes the appropriate call to accomplish the same thing. WRITE, for example, does the equivalent of Control-C before *every* read or write operation; thus it's always working with an up-to-date bit map and can cope with changes of disk and the like. (Remember, Tony put WRITE together from specs furnished by Larry Niven and me; and we're very paranoid about losing text, so WRITE is extremely defensive. Since Larry and I often write with, uh, lots of brandy for the coffee, WRITE has to

be tolerant of operator errors as well.)

But despite the fact that clever programmers can overcome many CP/M flaws, we still have a problem: CP/M, our de facto "standard," has holes you can drive a truck through. The question before the house is, "Is Digital Research doing anything to fix them?" When we get our 16-bit and 32-bit machines, must we endure more "BDOS ERROR ON X: R/O" when we know darned well the disk isn't Read Only because we physically removed the write-protect mechanism from the disk drive?

CP/M is a good operating system; but there are some improvements needed. We can hope Digital Research will make them. If not—well, think of it as evolution in action. . . .

Utilities

I hope CP/M cleans up its act. Meanwhile, I have a temporary solution to some of the problems.

First, if you're not getting the public-domain CP/M utilities, either "raw" from the CP/M Users' Group or "filtered" through someone like Barry Workman, you ought to do something about it.

And more good news: CP/M will give you a reasonably well formatted directory or tell you file sizes; it won't do both. You can, however, get XDIR or XD, which will. Both have long been available from the CP/M Users' Group, and Workman furnishes versions for both 1.4 and 2.x on his Utility Disk One. But there's better news.

Tony Pietsch has just written a real doozy of an XDIR that lets you put in wild card characters (XD *.FOO will list all and only those files with an extension of FOO), optionally allows you to alphabetize by extension (it groups all the .ASM files, then the .COM files, etc., with the filenames alphabetized within each extension), tells you the number of kilobytes each file takes up, tells you what user number is logged on, will show you the directory of *another user* without your having to log on as that user, tells you how many directory entries and how many kilobytes remain on that disk, and does it all speedily and efficiently. It's the equivalent of STAT in usefulness and reliability. There's even an XD.DOC file you can call for help. I can't imagine how I got along without it. Tony wrote it for me, Larry, and himself. You can get it and other programs from Barry Workman on his Utility Disk Four.

Then there's Power, which comes to you from an outfit with the cutesy name Computing! The exclamation point is part of the firm's name. I wonder, is it trademarked? For that matter, some day I suppose I'll wake up to discover that my own name has been trademarked—by someone else. In any event, at the West Coast Computer Faire the utility was called CPMPower, but since then the company has changed the name of its package because of legal complications, and it is now called Power.

Incidentally, the "licensing agreement" for Power makes more sense than most do. Computing! disclaims any responsibilities, of course, but



Natural habitat.

Wild animals can't live the way people do. They need wilderness to roam, secluded areas in which to raise their young, undisturbed freedom to hunt and forage for food.

With bulldozers and chain saws, man is constantly encroaching upon their range.

They can't share our spaces. So we have to give them the space they need.

That's the idea behind the National Wildlife Federation's Land Heritage Program. With the aid of interested individuals and corporations, we're acquiring still undeveloped land to preserve the habitat of endangered animals like the bald eagle.

The land in its natural state is part of our heritage too. Help preserve it. Join the National Wildlife Federation, Department 107, 1412 16th Street, NW, Washington, DC 20036.



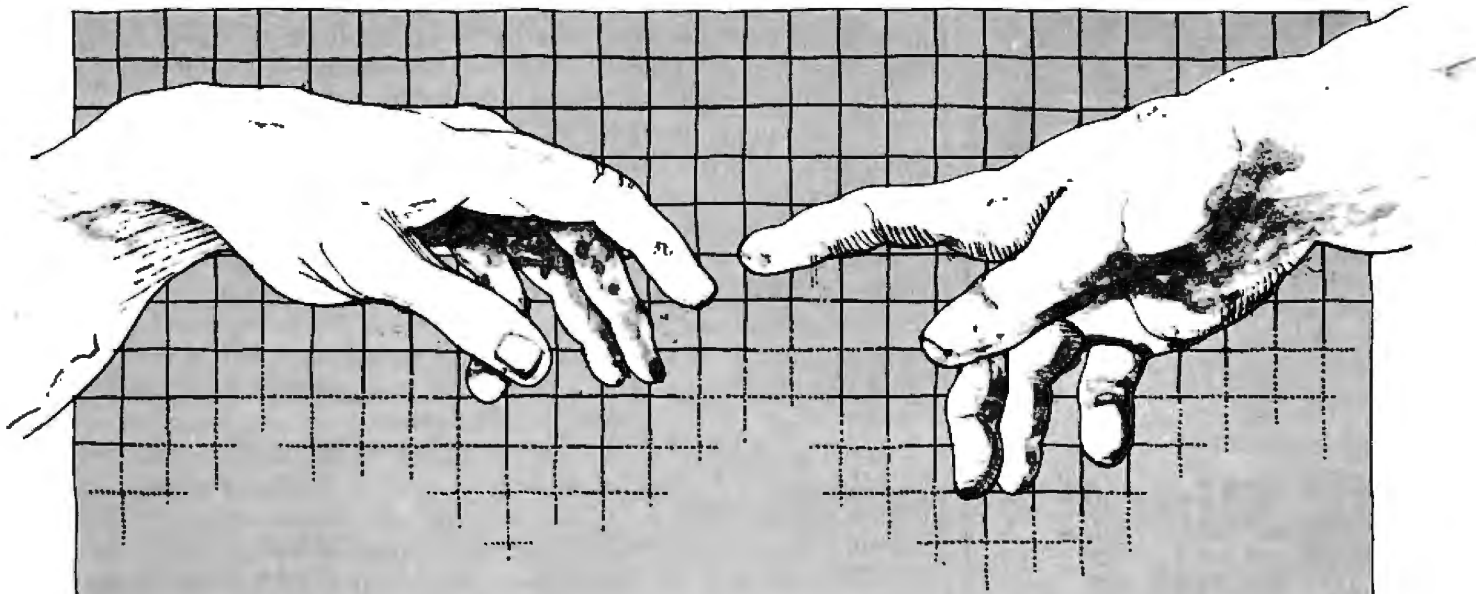

DATAFLEX™

THE MULTI-USER DATA BASE

SOFTWARE FOR CREATORS

Bring your CP/M* software applications to life with DataFlex. From menus to multi-key ISAM, DataFlex has the features and power you need to create complete turn-key software applications in a RELATIONAL data base environment.

Compare...what else gives you: up to 125 data files with 4 indexes each, fast on-line multi-key ISAM file maintenance, a multi-file report generator, on-line multi-file transaction processing, an easy to use Query, even a "soft" menu to replace the CP/M command mode. All of this using DataFlex's configuration utilities, and NO PROGRAM CODE!

Is it easy to use? You can type in a screen format "image" of a file with your text editor. Then, DataFlex's AUTODEF utility will create the file definition from the screen image...in about five seconds!

DataFlex will handle your multi-user requirements too! It runs under Software 2000's TurboDos Network O/S with data protection to the field level. That means multiple users in the same record at the same time!

If the 16 bit world is your domain, an 8086 version of DataFlex

will be available second quarter '82. And, you can develop now on your 8080/Z-80 system, and transport completed applications to the 8086.

If you need applications now, Data Access has a Library of existing DataFlex applications developed by other creators. They're ready to go at prices that will get you going. The DataFlex Library has Order Entry/Inventory, Accounting, Pharmacy, and Legal Billing, with more being added all the time. For highly specialized requirements, DataFlex's PASCAL Library is available to application developers.

DataFlex can change the way you do business. And, at \$750 it's the best software value in the business. A demo package, which limits file sizes internally, is only \$100 including the manual.

Get the full system, or get the demo, but get your hands on DataFlex.

It's software for creators.

DATAACCESS®

CORPORATION

4221 Ponce De Leon Blvd.,
Coral Gables, FL 33146
(305) 446-0669

"Dealer, Systems House and OEM inquiries invited."

*CP/M is a registered trademark of Digital Research, Pacific Grove, CA.

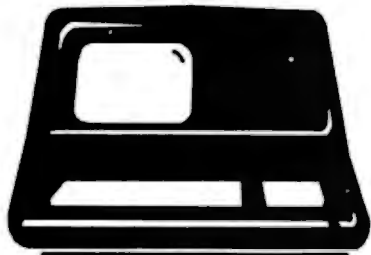

SUPERBRAIN™

The super performing, super reliable microcomputer from Intertec Data Systems features twin double-density 5¼" drives with 350K or 700K of disk storage – expandable to 10 megabytes. A CP/M* Disk Operating System, 64K of dynamic RAM and more.

\$ SUPER PRICE

Because we're a nationwide distributor of SuperBrain, CompuStar, and the CompuStar 10-Megabyte Disk Storage System, we can offer the absolute lowest prices in the business.

⚡ SUPER SERVICE

Better yet, we offer you a great deal of service and support because we want your business tomorrow as well as today.

- We'll burn-in your SuperBrain for 72 hours before we deliver it
- We'll help with installation and configuration
- We'll repair equipment at our service center and replace modules when necessary
- We'll fill your software needs or help you develop your own
- We'll match your SuperBrain with a super printer

For more information call 609-424-4700 or 215-629-1289. To order call toll-free 800-257-5217. In NJ call 609-427-4700.



* Registered trademark of Digital Research Inc. SuperBrain and CompuStar are trademarks of Intertec Data Systems.



simultaneously demands only that the user not redistribute the programs. It doesn't ask the buyer to restrict use to one machine.

One of the things Power claims to do is intercept the horrible "BDOS ERROR ON A: Select Error" message if you leave the drive door open. Unfortunately, if you follow the instructions to test this feature, you get the same old BDOS ERROR nonsense that you always get. The document says "NOTE: Error trap flag must be set at 10D Hex if your CP/M system accommodates this feature. (See CUSTOMIZATION.)" On turning to CUSTOMIZATION (which I had trouble finding; there's no table of contents, but fortunately CUSTOMIZATION is where the index would be if the document had one), I found no explanation whatever but an assembly listing that told me:

```
010D 00 ERRTRP: DB 0 0=not,
OFFh=trap hard disk errors
```

If you can tell me what that means, I'll give you sixpence. So I haven't the foggiest whether some kind of magic manipulation (such as setting 10D to something other than 0) will intercept the BDOS ERROR or not.

Once I got Power transferred onto my master disk (it's a 12K-byte program with a 6K-byte overlay), I played around with it. It's got some nice features. For example, there's a kind of mini-monitor built into it. You invoke Power, and not only can you do all the usual CP/M things like TYPE and STAT and RENAME, but you can dump, display COM files as hexadecimal numbers with ASCII messages out to the side just as DDT (the CP/M debugger) does, fill memory, search memory (but alas not search files) for a given text pattern, set DIR and USER number and all that stuff, go to a certain memory location, load and execute programs at *any* memory location, etc.

In other words, the program overcomes some of the limitations of CP/M. Of course, many of those are limitations only to hackers; most users aren't terribly interested, especially at the memory cost Power exacts. You'll also pay another way:

Power lists the directory in two columns that aren't in alphabetical order, so that if you use double-sided double-density disks with lots of files on them, you'll go nuts trying to find the filename you're interested in. To compensate, though, Power will assign a number to each filename on the disk, and to copy a file, you only have to type its number, not type (or, as they say, mistype) the whole filename. The same is true when erasing something. The bad news is that you *must* use the menu number, and it probably scrolled off the top of the screen before you caught it.

Another feature of Power is that you can reclaim lost files; this is especially helpful if you've inadvertently typed "ERA *.BAS" when you meant "*.BAK". Power will get all those .BAS files back for you. Unfortunately, the documentation does not explain that large files may be reclaimed improperly under certain circumstances.

There are a lot of other features, including the ability to read and write to disk by sector and track, which means that if you knew what you were doing, you could use Power to recover files from disks with messed-up directories. Power also claims the ability to operate without having a system disk in either drive.

All in all, Power looks useful, and I'm glad I have it. I'm even gladder of Tony's XD and some of the Workman-CP/M Users' Group utilities. I'd probably be even gladder of Power if the documentation were a bit clearer, and I'd like a bit more explaining of what Power does and how it does it. I suspect Power is more useful to hackers than users. It's obvious the writers understand CP/M very well indeed; I wish they'd shared a bit more of their knowledge.

Again, LISP

We recently had our big L-5 Society Conference on Space Development here in Los Angeles, and two of our speakers were John McCarthy, who wrote LISP back in the fifties, and Marvin Minsky, who designed and built the LISP machines used at MIT. (Plug: help the space program. Join the L-5 Society. Send \$25 to L-5,

1060 E. Elm, Tucson, AZ 85719. Do it now. I'll wait.)

As I've noted before, LISP has become *the* language of the artificial-intelligence community. Moreover, a number of LISPerS have taken up my challenge and shown me all kinds of useful programs written in LISP: accounting programs, library programs, and the like, all with really good user features like self-prompting and error trapping. I confess I'm impressed with what you can do with the language.

Walt Bilofsky says LISP is the ideal breadboard language; once you know it, you can do things quickly and without fuss, as long as you're not after elegance. After all, no one complains if a breadboard layout has resistors sticking up in the air and cut traces.

I'm also impressed at the chaos you can create; LISP programmers really and truly do go around handing each other lines of code and saying gleefully "I bet you can't tell me what *that* does." But I've long since conceded

that if you're interested in artificial intelligence, you have to learn LISP, and if you expect to make a living in the computer world, you probably ought to avail yourself of any opportunity to learn LISP because there are some things you can do with it that you can't do elegantly in any other language.

Software Toolworks' LISP will let you play around with the language to find out if you're really interested.

The problem has been that there aren't many LISPs for microcomputers. That's still true, but I have received two more, one of which on first inspection may be the best of the microworld's LISPs, while the other is certainly the cheapest. The first is from Supersoft, and it looks to be more complete than the Microsoft LISP originally developed by the Soft

Warehouse. The Supersoft LISP resides partly in memory and partly on disk, using swapping overlays as needed. Obscure user-defined functions can be kept on disk, leaving lots of free memory.

This allows Supersoft LISP to have full recursion—that is, a function may call itself any number of times. (Well, I presume there is *some* limit, but it's a pretty big number.) Because recursion is a standard, indeed vital, LISP feature, this makes Supersoft LISP pretty powerful. Supersoft claims its LISP is a full MIT LISP 1.5 with extensions. Because I'm not a LISP hacker (although I am getting more and more interested in the crazy language), I can't verify that. I do know mine works. Some functions are a bit slow due to the need to call in overlays from the disk, but put all that on M-Drive or Semidisk, and it really wails.

The Supersoft documents are complete in that they describe each function in the language, but they're not very good. There's no index and no

FINALLY!

the magazine
that speaks your language

JOURNAL of
PASCAL and ADA

- Program design
- Graphics
- Applications
- New developments



"A help in any one area is worth the price."

No-Risk Trial Subscription Offer

1 Year (6 Issues) \$14.00 in U.S.A., \$21.00 Elsewhere

—Refund on Unused Portion—

VISA MasterCard American Express

Card No. _____ Exp. Date _____

Signature _____

Name _____

Street _____

City _____ State _____ Zip _____

Mail to: Journal of Pascal and Ada
P.O. Box 327 Payson, Utah 84651



CAN'T MAKE ENDS MEET?

We couldn't either. At least, not until 1978 when we began connecting RS-232 devices to IEEE-488 computers with our family of serial interfaces. Three units available for use with Commodore's PET/CBM, the HP-85, Osborne-1 and others, plus our auto-answer/auto-dial 103 Modem, automatic calling unit (Operator), and data communications software. All with cabinet, one-year warranty, documentation. Priced from \$129-389. Details from George Masters:



Dept. B., 3444 Hancock St., San Diego, CA 92110
(714) 296-2115 • TWX 910-335-1194
VISA/MasterCard • Dealer Inquiries Welcome

Would you help this kid?



When the dam broke at Buffalo Creek, West Virginia, a lot of people weren't as lucky as this little guy.

Jamie and the rest of the Mosley family made it up the hill just in the nick of time. Seconds later, a wall of water swept all their earthly possessions away.

Here you see Jamie in the Red Cross shelter, thinking it all over.

One look at that face, and we're awfully glad we were there to help.

Every year, you know, Red Cross touches the lives of millions upon millions of Americans. Rich. Poor. Average. Black. White. Christian and Jew. With support. With comfort. With a helping hand when they need it.

So when you open your heart, with your time or your money, you can be certain it's in the right place.



Items Reviewed

CB-80 (compiler version of CBASIC)		\$500
Digital Research POB 579 Pacific Grove, CA 93950 (408) 649-3896		
Power		\$149.95
Computing! 2519 Greenwich St. San Francisco, CA 94125 (800) 227-3800, operator 28		
LISP		\$39.95
The Software Toolworks 14478 Glorietta Dr. Sherman Oaks, CA 91423 (213) 986-4885		
LISP		
Supersoft	CP/M version	\$150
POB 1628	TRS-80 cassette version	\$75
Champaign, IL 61820	TRS-80 disk version	\$100
(217) 359-2112		
Pascal Introduction Package and Utility Disk Four		\$50
Workman and Associates		\$32.50
112 Marion Avenue Pasadena, CA 91106 (213) 796-4401		
Software Tools for CP/M		\$325
Unicorn Systems 30261 Palomares Road Castro Valley, CA 94720 (415) 881-4490		
Semidisk		
Semidisk Systems	512K bytes	\$1995
POB GG	1 megabyte	\$2995
Beaverton, OR 97075	manual only	\$10
(503) 642-3100		
WRITE (Writers' Really Incredible Text Editor)		\$395
Ashton-Tate 9929 Jefferson Ave. Los Angeles, CA 90230 (213) 204-5570		

Books Reviewed

Software Tools		\$14.95
Brian W. Kernighan and P. J. Plauger Reading, MA: Addison-Wesley Publishing Company, 1976		
Software Tools in Pascal		\$15.95
Brian W. Kernighan and P. J. Plauger Reading, MA: Addison-Wesley Publishing Company, 1981 (617) 944-3700		

real explanation of what LISP is; to learn the language you'll need a lot more than Supersoft furnishes. Some of the discussions are completely opaque. On the other hand, I'm not convinced you can learn LISP from books anyway; I think you need tutorial help.

Supersoft furnishes everything you'll need, like a tracer. The hooks into CP/M are reasonable, or at least not unreasonable. (But there's no implementation of a random-access file; you'd have to write that in LISP yourself.) Again I emphasize that you'd better know what you're doing

because the explanations on using LISP with CP/M are terse beyond belief. Ditto for the section on "Machine Representation of LISP Objects." I expect it all makes very good sense to Minsky and McCarthy, and indeed every now and then I understand a line or two; but one should read this manual with a book like Winston and Horn (Patrick Henry Winston and Berthold Klaus Paul Horn, *LISP*, Addison-Wesley, 1981) firmly in hand.

With that warning, I can recommend Supersoft LISP.

If you just want to get a feel for the language, you can try Software Toolworks' LISP at \$39.95 for either Osborne 1 or any 8-inch CP/M system. This one was written in C and is somewhat slow, but it is fairly complete. The documents are better than Supersoft's. Software Toolworks' LISP will let you play around with the language to find out if you're really interested. How can you pass it up at the price?

Immortal Paperwork

I often get letters asking why I haven't reviewed one product or another. Often the suggestions are very helpful. But, there's a ton of software around here; lately everyone has been sending me stuff to review. I'm very grateful, but I do sometimes feel guilty about not getting to everything as quickly as I should.

One difficulty is that I have had two systems: a Z80 running CP/M 1.4 and an 8085/8088 running CP/M 2.2. But people kept sending me software that requires a Z80 running CP/M 2.2. Eventually I solved that problem: I got another computer. Next week we'll set up a Z80 running CP/M 2.x, and we'll reduce the size of that pile of unreviewed software that menaces me from the corner. We'll also be able to install Semidisk, which just arrived.

Meanwhile, I'm working on not one but *two* computer books. One will be in loose-leaf format and contain all my back columns (updated and revised as necessary) plus my fulminations about famous brand-name equipment, what hardware I *really*

can't stand, and random walks around Chaos Manor—in other words, much like these columns. Since it will be topical, it'll probably need revising fairly often. That means small print runs, so that (1) the price will have to be outrageous, around \$18 postpaid, and (2) I will want to keep it close to me and under control, so I'll let Barry Workman handle it. It may even be available by the time you read this. The other book is for a major publisher to be pitched at a mass market; BYTE readers may find it interesting, but you'll be more likely to give it to someone who asks you

about computers (at least I hope you'll want to do that).

So, what with the books, getting the new Z80 system running, the pressure of being chairman of the Citizen's Advisory Council on National Space Policy, finishing *Janissaries II: Clan and Crown*, and working with my partner Larry Niven to finish *Footfall* by next spring, it's amazing I get these columns written at all. But I do thank everyone for letters and suggestions, and I try to answer as much of my mail as I can. If I owe you a letter, please have pity. ■

COMPUTER FORMS

AND SUPPLIES

WE SUPPORT MORE SYSTEMS WITH FORMS THAN ANYONE!

INVOICES • STATEMENTS • CHECKS • P.O.'s • SHIPPERS • MEDICAL FORMS

Accounting Plus • AlphaMicro • Apple Computer • BPI Systems • Broderbund • CAD0 • Centurion/Warex/EDS • Cimarron • Compumax Associates • Continental Software • D.B. Software • Dakin-5 • Data Train • Denver Software Company • Designer Software • Digilog • Durango • Datamost • Dynabyte • IBM 5120 • IBM Sys 32/34 • IMS • Insoft • LIBRA • MCBA • NEC • Northstar • Open Systems • Osborne • Peachtree • R & B Systems • Radio Shack • Rocky Mountain Software • Serendipity • Shasta • (SSG) • Systems Plus • Taranto • TCS • The Bottom Shelf • Van Data • Vector Graphic • Wang

WE SUPPORT 170 SYSTEMS NOT LISTED HERE, SO IF YOU DON'T SEE YOUR SOFTWARE HERE CALL TOLL FREE FOR A FREE SAMPLE PACKET OF FORMS FOR YOUR SOFTWARE.

WORD PROCESSING LETTERHEAD

SHEER CUT LETTERHEAD FROM CHECKS TO-GO USES A NEW PROCESS TO PRODUCE CONTINUOUS FORM PAPER THAT TRIMS CLEAN WHEN BURST. NORMAL COMPUTER PAPER USES FIVE PERFORATIONS PER INCH, BUT SHEER CUT USES A NEW TECHNOLOGY TO PRODUCE 80 PERFS OR "TIES" PER INCH. THIS PRODUCES A VERY CLEAN AND UNIFORM EDGE WHEN BURST, AND IS ECONOMICAL IN BOTH SMALL AND LARGE QUANTITIES. SHEER CUT IS AVAILABLE ON A STOCK FORM BASIS IN FOUR "CLASSIC LAID" PAPERS, OR IN ANY TYPE PAPER ON A CUSTOM ORDER. EVERY OTHER FORM CAN BE IMPRINTED TO PRODUCE CONTINUOUS FIRST AND SECOND SHEETS. BLANK PRICES ARE \$60 FOR 1,000, \$235 FOR 5,000 AND \$400 FOR 10,000, WITH IMPRINTING, DEALER, AND VOLUME PRICING AVAILABLE.

W-2 MONTH

30% discount good on any order of W-2's paid for by August 31, 1982.

Continuous and snap-out forms available.

CALL FOR FREE 1982 TAX FORMS CATALOG!

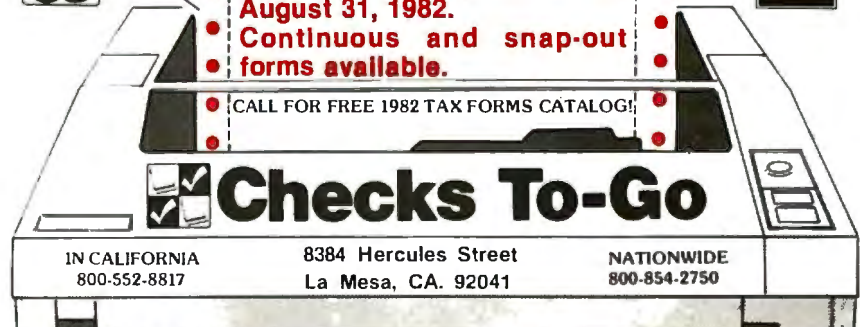

Checks To-Go

IN CALIFORNIA
800-552-8817

8384 Hercules Street
La Mesa, CA. 92041

NATIONWIDE
800-854-2750

CALL TOLL FREE: (800) 854-2750 IN CA (800) 552-8817

QUADBOARD™

THE FIRST AND ONLY BOARD YOUR IBM PC MAY EVER NEED.

Your IBM personal computer is a very versatile piece of equipment. Perhaps more versatile than you realize. New applications and functions are being developed every day. Now with Quadboard

by Quadram you can keep your options open for tomorrow's technology. Following in the tradition of Quadram Quality, four of Quadram's best selling IBM boards have been combined into one board. Your remaining slots will be left free and available to accommodate future expansion needs and uses which you may not even be able to contemplate today.

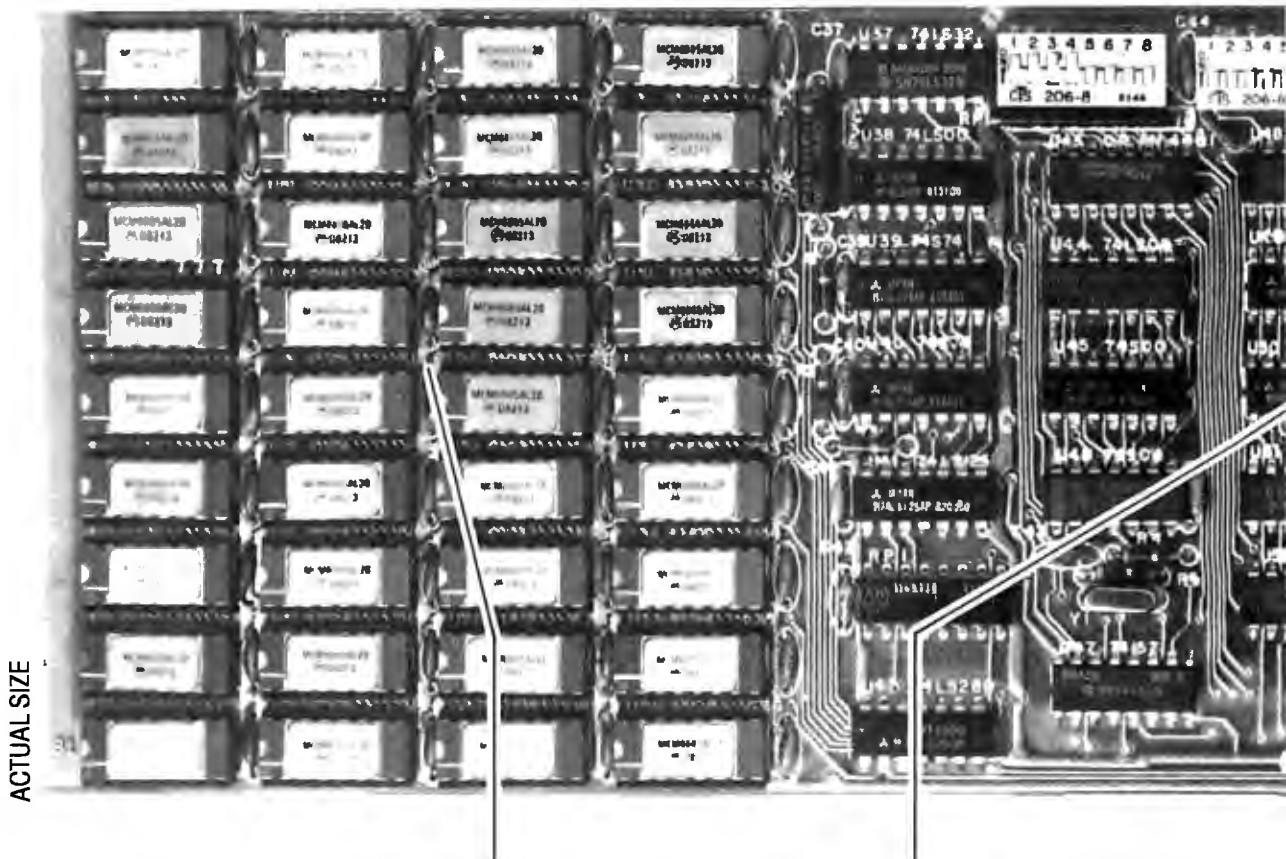

PROVEN DESIGN.

Quadram has been shipping IBM boards with each of the Quadboard functions on separate boards since December, 1981. They are still available as separates (including a Dual Port Async Board) for those who desire a quality board but do not need to keep slots open for future expansion. And they all come with a one year warranty from the leader in technology applications.

256K MEMORY EXPANSION.

Socketed and expandable in 64K increments to 256K, full parity generation and checking are standard. A Quadboard exclusive feature allows parity to be switch disabled to avoid lock-up upon error detection. The dip switches also allow it to be addressed starting on any 64K block so that it takes up only as much as it has memory installed. Memory access and cycle time naturally meet all IBM specifications.

CLOCK/CALENDAR.

Quadboard eliminates the hassle of manually inputting the date on system boot-up by providing for the clock and all software routines necessary for inserting the appropriate programs on your diskettes. The internal computer clock is automatically set for compatibility with most software routines which utilize clock functions. On-board battery keeps the clock running when the computer is off.

BY QUADRAM

ALL ON ONE BOARD

Now you can utilize all the PC's capacity with Quadram's extremely flexible configurations. And it's totally compatible with IBM hardware, operating systems, and high level languages. It's a full-size board that can be inserted into any free system slot and it even includes a card edge guide for securely mounting the card in place.

INCREDIBLE PRICE!

Priced at \$595 with 64K installed, \$795 with 128K, \$895 with 192K and an unbelievable \$995 fully populated with 256K. Quadboard! You pay less for more and still protect the few limited empty slots in your computer.

\$595
with 64K
installed

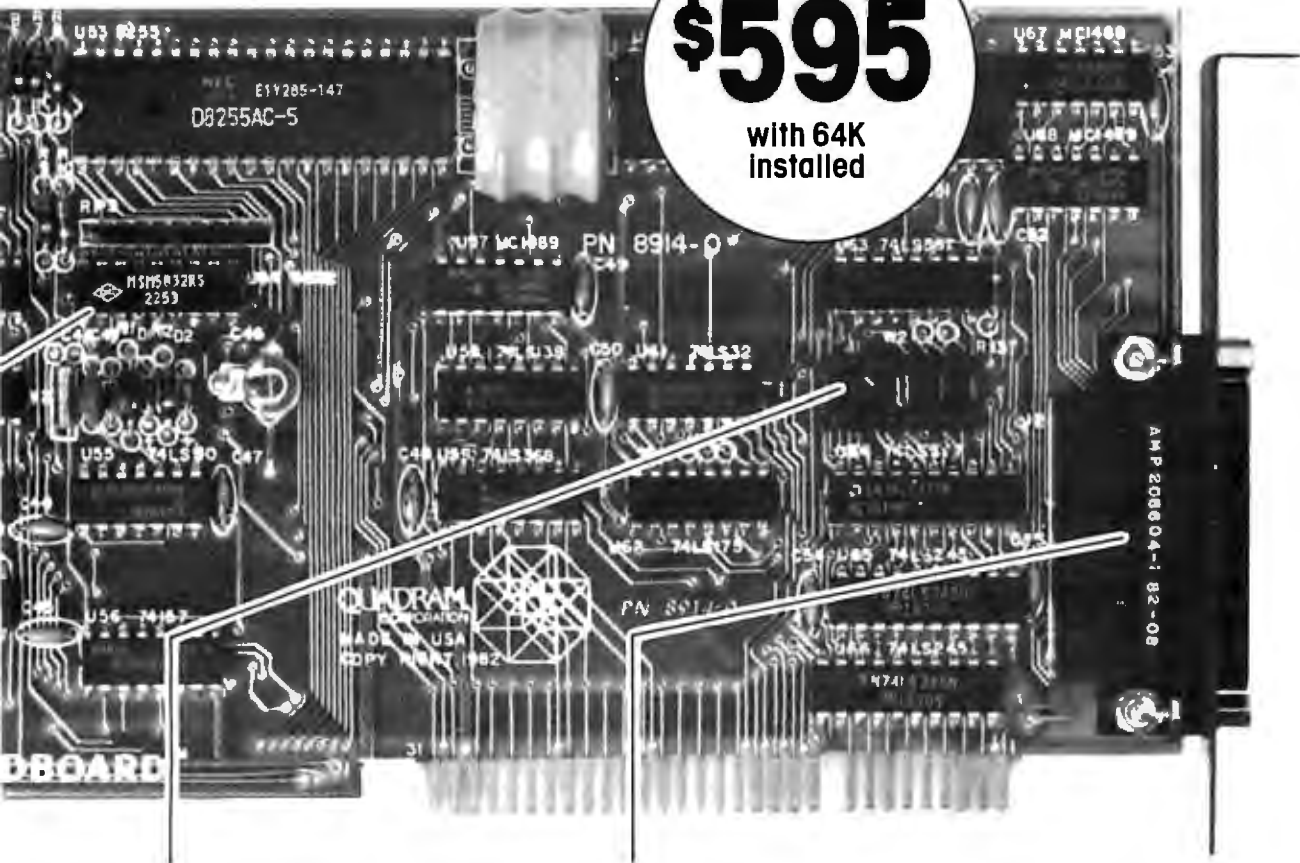

PARALLEL PRINTER I/O.

A 16 pin header on Quadboard is used for inserting a short cable containing a standard DB25 connector. The connector is then mounted in the knock-out hole located in the center of the PC back-plane. The parallel port can be switch disabled or addressed as Printer 1 or 2. No conflict exists with the standard parallel port on the Monochrome board. The internal cable, connector and hardware are all included.

ASYNCHRONOUS (RS232) COMMUNICATION ADAPTER.

Using the same chip as that on the IBM ASYNC board, the device is software programmable for baud rate, character, stop, and parity bits. A male DB25 connector located on the back connector is identical to that on the IBM Async Adapter. The adapter is used for connecting modems, printers (many letter quality printers require RS232), and other serial devices. Switches allow the port to be configured as COM1 or COM2 and the board fully supports IBM Communications Software.

AVAILABLE NOW!

Quadram does not advertise products until shipments have begun. Count on it. But order today for immediate delivery.

ASK YOUR DEALER.

All products are sold through local personal computer dealers. If yours does not stock Quadram, please ask him to call us at (404) 923-6666.

QUADRAM
CORPORATION

Circle 341 on inquiry card.

4357 Park Drive / Norcross, Ga. 30093

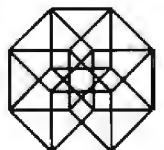

The Commodore 8032 Business System

Harold Dickerman
POB 355
Sharon, MA 02067

Commodore has introduced a new microcomputer for the small-business market: the Model 8032. Inside the 8032 is a new operating system that makes up for some of the deficiencies of Commodore's old operating systems. Also available is a version of this new operating system for Commodore's older machines.

Commodore has also upgraded its dual floppy-disk system, now called the 4040. It is used with an improved disk operating system (DOS), which is more reliable and can now randomly access disk files. Commodore has also released the 8050, a dual 5¼-inch floppy-disk-drive system with 500K bytes of storage per drive. Although the 8050 drives are single-sided, they allow double density and 96 tracks per inch. The disk operating systems for the 4040 and the 8050 are similar and the commands are basically the same. Any comment about the 4040 is usually applicable to the 8050 as well.

The release of this new equipment is accompanied with new software that makes this Commodore Business Machine (CBM) truly a professional piece of equipment. With a combination of software packages (not produced by Commodore), this microcomputer system will find its way into both small and large businesses.

New System Features

First, a look at the 8032. Its new 80-column, 12-inch video screen is the most obvious difference from Commodore's other systems. As before, the system's cabinet is

a one-piece housing for the main logic assembly (the circuit board on which the system is built), power supply, video display, and keyboard. The clean design makes the system aesthetically suited for residence in an office.

The main logic assembly runs the depth of the cabinet, with the power supply at the back left corner and the video circuitry mounted above. Heated air is allowed to rise upward, out of the cabinet, while cooler air enters through the bottom; a fan is unnecessary.

All interface circuitry is built into the system. It is accessible by way of three edge-card connectors at the back of the cabinet. This includes the famed IEEE-488 interface that allows the computer to control test equipment (among other things), the user parallel port, and one of two cassette ports. The memory-expansion port can be accessed through an opening in the side of the machine.

One of the features for which the old PET microcomputer was known was its real-time clock; thankfully, this feature is included with the 8032. For high-level-language use, this 24-hour clock reads out hours, minutes, seconds, and "jiffies" (sixtieths of a second). Through machine language, resolution down to 1 millisecond is available, making the system suitable as an instrumentation controller. Software has eliminated keyboard bounce. Of course, the 8032 has the unique CBM graphics characters and standard uppercase and lowercase letters.

The most dramatic improvement is in the video circuitry. Because the number of characters on the

SUPER-WAND

A FULL COLOR GRAPHIC LIGHTPEN SYSTEM FOR THE APPLE

THE FACTS:

1. The Best Low Resolution Lightpen on the Market
2. Complete Demo Program Standard
3. Store to Disk/Recall from Disk, Any Picture Any Time
4. Hard Copy Printout Using ASCII Characters to Represent Colors
5. Keyboard Color Editor Standard — Erase or Change Any Color Any Time
6. Easy to Understand User Prompts
7. Extensive Professionally Written User's Guide and Quick Reference Card for All Keypress Commands
8. 30-Day Warranty
9. You get Lightpen, Disk and User's Guide
10. Will work on either Black and White or Color Monitors/TV Sets



THE NEEDS:

1. Apple II or Apple II+
2. Firmware Applesoft and 20K or Language Card (48K)
3. Interger Version Available (20K)
4. 1 Disk Drive
5. (Optional) 80 Column ASCII Printer

INSTASORT

THE MOST VERSATILE, POWERFUL SORT PROGRAM FOR MICRO'S — PRICED UNDER \$100⁰⁰

I. CAPABILITIES

- A. Create user defined file formats consisting of records up to 128 characters long. Will allow up to 1000 records per file.
- B. Allows user to select up to 7 keys from fields within the record, thereby automatically sorting the file in 7 different ways.
- C. Single item search on any key.
- D. Partial listing of file according to any key in either ascending or descending order.
- E. Complete list of file according to any key in either ascending or descending order. This means the capability to do 14 different listings of the same file — 28 different listings if you include the partial listing capabilities.
- F. Allows correction of records, addition and deletion of records.
- G. Allows limited arithmetic manipulation (Addition & Subtraction) of selected numeric fields.
- H. Allows user to merge separate but identically formatted files to form a single file of up to 1000 records.
- I. Allows complete listing of file in the original order.
- J. Multiple nested key searches
- K. Complete Professional written User Guide included.

II. HARDWARE LIMITATIONS

- A. Requires minimum of 48K main memory.
- B. Requires 2 disk drives (500 records max. [single density]; 1,000 records max [double density])
- C. CP/M Operating System

III. SOFTWARE LIMITATIONS

- A. Maximum of 1000 records per file.
- B. Limited Arithmetic operations.
- C. No more than 7 keys all of which must be complete fields (no possibility of splitting keys into smaller fields for use as a key).



	PRICE	QUANTITY	AMOUNT
SUPER-WAND	\$88.00		
INSTASORT	\$95.00		
Shipping and Handling			\$4.95
TOTAL			

ORDER TODAY!

MAIL TO:

Data-Rite Industries, Inc.
P. O. Box 976, Spokane, WA 99210
Include Check or Money Order
Payable to Data-Rite Industries, Inc.

OR CALL:

Data-Rite Industries, Inc.
Inside Wash. (509) 455-9147
Outside Wash. 1-800-541-9001
Visa or Master Card
accepted on Phone Orders

NAME _____

ADDRESS _____

CITY/STATE/ZIP _____

80-column screen is double that of the old 40-column display (expanding the video buffer to 2K bytes), the time needed to perform screen-oriented functions (clearing the screen, scrolling, etc.) would be increased. However, the display is now controlled by a 6845 integrated circuit that frees the microprocessor from having to perform display functions. It also provides extra spacing between lines of text. Descenders on one line no longer touch the ascenders of the line below. By changing to the graphic mode, lowercase and uppercase characters are replaced by uppercase and graphics characters, respectively, and the extra spacing between lines is removed.

Turning on the system or moving the cursor past the seventy-fifth column rings the system's bell. The speaker

(actually a piezoelectric transducer) is connected to the CB2 line of the parallel port. Since this is the same line often used to create sound effects, these sounds can now be heard through the bell without an audio amplifier. The bell also rings when the ASCII bell code is printed.

New Software

To accompany the hardware modifications, Commodore has updated the operating system to version 4.0 in a way that complements the DOS. It now includes a new screen-oriented text editor, commands to simplify disk operations, and better string handling. Because the major change in this operating system is the addition of disk commands, the new version of BASIC is known as Disk BASIC (see the text box "A Quick Reference"). Notice that the new commands only make it easier to perform disk functions—they do not add any new features. The system defaults to device number 8, drive 0 (if this default can be changed, it is not documented).

To make these features available on older 16K- and 32K-byte CBM computers (those using version 3.0 BASIC), Commodore has released a version 4.0 read-only memory (ROM) upgrade. This will give the user all the enhanced commands, but not an 80-column screen. One catch is that the RECORD command (for random-access disk files) can only be used with DOS 2.1 and a 4040 floppy-disk-drive subsystem.

The disk commands are not the only change to BASIC, however. One other improvement is the string handling. When a string variable is used in a BASIC program, the BASIC interpreter sets aside memory space. As the string is reused, BASIC abandons the space and finds a new place in memory for the string's contents. Eventually, when all the free memory is used, the interpreter must collect and reuse the abandoned memory.

Garbage collection, as it is called, is also done when the system is asked to count the free memory locations. While garbage collection is going on, the system will not respond to the user. It therefore appears "dead" until the collection is done. The new version of the software does garbage collection in much less time. A collection that formerly might have taken as long as 21 minutes now takes only 0.64 seconds.

Commodore has also added disk-status flags to the new software. These special variables, DS and DS\$, contain the status of the last disk operation and disk error. Without these, it would be necessary for the user to write a three-line program to determine the nature of a disk error.

Three other improvements have been made:

- when sending data to a device via the IEEE-488 interface, the system will send only a carriage-return character; it will not be followed by a linefeed character
- it is now possible to append data to an existing disk file
- if the input string from a device is more than 80 characters long, the system will generate a trappable error with the message "?string too long error"

At a Glance

Name

CBM 8032 computer system

Manufacturer

Commodore Business Machines
Computer Systems Division
The Meadows
487 Devon Park Dr.
Wayne, PA 19087
(215) 687-9750

Price

\$2829.95 (suggested retail) including all required cables

Dimensions

Computer: 35.5 by 41.5 by 46.5 cm, 22.5 kg (14 by 16.5 by 18.5 inches, 50 lbs)
Disk drive: 16.5 by 38 by 36 cm, 12.5 kg (6.5 by 15 by 14.35 inches, 28 lbs)

Description

CBM 8032 computer: 6502 MOS Technology microprocessor, 73-key business-style keyboard, 12-inch green-phosphor display (80 characters by 25 lines, 2000 characters, 8 by 8 dot-matrix characters), IEEE-488 bus, 8-bit bidirectional parallel port, and two Commodore cassette ports included. 3-MHz system clock. 32K bytes (1K used for operating system overhead) plus 2K-byte screen buffer
4040 dual disk drive: Shugart 5¼-inch floppy-disk drives, single-sided, single-density, 174,848 bytes unformatted, 168,656 bytes formatted, 144 file entries per disk
Controller: 6504 microprocessor
Interface: 6502 microprocessor
Disk buffer: 4K bytes
CBM operating system included with 8032 computer: Microsoft BASIC, screen editor, and built-in IEEE-488 and disk commands (18K ROM)
Disk operating system included with 4040 disk drive: Program load and save; sequential; User, Relative, and Program files; file utilities [Copy, Rename, Scratch, Duplicate, New disk]; Disk Directory; and Error Recovery

Software

Business software available (also see the Commodore Software Encyclopedia): Wordpro 4 Plus (word processing—Professional Software Inc.), Visicalc (electronic blackboard—Visicorp), The Manager (database—Canadian Micro Distributors), BPI, and CMS accounting software

Audience

This system is well suited for use in a modern office environment, as well as educational institutions and other business applications

16 Bit 8086 Multi-User Microcomputer System

FOR **MP/M-86™**

\$7595
FOUR
USER
SYSTEM

ONLY
\$1899*
PER
USER



THE
TEC 86M

1/2 MEGABYTE
OF MEMORY
TWO 8 INCH D.O.
FLOPPY DISKS

STANDARD FEATURES

- 16 BIT 8086 CPU** - Processor performance is the most critical element in a Multi-User System. Speed, power and the increased throughput of our 16 Bit 8086 CPU are just a few of the reasons why our TEC 86M Multi-User Systems really perform.
- 1/2 MEGABYTE OF MEMORY** - The second most important factor which affects system performance is available user memory. Our 1/2 Megabyte, four user system gives each user well over 100K Bytes of memory, eliminating program size compromises which lead to poor Multi-User system performance.
- MP/M-86™ COMPATIBILITY** - The TEC 86M includes a ROM Boot for MP/M-86™ and is designed to provide optimal support for MP/M-86™. The MP/M-86™ Operating System is available separately from Tecmar for \$600. See Software Options listed below for important MP/M-86™ features.
- FULLY INTERRUPT DRIVEN** - The TEC 86M provides terminal and disk I/O interrupts to MP/M-86™, allowing for maximum system performance in Multi-User operation.
- TWO 8 INCH DOUBLE DENSITY FLOPPY DISK DRIVES** - The two Double Density floppy disks total 1.2 Megabytes of storage. Options include double sided floppy disk drives and Winchester drives.
- FOUR SERIAL USER PORTS** - Four serial user ports are provided. Each port can be independently set for speeds from 50 to 19200 Baud.
- MULTIPLE PARALLEL PORTS** - Parallel ports are provided for operating printers as well as other parallel devices.
- EASILY EXPANDABLE** - The modular design of the Tec 86 and Tec 86M assures you of continued system expandability. All options are easily field installable. Available options include: Memory 64K and 256K, additional users, double sided floppy disks, Winchester 31 Megabyte hard disk, terminals, and printers.
- ATTRACTIVE DESKTOP ENCLOSURE** - Tecmar Single and Multi-User systems come in your choice of an attractive desk top enclosure with wood grained side panels to blend nicely into your office surroundings, or an industrial quality cabinet for more hostile environments. Rack mount enclosures are available as options.
- ONE YEAR WARRANTY** - Tecmar Systems are fully assembled and thoroughly tested. All Tecmar Components carry a full One Year Warranty.

SOFTWARE OPTIONS

- MP/M-86™** - Multi-User interrupt driven Operating System for the 16 Bit 8086 TEC 86M Microcomputer System.
- FILE PASSWORD PROTECTION** - Access to user files can be restricted to require proper passwords prior to access.
- CONCURRENT FILE ACCESS** - Files may be accessed by multiple users, each reading and/or writing the same file, with protection provided at both the file and the record level.
- FILE TIME AND DATE STAMPING** - Files contain creation, and modification Times and Dates for ease and accuracy in determining the latest or most useful file versions.
- PRINT SPOOLER** - Files may be submitted to the System Spool file for printing. This frees the user terminal to continue operation during the independent printing function.
- LANGUAGES** - BASIC-86™ FORTRAN-86™ PASCAL-86™ CBASIC/86™ CIS-COBOL™ PASCAL/M86™ FORTH
*NOT INCLUDING MP/M-86 and User Terminals.

OTHER FINE \$100 and APPLE PRODUCTS AVAILABLE, INCLUDING:

- ANALOG to DIGITAL CONVERTERS** (12, 14, 16 bit accuracy; 30, 40, 100, 125 KHz Conversion rates; 16 to 256 Channels; programmable gain; timer/counters).
- DIGITAL to ANALOG CONVERTERS** (12 bit accuracy, 3 microsecond conversion rate).
- 8086 CPU Board, I/O Boards
- 64K/256K Memory Boards, Real-time Video Digitizer and Display.
- Complete Systems also available for Data Acquisition, Video Digitization, and General Purpose Applications.

REQUEST OUR CATALOG FOR COMPLETE LISTING, AND SPECIFICATIONS ON THE ENTIRE TECMAR PRODUCT LINE.



TECMAR
INC.

DEALER INQUIRIES INVITED

23600 Mercantile Rd. • Cleveland, OH 44122

TECMAR, INC.

(216) 464-7410

CP/M-86 and MP/M-86 are registered trademarks of Digital Research Inc. BASIC-86, FORTRAN-86 and PASCAL-86 are registered trademarks of Microsoft Inc. PASCAL/M86 is a registered trademark of SORDIM. CBASIC/86 is a registered trademark of Computer Systems Inc. CIS-COBOL is a registered trademark of Microfocus Inc.
CANADA: Our Ontario Distributor is OCTANT COMPUTER SERVICES INC., 146 Front Street West, Suite 485, Toronto, Ontario M5J 2L7 (416) 598-1046

This 80-character limitation becomes apparent during disk-file operations. Although a record written to disk can be as long as 254 characters, and a string can be as long as 255 characters, any record that is more than 80 characters long must be accessed one character at a time, using the GET# command.

Better Editor

Although the editor has been improved, its operation is still the same. To change a line in a program, merely move the cursor to where the corrections are to be made, make the corrections (insert, delete, etc.), and push Return. The corrected line is entered as if you had re-typed the whole thing.

What makes the editor so easy to use are the keys designated to perform each of the cursor movements, insertions, and deletions. Whole sections of programs can be copied from one program to another by listing the lines to be transferred on the screen, calling in the new program (which clears out the old one), moving the cursor to the start of the lines to be transferred, and pressing return for every line. The cursor does not have to be moved over each line, nor even moved to the end of each line. It is as simple as that and saves a lot of typing.

Special characters have been added to the screen editor that perform functions by using the video controller. (I've found that the graphics characters can be accessed from

the keyboard if the 2 key is hit while pressing both shift keys.) The screen can now be scrolled up or down just by printing a special character; whole lines can be inserted or deleted, a line can be cleared to its end from any position, or from its beginning to any position.

Two of the special characters define the upper-left and lower-right corners of a *scrolling window*—a portion of the screen in which the movement of the cursor is restricted to preset boundaries. For instance, if you wanted to simulate the older 40-column screen, you could set one special character at the top of the screen, indented 20 spaces; the second special character would be indented 60 spaces on the bottom line. The cursor movement would then be restricted to this area.

This is also useful for defining split screens to display information. The information will scroll in the window, leaving the rest of the screen untouched, no matter where on the screen the window is defined. Normally, when the computer is turned on, the entire screen is the scrolling window.

One problem occurs if tabs are used in the program. The tabs are always computed from column 1 regardless of the scrolling window. If the tab is before or beyond the scrolling window, the cursor will be placed on the nearest edge within the scrolling window. The window is cleared simply by printing the ASCII Home character or pressing the Home key twice. A complete list of special screen-

A Quick Reference

DOS 1.0 is the operating system of a 2040. DOS 2.1 is the operating system of a 4040. DOS 2.1 can read a DOS 1.0 disk and DOS 1.0 can read a DOS 2.1 disk; however, neither should write on a disk formatted by the other.

New Disk BASIC Commands	Operation	See Notes
DSAVE	Saves current program in memory on disk	1
DLOAD	Loads specified program into memory	
CATALOG	Lists the programs stored on the disk	
DIRECTORY	Same as CATALOG	
SCRATCH	Scratches specified program from disk	1,2
RENAME	Renames a file on disk	1
CONCAT	Concatenates two files	1
COPY	Copies specified file on disk	3
BACKUP	Track-to-track duplication from one disk to another	1
COLLECT	Collects disk space from unclosed files and verifies disk	1
HEADER	Formats a new disk for file storage	2
DOPEN	Opens a disk data file	1
DCLOSE	Closes a disk data file	1
APPEND	Opens old disk file to append additional data	1
RECORD	Specifies what record in a file will be read or written	4

Note 1: These commands cannot be used with DOS 2.1 with a disk that has been formatted with DOS 1.0 because they perform write functions and cause the "72,cbm v2 dos error."

Note 2: These commands will ask, "ARE YOU SURE?" A response of "Y" or "YES" to this will then perform the desired function.

Note 3: COPY can copy all the files on one disk to another. Use COPY to convert DOS 1.0 disks to DOS 2.1.

Note 4: This command (as well as some versions of DOPEN and COPY) will not work with DOS 1.0.

Continued on page 372

The MICROMINT Z8 BASIC COMPUTER/CONTROLLER board represents a milestone in microcomputer price-performance. It is cheap enough to be programmed directly in a high level language, and efficient enough to be battery operated if required. The entire computer is 4" by 4½" and includes a tiny BASIC interpreter, 4K bytes of program memory, one RS-232 serial port and two parallel ports, plus a variety of other features. Using a powerful Z8 microcomputer chip and Z6132 4K X 8 RAM, the Z8 BASIC COMPUTER/CONTROLLER board is completely self-contained and optimized for use as a dedicated controller. The unit is assembled and tested and comes with over 200 pages of documentation.

The price, in single quantity, a tiny \$195.*

Optional power supply (+5, +12 and -12V) \$35.

Please include \$4 for shipping and handling.

*Call Micromint for quantity pricing

Z8 MICROCOMPUTER

- On board tiny BASIC interpreter.
- Parallel and serial I/O ports.
- 6 interrupts.

RS-232 CONNECTOR

- Just attach a CRT terminal and immediately write control programs in BASIC.

4K BYTES OF RAM

- Z6132 4K X 8 low power quasi-static RAM. EPROM pin compatible.

SWITCH SELECTABLE BAUD RATES

- 110-9600 BPS.

FULLY EXPANDABLE

- Data and address buses available for 124K memory and I/O expansion.
- 2 onboard parallel ports.
- 7.3728MHZ crystal for fast control operations.

JUMPER SELECTABLE MEMORY OPTIONS

- 4K RAM, 2716 or 2732 EPROM operation.

LOW POWER

- Consumes only 1½ WATTS at +5, +12 and -12V (optional power supply available).

To Order:

Call Toll Free
1-800-645-3479

For Information Call
1-516-374-6793

MICROMINT INC.

917 Midway
Woodmere, N.Y. 11598

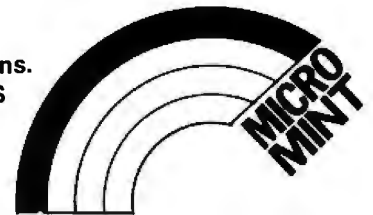

Micromint will put both a computer development system and an OEM dedicated controller in the palm of your hand for only \$195.

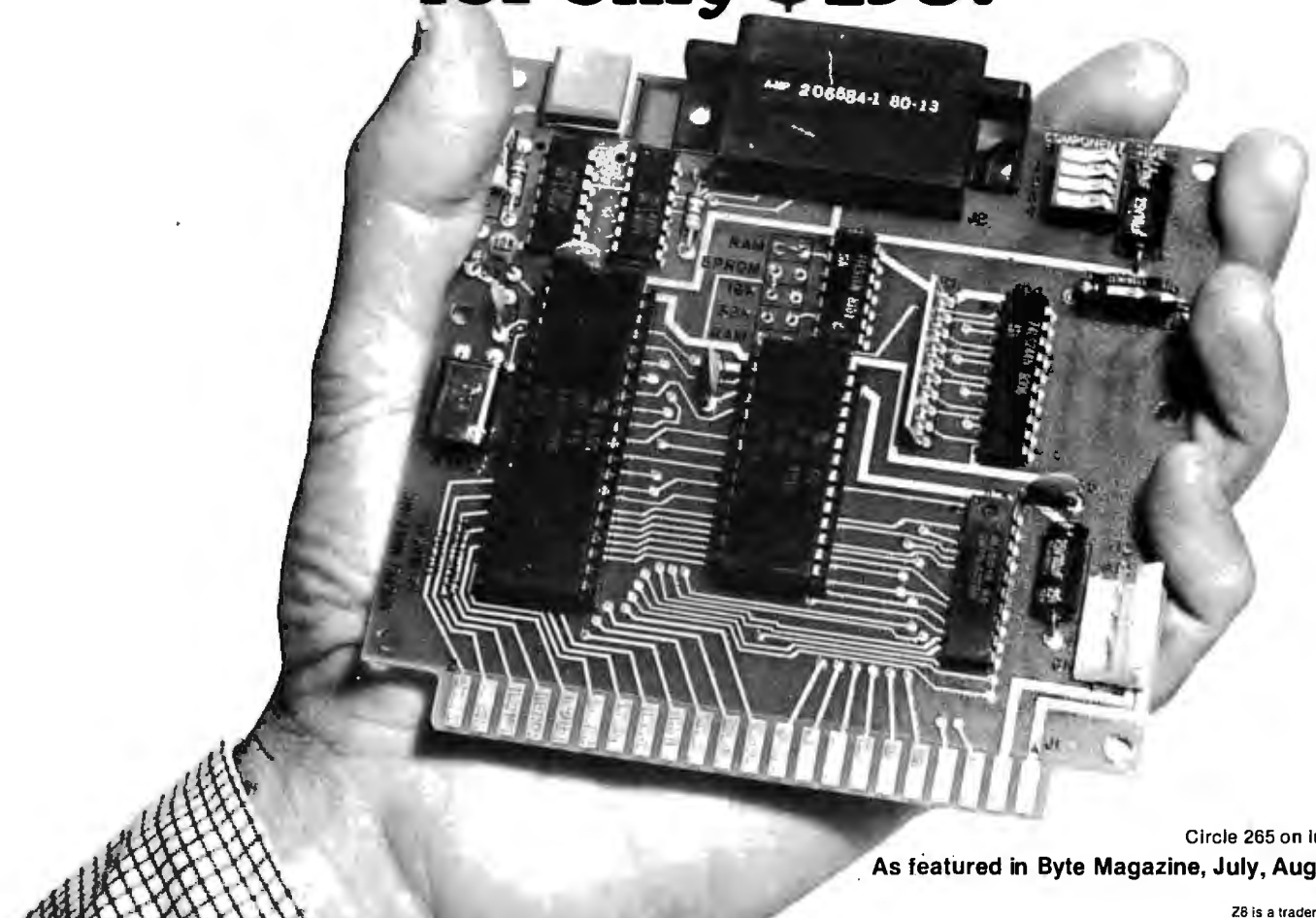

Circle 265 on Inquiry card.

As featured in Byte Magazine, July, August, 1981.

Z8 is a trademark of Zilog Inc.

Continued from page 370:

Screen-Control Function	Description	Decimal ASCII Code	Equivalent Control Character
BELL	Sounds bell for 1/4 second	7	g
TEXT MODE	Sets TEXT mode (uppercase/lowercase and extra spaces)	14	n
SET TOP	Sets top left of scrolling window at position	15	o
DELETE LINE	Deletes current line and scrolls screen up one line	21	u
ERASE TO END	Erases from current position to end of line	22	v
SCROLL UP	Scrolls screen up from bottom, top line lost	25	y
GRAPHIC MODE	Sets GRAPHIC mode (uppercase/graphic no space)	142	N
SET BOTTOM	Sets bottom right of scrolling window at position	143	O
INSERT LINE	Inserts a line at current position, scrolls down	149	U
ERASE BEGINNING	Erases from start of line to current position	150	V
SCROLL DOWN	Scrolls screen down from top, bottom line lost	153	Y

Poking a 12 or 14 to location 59468 will not change the line spacing between lines. A function's code and inverse (i.e., DELETE LINE versus INSERT LINE or SCROLL UP versus SCROLL DOWN) are 128 apart (i.e., 21 (DELETE LINE) + 128 = 149 (INSERT LINE))

Further Notes (Some known bugs in the disk operating system)

1. Sometimes when the pointer is moved from the middle of one record, it does not go to the beginning of the next record as it should. The RECORD command should be used to position the pointer before each I/O to the file.
2. The save and replace also found in DOS 1.0 has not been corrected.
3. When DS is less than 20 (but greater than 1), D\$\$ is blank.
4. Opening a data file without specifying the drive number causes a "FILE TYPE MISMATCH ERROR" by the DOS (this is taken care of in Disk BASIC).
5. The BLOCK-ALLOCATE command does not function properly.
6. The pattern matching with trailing '?'s does not match properly. "A???" will match the file "A", "AA", "AAA", or "AAAA", but not "AAAAA".
7. The D\$ variable does not always match the ST variable after a disk operation.
8. SCRATCH will not remove a recently used data file because it finds that was used and believes that the file is still open.
9. The work-space buffers are not reclaimed when a disk file is not properly closed.
10. Scratching an open file will give the file a "DELETED" file type in the directory and garbles D\$\$.
11. Relative files cannot be copied with the COPY command. They must be rewritten or the disk they are on must be duplicated (backed up).
12. When drive 1 is automatically initialized, D\$\$ becomes incorrect.

CROSS REF. PROGRAM

for MBASIC & BASCOM Source Files M80 and CP/M's ASM

MXREF will list all program variables, functions, key words, strings, constants and line number references in alphabetical order. 1000 variable names allowed. Requires an 8080 or Z80 running CP/M ver. 1.4 or later and at least 48K RAM. Price \$96.00. Manual only \$15.00. Add \$5.00 COD. MXREF available in CP/M format on 5" NorthStar or 8" single or double density soft sector.

COMPUTER TOOLBOX INC.
1325 East Main St.
Waterbury, CT. 06705
(203) 754-4197

Circle 104 on inquiry card.

ATARI*

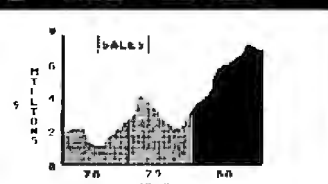

GRAPHICS HARD COPY

Dumps anything on screen of ATARI 400/800 to printer. All graphics and text modes. Players/Missiles, scaling, spy scale, GTIA/more! Works with EPSON, Centronics 739, IDS and Trendcom.

*ATARI is a registered trademark of ATARI Computer Inc.



See Jan 82 COMPUTE! for review
(209) 667-2888/634-8888

MACROTRONICS, Inc.
1125 N. Golden State Blvd.
Turlock, California 95380



Circle 242 on Inquiry card.

MEMOREX Flexible Discs

SAVE 40% Write for your complete list.

5 1/4" Specify soft, 10 or 16 sector Price/10

1 Side, double density \$24.70
2 Sides, double density 36.40
1 Side, 80 track, double density 32.50
2 Sides, 80 track, double density 44.20
(All 5 1/4" have Hub-rings)

8" Specify soft of 32 sector

1 Side, single density 23.40
1 Side, double density 30.60
2 Sides, double density 35.80

CHECKS — VISA — MC — C.O.D.
(313) 777-7780 ADD \$2 SHIPPING

LYBEN COMPUTER SYSTEMS
27204 Harper Ave.
St. Clair Shores, MI 48081

Circle 235 on Inquiry card.

CP/M USERS:

Prepare Even the Most Complicated Programs Quickly, Easily!

With EZ.COM Software Programming Aid



Program logically, conveniently by structure and modularity!

EZ.COM is an efficient programming tool that drastically reduces total cycle time of programming and eliminates the tedious construction of complex programs. EZ.COM creates and maintains libraries of program modules.

- Modules may be as long as 100 lines. Each library may be as large as 8 megabytes and may contain as many as 16 thousand modules.
- Modules may be created, transferred from another library, or purloined from other program source listings.
- Modules have no format restrictions and may consist of coding, tables, description text, display formats, etc!
- Modules are filed random access allowing instant storage and retrieval.

Written in efficient and fast 8080 assembly, EZ.COM produces easily debugged and understandable programs faster than any other technique. Many programs may coexist in the library in the form of module lists which may then be used to obtain source files. Using lists arranged as hierarchical structures, the most modern techniques of structured and modularized programming may be used. A library index is available on demand along with module catalogs and program source listings.

EZ.COM OFFERS THE SIMPLEST TO LEARN, EASIEST TO USE FULL PAGE EDITOR YOU'LL EVER SEE!

- All the special options and features you'll ever want!
- All edit features are detailed on an edit help page—a key stroke gets it and a second returns you to your original place.
- A spooler is provided for listing while you are editing.

GOOF PROOF?

You can bet on it! An OOPS Key is provided to back out of any situation. Syntax edit is performed on the way in; all commands will be grammatically correct. RESET at any time, the files are protected.

For \$195 we'll send you the program along with sample files and reports on an IBM format 8" single density floppy, and an instruction manual you'll find to be an invaluable programming aid. Or, send \$35 for the manual alone (later applied towards your purchase of the program.) \$5.00 will bring you a program description with sample modules and reports.

The Softwarehouse

1542 W. Pepper
Mesa, Arizona 85201

or Call (602) 969-1430

**Requires CPM, 40 K RAM, at least one disk, and the dumbest of terminals.*

control characters can be found in the text box "A Quick Reference."

The screen editor also gives the space-bar and the cursor-control keys an automatic repeat and enables both the Repeat key and the Tab key. Holding down the Repeat key while pressing any other key will cause that key to repeat. The Tab key causes the cursor to move to the next tab stop. By pressing a Shift/Tab combination, a tab stop will be set (or cleared if one already exists) at the current cursor position. Since a tab stop can be set for each column, a total of 80 tabs can be set at any one time.

The ESC (Escape) key has also been given a function. One wants cursor controls to function while the program runs, but the same controls should be visible as special characters in a listing (it would be difficult to read the listing if the screen would clear each time a Clear Screen character was used). To avoid this problem, Commodore decided that if an odd number of quotes were typed on a line, the system would be in quote mode and a screen-control character would appear as a white-on-black character. The quote mode is also initiated when spaces have been inserted into a line with the Insert key. To end quote mode, you have to type another quote (unless it was initiated by the Insert key) or hit Return (and accept a line that should possibly not be accepted). By hitting the ESC key, you will escape from quote mode and the cursor keys will function normally.

The Run/Stop key has also been changed. In the old OS, it would load the next program from tape and run it. Now, it automatically loads and runs the first file from disk drive 0. This makes it easier for inexperienced operators to use software packages.

The Rest of the Story

Disk BASIC (OS version 4.0) was primarily designed to be used in conjunction with the new DOS 2.1. Though it can be used with the older DOS (version 1.0), the full potential of the system cannot be realized. Although access is the major and most important improvement to the DOS, Commodore has made other improvements.

The reliability of the disk drives has been improved by the removal of one sector (256 bytes) from each of the inner seven tracks on the disk. Because one of these sectors came from the directory track, there is now a maximum of 144 entries to the directory. This change also resulted in the loss of six data blocks from the disk. Because of this change, the disks made by the different DOSes are not compatible: but one can read disks made by the other (note that an 8050 can read only an 8050 disk). DOS 2.1 will generate a "CBM DOS V2" error if you try to write on a disk formatted by a version 1.0 system; however, if you write to a 2.1 formatted disk with DOS 1.0, the directory track will be disturbed and subsequent operations will cause disk errors.

Other changes to DOS 2.1 include an error counter in the BACKUP (a track-by-track duplication that destroys any data originally on the destination disk) command. To back up a disk now takes 2 minutes and 15 seconds

instead of 6 to 7 minutes. Also, if the system encounters an error during a COLLECT (verify), the system will restore a bad Block Availability Map (which tells the DOS what blocks are free for use as storage). This was not available under DOS 1.0.

Another improvement is in the COPY command, which will now copy all the files on one disk to another. Trying to copy a file to disk where that file is already in use will produce the "FILE EXISTS" error message, and the COPY will be halted. When converting disks from DOS 1.0 to DOS 2.1, the COPY command is the one to use.

With random-access files, each record must be the same length, making it important to inform the DOS how large each record will be when the file is created. This is so that the DOS can compute where to position the disk's head for the next appropriate record. The maximum record length is 254 characters, with a maximum of 65,535 records in a file. (The disk would not be able to hold all 65,535 records if the record length was more than two characters.)

Part of the beauty of Commodore's system using intelligent peripheral devices is that they can be doing one thing while the microprocessor is doing another. For instance, when the disk drive sends out a record, it automatically does a "look-ahead" operation and gets the next record (this makes sequential operations faster) while the microprocessor busies itself with computations.

Software availability for any system is quite important. Usually, after the introduction of any new computer, it normally sits around for a time before any good software is available. For the CBM 8032, however, this is not the case. Any software written in standard BASIC or for Commodore computers should run on the 8032 without modification. It does, however, depend on how the program was written.

Because the 8032 uses the new version 4.0 OS (meaning different ROMs), any program that has machine-language calls to the operating system probably won't work without some modification. For instance, in the 8032, the interrupt vector points to a different location than in the older CBMs.

The other major difference that will cause a compatibility problem is the difference in the screen sizes. Programs (mostly games) that peek and poke at the screen buffer won't work due to the difference of line lengths on the screens and the additional 1000 bytes in the screen buffer of the 8032.

Since the 8032 is ostensibly a business computer, it is more important to have professional business software available than games. Fortunately, some very powerful business programs are on the market. One is Professional Software's Wordpro 4 Plus. This is possibly the most powerful word-processing software available for a stock microcomputer.

Another powerful software package available for the system is Visicalc. On the 80-column screen, you can lay out spreadsheets of all types (i.e., budgets, balance

TCS MODEL III 48k 2 DISK



Fully assembled and tested systems that are software compatible and functionally identical to Radio Shack units sold at computer centers for \$hundreds more. Includes DOSPLUS 3.3.

- CONTROLLER BOARDS are high quality double sided epoxy boards with gold plated contacts.
- POWER SUPPLY is the finest switching type available.
- MOUNTING HARDWARE includes power and data cables.
- DISK DRIVES are Tandon, the same ones used by Radio Shack - 40 track, double density, 5 millisecond stepping rate.

The System comes with 180 day TCS limited warranty. **\$1795**

\$2095 MODEL III 48k 2 DRIVE SYSTEM with 720,000 bytes of storage

TCS uses 2 dual headed 40 track Tandon drives. You can convert your existing 40 track standard diskettes. This system includes Free DOSPLUS 3.4 (retail value \$149).

MODEL III DISK EXPANSION KITS

1	Controller, Power Supply, Mounting Hardware & Instructions	\$379
2	Controller, Power Supply, Hardware & one 40 track Tandon drive	\$577
3	Controller, Power Supply, Hardware, two 40 track Tandon drives, 32k memory (everything you need for 2 drive 48k upgrade)	\$799
3a	Kit 3 but with two 80 track drives (dual sided 40s)	\$999
4	Tandon 40 track disk drive (bare drive only, no instructions)	\$199
4	Kit 4 but with Configuration Instructions & Power Cable	\$219
5	16k of high quality TCS memory	\$39
5a	16k of RS memory	special \$79
6	32k of high quality TCS memory	\$69
6a	32k of RS memory	special \$158
7	Disk Controller Board (supports 40/80 single/double sided drives)	\$249
8	Switching Power Supply for Controller & two drives	\$119
9	Hardware & Cabling kit for above components	\$89

PRINTERS & ACCESSORIES

MATRIX PRINTERS

LINE PRINTER VII RS	\$325
NEC 8023A	\$495
C. ITOH 8510	\$495
OKIDATA 82A	\$499
OKIDATA 82A w/tractor	\$559
OKIDATA 83A	\$769
LINE PRINTER VIII RS	\$649
CENTRONICS 739 parallel	\$599
CENTRONICS 739 serial	\$749
OKIDATA 84 / 200 cps	\$1295
LINE PRINTER VI RS	\$988
CENTRONICS 704	\$1559
ANADEX 9500/01 2k buf.	\$1295
TEXAS INST. 810 Basic	\$1595
LINE PRINTER V RS	\$1549
Centronics 352 / 200 cps	\$1795
Centronics 353 / dual mode, 200cps data proc., 50cps super letter quality	\$2495

LETTER QUALITY Daisy Wheel / Spinwriters

C. ITOH F-10 / 40 cps	\$1595
DAISY WHEEL II RS	\$1695
DIABLO from	\$2350
QUME from	\$1850
NEC SPINWRITERS	\$CALL

LINE PRINTERS

CENTRONICS 6080/81 600 lines per minute	
608I standard	\$6399
6080 quietized cabinet	\$7676

Epson

EPSON MX80	\$CALL
EPSON MX80 FT	\$CALL
EPSON MX100 FT	\$CALL

FREE Graphtrax!!!

EPSON ACCESSORIES

GRAPHTRAX 80 option (bit-image/italics)	\$.79
CABLE Model I interface & Model III	\$.35
\$25 if purchased with EPSON printer	
CABLE & INTERFACE to Model I keyboard	\$.85
APPLE interface & cable	\$.89
GRAPPLER Apple hi resolution graphics	\$.CALL
IEEE interface & cable (CBM/Pet)	\$.79
ATARI cable (must have 850 interface)	\$.35
SERIAL RS232 2k buffered int. card	\$.149
RS COLOR computer to Epson card/cable	\$.59

EPSON PACK II

Screen oriented bit image graphics generator for Model III. Create your own characters, symbols, etc. Includes documentation. \$24.95 purchased with printer \$34.95 when purchased separately \$7.50 for update of Epson Pack I

Interfaces & cables available for most printers with any TRS80, Apple, Atari & most other computers. **\$\$\$CALL FOR PRICES!**

ALTOS COMPUTERS

TRS-80

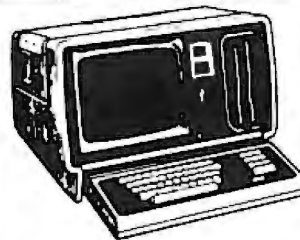

\$CALL

- MODEL II 64k
- MODEL 16 1 DRIVE
- MODEL 16 2 DRIVE
- DT-1 DATA TERMINAL
- Mod16 Memory Expansion

MODEL III SYSTEMS

Original 90 day manufacturer's warranty.

Model III 16k	\$818
Model III 32k	\$868
Model III 48k	\$918
Model III 48k 2Dr. RS232	\$1944

TCS Model III Systems have quality TCS memory and 180 day limited warranty. No warranty when you open computer or add internal components after you receive it.

TCS Model III 16k	\$788
TCS Model III 32k	\$818
TCS Model III 48k	\$848

COLOR COMPUTER

Original 90 day manufacturer's warranty.

16k Level 1	\$308
16k Extended Basic	\$398
32k Extended Basic	\$CALL
Color Disk	\$479
Disk 1.	\$349

TCS version Color Computers uses original RS hardware and TCS memory. You get 180 day limited warranty on TCS Color Computer.

16k Extended Basic	\$439
32k Extended Basic	\$499
32k Memory Upgrade	\$79
Color/Epson int. & cable	\$59
2k Buffer ColorGraph	\$155

TANDON DRIVES

DEALERS! ASSEMBLERS! Quantity Purchases Invited!

Bare drives are available, or you can buy them with power supply, cabinet and cable, fully assembled and ready to plug in to your computer.

INDIVIDUAL CABINETS

40 track single sided	\$249
80 track (dual sided 40 track)	\$389
160 track (dual sided 80 track)	\$499

BARE DRIVES ONLY

40 track single sided	\$199
80 track (dual sided 40 track)	\$299
160 track (dual sided 80 track)	\$419
6 inch Slimline sgl/dbl sided	\$CALL
Winchester hard drives. 5-30 meg	\$CALL

DOUBLE CABINETS with 2 DRIVES

40 track single sided	\$489
80 track (dual sided 40 track)	\$899
160 track (dual sided 80 track)	\$949

Heavy gauge CABINET with POWER SUPPLY. External gold connector allows instant hook/detach from drive cable.

WE WILL NOT

BE UNDERSOLD!

CORVUS HARD DISKS CALL FOR PRICES \$\$\$

Add 5, 10 or 20 megabytes of storage to your TRS80, Apple, Atari, Heath, Zenith, Intertec, IBM, S-100 and many others. One or several computers can share a hard disk. Get simultaneous access to data for multiple users. Available NOW at SUPER SAVINGS!

DEALERS... You can buy CORVUS from us for less. Call & SAVE.

CUSTOM SOFTWARE FROM TCS

Completely integrated **BINARY SEARCH TREE** programs now available. This series of programs fully implements the B-TREE structures including INSERTION, DELETION, EDITING & TRAVERSAL. No more sorting or long data file searches and yet files can be larger than memory. Duplicate keys are fully supported. Files can be retrieved in sorted order via B-TREE Traversal. Each of the programs come with fully commented source code so that you can use the modules in your own programming. A Screen oriented Input routine is also included in each module. The following B-TREE programs are now available and each includes all of the mentioned modules and full documentation:

B-TREE Library (organize your home library keyed by author)	\$39.95
B-TREE Video (organize your video cassette library, prints labels, etc)	\$39.95
B-TREE Mailing List (keyed by name or zip, label printing, etc)	\$49.95



If you buy somewhere else, you'll probably pay too much!

For fast, efficient service. Heart of we can air freight from Dallas

TEXAS COMPUTER SYSTEMS

P.O. Box 1327 Arlington, Texas 76004-1327

★ Toll Free Number 800 433-5184

Texas Residents 817 274-5625

* Prices subject to change at any time
No Tax out-of-state. Texans add 5%
Many items shipped FREE. Call for quote.

CALL FOR OUR

FREE CATALOG!

sheets, etc.) to see how changing one element affects the rest.

Documentation

One area in which Commodore has made a remarkable improvement is documentation. In the past, documentation for Commodore computers has been quite poor, lacking both in content and approach. The 8032 comes with a *User's Reference Manual* that explains in a clear, concise manner the capabilities of the system and the entire command set. The command set is presented in a form used by other technical manuals showing the command format and syntax, in which version of Commodore BASIC it can be used, its purpose, remarks about the command, and detailed examples. The manual included with the 4040 explains the operation of the disk and the disk organization, as well as how to use the various disk commands.

I believe, however, that some documentation is lacking. From past experience, I know that a command can be abbreviated to the first few letters (i.e., goto = gO, gosub = goS, print# = pR, etc.). This time-saver is not mentioned in any of the manuals. The screen-control characters and the use of the screen editor (one of the nicer programming features on the system) are also completely missing from the documentation.

In the *User's Guide* is a system memory map by 1K-byte blocks. Included in that manual's appendix is a list of more than 20 system calls, plus the missing machine code needed to perform the listed function. All these system calls are common to all versions of Commodore's operating system. This is quite helpful for those who wish to do machine-language programming; however, Commodore omits the zero-page memory map, one of the most important memory maps for a 6502-based machine. My interpretation is that Commodore wants other people to write software for its machines that is in-

dependent of the model it was written on.

The upgrade ROM for Model 2001 computers will give you all the features and improvements of Disk BASIC, without an 80-column screen. Though the new operating system uses an additional ROM, helpful commands such as TRACE and RENUMBER were not included. (The request for "Programmer's Aid" routines has been answered by Power, a 4K-byte ROM from Professional Software Inc., 51 Fremont St., Needham, MA 02194.) Likewise, Commodore is offering an upgrade for the 2040 disk drive that makes it a 4040. This set of three ROMs and one controller will give an old 2040 random-access capability and increased reliability. Remember that if you upgrade to a 4040, your 2040 disks must be converted to the new DOS 2.1 format *before* you can write on them.

Conclusions

The CBM 8032 computer and 4040 disk drive form a good business system for the small to medium-size business. The lack of a marketing strategy by Commodore, as well as its past nonchalant attitude toward the encouragement and development of good software, has hurt its credibility, especially in comparison to the other systems on the market.

The available business software, Wordpro and Visicalc, make excellent use of the capabilities of the CBM 8032 and coincide with the environment in which it is best suited. The recognition of the companies who market these types of programs will keep this computer in a business atmosphere.

With an increasing number of competitive machines being brought to the marketplace, Commodore appears to be now providing better support and documentation on its systems. The documentation included with the CBM 8032 and the 4040 disk drive has improved over the documentation provided with past Commodore computer systems. ■



**STARTJOB
&
O.T. CALENDAR CLOCK**
For Apple or S-100 Computers
Only \$150.00

22:00:00
STARTJOB VERS 1.1
These Jobs Will Start At
22:00:00

Receive B:
Transmit C:Test.txt
Crun2 Update
Submit Payroll

Starting Delayed Jobs

System Solutions, Inc.
P.O. BOX 35
KNOB NOSTER, MD. 65336
(816) 625-7863

 Z80

S-100

APPLE is a registered trademark of Apple Computer, Inc.
CP/M is a registered trademark of Digital Research, Inc.

Circle 389 on inquiry card.

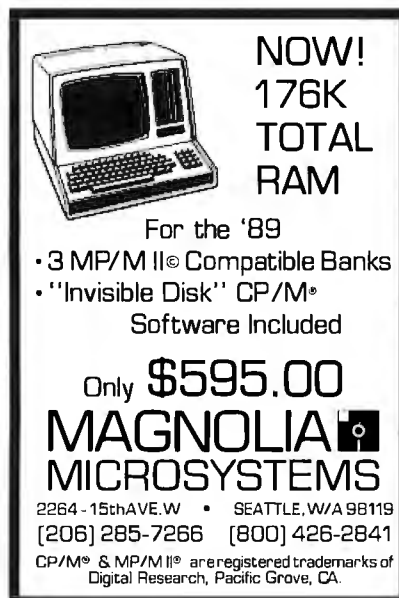

**NOW!
176K
TOTAL
RAM**

For the '89

- 3 MP/M II[®] Compatible Banks
- "Invisible Disk" CP/M[®]

Software Included

Only \$595.00

**MAGNOLIA
MICROSYSTEMS**

2264 - 15th AVE. W • SEATTLE, WA 98119
[206] 285-7266 [800] 426-2841

CP/M[®] & MP/M II[®] are registered trademarks of
Digital Research, Pacific Grove, CA.

Circle 243 on inquiry card.



Verbatim
flexible disks

Call Free (800) 235-4137 for
prices and information. Dealer
inquiries invited. C.O.D. and
charge cards accepted.



**PACIFIC
EXCHANGES**
100 Foothill Blvd.
San Luis Obispo, CA
93401. In Cal. call
(800) 592-5935 or
(805) 543-1037.

Circle 314 on inquiry card.

LOOK!
 14.4 MEGABYTES
 UNFORMATTED
 11.3 MEGABYTES
 FORMATTED



LOOK!
 \$2495
 Complete
 Subsystem

INEXPENSIVE MASS STORAGE

Gallium 10, 20, 30 & 40 megabyte disk systems are the **MOST** cost-effective winchester disk systems for your Apple® II computer.

The Gallium-10 is available in a 10 Mbyte configuration for an introductory price of **\$2495**.

GALLIUM IS VERY ECONOMICAL

For the price of 4 disk drives you can have the capacity of 72 diskettes and our Volumes are 3 Apple diskettes' capacity. That means you can have over 400 kilobytes files without segmenting your data base.

With our intelligent controller you can expand to 40 megabytes with the addition of 3 more 10 Megabyte drives.

We use proven winchester disk technology to assure you of the finest quality disk drive your money can buy. The disk drive operation is **NOISE-FREE** for office and home environments.

GALLIUM SOFTWARE

The Rom-resident software interfaces to DOS 3.3, Apple Pascal (optional) and CP/M (optional). All operating systems remain unmodified so there is no need to change anything in your programs to use the Gallium-10.

Utilities provided include programs to copy from floppy to Gallium and from Gallium to floppy, format volumes, and a demo program to show you how your disk can be used.

SERVICE

Gallium-10 disk drives come with a 90-day parts & labor warranty. An extended warranty is available

at extra cost. Gallium disk systems require no preventive maintenance.

SPECIFICATIONS:

DATA ORGANIZATION

Capacity (Megabytes)
 Unformatted 14.4 Megabyte
 Formatted 11.3 Megabyte

DISKS

Number 3
 Data Surfaces 6
 Diameter (Inches/cm) 5.25/13.33

PERFORMANCE

Access Time Track To Track (3 milliseconds)
 Disk Rotational Speed 3600 rpm
 Peak Transfer Rate 5 MB/S

UTILITIES

Format Formats All Surfaces
 Volume Initer Initializes With An "EMPTY" File
 A Given Number Of Volumes
 File Finder Finds All Volumes On Which
 Any Given File Is Resident
 File Runner Finds & Runs The Given File
 From The First Volume On
 Which It Is Resident
 Partition Partitions The Disk For DOS 3.3,
 CPM & PASCAL Allocating
 The Required Number Of Sectors
 For Each Given Operating System
 CPM Boot Permits Booting
 In CPM Operating System
 PASCAL Boot Permits Booting In PASCAL
 Connect Connects Gallium To DOS
 If Booted From Floppy Disk

* Apple is a registered trade mark of Apple Computer Co.

XITENSYSTEMS

16815 Hawthorne Blvd. • Lawndale, CA 90260 • (213) 370-3966
 (800) 421-1947

The Choice of



IBM-PC SUPPLY CENTER PERIPHERALS & SOFTWARE FOR THE IBM PC

HARDWARE:			
CORVUS, Hard Disk Systems. See Corvus section this page			
Microsoft, 64K RAM Card	New!	\$395	20%
128K RAM Card	New!	\$555	20%
256K RAM Card	New!	\$875	20%
64K RAM Chips	New!	\$160	20%
Quadram, Quad Board 256K, 4 function brd.	New!	\$689	31%
TG Products, Joystick		\$ 49	25%
SOFTWARE:			
Automated Slim, Temple of Apsah		\$ 29	25%
Cavalier, Championship Blackjack		\$ 29	25%
Continental, Home Accountant Plus		\$112	25%
Denver, Easy (Exec. Accounting Sys.)		\$545	25%
Infocom, Deadline		\$ 39	25%
Zork I		\$ 23	25%
Zork II		\$ 23	25%
Innovative, T.I.M. III (a DBMS)		\$369	25%
ISM, Mathmagic		\$ 69	25%
★ Insoft, Accountant		\$ 99	60%
<i>For each GL, A/R, A/P or Payroll. Absolutely the best IBM-PC accounting software we have seen. We use it and recommend it highly. A best buy!</i>			
Info, Unlimited		\$ 99	60%
Easywriter II	New!	\$259	25%
Phone Support on Easywriter II	Call	Call	Call
Easyspeller (88K words)	New!	\$129	25%
Easyspeller (a DBMS)	New!	\$299	25%
Micro Pro, Wordstar	New!	\$285	40%
MailMerge		\$ 90	40%
Sorcim, Superwriter		\$295	25%
Super Calc		\$219	25%
Visicorp, Viscalc		\$159	20%
Visicorp, Viscalc/256K		\$199	20%

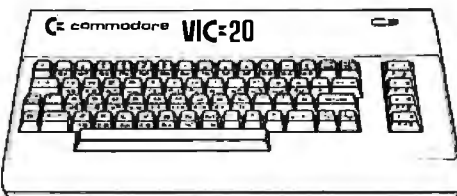

VIC 20 Home Computer			
Datasette VIC 1530		\$ 59	20%
Disk Drive VIC 1540		\$479	SAVE
Super Expander VID 1211A 3K with lots of extras		\$ 56	20%
3K Memory Expander Cartridge		\$ 32	20%
8K Memory Expander Cartridge		\$ 48	20%
16K Memory Expander Cartridge		\$ 88	20%
VIC Modem, Telephone Interface		\$ 96	20%
VIC/IEEE-488 Interface		\$ 80	20%
Joystick		\$ 8	20%
Game Paddle Pair		\$ 15	20%
Software full line in stock. Call			



800 Computer 16K			
800 Computer 32K		\$747	37%
800 Computer 48K		\$777	40%
400 Computer 16K		\$275	17%
810 Disk Drive		\$444	26%
16K RAM		\$159	25%
410 Recorder		\$ 79	21%
825 Printer 80 Col. Impact		\$595	25%
\$269		14%	
822 Printer 40 Col. Thermal		\$279	14%
830 Acoustic Modem		\$159	28%
16K RAM		\$ 85	15%
32K RAM		\$109	20%
Le Stick by Datasoft		\$ 29	28%
Game Paddles (pair)		\$ 18	20%
Joystick (pair)		\$ 18	20%
SOFTWARE:			
Visicorp, Disk		\$189	25%
Word Processing, Disk		\$119	23%
Pacman, Cart	New!	\$ 35	22%
Centipede, Cart	New!	\$ 35	22%
Covers of Mars, Disk		\$ 31	23%
Touch Typing, Tape		\$ 19	23%
Personal Financial Mgt. Disk		\$ 55	22%
Entertainer Kit, Cart		\$ 79	33%
Educator Kit, Cart		\$125	29%
Programmer Kit, Cart		\$ 55	22%
Communicator Kit, Cart		\$335	26%
Dow Jones Invest. Disk		\$ 99	24%
Temple of Apsah by Automated, Disk		\$ 29	25%
Apple Panic by Broderbund, Disk		\$ 23	25%
Raster Blaster by Bugdaco, Disk		\$ 23	25%
Bug Attack by Cavalier, Disk		\$ 23	25%
Text Wizard by Datasoft, Disk		\$ 75	25%
Compu-series by Edu-Ware, Disk		Call	25%
Deadline by Infocom, Disk		\$ 37	25%
Zork II by Infocom, Disk		\$ 29	25%
Asteroid by On-Line, Disk		\$ 20	25%

CP/M BUSINESS & DEVELOPMENT SOFTWARE

Adventure, Adventure's #11 to #12 inclusive, 8"		\$ 95	26%
Ashion-Tate, dBase II, 8"		\$495	30%
Datasoft, Mychess, 8"		\$ 39	25%
Fox & Geller, Quickcode for dBase II		\$249	13%
Quickscreen for dBase II		\$129	13%
dUtil for dBase II		\$ 75	25%
Infocom, Deadline, 8"		\$ 45	25%
Zork II, 8"		\$ 39	25%
Innovative, Spellguard, 8"		\$220	25%
★ Insoft, Accountant, 8", each module			
<i>For each GL, A/R, A/P or Payroll. Absolutely one of the best accounting software systems available. We use it and recommend it highly. A best buy!</i>			
MicroCraft, Legal Billing & Time Keeping		\$ 99	60%
Prof. Billing & Time Keeping		\$395	45%
MicroPro, Wordstar, 8"		\$249	50%
Datastar, 8"		\$199	43%
Malmmerge, 8"		\$ 85	44%
Super Sort, 8"		\$150	40%
Word Master, 8"		\$ 90	40%
Spell Star, 8"		\$150	40%
Calc Star, 8"		\$180	40%
Microsoft, Fortran 80, 8"		\$325	25%
Basic Compiler, 8"		\$295	25%
Cobol-80, 8"		\$545	25%
Basic-80, 8"		\$275	25%
Peachtree, Magic Wand, 8"		\$275	30%
GL, A/R, A/P, PR or Inventory, 8"		\$325	35%



H/P 85 Microcomputer/Monitor/Printer			
H/P 87 CP/Microcomputer	Special!	\$1895	31%
H/P 125 CP/M Microcomputer	New!	\$1875	25%
H/P 82901M 5" Dual Drives	New!	\$1965	30%
H/P 7225B Professional Graphics Plotter		\$1595	28%
H/P 7470A Graphics Plotter	Special!	\$1795	35%
H/P 82908 Serial Printer	New!	\$1125	28%
H/P 41C Calculator	Special!	\$ 850	50%
H/P 41CV Calculator 2.2K		\$ 185	25%
Card Reader for HP41		\$ 245	25%
Printer/Plotter for HP41		\$ 159	27%
Optical Wand for HP41		\$ 89	25%
Software:			
Visicorp + for HP87		\$ 189	25%
Visicorp + for HP125		\$ 159	20%
★ Accountant by Insoft for HP125 or HP87		\$ 99	60%
<i>For each GL, A/R, A/P or Payroll. Absolutely the best HP125 or HP87 accounting software we have seen. We use it and recommend it highly. A best buy!</i>			
Full line of HP accessories and software	Call	Call	Call

CORVUS SYSTEMS

6 Meg Hard Disk		\$2495	20%
11 Meg Hard Disk		\$3995	20%
20 Meg Hard Disk		\$4795	20%
Mirror built-in for easy backup		\$ 649	20%
Apple Interface		\$ 239	20%
Apple III Interface (SOS)		\$ 239	20%
IBM PC Interface (IBM DDS)		\$ 239	20%
Xerox Interface (CP/M)		\$ 239	20%
NEC Interface (CP/M)		\$ 239	20%
TRS-80 Interface (call)		Call	20%
Other Interfaces, Omni-Net, Constellation, Mirror. All in Stock.			



8001 32K Computer			
286K Total, Quad Drive PC8031		\$ 739	25%
32K add-on and I/O Unit PC8012		\$ 739	25%
		\$ 485	25%
Ren Tec "The Wedge" 32K		\$ 495	17%
8023 Impact Printer F/T		\$ 480	25%
Impact Printer Cable		\$ 49	25%
3510 Letter Quality Daisy Wheel Printer		\$1995	20%
Monitor, 12" Green		\$ 159	25%
Monitor, 12" Color		\$ 349	25%
SOFTWARE:			
NEC CP/M DOS for NEC 8001		\$ 115	25%
NEC Report Manager		\$ 135	30%
NEC General Accounting		\$ 239	40%
NEC Accounts Receivable		\$ 239	40%
NEC Inventory System		\$ 239	40%
NEC Payroll System		\$ 239	40%
NEC Game Pack I		\$ 24	20%
NEC Game Pack II		\$ 24	20%
NEC Word Processor		\$ 395	20%
Infocom, Zork II		\$ 29	25%
Deadline		\$ 39	25%
Insoft, Accountant			
<i>For each GL, A/R, A/P or Payroll. Absolutely the best NEC accounting software we have seen. We use it and recommend it highly. A best buy!</i>			
		\$ 99	60%

μ-SCI FOR THE APPLE II/II+ DIRECT SUBSTITUTES FOR APPLE DRIVES

Micro-Sci A2 drives and/or controllers are direct plug compatible substitutes for Apple drives and controllers. A2 will run all Apple software. Save over \$350 on an A40 or A2 dual drive system. We use them and highly recommend the product.			
★ A2, 5 1/4", 143K Disk Drive		\$369	23%
Controller Card for A2 Drive		\$ 79	21%
A40, 5 1/4", 160K Disk Drive		\$359	20%
A70, 5 1/4", 286K Disk Drive, Double Density		\$479	20%
Controller Card for A40 or A70 Drive		\$ 79	21%
Filer, Disk Utility Software System for A2 Drives		\$ 15	25%

OVERSTOCK SPECIAL

for the



ALS 16K AddRAM Card		\$ 59	60%
ALS ZCard, Z80 CP/M Card		\$199	27%
ALS Smarterm 80 Col. Card		\$229	34%
ALS Synergizer Pack		\$450	40%
ALS Synergizer Pack with Supercalc by Sorcim (while they last)		\$495	53%

PRINTERS, Daisy Wheel

★ Qume, Sprint 9, 45 Cps. RO	SPECIAL!	\$1895	33%
Sprint 5, 45 Cps. RO	SPECIAL!	\$1995	34%
★ Comrex, CR-1, 17 Cps. RO, RS232	NEW!	\$ 895	26%
★ Olympia (Typewriter/Printer) ES-100 18CPS, with full cable and interface to Apple II		\$1295	24%

PRINTERS, Impact

Epson See Epson section below	See below		
iOS, Prism 132, Color w/Graphics		\$1595	20%
Prism 80, Color, w/Graphics		\$1495	17%
Pager Tiger 445C, w/Graphics & 2K	Special!	\$ 595	35%
Pager Tiger, 560, w/Graphics		\$ 995	30%
Okidata, Microline 824, 120 Cps, 80 Col. Para & Serial		\$ 495	15%
Microline 84S, 200 Cps, 136 Col. Serial, 200 Cps.		\$1295	15%

EPSON PRINTERS & ACCESSORIES

MX80 w/GraTrax		\$425	31%
Mx80 F/T w/GraTrax +		\$525	25%
MX100 F/T w/GraTrax +		\$695	27%
Apple Interface and Cable for MX80/MX100		\$ 95	15%
GraTrax 80 for MX80		\$ 79	20%
Epson/Atari Cable		\$ 30	26%
Epson TRS 80 Cable		\$ 30	26%
GraTrax by Orange Micro, Specific Computer		\$129	21%

MONITORS

NEC, 12" Green		\$159	25%
12" Color, Composite		\$349	25%
Sanyo, 9" B&W		\$149	25%
★ 9" Green		\$149	31%
12" B&W		\$199	20%
12" Green		\$199	25%
13" Color, Composite		\$349	25%
Zenith, 12" Green		\$119	30%
Amdek, 12" Green #300		\$159	38%
13" Color I, Composite		\$359	20%
13" Color II, RGB		\$799	20%
Color II to Apple II Interface		\$159	20%
Comrex, 13" Color, Composite		\$349	27%
13" Color, RGB for IBM-PC		\$529	15%

DISKETTES

★ CDC 12 for 10 Special, Limited Time!			
CDC, 120 each, 5 1/4", with ring, SS, SO (Apple, IBM, etc.)		\$195	57%
12 each, 5 1/4", with ring, SS, SO (Apple, IBM, etc.)		\$ 22	45%
12 each, 5 1/4", with ring, SS, SO (H/P, etc.)		\$ 28	45%
12 each 8", SS, SO		\$ 28	45%
Verbatim, 10 each 5 1/4", with ring, SS, SO		\$ 28	45%
Maxell, 10 each 5 1/4", SS, SO		\$ 35	33%
Dysan, 10 each 5 1/4", SS, SO		\$ 39	30%
10 each 5, OS, DO		\$ 49	25%

ORDERING INFORMATION: Minimum order \$100. Cashiers Checks and Money Orders welcomed. Personal Checks allow 20 days to clear. Add 3% for VIS-A-R MC. Add 3% for shipping, insurance and handling. UPS is standard. Additional 10% for US Postal or AFD. Include telephone #. No C.O.D. Prices subject to change and typographic errors. Call to verify. All goods are new, include factory warranties, and are guaranteed to work. No refunds on opened software. There may be restocking fee on returns. Call before returning goods. Order desk hours are 8 to 6 PST 10 to 3 Saturdays.

OUR REFERENCES: We have been a computer dealer since 1978. Our bank reference is First Interstate Bank. (503) 776-5620. We belong to the Chamber of Commerce. (503) 772-6293, or call Dun & Bradstreet if you are a subscriber. Computer Exchange is a division of O'Tech Group, Inc.

Portland, OR, Cash & Carry Outlet

11507-D SW Pacific Hwy., Pacific Terrace Shop, Cr., Tigard, OR. Over-the-counter sales only. On 99W between Rte. 217 and Interstate 5. Call 245-1020.



NO SALES TAX Oregon Order Desk (503) 772-3803 **NATIONAL ORDER DESK TOLL FREE (800)547-1289**

Apple is a registered trademark of Apple Computer, Inc.

Professionals

Manufactured Exclusively for  Bell & Howell by  apple computer

	LIST PRICE	APPLE BEIGE	B&H BLACK	SAVE
64K (48K + ALS 16K)	\$1725	\$1345	\$1295	\$430
DISK II w/3.3 Cont.	\$645	\$555	\$545	\$100
DISK II Only	\$525	\$485	\$475	\$50

OR: SAVE OVER \$350 on a pair of drives.
Buy a pair of Micro-Sci A2 Drives.
See opposite page.

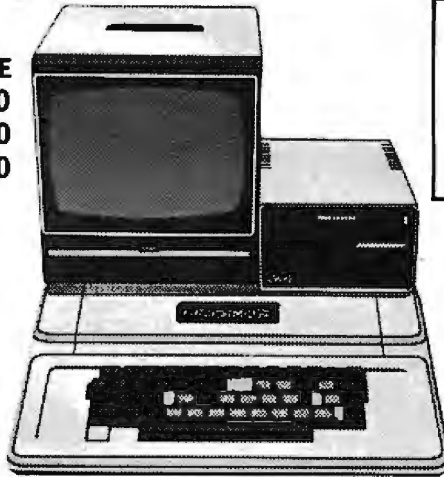

64K STARTER SYSTEM	\$1,950
SAVE \$ 620	

- 48K Micro II+
- ALS 16K RAM Card
- Disk II with 3.3 DOS & Controller
- Sanyo 9" Green Monitor

Add \$60 for Apple Beige color.
Save \$197 more. Substitute a Micro-Sci drive for the Disk II.
Save \$350 more on a pair.

64K BUSINESS STARTER SYSTEM	\$2,365
SAVE \$1,000	

Starter System above plus:

- ALS ZCard with CP/M
- ALS Smarterm 80 Column
- Sorcim Supercalc (while they last)

apple II/II+ supply center

HARDWARE for Apple II/II+

MICRO-SCI, Disk Drives. Plug/software compatible to Apple. See opposite page.

	PRICE	SAVE
RAM CARDS:		
Microsoft, 16K RAM Card	\$ 149	33%
★ ALS, 16K ADORam	\$ 59	60%
Saturn Systems, 32K	\$ 169	25%
64K	\$ 319	25%
128K	\$ 459	25%
VC Expand 40 or 80	\$ 75	25%
Axton, 320K RAM Disk system	\$1145	20%
80 COLUMN VIDEO CARDS:		
ALS, Smarterm	\$ 229	34%
Videx, Videoterm	\$ 249	28%
See more ALS and Videx under Miscellaneous below.		
Vista, Vision 80	\$279	30%
M&R, Sup R term	\$ 319	15%
MISCELLANEOUS:		
ALS, Smarterm 80 Col. Card Special	\$ 229	34%
Z Card (Z-80) W/CPM Special	\$ 199	27%
16K ADORam Special	\$ 59	60%
Synergizer Pack Special	\$ 450	40%
★ Synergizer with free Sorcim Supercalc. (While they last)	\$ 495	53%
Apple Computer,		
Silentype II Printer	\$ 335	15%
Graphics Tablet	\$ 675	15%
Axton, 320K RAM Disk System	\$1145	20%
CCS, Serial Interface 7710A	\$ 139	22%
Other CCS Cards in stock	Call	Call
Dan Paymar, Lower Case Chips	\$ 34	33%
Hayes, Micromodem II	\$ 289	25%
Smartmodem	\$ 229	20%
ISC, Videostick Paddle	\$ 35	23%
Keyboard Company,		
Joystick II	\$ 45	10%
Game Paddle	\$ 25	17%
Numeric Keypad	\$ 119	21%
M&R, RF Modulator	\$ 25	27%
★ Microsoft, 280 Software	\$ 269	33%
16K RAM Card	\$ 149	33%
SoftcardPremiumPack	\$ 579	25%
Mountain,		
CPS Multifunction Card	\$ 209	13%
★ Clock/Calendar	\$ 195	30%
Novation, Applcat Modem	\$ 329	16%
Orange Micro, Grappler	\$ 129	21%
★ Practical Peripherals, w/cable & Conn.)		
MBS 8K Serial (Epson) New!	\$ 129	20%
MBS 16K Para (Epson) New!	\$ 129	20%
★ Microbutler II 16K New!	\$ 209	20%
Microbutler II 32K New!	\$ 229	24%
RH Electronics, Super Fan II	\$ 59	21%
Station Two,		
6809 Pascal Speed-up Kit, The Mill & Assembler Development Software	Special!	\$250 50%
SSM, A10 Serial/Para Interface	\$ 159	20%
TG Products: Game Paddles	\$ 29	28%
Joystick	\$ 45	25%
★ Videx, Videoterm 80 col.	\$ 249	28%
Soft Video Switch	\$ 25	29%
Enhancer II	\$ 99	34%
Enhancer (Rev 6 or 7)	\$ 99	25%
Full Videx Line	Call up to 35%	

SOFTWARE on disk for Apple II/II+ BUSINESS

Apple Computer, Inc.	PRICE	SAVE
50% Off on Apple III Software	Call	50%
The Controller (Accounting)	\$499	20%
Apple Writer 1.1	\$ 59	20%
Apple Pascal	\$199	20%
Apple Fortran	\$159	20%
DOS Tool Kit	\$ 59	20%
DOS 3.3 Upgrade Kit	\$ 59	20%
Apple Plot	\$ 59	20%
Apple Pilot	\$119	20%
DJ News & Quotes	\$ 75	20%
DJ Portfolio Evaluator	\$ 45	20%
How to!	\$ 39	20%
Microcourier	\$199	20%
Micro Telegram	\$199	20%
Time Manager	\$119	20%
Many Others	Call	Call
Applied Soft Tech., Versa Form	\$299	26%
Artsci, Magic Window	\$ 75	25%
Ashion-tale, dBase II (CP/M)	\$495	30%
Beagle Bros., Utility City	\$ 22	25%
Broderbund, Payroll	\$269	30%
General Ledger	\$349	30%
Continental, CPA #1 General Ledger	\$189	25%
CPA #2 Accounts Rec.	\$189	25%
CPA #3 Accounts Pay.	\$189	25%
CPA #4 Payroll	\$189	25%
CPA #5 Property Mgt.	\$189	25%
Denver, Financial Partner	\$185	25%
dBase II for Apple II/II+ CP/M	\$495	30%
Fox & Geller, Quickscreen for dBase II	\$129	13%
Quickcode for dBase II	\$259	13%
Hayden, Pie Writer (Specify brd.)	\$125	25%
High Tech., Store Mgr.	\$189	25%
★ Job Control Sys.	\$469	40%
Info Master	\$119	40%
Info. Unim., Easywriter (PRO)	\$139	25%
★ Innovative, Spellguard (CP/M)	\$150	50%
Insolt, Accountant (CP/M)		
For each GL, A/R, A/P or Payroll. Absolutely the best accounting software available for the Apple II/II+. Better than Peachtree. We use it and recommend it highly.		
LJK, Letter Perfect	\$ 99	60%
★ Micro Graf, (CP/M) Legal Billing & timekeeper	\$250	65%
Prof. Billing & timekeeping	\$250	65%
Micro Lab, Data Factory ver 5.0	\$249	20%
★ Visifactory New!	\$ 56	25%
Invoice Factory	\$129	35%
Tax Manager	\$ 95	38%
Micro Pro, (all CP/M)	SAVE	
World Star NewVersion	\$199	47%
MailMerger	\$ 69	45%
SpellStar	\$119	40%
DataStar	\$169	40%
CalcStar	\$169	40%
SuperSort I or II	\$119	40%
Muse, Super Text II	\$113	25%
Super Text 40/80	New!	\$129 25%
Form Letter	New!	\$ 75 25%
Address Book	New!	\$ 39 25%
On-Line, Expediter II	\$ 75	25%
ScreenWriter II	\$ 95	27%
Osborne/C.P. Soft., (Disk and Book)		
★ Some Common Basic Programs.		
75 Business Statistics and Math programs for the Apple II	\$ 49	50%
★ Practical Basic Programs.		
40 more very valuable programs beyond "Some Com. Basic Prog"	\$ 49	50%
Peachtree, GL, AR, AP or Inv. each	\$189	36%
★ Magic Wand (Specify board)	\$250	50%
Phoenix, Zoom Grafix	\$ 29	28%
Sensible, Apple Speller	\$ 55	27%
Silicon Valley, Word Handler	\$150	40%
Solidus/Softech		
★ Stockfile	\$250	60%
Stockseller	\$425	40%
Software Publishing,		
PFS II or III NEW version!	\$ 89	30%
PFS Report II or III	\$ 69	30%
Sorcim, Super Calc. (CP/M)	\$219	25%
Southeastern,		
Data Capture 4.0, specify brd.	\$ 69	25%
Source, The Source	\$ 75	25%
Stoneware, DB Master	\$179	22%
DB Utility I or II	\$ 75	10%
VisiCorp/Personal Software,		
Visicalc 3.3	\$189	25%
VisiDex Special!	\$175	30%
VisiFile	\$199	25%
Desktop Plan II or III Special!	\$175	30%
VisiPlot	\$159	20%
VisiSchedule New!	\$239	20%
VisiTrend and VisiPlot Special!	\$210	30%
VisiTerm	\$ 79	20%
Zork	\$ 33	20%
UTILITY & DEVELOPMENT		
Beagle, Utility City	\$ 22	25%
OPS Boss	\$ 18	25%
Central Point Software:		
★ Copy II Plus (bit copier)	\$ 35	10%
Will copy most copy protected software for your backup in 45 seconds or less! Highly recommended.		
Filter, DOS Utility	\$ 18	25%
Epson, Graphics Dump	\$ 9	35%
Insolt,		
★ GrafFORTH by Paul Lutus New!	\$ 59	22%
ALO System II by Paul Lutus	\$ 59	22%
TRANSFORTH II by Paul Lutus	\$ 99	20%
Electric Duet by Paul Lutus New!	\$ 25	20%
Microsoft,		
ALL.D.S.	\$110	10%
BASIC Compiler	\$299	25%
Cobol 80	\$559	25%
Fortran 80	\$149	25%
Olympic Decathlon	\$ 24	24%
TASC Compiler	\$159	22%
★ Omega, Locksmith (bit copier)	\$ 75	25%
On-Line, Expediter II	\$ 75	25%
Phoenix, Zoom Grafix	\$ 29	28%
Source, The Source	\$ 75	25%
Southwestern, ASCII Express	\$ 59	25%
Sub-Logic, Flight Simulator	\$ 28	20%
Tymac, Super Pix	\$ 20	20%

Warranty: Factory warranty is by Bell and Howell (not by Apple) and is one year parts plus 90 day labor. Warranty service available at Bell and Howell service centers or return to Computer Exchange.

Apple is a registered trademark of Apple Computer Inc.

★ Means a BEST buy.

\$100 Minimum Order.

HOME & EDUCATION

	PRICE	SAVE
Autom. Sim., Crush Crumb Chomp	\$ 30	25%
Broderbund,		
Apple Panic	\$ 21	30%
Arcade Machine	\$ 32	30%
Red Alert	\$ 21	30%
Space Warrior	\$ 18	30%
★ Star Blazer New!	\$ 24	30%
Many others	Call	Call
Budgeco, Raster Blaster	\$ 22	27%
Calif., Pacific, Ultima	\$ 30	25%
Cavalier, Bug Attack	\$ 23	23%
Continental, Home Accountant	\$ 56	25%
Home Money Minder	\$ 26	25%
LA Land Monopoly	\$ 23	25%
DataMost, Snack Attack	\$ 22	25%
Thief	\$ 22	25%
Edu-Ware, Compumath	\$ 29	25%
Hayden, Sargon II (Chess)	\$ 29	22%
Infocom, Deadline New!	\$ 38	25%
Zork	\$ 29	25%
Insolt, Electric Duet by Lutus New!	\$ 25	20%
GrafFORTH by Lutus New!	\$ 59	25%
Lightning, Mastertype	\$ 29	25%
Microsoft, Olympic Decathlon	\$ 24	24%
Typing Tutor	\$ 19	30%
Muse, Robot War	\$ 29	25%
On-Line, Pegasus II	\$ 22	25%
Mouskattack New!	\$ 26	25%
Time Zone New!	\$ 75	25%
Jawbreaker New!	\$ 23	25%
Ultima II New!	\$ 27	25%
Marauder New!	\$ 26	25%
Threshold	\$ 30	25%
Cranston Manor	\$ 26	25%
Mission Astroid	\$ 15	25%
Mythic House	\$ 19	25%
Softporn (X Rated)	\$ 22	25%
Ulysses and Golden Fleece	\$ 22	25%
Piccadilly, Falcon	\$ 23	25%
Star Blaster	\$ 23	25%
Sentient, Oo-TOPOS	\$ 25	25%
Sirius, Sneakers	\$ 22	25%
Gorgon	\$ 29	25%
Twerpis	\$ 22	25%
Sir-Tec, Wizardry New!	\$ 39	22%
Strategic, Southern Command	\$ 30	25%
OTHER BRANOS IN STOCK. CALL.		

THE WORLD'S LARGEST COMPUTER MAIL ORDER FIRM

Computer Exchange

A Division of **O'TECH GROUP, INC.**

ALL MAIL: P.O. Box 1380, Jacksonville, OR 97530

Ad #935

WAREHOUSE AND OFFICES. BY APPOINTMENT AT 6791 UPPER APPLGATE ROAD.

Circle 95 on Inquiry card.

Let the MC68701 Program Itself

Arnold J. Morales and David Ruhberg
Motorola Inc.
3501 Ed Bluestein Blvd.
Austin, TX 78721

The Motorola MC68701 is an enhanced version of the MC6801 microprocessor. One of its chief features is the ability to program itself. The processing unit controls all movement of data into an on-chip EPROM (erasable programmable read-only memory). It controls programming power (V_{pp}) to the EPROM during programming, requiring only a few external devices to accomplish this.

On-chip resources of the MC68701 include a 2K-byte EPROM, a three-function timer, a serial-communication interface, up to 29 parallel I/O (input/output) lines, 128 bytes of RAM (random-access read/write memory), and an oscillator. These items provide a great deal of power and flexibility in a small package that's easy to use and design with.

In this article, we will explore how the MC68701 programs itself. We'll also discuss a fully tested MC68701 programmer, including software and a hardware design.

On-Chip EPROM

A dual-purpose MC68701 pin, $\overline{\text{RESET}}/V_{pp}$, is used both to reset the processor and to power the EPROM. This pin is normally +5 volts (V) during nonprogramming operation. It must be raised to V_{pp} ($21\text{ V} \pm 1\text{ V}$) during programming of the EPROM. However, the processor will operate normally with V_{pp} applied at all times.

The MC68701 EPROM is controlled by two bits in the RAM/EPROM control register (see figure 1). Bit 0 of the register is called the programming latch control (PLC) and is used to control an address latch used during programming of the EPROM. Bit 1 of the register is called

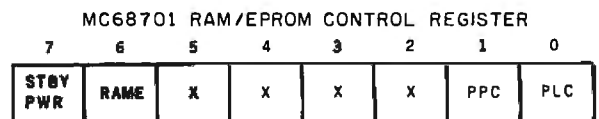

Figure 1: The RAM/EPROM control register. See the text for details of its operation.

the programming power control (PPC) and is used to control V_{pp} to the EPROM during programming.

When PLC is set, the latch is transparent. When PLC is clear, the address latch is enabled and latches each EPROM address asserted by the processor. PLC should be set during normal nonprogramming processor operation; it should be cleared only to program the EPROM. This bit is set at $\overline{\text{RESET}}$ and can be cleared only in Mode 0 (more about modes later).

When PPC is set, V_{pp} is not applied to the EPROM; when PPC is clear, V_{pp} is applied to the EPROM. PPC should be set during normal nonprogramming operation; it should be cleared only to program the EPROM. This bit is set at $\overline{\text{RESET}}$ and whenever the PLC bit is set, and can be cleared only in Mode 0 with the PLC bit clear.

The MC68701 is programmed in Mode 0 only. In this mode, all the interrupt vectors and reset vectors are in the locations BFF0 to BFFF hexadecimal, and the on-chip EPROM is at locations F800 to FFFF hexadecimal. The

H & E COMPUTRONICS INC.

• • EVERYTHING FOR YOUR TRS-80™ • ATARI™ • APPLE™ • PET™ • CP/M™ • XEROX™ • IBM™ • •

* TRS-80 is a trademark of the Radio Shack Division of Tandy Corp. - * ATARI is a trademark of Atari Inc. - * APPLE is a trademark of Apple Corp. - * PET is a trademark of Commodore
* CP/M is a trademark of Digital Research - * XEROX is a trademark of Xerox Corp. - * IBM is a trademark of IBM Corp.



★ All orders processed within 24-Hours
★ 30-Day money back guarantee

BUSINESS PAC 100 100 Ready-To-Run Business Programs

(ON CASSETTE OR DISKETTE).....Includes 128 Page Users Manual.....
Inventory Control.....Payroll.....Bookkeeping System.....Stock Calculations.....
Checkbook Maintenance.....Accounts Receivable.....Accounts Payable.....

BUSINESS 100 PROGRAM LIST

NAME	DESCRIPTION
1 RULE78	Interest Apportionment by Rule of the 78's
2 ANNU1	Annuity computation program
3 DATE	Time between dates
4 DAYYEAR	Day of year a particular date falls on
5 LEASEINT	Interest rate on lease
6 BREAKEVN	Breakeven analysis
7 DEPRSL	Straightline depreciation
8 DEPRSY	Sum of the digits depreciation
9 DEPRDB	Declining balance depreciation
10 DEPRDDB	Double declining balance depreciation
11 TAXDEP	Cash flow vs. depreciation tables
12 CHECK2	Prints NEBS checks along with daily register
13 CHECKBK1	Checkbook maintenance program
14 MORTGAGE/A	Mortgage amortization table
15 MULTMON	Computes time needed for money to double, triple, etc.
16 SALVAGE	Determines salvage value of an investment
17 RRVARIN	Rate of return on investment with variable inflows
18 RRCONST	Rate of return on investment with constant inflows
19 EFFECT	Effective interest rate of a loan
20 FVAL	Future value of an investment (compound interest)
21 PVAL	Present value of a future amount
22 LOANPAY	Amount of payment on a loan
23 REGWITH	Equal withdrawals from investment to leave 0 over
24 SIMPDISK	Simple discount analysis
25 DATEVAL	Equivalent & nonequivalent dated values for oblig.
26 ANNUEDEF	Present value of deferred annuities
27 MARKUP	% Markup analysis for items
28 SINKFUND	Sinking fund amortization program
29 BONDDVAL	Value of a bond
30 DEPLETE	Depletion analysis
31 BLACKSH	Black Scholes options analysis
32 STOCVAL1	Expected return on stock via discounts dividends
33 WARVAL	Value of a warrant
34 BONDDVAL2	Value of a bond
35 EPSEST	Estimate of future earnings per share for company
36 BETAALPH	Computes alpha and beta variables for stock
37 SHARPE1	Portfolio selection model i.e. what stocks to hold
38 OPTWRITE	Option writing computations
39 RTVAL	Value of a right
40 EXPVAL	Expected value analysis
41 BAYES	Bayesian decisions
42 VALPRINF	Value of perfect information
43 VALADINF	Value of additional information
44 UTILTY	Derives utility function
45 SIMPLEX	Linear programming solution by simplex method
46 TRANS	Transportation method for linear programming
47 EOQ	Economic order quantity inventory model
48 QJUE1	Single server queueing (waiting line) model
49 CVP	Cost-volume-profit analysis
50 CONDPFOP	Conditional profit tables
51 OPTLOSS	Opportunity loss tables
52 FQJQ	Fixed quantity economic order quantity model
53 FQEQWSH	As above but with shortages permitted
54 FQEQQPB	As above but with quantity price breaks
55 QJUECB	Cost-benefit waiting line analysis
56 NCFANAL	Net cash-flow analysis for simple investment
57 PROFIND	Profitability index of a project
58 CAPI	Cap. Asset Pr. Model analysis of project

59 WACC	Weighted average cost of capital
60 COMBPAL	True rate on loan with compensating bal. required
61 DISCBAL	True rate on discounted loan
62 MERGANAL	Merger analysis computations
63 FINRAT	Financial ratios for a firm
64 NPV	Net present value of project
65 PRINDLAS	Laspeyres price index
66 PRINDPA	Paasche price index
67 SEASIND	Constructs seasonal quantity indices for company
68 TIMETR	Time series analysis linear trend
69 TIMEMOV	Time series analysis moving average trend
70 FUPRINF	Future price estimation with inflation
71 MAILPAC	Mailing list system
72 LETWRT	Letter writing system-links with MAILPAC
73 SORT3	Sorts list of names
74 LABEL1	Shipping label maker
75 LABEL2	Name label maker
76 BUSBUD	DOME business bookkeeping system
77 TIMECLK	Computes weeks total hours from timeclock info.
78 ACCTPAY	In memory accounts payable system-storage permitted
79 INVOICE	Generate invoice on screen and print on printer
80 INVENT2	In memory inventory control system
81 TELDIR	Computerized telephone directory
82 TIMUSAN	Time use analysis
83 ASSIGN	Use of assignment algorithm for optimal job assign.
84 ACCTREC	In memory accounts receivable system-storage ok
85 TERMSPAY	Compares 3 methods of repayment of loans
86 PAYNET	Computes gross pay required for given net
87 SELLPR	Computes selling price for given after tax amount
88 ARBCOMP	Arbitrage computations
89 DEPRSF	Sinking fund depreciation
90 UPSZONE	Finds UPS zones from zip code
91 ENVELOPE	Types envelope including return address
92 AUTOEXP	Automobile expense analysis
93 INSFILE	Insurance policy file
94 PAYROLL2	In memory payroll system
95 DILANAL	Dilution analysis
96 LOANAFD	Loan amount a borrower can afford
97 RENTPRCH	Purchase price for rental property
98 SALELEAS	Sale-leaseback analysis
99 RRCONVBD	Investor's rate of return on convertible bond
100 PORTVAL9	Stock market portfolio storage-valuation program

- TRS-80 Cassette Version \$99.95
- TRS-80 (Mod-I or III), Pet, Apple or Atari Versions \$99.95
- TRS-80 Mod-II, IBM, Osborne and 8" CP/M Versions \$149.95

ADD \$3.00 FOR SHIPPING IN UPS AREAS
ADD \$4.00 FOR C.O.D. OR NON-UPS AREAS
ADD \$5.00 TO CANADA AND MEXICO
ADD PROPER POSTAGE OUTSIDE OF U.S., CANADA AND MEXICO

COMPUTRONICS
MATHEMATICAL APPLICATIONS SERVICE™

50 N. PASCACK ROAD
SPRING VALLEY, NEW YORK 10977

ASK FOR OUR 64-PAGE CATALOG

**NEW TOLL-FREE
ORDER LINE
(OUTSIDE OF N.Y. STATE)
(800) 431-2818**



**24 HOUR
ORDER
LINE**



(914) 425-1535



ALL PRICES & SPECIFICATIONS SUBJECT TO CHANGE
DELIVERY SUBJECT TO AVAILABILITY

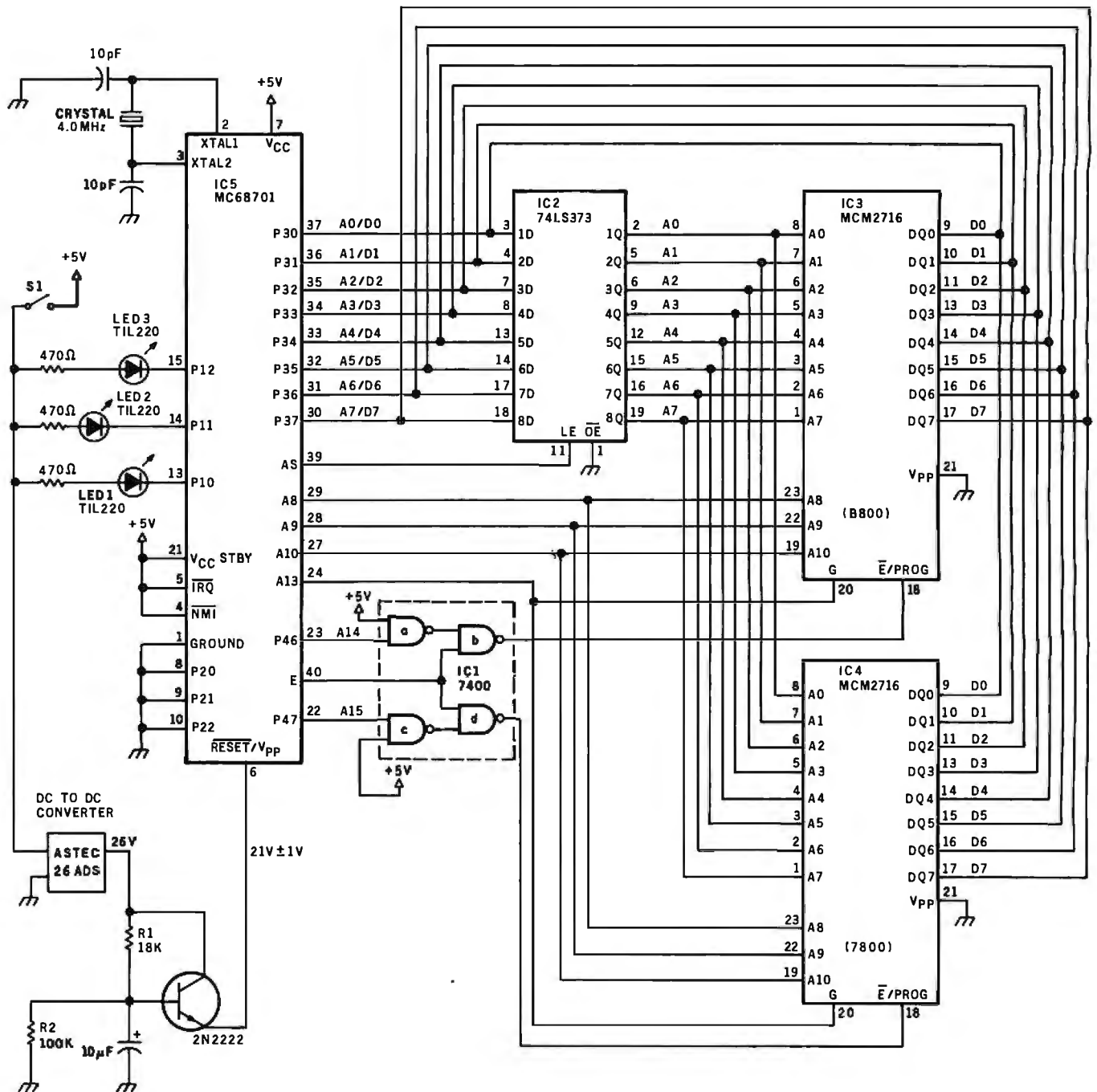

Figure 2: Programmer for the MC68701. The simplicity of this inexpensive circuit means easy construction and use. In combination with the software provided in listing 1, LEDs in the programmer can indicate that the EPROM is initially erased and that the newly stored data pass or fail a verification test.

reset vectors should direct the processor to what is essentially a bootstrap-loading program that will fetch data sequentially from memory or a peripheral controller and "burn" each byte into the EPROM. Once V_{pp} is applied to the $\overline{\text{RESET}}/V_{pp}$ pin, each data byte is programmed into the onboard EPROM as follows:

1. Clear the PLC bit and set the PPC bit. This enables the EPROM address latch and inhibits V_{pp} to the EPROM.
2. Write data to the EPROM location to be programmed. Both the data and address will be captured by internal latches.

3. Clear the PPC bit for 50 milliseconds (ms). This controls programming power to the EPROM, allowing the data byte to be burned in.

These steps are repeated until all bytes have been programmed.

An MC68701 Programmer

Fully assembled and tested modules designed to program the MC68701 are available through Motorola distributors. Some users, however, may require custom programming boards designed to meet specific needs.

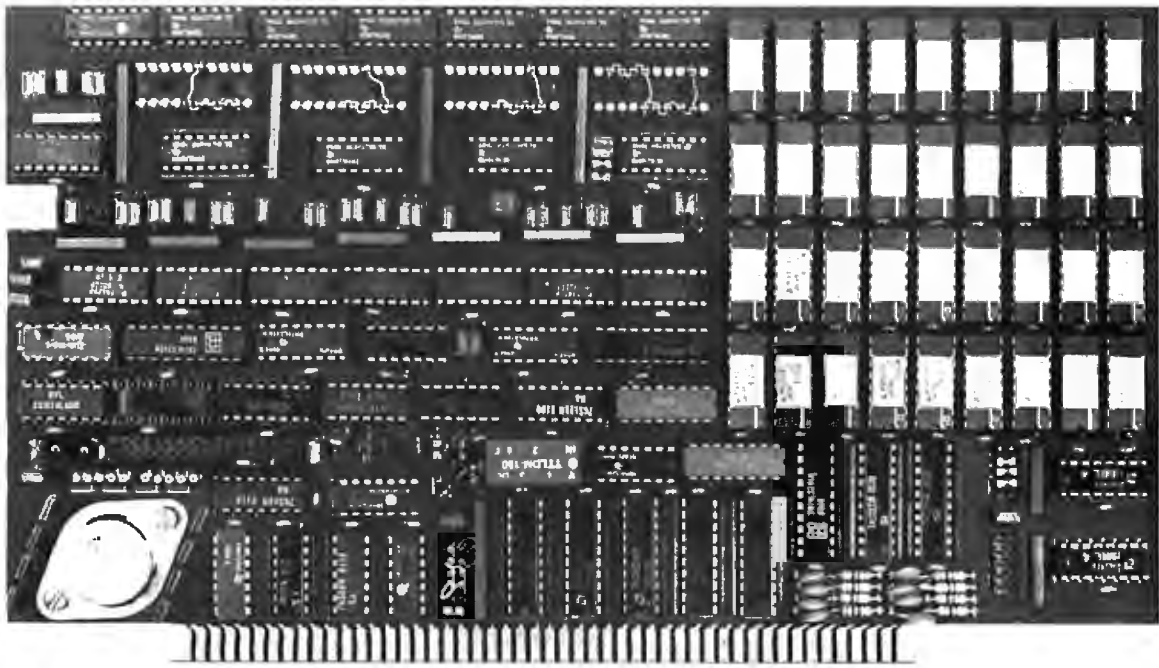

How to Get 256K of 16K Increment Bank Selectable Memory or 2 Megabytes of Contiguous Memory on One S100 Board

The 256 KMB-100 from Intercontinental Micro Systems is one of the most flexible and easily integrated S100 bus, 256K memories available today. Its advanced features include:

- Complete Cromix™, CP/M™, MP/M™ and other major systems compatibility—up to 16 users are now possible on a Cromemco System.
- Bank selectable in any combination of 16K banks (e.g. 4 64K users, 8 32K users, 16 16K users or any other combination.)
- Up to 2 contiguous megabytes are easily configurable.
- Configures for phantom deselection.
- Deselectable on 4K boundaries from 4K to 64K.
- 4 MegaHertz operation, no wait states.
- Parity error detection through interrupts.
- IEEE 696.1/D2 Spec S100 Bus.
- One year complete warranty.
- Fully compatible with Intercontinental Micro's advanced CPZ-48000 S100 Bus single board CPU, which features: Z80 based system, single or double density floppy disk controller, 64K onboard dynamic RAM, 4 channel DMA controller and memory management.

The others are still talking about their S100 Bus 256K memories—ours is in production—call today for further details and applications information.



1733 South Douglass Road, Suite E
Anaheim, California 92806
(714) 978-9758 Telex: 678401-TAB-IRIN

™ Cromix is a trademark of Cromemco Inc. ™ CP/M and MP/M are trademarks of Digital Research, Inc.

JOHN STARKWEATHER'S NEVADA PILOT

\$149.95

DISKETTE AND MANUAL

For all CP/M systems. Works with Apple (softcard needed), Osborne 1, TRS-80, North Star, Superbrain, Micropolis, Vector and many other microcomputers. Needs 32K RAM, one disk drive and CRT or video display and keyboard.

- PILOT for Programmed, Inquiry, Learning Or Teaching.
- An excellent interactive language for education and office automation.
- Perfect companion for BASIC, COBOL and PASCAL to solve training and documentation problems.
- John Starkweather, Ph.D., creator of PILOT, wrote this version to meet all PILOT-73 standards and added many new features.
- New features include full screen text editor, commands to drive optional equipment such as VTR's & voice response units.
- Currently used in many college and progressive high schools.
- Use for interactive applications—data entry, programmed instruction and testing.

NEVADA EDIT

\$119.95

DISKETTE AND MANUAL

For all CP/M-based systems. Requires 32K RAM, one disk drive and CRT or video display and keyboard.

- A character oriented full screen video display text editor designed specifically for program preparation of COBOL, FORTRAN, BASIC and similar programs.
- Features include single key commands for cursor control, scrolling, block moves, search and replace, tab setting and multiple file insertions.

NEVADA COBOL



\$199.95

DISKETTE AND MANUAL

For all CP/M or MP/M operating systems. Requires 32K RAM and one disk drive.

- Edition II of Nevada COBOL is based on ANSI-74 Standards.
- With 48K RAM, you can compile and execute up to 4000 statements.
- COPY statement for library handling.
- CALL...USING...CANCEL
- PERFORM...THRU...TIMES...UNTIL... paragraph or section names.
- IF...NEXT SENTENCE...ELSE...NEXT SENTENCE AND/OR <=> NOT.
- GO TO...DEPENDING ON...
- Interactive ACCEPT/DISPLAY...
- RELATIVE (random) access files
- Sequential files both fixed and variable length.
- INSPECT...TALLYING...REPLACING.



ELLIS COMPUTING
SOFTWARE TECHNOLOGY

600 41st Avenue, Dept. B
San Francisco, CA 94121
U.S.A.

CP/M, MP/M, TRS-80 and SoftCard system are registered TM's of Digital Research, Tandy Corporation and Microsoft respectively. Osborne 1 is a trademark of Osborne Computer Corporation.

COD's WELCOME



(415) 751-1522

The programmer described in this article (see figure 2) is designed for simplicity, low cost, and ease of use. The hardware and associated software verify that an inserted MC68701 is initially fully erased, do the programming, and verify the "entered" code. The user only applies power and monitors three light-emitting diodes (LEDs) that indicate EPROM status. The programmer enters the entire 2K-byte content of EPROM IC4 into the MC68701 EPROM. The system can be modified to, for instance, provide more detailed failure information or to program only a portion of the EPROM.

Using the Programmer

The user needs no knowledge of MC68701 operation and very little knowledge of electronics in order to use the programmer. Four steps are required:

1. Insert the EPROM containing the code to be programmed into the MC68701 into the socket at IC4.
2. Insert the MC68701 into the socket.
3. Apply power.
4. Monitor LEDs.

Within a few seconds after power is applied, LED 1 should light, indicating that the MC68701 EPROM is fully erased. Approximately 105 seconds after power is applied, LED 2 should light, indicating that the EPROM has been programmed and its contents verified. At this time, power can be removed from the system, and another MC68701 can be programmed.

LED 3 will light to indicate either a not fully erased MC68701 EPROM when power is initially applied, or failure to verify after attempted programming. If LED 3 lights and LED 1 is not lit, the MC68701 was not fully erased when inserted into the board. If this occurs, no attempt is made to program the EPROM. If LED 3 lights while LED 1 is lit, the EPROM's contents did not verify after attempted programming.

The LEDs should be color-coded to give readily recognized *pass* and *fail* indication. A good color scheme is amber for LED 1 (erased), green for LED 2 (pass), and red for LED 3 (fail). Zero insertion force sockets should be used for the MC68701 and EPROM.

Memory Map

The memory map, consisting of five special address spaces, is shown in figure 3. Four of the address spaces are fixed by the MC68701 during programming and cannot be relocated. These consist of an internal-register area (0000 to 001F hexadecimal), internal RAM (0080 to 00FF hexadecimal), external interrupt vectors (BFF0 to BFFF hexadecimal), and internal EPROM (F800 to FFFF hexadecimal).

A fifth address space is used for an MCM2716 that contains the code to be entered into the MC68701 on-chip EPROM. This MCM2716 has been arbitrarily placed at locations 7800 to 7FFF hexadecimal and can be relocated for custom programmer design.

Apple* en CASTELLANO

Tercer Medio presenta su sistema administrativo (T.M.A.) para Apple

Diseñado de acuerdo con los principios contables aceptados en todos los países de habla hispana.

APLICACIONES COMERCIALES Y CIENTIFICAS

- **CONTABILIDAD GENERAL**

Diario General
Resumen del Diario
Consulta parcial al Diario Mayor General
Balance de Comprobación
Balance General
Ganancias y Pérdidas
Catálogos de Cuentas
Consultas por pantalla

- **CUENTAS POR COBRAR**

Catálogo de Cuentas
Listado de Transacciones
Antigüedad de Saldos
Saldos por Vencer
Relación de Cobranzas
Relación de Pagos
Estado de Cuentas
Consultas varias por pantalla

- **INVENTARIO Y FACTURACION**
- **CONTROL DE BANCOS**
- **PERT/CPM**
- **CUENTAS A PAGAR**
- **CONTROL DE COSTO DE OBRAS**

VENTAJAS DEL SISTEMA T.M.A.

- Son completamente conversacionales.
- El chequeo de la información es instantáneo.
- Los reportes impresos o por pantalla guardan los formatos generalmente aceptados.
- Están pensados para adaptarse a cualquier empresa.
- Toda la información está instantáneamente disponible
- Precisión Expandida.
- Números de hasta + 999.999.999,99

Circle 402 on Inquiry card.



Tercer Medio
Sistema de Información C.A.

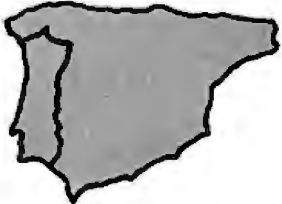

APARTADO DE CORREOS 62533
CARACAS 1060 - A - VENEZUELA
TELEX: 27.876 - CPB TH - VE.
TELEFONOS: 283.60.88 - 284.74.68

* Apple es marca registrada por APPLE COMPUTER INC.

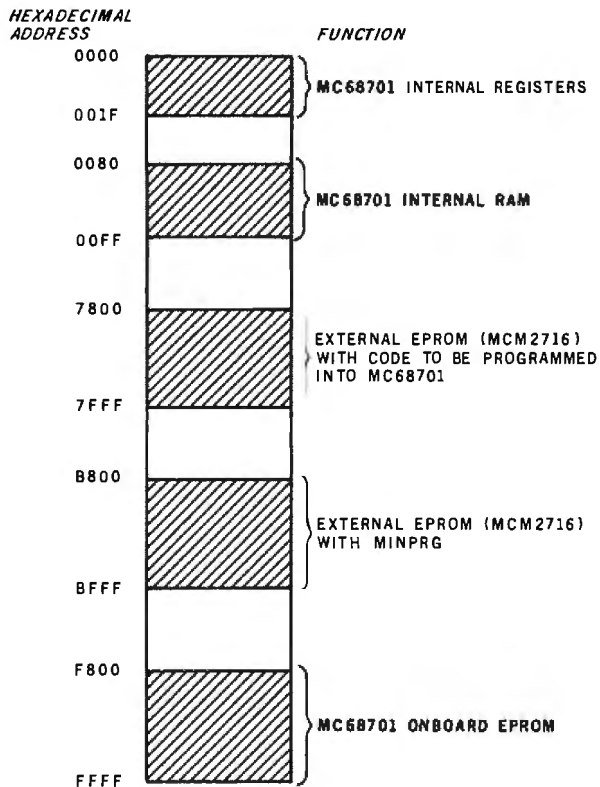

Figure 3: Memory map of the MC68701 address space.

For ease of decoding, an MCM2716 containing MINPRG, the programmer bootstrap program, is based at location B800 hexadecimal. The system RESET vectors are located at the top of the EPROM and decode at locations BFFE to BFFF hexadecimal.

Circuit Description

The MC68701 programmer consists of two MCM2716 EPROMs, a 74LS373 transparent latch, a 74LS00 NAND gate package, an MC68701 socket, and associated "glue," as shown in figure 2.

A 4-megahertz (MHz) crystal is used to yield 1-MHz operation. This clock frequency can be increased to accommodate higher-speed MC68701s, but changes in the operating frequency require changes in the MINPRG bootstrap software to ensure 50 ms programming time for each byte entered into the EPROM, or to minimize programming time.

This delay is governed by the value of WAIT in MINPRG and is indirectly related to the clock frequency. An increase in the clock frequency requires a proportional increase in the value of WAIT; a decrease of the clock frequency allows a proportional decrease in the value of WAIT.

The MC68701 can also be driven by an external transistor-transistor logic (TTL) clock at pin 3, with pin 2 grounded. If this clock option is used, the capacitors tied to pins 2 and 3, used to ensure stable crystal operation, are not required.

Pins 8, 9, and 10 are tied to ground to place the MC68701 into Mode 0 (programming mode) at RESET. IRQ (interrupt request) and NMI (nonmaskable interrupt) are tied high to eliminate external interrupts.

Three LEDs are tied to I/O pins 13, 14, and 15. They are used to indicate the state of the MC68701 EPROM during programming operations. High-current drivers force the pins low to light the LEDs.

The $\overline{\text{RESET}}/V_{pp}$ pin is driven by a transistor to assure adequate power to the pin during programming. The base of this transistor is controlled by an RC (resistor-capacitor) network that provides adequate delay between

*Text continued on page 394
Listing 1 is on pages 388-392*

THE LAST ONE™
THE PROGRAM THAT WRITES PROGRAMS

AVAILABLE FOR

TRS - 80 MLD II CP/M
Apple II Plus Sharp PC 3201
North Star Vantage

Still Only \$600.00

Dealer Inquiries Invited

Send to **KROWN COMPUTING**
1282 Conference Dr., P.O. 66763
Scotts Valley, CA 95066
(408) 335-3133

Circle 225 on inquiry card.

WMS IMPERIAL MICRO SUPPLY LTD.

Scotch DISKETTES

DISKS SCOTCH 3M

5¼" \$2.30 each
Reinforced Hubs, Any Quantity
Save more on 100 or more boxes \$2.25 ea.

MEMORY RAM

4116-200NS 8/\$16
4164-200NS \$10 each

EPROMS

2716 (5V) \$5.50 each

X-TALS MHZ \$2.25 each

1.0	3.579545	5.0688	10.0	18.0
2.0	4.0	5.7143	14.31818	20.00
3.0	5.0	8.0	16.0	

WMS IMPERIAL MICRO SUPPLY LTD.
P.O. BOX 833, DEPT. M, PONTIAC, MI 48056
Please add \$2.00 Shipping — Michigan add 4% Tax

Circle 199 on inquiry card.

LARGE DISK CP/M USERS

TIRED OF SEARCHING DIRECTORY LISTINGS FOR YOUR FILES???
ANNOUNCING the CPUTIL package:

- Allows system files to be logically moved to the current user file upon logon. This means that multiple copies of system files are not needed.
- Removes all system files from directory listings unless desired by the user.
- Restores all system files to file 0 upon logoff.
- Allows user files to be referred to by a user-defined name or the file number.
- Allows a directory listing of any user file from any other user file.

INTRODUCTORY PRICE \$49.95
including manuals
Texas res. add 6% sales tax

EARTH SCIENCE ASSOC.
10218 Cantertrot
Humble, Tx. 77338
713-446-1555

SATISFACTION GUARANTEED

Circle 157 on inquiry card.

TECHNOLOGY ADVANCES

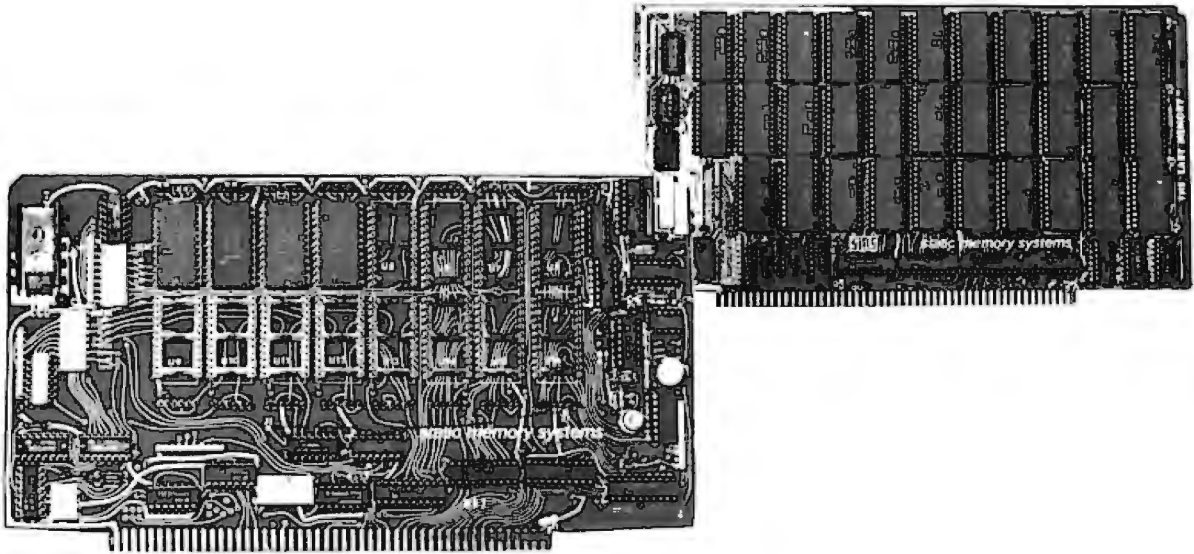

THE LAST MEMORY™ is a high performance 64K memory module for 8 bit S100 systems. This board uses 16K byte-wide static RAM's which eliminate the timing and reliability problems associated with dynamic RAM boards. The 2K by 8 architecture of these RAM's allow high density and low power consumption, a characteristic not found in most static memories. This architecture also allows the use of 2716 type EPROM's in place of RAM IC's with no modification. As a result, this one board provides total system memory. **THE LAST MEMORY™** is available starting at less than \$100.00

LASTING MEMORY™ is a combination EEPROM (Electrically Erasable PROM)/EPROM/RAM memory module for 8 bit S100 systems. This board includes an onboard EEPROM programmer which programs and erases 2816/2815 type EEPROM's with normal memory write instructions - no special software is required. Erasing and writing may be performed one byte at a time - no need to start over to make simple changes. Programming may be performed in any socket - EEPROM's can be tested and used without moving them. EEPROM's, 2716 type EPROM's, or 16K byte-wide static RAM's may be located in any of the 16 memory sockets for a total of 32K bytes of memory. **LASTING MEMORY™** is available at \$299.

The **VIBI™** is an intelligent I/O mapped CRT controller for use within S100 BUS (IEEE 696) systems. It incorporates all the video display capabilities of a stand-alone smart terminal. Some of its outstanding features include: 80 characters x 24 lines with an independent 25th line; full ASCII character set including control characters; graphics characters set; six visual attributes which can be used in combination; extensive screen editing and screen read capabilities. The **VIBI™** will be available in the 4th quarter 1982 at less than \$300.

ideaLink™ is a high speed FSK modem which plugs into the S100 BUS (IEEE 696) and connects to a standard telephone in place of the handset. It is Bell 103/202 compatible offering both 300 Bps full duplex and 1200 Bps half duplex. All signal processing is performed digitally for long term reliability. **ideaLink™** will be available in the 4th quarter 1982 at less than \$300.



static memory systems inc.

401 State Bank Center
Freeport, IL 61032 (815) 235-8713
9 A.M. to 4 P.M. Mon. - Fri.

MC VISA accepted
All prices net, FOB Freeport, IL
OEM discounts available
Dealer inquiries invited.

Listing 1: MINPRG is the software that allows the MC68701 to program itself.

```

00001          *
00002          *
00003          OPT      Z01,LLEM=80
00004          *
00005          *
00006          *      THIS PROGRAM WILL CHECK, PROGRAM AND VERIFY
00007          *      THE MC68701'S EPROM
00008          *
00009          *
00010          *      E Q U A T E S
00011          0000  A P1DDR EQU  $00  PORT 1 DATA DIR. REGISTER
00012          0002  A P1DR  EQU  $02  PORT 1 DATA REGISTER
00013          0008  A TCSR  EQU  $08  TIMER CONTROL/STAT REGISTER
00014          0009  A TIMER EQU  $09  COUNTER REGISTER
00015          000B  A OUTCMP EQU  $0B  OUTPUT COMPARE REGISTER
00016          0014  A EPMCNT EQU  $14  RAM/EROM CONTROL REGISTER
00017          *
00018          *      L O C A L   V A R I A B L E S
00019          *
00020A 0080          ORG      $80
00021A 0080          0002  A IMBEG RMB  2      START OF MEMORY BLOCK
00022A 0082          0002  A IMEND RMB  2      LAST BYTE OF MEMORY BLOCK
00023A 0084          0002  A PNTR  RMB  2      FIRST BYTE OF EPROM TO BE PGM'D
00024A 0086          0002  A WAIT  RMB  2      COUNTER VALUE
00025          *
00026A B850          ORG      $B850
00027A B850 8E 00FF  A START  LDS  #$FF      INITIALIZE STACK
00028A B853 86 07    A        LDAA #$07      INIT. PORT 1
00029A B855 97 00    A        STAA P1DDR     DDR
00030A B857 97 02    A        STAA P1DR      DATA REGISTER (ALL LED'S OFF)
00031          * *
00032A B859 CE F800  A        LDX  #$F800    CHECK IF EPROM ERASED
00033A B85C DF 84    A        STX  PNTR      INIT. PNTR WHILE CONVENIENT
00034A B85E C6 00    A        LDAB #$00      GET READY FOR CMPR.
00035A B860 A6 00    A ERASE  LDAA  0,X      LOAD EPROM CONTENTS
00036A B862 11      CBA        COMPARE TO ZERO
00037A B863 26 29 B88E RNE  ERROR1  BRANCH IF NOT ZERO
00038A B865 8C FFFF  A        CPX  $FFFF    CHECK IF DONE
00039A B868 27 03 B86D BEQ  NEXT     IF SO BRANCH
00040A B86A 08      INX        GO AGAIN
00041A B86B 20 F3 B860 BRA  ERASE
00042          * *
00043A B86D 86 06    A NEXT  LDAA  #$06      TURN ON ERASED LED
00044A B86F 97 02    A        STAA  P1DR
00045          * *
00046          *      WAIT FOR VPP TO REACH 21V (3.5 SEC.)
00047          *
00048A B871 DF 86    A        STX  WAIT
00049A B873 CE 0046  A        LDX  #$0046    GET READY FOR 70 TIMES THRU LOOP
00050A B876 09      STALL1  DEX
00051A B877 CC C350  A        LDD  #$C350    INIT. 50MS LOOP
00052A B87A D3 09    A        ADDD  TIMER     BUMP CURRENT VALUE
00053A B87C 7F 0008  A        CLR  TCSR      CLEAR OCF
00054A B87F DD 0B    A        STD  OUTCMP    SET OUTPUT COMPARE
00055A B881 86 40    A        LDAA  $40      NOW WAIT FOR OCF
00056A B883 95 08    A STALL2  BITA  TCSR
00057A B885 27 FC B883 BEQ  STALL2  NOT YET
00058A B887 8C 0000  A        CPX  $0000    70 TIMES YET?

```

Listing 1 continued on page 390

1-UPMANSHIP.



We opened our doors with two basic goals:

To distribute as many software packages to as many dealers as possible.

And to make money doing so.

Our success on both counts is the result of hard work, a positive business attitude and a recognition that you, as a retailer, have a right to be treated fairly and honestly by your distributor.

We're 1-up for three good reasons:

1. We always offer a wide selection of the latest and best microcomputer software packages available anywhere. (Why should you have to hunt for what you need?)
2. Our dealer discounts start with quantities of 1. (Remember all those times you just wanted one or two to see how they'd sell?)
3. We don't play The BackOrder Game. (If we can't ship your order within 48 hours we'll let you know, instead of hanging you out to dry.)

If there's anything else we can do for you, just let us know. Because we're 1-up and we intend to stay that way.

Software Distributors, 9929 Jefferson Blvd., Culver City, CA 90230. Telex 4990032 BVHL, ATT: SOFT

For our dealer info package, call (213) 559-9330.

SOFTWARE DISTRIBUTORS

We won't leave you holding the bag.

Circle 376 on inquiry card.

Listing 1 continued:

```

00059A B88A 26 EA B876      BNE    STALL1    NOPE
00060A B88C 20 06 B894      BRA    PGINT
00061      * *
00062A B88E 86 83      A ERROR1 LDAA    #$83      LIGHT ERROR LED ONLY
00063A B890 97 02      A      STAA    P1DR
00064A B892 20 5D B8F1      BRA    SELF
00065      * *
00066A B894 CE 7800      A PGINT LDX    #$7800    INIT. IMBEG
00067A B897 DF 80      A      STX    IMBEG
00068A B899 CE 7FFF      A      LDX    #$7FFF    INIT. IMEND
00069A B89C DF 82      A      STX    IMEND
00070A B89E CE C350      A      LDX    #$C350    INIT. WAIT (4.0 MHZ)
00071A B8A1 DF 86      A      STX    WAIT
00072      *
00073      *      THIS PART FROM 68701 DATA SHEET
00074      *
00075A B8A3 DE 84      A EPROM LDX    PNTR      SAVE CALLING ARGUMENT
00076A B8A5 3C          PSHX      RESTORE WHEN DONE
00077A B8A6 DE 80      A      LDX    IMBEG    USE STACK
00078      *
00079A B8A8 3C          EPROO2 PSHX      SAVE POINTER ON STACK
00080A B8A9 86 FE      A      LDAA    #$FE      REMOVE VPP, SET LATCH
00081A B8AB 97 14      A      STAA    EPMCNT    PPC=1,PLC=0
00082A B8AD A6 00      A      LDAA    0,X      MOVE DATA MEMORY-TO-LATCH
00083A B8AF DE 84      A      LDX    PNTR      GET WHERE TO PUT IT
00084A B8B1 A7 00      A      STAA    0,X      STASH AND LATCH
00085A B8B3 08          INX      NEXT ADDR.
00086A B8B4 DF 84      A      STX    PNTR      ALL SET FOR NEXT
00087A B8B6 86 FC      A      LDAA    #$FC      ENABLE EPROM POWER (VPP)
00088A B8B8 97 14      A      STAA    EPMCNT    PPC=0,PLC=0
00089      *
00090      *      NOW WAIT 50 MSEC TIMEOUT USING COMPARE
00091      *
00092A B8BA DC 86      A      LDD    WAIT      GET CYCLE COUNTER
00093A B8BC D3 09      A      ADDD   TIMER      BUMP CURRENT VALUE
00094A B8BE 7F 0008      A      CLR    TCSR      CLEAR OCF
00095A B8C1 DD 0B      A      STD    OUTCMP    SET OUTPUT COMPARE
00096A B8C3 86 40      A      LDAA    #$40      NOW WAIT FOR OCF
00097A B8C5 95 08      A EPROO4 BITA    TCSR
00098A B8C7 27 FC B8C5      BEQ    EPROO4    NOT YET
00099      *
00100A B8C9 38          PULX      SET UP FOR NEXT ONE
00101A B8CA 08          INX      NEXT
00102A B8CB 9C 82      A      CPX    IMEND     MAYBE DONE
00103A B8CD 23 D9 B8A8      BLS    EPROO2    NOT YET
00104A B8CF 86 FF      A      LDAA    #$FF     REMOVE VPP, INHIBIT LATCH
00105A B8D1 97 14      A      STAA    EPMCNT    EPROM CAN NOW BE READ
00106A B8D3 38          PULX      RESTORE PNTR
00107A B8D4 DF 84      A      STX    PNTR
00108      * *
00109      *      START NEW CODE
00110      *
00111A B8D6 CE 7800      A      LDX    #$7800    SET UP POINTER
00112A B8D9 3C          VERF2 PSHX      SAVE POINTER ON STACK
00113A B8DA A6 00      A      LDAA    0,X      GET DESIRED DATA
00114A B8DC DE 84      A      LDX    PNTR      GET EPROM ADDR.
00115A B8DE E6 00      A      LDAB   0,X      GET DATA TO BE CHECKED
00116A B8E0 11          CRA      CHECK IF SAME

```

Listing 1 continued on page 392

Listing 1 continued:

```

00117A B8E1 25 10 B8F3      BNE      ERROR2      BRANCH IF ERROR(LIGHT LED)
00118A B8E3 08              INX              NEXT ADDR
00119A B8E4 DF 84      A      STX      PNTR      ALL SET FOR NEXT
00120A B8E6 38              PULX            SETUP FOR NEXT ONE
00121A B8E7 08              INX              NEXT
00122A B8E8 8C 8000      A      CPX      #$8000      MAYBE DONE
00123A B8EB 25 EC B8D9      BNE      VERF2      NOT YET
00124      * *
00125A B8ED 86 84      A      LDAA     #$84
00126A B8EF 97 02      A      STAA     P1DR      LIGHT VERIFY LED
00127      * *
00128A B8F1 20 FE B8F1      SELF     BRA      SELF      WAIT FOREVER
00129      * *
00130A B8F3 86 82      A      ERROR2 LDAA     #$82      LIGHT ERROR & ERASED LED'S
00131A B8F5 97 02      A      STAA     P1DR
00132A B8F7 20 F8 B8F1      BRA      SELF
00133      * *
00134      *      R E S T A R T      A N D      I N T R . V E C .
00135      *
00136A BFF0              ORG      $BFF0
00137A BFF0      B8F1      A      FDB      SELF
00138A BFF2      B8F1      A      FDB      SELF
00139A BFF4      B8F1      A      FDB      SELF
00140A BFF6      B8F1      A      FDB      SELF
00141A BFF8      B8F1      A      FDB      SELF
00142A BFFA      B8F1      A      FDB      SELF
00143A BFFC      B8F1      A      FDB      SELF
00144A BFFE      B850      A      FDB      START
00145      END
TOTAL ERRORS 00000--00000

```

```

0014 EPMCNT 00016*00081 00088 00105
B8A3 EPROM 00075*
B8A8 EPROO2 00079*00103
B8C5 EPROO4 00097*00098
B860 ERASE 00035*00041
B88E ERROR1 00037 00062*
B8F3 ERROR2 00117 00130*
0080 IMBEG 00021*00067 00077
0082 IMEND 00022*00069 00102
B86D NEXT 00039 00043*
000B OUTCMP 00015*00054 00095
0000 P1DDR 00011*00029
0002 P1DR 00012*00030 00044 00063 00126 00131
B894 PGINT 00060 00066*
0084 PNTR 00023*00033 00075 00083 00086 00107 00114 00119
B8F1 SELF 00064 00128*00128 00132 00137 00138 00139 00140 00141 00142
00143
B876 STALL1 00050*00059
B883 STALL2 00056*00057
B850 START 00027*00144
0008 TCSR 00013*00053 00056 00094 00097
0009 TIMER 00014*00052 00093
B8D9 VERF2 00112*00123
0086 WAIT 00024*00048 00071 00092

```

Terms: COD, MC, Visa, Cashier's Check
Shipping charges added to all orders.

\$499 ADDS VIEWPOINT

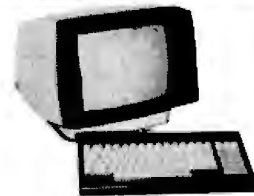

10MBYTE

Subsystem for Z-80/CP/M
Based computers.

Completely assembled and tested. Suggested ret.

\$2695

8" FLOPPY DISK DRIVES

QumeTrak 842	SPECIAL	Dual-sided	\$475.00 qty 1
Tandon TM 848-1		Single-sided, Thinline	425.00 qty 1
TM 848-2		Dual-sided, Thinline	545.00 qty 1
Shugart 801R		Single-sided	395.00 qty 1
851R		Dual-sided	525.00 qty 1
Mitsubishi M2894-63		Dual-sided, extremely reliable (11,000 MTBF)	475.00 qty 1
Remex 2000		Single-sided	475.00 qty 1
4000		Dual-sided	575.00 qty 1

5 1/4" FLOPPY DISK DRIVES

For the IBM Personal!

Tandon TM 100-1		Single-sided, 48TPI	245.00 qty 1
For IBM/Northstar/Cromemco			
Tandon TM 100-2		Dual-sided, 48TPI	325.00 qty 1
For Zenith/Heath SPECIAL!			
Tandon TM 100-4		Dual-sided, 96TPI	395.00 qty 1
QumeTrak 542		Dual-sided, 48TPI	310.00 qty 1
Remex PICO Drives	RFD 480	Dual-sided, slimline, 48TPI	375.00 qty 1
	RFD 960	Dual-sided, slimline, 96TPI	475.00 qty 1

5 1/4" WINCHESTER DRIVES

Tandon TM 602	6.4 Mb	1095.00 qty 1
Tandon TM 603	9.6 Mb	1195.00 qty 1

RIBBONS

QUME quickload multistrike	2.75 ea.
DIABLO multistrike	3.75 ea.
NEC multistrike	3.95 ea.
RICOH RP 1600 multistrike	5.95 ea.
EPSON MX-80/MX-70	9.00 ea.
IDS 450/460/500	7.50 ea.
WANG multistrike	3.95 ea.

All ribbons in stock for immediate shipment.
Prices quoted for **minimum quantity of 12.**

DISKETTES

5 1/4":	MAXELL MD1-DDM 96TPI SSDD	4.93 ea.
	MAXELL MD2-DDM 96TPI DSDD	5.61 ea.
	Scotch 745-0 48TPI DSDD	3.86 ea.
	DYSAN 204/1D 96TPI SSDD	4.95 ea.
	DYSAN 204/2D 96TPI DSDD	5.61 ea.
8":	Scotch 741-0 SSDD	3.05 ea.
	MAXELL FD1-128 SSDD	5.09 ea.

All diskettes in stock for immediate shipment.
Prices quoted for **minimum quantity of 100.**

FULL LINE OF RIBBONS AND DISKETTES IN STOCK! CALL FOR COMPLETE LISTING.

QUANTITY DISCOUNTS AVAILABLE — DEALER INQUIRIES INVITED!

4444 SCOTTS VALLEY DR., SCOTTS VALLEY, CA 95066 (408) 438-5454

HEXADECIMAL ADDRESS

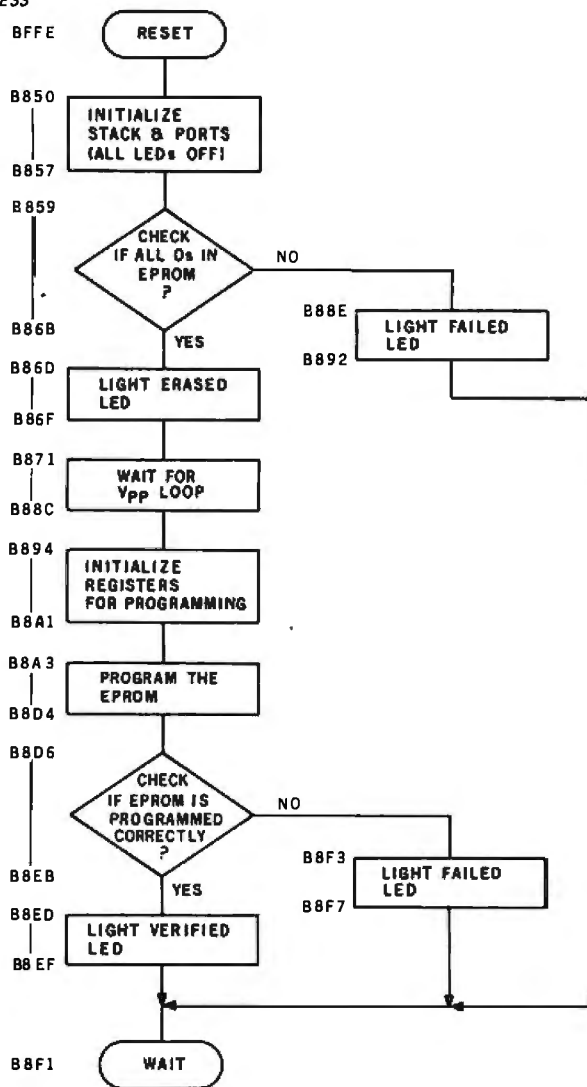

Figure 4: Flowchart of the programmer software called MINPRG. The program is shown in listing 1.

Text continued from page 386:

the application of V_{CC} and $\overline{\text{RESET}}$. During programming, $21\text{ V} \pm 1\text{ V}$ (V_{pp}) must be applied to the $\overline{\text{RESET}}/V_{pp}$ pin. A 5- to 26-V voltage converter is used to eliminate the need for two power supplies. R1 and R2 form a voltage divider that provides a proper voltage level to the $\overline{\text{RESET}}/V_{pp}$ pin. R2 also serves to discharge C1 during power-down.

A 74LS373 transparent latch is used to demultiplex port 3, which is used both as a lower address port (signals A0 through A7) and as a data port. An address strobe (AS) from the MC68701 is tied to latch enable (LE) of the 74LS373 to latch the lower-order address at the proper time each bus cycle. Once the lower address is latched, the port is used for data transfer.

Four NAND gates are used for address decoding of the two external EPROMs. Each EPROM is selected with high A13 to ensure deselection during access of MC68701 internal RAM and internal registers. EPROM IC3 drivers are enabled with low A14 and high E; EPROM IC4

drivers are enabled with low A15 and high E. Controlling with E ensures that drivers are in the high-impedance state during E low, eliminating driver contention on the multiplexed lower-address/data bus. Controlling the drivers with low A14/A15 assures separation between the off-chip and on-chip EPROM address spaces. EPROM IC3, containing MINPRG, is selected at locations B800 to BFFF hexadecimal; EPROM IC4, containing the program to be entered into the MC68701 EPROM, is selected at locations 7800 to 7FFF hexadecimal. Incomplete address decoding is used for IC3 and IC4 to minimize the number of devices used in the system, allowing their selection in several address spaces. Care must be taken when writing software for the system to ensure that only one device is accessed at any time.

Note that only Motorola MCM2716 EPROMs allow an optional active high chip select (pin 20) by tying V_{pp} (pin 21) low during reads. If non-Motorola 2716 EPROMs are used, V_{pp} must be tied high and A13 must be inverted to the active low chip selects.

Program Description

The programmer uses a bootstrap program, MINPRG, to control programming of the MC68701 EPROM. The program performs the following functions:

1. Initialize the MC68701.
2. Check that the EPROM is erased.
3. Program the EPROM.
4. Verify the program.
5. Stop.

MINPRG also controls three LEDs that indicate MC68701 EPROM status during programmer operation. A detailed flowchart of MINPRG is shown in figure 4; a complete listing is shown in listing 1 on page 388.

Program Modifications and Considerations

Additions and modifications to this code can be made easily by inserting routines between the basic blocks on the flowchart. For convenience, the start and stop addresses of each block are located directly to the left of each block.

Parameters IMBEG, IMEND, PNTR, and WAIT, stored in RAM locations 80 to 87 hexadecimal, determine the size of the data block to be programmed into the MC68701, the first MC68701 EPROM location to be programmed, and the time period each byte will be burned into the EPROM. These parameters can be changed to allow programming of selected EPROM locations and to allow changes in operating frequency. These parameters, once selected, should remain constant throughout the entire program.

A modification to MINPRG that should be considered is verification of the EPROM if the EPROM is not initially erased, rather than to simply light LED 1 and wait. This change would allow verification of MC68701 EPROMs that have already been programmed and used. ■

Get Omni quality for as little as \$1.99... even if all you

Call toll-free for great savings on Omni's complete line of 5¼" premium disks. Each is certified error-free at a minimum of twice the error threshold of your system. Each is rated for more than 12 million passes without disk-related errors or significant wear. And each is precision fabricated to exceed all ANSI specifications with such standard features as reinforced hub rings and Tyvec sleeves. Get same day shipment and an



Be sure to indicate system name and model # at right.

# of 10 Packs	5¼" Disks	Price Per 10 Pack	Total Price
_____	Single side/single density	\$19.90	\$ _____
_____	Single side/double density	\$23.90	\$ _____
_____	Double side/double density	\$39.90	\$ _____
_____	Flip/Floppy reversible Double side/double density	\$39.90	\$ _____
_____	Protective plastic library case (in lieu of soft storage box)	\$ 2.99	\$ _____
	Shipping and handling		\$ 1.50
	5% sales tax (Mass. only)		\$ _____
	Total		\$ _____

Check
 COD

Master Card
 VISA

Card # _____ Exp. _____

System and model # _____

Name _____

Address _____

Tel. _____

Birth of a legend.



Epson.

A whole new generation of Epson MX printers has just arrived. And while they share the family traits that made Epson famous — like unequalled reliability and ultra-fine printing — they've got a lot more of what it takes to be a legend.

For instance, they've got a few extra type styles. Sixty-six, to be exact, including italics, a handy subscript and superscript for scientific notation, and enough international symbols to print most Western languages.

What's more, on the new-generation MX-80, MX-80 F/T and MX-100, you get GRAFTRAX-Plus dot addressable graphics. Standard. So now you can have precision to rival plotters in a reliable Epson printer. Not to mention true backspace, software printer reset, and programmable form length, horizontal tab and right margin.

All in all, they've got the features that make them destined for stardom. But the best part is that beneath this software bonanza beats the

Uh...three legends.

heart of an Epson. So you still get a bidirectional, logical seeking, disposable print head, crisp, clean, correspondence quality printing, and the kind of reliability that has made Epson the best-selling printers in the world.

All of which should come as no surprise, especially when you look at the family tree. After all, Epson *invented* digital printers almost seventeen years ago for the 1964 Tokyo Olympics. We were

the first to make printers as reliable as the family stereo. And we introduced the computer world to correspondence quality printing and disposable print heads. And now we've given birth to the finest printers for small computers on the market.

What's next? Wait and see. We're already expecting.

EPSON
EPSON AMERICA, INC.

3415 Kashiwa Street • Torrance, CA 90505 • (213) 539-9140

FEATURE	ORIGINAL MX-80	GRAFTRAX-80*	ORIGINAL MX-100	MX-80 with GRAFTRAX-Plus	MX-80 FT	MX-100
Bidirectional printing	X	X	X	X	X	X
Logical seeking function	X	X	X	X	X	X
Disposable print head	X	X	X	X	X	X
Speed: 80 CPS	X	X	X	X	X	X
Matrix: 9 x 9	X	X	X	X	X	X
Selectable paper feed			X		X	X
PAPER HANDLING FUNCTIONS						
Line spacing to n/216		X		X	X	X
Programmable form length	X	X	X	X	X	X
Programmable horizontal tabs	X	X	X	X	X	X
Skip over perforation			X	X	X	X
PRINT MODES AND CHARACTER FONTS						
96 ASCII characters	X	X	X	X	X	X
Italics character font		X		X	X	X
Special international symbols				X	X	X
Normal, Emphasized, Double-Strike and Double/Emphasized print modes	X	X	X	X	X	X
Subscript/Superscript print mode				X	X	X
Underline mode				X	X	X
10 CPI	X	X	X	X	X	X
5 CPI	X	X	X	X	X	X
17.16 CPI	X	X	X	X	X	X
8.58 CPI	X	X	X	X	X	X
DOT GRAPHICS MODE						
Line drawing graphics				X	X	X
Bit image 60 D.P.I.		X	X	X	X	X
Bit image 120 D.P.I.		X	X	X	X	X
CONTROL FUNCTIONS						
Software printer reset		X		X	X	X
Adjustable right margin			X	X	X	X
True back space		X		X	X	X
INTERFACES						
Standard — Centronics-style 8-bit parallel	X	X	X	X	X	X
Optional — RS-232C current loop w/2K buffer	X	X	X	X	X	X
RS-232C x-on/x-off w/2K buffer	X	X	X	X	X	X
IEEE-488	X	X	X	X	X	X

*Tandy TRS-80 block graphics only available with GRAFTRAX 80.

ABCDEFGHIJKLMNOP abcdefghi jklmn ABCDEFGHIJKLMNOP abcdefghi jklmn 01234
 ABCDEFGHIJKLMNOP abcdefghi jklmn ABCDEFGHIJKLMNOP abcdefghi jklmn 01234
 ABCDEFGHIJKLMNOP abcdefghi jklmn ABCDEFGHIJKLMNOP abcdefghi jklmn 01234
 ABCDEF abcdef ABCDEF abcdef 0123456
 ABCDEFGHIJKLMNOPQRSTUVWXYZ abcdefghi jklmnopqrstuvwxyz ABCDEFGHIJKLMNOPQRSTUVWXYZ abcdefghi jklmnopqrstuvwxyz 01234567
 ABCDEF abcdef ABCDEF abcdef 0123456
 ABCDEFGHIJKLMNOPQRSTUVWXYZ abcdefghi jklmnopqrstuvwxyz ABCDEFGHIJKLMNOPQRSTUVWXYZ abcdefghi jklmnopqrstuvwxyz 01234567
 ABCDEFGHIJKLMNOPQRSTUVWXYZ abcdefghi jklmnopqrstuvwxyz ABCDEFGHIJKLMNOPQRSTUVWXYZ abcdefghi jklmnopqrstuvwxyz 01234567

The Heath/Zenith Model 47 Dual Floppy-Disk System

Christopher O. Kern
201 I St. SW, Apt 839
Washington, DC 20024

The H-47-BA (also called the Z-47-BA) is a dual-drive 8-inch floppy-disk subsystem for the Heath H-8 and H-89 (or Z-89) computers (the "H" models are provided in kit form by Heath Company; "Z" designates assembled products sold by the parent Zenith Corporation). The H-/Z-47 (the BA suffix is dropped throughout) provides approximately 2 megabytes of online storage, which should be adequate for most hobby and many small-business purposes. Equally im-

portant, it provides standard IBM soft-sectored floppy-disk compatibility for the Heath/Zenith product line, which substantially increases the amount of software that is available.

Under CP/M, a formatted double-sided, double-density disk (with twenty-six 256-byte physical sectors per track) has 980K bytes of usable storage capacity. The comparable figure for HDOS is 999K bytes. The difference is the result of how the two operating systems organize their disk

directories and other supporting software. Heath's implementation of CP/M also supports an "extended double-density" format where each track is divided into eight sectors of 1024 bytes each. With extended double density, the usable capacity of a double-sided disk is 1208K bytes. This format is not in general use and disks using it normally will not be readable by other CP/M-based computer systems.

Disk deblocking under CP/M (transforming the 256- and 1024-byte sectors that are physically present on the disk into the 128-byte logical sector that CP/M expects) is invisible to the user. One of the advantages of the denser recording formats is that multiple logical read-sector operations can be performed by a single physical disk access. This speeds up disk I/O (input/output) because it is faster to withdraw data from a buffer in semiconductor memory than to read it from the disk. Both Heath-supplied operating systems identify the number of sides and the density of the disk at the time that it is logged in. Densities can be mixed, and a single-sided disk can be used in one drive while a

At a Glance

Name

H-47-BA, Z-47-BA

Type

Dual-drive 8-inch floppy-disk subsystem

Capacity

Up to 2.4 megabytes (1.2 megabytes/drive) depending on operating system and disk density

Manufacturer

Heath Company (H-47 kit)
Zenith Data Systems (Z-47-BA assembled unit)
Benton Harbor, MI 49022
(616) 982-3200

Price

\$2595, kit; \$3500, assembled

Computer

Heath H-8 (requires interface card, kit only, \$350; H-8 s equipped with 8080A processor require "extended configuration" option, \$65); Heath H-89 and Zenith Z-89 (require Z-89-47 interface card, assembled only, \$195; older units may need other minor hardware modifications)

Audience

Advanced hobbyists, business users of Heath computers who require large-capacity floppy-disk storage

THIS MONTH'S TOP TEN

CP/M® software for IBM, Osborne, Xerox, Apple, Televideo, TRS 80 II, SSSD, Northstar

TITLE	MANUFACTURER	LIST	NOW
dBase II	Ashion-Tale	700.00	499.00
WordStar	MicroPro	495.00	299.00
WordStar w/MaxMerge	MicroPro	645.00	385.00
Supercalc	Sorcim	295.00	210.00
Pascal MT +	D. Research	475.00	425.00
CalcStar	MicroPro	295.00	165.00
CB80	D. Research	500.00	420.00
Mathmagic	I.S. Mng	100.00	95.00
PL V/80	D. Research	500.00	420.00
Select w/Superspell	Select Info Systems	595.00	395.00

This is just a sample of the CP/M® software available from DataSource. Call us for the package you need in your format.

SMITH-CORONA TP-1

Daisy-wheel printer

689.00!



New letter-quality printer for IBM, Apple, TRS-80, Xerox, Osborne, etc. Unbelievable price for 120 wpm word processing quality. Parallel (Centronics) interface or RS232 serial interface (specify).

List 895.00 689.00
 Cable for TP-1 (specify computer) 40.00
 Apple parallel interface (w/cable) 120.00

Call for more great buys on C.I.T.O.H., Hayes, etc.

ORDER/TECHNICAL HOTLINE:

1-612-944-7907



ORDERING INFORMATION MAIL ORDERS: Cash or money order. Charge cards add 3%. Shipping \$3.00 per software item. 25% per hardware item. Min. res. add 5% sales tax. Pricing and avail. subj. to change. Prices are mail order only. DataSource is a Division of DataSource Systems Corporation. CP/M is a registered trademark of Digital Research Corp.

DataSource Systems

P.O. BOX 35007 MINNEAPOLIS, MN 55435 612-944-7907

TERMINALS FROM TRANSNET

PURCHASE PLAN • 12-24 MONTH FULL OWNERSHIP PLAN • 36 MONTH LEASE PLAN

	DESCRIPTION	PURCHASE PRICE	PER MONTH		
			12 MOS.	24 MOS.	36 MOS.
DEC	LA34 DECwriter IV Forms Ctrl.	\$1,095	\$105	\$ 58	\$ 40.
	LA100 Letter Printer RD.	1,995	190	106	72
	LA120 DECwriter III KSR.	2,295	220	122	83
	LA120 DECwriter III RD.	2,095	200	112	75
	LA12A Portable DECwriter.	2,950	280	155	106
	VT100 CRT DECscope.	1,695	162	90	61
	VT101 CRT DECscope.	1,195	115	67	43
	VT125 CRT Graphics.	3,295	315	185	119
	VT131 CRT DECscope.	1,745	167	93	63
	VT132 CRT DECscope.	1,995	190	106	72
TEXAS INSTRUMENTS	TI745 Portable Terminal.	1,595	153	85	58
	TI765 Bubble Memory Terminal.	2,595	249	138	93
	TI940 CRT.	1,795	173	96	65
	TI785 Portable KSR, 120 CPS.	2,395	230	128	86
LEAR SIEGLER	TI787 Portable KSR, 120 CPS.	2,845	273	152	102
	TI810 RD Printer.	1,695	162	90	61
	TI820 KSR Printer.	2,195	211	117	80
DATAMEDIA	ADM3A CRT Terminal.	595	57	34	22
	ADM5 CRT Terminal.	645	62	36	24
	ADM32 CRT Terminal.	1,165	112	65	42
TELEVIDEO	EXCEL 12 CRT Terminal.	1,595	153	85	58
	EXCEL 42 Smart Buffered CRT.	995	96	54	36
	COLORSCAN 10 Color CRT.	3,195	307	171	116
NEC SPINWRITER	910 CRT Terminal.	650	62	36	24
	925 CRT Terminal.	850	82	46	31
	950 CRT Terminal.	1,075	103	57	39
GENERAL ELECTRIC	Letter Quality, 7715 RD.	2,895	278	154	104
	Letter Quality, 7725 KSR.	3,295	316	175	119
EPSON	2030 KSR Printer 30 CPS.	1,195	115	67	43
	2120 KSR Printer 120 CPS.	2,195	211	117	80
TIMEPLEX	MX-80 F/T Printer.	745	71	42	27
	MX-100 Printer.	895	86	48	32
ACCESSORIES AND PERIPHERAL EQUIPMENT	E0400 4 Channel Stat Mux.	1,525	147	82	55
	E0600 8 Channel Stat Mux.	2,050	197	110	74

FULL OWNERSHIP AFTER 12 OR 24 MONTHS • 10% PURCHASE OPTION AFTER 36 MONTHS

MICROCOMPUTERS

APPLE • COMMODORE • HP87 • DEC

ACCESSORIES AND PERIPHERAL EQUIPMENT

ACOUSTIC COUPLERS • MODEMS • THERMAL PAPER • RIBBONS • INTERFACE MODULES • FLOPPY DISK UNITS



TRANSNET CORPORATION

1945 ROUTE 22 • UNION, N.J. 07083 • (201) 688-7800
 TWX 710-985-5485 800-526-4965 OUTSIDE N.J.

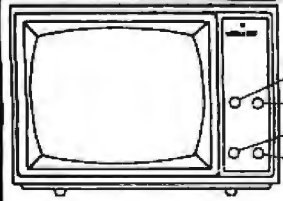

1. CONTRAST
2. POWER-BRIGHT
3. V-HOLD
4. H-HOLD

VIDEO 100
 12" Black & White
 MONITOR
\$89.50
 by AMDEK

Fourth Dimension Systems FLOPPY DISK DRIVE FOR APPLE COMP.

The unit features a track zero micro-switch and read/write electronics DOS 3.2.1., DOS 3.3, PASCAL or CP/M.
\$349.95

DISKETTES
 5 1/4" BULK "OEM" PACK
 FOR YOUR APPLE
\$149
 Box of 100



BROAD BAND MICROWAVE RECEIVER SYSTEM 1.8GHZ to 2.4 GHZ

only **\$295.00**

- RANGE: Line of sight to 250 miles
- SCOPE: Will receive within the frequency band from satellites, primary microwave stations, and repeater microwave booster stations
- CONTENTS: Packaged in 19"x19"x4 1/2" corrugated carton complete with:
- 24" Dish
 - Feed-Horn Receiver
 - Mounting Bracket
 - Mounting Clamp
 - Instructions
 - 300 Ohm to 75 Ohm Adapter
 - 750 Ohm to 300 Ohm Adapter
 - 60 Feet Coax Cable with Connectors
 - 3 Feet Coax Cable with Connectors

VISION-80® 80x24 Video Display Card \$269

Vista Computer Company's new Vision-80 board is a sophisticated yet easy to use video display card for the Apple™ computer.

SUPER BUY!
 16K RAM EXPANSION CARD
 For Your APPLE
 LANGUAGE TRANSPARENT
 ALL NINE RAMS INSTALLED!
\$79.95

TERMS OF SALE: Cash, checks, credit cards, C.O.D. Calif. residents add 6% sales tax.

"HAVE YOU KISSED YOUR COMPUTER LATELY?" Components Express, Inc.

1380 E. Edinger • Santa Ana, Calif. 92705 • 714/558-3972 TWX 910-595-1565



New from TOKYO CAP-M20GP

High-Reliability 20MBYTE
FIXED DISK Subsystems

GP-IB RS-232C



GENERAL SPECIFICATIONS

● DRIVE: FUJITSU 8", 20MByte Winchester-type
Maintenance Free. ● I/F: GP-IB(IEEE-488/1978)
RS-232C Switch selectable ● BAUD-RATE: 300 to
38,400 baud (RS-232C) ● COMMAND: A, R, W, E, S,
and Maintenance Command ● SOFTWARE: In case
that you use our GP-IB-100 as a controller, we can
support CP/M based driver. ● POWER: AC100-to-
240V 150VA ● DIMENSIONS: 430W x 150H x 450D,
25kg Approx ● PRICE: \$ 6200.00

F2P/F2

New 8" FD subsystems for CROMEMCO*
and other general systems



*CROMEMCO is a trade
mark of Cromemco Inc.

GENERAL SPECIFICATIONS

● DRIVE: Ultra-compact NEC FD1165x2 (8" double-
sided dual-density, direct drive motor), fully com-
patible with Shugart SA850R
● ENCLOSURE: 160W x 230H x 500D(mm), power sup-
ply and noise filter included
● PRICES:
☆F2P (signal compatible with Percsi 299).....
\$ 2,580.00 (including FSC-1250)
☆FSC-1250 (I/F for 16FDC & Shugart type drives
(no modification required of CDOS).....\$ 550.00
☆F2 (pin compatible with Shugart drives).....\$ 1,990.00

GP-IB-100

S-100 multifunction board meeting
IEEE-488 specifications.

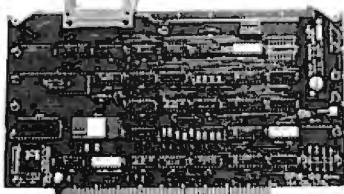

GENERAL SPECIFICATIONS

● GP-IB: IEEE-488, 1975/1978(TMS9914)
● TIMER: 100μs to 18 hours (8253) ● INTERRUPT: S-
Universal interrupt controller (AM9519) ● CLOCK: S-
Real time, battery-backup (MSM5832) ● BUSS: S-
IEEE S-100 ● SOFTWARE: All necessary handler
programs included on 8" diskette ● PRICE: \$550.00

ALL PRICES ARE FOB TOKYO AND SUBJECT TO
CHANGE WITHOUT NOTICE (Dealer inquiries invited)

International Systems & Automation

ISA co., Ltd.

HEIAN BLDG. 2-6-16 OKUBO, SHINJUKU-KU, TOKYO 160 JAPAN
PHONE: 03-232-8570 TELEX: 2324466 ISATOK CABLE: ISAEIAN



Photo 1: Front view of the Heath/Zenith 47 dual floppy-disk system.

double-sided disk is in the other.

Previous Heath disk systems, based on single-density 5¼-inch floppy-disk drives, provided a maximum of roughly 300K bytes of online storage, so the 2-megabyte H-/Z-47 represents a major increase in system capacity. Up to three 5¼-inch drives can still be used in addition to the H-/Z-47 with either the H-8 or H-/Z-89 computers.

Speed of Disk I/O

An incidental benefit of adding 8-inch drives to an existing 5¼-inch system is an increase in disk-access speed, especially when using extended double density under CP/M. According to Heath's specifications, the average time required to access a particular sector is about 15 percent faster on the H-/Z-47 than on Heath's 5¼-inch drives (191 ms compared with 225 ms). My rudimentary tests confirmed that most disk-bound programs run about 15 percent faster.

The most noticeable speed-up is in the time required to initiate a CP/M transient program or open a data file. This is particularly apparent when lengthy "batch" jobs are being run under CP/M's SUBMIT facility. An experimental Unix-like disk operating system I have been using, which must often read down a hierarchy of file directories, was rather laggardly with

5¼-inch drives. It perked up considerably when run on the H-/Z-47.

Operating Requirements

Interface cards for the H-8 and H-/Z-89 computers are sold separately. These provide the control logic for disk input and output, as well as the buffer memory required to store data that has been read from or written to the disk. The interface board for the H-8 also provides two programmable RS-232C serial channels. If a system has only serial peripheral devices (e.g., a terminal and a printer), this can free an extra card position on the H-8 bus.

The H-/Z-47 is large (19 by 18½ by 10⅞ inches) and fairly heavy (65 pounds). The twin cooling fans in the back of the unit are relatively quiet and they provide excellent, filtered, positive ventilation (this should keep dust away from the surfaces of the disks). The noise level of the active drives is about average, but I don't think the H-/Z-47 would be intrusive in the average office.

The H-/Z-47 carries an FCC-required warning label to the effect that its operation in residential areas may cause RFI and TVI (radio and television interference) and that the user is responsible for ensuring that this doesn't happen. But there was no sign of TVI when I operated the unit

WARNING!

**Electric Power Pollution.
Spikes & Lightning
HAZARDOUS to
MICROCOMPUTERS!!**



Patented ISOLATORS provide protection from ...

- Computer errors cause by power line interference
- Computer errors due to system equipment interaction
- Spike damage caused by copier/elevator/air conditioners
- Lightning caused damage

MONEY BACK GUARANTEE!

- ISOLATOR (ISO-1) 3 Isolated 3-prong sockets; Spike Suppression; useful for small offices, laboratories, classrooms. \$69.95
- ISOLATOR (ISO-2) 2 Isolated 3-prong socket banks; (6 sockets total); Spike Suppression; useful for multiple equipment installations. \$69.95
- SUPER ISOLATOR (ISO-3) similar to ISO-1 except double isolation & oversize Spike Suppression; widely used for severe electrical noise situations such as factories or large offices. \$104.95
- SUPER ISOLATOR (ISO-11) similar to ISO-2 except double isolated socket banks & Oversize Spike Suppression; for the larger system in severe situations. \$104.95
- MAGNUM ISOLATOR (ISO-17) 4 Quad Isolated Sockets; Multiple Spike Suppressors; For ULTRA-SENSITIVE Systems in extremely Harsh environments. \$181.95
- CIRCUIT BREAKER, any model (Add-CB) Add \$9.00
- REMOTE SWITCH, any model (Add-RS) Add \$16.00

AT YOUR DEALERS MasterCard, Visa, American Express
ORDER TOLL FREE 1-800-225-4876 (except AK, HI, PR & Canada)

Electronic Specialists, Inc.
 171 South Main Street, Box 389 Natick Mass 01760
 (617) 655-1532

S-100 SYSTEM DESIGNERS

NEW TARBELL CACHE MEMORY SYSTEM

Increase floppy disk system speed from 2 to 5 times using our new CACHE-C CP/M®. This will only work with the Tarbell CPU/IO board and the Tarbell Double Density Floppy Disk Interface, so we have a combination package available.

This package includes the following:

- CPU/IO board with 4 Mhz Z-80A, 2 RS232 serial ports with full handshaking, timer, and special memory management circuitry.
- Double Density Floppy Disk Interface with boot ROM, Direct Memory Access and extended memory addressing.
- CP/M 2.2 on single density disk with manuals
- New CACHE-C CP/M 2.2 on double density disk. This system keeps up to 64k of most recently used 512-byte sectors in extended address memory.

All for \$945 list (25-35% dealer discounts)

Tarbell Electronics, 950 Dovlen Place, Suite B
 Carson, California 90746 (213) 538-4251, 2254

CP/M is a registered trademark of Digital Research



Ride the **wabash** express

<p>5 1/4" \$199*</p> <p>SINGLE SIDE SINGLE DENSITY W/HUB RING</p> <p>100% CERTIFIED 2 YEAR WARRANTY</p> <p style="text-align: right;">SOFT, 10 OR 16 SECTORS</p>	<p>8" \$199*</p> <p>SINGLE SIDE SINGLE DENSITY</p> <p>100% CERTIFIED 2 YEAR WARRANTY</p> <p style="text-align: right;">SOFT OR 32 SECTORS</p>
<p>5 1/4" \$219*</p> <p>SINGLE SIDE DOUBLE DENSITY W/HUB RING</p> <p>100% CERTIFIED 2 YEAR WARRANTY</p> <p style="text-align: right;">SOFT, 10 OR 16 SECTORS</p>	<p>8" \$249*</p> <p>SINGLE SIDE DOUBLE DENSITY</p> <p>100% CERTIFIED 2 YEAR WARRANTY</p> <p style="text-align: right;">SOFT OR 32 SECTORS</p>
<p>5 1/4" \$299*</p> <p>DOUBLE SIDE DOUBLE DENSITY W/HUB RING</p> <p>100% CERTIFIED 2 YEAR WARRANTY</p> <p style="text-align: right;">SOFT, 10 OR 16 SECTORS</p>	<p>8" \$309*</p> <p>DOUBLE SIDE DOUBLE DENSITY</p> <p>100% CERTIFIED 2 YEAR WARRANTY</p> <p style="text-align: right;">SOFT OR 32 SECTORS</p>

* Minimum order 100 • For smaller quantities add 10%
 • Packed 10 boxes of 10 diskettes with sleeves and labels
 • Quantity discounts - 1,000 deduct 3%, 5,000 deduct 5%, 10,000 deduct 7%
 • Add \$5.00 per case 5 1/4", \$7.00 per case 8"
 For shipping and handling Continental U.S.A. U.P.S. ground

<p>Box of 10 diskettes, 5 1/4"</p> <p>OPUS ss/rd \$20 ss/rd \$21 BASF ss/rd \$23 ss/rd \$24 MAXWELL TOO LOW TO QUOTE CALL DYSAM</p> <p>SPECIFY SECTORING WHEN ORDERING 5 1/4" QUAD DENSITY IN STOCK</p>	<p>DISK DRIVE HEAD CLEANING KITS</p> <p>Prevent head crashes and ensure error-free operation 5 1/4" or 8"</p> <p style="text-align: right;">\$19.50</p>
<p>HARDHOLE DISK PROTECTORS</p> <p>Reinforcing rings of tough mylar protect disk hole edge from damage.</p> <p>Applicators . . . \$2 \$4 Hardhole Rings (50) . . . \$5 \$8</p>	<p>SFD C-10 CASSETTES . . . 10/87</p> <p>(All cassettes include box and labels.)</p> <p>Get 8 cassettes, C-10 Sonic, and Cassette/8 Library-Album, as illustrated, for only . . . \$8</p>

<p>LIBRARY CASES</p> <p>8" Kas-sette/10. . . \$2.99 5 1/4" Mini Kas-sette/10. . . \$2.49</p>	<p>5 1/4" or 8"</p> <p>Vinyl Storage Pages . . . 10/85</p>
--	---

• Written purchase orders accepted from government agencies and well rated firms at a 10% surcharge (wabash media only) for net 30 billing. • International orders accepted with a 15.00 surcharge for handling, plus shipping charges. • C.O.D. requires a 10% deposit. • We accept Visa, Mastercard, Money Orders, and Certificate checks. • Checks require bank clearances. • All shipments F.O.B. San Diego. • Minimum shipping and handling 2.00, minimum order 10.00. • California residents all 6% sales tax. • Prices and terms subject to change without notice. • All sales subject to availability, acceptance, and verification. • All sales are final. • Satisfaction guaranteed or full refund.

We also offer printer ribbons, printwheels, type elements, equipment covers, power consoles, paper supplies, storage and filing equipment, furniture and many other accessories for word and data processing systems. Write for our free catalog.

Toll Free Order Only
800-854-1555

For Information
 or California Orders
(714) 268-3537

ABM

PRODUCTS

8868 CLAIREMONT MESA BLVD.
 SAN DIEGO, CALIFORNIA 92123

within a few feet of a portable television set that has proved sensitive to interference from other sources.

No preventive maintenance is required. The drive manufacturer (Remex) does not even recommend cleaning the read/write head. Repair service is available at the various Heathkit Electronic Centers around the country and from the factory in Benton Harbor, Michigan. In my experience with previous Heath products, repairs are invariably done correctly and usually within a week. Heath also maintains a special tech-

nical-service telephone number for those who want to troubleshoot Heath equipment themselves. I have found this fairly helpful on occasion, although there are obvious limits to how much can be accomplished on the phone.

Construction

Heath is one among the dwindling number of manufacturers that still supplies computer products in kit form. I have been building Heathkits off and on for the better part of 20 years, and construction of the H-47

was more reminiscent of some of those earlier projects than, say, of building my H-8 computer. Most of the required wiring is point-to-point. The two disk drives, along with their associated electronics, come preassembled. There are only two small printed-circuit boards that must be prepared. One contains two front-panel switches that make it possible to write-protect a disk electronically (as well as by the usual method of removing the adhesive write-enable tab). The other circuit board, on the rear panel, provides various connectors for the wiring harnesses.

The rest of the job falls into two main categories: wiring the power supply and assembling the sheet-metal parts that form the chassis. Most of the power-supply components are easy to get to, although there are a few places where wires are packed closely enough to require care in maneuvering a hot soldering iron. The chassis assembly is considerably more complex than that of other Heath products I have built, and it gets fairly involved as more and more parts are added. There were a couple of times when a second pair of hands would have helped. Despite the relatively large number of sheet-metal components, everything fits together with gratifying precision and the finished product is very solid.

Heath's assembly instructions have long been the standard against which others are judged, and the 65-page manual for the H-/Z-47 (supplemented by a schematic diagram and a 30-page booklet of large illustrations) fully lived up to my expectations. I found only one minor error—the picture of the AC line filter in the assembly manual didn't match the part that was actually supplied—but it was obvious from other illustrations how the part was intended to fit. From start to finish, the unit required 9½ hours of construction time, and it worked perfectly the moment it was powered up.

The H-8 and H-/Z-89 interface cards, like the controller electronics on the two disk drives, are supplied prewired. Apparently there is little savings to be had in providing printed circuits in kit form now that auto-



The DS120 Terminal Controller makes your LA36 perform like a DECwriter® III.

The Datasouth DS120 gives your DECwriter® II the high speed printing and versatile performance features of the DECwriter® III at only a fraction of the cost. The DS120 is a plug compatible replacement for your LA36 logic board which can be installed in minutes. Standard features include:

- 165 cps bidirectional printing
- Horizontal & Vertical Tabs
- Page Length Selection
- 110-4800 baud operation
- 1000 character print buffer
- X-on, X-off protocol
- Self Test
- RS232 interface
- 20 mA Current Loop interface
- Top of Form
- Adjustable Margins
- Double wide characters
- Parity selection
- Optional APL character set

Over 5,000 DS120 units are now being used by customers ranging from the Fortune 500 to personal computing enthusiasts. In numerous installations, entire networks of terminals have been upgraded to take advantage of today's higher speed data communications services. LSI microprocessor electronics and strict quality control ensure dependable performance for years to come. When service is required, we will respond promptly and effectively. Best of all, we can deliver immediately through our nationwide network of distributors. Just give us a call for all the details.

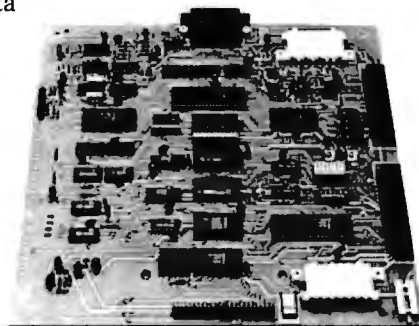

datasouth computer corporation

4740 Dwight Evans Road • Charlotte, North Carolina 28210 • 704/523-8500

DYMARC INDUSTRIES, INC.



LINE VOLTAGE TRANSIENT SUPPRESSORS

Features Parallel Operation 5000 Hits/Second

Clipstrip™ AND Clipper™

PROTECTS:

- Computers
- Micro-Computer Systems
- Word Processors
- Cash Registers
- Power Supplies

PROTECTS AGAINST:

- High Energy Voltage Transients
- On-Off Switching
- Lightning Induced Transients
- Inrush of On/Off Power

DYMARC INDUSTRIES, INC.

DEALER INQUIRIES INVITED



**7133 Rutherford Rd.
Baltimore, Md. 21207**

Clipstrip 977E
Clipper 678F



LISTED

WE HONOR

LISTED

**800-638-9098
(301) 298-3130**

RISK FREE MAIL ORDER

IBM & OSBORNE

PERSONAL COMPUTER
CALL FOR PRICE & AVAILABILITY

NEC PC-8000

PC-8001A 32K W/24K ROM
5 FUNC. KEYS 735

PC-8012A I/O & EXPANSION
SLOTS W/32K 475

PC-8031A DUAL DRIVES 735

BENCHMARK WORD PROCESSOR 379

WORDSTAR 299

Apple II SOFTWARE & ACCESSORIES

VISICALC 189

VISIREND/VISIPLOT 210

VISIFILE 199

BPI BUSINESS SOFTWARE 335

WORDSTAR 299

HAYES MICROMODEM II 299

NOVATION CAT II 349

MICROSOFT Z-80 SOFTCARD 299

VIDEX 80 COLUMN CARD 269

DISKETTES

BASF 5 1/4" SS/DD/HUB RING (10) ... 23

BASF 8" DISKETTES (10) 24

ATARI 800 & 400

ATARI 800 (16K) 675

ATARI 400 (16K) 335

410 PROGRAM RECORDER 85

810 DISK DRIVE 499

16K RAM MEMORY MODULE 89

850 INTERFACE MODULE 165

830A COUSTIC MODEM 159

ATARI VISICALC 199

ATARI WORD PROCESSOR 125

PRINTERS Epson

EPSON MX-80 CALL

EPSON MX-80FT CALL

EPSON MX-100 CALL

NEC 8023 FRICTION/TRACTOR 499

NEC 3530 SPINWRITER 1950

THE GRAPPLER INTERFACE 129

OKIDATA MICROLINE 82A 575

OKIDATA MICROLINE 83A 795

C.I.TOH STARWRITER F10-40PU 1550

C.I.TOH PROWRITER 8510 AP 499

MONITORS

AMDEX LOW-RES 13" COLOR I 365

AMDEX HI-RES 13" COLOR II 850

SANYO 9" B&W 185

ZENITH 12" GREEN (ZVM-121) 129

NEC 12" GREEN (JB-1201) 169

NEC 12" RGB COLOR (JC-1202DH) . 875

ELECTROHOME 13" RGB HI-RES . 825

TO ORDER: Please send cashier's check or personal check (allow 10 business days to clear). VISA and Master Card credit card service add 3%. Shipping, handling and insurance in U.S. add 3%. Minimum \$3.00. California residents add 6% sales tax. Foreign orders add 10% for shipping. Equipment is subject to price change and availability. All equipment carries warranty. Store prices may differ from mail order prices.

computer age

4688 CONVOY STREET, SAN DIEGO, CA 92111
(800) 854-1941 (714) 565-7092
CALL OR WRITE FOR COMPLETE PRICE LIST

SUNNY LOW LOW COST POWER SUPPLIES (LINEAR & SWITCHING) FOR S-100, DISK DRIVES

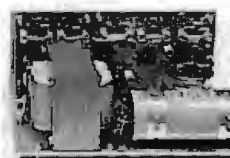
KIT 1, 2 & 3 For S-100 **R3** For 3x 8" (or 5 1/4") Disks **S3** For S-100 & Two Disks

S-100 & DISK POWER SUPPLY "S3" OPEN FRAME, ASSY. & TESTED, 6 OUTPUTS. SIZE: 10" (W) x 6" (D) x 5" (H) **102.95**

REGUL. OUTPUTS FOR DISKS: +5V @ 5A OVP, -5V @ 1A, +24V (OR +12V) @ 5A-7A PEAK. ADJUSTABLE AND UNREGUL. OUTPUTS FOR S-100: +8V @ 14A, ±16V @ 3A. FUSES PROTECT ALL REGUL. OUTPUTS. IDEAL FOR THE MAINFRAME WITH 12 SLOTS & 2 x 8" or 5 1/4" FLOPPY (OR 1x FLOPPY & 1x HARD DISK).

DISK POWER SUPPLIES: OPEN FRAME, ASSY. & TESTED, REGULATED, ADJUSTABLE & FUSES PROTECT.

ITEM	IDEAL FOR	+5V OVP	-5V (or -12V)	+24V (or +12V)	+8V Unreg.	SIZE W x D x H	PRICE
R0	2 x 8" SLIMLINE	2.5A		2.5A - 5A Peak		5" x 4" x 4"	49.95
R1	2 x 8" or 2 x 5 1/4" DISK	3A	1A	3A - 5A Peak	2A	8" x 4" x 3 3/8"	54.95
R2	3 x 8" (or 5 1/4") FLOPPY	6A	1A (or 2.5A)	6A - 8A Peak		1. 8 1/2" x 5" x 4 3/8" or 2. 10" x 4 7/8" x 3 3/4"	69.95
R3	or 1x Floppy & 1x Hard	6A	1A	6A - 8A Peak		1. 9" x 6 1/4" x 4 3/8" or 2. 9" x 5 1/4" x 5 1/4"	69.95

OPTION: ±12V @ 1A CAN BE ADDED TO ITEM "R3" SIZE 1. ONLY, COSTS \$12.00 MORE.

S-100 POWER SUPPLY KITS (OPEN FRAME WITH BASE PLATE, 3 HRS. ASSY. TIME)

ITEM	(IDEAL FOR)	+8V	-8V	+16V	-16V	+28V	SIZE: WxDxH	PRICE
KIT 1	15 CARDS	15A	---	2.5A	2.5A	---	12" x 5" x 4 7/8"	54.95
KIT 2	20 CARDS	25A	---	3A	3A	---	12" x 5" x 4 7/8"	61.95
KIT 3	DISK SYSTEM	15A	1A	3A	3A	5A	13 1/2" x 5" x 4 7/8"	69.95

POWER TRANSFORMERS (WITH MOUNTING BRACKETS)

ITEM	PRIMARY	SECONDARY #1	SECONDARY #2	SECONDARY #3	SIZE WxDxH	PRICE
T1	110/120	2x8 Vac, 15A	28 Vac, CT, 2.5A	---	3 3/4" x 3 3/8" x 3 3/8"	22.95
T2	110/120	2 x 8 Vac, 25A	28 Vac, CT, 3.5A	---	3 3/4" x 4 3/8" x 3 3/8"	28.95
T3	110/120	2 x 8 Vac, 15A	28 Vac, CT, 3A	48 Vac, CT, 2.5A	3 3/4" x 4 3/8" x 3 3/8"	30.95
T4	110/120	2 x 8 Vac, 6A	28 Vac, CT, 1.5A	48 Vac, CT, 3A	3 3/4" x 3 3/8" x 3 3/8"	23.95
T5	110/120	16 Vac, CT, 3A	28 Vac, CT, 2A	(48 Vac, if specified)	3" x 3" x 2 1/2"	15.95

MAILING ADDRESS:
P.O. BOX 4296
TORRANCE, CA 90510
TELEX: 182558

SUNNY INTERNATIONAL
(TRANSFORMERS MANUFACTURER)
(213) 328-2425 MON-SAT 9-6

SHIPPING ADDRESS:
22129 1/2 S. VERMONT AVE
TORRANCE, CA 90502

ATTENTION O.E.M.'S
YOUR SPECIAL NEEDS OR DESIGNS OF TRANSFORMER, LINEAR & SWITCHING PWR SUPPLY WILL BE MADE TO ORDER AT SUNNY LOW LOW COST & FASTEST DELIVERY.

COMPUTER CONTROLLED MOTION

CONSIDER THE POSSIBILITIES.

Robots. Factory Automation. Where computers and machines perform dirty, dangerous, degrading jobs, instead of men. All part of the Factory of the Future, the new Industrial Revolution. Compumotor. And you.

Your proficiency with today's powerful mini and microcomputer systems has expanded your vision of tomorrow and beyond. To a world where low-cost intelligence drives the products and processes around you. If there was a motor system as easy to use as a computer peripheral, you could be in the forefront of that Revolution today.

Such a system exists now and has been proven through years of operation and thousands of applications. The Compumotor system of motors, drives, indexers and computer interfaces gives you 0.001 to 2.5 horsepower in packaged, plug together building blocks. Motion control as easy to understand as it is to use.

Imagine simple ASCII commands on your RS-232C serial interface, allowing you to position up to 16 motors simultaneously with accuracies of one thousandth to 20 millionths of an inch.

Controlling speeds with an accuracy to 0.01% of set rate. Running motors at 2 revo-

lutions per day or up to 3000 revolutions per minute. Torques from 6 to 12000 in-oz (0.05 to 85Nm). Rotary resolutions of 400 to an amazing 50000 parts per revolution. Linear resolutions with leadscrews from one one-thousandth to 10 millionths of an inch.

No system in the world today offers the same combination performance and ease of use. That is why Compumotor components are used in so many demanding applications: assembly and welding robots, machine tools, automated grinders, semi-conductor fabrication, laser scanning systems, non-contact measurement and inspection, fiber optic production, follow focus and autofocus systems, special effects generators, optical printers and dozens of others.

Plug your imagination into your computer and your computer into the Compumotor system. The possibilities are endless.

For more information, call (800) 358-9068 toll free outside of California or (707) 778-1244 collect in the State.

You may write us at 1310 Ross Street, Petaluma, CA 94952 or circle the Readers Service Card Number below.



The Computer Movement that started a Revolution

COMPUMOTOR
CORPORATION™

1310 Ross Street, Petaluma, California 94952
(707) 778-1244 / (800) 358-9068

Circle 90 on inquiry card.

Could you pass this Red Cross swimming test?

SWIM:

1. Breaststroke—100 Yds.
2. Sidestroke—100 Yds.
3. Crawl stroke—100 Yds.
4. Back crawl—50 Yds.
5. On back (legs only)—50 Yds.
6. Turns (on front, back, side).
7. Surface dive—underwater swim—20 Ft.
8. Disrobe—float with clothes—5 mins.
9. Long shallow dive.
10. Running front dive.
11. 10-minute swim.

Anybody who's taken a Red Cross swim course knows how tough it can be.

There's a good reason.

We believe drowning is a serious business.

Last year alone, we taught 2,589,203 Americans not to drown—in the seven different swim courses we offer all across the country. (Incidentally, most of the teaching—as with almost everything American Red Cross does—is done by dedicated volunteers.)

A good many of the youngsters not only are learning to keep *themselves* safe. Thousands upon thousands of them are learning to become lifesavers.

And the life they save—it just might be your own.



Red Cross
is counting
on you.

mated assembly equipment is available to manufacturers. I don't mourn the loss. Stuffing printed-circuit boards is boring and it demands intense attention to soldering technique because of the high speeds involved in digital electronics and the high component density of modern boards.

The Heath operating system, HDOS, includes a disk-drive test program along with a number of other useful diagnostics. The program—which runs for a full hour on an 8-inch double-sided disk, reading and writing random as well as sequential disk sectors—provides a fairly stringent test of the drive's ability to stand up to heavy usage. Both H-/Z-47 drives performed perfectly, with no soft (recoverable) or hard (nonrecoverable) errors. Even after two hours of strenuous operation, the unit did not heat up noticeably.

Use with Existing Systems

The H-8 computer requires a minor hardware modification (Heath's "extended configuration" card) when the H-/Z-47 is used with an 8080A central processor. The Z-80 CPU board for the H-8 includes the extended configuration option. Older H-/Z-89 models also need modification to use the 8-inch disk unit. Recent models—those with an external control to adjust video-screen brightness—can accept the H-/Z-47 as is. Once the hardware is properly configured, integrating the H-/Z-47 into an existing system amounts to little more than plugging it in.

Both Heath's version of the CP/M operating system and the company's own HDOS operating system come complete with device drivers for 8-inch as well as 5¼-inch drives. The presence of the 8-inch disk unit is determined automatically at the time of the initial bootstrap load by special configuration programs that are provided as part of the Heath software. New system disks created by the system-generation program (provided with each operating system) will "remember" what disk devices are available. This means the configuration process does not have to be repeated each time the system is loaded.

Heath's CP/M BIOS module in-

cludes all the source code for the disk drivers and device tables (the BIOS—basic input/output system—contains the hardware-dependent routines for a specific computer system). The corresponding source modules are also provided with the Heath operating system. The entire HDOS source code is available in printed form at extra cost. Heath's liberal policy with regard to source-code distribution is unusual and very welcome. While most users will never need the source for the operating system, it is critical for some specialized applications.

The H-/Z-47 can be used as either the primary or secondary disk unit in a system. The primary unit is the one from which the operating system is usually booted up. The H-8 computer (but not the H-/Z-89) permits the system to be booted from either the primary or the secondary unit. The Heath software manuals contain step-by-step instructions for generating new system disks for secondary drives. The operating systems that are distributed on 5¼-inch and 8-inch disks are identical, so no new software is required when H-/Z-47 is added to an existing system.

Conclusions

The H-/Z-47 provides a maximum of 999 and 1208K bytes of usable storage under HDOS and CP/M, respectively, for the Heath H-8 and Heath/Zenith-89 computers. It also provides compatibility with the standard IBM soft-sectored 8-inch disk format, substantially increasing the availability of software for the Heath/Zenith product line.

The kit version of the unit requires point-to-point wiring, since all but two small printed-circuit boards come preassembled. Construction took about 9½ hours. Heath's documentation is excellent, and the H-/Z-47 is easily integrated into existing Heath/Zenith computer systems without the addition of any new software. H-8 computers with an 8080A microprocessor and some older H-/Z-89 models require minor hardware modification, available at a nominal extra cost. Interface circuit boards are sold separately. ■

TEACHING

WILL NEVER BE
THE SAME AGAIN!

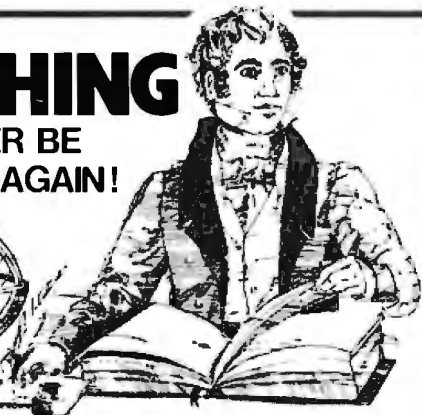

INTRODUCING Torricelli author

A powerful authoring and presentation program that allows teachers without programming experience to create effective training and education courses. Specifically designed for Business, Industry, Education and Home use.

Features include:

- Built-in full screen editor using WordStar™ commands for rapid on-screen editing and course generation.
- Creation of courses for mass distribution is fully supported. 20% royalties for courses submitted for our courseware catalog.

Requires CP/M™ 2.2, 48K, and 24 x 80 CRT. Available on 8" (3740) Single Density Disk. Contact distributors for other formats.

Package includes: Torricelli Author program, a linear presentation program, complete documentation, two courses of instruction and description of the entire educational software line. **\$295.**

California residents add 6% tax. Visa/MasterCard accepted.

*CP/M is a trademark of Digital Research.
*WordStar is a trademark of Micro Pro Int.

THE ANSWER IN COMPUTERS

6035 University Avenue, #7
San Diego, CA 92115
714-287-0795

DIGITAL DATA RECORDER MODEL DC-3

For six years, the DC series recorders have been the industry NRZ Asynchronous recorder standard. Now the DC-3 model sets a new standard in stability and reliability with its tachometer feedback LC stabilized motor circuit.



DC-3 Model
Price \$323.30

- *4800 Baud (3" per second)
- *10⁻⁸ Error Rate
- *Controlled by Hand-shake
- *DB25P Connector installed
- *Speed Stability (long term) ± .1%
- *RS232 Output standard.
- No interface or controller required.
- *Operating range 105-125 VAC
- *Optional 220 V. on request.
- *Panel-mounted unit optional

PEGASUS DATA SYSTEMS
236 LACKLAND DRIVE
MIDDLESEX, NEW JERSEY 08846

Tel. (201) 356-9200

TWX 710-997-9530

Apple™ users. THE SOURCE™ and TRANSEND™. Together for the first time for only \$89.

Buy our \$89 Transend state-of-the-art data communications software and membership in THE SOURCE, AMERICA'S INFORMATION UTILITY™, is included. This combination allows you to easily access one of the world's largest information services for up-to-the-minute news and sports, stock prices, travel services and much more.

An optional 260-page Source User's Manual is available for \$19.95. Your dealer has complete details. Call 800-227-2400, ext. 912 (in Calif. 800-772-2666, ext. 912) for the name of your local Transend dealer.

offer expires Oct. 1, 1982.

Apple is a trademark of Apple Computer Inc.
THE SOURCE and AMERICA'S INFORMATION UTILITY are service marks of Source Telecomputing Corp., a subsidiary of The Reader's Digest Association Inc.



The Transformation People.



SSM Microcomputer Products Inc.
2190 Paragon Drive, San Jose, CA 95131

Assisted Instructional Development System

George Wolfe
James Madison University
Harrisonburg, VA 22807

Computer-assisted instruction (CAI) in public schools and colleges has increased in the last few years. Until now, however, two limitations made extensive CAI programs impractical for most school systems: (1) the time and cost involved in writing separate programs in BASIC, PILOT, or other language for each new lesson; and (2) the shortage of experienced educational programmers who could provide a school with its own personalized software.

The Assisted Instructional Development System (AIDS) represents a significant effort to overcome

these constraints. The AIDS package, which includes both hardware and software, is a versatile educational system which makes creating CAI lessons cost-effective. It also does away with the instructor's need for extensive programming experience.

The economic catalyst for AIDS's development was the Norfolk (Virginia) Public School System, which has been experimenting with CAI for several years. The school system decided to move from the Hewlett-Packard HP3000 minicomputer system it had been using to individual Apple II microcomputers.

The Small Business Computer Center of Virginia Beach was commissioned to develop an adaptable, easy-to-use CAI package that would meet the school's educational needs. The result of this project is the AIDS package.

The System

Through elaborate use of text files and string variables, AIDS allows teachers with virtually no programming experience to write elaborate CAI lessons. A teacher simply types in the lesson and then inputs questions pertaining to the lesson. The questions must be in the standard objective formats of true/false, multiple choice, or short answer. A special string search option enables the computer to search for any *keyword* the teacher may be looking for in a student response.

The instructor can input personalized reinforcing responses for correct and incorrect answers. A *failure message*, which the teacher can input, informs the student that he or she did not enter the correct response. A *hint* feature also exists for the student if a question poses great difficulty. The teacher has the option to include this feature in any question—without limit to the number of hints that can be given for each question. The number of questions per lesson is limited only by the storage space available on the lesson disk.

At a Glance

Name

Assisted Instructional Development System (AIDS)

Use

Comprehensive computer-assisted instruction (CAI) system

Manufacturer

Instructional Development Systems
2929 Virginia Beach Blvd.
Virginia Beach, VA 23452
(804) 340-1977

Price

\$345

Features

AIDS interface card with on-board calendar/time clock; 5¼-inch disk in Apple DOS 3.2 or 3.3 (demonstration disk available upon request for \$25)

Language

Applesoft BASIC with supplementary machine-language subroutines

Hardware required

Currently for Apple II Plus with 48K bytes of RAM, TRS-80 version available soon

Documentation

200-page instruction manual in a 3-ring binder

Audience

Elementary and secondary schools and colleges—especially those with limited access to experienced programmers

**"I will not program on any APPLE II
with less than two Legend cards in it."**

Robert Woodhead

**Robert Woodhead, Inc.
Co-Author of Wizardry**

**If Robert Woodhead, co-author of one of
the top selling game programs in the
world, thinks this highly of Legend
Products, we're doing something right.**

**Go to your nearest computer dealer today
and find out for yourself about Legend
products.**

**The Original Hi-Density RAM Products
for APPLE II**



Legend Industries Ltd.

**2220 Scott Lake Road
Pontiac, MI 48054
(313) 674-0953 Office
(313) 674-1340 Modem**

Circle 472 on inquiry card.

Best School System		Anywhere Public Schools				Page 1
Daily Work Report		Title I	Language Arts			
Teacher: Jane Sumter						
Student Names	ID Number	Lesson	Subject	Number R/A	Remarks	
Billings, Shelia	32309	5430	Punct.	10/20	Needs help	
Goodard, Vick	32310	Test	Capitiz.	34/40	Score C+	
Hilton, Wilt	32311	4580	Verbals	20/20	Excellent	
Johnson, Mary	32306	3218	Nouns	37/40	Excellent	
Johnson, Mary	32306	3211	Nouns	15/20	H.H. assign#2	
Limming, Rob	32305	7809	Dictionary	17/20	Score B+	

Table 1: *The Daily Report, one of the three reports generated by the Assisted Instructional Development System (AIDS), consists of a daily summary of all students' completed lessons.*

Best School System		Anywhere Public Schools		Page 1
Name Listing Report		Title I	Language Arts	
"Usage Report"				
Teacher: Jane Sumter				
Name	ID Number	Use Time (hrs)	Sessions	
Billings, Shelia	32309	1.13	4	
Dillinger, Larry	32333	0.27	1	
Goodard, Vick	32310	2.00	8	
Hilton, Wilt	32311	1.28	5	
Johnson, Mary	32306	1.48	7	

Table 2: *The Usage Report shows the number of hours and sessions each student used the system.*

students can be assigned an additional exercise based on their performance during a previous lesson. For example, an excellent score permits a branch to an enrichment lesson, average performance can branch to a reinforcing exercise, or a low score to a remedial one. A message file allows the teacher to make a follow-up assignment in a text, workbook, or other supplementary material.

Three types of permanent records are kept automatically by the system on student performance:

1. Daily report, an itemized account of the work done by a student on a given day (see table 1)
2. Usage report, a record of system usage in terms of hours and number of individual student sessions (see table 2)
3. Cumulative student report, a cumulative listing of all lessons taken by the student over a nine-week period (see table 3)

In addition to these lesson-design options, AIDS makes possible multiple lesson assignments that can be given in a specified order. Entire curriculum modules can then be developed on the system. When used, this feature supersedes the AIDS lesson-branching option. Finally, a lesson index lists all the lessons contained on a lesson disk for easy access to any material filed either by number or name.

Editing Features

AIDS contains built-in word-processing functions that allow

Best School System		Any City's Public School System		Page 1
"Student Report"		Title I	Language Arts	
Teacher: Sally Smith				
Student: John Bendzunas — ID#32102				
Lesson	Subject	Number Right/Attempt	Percent Correct	
3203	Adjectives	12/20	60	
2133	Verbals	19/20	95	
2154	Verbals	19/20	95	
2134	Verbals	18/20	90	
Test	Verbals	38/40	95	
3231	Adjectives	15/20	75	
2378	Adjectives	20/20	100	
Totals		141/160	87	

Table 3: *The Cumulative Student Report lists all lessons attempted by an individual student during the standard nine-week session.*

CAI Options

Each student is assigned an ID number for reporting purposes, but lessons can call the student by name, which adds a personal touch. Exercises can be presented in either a timed or nontimed format for the entire lesson or for individual questions. As the student works through the

lesson(s), the system keeps an ongoing record of the student's usage and performance. After each lesson is completed, AIDS displays lists of the number of problems attempted, number of correct and incorrect answers, percentage score, and next assigned lesson.

With the *lesson-branching* option,

BDOS ERROR ON B:BAD SECTOR



Before disk errors ruin your work again order BADLIM.

- BADLIM assures the reliability of your CP/M computer.
- You can use your disks 10 times longer without losing your data AND your time.
- BADLIM checks thoroughly your disk marking all the blocks which have defective sectors. The operating system will know that those sectors should be skipped.
- BADLIM is the only program that gives protection for soft and hard errors.
- The first time BADLIM will list which files in your disk are on bad sectors, so you can take action to correct it.
- But thereafter the bad areas in your disk will be automatically by-passed.
- For CP/M 1.4 single density and for CP/M 2.xx of any format and density. It is a must for Winchester as the media cannot be replaced.

BADLIM cost only \$73. Whatever the reason you have to use a computer you need BADLIM. Contact your dealer or call us today:

BLAT R&D Corp., 8016 188th. St SW, Edmonds WA 98020. Phone: (206) 771-1408

DEALER INQUIRIES INVITED. **BADLIM**

TELEPHONE VOICE RESPONSE

The V100 interactive voice synthesizer

with telephone interface is an Apple II® or IBM Personal Computer® compatible, low-cost, solution to remote data base access arrangements.

\$395⁰⁰
V100-A

- Direct telephone connection, auto-dial/answer
- Touch-tone® generation and detection
- Includes 1000 word, LPC allophone vocabulary
- Software for sentence/library construction
- Expandable with 300 (\$150) or 1300 (\$495) high quality LPC words

For a demonstration call toll free (800) 538-7002
In California call (408) 942-1595

VYNET CORPORATION

2405 Qume Dr., San Jose, CA 95131
(408) 942-1037



Maryman INDUSTRIES, INC.

In Texas Orders
Questions & Answers
1-713-392-0747

22511 Katy Freeway
Katy (Houston) Texas 77450

To Order
1-800-231-3680
800-231-3681

SAVE BIG DOLLARS ON ALL TRS-80® HARDWARE & SOFTWARE

TRS-80® BY RADIO SHACK. Brand new in cartons delivered. Save state sales tax. Texas residents add only 5% sales tax. Open Mon.-Fri. 9-6, Sat. 9-5. We pay freight and insurance. Come by and see us. Call us for a reference in or near your city. Ref: Farmers State Bank, Brookshire, Texas.

WE OFFER ON REQUEST

- Federal Express (Overnight Delivery)
- Houston Intercontinental Airport Delivery (Same Day)
- U.P.S. BLUE (Every Day)
- References from people who have bought computers from us probably in your city

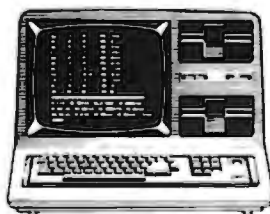

In stock TRS-80 Model II and III

No Tax on Out of Texas Shipments!

**Save
10% 15%
OR MORE**

Reserve Your Model 16 Today

Telex 77-4132 (Fleks Hou)

WE ALWAYS OFFER

- NO extra charge for Master Card or Visa.
- We use Direct Freight Lines. No long waits.
- We always pay the freight and insurance
- Toll free order number
- Our capability to go to the giant TRS-80® Computer warehouse 5 hours away, in Ft. Worth, Texas, to keep you in stock.

JOE McMANUS

* TRS-80 is a Registered Trademark of Tandy Corp

ED McMANUS



asap

computer
products, inc.

1198 E. Willow St., Signal Hill, CA 90806

Call Toll Free (800) 421-7701

In California (213) 595-6431

or (714) 891-2663

In Canada Call ASAP Computer
Products LTD., 116 Viceroy Rd., D-12 Concord
Toronto, Ontario, Canada L4K 1A9
(416) 738-0500 (800) 268-1996

OKIDATA

82A	80-column	\$ 460.00
83A	136-column	\$ 699.00
84AP	136-column, parallel	\$1,095.00
84AS	136-column, serial	\$1,225.00



Oki Graph 1 \$ 40.00

INTERFACES & CABLES

OKI-1	2K serial buffer	\$ 85.00
AEI-1	Parallel interface	\$ 40.00
AEC-1	Cable to Apple	\$ 17.95
AEC-2	Cable to Atari	\$ 19.95
RSC-2	RS-232 cable	\$ 25.00
TRSE-1	Cable to TRS-80	\$ 18.95

C.I.TOH

8510ADC	Pro/Writer serial & parallel	\$ 695.00
---------	------------------------------	-----------



8510AP	Pro/Writer, parallel	\$ 499.00
1550	Pro/Writer II serial & parallel	Call for price
F10-40PU	Printmaster, parallel	\$1,495.00
F10-40RU	Printmaster, serial	\$1,495.00

EPSON*

MX-80	80-column dot matrix	Call
-------	----------------------	------



MX-80FT	80-column, friction feed	Call
MX-100	132-column dot matrix	Call

*Graphtrax Plus standard on all models

INTERFACES & CABLES

EPI-1	2K serial buffer interface	\$ 65.00
AEI-1	Parallel interface	\$ 40.00
SEI-1	Serial interface	\$ 35.00
AEC-1	Cable to Apple	\$ 17.95
AEC-2	Cable to Atari	\$ 19.95
RSC-1	RS-232 cable	\$ 19.95

DRIVE CABINETS*

CAB8H	2 Drive, 8" horizontal	\$260.00
CAB8V	2 Drive, 8" vertical	\$275.00
CAB8V/2F9SMB	2 Drive, Shugart or Qume 8" with 9-slot motherboard	Call for price



X5	Desktop mainframe, small power supply	\$210.00
800D	Desktop mainframe, standard power supply	\$255.00
CAB5V	1 Drive, Shugart or Qume 5 1/4"	\$ 75.00

*All cabinets come complete with power supply, fan & internal cables

DISK DRIVES

Qume DT-5	ANSI 5 1/4" compatibility	\$325.00
Qume DT-8	IBM compatibility	\$480.00
Shugart 801	Standard floppy	\$390.00
Shugart 850	Double-sided floppy	\$600.00
Mitsubishi M2894-63	8" double-sided, double-density	\$475.00
Mitsubishi M4853	5 1/4" 96 TPI, 1MB	Call for price

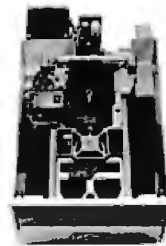

Mitsubishi M4854	5 1/4" double-sided, 1.5 MB	Call for price
------------------	-----------------------------	----------------

ALL PRICES SUBJECT TO CHANGE WITHOUT NOTICE. CALL FOR BEST PRICE.

ASAP offers a 15-day buyer protection policy: full money-back guarantee if not totally satisfied.

Ordering Information: name, address, phone; ship by: UPS or Mail. Shipping charge: add \$2.90 up to 1 lb. (UPS blue), U.S. Mail add \$1.50 (U.S. only) (\$25.00 minimum order).

Terms: We accept cash, check, money orders, Visa and Master Charge (U.S. funds only). Tax: 6% Calif. res., COD's and terms available on approval (School PO's Accepted).

SUBSYSTEMS

CAB5V/1Q	Single cabinet with Qume DT-5	\$ 375.00
CAB8H/V+1S	Dual cabinet with Shugart 801R	\$ 690.00
CAB8H/V+2S	Dual cabinet with (2) Shugart 801R	\$1,065.00
CAB8H+1M	Dual horizontal cabinet with (1) Mitsubishi 8"	\$ 705.00
CAB8H+2M	Dual horizontal cabinet with (2) Mitsubishi 8"	\$1,190.00
CAB8H+1Q	Dual horizontal cabinet with (1) Qume DT-8	\$ 735.00
CAB8H+2Q	Dual horizontal cabinet with (2) Qume DT-8	\$1,220.00
CAB8V+1Q	Dual vertical cabinet with (1) Qume DT-8	\$ 750.00
CAB8V+2Q	Dual vertical cabinet with (2) Qume DT-8	\$1,235.00
CAB8V+1M	Dual vertical cabinet with (1) Mitsubishi 8"	\$ 720.00
CAB8V+2M	Dual vertical cabinet with (2) Mitsubishi 8"	\$1,205.00
HDC8/1-HD	Cabinet with (1) Priam 10MB hard disk & Microbyte Controller	Call for price
HDC8/F+1HD	Cabinet with (1) Qume DT-8 and (1) Priam 10MB hard disk & Microbyte Controller	Call for price

All units assembled & tested, with all cables included.

Modems

Manufacturer	Model #	Price
Novation	CAT	\$159.00
Novation	d-CAT	\$170.00
Novation	Auto-Cat	\$229.00
DC Hayes	Smart Modem	\$235.00
DC Hayes	Micro Modem II (Apple)	\$320.00
DC Hayes	Micro Modem 100	\$320.00
Lexicon	Lex-11	\$139.00
Livermore	LIV-Star 20M	\$149.00
UDS	UDS 103 LP (300 Bd)	\$185.00
UDS	UDS 202 LP (1200 Bd)	\$245.00

Monitors

Manufacturer	Model #	Price
Amdek	100/12" B&W	\$110.00
Amdek	300G/Green	\$165.00
Amdek	Color-1/13"	\$350.00
Sanyo	DM 5109CX/9" Grn.	\$175.00
Sanyo	DM 5012/12" B & W	\$270.00
Sanyo	DM 5112ex/12" Grn.	\$290.00
Sanyo	DM C6013/13" Color	\$450.00
Zenith	ZVM-121/12" Grn.	\$115.00

Terminals

Manufacturer	Model #	Price
Ampex	Dialogue 80	\$780.00
Ampex	Dialogue 81	\$885.00
Televideo	TVI 910	\$625.00
Televideo	TVI 912C	\$725.00
Televideo	TVI 925	\$825.00
Televideo	TVI 950C	\$990.00



SYSTEMS WITH SPICE from CALIFORNIA COMPUTER SYSTEMS FOR APPLE II™ USERS

Synchronous Serial Interface Part Number 7712A	Price: \$149.00
Programmable Timer Part Number 7440A	Price: \$110.00
Asynchronous Serial Interface Part Number 7710A	Price: \$139.00
Calendar/Clock Module Part Number 7424	Price: \$110.00
3 1/4 Digit BCD A-to-D Converter Part Number 7470A	Price: \$110.00
12K ROM/PROM Module Part Number 7114A	Price: \$105.00
Parallel Interface Part Number 7720A	Price: \$115.00
Arithmetic Processor Part Number 7811A	Price: \$349.00
Centronics Printer Interface Part Number 7728A	Price: \$105.00

FOR S-100 USERS

32K Static RAM Board Part Number 2032C	Price: \$475.00
16K Static RAM Board Part Number 2116C	Price: \$290.00
64K Dynamic RAM Board Part Number 2065C	Price: \$375.00
Z80A CPU Board Part Number 2810A	Price: \$295.00
Floppy Disk Controller Part Number 2422A	Price: \$365.00
CP/M™ Version 2.2 Free With Purchase	
S-100 Mainframe Part Number 2200A	Price: \$475.00
S-100 Motherboard Part Number 2501A	Price: \$150.00
4-Port Serial I/O Interface Part Number 2710A	Price: \$295.00
2-Serial, 2-Parallel I/O Board Part Number 2719A	Price: \$325.00
4-Port Parallel I/O Board Part Number 2720A	Price: \$255.00

Connectors

	1-9	10-24	25 up
DB25P	\$2.00	\$1.90	\$1.75
DB25S	\$2.95	\$2.75	\$2.50
DB25C	\$.95	\$.85	\$.75

asap

computer products, inc.

1198 E. Willow St., Signal Hill, CA 90806

Call Toll Free (800) 421-7701

In California (213) 595-6431

or (714) 891-2663

In Canada Call ASAP Computer

Products LTD., 116 Viceroy Rd., D-12 Concord

Toronto, Ontario, Canada L4K 1A9

(416) 738-0500 (800) 268-1996

DISKETTES from ASAP

Part #	Verbatim 5 1/4" Diskettes		Price
	Side/Dens	Sector	
MD525-01	1/Sgl	Soft	10/\$27.50
MD525-10	1/Sgl	Hard 10	10/\$27.50
MD525-16	1/Sgl	Hard 16	10/\$27.50
FD32-1000	8" Diskettes		
	1/Sgl	Hard	10/\$35.00
FD34-1000	1/Sgl	Soft	10/\$35.00

Part #	Memorex 5 1/4" Diskettes		Price
	Side/Dens	Sector	
MEM 3481	1/Sgl	Soft	10/\$26.50
MEM 3483	1/Sgl	Hard 10	10/\$26.50
MEM 3485	1/Sgl	Hard 16	10/\$26.50
MEM 3060	8" Diskettes		
	1/Sgl	Soft	10/\$35.00
MEM 3101	2/Sgl	Soft	10/\$45.00
MEM 3090	1/Sgl	Soft	10/\$45.00
MEM 3102	2/Sgl	Soft	10/\$55.00

Part #	Scotch 3M 5 1/4" Diskettes		Price
	Side/Dens	Sector	
744-0	1/Sgl	Soft	10/\$33.00
744-10	1/Sgl	Hard 10	10/\$33.00
744-16	1/Sgl	Hard 16	10/\$33.00
745-0	2/Sgl	Soft	10/\$45.00
745-10	2/Sgl	Hard 10	10/\$45.00
745-16	2/Sgl	Hard 16	10/\$45.00

Part #	Maxell 5 1/4" Diskettes		Price
	Side/Dens	Sector	
MD1	1/Sgl	Soft	10/\$32.00
MD2D	2/Sgl	Soft	10/\$44.00
MH1	1/Sgl	Hard 16	10/\$39.00
MH2D	2/Sgl	Hard 16	10/\$50.00
FD1-128	8" Diskettes		
	1/Sgl	Soft	10/\$41.00
FH1-32	1/Sgl	Soft 32	10/\$41.00
FD2-XD	2/Sgl	Soft	10/\$50.00

Part #	Elephant Memory Systems		Price
	Side/Dens	Sector	
EMS 1	1/Sgl	Soft	10/\$25.00
EMS 2	1/Sgl	Soft	10/\$27.50
EMS 3	1/Sgl	Hard 10	10/\$27.50
EMS 4	1/Sgl	Hard 16	10/\$27.50
EMS 5	2/Sgl	Soft	10/\$33.00
EMS 6	2/Sgl	Hard 10	10/\$33.00
EMS 7	2/Sgl	Hard 16	10/\$33.00

Part #	SRW Media Storage Cases		Price
	Size		
SRW-5	5 1/4"		\$2.50 ea.
SRW-8	8"		\$3.25 ea.

ALL PRICES SUBJECT TO CHANGE WITHOUT NOTICE. CALL FOR BEST PRICE

ASAP offers a 15-day buyer protection policy: full money-back guarantee if not totally satisfied.

Ordering information: name, address, phone; ship by: UPS or Mail. Shipping charge: add \$2.90 up to 1 lb. (UPS blue), U.S. Mail add \$1.50 (U.S. only) (\$25.00 minimum order).

Terms: We accept cash, check, money orders, Visa and Master Charge (U.S. funds only). Tax: 6% Calif. res., COD's and terms available on approval (School PO's Accepted).

ATARI COMPUTER PRODUCTS



ATARI 800

(16K) Personal Business Computer Features:

- Computer console
- Atari 8K basic
- 57 full stroke alpha-numeric keyboard with four function keys
- Operator's manual
- RF modulator
- Power supply

Call for price
ATARI 400 \$349.00

Software

Description	Price
Atari	
Basketball	\$ 27.00
Super Breakout	\$ 33.00
Chess	\$ 32.00
Video Easel	\$ 26.00
Star Raiders	\$ 37.00
Asteroids	\$ 32.00
Music Composer	\$ 44.00
Assembler/Editor	\$ 45.00
Telexlink I	\$ 24.00
Space Invaders	\$ 33.00
Missile Command	\$ 33.00
Graph It	\$ 17.95
Mailing List	\$ 19.95
Touch Typing	\$ 19.95
Stock Charting	\$ 22.95
Stock Analysis	\$ 19.95
Bond Analysis	\$ 22.95
Word Processor	\$119.00
Personal Finance	\$ 64.95
Microsoft BASIC	\$ 75.00
Pac-Man	\$ 35.00
Centipede	\$ 35.00
Caverns of Mars	\$ 32.00
Datasoft	
Atari Mailing List Disk	19.95
Atari Character Generator Disk	16.95
Text Wizard Disk	89.95
Micropainter Album 1 Disk	16.95
Micropainter Album 2 Disk	16.95
Le Stick Accessory	30.00

Innovative Design Software, Inc.	
Pool 1.5 HI-RES 48K	\$28.95
On-Line Systems	
HI-RES Adv #0 — Mission: Asteroid Disk	19.95
HI-RES Adv #2 — Wiz & Princess Disk	25.00
Roadwork Disk	29.95
Jawbreaker Disk	25.00
Soft porn Adventure (X-rated) Disk	25.00
The Next Step Disk	29.95

Personal Software	
Visicalc Disk	169.00
Arcade Plus	
Ghost Hunter (Cassette)	\$ 23.50
Ghost Hunter (Disk)	\$ 27.50

Atari Optional Accessories

Model #	Description	Price
410	Program Recorder	\$ 80.00
810	Disk Drive System	\$470.00
822	40 Column Thermal Printer	\$299.00
820	40 Column Dot Matrix Printer	\$279.00
825	80 Column Dot Matrix Printer	\$645.00
830	Acoustic Modem	\$159.00
850	Interface Module	\$175.00
CX30-04	Paddle Controls	\$ 17.95
CX40-04	Joysticks (pair)	\$ 17.95
A16KA	16K RAM Board	\$ 45.00

Components

4116's (200 nS)/5290-3

Apple, TRS-80, Heath	
1-15	\$1.50 each 50-99 \$1.30 each
16-49	\$1.40 each 100 up \$1.20 each

1 Mhz - 12 Bit A/D

for your Apple II Computer

The APPLESCOPE-HR12 analog to digital converter uses a high stability buried zener voltage reference and a flash A/D to give 12 bit accuracy with a 14 bit dynamic range.

- DC to 1 Mhz Programmable Sample Rate
- 2048 Sample Buffer Memory
- Pretrigger Viewing
- Continuous or Single Sweep
- 4 Channel Software Support (requires additional power supply)
- External Trigger Input

The standard software provided with each APPLESCOPE-HR 12 includes all of the functions necessary to turn your Apple II computer into a high quality digital storage oscilloscope. In addition all of the SCOPE DRIVER options are being up-graded to handle the higher resolution data.

Price per channel: **\$695**

The original APPLESCOPE still provides the optimum price/performance trade off for those users requiring 8 bit converter resolution.

APPLESCOPE INTERFACE

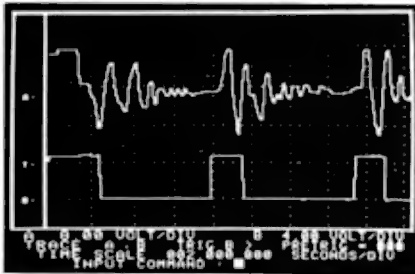

- DC to 3.5 Mhz sample rate
- 1024 byte buffer memory
- Pretrigger Viewing
- Programmable Scale Select
- Continuous and Single Sweep Modes
- Single or Dual Channel Trace

Price for the two board Applescope system is **\$595**
EXTERNAL TRIGGER ADAPTER **\$29**

SCOPE DRIVER Advanced software for the APPLESCOPE analog to digital converters makes full use of the computing power of the Apple II to create a total data acquisition system. Available options include:

- Signal Averaging-Acquires 1 to 999 signal sweeps and displays the averaged result.
- Digital Volt Meter-Allows use as real time DVM or use to measure points on an acquired sweep.
- Disk Storage - Allows automatic storage and recover of acquired data on floppy disks.
- Spectrum Analyzer-Calculates and displays frequency spectrum of acquired data.

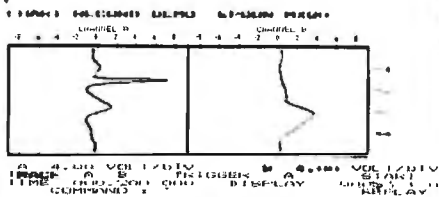

BUS RIDER

LOGIC ANALYZER for the APPLE II

The BUS RIDER circuit card silently rides the Apple II peripheral bus and allows real time tracking of program flow. Software provided allows set up of trace parameters from the keyboard and read back of disassembled code after a program has been tracked

- 32 bit by 512 sample memory buffer
- Monitors Data and Address bus plus 8 external inputs
- Trigger on any 32 bit word or external trigger
- Pretrigger viewing

The BUS RIDER is an invaluable development tool for anyone working with Apple II or Apple II+ computers.

Price **\$395**

RC ELECTRONICS INC.

7265 Tuolumne Dr., Goleta, CA 93117

(805) 968-6614

teachers to edit existing lessons easily. For example, a lesson may be added to or deleted from a disk at any time. Any component of a question (i.e., text, correct- or wrong-answer groups, hints, unexpected replies, or failure messages) can be modified without altering the other components of the question. Changes in branching direction or performance criteria for the next lesson can also be made at any time. Student records—including name, ID number, special assignments, lessons completed, scores, and hours of usage—can be added, deleted, or changed without affecting the remaining data in the file.

Finally, complete lessons may be displayed for section-by-section editing on the video screen or on a line printer. Because lesson-text editing is done line by line, minor corrections can be inserted without having to retype the entire lesson. One inconvenience accompanies line-by-line editing. Each line of a lesson is a different string variable within the program. If one notices an error in a previous line when editing or writing a lesson, it is impossible to return to that line by moving the cursor backward. Instead, the teacher must begin the lesson-editing routine anew in order to make the correction. This inconvenience can be avoided if the lesson is carefully proofread and care is taken to avoid typing errors.

Documentation

Accompanying the AIDS hardware and software is a 200-page, 6-chapter instruction manual that comes in a 3-ring binder. This manual is designed to give the user a thorough understanding of all the system's features. A demonstration disk is also available for potential buyers desiring to review the system themselves.

Hardware/Software

The Assisted Instructional Development System is currently available for the Apple II Plus microcomputer with 48K bytes of RAM and DOS 3.2 or 3.3. (According to a spokesperson for Instructional Development Sys-

tems, the company intends to make the AIDS package available for Radio Shack's TRS-80 microcomputers.) In addition to the program and instruction manual, the AIDS package includes a hardware interface card with an onboard calendar/time clock for dating records as well as timing lessons and student responses. The cost of the entire package is \$345.

Conclusions

The AIDS package has been designed with the educator in mind and has several practical advantages over previous software approaches to CAI. A few shortcomings, however, should be mentioned.

First, the question/answer formats presently do not accommodate matching-type questions. Also, the lesson-design format favors an information-oriented approach, providing limited flexibility for alternative designs.

Second, after every three or four questions the disk must be accessed to load the next questions. Low-resolution animated graphics entertain the student while this loading is taking place, but, after a while, such frequent delays can become tedious.

Finally, although the graphics are an entertaining part of the system, no means is available (as yet) for incorporating graphics into the teacher's written lesson. According to Instructional Development Systems, this will be remedied in the near future by the inclusion of both low- and high-resolution graphics options. Other enhancement plans include a question-evaluation feature and a special interface to videotape or videodisc systems so that audiovisual material can be incorporated into the lessons.

Despite any shortcomings, the AIDS package is a flexible, simple, and time-efficient way for teachers to create CAI lessons. Although it can never be a substitute for programming expertise, the Assisted Development Instructional System can fill the needs of many educators and will serve as a model for future systems dedicated to the development of CAI. ■

DEC LSI-11 Components

Dependable service
at discount prices

Domestic
and Export

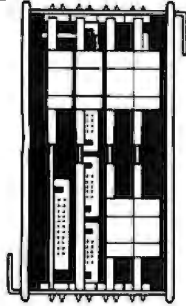

Mini
Computer Suppliers, Inc.

25 Chatham Rd., Summit, N.J. 07901
Since 1973

(201) 277-6150 Telex 13-6476

©Mini Computer Suppliers, Inc.
1979

COMPARE DISCOS, A Multi-User RDOStm, Feature for Feature to UNIXtm

- Multi-programming with up to 8 separate users
- Multi-tasking for each user
- Multiple languages available: Algol, Fortran IV and V, Basic, Business Basic, Cobol, Pascal, C, etc.
- Word Processing and Text Processing available
- Multi-user RDOStm has real-time features
- Wide range of applications software packages available



132 E St., Suite 3B □ Davis, CA 95616 □ (916) 758-9355

DISCOS is available for RDOStm systems on mapped
Data General Novas* or Eclipses*

NOVA* and ECLIPSE* are U.S. Registered Trademarks
of Data General Corporation □ UNIXtm is a trademark of Bell Laboratories

APPLE SPEAKS INTELLIGENTLY!



The people who dared to teach Atari to talk are again challenging the microcomputer establishment with the VOICEBOX Speech Synthesizer for Apple. This low cost intelligent peripheral can speak thousands of words unassisted, generated directly from its firmware ROM dictionary located on its plug-in card. This means that speech, with variable intonation and speed, can be used in any of your apple programs without ever having to bother loading a disk. And, in case you want to expand your dictionary to include unusual words or words in foreign languages, you can easily define them with our 64 phonemes and store them by the thousands on one of the six special dictionaries provided for on our disk.

In addition your VOICEBOX for Apple can be easily coded to sing on key with uniform barlengths and you can store (record) your songs on disk, retrieving and modifying sections whenever you want. With the disk system, you'll also enjoy an educational random sentence generator and graphic speech animation! The VOICEBOX for Apple will run on 32K Apple II with Applesoft or Apple II Plus systems equipped with sixteen-sector disk drives. VOICEBOX for Apple comes with loudspeaker and disk. The Alien Group also makes a less expensive VOICEBOX for Apple with all features (including expandable disk dictionary), but excluding firmware ROM and singing capability. Speaker is optional on this unit.

For Atari users,
the VOICEBOX for
16K and up Atari
plugs directly into the

serial port. No extra cables are needed and no speaker is needed since the speech comes directly over your TV monitor. This unit has all speech synthesis features except singing and firmware ROM.

- AL-3001 VOICEBOX for Apple. With firmware ROM, singing capability and speaker \$215.00
- AL-3501 VOICEBOX for Apple. Without firmware ROM, singing capability and speaker \$139.00
- AL-4001 Speaker for AL-3501 (the AL-3501 will also work with any other speaker) \$15.00
- AL-5001 VOICEBOX for Atari \$169.00

All mail orders are on a 10 day moneyback guarantee if you're not completely satisfied. When ordering enclose check or money-order or state VISA or MASTERCARD number. Send mail orders to:

THE ALIEN GROUP	or Telephone orders
27 West 23rd Street	from 10 AM to 6 PM
Dept. BT-2	New York time
New York, New York 10010	(212) 924-5546

ALSO AVAILABLE AT LEADING COMPUTER STORES
THROUGHOUT THE WORLD.

Book Reviews

Software Design: Methods & Techniques

Lawrence J. Peters
Yourdon Press
New York, 1981
248 pages
softcover, \$23

Reviewed by
Paul S. Swanson
97 Jackson St.
Cambridge, MA 02140

Software Design: Methods & Techniques is a valuable source book for both the experienced software designer and the initiate. A compilation of various methods and techniques available to software designers, the book examines each method individually and summarizes its advantages and disadvantages.

Peters begins with a discussion of a quandary that software designers face. Like other engineers, software engineers require problem-solving methods. But while other engineers have access to fixed, known solution meth-

ods for a specific problem, no such clear-cut solutions are available to software engineers. In software, not only are the methods of solution in their stages of infancy, but the problems themselves are usually only vaguely defined. And that brings us to Peters' second major topic: defining design. Although he asserts that design has never been adequately defined, he provides a thorough description of the subject from several viewpoints.

Software Design: Methods & Techniques addresses 44 of the many different methods currently used in software design representation, treating system architecture, design structure, database structure, and software behavior separately. Each category in turn contains several methods. Summary charts show the relative strengths and weaknesses of each.

Among the methods Peters presents is the design tree, from which many other methods are derived. The derivatives, however, either stress or ignore various items in the

system and therefore have different strengths and weaknesses. Some methods are hybrids that combine advantages.

After exploring different approaches to design representation, Peters turns to software design methods. He divides these into three types: data-flow-oriented, data-structure-oriented, and prescriptive. Each is presented in synopsis form with descriptions, examples, and tables showing its relative strengths and weaknesses. Peters includes a list of references for those interested in further reading.

Peters' views on flowcharts struck me as particularly amusing in light of the emphasis I have heard placed on them. He seems to have the same opinion of them that I do—they simply answer the wrong question. At one point, he mentions that they were invented to document existing software. That they are used in the design stages of software may have some bearing on why many people I know dislike them so much.

After presenting the methods, Peters describes ways to combine them. As he points out, some methods are better suited to people who do the programming, while others are better suited to users. The section on forming a methodology offers guidelines for developing a software design tailored to a particular project.

Peters' book is not only pleasant reading but will make a good reference manual because specific information in it is easy to locate. The charts and diagrams are plentiful and, for the most part, very informative. And the order of the book makes for logical transitions from one section to the next.

I recommend *Software Design: Methods & Techniques* to anyone who assembles or plans to assemble larger software systems on any computer system. Any programmer who understands the value of using a disk for program and data storage would benefit substantially from the information presented in this book. ■

NEW FOR THE IBM PERSONAL COMPUTER WHY STOP AT 256K OF RAM?

PC/RAM STACK

256K/512K Ram Extension Board
For The IBM Personal Computer

PC/RAM STACK allows expanding the IBM Personal Computer's memory by 512K in just one I/O expansion slot, leaving the other slots available for I/O functions and peripherals.

SUGGESTED RETAIL

512K Model	\$1795.00
256K Expandable to 512K	\$1195.00
256K Non Expandable Model	\$995.00
64K Expandable to 256K	\$495.00
	each

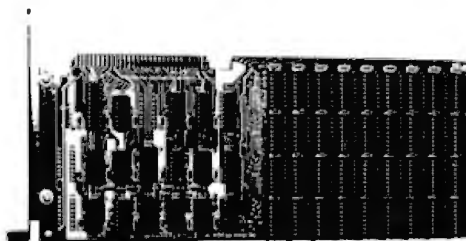

FREE SOFTWARE

With each 256K or 512K PC/Ram Stack purchased before September 1, "MDISK" software allows accessing all or part of PC/Ram Stack as if it were Disk Drive C:. Only 5 to 10 times faster.

**NATIONAL
TECHNOLOGY
SALES**

P.O. Box 401782
Garland, Texas 75040
(214)349-8259

PRINTERS:

EPSON:

MX-80	\$460.00
NEW - MX-80 with GrafTrax Plus	\$500.00
NEW - MX-80 FT with GrafTrax Plus	\$595.00
NEW - MX-100 with GrafTrax Plus	\$680.00

TALLY:

MT-1802/5 NLQ	\$1795.00
MT-120I	\$845.00
MT-120L	\$990.00

SMITH-CORONA:

TP-1 Letter Quality	\$725.00
---------------------------	----------

NEW

Three Functions on One Board:

1. 256K RAM with parity
2. SASI interface for winchester disk
3. Asynchronous communications port with RS-232 and current 100P interfaces

STOP!! LOOK!! WE HAVE THE LOWEST MAIL ORDER PRICES AVAILABLE

BMC 12" GREEN SCREEN

- 15 MHZ
- 80 x 24 lines • 13 lbs.
- ONLY \$87.00

PRINTERS

Microline 82A	\$ 460.00
Microline 83A	699.00
Microline 84	999.00
Microline 84 (Serial) ..	1125.00
Epson MX-80	435.00
Epson MX-100	695.00
NEC 8023A	479.00

DISK DRIVES

Tandon TM-100-1	\$ 220.00
Tandon TM-100-4	430.00
Shugart SA400L	249.00
Shugart 801R	380.00
Qume DT-8	480.00

APPLE PRODUCTS

Apple II Plus (48K)	\$1190.00
Franklin Ace (64K)	1050.00
Fourth Disk Drive	360.00
Micro-Sci A-2 Drive	370.00
16K Ram (by MPC)	95.00
Parallel Card & Cable	65.00
8K Serial Buffer Interface	130.00

DRIVES FOR APPLE

Rana Drive

- 40 Tracks • Works with either Controller • 300% Greater track-to-track speed • Sleek Cabinet
- Runs Apple Dos 3.3 CP/m 2.2 Pascal 1.1 • Controller will support 4 drives

Rana Dr. w/Controller \$	359.00
Rana Dr. w/Controller \$	449.00
Controller	\$ 115.00

MONITORS

Amdek Color I	\$335.00
Amdek Color II (Hi-Res) ..	695.00
Amdek Color III (Med-Res) ..	450.00
Zenith 12" Grn	110.00
BMC Color 13"	329.00

COMPONENTS

	1 pc.	50 pcs.
2532 (450NS) ..	\$ 7.00	\$6.50
2716 (450NS) ..	4.20	3.90
2732 (450NS) ..	7.25	6.75
4116 (200NS) ..	1.70	1.40
4164 (200NS) ..	10.00	9.00
6116 (150NS) ..	7.60	6.90

HAVA-COMPUTER

1857 Montana Vista, Suite C
Lake Havasu City, AZ 86403
ORDER DESK: (602) 453-6282

• All Products New • Most items shipped in 24 hrs. • No surcharge
Order Info. • MC • VISA • M.O. / Check • Min. shipping order \$3.50
Prices subject to change

Model 953A EPROM PROGRAMMER

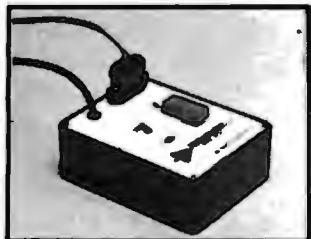

- Programs 2508, 2758, 2516, 2716, 2532 and 2732 five volt EPROMS.
- Complete - no personality modules to buy.
- Intelligent - microprocessor based; programs and verifies any or all bytes.
- RS-232 serial interface - use with computer or terminal.
- Verify erasure command - verifies that EPROM is erased.
- Extended diagnostics - error output distinguishes between a bad EPROM and one which needs erasing.
- May be used for extremely reliable data or program storage.
- All power on programming socket under processor control. LED warning light indicates when power is applied.
- Complete with Textool zero insertion force socket.
- High performance/cost ratio.
- Standard DB-25 I/O connector.

PRICE \$289

BTA BAY TECHNICAL ASSOCIATES, inc.
HWY. 603, P.O. BOX 387
BAY ST. LOUIS, MISSISSIPPI 39520
(601) 467-8231

TRS-80™ By RADIO SHACK

1-800-841-0860 Toll Free

BUY DIRECT
PURE RADIO SHACK EQUIPMENT
LOW DISCOUNT PRICES

TRS-80 Color Computer



BUY DIRECT

PRICED FROM **\$309**

TRS-80 Model II Computer



BUY DIRECT

PRICED FROM **\$3098**

TRS-80 Model III Computer



BUY DIRECT

PRICED FROM **\$609**

TRS-80 Model 16 Computer



BUY DIRECT

PRICED FROM **\$4158**

Smith Corona TP-1 Daisy Wheel Printer



BUY DIRECT

*LIST \$895**
\$695

Commodore

VIC-20

The Friendly Computer

\$249

TM - TANDY CORPORATION
FREE COPY OF WARRANTY
UPON REQUEST

CENTRONICS 7397
\$499

WRITE FOR YOUR FREE CATALOG

We Carry The Full TRS-80 Product Line

MICRO MANAGEMENT SYSTEMS, INC

PARCEL DIVISION - DEPT. NO. 1

2803 Thomasville Road East

Cairo, Georgia 31728

GA. & INFO 912-377-7120

SMITH-CORONA

VIC-20
The Friendly Computer

Thousands of Satisfied Customers Since '78

Ask BYTE

Conducted by Steve Ciarcia

Tips on Homebrewing

Dear Steve,

I have started doing some research for my next project: building my own microcomputer and am interested in your book *Build Your Own Z80 Computer*. I have read several similar books and am getting ready to start design and construction; however, I have a number of questions:

- If I wish to incorporate a BASIC interpreter in my computer (not tiny BASIC but something akin to TRS-80 Level II, etc.), I presumably need to purchase a ROM (read-only memory) containing this program. Where do I find one? I haven't seen them advertised in the mail-order places in the popular magazines.
- Along the same line, where can I buy an interpreter for assembly language so that I can use mnemonic op codes instead of hexadecimal codes for programming?
- Is it possible for a home-built machine to be software-compatible with, say, the Radio Shack TRS-80 Model I? In other words, is it realistic to try and build a machine that will be able to load and run tapes or disks made for the TRS-80?
- Are there many different BASIC interpreters from which to choose? If so, which do you consider the best from a homebrewer's point of view?

David J. Abineri
Lakewood, OH

Microsoft BASIC is the de facto standard among BASIC interpreters and is the most popular BASIC in use today. Netronics Research & Development Ltd. (333 Litchfield

Rd., New Milford, CT 06776, (800) 243-7428; in Connecticut, (203) 354-9375) markets an 8K-byte Microsoft BASIC for the Intel 8085 microprocessor that you might want to look into. A cassette version is available for \$64.95 postpaid, and a ROM version is available for \$99.95, plus a \$2 shipping charge. The 8085 is 100% software-compatible with the 8080A and the Z80 (but it does not have all of the Z80 instructions).

For programming in assembly language, you need an assembler, not an interpreter. An assembler allows you to type in the instruction-set mnemonics and specify the program's start address. It then will "assemble" machine language starting at the specified address. Unfortunately, most of the assemblers sold today are geared toward a particular computer. However, I know an excellent book that provides a detailed explanation and complete listing of an assembler for an 8080-based system. It's called TEA: An 8080/8085 Co-Resident Editor/Assembler by Christopher A. Titus. It's published by Howard W. Sams & Company (4300 West 62nd St., POB 7092, Indianapolis, IN 46206, (800) 428-3696; in Indiana, (317) 298-5400) and sells for \$10.95.

For a home-built machine to be software-compatible with the TRS-80, it would need the TRS-80 operating system and TRS-80 Level II BASIC. It is not realistic to try to build a TRS-80-compatible machine from scratch.

Rather than try to copy the TRS-80, I would suggest that, if you wish to build a Z80 computer, build it along the lines of my ZAP computer. Make it S-100-bus-compat-

ible and add some memory and a floppy-disk controller. You can use CP/M (a disk operating system that can run a good Microsoft disk BASIC called BASIC-80) and you will have an unlimited amount of good software available.

The only real problem in custom building your own computer is that you are not software-compatible with anyone and you are constantly "reinventing the wheel" every time you write a program. . . . Steve

Where Does the BASIC Go?

Dear Steve,

I don't know much about computers yet, but I read or heard somewhere that if you wanted to use Pascal or any other language instead of the BASIC that comes with a certain system, you would replace the BASIC with Pascal in the ROM (read-only memory). Would I still have the BASIC in ROM or not? Can you explain it to me?

Thanks.

Keith McCreery
Portage, MI

Using Pascal in a computer that has BASIC in ROM does not affect the BASIC in any way. Pascal is just loaded into user memory. Normally, when another language is used, additional user memory is mapped into the memory-address space used by the ROM BASIC. In this way, the full addressing capability of the microprocessor can be used.

For example, in the Apple II computer, which has BASIC in ROM, supplementary languages are employed through the use of a "lan-

guage card." This provides an additional 16K bytes of memory in place of the BASIC ROM when Pascal is used. The ROM BASIC is still in the computer, but it's bypassed. . . . Steve

Disturbing Line Disturbances

Dear Steve,

I own an Atari 800 that has been sent for repairs three times. I use it with an RCA XL-100 TV, which occasionally loses its screen or flickers for a second when the furnace switches on or off. However, the Atari does not "crash" during the display disturbance. Should I be concerned about the possibility of voltage spikes? I've heard that they can damage the internal parts of a computer, but can they damage a computer when it's off? What should I look for in a power-line protector? The literature from manufacturers seems inadequate.

Walter M. Lee
Olney, MD

The symptoms you describe suggest that you are experiencing a voltage drop as well as possible spikes. Many devices on the market protect against voltage transients by clipping the peaks, thereby keeping them in a safe range, but such devices will not prevent the line voltage from dropping to the point where the computer memory becomes erratic.

From the fact that your Atari 800 does not "crash" during these disturbances, I would suggest a device to clip the transients. This will protect your computer from damage. These units are usually MOVs (metal-oxide



A Message to our Subscribers

From time to time we make the BYTE subscriber list available to other companies who wish to send our subscribers promotional material about their products. We take great care to screen these companies, choosing only those who are reputable, and whose products, services, or information we feel would be of interest to you. Direct mail is an efficient medium for presenting the latest personal computer goods and services to our subscribers.

Many BYTE subscribers appreciate this controlled use of our mailing list, and look forward to finding

information of interest to them in the mail. Used are our subscribers' names and addresses only (no other information we may have is ever given).

While we believe the distribution of this information is of benefit to our subscribers, we firmly respect the wishes of any subscriber who does not want to receive such promotional literature. Should you wish to restrict the use of your name, simply send your request to BYTE Publications Inc, Attn: Circulation Department, 70 Main St, Peterborough NH 03458. Thank you.

FREE!

MICROCOMPUTER IDEA BOOK & CATALOG.

- **One-Stop Shopping.** More than 1000 microcomputer accessories and supplies - from diskettes and line-printer paper to connectors and cables - for Apple, Atari, Northstar, TRS-80s and many others. Loaded with ideas for extra convenience and efficiency.
- **Easy Ordering.** By mail, phone, or FAX. Friendly, helpful, expert assistance.
- **Fast Delivery.** Your order shipped in 24 hours from the Inmac Center nearest you. Overnight emergency shipments also available.
- **Risk-Free Trial.** Try any product for 45 days. If not satisfied, return for full refund.
- **Guaranteed Quality.** Field-tested for precision performance and compatibility. Backed by warranties ranging up to 10 years - and some with Lifetime Guarantees.

Please RUSH my copy of the Microcomputer Idea Book & Catalog.

Name _____ Title _____
 Company _____ Phone _____
 Address _____
 City _____ State _____ Zip _____

**SEND TODAY FOR YOUR
FREE MICROCOMPUTER
IDEA BOOK &
CATALOG OR
PHONE (408)
727-1970.**

inmac

Catalog Dept., 88-82
2465 Augustine Dr.,
Santa Clara,
CA 95051.



800-SOFTWARE DECLARES WAR ON CPM® PRICES!

dBASE II™
\$495

WORDSTAR™
\$239
IBM/PC

SuperCalc™
\$199
IBM/PC

PERFECT WRITER™
\$249

800-227-4587 GETS YOU THE BEST FOR LESS

MICROPRO™	For Apple	For CPM
Word Star	\$.199	\$.239
CalcStar	\$.119	\$.199
MailMerge	\$.69	\$.79
SpellStar	\$.119	\$.169
DataStar	\$.169	\$.199
SuperSort	\$.119	\$.169
dBASE II.™	\$.495	
SUPERCALC™	\$.199	
SPELLGUARD™	\$.199	

PERFECT SOFTWARE™	
Perfect Writer	\$.249
Perfect Speller	\$.129
Perfect Filer	\$.199
SMARTERM.™	\$.49
ARTIFICIAL INTELLIGENCE	
medical	\$.495
dental	\$.495
CBASIC.™	\$.99

SELECT™ "the word processor" ..	\$.449
PICKLES and TROUT™ ..	\$.169
MICROSOFT™	
Softcard ..	\$.289
Videoterm ..	\$.279
Ram Card ..	\$.169
All three above ..	\$.579
FOX AND GELLER™	
Quickcode ..	\$.239

TCS ACCOUNTING™	
general ledger	\$.99
accounts payable	\$.99
accounts receivable	\$.99
payroll	\$.99
all four above	\$.249
inventory management	\$.99
trsdos accounting package ..	\$.199
MBASIC	\$.279

WE OFFER TECHNICAL SUPPORT ON ALL SALES

TO ORDER CALL TOLL FREE 800-227-4587 * * VISA-MASTER-AM. EX.

- FREE CUSTOMER SERVICE 415-974-5990
- RELIABLE UPS BLUE LABEL DELIVERY
- WE SPECIALIZE IN BUSINESS CPM*

* * 800-622-0678 in California (Calif. residents add sales tax)

800-SOFTWARE™
185 Berry Street
San Francisco, California 94107

800-SOFTWARE HAS THE BEST CPM® PRICES!

varistors) and are rated by their energy absorption, usually in joules. Choose the largest one that you can find.

If the voltage spikes do not exceed the voltage-breakdown rating of the computer's plug transformer, there is little harm in leaving the computer plugged in after it is turned off. With the transient suppressor in the line, this problem vanishes. . . . Steve

Always Correct Clock

Dear Steve,

Some time ago I saw Don Lancaster's *TTL Cookbook* and became very interested in the "always correct clock" he talked about. I have tried to

find the *Popular Electronics* issues he refers to but have not been able to do so (*Popular Electronics* does not have back issues that old). What I want to do is build that clock and bring the time value to a series of ports that connect with my S-100 system. With this approach, the clock will be correct so long as there is power for the computer. Any information you can supply would be helpful.

Tim R. Norton
Richardson, TX

The articles that Don Lancaster referred to were in the July 1972 and July 1973 issues of *Radio-Electronics*, not *Popular Electronics*. What he also neglected to mention is

the complexity of the receiver necessary to receive and decode the information broadcast at 60 kHz from station WWVB in Boulder, Colorado.

Many S-100 clock boards on the market feature quartz crystals for their timing and should be accurate to within a few seconds a month. This is more than adequate for almost all conceivable timing applications. Some even have onboard battery backup to maintain their accuracy when the computer is shut off. The ready availability and moderate cost of these boards makes them the obvious choice.

For further information, see my article "Everyone Can Know the Real Time" (May 1982 *BYTE*, page 34). . . . Steve

Z8-based Voice-Recognition System

Dear Steve,

I'm working on a voice-recognition system using the Zilog Z8 microprocessor. I need advice on interfacing the Z8 board with an inexpensive speech recognizer that handles 32 words.

I'm a rank beginner.

Robert J. Marek
Waltham, MA

Interfacing a voice-recognition system to the Z8 is not difficult because there are sufficient I/O ports for the hardware portion of it. The tiny BASIC may not be sophisticated enough, so you may have to use machine language.

Since its initial presentation in the July and August 1981 *BYTEs* (see "Build a Z8-Based Control Computer with BASIC," Part 1, July, page 38; Part 2, August, page 50), many accessories have become available for the

Z8-BASIC Microcomputer from The Micromint (917 Midway, Woodmere, NY 11598, (800) 645-3476; in New York, (516) 374-6793). In addition to cross assemblers that run on TRS-80 and CP/M systems, The Micromint has a memory, parallel I/O, and cassette-interface expansion board; a motherboard; and an EPROM (erasable programmable read-only memory) programmer. Other peripherals are in the works.

An excellent article by James R. Boddie, "Speech Recognition for a Personal Computer System," appeared in the July 1977 *BYTE* (see page 64). You can also read "An Extremely Low-Cost Voice Response System" by James C. Anderson (February 1981 *BYTE*, page 36), "Speech Recognition: Turning Theory to Practice" by George R. Doddington and Thomas B. Schalk (*IEEE Spectrum*, September 1981, page 26), and my article "Use Voice Prints to Analyze Speech" (March 1982 *BYTE*, page 50). With help from these articles, you should be able to write the necessary software. . . . Steve ■

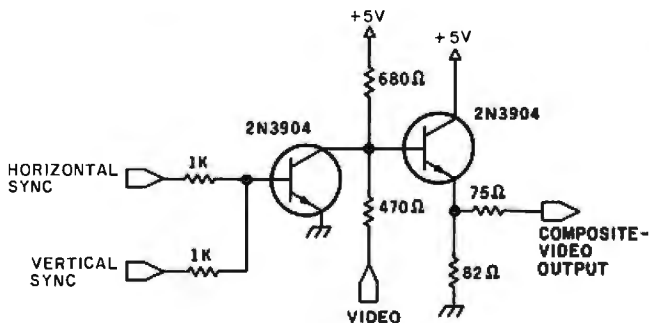

Figure 1

Composite Video from PETs

Dear Steve,

I own a Commodore PET 2001 computer with the old ROM (read-only memory) set. I recently purchased a Sanyo DM5112CX video monitor that I intend to use along with the PET's 9-inch monitor. Are you aware of a simple circuit that would take the signals from the PET and give me the composite-video signal that I need for the Sanyo? From the PET, I can easily get the following signals:

- horizontal drive (TTL)
- vertical drive (TTL)
- video (TTL)

I can also get a +5-volt signal from the main logic board.

David Rene Anatol
Philadelphia, PA

Obtaining a composite-video signal from the horizontal sync, vertical sync, and video signals from the PET 2001 is very easy. The circuit shown in figure 1 is a video combiner that transforms the three separate inputs into a composite-video output. . . . Steve

In "Ask BYTE," Steve Ciarcia answers questions on any area of microcomputing. The most representative questions received each month will be answered and published. Do you have a nagging problem? Send your inquiry to:
Ask BYTE
c/o Steve Ciarcia
POB 582
Glastonbury CT 06033
If you are a subscriber to The Source, send your questions by electronic mail or chat with Steve directly. Due to the high volume of inquiries, personal replies cannot be given. Be sure to include "Ask BYTE" in the address.

YOUR COMPUTER HEADQUARTERS

apple®

BUSINESSMAN'S SPECIAL

Apple II plus 48K, Apple Disc Drive II w/DOs 3.3, 12" High Resolution Green Monitor, Visicalc 3.3 Software

\$2039.00



WORD PROCESSOR SYSTEM

Apple II plus 48K, Apple Disc Drive II with DOS 3.3, 12" High Resolution Monitor, OKDATA Microline 80 Printer, Printer cable w/Interface, Apple Writer

\$2339.00

SPECIAL OFFER!

Buy a Microsoft Z-80 CP/M card for \$279.95, a Videx Videoterm 80 col. board for \$259.95 and a CP/M Users' Guide for \$10.00, then save \$100.00 on purchase of the 16K Microsoft RAM Card

Reg. \$159.95

Now Only **\$59.95**

Plus get a FREE Videx Soft Switch (\$30 Value).

Apple is a registered trademark of Apple Computer Inc.

ACCESSORIES FOR APPLE

Videx Videoterm - 80 Col. \$259.95
Videx Enhancer II. \$119.95
DC Hayes Micromodem II \$289.95
Microsoft Z-80 CP/M Card \$279.95
Microsoft 16K Ram Card \$159.95
Saturn 32K Ram Card \$199.95
VC Expand for Saturn Card \$84.95
Mountain CPS
MultiFunction Card \$179.95
Mountain Clock \$239.95
Keyboard Company
Numeric Keypad \$135.95
Apple Pascal \$209.95
CCS Serial Interface \$189.95
System Saver fan with Line Surge Suppression \$74.95
Apple Graphics, Tablet \$649.95
Verawriter Graphic Tablet \$249.95
Special! Game Paddles \$19.95

WORD PROCESSORS

IUS - Pro Easywriter \$149.95
IUS - Pro Easywriter \$119.95
Apple Pie (WIP 40 Col.) \$104.95
LJK Letter Perfect \$129.95
Supertext II \$129.95
Screenwriter (70 Col.) \$104.95
Executive Secretary \$199.95
Magic Window \$84.95
Format II w/Mail List \$279.95
Select for Apple \$389.95
Word Handler \$149.95

PRACTICAL PERIPHERALS

Don't tie up your computer while your printer is printing!
Micro Buffer II 16K \$214.95
Micro Buffer II 32K \$249.95

FOR EPSON ONLY

Micro Buffer Parallel 16K \$135.95
Micro Buffer Serial 8K \$135.95

SOFTWARE FOR APPLE

Fortran 80 \$154.95
A.L.D.S. \$99.95
Basic Compiler \$295.95
Tasc Compiler \$149.95
Cobol - 80 \$595.95
Context Connector \$145.00

USA
Apple World \$49.95
3D Super Graphics \$33.00

SOFTWARE (cont'd)

SENSIBLE
The Sensible Speller \$99.00
MICRO PRO
Wordstar 3.0 \$249.95
Spell Star \$169.95
Mail Merge \$94.95
Super Sort-1 \$139.00

MICROLAB

Data Factory 5.0 \$229.95
Invoice Factory \$159.95
Tax Manager \$119.95

HOWARD SOFTWARE

Tax Preparer New 1982 \$119.95
NEW! Real Estate Analyzer \$249.95
2nd Addition \$149.95

PERSONAL SOFTWARE

Visicalc 3.3 \$189.95
Visiplot \$159.95
Visidex \$189.95
Visitrend/Visiplot \$239.95
Visiterm \$79.95
Visifile \$189.95
Desktop Plan II \$199.95
Desktop Plan III \$253.00

THE SOURCE

Telecommunication \$89.95

AARDVARK

Personal Tax Plan \$104.95
Individual Tax Plan \$239.95

SOFTWARE DIMENSIONS

Accounting Plus II CALL

ASHTON TATE

DBase II \$524.95

HIGH TECHNOLOGY

Info. Master \$119.00
Store Manager \$199.95
Data Master \$79.95
Job Control System \$595.95
Client Billing System \$279.95

SOUTHEASTERN SOFTWARE

Data Capture 4.0 40 Col. \$49.95
Data Capture 4.0 80 Videx \$69.95

SOFTWARE PUBLISHING

PFS New! \$97.95
PFS Report \$77.95

PHOENIX SOFTWARE

Zoom Graphics \$345.95
Master Diagnostic
(Formerly Brain Surgeon) \$45.00
STONEWARE
DB Master Vers. 3 \$179.95
Utility Pack I \$79.95
Brodebund Payroll \$299.95

GAME AND HOBBY

Temple of Asphai \$31.95
Hellfire Warrior \$32.95
Rescue at Rigel \$22.95
Crush, Crumple & Chomp \$25.00
Jabber Talky \$24.95
Major League Baseball \$26.95
Apple Panic \$24.95
Snack Attack \$24.95
Joy Breaker \$24.95
Space Quarks \$24.95
Genetic Drift \$24.95
Red Alert \$24.95
Ultima \$32.95
Star Thief \$24.95
Bug Attack \$24.95
Sargon II \$27.95
Pool 1.5 \$30.00
Shuffle Board \$24.95
Trick Shot \$32.95
Dog Fight \$24.95
Olympic Decathlon \$24.95
Three Mile Island \$32.95
ABM \$19.95
Robot War \$32.95
Castle Wolfenstein \$24.95
Zork \$32.95
Zork II \$32.95
Falcons \$24.95
Beer Run \$30.00
Raster Blaster \$24.95
Space Eggs \$24.95
Gorgon \$32.95
Cops and Robbers \$30.00
Tigers in the Snow \$32.95
The Battle of Shiloh \$32.95
The Shattered Alliance \$48.95
Computer Baseball \$32.95
Computer Quarterback \$32.95
Sneakers \$24.95
TC Joystick \$48.95
TG Game Paddles \$34.95
Krell LOGO for Apple \$149.95

FRANKLIN

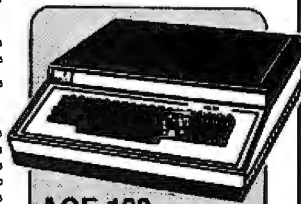

ACE 100 Personal Computer

A professional personal computer that is hardware and software compatible with the Apple II® and includes many features not found on the Apple®. All peripherals and programs written for the Apple II® can be used with the Franklin ACE 100 without modification including high and low resolution black and white graphics. The ACE 100 is also plug compatible with Apple®.

FEATURES: Apple® compatible, 64K of RAM memory, upper & lower case, typewriter-style keyboard, 12-key numeric pad, alpha lock shift key, Visicalc friendly, 50-watt power supply, built-in fan.

Call for Low Price!

Apple is a registered trademark of Apple Computer Inc.

μ-SCI APPLE COMPATIBLE DISC DRIVES
MICRO-SCI
A-35 Disk Drive with-out Controller... **369.00**
A-35 Disk Drive with Controller... **469.00**

*** SHARP MINI COMPUTERS ***
PC-1500 LCD POCKET COMPUTER
Extended BASIC system capable of 2 dimens. arrays. Full graphic commands.
Now Only **\$214.95**
CE-150 Color Graphics Printer with Cassette interface.
Now Only **\$174.95**
4K and 8K Memory Expansion **IN STOCK!**

PC-1211 POCKET COMPUTER
Formidable computing power. Prog. w/BASIC language. 24 digit LCD.
Now Only **\$119.95**
CE-122 16-DIGIT MINI DOT PRINTER
Print out programs
Now Only **\$99.50**
FREE! Cassette Interface (\$50 Value) with purchase of PC-1211. Ltd. Qty.

PRINTERS
*** EPSON ***
MX-80 III F/T 80-136 Column Dot Matrix, Tractor or Friction Feed, Bidirectional, 80 CPS, Graftrax Plus... **549.95**
MX-80 80-136 Column... **439.95**
MX-100III FT 136-233 Column, with Graftrax plus... **719.95**

commodore
VIC 20 COMPUTER w/RF Modulator
On Sale for Only **\$239.95**
8K Memory Expansion... 53.95
Phone Modem f/VIC by Bizcom... 139.95
DATACORDER (f/Cass. Prog.)... 69.95
Jupiter Landers (cart.)... 24.95
Super Alien (cart.)... 24.95
Midnight Driver (cart.)... 24.95
Household Finance (cass.)... 29.95
Car Cost (cass.)... 13.95
Loan Analyzer (cass.)... 13.95
Amok (cass.)... 20.95
Alien Blitz (cass.)... 20.95
VT 106A 6 Pk. Recreational Prog... 49.95
Super Expander... 57.95
Snackman... 14.95
Vixel I... 11.50
Vixel II... 11.50
QUANTUM DATA
RS 232 Interface... 47.95
24K Memory... 179.95
Mini Mother Expansion Interface... 64.50

Texas Instruments
TI 99/4A COMPUTER
FREE! RF Modulator w/purchase (\$30 Value) Only **\$329.95**
2 FREE offers direct from TI!
Call or Write for Details!
Full line of hardware, software and accessories in stock!
ATARI
ATARI 800 w/16K... \$649.95
ATARI 400... \$274.50
810 Disc Drive... \$459.95
850 Interface... \$179.95
410 Programmable Recorder... \$79.95
Axlon 32K Ram... \$129.95
POPULAR ATARI GAMES IN STOCK!
We carry the full line of TI and HP Programmable Calculators.

hp HEWLETT PACKARD
HP-87A
Rapid Programming Power!
Has 32K bytes of user memory, expandable to 544K. Versatile alphanumeric keyboard. High resolution CRT. Built-in HP-IB interface, printer and mass storage firmware. Built-in BASIC and operating system.
New Low Price **\$1884.00**
32K, 64K and 128K Memory Expansion Modules In Stock!
Special! HP-83 (Ltd. Qty.)... \$1295.00
HP-85A... Now Only \$1982.00
HP-125 Reg. \$2750... Only \$1982.00
HP 82091M 5 1/4" Disc Drive... \$1650.00
HP 82905 Serial Printer... \$595.00
HP 7470A New Plotter... \$1269.00

GRAPPLER Graphic Inter/Cable... **139.95**
OKIDATA 80 80 CPS, Parallel, Friction and Pin Feed... **325.00**
OKIDATA 82A 120 CPS, Bidirectional, Friction and Pin Feed, Serial and Parallel, 80/132 Columns... **449.95**
OKIDATA 83A 120 CPS, Bidirectional, Friction & Tractor, 136 Col. Serial & Parallel, Takes 15" Paper... **719.95**
Tractor Feed, (optional)... **54.95**
CENTRONICS 739-I Graphics, 100 CPS Monospaced Mode, Right Justification, Friction and Tractor... **474.95**
XEROX Diablo 630 with word processing enhancement & 2K buffer... **2199.95**
Bi-directional Tractor (optional)... **204.95**
NEW! C.I.TOH F10-40 Parallel, Daisy Wheel, Letter Quality Printer... **1499.95**
F10 Serial... **Now Only 1549.95**
C.I.TOH 8510 Pro Writer, 120 CPS, 136 Columns, Parallel, Bidirectional, F/T, High Resolution Graphics... **499.95**
MONITORS
SANYO VM-4509 9" B&W... 159.95
Pi-3 12" Amber... 189.95
SANYO DMC-6013 13" Color... 389.95
NEC JB1201 12" Green... 179.95
NEC JC1201 12" Color... 349.95

47st photo CORPORA TE ACCOUNTS WELCOME (212) 260-4410
TOLL FREE OUT-OF-STATE
800-221-7774
800-221-5858
800-223-5661
Cameras - Electronics - Audio - Video - Computers - Darkroom - Accessories
67 West 47th Street, New York, N.Y. 10036
115 West 45th Street, New York, N.Y. 10036
MAIL ORDER ADDRESS: 36 E. 19th St. New York, N.Y. 10003
Items on sale for limited time only, and are subject to limited availability. Not responsible for typographical errors. This ad supersedes all other ads prior to August '82. Prices effective as of July 28, 1982, and are subject to change without notice. All orders subject to verification and acceptance. Minimum shipping and handling \$4.95

Software Received

Logo

Apple Logo, documentation includes *Apple Logo: An Introduction to Programming Through Turtle Graphics* and *Apple Logo: Reference Manual*; For the Apple II; floppy disk, \$175. Logo Computer Systems Inc., 222 Brunswick Blvd., Pointe Claire, Quebec H9R 1A6, Canada.

Krell Logo, documentation includes *Logo for the Apple II*, *Logo for the Apple II: Technical Manual*, *Alice in Logoland Primer*, *Logo Teacher's Manual*, and a one-year subscription to *The Logo and Educational Computing Journal*. For the Apple II; floppy disk,

\$149.95. Krell Software Corp., 1320 Stony Brook Rd., Stony Brook, NY 11790.

Terrapin Logo, documentation includes *Terrapin Logo Tutorial* and *Logo for the Apple II: Technical Manual*. For the Apple II; floppy disk, \$149.95. Terrapin Inc.,

678 Massachusetts Ave., Cambridge, MA 02139.

TI Logo, documentation includes *TI Logo*. For the TI-99/4 and TI-99/4A; command module (ROM cartridge) and cassette or floppy disk, \$129.95. Texas Instruments Customer Relations, POB 53, Lubbock, TX 79408.

Apple

Adventure to Atlantis, an adventure-type game in which you become a nobleman struggling to prevent the enslavement of mankind by the Atlanteans. Includes graphics, sound, and personality definition for your player. For the Apple II; floppy disk, \$40. Synergistic Software, 5221 120th Ave. SE, Bellevue, WA 98006.

Bandits, an arcade-type game in which you must protect a lunar supply base from thieves. You are armed with a laser cannon and shields, but the alien thieves have even more imaginative weapons. For the Apple II; floppy disk, \$34.95. Sirius Software Inc., 10364 Rockingham Dr., Sacramento, CA 95827.

Cannonball Blitz, an arcade-type game where you must climb Nutcracker Hill and destroy a castle while dodging cannonballs. For the Apple II; floppy disk, \$34.95. On-line Systems, 36575 Mudge Ranch Rd., Coarsegold, CA 93614.

Cricketeer, an arcade-type game. You must get your cricket across the highway and the river into his home. For the Apple II; floppy disk, \$29.95. The Software Farm, 3901 South Elkhart St., Aurora, CO 80014.

Crossfire, an arcade-type game. Aliens have invaded the city and you must patrol

the streets trying to destroy them while eluding laser fire. For the Apple II; floppy disk, \$29.95. On-line Systems (see address above).

Cyclod, an arcade-type game. You control an eyeball that must build walls to smash or trap snakes. For the Apple II; floppy disk, \$29.95. Sirius Software (see address above).

Dietician, a program to help you plan your daily diet, includes food values for more than 700 foods. For the Apple II; floppy disk, \$59.95. Dietware, POB 503, Spring, TX 77373.

Disc Utility, this utility allows you to recover lost files, patch to any sector, display ASCII and hexadecimal characters on screen, and reorganize your disk. For the Apple II; floppy disk, \$50. Answer Corp., 502A North Second Ave., Sandpoint, ID 83864.

Dueling Digits, an arcade-type game. You must shoot and capture numbers and mathematical operands and arrange them in a logical order. For the Apple II; floppy disk, \$29.95. Broderbund Software, Entertainment Software Division, 1938 Fourth St., San Rafael, CA 94901.

Financial Records Manager, a personal financial-management package. For the Apple II; floppy disk, \$44.95. Cyber-tech, Suite 404, 1500 West Shaw, Fresno, CA 93711.

Karel the Robot, an introductory Pascal programming course. You control a computerized robot by programming its actions with structured programs. For the Apple II; floppy disk, \$85. Cybertronics International Inc., Software Publishing Division, 999 Mount Tremble Ave., Morristown, NJ 07960.

Labyrinth, an arcade-type game in which you must free the men trapped in an abandoned diamond mine from the clutches of various monsters. For the Apple II; floppy disk, \$29.95. Broderbund Software (see address above).

The Last One, a program generator that develops complete BASIC programs from a user-designed flow chart. For the Apple II; floppy disk, \$600. D. J. 'AI' Systems Ltd., Suite 480, Two Century Plaza, 2049 Century Park E, Los Angeles, CA 90067.

Lemmings, an arcade-type game. Before you go insane, you must prevent lemmings from overbreeding and going on a suicide run to the ocean. For the Apple II; floppy disk, \$29.95. Sirius Software Inc. (see address above).

Letter Editor, a simplified word-processing program. For the Apple II; cassette, \$20. Jalyn Software, 933 Mount Hood Dr., Pittsburgh, PA 15239.

Multiploy, designed for children from 4 to 14, this

program presents basic mathematics problems in a game-type setting. For the Apple II Plus; floppy disk, \$19.95. Reston Publishing Co., 11480 Sunset Hills Rd., Reston, VA 22090.

Property Management System, an income and expense tracking system for rental property. This system will handle single-family homes, condominiums, and multi-family housing. Operating statements for each building can be printed separately or combined in a consolidated operating statement. For the Apple II and III; floppy disk, \$375. Realty Software Co., 1116 F 8th St., Manhattan Beach, CA 90266.

Rear Guard, an arcade-type game. You must maneuver around and destroy enemy spaceships as they attempt to overtake your vessel. For the Apple II; floppy disk, \$29.95. Adventure International, POB 3435, Longwood, FL 32750.

Ricochet, an arcade-type game. This is an advanced version of pinball for one or two players. It has relocatable bumpers and demands strategy and thought. For the Apple II; floppy disk, \$19.95. Automated Simulations, POB 4247, Mountain View, CA 94040.

Short Term Trader, a stock-market analysis package. It gives buy-sell direc-

Powerful Lab Graphics

For Your Apple II+® Computer

SCIENTIFIC PLOTTER

VIDICHART™

CURVE FITTER

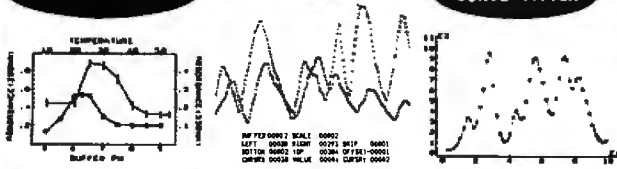

SCIENTIFIC PLOTTER 48K APPLE II+, \$25
 Draws professional-looking graphs of your data. EASIER, FASTER, NEATER and more ACCURATE than handplotting. You choose data format, length and position of axes, 20 symbols, error bars, labels anywhere in 4 orientations, etc. Includes 5 DEMOS on disk with 30-PAGE MANUAL.

CURVE FITTER 48K APPLE II+, \$35
 Selects the best curve to fit your data. SCALE, TRANSFORM, AVERAGE, SMOOTH, INTERPOLATE (3 types), LEAST SQUARES FIT (3 types), EVALUATE UNKNOWNNS from fitted curve. Includes 5 DEMOS on disk with 33-PAGE MANUAL.

VIDICHART™ 48K APPLE II+, \$75
 NEW tools for lab data management. FAST plots of 4 data sets with SCROLLING in 4 directions, ZOOM scaling on X and Y axes, 2 types of graphic CURSORS and on-screen STATUS REPORT. PLOTS A/D INPUT while sampling. ADD, SUBTRACT, MULTIPLY, DIVIDE, INTEGRATE, DIFFERENTIATE, AVERAGE or NORMALIZE data sets with SIMPLE COMMANDS. Ideal for spectra, chromatograms, rate curves, etc. Includes SAMPLE DATA on disk with 28-PAGE MANUAL.

SPECIAL! All 3 programs on one disk, only \$120. Since each program uses the same data format on disk, data may be shared.

BUY THESE PROGRAMS AT YOUR LOCAL DEALER OR ORDER DIRECT. For more information, ask for FREE brochure or send \$5 for any manual (\$12 for all 3), deductible with purchase. Add \$1.50 shipping on all orders. For fastest service, call in your VISA or Master Card order.



INTERACTIVE MICROWAVE, INC.
 P.O. Box 771, Dept. B State College, PA 16801
 CALL (814) 238-8294 for IMMEDIATE ACTION

• Trademark of Apple Computer, Inc.

AUTHORIZED SERVICE



Now you can get **FACTORY AUTHORIZED** service for your Commodore or Atari computer and peripherals at reasonable cost. Minimize your down time frustration and expense. Extended warranty available for most products, too!

Micro Computer Service Center

CALL 717-327-1450

477 E. Third St., Williamsport, PA 17701

DISCOUNT PRINTER RIBBONS

Brand New, Top Quality, Exact Replacement Ribbons & Cartridges. These Ribbons Produce Super Jet Black Impressions and Ultra Reliable Print Life. They Are Delivered to Your Door Promptly for Much Less Than Most Retail Stores

40% OFF!! OR MORE!

***SPECIAL! BUY 10 and GET ONE FREE!**

YOUR PRINTER	PACK SIZE	RETAIL LIST**	YOUR WHOLESALE PRICE	SIZE	COMMENTS	CAT. ORDER#
ANADIX 9000 Series	1 pk.	14.00 ea	14.00 (14.00 ea)	500'	Nylon Jet Blk	C-777
CENTRONICS 700-703, 737, 779	3/pk	18.95/3 pk	11.95/3 pk (3.98 ea)	563' x 45'	Nylon Jet Blk	C-700
CENTRONICS 100, 101A, 102, 103, 300, 301, 306, 308, 330, 358, 398, 500, 501, 503, 508, 588, 620, 820.	3/pk	26.33/3 pk	17.55/3 pk (5.85 ea)	1" x 108'	Nylon Jet Blk	C-100
CENTRONICS 704-705	1/pk	16.95 ea	13.95/Giant Cart (13.95 ea)	5 16" x 210'	Giant Cart	C-7045
DEC 1/2 x 40Y0.	3/pk	17.77/3 pk	12.95/3 pk (4.32 ea)	1.2" x 120'	Double Spools	R-600
DEC 1/2 x 60Y0.	3/pk	20.12/3 pk	14.25/3 pk (4.75 ea)	1.2" x 180'	Double Spools	R-644
DIABLO HYTYPE II (M/S BLK) HI YIELD. FITS 70 PRINTERS!	1/pk	9.31 ea	6.87 ea (6.87 ea)	5 16" x 300,000 plus imp		C-511
EPSON MX70 80	1 pk.	16.00 ea	16.00 ea (13.95 ea)	500' x 60'	Nylon Jet Blk	C-522
IBM "SILVER DOLLAR" Sys. 34, Sys. 32 MOLA, Series IMOL4974, 5256, 3287, 377U, 3771-3774, 4974, 5100, 5103, 5110, 5228, 5256, 5320MOLA	5/pk	5.80 ea	14.90/5 pk (2.98 ea)	9/16" x 30'	Nylon Jet Blk	R-300
IBM - HARMONICA 1/2" SERIES I, MDD 4973/11, 3200, 3288, MDD 2.	3/pk	9.42 ea	20.85/3 pk (6.95 ea)	1 2" x 108'	Nylon Jet Blk	C-350
NEC SPINWRITER	4/pk	23.40/3 cart	23.00/4 pk rb. reload (5.90 ea)	1 1/2" x 51'	Nylon/Ex Lng Life	R-400
QUIME (FITS 80 PRINTER MOODS)	3/pk	18.00/3 pk	13.95/3 pk (4.65 ea)	1 1/4" x 310'	Multistrike Film	C-525
RADIO SHACK OASIS WHEEL II	1 pk	24.95/3pk	8.25 (8.25 ea)	250'	Mylar Multistrike	C-789
RADIO SHACK LP11, LPV	one, pk	13.95/cart	8.95/Reload rib only (8.95 ea)	500" x 45'	Nylon Incl Instr	R-73
RADIO SHACK LP11, LP1V	3/pk	18.95/3 pk	11.95/3 pk (3.98 ea)	563' x 45'	Nylon Jet Blk	C-700
TELETYPE MDD 33, 28, 35, 37, 38, 88.	10/pk	2.40 ea	13.90/10 pk (1.39 ea)	1 1/2" x 36'	Nylon Jet Blk	R-450
WANG M/S, 5541W, WC, 5581, WD, 6581W, 2281W	1/pk	6.85 ea	5.95 ea (5.95 ea)	5 1/8" x 393'	Multistrike Film	C-550

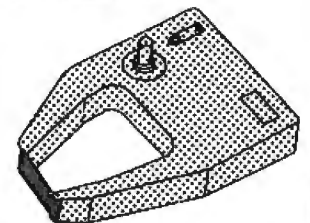

TERMS:

MINIMUM PURCHASE - \$20
 PAYMENT BY: C.O.D. (UPS), CHECK, MASTER CARD, OR VISA CHARGE CARD.

VOLUME DISCOUNTS:

20 - 50 PACKS 10%
 51 - 100 PACKS 15%

*UNDER \$20, ADD \$5 HANDLING.

**APPROX. RETAIL. PRICE VARIES.

ANCIE LABORATORIES

5200-J Philadelphia Way 301-345-6000 (Wash. D.C. Local)
 Lanham, Maryland 20706 301-792-2060 (Balto. MD Local)

800-638-0987 (National)

NAME _____
 ADDRESS _____
 CITY _____ STATE _____ ZIP _____

QTY _____ CAT.# _____ AMT. _____

 TOTAL _____

Check Enclosed
 C.O.D.
 VISA
 MASTER CHARGE
 ACCT. # _____
 EXP. DATE _____
 MIN. ORDER \$20
 PRICES SUBJECT TO CHANGE

Software Received

tions on any stock you choose to follow, contains a call value section for puts and calls, and a commission costs estimating feature. For the Apple II and II Plus; floppy disk, \$54. KCR Inc., Micro Statistics Division, POB 727, Sherman, TX 75090.

Sunpas, Sunop, and Tswing, a passive solar-heating analysis package designed for architects and engineers. These programs estimate yearly heating requirements of a passive solar building and perform nodal analysis thermal simulations. For the Apple II Plus; floppy disk, \$700. Solarsoft Inc., POB 124, Snowmass, CO 81654.

Super Stellar Trek, a Star Trek-type game. This is an improved successor to the original Stellar Trek game. For the Apple II; floppy disk, \$34.95. Rainbow Computing Inc., 9719 Reseda Blvd., Northridge, CA 91324.

Threshold, an arcade-type game. You must destroy a large number of alien targets that appear in successive waves with increasing speed. For the Apple II; floppy disk, \$39.95. On-Line Systems (see address above).

Time Zone, an adventure-type game on six floppy disks. As you travel through time, you attempt to save humanity from alien domination. Estimated playing time: one year. For the Apple II; floppy disk, \$99.95. On-Line Systems (see address above).

VC-Loader, a utility program to convert text or print files into DIF files for use with Visicalc, Visiplot, and Visi-trend. For the Apple II Plus; floppy disk, \$65. Micro Decision Systems, POB 1392, Pittsburgh, PA 15219.

Visicaids, Visicalc formatting aids for use with Visicalc files. It allows for variable width columns, long labels, splitting labels, formula printout, and print file reading. For the Apple II Plus; floppy disk, \$44.95. Data

Security Concepts, POB 31044, Des Peres, MO 63131.

Word Handler, a word-processing program that gives you a 66-column display without hardware modifications. It includes all standard word-processing functions such as lowercase, underlining, superscript, and unlimited tabs. All functions are displayed on the screen. For the Apple II; floppy disk, \$199. Silicon Valley Systems Inc., 1625 El Camino Real #4, Belmont, CA 94002.

Zero Gravity Pinball, an arcade-type game. This game simulates pinball as it might be played in zero gravity. For the Apple II; floppy disk, \$29.95. Avant-Garde Creations, POB 30160, Eugene, OR 97403.

Atari

Rear Guard, an arcade-type game (see description above). For the Atari 400 and 800; floppy disk, \$29.95. Adventure International, POB 3435, Longwood, FL 32750.

Ricochet, an arcade-type game (see description above). For the Atari 400 and 800; floppy disk or cassette, \$19.95. Automated Simulations, POB 4247, Mountain View, CA 94040.

CP/M

Accounts Payable, an accounts payable package. For CP/M with RM/COBOL; floppy disk, \$1000. Micro Business Software Inc., Dover Rd., Willow Hill Building, Chichester, NH 03263.

Accounts Receivable, an accounts receivable package. For CP/M with RM/COBOL; floppy disk, \$1000. Micro Business Software Inc. (see address above).

General Ledger, a general ledger package. For CP/M with RM/COBOL; floppy disk, \$1000. Micro Business Software Inc. (see address above).

Order Entry/Billing, this package provides complete order-entry and billing functions including printing credit memos and invoices, receiving transaction entry, editing and posting with edit list and journal, order-entry, and interactive inventory control. Interfaces with other Micro Business Software accounting packages. For CP/M with RM/COBOL; floppy disk, \$1000. Micro Business Software Inc. (see address above).

Perfect Writer, a word-processing program featuring virtual memory architecture that allows editing of documents larger than memory. Includes multiple file display and user-definable commands. For CP/M; 8-inch floppy disk, \$389. Perfect Software Inc., 71 Murray St., New York, NY 10007.

Payroll, a full payroll system for a small business. Handles both hourly and salaried employees, prints checks and check register, payroll and deductions register, and performs all payroll calculations. Interfaces with the Micro Business Software General Ledger package, or it can run as a stand-alone system. For CP/M with RM/COBOL; floppy disk, \$1000. Micro Business Software Inc. (see address above).

Sales Analysis, this program tabulates and prints sales analysis reports according to customer types and volumes, item type, category, and volume. Also analyzes sales force performance. For CP/M with RM/COBOL; floppy disk, \$500. Micro Business Software Inc. (see address above).

UVMAC Z80—Absolute Macro Assembler, this utility uses source files similar to CP/M assembly language. It supports file inclusion, conditional assembly, and listing control, and it produces

.COM files. Includes a non-macro version. For CP/M (Z80); floppy disk, \$29.95. The Software Toolworks, 14478 Glorietta Dr., Sherman Oaks, CA 91423.

Exidy Sorcerer

Duel: A Dogfight in Space, an arcade-type game for two players. Written in machine-language, this high-resolution graphics game features two ships that accelerate, rotate, and fire weapons. For the Exidy Sorcerer; cassette, \$20. Dayspring Computer Enterprises, POB 1910, Eugene, OR 97440.

Heath

Recipe-Master Version 1.01, a program to index and select recipes from a master file. It lets you display or print a recipe, create a sorted index, search for a specific recipe, and scan titles for specific keywords. For the Heath H-8 and H-89; floppy disk, \$19.95. Interactive Micro Systems, POB 21007, Columbus, OH 43221.

IBM Personal Computer

Diskette Library Management System, a disk-library cataloging system that creates a file of the programs on each of your disks. Files can be updated and edited at any time. For the IBM Personal Computer; floppy disk, \$100. Software Architects Inc., 27B Griffith Lane, Ridgefield, CT 06877.

Floppy-Disk Librarian, a disk-library cataloging system. This interactive set of programs maintains files and shows the location of each program on any particular disk. Requires PC DOS. For the IBM Personal Computer; floppy disk, \$39.95. Little Bit, 469 Edgewood Ave., New Haven, CT 06511.

The Programmer, a program generator. Designed to run under BASICA, the Programmer allows you to create a program by selecting func-

Software Received

tions from a series of menus. Once the function of the program has been defined, the Programmer writes the BASIC code. For the IBM Personal Computer; floppy disk, \$495. Advanced Operating Systems, 450 St. John Rd., Michigan City, IN 46360.

Visicalc, electronic spread sheet. This latest version displays 63 columns by 254 rows and allows viewing the display through two windows. For the IBM Personal Computer; floppy disk, \$250. Visicorp, 2895 Zanker Ave., San Jose, CA 95134.

TRS-80

Aircraft Instrument Approach Simulator, a program to train pilots for instrument landings. It features six types of approaches to an airfield and uses a full instrument panel display. For the TRS-80

Models I and III; cassette, \$9.95. J. C. Sprott, 5002 Sheboygan #207, Madison, WI 53705.

Astroids, two arcade-type games. In the first game, you pilot a spaceship through an asteroid field. In the second game, you shoot the asteroids. For the TRS-80 Color Computer; cassette, \$6.65. MFJ Electro Enterprises, POB 13076, Kanata, Ontario K2K 1X3, Canada.

Cubie Movie, a Rubik's Cube puzzle-solving program. For the TRS-80 Models I and III; cassette, \$20. Five Stones Software, POB 1369, Station B, Ottawa, Ontario K1P 5R4, Canada.

Penetrator, an arcade-type game. Your mission is to carefully weave your way into an enemy base and destroy a neutron bomb cache. The enemies' defenses are composed of four increas-

ingly difficult rings, with missiles, radar bases, and paratroopers abounding. This program features graphics, sound, and a customizing option. For the TRS-80 Models I and III; floppy disk or cassette, \$24.95. Melbourne House, c/o Braverman, Cordon Co., 233 South Beverly Dr., Beverly Hills, CA 90212.

Property Management System, an income and expense tracking system for rental property (see description above). For the TRS-80 Models I and III; floppy disk, \$375. Realty Software Co., 1116 F 8th St., Manhattan Beach, CA 90266.

Ricochet, an arcade-type game (see description above). For the TRS-80 Models I and III; disk or cassette, \$19.95. Automated Simulations, POB 4247, Mountain View, CA 94040.

W9AV Morse Code Trainer, a Morse code training program. For the TRS-80 Models

I and III; cassette, \$9.95. J. C. Sprott (see address above).

VIC-20

Astroids, an arcade-type game (see description above). For the Commodore VIC-20; cassette, \$6.65. MFJ Electro Enterprises, POB 13076, Kanata, Ontario, K2K 1X3, Canada.

Type-Test, a program to help you increase your typing speed. It includes a five-line speed test, where typing errors are subtracted and your speed is displayed. For the Commodore VIC-20; cassette, \$9.85. MFJ Electro Enterprises (see address above).

ZX80/81

ZX81 Classics, Lunar Lander, K-Trek, Life, and Mastermind, games. For the ZX-81 and ZX-80 (8K ROM); cassette, \$9.95. Lamo-Lem Laboratories, POB 2382, La Tolla CA 92038 ■

Mightier than Both



THE BENCHMARK® Word Processor

- NOW AVAILABLE ON IBM-PC.
- WORD PROCESSING TO MEET THE MOST EXACTING DEMANDS.
- MEETS HIGH VOLUME DEMANDS.
- EASY TO USE FOR THE BEGINNING USER, YET THE MOST FUNCTIONAL WORD PROCESSOR.
- ALSO AVAILABLE ON MOST MAJOR MICROS.

Take a closer look at this outstanding word processor and you will see why VICTOR, NECIS, ECS and HARRIS have all chosen the mightiest of them all... The BENCHMARK Word Processor.

For more information on this package that fits most all major micros including the IBM-PC and the new 8088/88 computers, please call or write to:

Metasoft Corporation,
711 East Cottonwood,
Suite E, Casa Grande,
Arizona 85222. Telephone (602) 836-6160.



The BENCHMARK is a registered trademark.

FEATURES: • Horizontal Scroll • Math Footnotes • Sophisticated Boilerplate Assembly with Auto Variable Filling • Phrase library permanently stored on disk • Column Manipulation • Hyphenation • Graphics

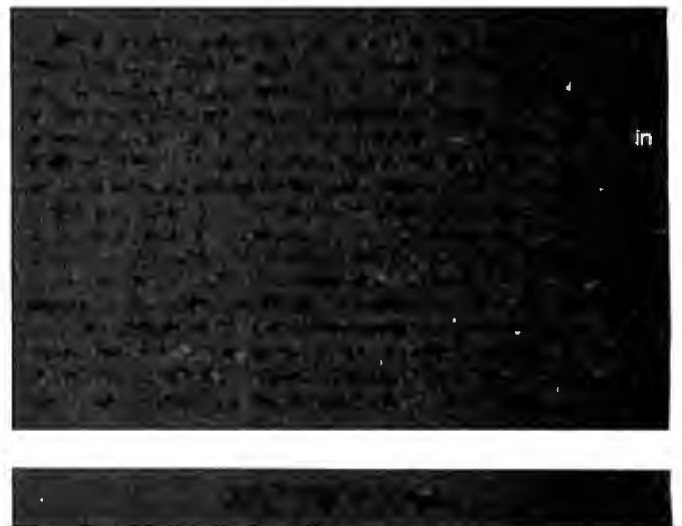

LC ; Update ;

Logic Systems has made a number of changes to the LDOS operating system since it was reviewed in BYTE. (See "LDOS-Disk Operating System for IBM-PC," page 372.) One change is that the price has been lowered to \$129. Another change involves the cost of the Extended Support Package (available for \$25 per year). For a subscription to a quarterly newsletter, access to the online bulletin board on Micronet, and updates for only \$10, you must elect to purchase the Extended Support Package for \$10. Contact Logical Systems Inc., 11520 North 1st Rd., Mequon, WI 53092, (414) 241-3066. ■

Dealers and OEM Inquiries Circle 488. All other Inquiries Circle 489

DEC DISK CARTRIDGES Overnight!

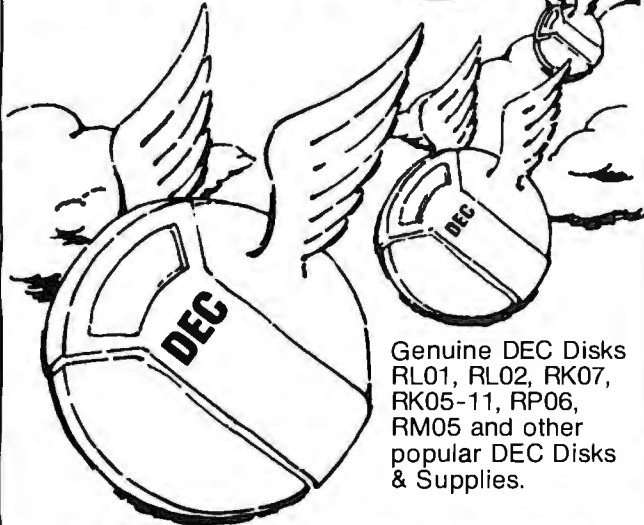

Genuine DEC Disks
RL01, RL02, RK07,
RK05-11, RP06,
RM05 and other
popular DEC Disks
& Supplies.

RADGO SALES CO.

3988 McMann Rd., Cincinnati, Ohio 45245

TOLL FREE Ordering 1-800-543-1986
except in Ohio phone 1-513-752-6880

Ask for free catalog

\$495.

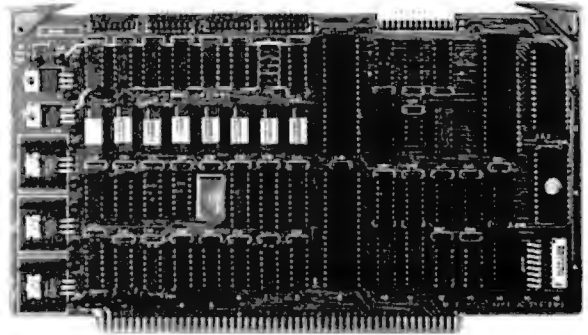

SBC can be redundant!!

- Z80A 4MHz, 64K RAM, 2K ROM
- 2 serial, 2 parallel, 4 timer ports
- Bi-directional inter-processor channel
- Multi-processor architecture capability
- Redundant processor manipulation capability
- Matching double-density disc controller with SASI and PRIAM interface
- Application note for system configurations

JC SYSTEMS (415) 657-4215
1075 Hiawatha Ct. Fremont, CA 94538

PRODUCTS FOR YOUR RADIO SHACK

NEW!

COLOR COMPUTER

MACRO-80C

The Micro Works is pleased to announce the release of its **disk-based editor, macro assembler and monitor**, written for Color Computer by Andy Phelps. THIS IS IT — The ultimate programming tool!

The powerful 2-pass macro assembler features conditional assembly, local labels, include files and cross referenced symbol tables. MACRO-80C supports the complete Motorola 6809 instruction set in standard source format. There are no changes, constraints or shortcuts in the source language definition. Incorporating all of the features of our Rompack-based assembler (**SBS80C**), MACRO-80C contains many more useful instructions and pseudo-ops which aid the programmer and add power and flexibility.

The screen-oriented text editor is designed for efficient and **easy** editing of assembly language programs. The "Help Key" feature makes it **simple** and fun to learn to use the editor. As the editor requires no line numbers, you can use the arrow keys to position the cursor anywhere in the file. MACRO-80C allows global changes and moving/copying blocks of text. You can edit lines of assembly source which are longer than 32 characters.

DCBUG is a machine language monitor which allows examining and altering of memory, setting break points, etc.

The editor, assembler and monitor — as well as sample programs — come on one Radio Shack compatible disk. Extensive documentation included. **MACRO-80C Price: \$99.95**

SBS80C — Our famous editor, assembler and monitor in Rompack. Complete manual included. **Price: \$89.95**

PARALLEL PRINTER INTERFACE — Serial to parallel converter allows use of all standard parallel printers. You supply printer cable. **PI80C Price: \$69.95**

MICROTEXT — Get printouts while using your modem! Also download to cassette. General purpose terminal Rompack. **Price: \$59.95**

THE MICRO WORKS

Also available: Machine language Monitor ★ 2-pass Disassembler ★ Books ★ Memory Upgrade Kits ★ Parts and Services ★ Call or write for information

P.O. BOX 1110 DEL MAR, CA 92014

California Residents add 6% Tax
Master Charge/Visa and COD Accepted

714-942-2400

YOU NEED COLOR FORTH!!

Why?

- Forth is faster to program in than Basic
- Forth is easier to learn than Assembly Language
- Forth executes in less time than Basic

Forth is a highly interactive language like Basic, with structure like Pascal and execution speed close to that of Assembly Language. The Micro Works Color Forth is a Rompack containing everything you need to run Forth on your Color Computer.

Color Forth consists of the standard FORTH Interest Group (FIG) implementation of the language plus most of FORTH-79. It has a super screen editor with split screen display. Mass storage is on cassette. Color Forth also contains a decompiler and other aids for learning the inner workings of this fascinating language. It will run on 4K, 16K, and 32K computers. Color Forth contains 10K of ROM, leaving your RAM for your programs! There are simple words to effectively use the Hi-Res Color Computer graphics, joysticks, and sound. The 112-page manual includes a glossary of the system-specific words, a full standard FIG glossary and complete source listing. **COLOR FORTH ... THE BEST!** From the leader in Forth, Tabot Microsystems. **Price: \$109.95**

GAMES

Star Blaster — Blast your way through an asteroid field in this action-packed Hi-Res graphics game. Available in ROMPACK; requires 16K. **Price: \$39.95**

Pac Attack — Try your hand at this challenging game by Computerware, with fantastic graphics, sound and action! Cassette requires 16K. **Price: \$24.95**

Berserk — Have fun zapping robots with this Hi-Res game by Mark Data Products. Cassette requires 16K. **Price: \$24.95**

Adventure — *Black Sanctum* and *Calixto Is'land* by Mark Data Products. Each cassette requires 16K. **Price: \$19.95 each.**

Cave Hunter — Experience vivid colors, bizarre sounds and eerie creatures in hot pursuit as you wind your way through a cave maze in search of gold treasures. This exciting Hi-Res game by Mark Data Products requires 16K for cassette version. **Price: \$24.95**

Clubs and Newsletters

OSI Group Meets in Miami

MSIG: OSI (Miami Special Interest Group: Ohio Scientific Inc.) meets monthly to exchange information on Ohio Scientific systems. The meetings are held on the first Thursday of each month at 656 Northeast 164 St., North Miami Beach, Florida. A software library is being set up. Membership fees are \$8 per year. Contact the Miami Special Interest Group: OSI, 656 Northeast 164 St., North Miami Beach, FL 33162.

Newsletter Exchange Wanted

Northern Bytes, the monthly publication of Microcomputer Users International in Sault Sainte Marie, Michigan, contains club news and information as well as programs for many popular computers. The club is seeking to exchange newsletters with other microcomputer clubs and users groups anywhere in the world. If your club or group is interested, send a copy of your publication to Microcomputer Users International, c/o Jack Decker, Lot #155, 1804 West 18th St., Sault Sainte Marie, MI 49783.

Pocket Computer Group Formed

A club for TRS-80 Pocket Computer and Sharp PC-1211 users has been formed. For a \$10 annual fee you will receive two free games, Draw Poker and Tic-Tac-Toe, and a year's subscription to the *Pocket Programming* newsletter. For details, write to John Riggs, 1114 Elaine, Livermore, CA 94550.

National Personal Computer Organization

Autumn Revolution '81 is a national organization of IBM Personal Computer owners, users, and interested parties. A \$30 annual membership fee provides you with access to a toll-free technical hot line staffed with specialists who can answer most of your software and hardware questions, a newsletter, and software and technical libraries. Local chapters of Autumn Revolution '81 are being formed throughout the country. In the Chicago area, the local chapter, Neobyte, can be reached by contacting James L. Szafranski, 5195 Castaway Lane, Barrington, IL 60010, (312) 934-8133. In Utah, contact Nancy Williamson, Com-

puterland Store, 161 East 200 South, Salt Lake City, UT 84111.

Complete details are available from Autumn Revolution '81, 10981 East 23rd St., Tulsa, OK 74129, (918) 438-4582.

Professional Newsletter

Computers in Psychiatry/Psychology is a clinical-resource newsletter for professionals interested in the use of computers in psychiatry and psychology. Each issue has descriptions of the computer-related activities of subscribers in such diverse fields as neuropsychiatric and MMPI (Minnesota multiphasic personality inventory) testing, problem assessment, biofeedback, computer psychopharmacology consultation, and electroencephalogram (EEG) analysis. Other features include summaries, reviews, original articles, and an ongoing bibliography and program catalog.

Individual subscriptions to *Computers in Psychiatry/Psychology* cost \$25; institutional and foreign subscriptions are \$35. Contact *Computers in Psychiatry/Psychology*, 26 Trumbull St., New Haven, CT 06511.

LAUGH in Hong Kong

LAUGH (Local Apple User Group—Hong Kong) meets on the third Thursday of the month on the twentieth floor of the New May House in Hong Kong. A newsletter is produced. Apple users traveling in the area are welcome to stop by. Contact LAUGH's secretary, Paul Deal, C12 Pearl Gardens, 7 Conduit Rd., Hong Kong, 5-221962, or call the club's president, Dr. Mike Rogers, at Kowloon 320865.

Logo Newsletters Available

The following is a list of Logo newsletters: *The National Logo Exchange*, POB 5341, Charlottesville, VA 22905, Attn: Bill Mattson. Subscriptions cost \$25 per year (9 issues).

Turtle News, Young People's Logo Association, 1208 Hillsdale Dr., Richardson, TX 75081, Attn: Jim Muller. Subscriptions are free for children and \$15 per year for adults.

Logo and Educational Computing Journal, Krell Software Inc., 1320 Stony Brook Dr., Stony Brook, NY 11790. Subscriptions are available for \$30 a year. ■

BYTE Back Issues For Sale

The following issues are available:

\$2.00 ea.	\$2.75 ea.	\$2.75 ea.	\$3.25 ea.	\$3.25 ea.
July 76	June 78	Sept. 79	Sept. 80	Oct. 81
May 77	July 78	Oct. 79	Oct. 80	Nov. 81
June 77	Aug. 78	\$3.25 ea.	Nov. 80	Dec. 81
July 77	Sept. 78	Nov. 79	Dec. 80	\$3.70 ea.
Aug. 77	Oct. 78	Dec. 79	Jan. 81	Feb. 82
\$2.75 ea.	Dec. 78	Jan. 80	Feb. 81	Mar. 82
Sept. 77	Jan. 79	Feb. 80	Mar. 81	Apr. 82
Nov. 77	Feb. 79	Mar. 80	Apr. 81	May 82
Dec. 77	Apr. 79	Apr. 80	May 81	June 82
Feb. 78	May 79	May 80	June 81	July 82
Mar. 78	June 79	June 80	July 81	
Apr. 78	July 79	July 80	Aug. 81	
May 78	Aug. 79	Aug. 80	Sept. 81	

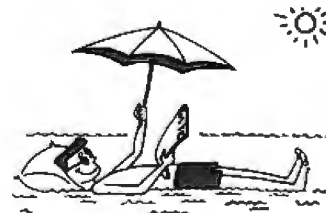

Prices include postage in the US. Please add \$.50 per copy for Canada and Mexico; and \$2.00 per copy to foreign countries (surface delivery).

Send requests with payment to:
BYTE Magazine
 70 Main St., Peterborough NH 03458
 Attn: Back Issues

* Payments from foreign countries must be made in US funds payable at a US bank.

* Please allow 4 weeks for domestic delivery and 8 weeks for foreign delivery.

SAVE

TRS-80's™
FULL LINE
and
Hewlett Packard
85, 87, 125

WE PAY SHIPPING in the 48 continental states on prepaid orders of \$100.00 or more.
NO TAXES are collected on out-of-state shipments.
WE ACCEPT Visa, MasterCard and American Express, or you can save additional money by paying cash.

TOLL FREE ORDER NUMBER 800/531-7466

Pan American Electronics

1117 Conway • Dept. B
Mission, Texas 78572
Phone 512/581-2766
Telex Number 767339

FORT WORTH BRANCH
2912 N. Main
Ft. Worth, Texas 76106
Phone 817/625-6333
Telex Number 794836

85, 87, 125

Hewlett-Packard

TM — Trademark of Tandy Corporation

NO. 1

FOR
COLOR COMPUTER PRODUCTS

GAMES
Arcade Graphics • Strategy Adventure • Invaders • Pac Attack • Storm • Magikarp • Cave Hunter • Bercock • Maze Race • Castle Island • Black Sanctum • Starship Chessman

HOME & WORK
Home Money Manager • Finance • Scribble Word Processor • Color Data Organizer • Address Factory • 3D Drawing Board

PROGRAMMING AIDS
PASCAL • Diagnostics • Error • Assembler • Monitor • Macro Assembler

CASSETTE & DISKETTE

HARDWARE
16K • Memory Expansion • Modems • Printers • Lower Case Adapter • 64K Memory • TV Adapter

ACCESSORIES • SUPPLIES • BOOKS

Dealer Inquiries Invited

Call or Write:

COMPUTERWARE®
6809 Specialists
Dept. C • Box 668
Encinitas, CA 92024 • (714) 436-3512

Computerware is a trademark of Computerware

SAVE \$\$ DISCOUNT PRICES SAVE \$\$

apple computer



APPLE COMPUTER SYSTEMS SOLD ONLY IN STORE. CALL FOR PRICES.

RAM MEMORY
FOR TRS-80, APPLE II
16K SET 4116's (200 NS) 24.95

General Information:
We carry a large selection of hardware and software by other companies. Send for our catalog.
We are an authorized repair center for **APPLE, ATARI, NORTH STAR, AND EPSON.**

ATARI



400 16K	349.00
800 16K	699.00
410 Recorder	89.00
810 Disk	449.00
822 Printer	359.00
825 Printer	779.00
830 Modem	159.00
850 Interface Module	179.00
CX853 RAM	89.00
CX70 Light Pen	64.00
CX30 Paddle	18.00
CX40 Joystick	18.00

VERBATIM DISKETTES

Box of 10 5 1/4"	29.50
Box of 10 8"	39.50

NorthStar™



ADV-2Q-64K	3150.00
ADV-1Q-64K-HD-5	5195.00



HRZ-2Q-64K	2795.00
HRZ-1Q-64K-HD-5	4695.00
HRZ-1Q-64K-HD-18	6295.00
5 MB HARD DISK	2350.00
18 MB HARD DISK	4195.00

PRINTERS

EPSON	
MX-70	299.00
MX-80	469.00
MX-80 F/T	569.00
GRAFTRAX	90.00
INTERFACE (APPLE)	75.00
CABLE (APPLE)	22.50
IDS	
560G	1450.00
PRISM	1795.00
NEC	
3510 35CPS	1995.00
7710 55CPS	2650.00
8023A	599.00
OKIDATA	
MICROLINE 80	389.00
MICROLINE 82A	549.00
MICROLINE 83A	849.00
MICROLINE 84	1245.00
C.I.T.O.H.	
STARWRITER 25CPS	1595.00
STARWRITER 45CPS	2195.00
FORMS TRACTOR	275.00

PRICES SUBJECT TO CHANGE WITHOUT NOTICE. MARYLAND RESIDENTS ADD 5% SALES TAX

FREDERICK COMPUTER PRODUCTS, INC. 5726 INDUSTRY LANE

TO ORDER CALL: (301) 694-8884

Store Hours:
MON. THRU THURS. 9:30 AM-9:00 PM
FRI. AND SAT. 9:30 AM-5:00 PM
FREDERICK, MD. 21701

Books Received

Algorithms for Graphics and Image Processing, Theo Pavlidis. Rockville, MD: Computer Science Press, 1982; 416 pages, 15.5 by 23.5 cm, hardcover, ISBN 0-914894-65-X, \$24.95.

BASIC Betting, The Micro-Computer Edge James Jasper. New York: St. Martin's Press, 1982; 283 pages, 15.2 by 23.3 cm, softcover, ISBN 0-312-06714-3, \$9.95.

BCPL-The Language and Its Compiler, Martin Richards and Colin Whitby-Stevens. New York: Cambridge University Press, 1981; 173 pages, 15 by 22.8 cm, softcover, ISBN 0-521-28681-6, \$10.95.

Bits 'n Bytes About Computing: A Computer Literacy Primer, Rachele S. Heller and C. Diane Martin. Rockville, MD: Computer Science

Press, 1982; 174 pages, 15.5 by 23.6 cm, hardcover, ISBN 0-914894-26-9, \$17.95.

Compu Guide, The Consumer's Guide to Small Business Computers, Martha Eischen. Beaverton, OR: Dilithium Press, 1982; 157 pages, 13.5 by 21.3 cm, softcover, ISBN 0-918398-69-X, \$14.95.

Discover FORTH, Thom Hogan. Berkeley, CA: Osborne/McGraw-Hill, 1982; 142 pages, 16.4 by 23.4 cm, softcover, ISBN 0-931988-79-9, \$15.

Elementary BASIC, Henry Ledgard and Andrew Singer. New York: Vintage Books, 1982; 264 pages, 15.5 by 23.5 cm, softcover, ISBN 0-394-70789-3, \$12.95.

Elementary Pascal, Henry Ledgard and Andrew Singer. New York: Vintage Books,

1982; 266 pages, 15.5 by 23.5 cm, softcover, ISBN 0-394-70800-8, \$12.95.

Introduction to Digital Board Testing, R.G. Bennetts. New York: Crane, Russak & Company, 1982; 352 pages, 15.5 by 23.2 cm, hardcover, ISBN 0-8449-1385-0, \$32.50.

Management Tools for Everyone, Steve M. Erickson. Princeton, NJ: Petrocelli Books, 1981; 170 pages, 16 by 24 cm, hardcover, ISBN 0-89433-131-0, \$17.50.

Microprocessor Circuits, Volume 1: Fundamentals and Microcontrollers, Edward M. Noll. Indianapolis, IN: Howard W. Sams & Co., 1982; 109 pages, 21.2 by 28 cm, softcover, ISBN 0-672-21877-1, \$9.95.

Numerical Analysis for Semiconductor Devices, Mamoru Kurata. Lexington, MA: Lexington Books, 1982; 269 pages, 16.4 by 23.3 cm, hardcover, ISBN 0-669-04043-6, \$28.95.

Pascal, A Considerate Approach, David Price. Englewood Cliffs, NJ: Prentice-

Hall, 1982; 194 pages, 17.5 by 23.5 cm, softcover, ISBN 0-13-652800-7, \$9.95.

Pascal, An Introduction to Methodical Programming, 2nd edition, W. Findlay and D.A. Watt. Rockville, MD: Computer Science Press, 1981; 404 pages, 15.2 by 22.8 cm, softcover, ISBN 0-914894-73-0, \$15.95.

A Practical Introduction to Computer Graphics, Ian O. Angell. New York: Halsted Press, 1981; 146 pages, 14.6 by 23.3 cm, softcover, ISBN 0-470-27251-1, \$16.95.

Trade Secrets: How to Protect Your Ideas and Assets, James Pooley. Berkeley, CA: Osborne/McGraw-Hill, 1982; 145 pages, 16.9 by 24 cm, hardcover, ISBN 0-931988-72-1, \$19.95.

Visical: Home and Office Companion, David M. Castlewitz and Lawrence J. Chisausky with Patricia Kronberg. Berkeley, CA: Osborne/McGraw-Hill; 182 pages, 21.2 by 27.6 cm, softcover, ISBN 0-931988-50-0, \$15.99. ■

POWER-LINE FILTERS

These filters protect any sensitive electronic equipment from power line transient damage and radio frequency interference. Both models offer surge suppression for power line "spikes". RF interference is suppressed using both inductive and capacitive components. Ideal for computers, test equipment, or TV.

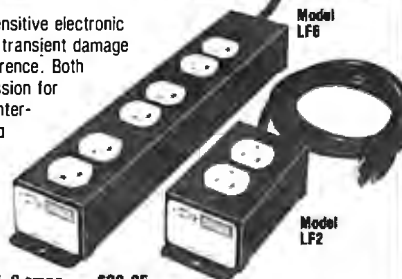

LF2—A duplex outlet, 120V, 8 amps ... **\$39.95**

LF6—three separately metered duplex outlets, 120V, total fused capacity 15 amps, power switch and indicator lamp ... **\$69.95**

Add \$2.50 shipping and handling per order. Send check with order and provide street address for UPS shipment. Ohio residents add Sales Tax. Charge card buyers may call toll-free:



1-800-543-5612

In Ohio, or for information, call: **1-513-866-2421**



R. L. DRAKE COMPANY

1 Richard Street, Miamisbur
INSTITUTIONAL AND DEALER INQUIRY

This is a list of books received at BYTE Publications during this past month. Although the list is not meant to be exhaustive, its purpose is to acquaint BYTE readers with recently published titles in computer science and related fields. We regret that we cannot review or comment on all the books we receive; instead, this list is meant to be a monthly acknowledgment of these books and the publishers who sent them.

BYTE's Bugs

Lines Taken Out of Context

A production error occurred in the listing associated with the System Note "Epson MX-80 Print-Control Program for the Apple II," by Bill Starbuck (March 1982 BYTE, page 166). The completion of line 160 of the

BASIC program (at the bottom of page 168) is actually the bottom four lines of page 169 (erroneously attached to line 440, which then correctly continues at the top of page 170). We regret the error. ■

MICROSTAT® - Release 3.0

MICROSTAT® + baZic® = PERFORMANCE

The best just got better! MICROSTAT has been the leader in the statistics field for microcomputers since 1979, and the new release 3.0 outperforms and is noticeably faster than previous versions. Just a few of the features include:

GREATER ACCURACY

BCD with up to 14 digit precision;

PROGRAM ENHANCEMENTS

Missing data capabilities and many more;

FASTER EXECUTION

Calculation time greatly reduced;

DYNAMIC FILE ALLOCATION

Data can be inserted, added, or deleted;

SPECIAL PRICE:

For a limited time get MICROSTAT plus baZic complete with program disk and documentation for each for \$395.00, save \$50.00!

The MICROSTAT - baZic version requires: a Z80 CPU, CP/M™ and 48K of memory. Available formats: 8" SD disk or 5¼" North Star only. Check with your dealer for other formats. Also available for: Microsoft's Basic-80™, North Star DOS and IBM. For more information, call or write:

ECOSOFT INC.

P.O. Box 68602
Indianapolis, IN 46268-0602
(317) 255-6476



MICROSTAT is a registered trademark of ECOSOFT, INC.
baZic is a registered trademark of MICROMIKES, INC.
CP/M is a registered trademark of DIGITAL RESEARCH
Basic-80 is a registered trademark of MICROSOFT

AUGUST SPECIALS

OUR
SPECIAL
CASH PRICE

S.D. Systems SBC-100 Kit	239.00
Morrow Designs 65K Static RAM A & T	393.00
Digiacc 64K Dynamic RAM A & T	279.00
Hayes Smart Modem "Stack" A & T	237.00
Godbout 6 Slot MB A & T	105.00
SSM PB-1 Prom Burner A & T	212.00
SSM IO-4 2P+2S Kit	168.00
SCION Microangelo Graphics Board A & T	899.00
Cromemco BRZ-II For CS-2 or Z-2H	399.00
Novation D "Cat" Modem	141.00
Ithaca Intersystems DPS-1 MF, CPU, With Front Panel A & T	1,599.00

Subject to Available Quantities • Prices Quoted Include Cash Discounts.
Shipping & Insurance Extra.

We carry products from all Major Manufacturers

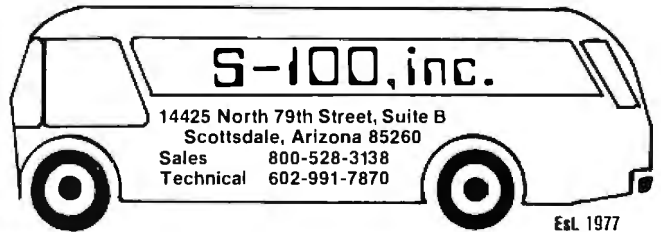

Best Price • Good Quality • Swift Delivery • Export

COMPUTER	
The Best Graphic Personal Computer	
LNW 80 I	280A, 65K, 480 x 192 \$1,395
	w/CPM compatible 1,670
II	125K, CPM compatible 2,100
	RGB interface 125
Multiuser Business/Engineer	
Best Price Anywhere	
CS1	5 1/4" floppy 2,956
Z2H	hard disk system 7,396
CS3	64K, 8" 5,177
CS1D2E	256K RAM, 68000 & 280
	4,067
C10	64K w/12" monitor 950
DYNABYTE	5200 64K, 1MB, Z80A 3,300
	5605 64K, 6MB hard d. 6,550
SWTPC	S/09 128K (UNIFLEX) 3,450
6809	/09 64K 1,835
Professional/Word Process	
ZENITH	Z90-80, 64K 2,050
	Z90-82, 64K, 1 disk 2,350
	Z89, 48K, 1 disk 2,050
	Z37 1.2MB Drives 1,450
NORTH STAR	HORIZON, 1
	quad drive, HD5 3,750
	ADVANTAGE, 2
	quad drives, 64K 2,689
16-bit CPU	
WICAT	S150 1FS 1-user 7,520
	256K RAM, CRT, 2 floppies
68000	S150 WS 1-user 8,999
	256K RAM, 10MB hard disk,
	960KB floppy CRT, OS + 1 language
	S150-3 WS 3-users 10,800
	same as S150 WS
	S150-6 WS 6-users 12,800
	512K RAM same as S150 WS
	Graphics 300 x 400 900
TERAK	8510A w/CRT 8,000
LSI/11	320 x 240, DD 17,000
graphic*	8600 w/13" color 17,000
	monitor, 640 x 480
ALTOS	ACSB600-10 500KB 8,350
8086	RAM, 10MB hard disk,
	500KB floppy multusers
	ACSB000-2 2,850
	64K, 1M, 8-bit
	PDP/11, VAX780, MINC call
DEC	
ATARI, NEC,	
SANYO	call

PRINTER	
Integral Data System	\$
PRISM 80	150 cps, 80 col. 740
	w/graphic 84 x 84 820
	W/color & graphic 1,120
	W/all options 1,340
PRISM 132	132 col. 1,050
	w/graphics 84 x 84 1,130
	w/color & graphic 1,430
	w/all options 1,590
EPSON	MX80 w/Graftrax 435
	MX70 315
	MX80 FIT Graftrax 539
	MX100 699
NEC	PC-8023A 480
ANADEX	DP-9500 1,300
OKIDATA	MICROLINE 80 365
Letter Quality	
DIABLO	630 1,995
C.I.TOH	Starwriter F-10 1,450
QUME	9/35 R.O. 1,800
BROTHER	HR-11 excellent 2,950
NEC	7710 2,299
MONITOR	
ZENITH	12" green 114
AMDEK	COLOR II RGB 13" 775
	COLOR I 13" 360
	300 G 12" green 1,179
SANYO	13" color 445
	13" RGB 905
NEC	12" green 170
	12" color 330
BMC	A 12" green 105
TM 12	RGB, 8 colors 550
TERMINAL	
ZENITH	Z19 635
HAZELTINE	ESPRIT 595
BEEHIVE	DMS smart ter. 800
IBM	3101-10 1,195
	3101-12 1,225
	3101-20 1,400
TELEVIDEO	910 599
CROMEMCO	Compatible 1,350
MODEM	
PRENTICE	STAR RS232 155

SOFTWARE	
database	\$
dBASE II Ashton Tate	499
CONDOR I	250
II	450
III	850
Financial (AR, AP, Inventory etc.)	
Accounting Plus Software Dimension	450
other	
VISICALC	199
MICROSOFT software	330
FORTRAN 80	345
BASIC 80	285
BASIC Compiler	310
SUPERCALC Sorcim	250
Micro Pro WORDSTAR	295
MAILMERG	105
SUPERSORT II	165
Digital Research CPM 2.2	139
CPM86	275
PASCAL MT & 86	450
IBM Personal Computer Software	call
DIGITIZER/PLOTTER	
HOUSTON INSTRUMENT	
HI PAD DIGITIZER DT-11 11" x 11"	725
DT-11A w/APPLE Interface	750
HI PLOT DMP-2 8 1/2" x 11"	920
COMPLIT DP-11 4000 steps/sec	4,000
8411A PRINTER/PLOTTER	5,200
CALL (212) 937-6363 free consultation, catalogue	
Prices subject to change. American Express, Visa/Mastercard add 3%. F.O.B. point of shipment. 20% restocking fee for returned merchandise. Personal checks take 3 weeks to clear. COD on certified check only. N.Y. residents add sales tax. Manufacturers' warranty.	
Computer Channel 21-55 44th Road Long Island City, NY 11101	

Computer Channel

Event Queue

August 1982

August

Database Concepts and Design, various sites throughout the U.S. Sponsored by the American Management Associations (AMA), this five-day seminar is designed for data-processing managers, system designers, and other personnel involved in database activities. Topics include an overview of the database environment; evaluating and measuring performance, costs, and results; determining organizational needs and the systems and software to meet them; and implementing, integrating, and supporting the database within company plans and budgets. Highlighting this seminar is a comprehensive review of database products. Individual fees are \$850 for AMA members and \$975 for nonmembers. Team discounts are available. Contact AMA, 135 West 50th St., New York, NY 10020, (212) 586-8100. To register by phone, call (212) 246-0800.

August

Summer Seminars from Datapro Research, various sites throughout the U.S. and Canada. Among the seminars being offered are "Using Computer-Aided Design/Computer-Aided Manufacturing Systems: Planning, Equipment Selection, and Applications" and "Data Communications: Effective Network Design." Enrollment fees are \$640 for Datapro subscribers and \$690 for nonsubscribers. For more information, contact Datapro Research Corp., 1805 Underwood Blvd., Delran, NJ 08075, (800) 257-9406; in New Jersey, (609) 764-0100.

August

Engineering Summer Conferences, Chrysler Center for

Continuing Engineering Education, North Campus, University of Michigan, Ann Arbor, MI. Among the conferences being offered are "Computers Image Analysis" and "Database Technology." For complete details, contact Engineering Summer Conferences, 200 Chrysler Center, North Campus, University of Michigan, Ann Arbor, MI 48109, (313) 764-8490.

August

Introduction to Microcomputing, various sites throughout the Midwest. Each participant in this three-day seminar will receive a Rockwell International AIM-65 computer and learn to program in machine language. Applications for instrumentation and process control will be emphasized. The seminar fee is \$895, which includes the AIM-65; in-house presentations can be arranged. Details are available from the Foundation for Computer Education, POB 668, Ogden, IA 50212, (712) 843-2000.

August-September

Professional Development Seminars, various sites throughout the U.S. These seminars are presented by the Institute for Advanced Technology, a part of Control Data Corporation. Seminar topics include "Computer Operations Management," "Data and Site Security," and "Effective Management of Software Projects." Complete outlines can be obtained from the Registrar, Institute for Advanced Technology, Control Data Corp., 6003 Executive Blvd., Rockville, MD 20852. To register, call (800) 638-6590; in Maryland, (301) 468-8576. Information on in-house presentations is available from Pam Gallos at the address above.

August-September

Courses from Boeing Computer Services Company, various sites throughout the U.S. Among the topics to be covered are programming languages and aids, operating system facilities, and conversational systems. A complete catalog of courses, locations, and fees is available from Boeing Computer Services Co., Education and Training Division, POB 24346, Seattle, WA 98124, (206) 575-7700.

August-December

Courses from Fairchild Camera and Instrument Corporation, Santa Clara, CA. Among the courses being offered are "F9445 Family Introduction," "Pascal for Microprocessors," and "F680X Microprocessor Family." For more information, contact Fairchild Camera and Instrument Corp., Education Center, 3420 Central Expressway, Santa Clara, CA 95051, (408) 773-2161.

August-December

Courses from Don White Consultants, various sites throughout the U.S. and Canada. Among the courses being offered are "Interference Control: An Introduction to Electromagnetic Interference/Radio Frequency Interference/Electromagnetic Compatibility," "Electromagnetic Compatibility—Design and Measurement for Control of Electromagnetic Interference," and "Tempest—Design, Control, and Testing." Course fees range from \$675 to \$945. For complete details, contact Don White Consultants Inc., State Route 625, Gainesville, VA 22065, (703) 347-0030.

August-December

IEEE Computer Society Conferences and Meetings, vari-

ous sites throughout the U.S., Europe, and Asia. Among the events scheduled are "Computer Vision: Representation and Control" and "The Annual Workshop on Computing to Aid the Handicapped." For a complete listing of conferences and meetings, contact the Executive Secretary, IEEE Computer Society, POB 639, Silver Spring, MD 20901, (301) 589-3386.

August 8-14

Institute for Coordinator of Academic Computing, Potsdam, NY. Among the topics to be covered are user education, hardware planning, software location, conversion and adaptation, and exposure to instructional software and utility. For details, contact Dr. Fritz H. Grupe, Associated Colleges of the St. Lawrence Valley, Potsdam, NY 13676.

August 10-11

Computers—Can You Afford Not to Understand?, New York, NY. The fee for this executive briefing is \$500. Further information can be obtained from the Registrar, Arthur Andersen & Co., Center for Professional Education, 1405 North Fifth Ave., St. Charles, IL 60174, (800) 323-0815; in Illinois, (800) 942-0851.

August 10-11

The Uncommon Carrier: New Opportunities in Carrier Services, New York, NY. For details, contact the Yankee Group, POB 43, Harvard Square, Cambridge, MA 02138, (617) 542-0100.

August 12-13

Microcomputers in Vocational Education Conference, Sheraton Inn, Madison, WI. Attendees will have access to both computer information for beginners and advanced applications of vocational education-related software.

START YOUR OWN COMPUTER CO.

HOW TO START YOUR OWN SYSTEMS HOUSE \$36.
7th edition, November 1981

Written by the founder of a successful systems house, this fact-filled 220-page manual covers virtually all aspects of starting and operating a small systems company. It is abundant with useful, real-life samples: contracts, proposals, agreements and a complete business plan are included in full, and may be used immediately by the reader. Proven, field-tested solutions to the many problems facing small turnkey vendors are presented.

HOW TO BECOME A SUCCESSFUL COMPUTER CONSULTANT \$28.
by Leslie Nelson, 4th revised edition, December 1981

Independent consultants are becoming a vitally important factor in the micro-computer field, filling the gap between the computer vendors and commercial/industrial users. The rewards of the consultant can be high: freedom, more satisfying work and doubled or tripled income. This manual provides comprehensive background information and step-by-step directions for those interested to explore this lucrative field.

FREE-LANCE SOFTWARE MARKETING \$30.
by B.J. Korites, 3rd edition, June 1980

Writing and selling computer programs as an independent is a business where • you can get started quickly, with little capital investment • you can do it full time or part time • the potential profits are almost limitless. This best-seller by Dr. Korites explains how to do it.

HOW TO START YOUR OWN WORD PROCESSING SERVICE \$39.50
by Leslie Nelson, May 1982

Turn a small investment into a steady, money making business that adds \$10,000, \$50,000 or \$100,000 to your income. Detailed start-up, marketing and operations plans are included.

Send check, money order, VISA, Master Charge or American Express # and exp. date. Publisher pays 4th class shipping. Add \$1.00 per book for UPS shipping (USA only). NJ residents add 5% sales tax. For faster shipment on credit card orders call (201) 783-6940.

ESSEX PUBLISHING CO. Dept. 2
285 Bloomfield Avenue • Caldwell, N.J. 07006

YOU'VE JUST FOUND THE MISSING LINK!



Computer Shopper is your link to individuals who buy, sell and trade computer equipment and software among themselves nationwide. No other magazine fills this void in the marketplace chain.

Thousands of cost-conscious computer enthusiasts save by shopping in Computer Shopper every month through hundreds of classified ads. And new equipment advertisers offer some of the lowest prices in the nation.

Computer Shopper's unbiased articles make for some unique reading among magazines and there's a "help" column to answer difficult problems you may have with interfacing, etc.

For a limited time you can subscribe to Computer Shopper with a 6 month trial for only \$6 or 12 months for only \$10. MasterCard & VISA accepted.

6 month trial, \$6 or 12 months for only \$10

COMPUTER SHOPPER
P.O. Box F303 • Titusville, FL 32780

305-269-3211

A REFURBISHED DAISY WHEEL TERMINAL FOR PERSONAL COMPUTER USERS AND SMALL BUSINESSES.

Now you can have letter-quality printing and professional features for just \$995*.

AJ daisy wheel printer terminals are renowned for exceptional performance, high reliability, and applications versatility. Now you can have all this for only \$995* in our special limited offer.

- 30 cps *letter-quality* printing
- Changeable type faces
- Full ASCII keyboard with numeric pad
- High resolution X-Y plotting
- Complete electronic forms control
- 128-character buffer
- Asynchronous RS-232 interface
- Printwheel, ribbon cartridge, and cable included
- 30-day parts/labor warranty

And you can choose from a list of options including forms tractor, pin-feed platen, paper trays, side shelves, extra printwheels, APL keyboard and 2K buffer.

Call your nearest AJ regional office for details: San Jose, CA (408) 946-2900; Rosemont, IL (312) 671-7155; Hackensack, NJ (201) 488-2525. Or check the phone book for the number of your local AJ sales/service office.

*Price excludes options and is subject to change without notice. Model shown includes certain options. Offer available only in the contiguous U.S.



ANDERSON JACOBSON

ADVANCED GRAPHICS SOFTWARE NOW—FOR MICROCOMPUTERS!

512 x 240
RESOLUTION

FOR COMPUSTAR®
SUPERBRAIN®
TRS-80® MODEL II



SPECIAL PACKAGE PRICE
SAVE \$950.00
(GETS YOU THE HARDWARE FREE!)

(213) 320-6604

XCEL™ GRAPHICS SOFTWARE

- Symbol Generator **\$175.00**
- Graph Plotter **\$175.00**
- 3D Generator **\$345.00**
- Surface Plotter **\$395.00**
- Graphics Terminal Emulator **\$395.00**
- Screen Printer **\$65.00**
ANADEX
EPSON
IDS

MAXTEK, INC. 2908 Oregon Court, Torrance, CA 90503
Available in Europe from Micronex Ltd., Chew Magna, England 3042 (STD 027-589 3042)
TRS-80 registered trademark. Tandy Corp.™ SuperBrain™ trademark. Interface Data Systems.
Textvision™ registered trademark. Textvision, Inc.™ CHM™ registered trademark. Digital™ trademark.

Event Queue

The registration fee is \$35. For more information, contact Judy Rodenstein or Roger Lambert, Vocational Studies Center, 964 Educational Sciences Building, 1025 West Johnson St., Madison, WI 53706, (608) 263-4367 or (608) 263-2704, respectively.

August 15-19

The Second International Computer Engineering Conference and Exhibition, Sheraton Harbor Island Hotel, San Diego, CA. This conference is sponsored by the Computer Engineering Division of the ASME (American Society of Mechanical Engineers). More than 50 exhibitors will display computer-engineering products, information, and services. The conference will feature technical sessions on more than 60 topics ranging from interactive graphics, personal computing by means of programmable calculators, computer-aided design and manufacturing, and robots. For complete details, contact the ASME, 345 East 47th St., New York, NY 10017, (212) 644-7100.

August 16-20

The National Conference on Artificial Intelligence, Carnegie-Mellon University and the University of Pittsburgh, Pittsburgh, PA. Among the topics to be addressed are expert systems, robotics, computational vision, programmable automation, game playing, and knowledge representation. Other features include an exhibition program and a two-day tutorial program providing a nontechnical look at key areas of artificial-intelligence research. Complete conference details are available from the American Association for Artificial Intelligence, 445 Burgess Dr., Menlo Park, CA 94025, (415) 328-3123.

August 17-18

The Uncommon Carrier: Opportunities in Carrier Services, Palo Alto, CA. For details, contact the Yankee Group, POB 43, Harvard Square, Cambridge, MA 02138, (617) 542-0100.

August 23-24

Personal Computer Market Opportunities and Pitfalls, the Anatole, Dallas, TX. The fee for this seminar is \$495. For more information, contact Future Computing Inc., 900 Canyon Creek Square, Richardson, TX 75080, (214) 783-9375.

August 31-September 3

Systems Project Management, Chicago, IL. The fee for this course is \$900. Complete details will be furnished by the Registrar, Arthur Andersen & Co., Center for Professional Education, 1405 North Fifth Ave., St. Charles, IL 60174, (800) 323-0815; in Illinois, (800) 942-0851.

September 1982

September 1-3

European Conference on Integrated Interactive Computing Systems (ECICS '82), Stresa, Italy. Among the topics to be covered are software architecture, user interfaces, system software and hardware, knowledge support, activities management, office information systems, and computer-aided design systems. For details, contact Maria Simi or Pierpaolo Degano, Istituto di Scienze dell'Informazione, Corso Italia 40, I-56100 Pisa, Italy, (50) 40862; Telex, 500371 CNUCE.

September 2-3

Indiana Computer Expo (ICE), Indianapolis Convention Center, Indianapolis, IN. This exposition will feature

runs on Logo



TURTLE GEOMETRY

The Computer as a Medium
for Exploring Mathematics
by Harold Abelson and Andrea diSessa

"Reading this book with the help of a good graphics computer system, you are sure to discover new and interesting math. *Turtle Geometry* is a serious effort to blend the computer with mathematics... an excellent textbook or self-study guide... a model for other efforts to bring the computer and mathematics to fruitful collaboration." —W. Lloyd Milligan, *Byte* (9/81)

Developed during the past decade by the authors and other members of the Logo Group at MIT's Artificial Intelligence Laboratory, material in *Turtle Geometry* covers: random motion • branching processes • space-filling designs • vector operations in two and three dimensions • topology of curves • maze-solving algorithms • intrinsic curvature of surfaces • spherical and "cubical" geometry • piecewise flat surfaces • General Relativity, among other topics. 477 pp. 300 illus. \$20.00

The MIT Press
28 Carleton Street
Cambridge, MA 02142

Reliable Business Software

DATASMITH software requires no previous computer experience, so it can be used effectively by your present office staff. The menu-driven systems feature extensive error detection and correction facilities, so they are "friendly" to the user.

- **GENERAL LEDGER.** Everything you need to keep the books. Features easy-to-use data entry and error correction, trial balance, fast post, and a variety of comprehensive reports. Automatic error detection keeps the books in balance. Writes checks and makes journal entries in one operation.
- **PAYROLL.** A very flexible system that adapts to a wide variety of needs. Features Federal, state, and local tax calculations, EI credit, and special pay and deduction amounts. Prints all necessary reports, paychecks, and W-2 forms.
- **DATA MANAGER.** A powerful generalized data management system that lets you define, enter, update, sort, select, and print reports from a database of your own design. Applicable to almost any job where records must be kept, this system can replace literally hundreds of programs.

Put your computer to work with these sophisticated systems now. Programs are available for 48K or larger two-disk systems in your choice of code for Microsoft BASIC-80® under CP/M®, IBM® Personal Computer BASIC, or Micropolis® BASIC.

DATASMITH

Box 8036, Shawnee Mission, KS 66208, (913) 381-9118

PRINTERS/SOFTWARE EXPANSION BOARDS

PRINTERS

ADS-8001	\$485.00
or C. ITOH 8510A	\$20.00
Dot Matrix Printers. Both printers have identical specs.	
120 CPS w/Graphics, tractor and friction feed.	
C. ITOH 1550 (PRO WRITER II) Parallel interface	\$800.00
Parallel/serial combination	850.00
120 cps 15" wide carriage. All other same as 8510A.	
C. ITOH F10/40	\$1,550.00
Daisy wheel 40 cps	
Grappler	\$140.00

DIGITAL PLOTTERS/DIGITIZERS

HOUSTON INSTRUMENT HIPLLOT	
DMP-3	\$1,177.00
DMP-4	1,262.00
DMP-6	1,687.00
DMP-7	1,857.00

PEN EXCHANGE KIT

DMP-442 6 Pen	\$356.00
DMP-593 8 Pen	456.00
HIPAD DT-11	701.00
HIPAD DT-11A	723.00

STROBE

Strobe Plot	\$749.00
-------------------	----------



MICRO DATA TEK

A Division of International Antex, Inc.
2630 California Street, Mountain View,
California 94040 (415) 941-7914

IBM PC

256K RAM Expansion Card (ADS-5001) expandable with 64K interval	
w/64K RAM on board	\$275.00
w/128K	425.00
w/192K	575.00
w/256K	725.00
Disk Drive—Double sided/double density	420.00
Single sided/double density	350.00
WordStar	297.00
MailMerge	90.00
Visicalc/256K	220.00
SuperCalc	220.00

MICROPRO SOFTWARE

	CP/M	Apple
WordStar	\$297.00	\$225.00
MailMerge	90.00	75.00
SpellStar	150.00	120.00
DataStar	210.00	177.00
SuperSort I	150.00	120.00
CalcStar	177.00	117.00

TERMINAL

BMC Green Terminal	\$105.00
---------------------------------	----------

APPLE BOARDS

16K RAM Card	\$75.00
Versacard	175.00
PRT-1 Parallel Int.	60.00
Smarterm	248.00
Z-Card	220.00

Showroom Hours: 8:30 to 5:30
Saturday: 10:00 to 3:00

ORDER: 1-800-547-2492

IN OREGON CALL

FOR TECHNICAL ASSISTANCE
(503) 479-4711 or (503) 479-4150

ATARI 400 (16K) \$289
800 (16K) \$665

EPSON w/GRAFTRAX I.D.S.

MX-80 \$439	560G Printer \$999
MX-80FT \$539	Prism 80 w/color \$1249
MX-100 \$699	Prism 132 w/color \$1549

RANA DRIVES VIC \$245

Controller - 4 Drives - \$119	TRS- 80
Elite 1 \$379	(CALL FOR PRICES)

TERMS:
SHIPPING: Add 3% of total transaction for UPS brown (ground) or 5% for UPS blue (air), Parcel Post, or any special arrangements.
PAYMENT: Cashier's checks, certified checks, money orders, and bank wires honored immediately. Wire transfer funds to U.S. National Bank of Oregon, South Grants Pass Branch. Credit RCE, account number 501-981, Add 3% for Visa and Master Charge. Allow 20 days for personal checks to clear.
REFUNDS: 10% restocking charge on all returns or exchanges. No refunds on opened software. Call first.
GUARANTEE: All products with full manufacturer's warranty. Sanyo and Apple warranty available. We have full repair and service facilities for all electronic repairs with HP, Dynascan, Pioneer, Sanyo and Apple trained and certified technicians. For any technical service call them for instant advice or questions right on their benches at (503) 479-4150.
REPAIRS: Out of warranty guarantee: Labor 30 days from date of your receipt, 90 days on parts. Call for details on quality guaranteed discount repair and reconditioning service.
We have been repairing electronic equipment for 12 years and love it!

SPECIAL ON APPLE REPAIRS — ALL PRICES PLUS PARTS

APPLE II \$50	DRIVES \$40	PRINTERS \$100
APPLE III \$100	SILENTYPE \$50	PERIPHERAL CARDS \$45

"A Unique Combination of Quality Products, Competitive Prices, and Service"

APPLE HARDWARE

MICRO SCSI DISK DRIVES (DIRECT APPLE REPLACEMENT)	
A-2 DISK DRIVE	\$359
A-70	\$479
A-40	\$359
CONTROLLER - 3.3 & 3.2	\$79
CCS 7710A SERIAL INT	\$129
CCS 7710B SERIAL INT	\$129
VIDEX 80 COLUMN	\$239
VIDEX ENHANCER II	\$119
LOWER CASE ADAPTOR	\$39
16K RAM CARD	\$149
MICROSOFT OR MPC	\$139
ALS	\$99
MICROTEK RAM-1	\$275
Z80 CARD (MICROSOFT)	\$269
MICROMODEM (HAYES)	\$209
SMART MODEM (HAYES)	\$309
NOVATION MODEMS	\$209
APPLE CAT	\$139
AUTO CAT	\$139
CAT	\$139
D CAT	\$139
MOUNTAIN CLOCK	\$239
MOUNTAIN MUSIC SYSTEM	\$309
MOUNTAIN A/D CONVERTER	\$269
MOUNTAIN INTROL/X-10 CARD	\$169
MOUNTAIN C.P.S.	\$149
KBD 23 KEYPAD	\$139
SUP-RATEM (80 COLUMN)	\$299
SUP-RMOD R.F. MODULATOR	\$24
ZORK	\$45
9" B&W MONITOR (SANYO)	\$145
12" B&W MONITOR (SANYO)	\$189
12" GREEN MONITOR (SANYO)	\$229
12" GREEN MONITOR (ZENITH)	\$119
12" GREEN MONITOR (BIC)	\$114
13" COLOR MONITOR (SANYO)	\$385
EPSON CABLE & INTERFACE	\$79
EPSON GRAFTRAX	\$10
POWERLINE PROTECTOR	\$39

ATARI HARDWARE

410 PROGRAM RECORDER	\$75
810 DISK DRIVE	\$425
820 PRINTER	\$249
822 PRINTER	\$339
825 PRINTER	\$579
830 MODEM	\$149
830 INTERFACE MODULE	\$165
833 16K MEMORY EXPANSION	\$79
MPC 32K	\$149

SOFTWARE

VISICALC (ATARI)	\$179
BASIC (ATARI)	\$49
VISICALC	\$179
VISIDEX	\$179
VISIFLOT	\$145
VISITERM	\$75
VISITREND/PLOT	\$214
VISIPAC	\$499
DESK TOP PLAN #2	\$179
DESK TOP PLAN #3	\$214
MICROLAB DATA FACTORY	\$129
D B MASTER (STONEWARE)	\$179
SUP-R-TEXT II	\$109
WORDSTAR	\$349
B.P.I. SOFTWARE (each)	\$319
STOCKFILE INVENTORY	\$269
ZORK	\$35
SARGONCHESS	\$29
GALAXIAN	\$22
VERBATIM DISKS	\$29
MAXELL DISKS	\$32
THE SOURCE	\$85

MINIMUM ORDER—\$100.00

MINIMUM SHIPPING CHARGES—\$4.00

PRICES SUBJECT TO CHANGE WITHOUT NOTICE

WRITE FOR CATALOG

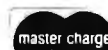

RALSTON-CLEARWATERS ELECTRONICS

530 N.E. 'E' Street • Grants Pass, Ore. 97526
ALL BRAND NAMES ARE REGISTERED TRADE MARKS

FREE NEBS COMPUTER FORMS CATALOG

Send today for our NEW full-color 56-page catalog with continuous checks, statements, invoices, stationery, envelopes, supplies and accessories. We will also send our FORMS SELECTOR GUIDE, to help you find the right forms for your software.

- **Quality products at low prices**
- **Available in small quantities**
- **Fast Service**
- **Money-Back Guarantee**
- **Convenient TOLL-FREE ordering**

Fast Service by mail or...PHONE TOLL FREE

1 + 800-225-9550

Mass. residents 1 + 800-922-8560

8:30 a.m. to 5:00 p.m. Eastern Time Monday — Friday

Please rush a new computer forms catalog to: _____

NAME _____

COMPANY _____

STREET _____

CITY, STATE and ZIP _____

PHONE _____

Hardware and Software being used. _____

CODE 31460

**Neb's
Computer Forms**

78 Hollis Street, Groton, Massachusetts 01471
A division of New England Business Service, Inc.

Event Queue

covered are analog and digital signal processing, office automation, and semiconductor technology. For more details, contact Electronic Conventions Inc., Suite 410, 999 North Sepulveda Blvd., El Segundo, CA 90245, (213) 772-2965.

September 20-24

COMPCON Fall '82, Capital Hilton Hotel, Washington, DC. This conference will focus on the principles behind work-station technology, including local area networks, operating systems, and new concepts in user interfaces. Topics of interest include reliability and availability techniques, network-wide databases, distributed architectures, network user environments, and standards. For information, contact COMPCON Fall '82, POB 639, Silver Spring, MD 20901, (301) 589-3386.

September 20-24

Auditing in the Contemporary Computer Environment, Oklahoma City, OK. This course is designed for internal auditors and financial and data-processing professionals. A comprehensive audit approach for computer-based systems will be presented. Topics on the agenda include how to evaluate controls, how to prepare an audit report, and how to design a program of tests using questionnaires, checklists, software tools, and flowcharts. Contact Marge Umlor, EDP Auditors Foundation, 373 South Schmale Rd., Carol Stream, IL 60187.

September 21-22

Word Processing/Information Systems Expo, Sheraton Washington Hotel, Washington, DC. This conference and exposition will address the trends and advances in the word-processing industry. Among the topics to be

covered are word processing and office integration, productivity measurement, and levels of managing an organization. Further details are available from National Trade Productions Inc., Suite 206, 9418 Annapolis Rd., Lanham, MD 20706, (301) 459-8383.

September 21-23

Software/Expo-National, Expo-center, Chicago, IL. This show is sponsored by *Infosystems* magazine. For complete details, contact Software/Expo, Suite 400, 222 West Adams St., Chicago, IL 60606, (312) 263-3131.

September 23-25

The First International Conference and Exhibition on Medical Computer Science (Medcomp '82), Hilton Hotel and the University of Pennsylvania, Philadelphia, PA. This conference is sponsored by the IEEE (Institute of Electrical and Electronics Engineers) Computer Society's Technical Committee on Computational Medicine. It is a transdisciplinary forum for engineers, medical professionals, and biomedical and computer scientists. Papers and exhibits will focus on topics such as the history and evolution of computers in medicine, artificial intelligence, software and systems evaluation, and signal and image processing. For additional information, contact the IEEE Computer Society, POB 639, Silver Spring, MD 20901, (301) 589-3386.

September 28-29

The Future Factory, Sunnyvale, CA. For details, contact the Yankee Group, POB 43, Harvard Square, Cambridge, MA 02138, (617) 542-0100.

September 28-October 1

Computer Trade Forum, National Exhibition Centre, Birmingham, England. This



SA2 ROBOT

\$999

The SA2 is a robot developed for the educational market, and has been designed to meet a requirement for a robot which will emulate, in behaviour and physical attributes, larger industrial robots.

The arm can access 360°, with a reach of 18 inches and a maximum lift of 1/2lb.

The Syntheasy

A low cost speech unit complete with Votrax speech output chip, unlimited vocabulary, power supply, speaker and case, all for only -

\$120



For further information contact:

INTELLIGENT ARTEFACTS LTD.

19205 Parthenia St., Suite H
Northridge, CA 91324 Tel (213) 993-4803

THEY SAY IT ALL... WE DO IT ALL!

ANNOUNCING THE C86™ C COMPILER —THE COMPILER THAT SPEAKS THE LANGUAGE OF THE FUTURE!

Kernighan and Ritchie's book, *The C Programming Language*, is the key source for C. Just as fundamental is the C86™ C Compiler.

The C86™ C Compiler is especially designed for the IBM® Personal, IBM® Display Writer, CP/M-86® and MS-DOS®

For further information on the C programming language and the C86™ C Compiler, please contact:

Computer Innovations, Inc.
75 Pine Street
Lincroft, New Jersey 07738
Telephone: (201) 530-0995

C86 is a trademark of Computer Innovations, Inc., CP/M-86 is a trademark of Digital Research; IBM and MS-DOS are registered trademarks of International Business Machines, Inc.

LEASE YOUR FLEET FROM THE COMPANY THAT MANAGES THE LARGEST FLEET IN THE WORLD.

When you lease from Hertz you get something no other leasing company can offer you: Hertz experience.

We can lease you any make, any model and any number of cars. And no matter what your leasing needs are you'll find Hertz has a plan to meet them.

So call 1-800-847-4068 or write to Kevin McDonald, Hertz Car Leasing, 3 Entin Road, Parsippany, New Jersey 07054.

And get the same company that manages the #1 fleet in the world helping you manage yours.



© REG U S PAT OFF ©HERTZ SYSTEM INC 1982

Stackworks Forth Means . . . Fast Development

Stackworks Forth is more than a language— it is a complete approach to Z80 software development. A full, extendable interpreter-compiler producing compact code, optionally ROMable to under 2K, Stackworks Forth is as fast as compiled Fortran, as easy to use as interactive Basic.

Completely I/O compatible with CP/M, Stackworks Forth is a simple, self-contained, stack oriented system allowing high level development and instantaneous debugging and modification of complete end user oriented programs. Stackworks Forth is fast and its threaded list structure offers production code approaching and in many cases exceeding the compactness of equivalent assembly code.

Stackworks Forth is ideally suited for rapid software design with immediate testing capability, for applications in robotics, hardware development, process control, any field with a need for Stackworks power.

Stackworks Forth Means Power

Stackworks Forth means compact production code, high speed, high level coding, fast on-the-spot debugging, in-line assembly code capability, simplicity of structure, and more . . .

Forty-Five Dollars provides the user with a complete, fully documented system for Z80 CP/M software development (includes 16 bit, 32 bit, and 13 digit BCD math routines).

Option B adds the Stackworks Forth assembler and debugger to the base package and includes tutorial for a total of \$80.

Option C includes the above with ROM option and source code for creating modules in as little as 2K bytes and allows unlimited in-house use of Stackworks Forth for \$400. Commercial users are invited to inquire about additional Stackworks Forth licenses.

Option D provides Option B software and the **Xedex Baby Blue** add-in board for the IBM Personal Computer for a total of \$600.

MasterCard, Visa, or American Express call 800/457-4544 or write The Stackworks, 1414 E University, Box 1596, Bloomington, IN 47402.

The logo for Stackworks, featuring the word "stack" in a bold, lowercase, sans-serif font above the word "works" in a similar font, both slanted to the right.

Stackworks Forth for both CP/M-86 and DOS on the IBM Personal Computer . . . in development.

Event Queue

trade show will bring together vendors, original equipment manufacturers, dealers, distributors, retailers, service companies, and independent sales organizations. For complete details, contact Clapp & Poliak Inc., 245 Park Ave., New York, NY 10167, (212) 661-8410. In England, contact Clapp & Poliak Europe Ltd., 232 Acton Lane, London W4 5DL, 01-747-3131.

October 1982

October 1-2

The Third Annual Fall Conference on Classroom Applications of Computers, San Jose, CA. This conference is sponsored by Computer-Using Educators, a nonprofit corporation. Topics will cover all areas of curricula from preschool through post-secondary school. Workshops, field trips, school visits, commercial exhibits, and a banquet dinner with a keynote speaker will be featured. Participation in all events is by preregistration only. Conference information is available by writing to Don McKell, Computer-Using Educators, POB 18547, San Jose, CA 95158.

October 1-7

Electronics 82, Bella Center, Copenhagen, Denmark. This will be the largest electronics fair in Scandinavia this year. It will feature demonstrations, conferences, talks, seminars, and commercial exhibits ranging from automation equipment to technical magazines. Approximately 250 exhibitors, representing almost 1000 firms, are expected. For particulars, contact Bella Center A/S, Center Blvd., DK-2300 Copenhagen S, Denmark, (01) 51 88 11; Telex: 31188 bella dk.

October 4

Knowledge Engineering in the 1980s, Boston, MA. For details, see September 13.

October 4-8

Auditing in the Contemporary Computer Environment, Hartford, CT. For details, see September 20-24.

October 5-7

The Third Annual Southwest Semiconductor Exposition, Civic Plaza Convention Center, Phoenix, AZ. "Automation/Automania?" is the theme for this year's technical conference. Suppliers of equipment and materials dedicated to the semiconductor, printed-circuit board, and hybrid industries will attend. Among the issues to be explored are the latest trends in general wafer processing and printed-circuit board manufacturing, hybrids, automation, robotics, and automatic testing. Highlighting this conference will be a preventative-maintenance training forum. Contact Cartlidge & Associates Inc., Suite 1014, 491 Macara Ave., Sunnyvale, CA 94086, (408) 245-6870.

October 7-8

Workshop on Automotive Applications of Microprocessors, Hyatt Regency Hotel, Dearborn, MI. This workshop is a forum on applications of microprocessors to automobiles, trucks, vans, allied automotive products, plants, and processors. Topics of interest include engine control, engine and vehicle diagnostics, instrumentation and display, safety systems, drive train control, plant process and quality control, and test equipment. For further details, contact S. Murtuza, Department of Electrical Engineering, University of Michigan, 4901 Evergreen

Rd., Dearborn, MI 48128, (313) 593-5028 or (313) 593-5420.

October 8-11

Electronica, Hynes Auditorium, Boston, MA. This show will feature a wide variety of personal electronics equipment, including computers, electronic games, ham radios, and projection TV. For more information, contact Northeast Expositions, 824 Boylston St., Chestnut Hill, MA 02167, (617) 739-2000.

October 10-14

Association of Records Managers and Administrators (ARMA) Annual Conference and Exposition, Atlanta, GA. This is ARMA's twenty-seventh annual meeting. Word processing, data communication, and other aspects of information storage and retrieval will be examined. Additional information can be obtained from National Trade Productions Inc., 9418 Annapolis Rd., Lanham, MD 20706, (301) 459-8383.

October 10-14

Issue '82, Monteleone Hotel, New Orleans, LA. This is the sixth annual conference of Issue, an independent nonprofit organization of SPSS Inc. software users and coordinators. Papers will address such topics as data analysis, research training, computer graphics, and training materials and documentation. Contact the Executive Coordinator of Issue Inc., POB 11385, Chicago, IL 60611, (312) 329-2400.

October 11-12

Personal Computer Peripherals Market Analysis, The Anatole, Dallas, TX. The fee for this seminar is \$495. Further details are available from Future Computing Inc., 900 Canyon Creek Square, Richardson, TX 75080, (214) 783-9375.

October 11-14

The Ninth International Management Exposition and Conference, Info 82, New York Coliseum, New York, NY. Full particulars may be requested from Clapp & Poliak Inc., 245 Park Ave., New York, NY 10167, (800) 223-1956; in New York, (212) 661-8410.

October 12-13

The Future: Home, New York, NY. For details, contact the Yankee Group, POB 43, Harvard Square, Cambridge, MA 02138, (617) 542-0100.

October 13-15

Advanced Electronic Data Processing Auditing Concepts, Los Angeles, CA. For details, see September 13-15.

October 15-17

The Second Annual Symposium on Small Computers in the Arts, Philadelphia, PA. Papers, tutorials, workshops, a gallery display of computer-generated prints and plots, films and video tapes, and computer-generated music performances are parts of this event. Topics of interest include computer graphics and animation, computer-automated sculpture, choreography, designs, and computer-generated music. The Annual Philadelphia Computer Music Concert is the featured attraction of this symposium. Address inquiries to the Symposium on Small Computers in the Arts, POB 1954, Philadelphia, PA 19105.

October 17-21

The Thirty-first Annual Data Processing Management Association (DPMA) International Conference and Exposition, Chicago Marriott Hotel, Chicago, IL. This will be the largest show in the DPMA's history. More than 85 companies will exhibit office automation technologies and data- and word-processing

equipment. A full conference program is planned. Contact National Trade Productions Inc., 9418 Annapolis Rd., Lanham, MD 20706, (301) 459-8383.

October 18-22

Auditing in the Contemporary Computer Environment, Tulsa, OK. For details, see September 20-24.

October 18-22

Maintainability and Availability Engineering of Equipment and Systems, University of California, Los Angeles, CA. This short course is for upper-level and product managers, designers, salespeople, field-service personnel, and for those involved in the management, conception, design, operation, and maintenance of equipment. Topics to be

covered include distribution of times-to-repair components and times-to-restore equipment, the equipment mean-time-to-restore, and optimum preventive maintenance schedules for minimum total corrective and preventive maintenance cost. The fee is \$825, which includes notes. A complete course outline is available from Continuing Education in Engineering and Mathematics, UCLA Extension, POB 24901, Los Angeles, CA 90024, (213) 825-4100.

October 19-20

The Future: Home, Palo Alto, CA. For information, contact the Yankee Group, POB 43, Harvard Square, Cambridge, MA 02138, (617) 542-0100.

MULTI-PROGRAMMER SYSTEM-10

Features:

- Dedicated keys and large display vocabulary for ease of use.
- I/O - 6 baud rates, 13 formats including Intellec, Textronix and Motorola.
- EPROMs, E²PROMs and bipolars.
- Gang option - programs eight at once.
- Remote control option.

\$1,295

**PROGRAMS
OVER 250
DEVICE TYPES**

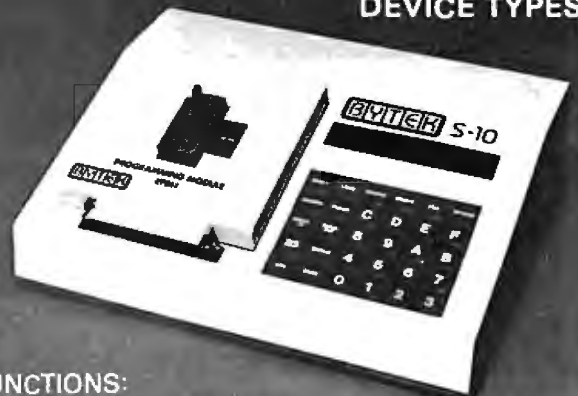

FUNCTIONS:

DISPLAY DEVICE DATA	LOAD DATA	CRC - DEVICE/RAM
EDIT RAM DATA	COMPARE FIELDS	CRC - RAM
DEVICE PROGRAM	FILL MEMORY FIELD	I/O HOST PROMPT
TYPE SELECTION	BLOCK MOVE	DIAGNOSTICS
		and more . . .

BYTEK

COMPUTER SYSTEMS CORP

100 East Linton Blvd. Delray Beach, Fla. 33444 (305) 272-2051

Event Queue

October 21-24

EdCOM '82—The National Computer Conference and Expo for Educators, Los Angeles Convention Center, Los Angeles, CA. More than 200 seminars, workshops, demonstrations, and exhibits are planned. In-depth tutorials and hands-on sessions will be held. Topics of interest include computer-aided instruction, administrative uses of microcomputers, classroom management, programming, research applications, computer literacy, and authoring languages. Information is available from Jayne LaFountain, EdCOM '82, 2629 North Scottsdale Rd., Scottsdale, AZ 85257, (800) 528-2355.

October 24-26

Texas Association for Educational Data Systems (TAEDS)

Eighteenth Annual Convention, Villa Capri Hotel, Austin, TX. The conference theme is "Computer Literacy for Education, Industry, and the Community." Contact Dr. Terry Bishop, Austin ISD, 6100 Guadalupe St., Austin, TX 78752.

October 25-27

Advanced Electronic Data Processing Auditing Concepts, Tulsa, OK. See September 13-15 for details.

October 25-27

The 1982 ACM (Association for Computing Machinery) Annual Conference, ACM '82, Dallas Hilton Hotel, Dallas, TX. Among the topics to be addressed are programming languages, artificial intelligence, office automation, networks, graphics, com-

puters and the handicapped, and operating, database, and distributed systems. General conference information is available from William Burns, ACM '82 Chairman, E-Systems Inc., POB 226118, Dallas, TX 75266, (214) 272-0515, ext. 3916.

October 26-28

The First IEEE Computer Society International Symposium on Medical Imaging and Image Interpretation, ISMII '82, International Congress Center, Berlin, West Germany. This symposium is sponsored by the IEEE (Institute of Electrical and Electronics Engineers) Computer Society's Technical Committee on Computational Medicine. It will provide a transdisciplinary forum for biomedical and computer scientists, engineers, medical physicists, and physicians from universities, medical centers, industry, and government. Papers and panel discussions will examine a variety of topics including microscope imaging, medical computer graphics, medical device regulation, computer-aided diagnosis, and image analysis systems. Equipment will be displayed. A thorough description of ISMII '82 is available from the IEEE Computer Society, POB 639, Silver Spring, MD 20901, (301) 589-3386.

October 26-31

The Fourth International Office Trade Fair, Orgatechnik

'82, Cologne, West Germany. More than 1300 companies from 25 countries will exhibit the complete spectrum of office and information system products. Among the concurrent events planned are the KTV—Congress for Text Processing, Dafta '82—Data Protection Conference, and Telecom '82 Germany—Congress for Telecommunications in Business and Industry. For further information, contact Messe- und Ausstellungs-Ges.m.b.H Köln, Box 21 07 60, D-5000 Cologne 21, West Germany; Telex: 8 873 426 a mua d.

October 30-November 2

The Sixth Annual Symposium on Computer Applications in Medical Care (SCAMC), Sheraton Washington Hotel, Washington, DC. Topics to be addressed include medical informatics, health-care administration, information systems in health care, and artificial intelligence in medicine. Panel discussions, workshops, applications and methods demonstrations, and commercial exhibits are on the agenda. Highlighting this show will be the final round of the student paper competition. Information is available from Bruce I. Blum, SCAMC—Office of Continuing Medical Education, George Washington University Medical Center, 2300 K St. NW, Washington, DC 20037, (202) 676-4285. ■

UV EPROM ERASER

- * Erases over 15 EPROMS - 15 minutes erase time
- * Element life 7700 hours
- * Intensity: 12W/s 1/4cm² at 1"
- * Erases all UV EPROMS (2716, 2732, 2516, 2532, etc.)

\$49.95*

*HOBBY MODEL



INDUSTRIAL MODEL
QUV-T8/2N
\$68.95

WITH TIMER & SAFETY SWITCH
QUV-T8/2T
\$97.50

ABOVE 220VAC
50HZ
QUV-T8/2TE
\$109.50

PRICE INCLUDES ALL PERSONALITY MODULES

STAND ALONE RS-232 INTELLIGENT PROGRAMMER \$489.00

PROGRAMS: 2508, 2516, 2532, 2716, 2732, 2732A, 2758, 8748, 8749

- * STAND ALONE, CRT, OR COMPUTER CONTROL
- * UPLOAD/DOWNLOAD IN MOTOROLA OR INTEL HEX FORMAT
- * MICROPROCESSOR BASED * 4 K INTERNAL RAM
- * 90 DAY PARTS & LABOR WARRANTY ON ALL PRODUCTS

- * GANG PROGRAMMER
- * 2564 2764 PERSONALITY MODULES

Soon to be released

PHONE ORDERS (305) 776-5870

TWX: 510-955-9496 • WE ACCEPT VISA, MC, CHECKS, C.O.D., MONEY ORDER

LOGICAL DEVICES INC.

781 W. OAKLAND PARK BLVD. • FT. LAUDERDALE, FL 33311

ADD: \$4.00 SHIPPING \$2.00 C.O.D. CHARGES

In order to gain optimal coverage of your organization's computer conferences, seminars, workshops, courses, etc, notice should reach our office at least three months in advance of the date of the event. Entries should be sent to: Event Queue, BYTE Publications, POB 372, Hancock NH 03449. Each month we publish the current contents of the queue for the month of the cover date and the two following calendar months. Thus a given event may appear as many as three times in this section if it is sent to us far enough in advance.

System Notes

Using the LOOKUP Function in Visicalc

Robert E. Ramsdell, C.P.A.
Pansophics Ltd.
Whistlestop Mall
POB 59
Rockport, MA 01966

According to feedback I get from users, the most difficult operation to understand in the Visicalc software package is the @LOOKUP function. In this article, I'll explain that function using as an example calculation of the 1980 federal income tax form 1040 for a joint return (see table 1).

The LOOKUP function in Visicalc is designed to take a value and compare it to a table of increasing values. This operation can be performed either across a row or down a column. When the program finds an amount greater than the value being tested, the LOOKUP function displays the entry immediately to the right (in column order) or immediately below (in row order) the value that appears just *before* the amount greater than the value being tested. In our example, the initial value is the taxable income and the range of values is defined by the income-level break-points in the tax-rate schedule.

In BASIC, the @LOOKUP function would be represented by the following formula:

IF (value) <= (number in range) THEN (result)

In Visicalc the result can be a fixed value or a calculated amount based on certain other information.

Let's see how the LOOKUP table is created (see table 2). First a title for the model is placed in columns A to D, row 1. Next a value of 0 is placed in column A, row 2 and

a title is placed in columns B and C, row 2. The value at A2 will become the amount that is looked up in the table. Columns A, B, C, and D in row 3 all contain 0 values.

SCHEDULE Y—Married Taxpayers and Qualifying Widows and Widowers

Married Filing Joint Returns and Qualifying Widows and Widowers

Use this schedule if you checked Filing Status Box 2 or 5 on Form 1040—

If the amount on Schedule TC, Part I, line 3, is:

Enter on Schedule TC, Part I, line 4:

Not over \$3,400..... —0—

Over—	But not over—		of the amount over—
\$3,400	\$5,500	14%	\$3,400
\$5,500	\$7,600	\$294+16%	\$5,500
\$7,600	\$11,900	\$630+18%	\$7,600
\$11,900	\$16,000	\$1,404+21%	\$11,900
\$16,000	\$20,200	\$2,265+24%	\$16,000
\$20,200	\$24,600	\$3,273+28%	\$20,200
\$24,600	\$29,900	\$4,505+32%	\$24,600
\$29,900	\$35,200	\$6,201+37%	\$29,900
\$35,200	\$45,800	\$8,162+43%	\$35,200
\$45,800	\$60,000	\$12,720+49%	\$45,800
\$60,000	\$85,600	\$19,678+54%	\$60,000
\$85,600	\$109,400	\$33,502+59%	
\$109,400	\$162,400	\$47,544+64%	\$109,400
\$162,400	\$215,400	\$81,464+68%	\$162,400
\$215,400	\$117,504+70%	\$215,400

Married Filing Separate Returns

Use this schedule if you checked Filing Status Box 3 on Form 1040—

If the amount on Schedule TC, Part I, line 3, is:

Enter on Schedule TC, Part I, line 4:

Not over \$1,700..... —0—

Over—	But not over—		of the amount over—
\$1,700	\$2,750	14%	\$1,700
\$2,750	\$3,800	\$147.00+16%	\$2,750
\$3,800	\$5,950	\$315.00+18%	\$3,800
\$5,950	\$8,000	\$702.00+21%	\$5,950
\$8,000	\$10,100	\$1,132.50+24%	\$8,000
\$10,100	\$12,300	\$1,636.50+28%	\$10,100
\$12,300	\$14,950	\$2,252.50+32%	\$12,300
\$14,950	\$17,600	\$3,100.50+37%	\$14,950
\$17,600	\$22,900	\$4,081.00+43%	\$17,600
\$22,900	\$30,000	\$6,360.00+49%	\$22,900
\$30,000	\$42,800	\$9,839.00+54%	\$30,000
\$42,800	\$54,700	\$16,751.00+59%	\$42,800
\$54,700	\$81,200	\$23,772.00+64%	\$54,700
\$81,200	\$107,700	\$40,732.00+68%	\$81,200
\$107,700	\$58,752.00+70%	\$107,700

Table 1: Schedule Y from the 1980 federal income tax form 1040.

About the Author

Robert E. Ramsdell, C.P.A., is a microcomputer consultant who lives and works in Rockport, Massachusetts.

WANTED:
S D SYSTEMS
USERS
REWARD:

“On Time Delivery”
 “Professional Treatment”
 “Full Support”
 “\$\$\$ Competative \$\$\$”

BOARD LEVEL PRODUCTS

SBC 200	\$308
EXPANDORAM II	\$417
EXPANDORAM III	\$799
VERSA FLOPPY II	\$355
VDB 8024	\$465
MPC - 4	\$495

SYSTEMS: READY
FOR DELIVERY!!

WS-800	MS-200
SD-200	MS-610
SD-610	
SD-700	

SONICS MICRO SYSTEMS

1500 N.W. 62nd ST. #508
 FT. LAUDERDALE, FLA. 33309

1-800-327-5567

System Notes

	A	B	C	D	
1	1980	JOINT	TAX	LOOKUP	1
2		0	TAXABLE	INCOME	2
3		0		0	0 3
4		0	.14	3400	-476 4
5		294	.16	5500	-586 5
6		630	.18	7600	-738 6
7		1404	.21	11900	-1095 7
8		2265	.24	16000	-1575 8
9		3273	.28	20200	-2383 9
10		4505	.32	24600	-3367 10
11		6201	.37	29900	-4862 11
12		8162	.43	35200	-6974 12
13		12720	.49	45800	-9722 13
14		19678	.54	60000	-12722 14
15		33502	.59	85600	-17002 15
16		47544	.64	109400	-22472 16
17		81464	.68	162400	-28968 17
18		117504	.7	215400	-33276 18
19				1E12	19
20			TOTAL TAX		0.00 20

Table 2: LOOKUP table using column format.

Column A will now have the cumulative tax amounts typed in; column B, the tax percentages; and column C, the income-level break-points (see table 1). One additional amount (at location C19) must be entered, representing the highest possible taxable income. I have arbitrarily chosen 1E12 for this amount, because the majority of my clients don't have taxable income exceeding a trillion dollars.

Now the actual tax calculations can be entered into column D. At location D4 the following formula could be typed:

$$+B4*(A2-C4)+A4$$

This formula states: take the taxable income (A2) and subtract the income-level break-point (C4), multiply it by the tax rate (B4) and add the cumulative tax amount (A4). This formula may now be replicated with the following commands:

/R (return), D5 . D18 (return), R N R R

Finally, the @LOOKUP function is inserted at location D20 with the following formula:

$$@LOOKUP (A2, C3 . C19)$$

This formula states: take the taxable income (A2) and compare it to the values shown in the table (C3 to C19). When a value greater than A2 is found, back up one amount and print the result found in the column immediately to the right.

An important point to remember concerning a Visicalc idiosyncrasy is that determinant (or forward) references require recalculation, and to avoid this requires an awareness of Visicalc's calculation methods. The value to be looked up (in this case the taxable income) must appear *before* the LOOKUP table, and the @LOOKUP

	A	B	C	D	E	F	G	H	I
1	1980 JOINT TAX TABLE								
2	0 TAXABLE INCOME								
3		0	0	294	630	1404	2265	3273	4505
4		0	.14	.16	.18	.21	.24	.28	.32
5		0	3400	5500	7600	11900	16000	20200	24600
6		0	-476	-586	-738	-1095	-1575	-2383	-3367
7	0.00 TOTAL TAX								

	J	K	L	M	N	O	P	Q	R
									1
									2
	6201	8162	12720	19678	33502	47544	81464	117504	3
	.37	.43	.49	.54	.59	.64	.68	.7	4
	29900	35200	45800	60000	85600	109400	162400	215400	1E12 5
	-4862	-6974	-9722	-12722	-17002	-22472	-28968	-33276	6
									7

Table 3: LOOKUP table using row format.

function after the table has been seen in the calculation order. Remember that column calculations begin at location A1 and proceed downward to location n , then back to B1 and down to n , etc. Row calculations begin at A1 and proceed across to n , then back to A2 and across to n , etc. (see table 3).

Now let's take a look at table 4 to see how the calculation works. A taxable income of \$26,000 has been entered at location A2. The @LOOKUP function at D20 takes this value and compares it to the table from C3 to C19. The first number greater than 26,000 in the table is 29,900, so the function drops back one value (to 24,600) and prints the calculation shown immediately to the right of that value, 4953. Table 5 shows how to accomplish these same calculations using row lookups instead of columns.

The @LOOKUP function has many more uses, and when used with the @MIN and @MAX functions it can be used to solve most problems involving conditional relationships. ■

	A	B	C	D
1	1980 JOINT TAX LOOKUP			
2	26000 TAXABLE INCOME			
3	0	0	0	0
4	0	.14	3400	3164
5	294	.16	5500	3574
6	630	.18	7600	3942
7	1404	.21	11900	4365
8	2265	.24	16000	4665
9	3273	.28	20200	4897
10	4505	.32	24600	4953
11	6201	.37	29900	4758
12	8162	.43	35200	4206
13	12720	.49	45800	3018
14	19678	.54	60000	1318
15	33502	.59	85600	-1662
16	47544	.64	109400	-5832
17	81464	.68	162400	-11288
18	117504	.7	215400	-15076
19			1E12	19
20			TOTAL TAX	4953.00 20

Table 4: LOOKUP table for a couple with \$26,000 in total income.

	A	B	C	D	E	F	G	H	I
1	1980 JOINT TAX TABLE								
2	26000 TAXABLE INCOME								
3		0	0	294	630	1404	2265	3273	4505
4		0	.14	.16	.18	.21	.24	.28	.32
5		0	3400	5500	7600	11900	16000	20200	24600
6		0	3164	3574	3942	4365	4665	4897	4953
7	4953.00 TOTAL TAX								

	J	K	L	M	N	O	P	Q	R
									1
									2
	6201	8162	12720	19678	33502	47544	81464	117504	3
	.37	.43	.49	.54	.59	.64	.68	.7	4
	29900	35200	45800	60000	85600	109400	162400	215400	1E12 5
	4758	4206	3018	1318	-1662	-5832	-11288	-15076	6
									7

Table 5: LOOKUP table as in table 4 but in row format.

News and Speculation about Personal Computers

Conducted by Sol Libes

Random Rumors: Commodore International is said to have working prototypes of its new family of 16/32 microprocessors. The devices are expected to be upwardly compatible with the 6500 series microprocessors, and the company may begin shipping samples before year-end. However, expect to see an Intel 8088 or 8086 in the new 16-bit personal computer Commodore is expected to introduce soon. . . . You can expect Sears to expand the number of its Business Systems Centers to over 200 within the next few years. . . . IBM is rumored to be working on several new microcomputer projects: a second-generation personal computer, a portable personal computer, a low-cost consumer personal computer, and a professional work station. . . . Microsoft is expected to release version 2.0 of its MS-DOS (used on the IBM Personal Computer) this fall. Expect it to contain features such as multiple screen windows, string system commands, and stress networking. . . . Portia Isaacson predicts that we will soon see robot stores in addition to our current computer stores and software stores. She also predicts that software stores will follow a growth curve similar to that of computer stores, sharing a \$1.5 billion market by 1989. . . . Intel is said to be negotiating with Microsoft to put Xenix in its software line as an option. In the meantime Intel is readying release 5 of its RMX operating system, which will be upgraded to a multiuser system. . . . Zenith is reportedly dubbing its new 16-bit system the Z-100; it may use the 68000 microprocessor and may also be available in kit form from Heath. A 16-bit microprocessor trainer might also be in the works. Heath, which already has 60 stores,

is expected to open 10 more this year. Microcomputers are now approaching 50 percent of Heath sales. . . . The Marc operating system for Z80-based computers, which contains many Unix-like features, is expected to reach the market finally in the fall. It is from Vortex Technology, Culver City, California. . . . Digital Research is rumored to be working on 68000 versions of CP/M, MP/M and CP/Net. These versions are all currently running in-house and are expected to be released before year-end. . . . Univac and Control Data Corporation are expected to soon introduce Z80-based personal computers running CP/M, with communications facilities.

Word has it that Osborne Computer is readying a \$500 personal computer, complete with software, for introduction possibly this year. In the meantime, the company expects to have 150,000 Osborne 1s installed by the end of this year.

IBM Rumblings: From disclosures of disk contracts being signed by IBM it is estimated that IBM expects to sell close to 1 million IBM Personal Computer systems by the end of 1984. The company has also just added 500 more employees to its Boca Raton, Florida, facility, which assembles the Personal Computers. . . . IBM reported worldwide net earnings of \$768 million for the first quarter of 1982; that's up \$38 million from the same quarter last year. Gross income for the period was over \$7 billion, compared to \$6.46 billion last year.

Apple Doings: Apple Computer Inc. reported that earnings for the first quarter of this year rose 50 percent

while revenue rose 70 percent. A. C. "Mike" Markkula, Apple president, forecasted earnings of close to \$14 million, as opposed to \$9.2 million for the same period last year.

Apple is beginning to feel the effects of recent marketing decisions (e.g., Apple's controversial ban on mail-order sales) and competition from new entries into the field (most notably IBM). Revenue was fractionally below the previous quarter (\$133.6 million).

Most industry analysts feel that sales of the Apple II have finally hit a plateau at an estimated 20,000 systems per month. It is also estimated that there are about 400,000 such systems presently in use. It is expected that Apple will finally announce a new version of the Apple II this summer. The new computer is expected to be compatible with the Apple II and have a standard 80-character by 24-line display with lowercase letters, plus several other enhancements; and it will be priced lower than the current version.

In the meantime, Apple has made another major marketing change that should have a considerable effect on its sales. Apple has terminated its central buying agreement with Computerland, the nation's largest chain of computer stores, in an attempt to gain control over the geographic locations of its retail outlets. Computerland wanted all of its current and future outlets to be able to sell Apples from any location Computerland desired. Apple wanted to be able to specify which new franchises could or could not sell Apples.

Independent Apple dealers have long been asking Apple to reduce the competition from so-called low-support

dealers and have contended that mail-order companies and many Computerland dealers were guilty of low-support discount sales.

Apple already has agreements to sell directly to most Computerland dealers; however, these dealers will now have to pay a higher cost than under their previous central purchasing agreement. Since Computerland undertook to sell IBM's system, the chain's contribution to Apple's sales has declined.

Apple is also cracking down on dealers who have been "transshipping" to mail-order and telephone sellers. Reportedly, at least six Apple dealerships have been terminated for this reason. Apple has been discreetly purchasing systems from unauthorized dealers to track serial numbers and identify the transshippers.

The sum and substance of these policy changes is that Apple is attempting to build loyalty into its dealer base to offset existing and anticipated competition from IBM, Osborne, Digital Equipment Corporation (DEC), and several Japanese makers.

The \$99.95 Personal Computer: Timex, well known around the world as a leading supplier of low-cost watches, has entered the personal computer market with a blockbuster. The company will be mass-merchandising an improved version of the Sinclair ZX81, to be called the Timex Sinclair 1000, at a list price of \$99.95, and it's likely that we'll eventually see these machines discounted in chain department stores, drugstores, jewelry stores, and consumer electronics outlets at prices ranging down to \$75.

Timex has been manufacturing the ZX81 for Sinclair and is currently pushing units



“Our current recommendation for a big five accounting package is MBSI”

Computer Dealer magazine
January, 1982

At last, full feature general business software for micro-computers.

Officially authorized derivations from the popular MCBA[®] mini-computer packages, these packages have been eased down to micros and made even more user friendly.

The mini versions of these packages are distributed by over 900 OEMs and dealers, and are in use at over 9,000 end user sites worldwide.

And already these micro versions themselves are in use by thousands of end users.

Written in RM/COBOL[™], these packages run under CP/M[®], OASIS[™], UNIX[®], COS-990[®] and other operating systems.

They run on dozens of brands of micro-computers, including properly configured models from Radio Shack II,

Apple III, Zenith, Hewlett Packard 125, Xerox 820, ALTOS, ONYX and many more.

Tens of man-years have gone into these packages, which comprise over 230 programs, 165,000 lines of structured source code, and 1,800 pages of user and technical documentation.

Our claim is simple:

THIS IS THE BEST MICRO-COMPUTER GENERAL BUSINESS SOFTWARE AVAILABLE.

And we stand behind that with a moneyback guarantee.

It's no accident that *Computer Dealer* magazine recently endorsed MBSI software.

So if you're a re-seller looking for first class micro-computer software, contact us today.

mbsi

Micro Business Software, Inc.
Dover Rd., Dept. BY3
Chichester, NH 03263
Phone: (603) 798-5700

off the production line at a rate of 1 every 10 seconds. The Timex Sinclair 1000 will be distributed through over 100,000 retail outlets, starting with computer stores. Timex will also be offering a wide selection of game, educational, personal, Visicalc-like, and business software for the system. Predictions are that there may be as many as 1 million of these units out by the end of next year.

The Timex Sinclair 1000 contains 2K bytes of memory, compared to the ZX81's 1K bytes, and Timex expects to introduce shortly a communications interface and a thermal printer (\$99.95 each). A 16K-byte memory module will be available for \$49.95. Timex also disclosed that a more powerful computer is in the works. Could it possibly use the new flat video screen that Sinclair is developing?

The Sony System: Sony has finally decided to take the plunge and will enter the personal computer market with a Z80-based CP/M system. In a cabinet roughly the same size as that of an Apple II, it contains two of Sony's new 3½-inch floppy-disk drives, 64K bytes of memory, and 32K bytes of ROM (read-only memory) containing Sony-BASIC, which will be very similar to Microsoft BASIC. The basic unit without the drives will cost \$1475. It will have 4 different graphics modes that range from 640 by 400 black-and-white pixels to 640 by 200 color pixels. It will have five slots for optional plug-in accessory cards and numerous other optional features. There will be plug-in options such as a cache 8-inch floppy-disk controller, an IEEE-488 interface, plug-in ROM and keypad interfaces, an 8086 card with 256K bytes of memory (to run either CP/M-86 or MS-DOS) and lots more. The basic unit includes sound, RS-232 and parallel ports, a clock/calendar, and a cassette interface.

Commodore Unveils New Units: Commodore has disclosed that it will soon introduce three new microcomputers: a 16-bit system and two "very low-cost" 8-bit systems. The 16-bit computer will be a dual-processor system using Commodore's new 6509 8-bit microprocessor and Intel's 16-bit 8088. It will have multiprocessing ability, an 80-column display screen, 256K bytes of memory, and dual floppy-disk drives with 680K bytes of storage. All three systems will accept plug-in Z80 or 8088 processors, enabling users to run CP/M-80 or CP/M-86. Prices of these systems should be significantly less than comparable machines currently on the market.

Commodore also disclosed that sales for the first quarter of this year rose to \$82 million, up from \$50 million for the same period last year.

Unix Where Art Thou: Despite advertisements in magazines, publicity releases and articles maintaining that Unix or Unix-like operating systems are available for microcomputers, I have yet to see any multiuser microcomputer systems being shipped (although I have received samples of *single-user* Unix-like systems and am aware that two or three companies have begun shipping these systems). Just what is the problem? It appears that, although it is written in the C language, Unix is still very difficult to convert for use on other systems. Because Unix was written to run on large minicomputer systems such as the DEC PDP-11, it is not easy to make multiuser versions run with decent speed on microcomputers. Therefore, many companies are spending an inordinate amount of time on refinements and optimization of the code.

The result is that we can expect Unix versions with various levels of implementation. The likelihood is that few of the microcomputer

versions will be full implementations of Unix. Keep in mind also that there are several different versions of Unix currently in use in the mini-computer world. Thus there is the question of software compatibility between these different implementations, and application software transportability may turn out to be a serious problem.

It is interesting to note that, until last year, the overwhelming number of Unix users were *internal* to the Bell System; however, since last year, the number of commercial users granted binary licenses and the number of universities granted source licenses have increased. It has been estimated that over 90 percent of the universities in this country have Unix source code licenses.

Software Suppliers Doing Well: To a large extent the software industry is still a cottage industry, but things are changing. Just a few short years ago companies such as Digital Research, Microsoft, Micropro, and Visicorp were "basement" and "spare-room" operations. Today they are large corporations. Digital Research, creator of CP/M, MP/M, CP/Net, PL/I-80 and more, now has over 150 employees and will probably do over \$20 million in gross business this year. Micropro, creator of Wordstar, last year earned \$5.2 million and this year should earn well over \$12 million.

Microsoft, which did not incorporate until July of last year, now has over 125 employees and anticipates a gross revenue of close to \$30 million this year, up from \$15 million last year. Visicorp (previously known as Personal Software Inc.) last year had revenues of more than \$3 million, mostly from its Visicalc program.

Digital Research and Microsoft have already gotten venture capital money, which is usually a precursor to "going public" (offering stock for sale to the public) a la Apple

Computer. Micropro plans to go public before this year is out.

Race for Space: Shelf space is the key to merchandising low-cost personal computer systems, and a battle is developing as personal computer vendors vie for that precious shelf space among mass merchandisers. Texas Instruments (TI), Atari, Commodore, and Nippon Electric Company (NEC) are currently fighting for acceptance by mass-merchandising chains such as J. C. Penney, K-Mart, Sears Roebuck, Woolco, and Montgomery Ward for machines such as the TI 99/4A, Atari 400, Commodore VIC, and NEC PC-6001. Apple is expected to enter the low-cost marketplace this year, and there are even rumors that IBM is developing a low-cost unit. However, Timex with its \$99.95 machine may pull the rug out from under these companies.

The personal computer vendors estimate that over a million machines will be sold in 1983. TI has already had limited success selling systems through J. C. Penney, and Atari through Sears. Other consumer discount chains such as Tech Hi-Fi, Crazy Eddie, and Shack Electronics are also jumping onto the personal computer bandwagon.

The mass merchandisers are looking to use the hardware to draw traffic to sell software and peripherals. They think it might work out like the razor/razor-blade and record-player/record markets, where the profits are in the big aftermarket sales. In the meantime the traditional computer stores have dropped these low-cost products and are concentrating on the business marketplace, where performance, training, and support are important.

Who's on Top? In the traditional personal computer marketplace, the question is frequently asked,

"who is on top?" Apple last year had sales of \$334 million, while Tandy reported computer sales of \$370 million (21.3 percent of the firm's total sales). However, Tandy's figures include sales of its hand-held calculators and the more consumer-oriented Color Computer. IBM is not expected to become a major contender until it broadens out its distribution organization (which should happen soon).

Sales of personal computers are expected to increase by about 60 percent this year over last year and could total \$2.7 billion. Although this year Apple and Tandy are again expected to fight it out for first place, IBM will probably be close behind. Other companies that are expected to carve out sizable chunks of this market are Commodore, Atari, Hewlett-Packard, Osborne, Zenith, Xerox, and NEC. The Japanese firms appear still to be developing their products and setting up their distribution organizations; therefore, they are not expected to become a major force in the U.S. market until late 1983 at the earliest.

What's Doing In Japan?

NEC has introduced its new PC-8801 system in Japan (no word yet as to when the system will arrive in the U.S.) and, contrary to my recent prediction, it is using a Z80-like processor (the NEC μ PD780, the same microprocessor used in the PC-8000). It is software compatible with the PC-8000 and has an enhanced ROM BASIC similar to the IBM Personal Computer BASIC. Further, it has such features as labels, interrupt handling, and special port handling commands. It sells for the equivalent of \$950 in Japan.

The other hot sellers include the Sharp MZ-80C, the new Epson machine, the Toshiba Pasopia, and a fancy living-room system from

Yamaha called the YIS. Hitachi has also introduced a new system called the MB-6891 using the 6809 microprocessor. All the new Japanese systems feature high-resolution (typically 640- by 200-pixel) color graphics.

Changing Disk Scene:

Prices of 5¼-inch Winchester drives are dropping drastically in a price war that is shaking up the industry. Leaders in this battle are Seagate Technology and Tandon Corp., which are quoting large-volume order prices of as low as \$650 per unit. The result is that retail prices are dropping. For example, Apple originally priced its hard-disk option for the Apple III at \$4000. It is now selling for \$2500, and the price should be under \$2000 by year-end.

The first 5¼-inch disk drives typically stored 6 megabytes. Now, however, 10 and 20 megabytes are routine and capacities are expected to be pushed to over 60 megabytes next year. In fact, Micropolis introduced drives storing 25 and 38 megabytes at the recent National Computer Conference show. The company also introduced an 8-inch Winchester hard-disk drive with a capacity of 110 megabytes.

The Japanese are attempting to crack the U.S. hard-disk drive market. They have already shown drives at trade shows and are expected to start shipping units in large quantities soon. It is of real concern to U.S. disk vendors who fear that the Japanese may take over this market as they have the low-cost printer market. The Winchester disk market is expected to be threatened as early as 1984 by the optical disk, which will offer spectacular price and performance advantages.

Personal Robotics:

Last year Jerome Hamlin constructed a robot "butler"

at home. He named it Comro I and persuaded Neiman-Marcus to feature the robot, priced at \$15,000, in its Christmas catalog. The store sold three. Hamlin is now working on a robot kit that he plans to sell for under \$2000.

Heath has already demonstrated a prototype robot kit that it plans to introduce either later this year or next year for between \$1500 and \$3000.

Several companies are already selling computer-controlled arms and bodies in kit form that range in price from \$700 to \$2500, and there are rumors that some toy companies have developed prototypes of true robotic toys that will sell in the \$300 to \$500 price range.

So far, the personal robotics products and projects that have been built are awkward and not very useful, reminiscent of the early personal computers. But more and more experimenters are getting involved in robotics projects, and the likelihood is that we will soon see the fruits of these labors translated into a mushrooming new market.

Phone Set Goes Digital:

Northern Telecom, Richardson, Texas, has introduced an integrated telephone terminal called the Displayphone. Measuring just 11.5 by 14.5 by 8.5 inches and weighing only 13.5 pounds, it allows voice, data, and simultaneous voice and data calls. It has a built-in 7-inch 80-character by 25-line video display and a pull-out keyboard. It uses an 8085 microprocessor, 32K bytes of ROM, 64 bytes of memory with battery backup, and Centronics-type parallel and RS-232 ports.

Not on Speaking Terms:

Consumers are not taking to talking appliances. Sales of microprocessor-con-

trolled appliances appear to be lagging and in some instances are declining. A case in point is the failure of talking microwave ovens. Apparently users, not only in the U.S. but in Japan and elsewhere, don't like to be talked to by a machine. Sales of microwave ovens that tell the user what to do next have been so bad that Mitsubishi Electric recently stopped producing talking ovens sold under the Panasonic and Quasar labels.

Random News Bits:

There's a new game out called Tax Man in which an IRS agent chases a taxpayer through a maze that looks very much like a 1040 form. . . . Bible Research Systems, Austin, Texas, has released "THE WORDprocessor," consisting of eight floppy disks containing the entire King James version of the Bible. An Apple or TRS-80 user can scan and locate biblical references through a series of indexes. . . . Did you know that each year Japan graduates more engineers than the U.S., even though it has half the population?

Quote of the Month:

"Software suppliers are trying to make their software packages more 'user friendly.' The best approach, so far, has been to take all the old brochures and just rubber stamp them with 'user-friendly' on the front cover." Bill Gates, President Microsoft

MAIL: I receive a large number of letters each month as a result of this column. If you write to me and wish a response, please include a self-addressed, stamped envelope.

Sol Libes
POB 1192
Mountainside, NJ 07092

I-Protect™ for eye protection

The only screen shield made with lead to stop x-rays from computer VDT's!

Fact: Current Federal Regulations permit computer terminals, at a distance of 6 cm. from the screen, to emit .5 millirads x-ray radiation per hour ... the old black & white TV standard.

Fact: Computed on a 35 hour work week, that can be the equivalent of a chest x-ray every 12 days, (or 30 chest x-rays each year). A single chest x-ray is 30 millirads ... and radiation is cumulative.

Fact: The **I-Protect™ Screen Shield**, a slightly tinted sheet of leaded acrylic, gives 100% protection from x-rays and most u.v. radiation.

You and your fellow workers may be joining the growing number of computer users complaining of eye fatigue and other problems that seem to be caused by video display terminals used in word processors, stock reporting machines, home computers and video games. If the increase in health problems related to the extended use of VDT's concerns you, LSI offers the solution.

Developed by a physician who was troubled by the amount of radiation his son was absorbing from their home computer, **I-Protect** is made from leaded hi-impact acrylic, similar to that used to shield x-ray machines and protect workers in experimental laboratories.

I-Protect is available from Langley-St. Clair, a leader in

video enhancement systems for the computer industry. It has the lead equivalency of 0.15mm, is slightly tinted to increase contrast and effectively prevents 100% of the x-rays and most of the u.v. radiation from reaching you.

In a recent FDA study,* nearly 10% of the monitors tested showed x-radiation at levels above the current limits of .5 millirads per hour, or 30 chest x-rays per year. While it may be true that when sitting 6 feet from a television screen, very little radiation actually reaches the viewer, daily close work on a video computer terminal can be subjecting you to constant radiation. So, for your protection and your peace of mind, equip your computer with an **I-Protect** screen shield.

Order an I-Protect Screen Shield now... direct from LSI. Call (800) 221-7070. (Be sure to inquire about our "Anti-Flicker Slow-Phosphor" Replacement CRT Tubes for TRS 80 Microcomputers...and about our new leaded screen shield with an exclusive anti-glare polarized surface.)

I-Protect... in two sizes, complete with velcro fasteners for easy attachment to most monitor screens. 8½" x 11" - **\$49.95**
10" x 13" - **\$59.95**. Add \$2.00 for shipping and handling, \$3.00 for C.O.D. New York State residents, add 8.25% sales tax. Allow 2-6 weeks for delivery.

**"Evaluation of Radiation." FDA #81-8153;
U.S. Dept. HEW. NIOSH #78-129, 1977;
U.S. Public Law 90-602; J.E.D.E.C. Publ. 64

For technical information and for West Coast Distributors: (800) 382-3450

In New York state, to order call (212) 989-6876.



●●● Langley-St. Clair Instrumentation Systems, Inc. 132 West 24th Street, New York, N.Y. 10011

Circle 470 on Inquiry card.

What's New?

SYSTEMS



Desktop Unit for Business and Science

The MT500, a desktop computer with data- and word-processing capabilities for business and science applications, is a Multi-Tech Systems product. It features a full DMA (direct memory access) video display, a Z80A microprocessor, the CP/M operating system, 64K bytes of RAM (random-access read/write memory), and a single-board central processing unit with built-in S-100 expansion capabilities. The MT500 has two integral 5¼-inch disk drives with floppy-disk storage capacity of up to 900K bytes and 5¼-inch Winchester disk-storage capacity of 5 megabytes.

Optional equipment for the MT500 includes letter-quality or high-speed printers and Bell 103- or 212A-compatible modems. The price for the MT500 ranges from \$4795 to

\$7995, depending on storage options; dealer discounts are available. Multi-Tech Systems Inc. is located at 82 Second Ave. SE, New Brighton, MN 55112, (612) 631-3550.

Circle 550 on inquiry card.

Development System

Sys-1 from Octagon Systems Corporation is a single-board microprocessor development system and process controller. It operates in BASIC and employs National Semiconductor's INS8073 chip with integral control BASIC interpreter. Sys-1 features 4K bytes of static RAM (random-access read/write memory), up to 4K bytes of EPROM (erasable programmable read-only memory) in 2K-byte increments, hardware-interrupt vectored in

BASIC, a 2K-byte system utilities library, 24 programmable input/output (I/O) lines, 2 flags, 1 sense input, a decoded peripheral-select line, and a large bread-board area with ten 16-pin DIP (dual-inline pin) sockets. Other standard features include an EPROM programmer, a serial RS-232C I/O port that operates at data rates from 110 to 4800 bps (bits per second), and the ability to address 8K bytes of external memory.

An individual Sys-1 costs \$245; OEM (original equipment manufacturer) inquiries are invited. Complete details are available from Octagon Systems Corp., 2849 West 35th Ave., Denver, CO 80211, (303) 458-1705.

Circle 551 on inquiry card.

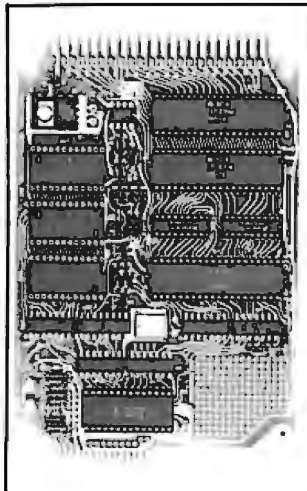

6502 Board Is AIM-Compatible

The Model SBC651 is an AIM-compatible single-board computer from Industrial Micro-Systems. Based on the 8-bit 6502 microprocessor, the 4½-by

6½-inch SBC651 features 40 lines of parallel input/output (I/O), eight channels of 8-bit analog input, an onboard 20 mA current loop, TTL (transistor-transistor logic), and RS-232C serial I/O. Intended for controller and OEM (original equipment manufacturer) applications, the SBC651 has such standard features as four programmable 8-bit parallel ports, eight auxiliary control lines, four 16-bit counter/timers with 1-μs (microsecond) resolution, and a crystal-controlled clock that provides 1 MHz operation. The SBC651 can accommodate from 1K to 3K bytes of RAM (random-access read/write memory) and up to 10K bytes of ROM (read-only memory) and EPROM (erasable programmable ROM).

Peripheral equipment available for the SBC651 includes a device that allows Rockwell International's AIM-65 to fully emulate the SBC651 and provide low-cost development support. Another option is an EPROM burner (programmer) that is used with the AIM-65 as a program-development system. In single units, the board costs \$154.50. Full product specifications are available from Industrial Micro-Systems Inc., POB 306, Plantsville, CT 06479, (203) 628-4844.

Circle 552 on inquiry card.

Super Computer

The Super Computer from the Mega Company is a single-board Z80A-based

What's New?

unit that's guaranteed to run at 5 MHz. It features a 4K-byte system monitor in EPROM (erasable programmable read-only memory), 64K bytes of dynamic RAM (random-access read/write memory), and memory parity checking. Super Computer has a single- or double-density, single- or double-sided 5 1/4- or 8-inch floppy-disk controller, a hard-disk interface that connects directly to Priam Corporation's intelligent hard-disk controller, and a DMA (direct memory access) controller for the floppy disks, serial ports, and general input/output (I/O) interface. Super Computer's two serial ports operate at data rates from 150 to 19,200 bps (bits per second) and are controlled by two Z80A SIOs (serial I/Os) with drivers for full RS-232C handshaking. Other standard features include a Z80A-based counter/timer circuit, sockets for expandability, and CP/M and MP/M operating system compatibility.

Optional equipment for Super Computer includes two 8-bit bidirectional parallel ports with Z80A PIO (parallel I/O), four serial ports with two SIOs and handshaking, 448K bytes of onboard dynamic RAM with a PAL (programmable array logic) chip for either fast RAM disk or bank-switching for multiuser applications under MP/M, and a 9511A mathematics processor. The basic Super Computer system costs \$1099. A full system, including the 9511A, costs \$2199. Dealer inquiries

and purchase orders will be accepted by the Mega Co., 2318 South Park St., Madison, WI 53713, (608) 255-7400. Circle 553 on inquiry card.

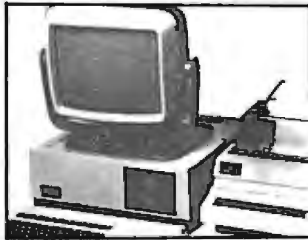

Basis for Expansion

The Basis 200 series of modular microcomputers offers true upward expandability, because the same bus structure supports either 8- or 16-bit plug-in processors. At this time, two models are available: Basis 208 and Basis 216. The 8-bit Basis 208 features the Z80B processor, a 6-MHz clock, and the CP/M operating system. Its minimum configuration has 128K bytes of RAM (random-access read/write memory) expandable to more than 1 megabyte, dual 5 1/4-inch floppy-disk drives, an 8-bit parallel printer interface, a serial RS-232C interface, and a 10-slot card cage with room for additional memory, high-resolution graphics, and other equipment.

The Basis 216 is currently offered equipped with the Z8001 processor, but the 68000 and others are in development. This 16-bit machine features Microsoft's Xenix operating system and the ability to sup-

port up to 16 workstations for multitasking and multiuser environments. Approximate prices are \$6000 for the Basis 208 and \$9000 for the Basis 216. Further information is available from Basis Inc., 23116 Summit Rd., Los Gatos, CA 95030, (408) 438-5804. Circle 554 on inquiry card.

Multiuser, Multitasking Microcomputer

The SB-80/4 microcomputer from Colonial Data Services allows up to four users to share floppy-disk and hard-disk storage, while maintaining separate 4-MHz Z80A microprocessors with 64K bytes of RAM (random-access read/write memory) for each user. This is accomplished by placing all four computers on a single printed-circuit board, connected to a master Z80A multiuser input/output (I/O) controller. The system is CP/M compatible, uses 5 1/4- or 8-inch floppy disks, supports a 10- to 104-megabyte hard disk, takes up to 320K bytes of 200-nanosecond dynamic RAM, and has four Centronics-type parallel ports and six serial ports, two programmable real-time clocks, a switching power supply (115V 60 Hz or 220V 50Hz), and a 50-pin expansion connector. The system is designed to run business software under the CP/M operating system. The multiuser supervisor allows simultaneous users to

share the same database and off-line memory.

For more information on the SB-80/4, contact Colonial Data Services Corp., 105 Sanford St., Hamden, CT 06514, (203) 288-2524. Circle 555 on inquiry card.

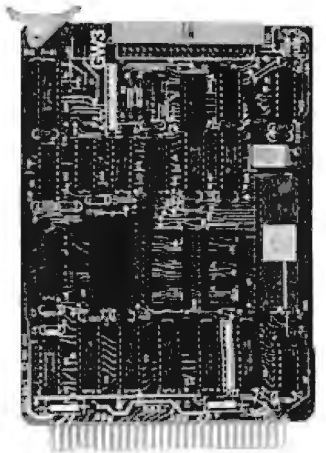

TMS9995-based Computer

The SBC 95/1 is an STD bus single-board computer using Texas Instruments' TMS9995 processor, which is fully object-code-compatible with the TMS990 and 9900 families. The board has two independently configurable asynchronous communications ports for RS-232C and RS-422 interfaces. Also provided are a 5-bit parallel output port, an 8-bit input port, and two software-selectable memory maps. Capable of operating as a stand-alone unit, the 16-bit SBC 95/1 can be equipped with up to 16K bytes of onboard EPROM (erasable programmable read-only memory) and up to 4K bytes of RAM (random-access read/write memory).

What's New?

One option available for the SBC 95/1 is Eyring Research Institute's PDOS program development tool, which consists of a real-time multitasking, multiuser DOS (disk operating system), and PDOS BASIC. Floppy-, mini-floppy-, and hard-disk storage options are supported. In lots of one to nine, the SBC 95/1 costs \$349. An evaluation kit that includes 4K bytes of RAM, an EPROM debugging monitor, connection hardware, and documentation can be purchased for \$624. Contact GW3, 7239 Belinger Court, Springfield, VA 22150, (703) 451-2043. Circle 556 on inquiry card.



Versatile System

Thomas Engineering Company has introduced the TEC MZ-80, a microprocessor-based computer system suitable for communications, word processing, and small-business applications. Built upon Intel's Multibus architecture, the MZ-80 is configured around separate processor, memory, input/output (I/O), and DMA (direct memory access) disk-controller boards that mount on the chassis with four or eight slots. The processor

board contains a 6-MHz Z80B microprocessor, 32K bytes of 150-ns (nanosecond) dynamic RAM (random-access read/write memory), 4K bytes of ROM (read-only memory) or EPROM (erasable programmable ROM) control memory, a 30-millisecond timer, and a serial I/O port. Each additional memory board provides the MZ-80 with 32K bytes of 150-ns static RAM and allows bank switching. The I/O boards have eight independent RS-232C channels and are engineered with an onboard crystal-controlled clock to assure proper timing reference. The DMA disk controller can handle up to four standard single- or double-density 8-inch drives or two 3½-inch mini-floppy drives. Sector size can be as large as 8K bytes.

The list price for a typical ROM-based MZ-80 is \$7435, including software license. The price for a disk-based configuration for use as a local processing system is \$7330. Contact Thomas Engineering Co., Suite 106, 1040 Oak Grove Rd., Concord, CA 94518, (415) 680-8640. Circle 557 on inquiry card.

PUBLICATIONS

Free Business Graphics Guide

A free guide to business computer-graphics software, systems, and services is available from The

Harvard Newsletter on Computer Graphics; Stanley Klein, publisher and editor. The guide contains concise descriptions of source materials and the name, address, and telephone number of each supplier, including contact person. Information on foreign sources is also provided.

To receive your copy, contact the Biz CG Guide, The Harvard Newsletter on Computer Graphics, Service Department, POB 89, Sudbury, MA 01776. Your request must be made on letterhead and accompanied with a self-addressed envelope with \$0.37 postage (\$1.20 outside the U.S.) affixed. The Harvard Newsletter on Computer Graphics is published under the auspices of the Laboratory for Computer Graphics at Harvard University. Circle 558 on inquiry card.

Power of Visicalc

Management Information Source has announced the availability of Robert Williams and Bruce Taylor's book *The Power of Visicalc*. Written in plain English, this book has seven easy-to-follow exercises that are designed to show you how to expand your applications usage of Visicorp's Visicalc program. The *Power of Visicalc* uses specific examples to illustrate the logic of each step in designing an applications program and step-by-step instructions that help you understand the basic concepts behind Visicalc function and command uses.

The Power of Visicalc is available in softcover for \$9.95 from Management Information Source, 1626 North Vancouver, Portland, OR 97227, (503) 287-1462. Circle 559 on inquiry card.



Microprocessor Software Databook

D.A.T.A. Inc. has introduced a new subscription service: *Microprocessor Software D.A.T.A. Book*. Published biannually, the *D.A.T.A. Book* is organized by general type of software package, by the micropro-

cessor upon which it will operate, and by the manufacturer's title. The information covers language and extensions, ANSI (American National Standards Institute) standard, date of introduction, number of in-

What's New?

stallations, memory and peripheral requirements, and available support. Some of the topics covered by D.A.T.A.Book are resident, cross-system, system support, and applications programs.

D.A.T.A. Inc.'s Micro-processor Software D.A.T.A.Book costs \$120. Purchasing information is available from D.A.T.A. Inc., POB 26875, San Diego, CA 92126, (800) 854-7030; in California, (714) 578-7600. Circle 560 on inquiry card.

Newsletter for Pascal Users

Pascal Market News is aimed at current and prospective Pascal language users. This bimonthly newsletter is packed with Pascal hardware and software information, commercial notices, and interviews with personalities in the news. In a recent issue, Pascal Market News explored the use of Pascal in real-time chemical analysis of blood samples at Yale-New Haven Hospital.

Subscribing to Pascal Market News entitles you to discounts on many Pascal-related books and software publications. A year's subscription costs \$20 in North America. Foreign prepaid air-mail subscriptions are \$29, and invoiced subscriptions are \$4 higher. Order from Pascal Market News, POB 5314, Mount Carmel, CT 06518. Circle 561 on inquiry card.

Marine Industry Journal

Floating Point is a quarterly newsletter devoted to the use of computers in the small naval-architectural or boat-design office, small shipyard or boatyard, and on board ships. Its scope covers easily accessible programs for large computers, interactive time-sharing, and programmable calculators as well as personal and small-business computers. Floating Point is produced by the Bay Area Marine Institute, a nonprofit educational corporation engaged in apprenticeship training, continuing education, research, and computer software development for the marine industry.

Subscriptions to Floating Point cost \$5 per year. For a sample issue and further subscription information, contact Bay Area Marine Institute, Pier 66, San Francisco, CA 94107, (415) 552-4500. Circle 562 on inquiry card.

Database Management Tool Explained

A free 12-page brochure describing Micro Data Base Systems' MDBS III micro-computer database-management application development tool is available from ISE-USA. MDBS III innovations, advantages, features, and capabilities, including its flexible query system, are described.

Typical applications are discussed, and a company profile is provided. Obtain your copy from ISE-USA, 350 West Sagamore Parkway, West Lafayette, IN 47906, (317) 463-2581. Circle 563 on inquiry card.

Consumer Newsletter Tests TRS-80 Software

Software Review is a bimonthly newsletter that tests and evaluates programs for Radio Shack TRS-80 Model I and III users. Software Review reports on a program's performance, advantages, and limitations from the user's point of view to help consumers select the products that are best for them. In each issue a wide range of materials are evaluated, including games, business programs, operating systems, utilities, educational programs, and languages. One special feature, the Bug Killer column, provides advice, operating and programming tips, short cuts, fixes, hardware reviews, modifications, and so on.

For a sample copy of the Software Review, send a self-addressed envelope with \$0.37 postage to Software Review, 92 Washington Ave., Cedarhurst, NY 11516. Retailers or computer clubs interested in selling the Software Review can call (516) 374-5193. Circle 564 on inquiry card.

PERIPHERALS



Three-Dimensional Graphics Tablet

Micro Control Systems and Penguin Software have joined together to create Space Tablet, a hardware/software three-dimensional graphics input device for the Apple II. Space Tablet's hardware is made up of a clear 16- by 13-inch two-dimensional workspace and an arm with an elbow that enables it to swivel on the two-dimensional space or rotate above the tablet. Information on the position of the tip of the arm is converted by the computer to X,Y,Z coordinates, making it possible to trace three-dimensional objects, both real and imaginary. The tablet, which connects to the Apple by means of the paddle port, also has two buttons for additional inputs.

Space Tablet's software allows it to be used as a standard two-dimensional tablet or in three dimensions. Its two-dimensional programs include the high-resolution drawing, text, and shape routines available in the Apple Tablet and paddle/joystick ver-

What's New?

sions of that package. The three-dimensional programs expand the input from a choice of coordinates or two-dimensional panels to three-dimensional locations. You can recall any three-dimensional object from memory at any time, display it on the Apple's screen, rotate it on any axis, and scale and edit it.

The Space Tablet costs \$475. A slightly different version is produced for the IBM Personal Computer. It costs \$595. Contact Micro Control Systems, 230 Hartford Turnpike, Vernon, CT 06066, (203) 643-4897. Circle 565 on inquiry card.

TRS-80 Data Acquisition and Control

The 8882 data-acquisition and control system from Starbuck Data Company is designed for Radio Shack's TRS-80 Models I and III. The device has eight digital inputs, eight digital outputs, eight 0- to 5-volt analog inputs, two analog joystick ports; all inputs and outputs are fully protected. Supplied software permits high-speed data acquisition of up to 4000 points per second and up to 30 points per second for low-speed acquisition in the interrupt mode. In the interrupt mode, the 8882 allows all data acquisition and control to be timeshared with normal TRS-80 use.

The 8882 data-acquisition and control system for the TRS-80 costs less than \$200, including software. Complete product and purchasing information is available from Starbuck Data Co., POB 24, Newton Lower Falls, MA 02162, (617) 237-7695. Circle 566 on inquiry card.

Apple PROM Development System

A PROM (programmable read-only memory) development system for the Apple II is available from Vista Computer Company. This system simulates PROM in RAM (random-access read/write memory), allowing new code to be tested and modified within the computer before the PROM is burned in. Supplied with a disk-based, menu-driven program-development monitor, the system has onboard memory that can be directly loaded from assembler or disk. Other standard features include a data and address interface for operator location and control.

The Vista Computer PROM development system simulates and programs most standard PROMs, including 2K- and 4K-byte EPROMs (erasable PROMs) such as 2708, 2716, and 2532 types. The system costs \$495. Further details are available from Vista Computer Co., 1317 East Edinger, Santa Ana, CA 92705, (714) 953-0523. Circle 567 on inquiry card.



Acoustic Data Coupler

The Anderson Jacobson AJ 1233 acoustic data coupler is capable of communicating with Bell 212-type modems. The AJ 1233 is an originate-only full-duplex acoustic coupler with switch-selectable data rates of 1200 bps (bits per second) for synchronous or asynchronous communications and from 0 to 450 bps for asynchronous communications. It can be used either as an acoustic coupler or as a modem, and it can communicate with VA 3400 and AJ 1200 series modems and in Bell 103 or 113 modes.

The microprocessor-controlled, Federal Communications Commission-approved AJ 1233 costs \$995. Complete details are

available from Anderson Jacobson Inc., 521 Charcot Ave., San Jose, CA 95131, (408) 263-8520. Circle 568 on inquiry card.

Analog I/O Interface

International Aerospace Products' Model ADA 8/4 AP analog input/output (I/O) interface board is designed for the Apple II. It's equipped with eight A/D (analog-to-digital) input channels, four D/A (digital-to-analog) output channels, screw-activated terminal strips for I/O connections, voltage-follower buffers on A/D inputs, V_{REF} output for ratiometric transducers, and buffers on D/A outputs. It's compatible with any language, such

What's New?

as BASIC, that allows direct addressing of specific memory locations.

The ADA 8/4 AP plugs in any Apple II I/O slot except slot 0. Complete specifications are available upon request from International Aerospace Products Inc., POB 166, White Marsh, VA 23183.

Circle 569 on inquiry card.

Color Port

The Color Port from Maple Leaf Systems gives your Radio Shack TRS-80 Color Computer powerful input/output capabilities. The plug-in cartridge Color Port gives the Color Computer two fully programmable 8-bit bidirectional parallel ports with full handshaking. It supports full interrupt capability and computer voltage and logic control lines are brought out to the standard edge connector. Additionally, the cartridge has a socket for 2K bytes of RAM (random-access read/write memory) or EPROM (erasable programmable read-only memory).

Optional equipment for the Color Port includes 2K-byte RAMs and 2K-byte EPROMs. With documentation, the Color Port cartridge without memory costs \$129.95. The optional RAM is available for \$19.95, and the EPROM costs \$12.95. All can be purchased from Maple Leaf Systems, POB 2190, Station C, Downsview, Ontario M2N 2S9, Canada. Circle 570 on inquiry card.



Glitch Sentinel Has Built-In Printer

The Model GS-2 Glitch Sentinel power-line monitor from Billings McEachern diagnoses power problems for microcomputers, disk drives, and other sensitive electronic equipment. The Sentinel checks for power failures, low and high line voltages, spikes, voltage drops, high-frequency noise, and high and low line frequencies. Built-in features include a clock/calendar, a user-enabled audible alarm, latched LEDs (light-emitting diodes) for each alarm type, and a printer that prints alarm messages in English.

In addition to the Model GS-2, Billings McEachern offers the GS-1 and the GS-3 Glitch Sentry power-line monitors. The GS-1 is similar to the GS-2, but it does not have the printer, clock/calendar, and the

line-frequency monitoring capabilities. The GS-3 is designed for three-phase power monitoring.

In single units, the Model GS-2 Glitch Sentinel and the Model GS-3 cost \$900; in lots of two to ten, the price is \$750. A single GS-1 costs \$300, and two to ten units are available for \$250 each. Order directly from the manufacturer, Billings McEachern Inc., Suite 106, 333 Cobalt Way, Sunnyvale, CA 94086, (408) 746-0830.

Circle 571 on inquiry card.

Apple Time II

Time II, an Applied Engineering product, is a real-time clock/calendar for the Apple II computer. Time II tells time in hours, minutes, and seconds with program-selectable 24-hour

military or 12-hour (with a.m. and p.m. indication) formats. It tells you the date with year, month, date, day of week, and leap year information. **Standard** features include rapid date and time setting, crystal-control for 0.0005% accuracy, latched input/output ports for easy PEEK and POKE BASIC programming, and an onboard battery backup that provides power-off operation for more than four months. With Time II, you can call up schedules, time events, and date listings and other printouts because its **DIP-(dual-inline package)** switch-selectable interrupts permit foreground and background operation of two programs simultaneously.

Time II is supplied with a 16-sector DOS 3.3 disk with Time II programs and a 23-page operating manual that contains many example programs to use with your Apple II. The price is \$129. Contact Applied Engineering, POB 470301, Dallas, TX 75247, (214) 492-2027.

Circle 572 on inquiry card.

SOFTWARE

Stock and Commodities Messenger

George Arndt's Investors' Micro Messenger (IMM) is made up of a group of investors who pool their expertise to develop stock- and commodities-management software for the Apple II. As an IMM

What's New?

member, you receive annually four packages containing floppy disk-based software, updated commodity database, a detailed instruction book written in nontechnical language, complete documentation and reports, and graphics software that allows you to see buy-and-sell calls with daily open, high, low, and close. Opportunities to purchase technical trade books are also offered.

The IMM membership fee is \$995 for the first year and \$350 for the second year. Members receive \$100 for each program donated to IMM. Complete details are available from George Arndt, CTA, Investors' Micro Messenger, POB 319, Harvard, MA 01451, (617) 456-8830. Circle 573 on inquiry card.

Atari BASIC Tutorials

Santa Cruz Educational Software's Tricky Tutorials are designed to help sharpen your Atari BASIC programming skills. Each tutorial in the six-disk package consists of a discussion in plain language and examples already entered and running. The topics covered are Display Lists, Horizontal and Vertical Scrolling, Page Flipping, Basics of Animation, Player Missile Graphics, and Sounds and Music.

Tricky Tutorials are available on tape or disk in a single package for \$99.95 plus \$3 for shipping and handling. They require

16K- to 32K-byte tape-based Ataris or 24K- or 32K-byte Ataris with disk drives. Order Tricky Tutorials from Santa Cruz Educational Software, 5425 Jigger Dr., Soquel, CA 95073, (408) 476-4901. Circle 574 on inquiry card.

Strategy Game

Automated Simulations' Ricochet is a strategy game combined with fast-action graphics. It can be played with another player or any of four different computer opponents. Here's how it works: players maneuver blocks to set up a shot at the opposing goal and to protect their own goal. Each contestant has two launchers to fire. Shots ricochet off the blocks, earning points for each hit plus bonus points for hitting the opponent's goal. Before victory can be claimed, a player must win two of three (or three of five) games.

Ricochet is available on cassette for 16K-byte Atari 400/800s equipped with the BASIC ROM (read-only memory) cartridge and 16K-byte Level II TRS-80s. On disk, the game can be enjoyed on 32K-byte Atari 400/800s, 32K TRS-80s with the TRSDOS operating system, and 48K-byte Apples with Applesoft in ROM. The suggested retail price is \$19.95. Contact Automated Simulations, POB 4247, Mountain View, CA 94040. Circle 575 on inquiry card.

Solar Design Programs

Version 2.0 of Solarsoft's Sunpas, Sunop, and Tswing interactive solar-analysis programs for 48K-byte Apple II Plus computers is now available. Given both the solar input and the load on the building, Sunpas and Sunop estimate the yearly auxiliary heating requirements of a passive solar building. Both programs are based on Los Alamos National Laboratory's Solar Load Ratio Method, which is described in volume two of the *Passive Solar Design Handbook* (available for \$30.50 from National Technical Information Service, 5285 Port Royal Rd., Springfield, VA 22161). With documentation, Sunpas and Sunop cost \$250 each or \$400, if purchased together.

Tswing is a nodal-analysis thermal-simulation program that helps predict temperature swings in a building. It is useful for sizing mass and glazing areas to prevent overheating. Tswing makes extensive use of graphs to supplement hard-copy printouts of data. Provided with Tswing is Solgain, a clear-day solar-insolation routine to calculate incident and transmitted hourly solar gains. Tswing costs \$395, including a 60-page manual.

Sunpas, Sunop, and Tswing can be purchased as a three-program package for \$700. Yearly subscriptions to an updating service are available for \$75, and users manuals

without software may be obtained for \$25. Get additional details on these programs from Solarsoft Inc., POB 124, Snowmass, CO 81654, (303) 927-4411. Circle 576 on inquiry card.

PILOT for CP/M

Owners of CP/M-based computers can now run the Nevada PILOT language, thanks to Ellis Computing. A string-oriented language, Nevada PILOT is designed for interactive applications such as data entry, programmed instruction, and testing. Among its many features are an integrated full-screen text editor and the ability to drive video-tape recorders, voice-response units, and other optional equipment. With Nevada PILOT, someone with no prior computer experience can develop dialog programs in an hour or so. Nevada PILOT meets all PILOT-73 standards.

Nevada PILOT requires 32K bytes of RAM (random-access read/write memory), one disk drive, a video display and keyboard. It will run on TRS-80, North Star, Superbrain, Micropolis, Vector, Softcard-equipped Apples, and many other CP/M-based systems. Nevada PILOT costs \$149.95, which includes a floppy disk and a manual, and is available from Ellis Computing, 600 41st Ave., San Francisco, CA 94121, (415) 751-1522. Circle 577 on inquiry card.

What's New?

Flexible Changes

The Flex 9.0 DOS (disk operating system) for Radio Shack's TRS-80 Color Computer is available from Technical Systems Consultants (TSC), 111 Providence Rd., Chapel Hill, NC 27514. Occasionally, changes to TSC-supplied utility programs are required to avoid memory conflicts with the BASIC ROMs (read-only memories). These changes and an implementation guide can be obtained from South East Media, POB 794, Chattanooga, TN 37443.

Circle 578 on inquiry card.

Wiremaster 4.02

Afterthought Engineering has released version 4.02 of its Wiremaster software tool for the design, layout, and construction of electronics hardware. Wiremaster generates network maps, wire lists, cross-references, and checklists. It can handle large industrial jobs as well as small prototypes and hobby projects. Version 4.02 enhancements include location accuracy of 0.001 inch, provisions for twisted-pair and coaxial wiring, and input language expansions that handle special components such as connectors.

Wiremaster version 4.02 costs \$200; computer club members are eligible for a 50% discount. Updates to earlier versions are priced at \$25. Complete details can be obtained from After-

thought Engineering, 7266 Courtney Dr., San Diego, CA 92111, (714) 279-2868. Circle 579 on inquiry card.

TRS-80 Game System

The Adventure System has all the necessary ingredients you need to cook up adventure-type games on your Radio Shack TRS-80 Model I or III. Offered by The Alternate Source, the Adventure System consists of an editor that compiles a command language into an adventure database and a driver program that executes the database. A manual documenting the Adventure Language syntax and a complete analysis of a small adventure is provided. Two full adventures are also supplied with the System.

The Adventure System requires a 48K-byte TRS-80 Model I or III with disk drives. It is available on formatted disks for \$39.95. Purchase orders are being fulfilled by The Alternate Source, 1806 Ada St., Lansing, MI 48910, (517) 487-3358.

Circle 580 on inquiry card.

Disk Recovery System

DPatch 1.3 is a CP/M- and MP/M-based disk recovery and reliability system from Advanced Micro Techniques. It gives you the ability to recover files that contain input/output

errors and to regain the use of disks that have error tracks. With DPatch, files that have been erased from the disk directory may be recovered. Additionally, you can extract data from files that are no longer readable under normal circumstances. Damaged or unreadable disks can be returned to normal using DPatch's Surface Analysis, which analyzes and locks out damaged areas.

DPatch is distributed in most popular disk formats and has a suggested retail price of \$195. The manufacturer invites dealer and OEM (original equipment manufacturer) inquiries. Complete specifications are available from Advanced Micro Techniques, Suite 209, 1291 East Hillside Blvd., Foster City, CA 94404, (415) 349-9336. Circle 581 on inquiry card.

Bigbug Squashes Debugging Delays

Future Project Corporation has developed Bigbug, a Z80 monitor for controlling Radio Shack TRS-80 Model I Level II assembly-language programming. The device features a ROM- (read-only memory) based monitor that doesn't need a backup, direct access of input/output, a hexadecimal calculator, built-in RS-232C driver software, up to eight user-selectable breakpoints, and the ability to produce hard-copy printouts for debugging history. Bigbug can be

treated as a subroutine from your programs, and its hardware can accept your own EPROM (erasable programmable ROM), which can save you loading time. Other features include 3K bytes of memory that permit a target program to be resident anywhere in memory.

Bigbug costs \$75. Further details are available from Future Project Corp., POB 11, Hawleyville, CT 06440, (203) 775-3062. Circle 582 on inquiry card.

Superfile System

FYI Inc. has introduced Superfile, an indexing and file-retrieval system for text entries of any size. The system can handle more than 7000 entries per database on 8-inch single-density disks or 2500 entries per database on 80K-byte 5¼-inch disks. Superfile can search as many as 100 entries per second, and up to 65 keywords can be combined with AND, OR, and NOT in a single search. Superfile lets you direct output to the screen, printer, or disk, and it does not limit the amount of text per entry or the number of data disks per database. Additionally, Superfile can access up to 16 floppy- or hard-disk drives.

Superfile runs under the CP/M operating system on Z80-based processors. Available on 8-inch and most 5¼-inch disks, Superfile costs \$195, which includes a demonstration database, installation pro-

What's New?

MISCELLANEOUS



Micromonitor

MK Enterprises' Micromonitor MX2100 Teleprocessor is a 3- by 5- by 1½-inch device that can connect your microcomputer to the Bell Telephone Network. The Micromonitor is a DTMF (dual-tone multifrequency) transceiver/coupler outfitted with parallel input/output, two 600-ohm audio channels, ring and off-hook signaling circuitry, a retriggerable circuit that signals the presence of a conversation, and circuitry that monitors the status of the telephone trunk (i.e., dial tone, ringing, busy, etc.). Two on-board optoisolators can control your equipment by means of Touch-Tone (a registered trademark of AT&T) commands. The Micromonitor's Touch-Tone transmitter allows outward dialing in PABX (private automatic branch exchange) applications, in-

cluding automatic redial and speed dialing, while its companion Touch-Tone receiver permits end-to-end signaling for remote data entry. When used with a microprocessor or an intelligent controller, the Micromonitor is capable of performing sophisticated functions such as telephone call accounting, information retrieval, radio-telephone paging, and remote security monitoring.

Certified by the Federal Communications Commission, the Micromonitor is compatible with Apple, STD bus, and many single-board computers. It costs \$495, including a manual. Additional operating specifications are available from MK Enterprises, 8911 Norwick Rd., POB 29654, Richmond, VA 23229, (804) 740-8380.

Circle 585 on inquiry card.

gram, and a user's manual. Orders for the Superfile indexing and retrieval system are being accepted by FYI Inc., POB 10998 #615a, Austin, TX 78766, (512) 258-6310.

Circle 583 on inquiry card.

Statistics Package

Questionnaire Service Company's Statistical Package for Microcomputers (SP-Micro) is based on SPSS Inc.'s Statistical Package for Social Sciences. It features variable and value labels, long variable names, missing values, and English-language error messages. Built-in print routines are programmed for an 80-column printer and include controls for page length. Among the procedures implemented in SP-Micro are frequency distribution with optional histogram, cross-tabs (includes chi-square), Pearson correlation with an optional covariance table, and multiple regression with block-wise or step-wise inclusion levels.

SP-Micro requires a TRS-80 Model II or a North Star computer, the CP/M operating system, and CBASIC2. The manufacturer recommends a minimum of 48K bytes of memory and two disk drives. SP-Micro costs \$250, including a manual, which is available separately for \$5. SP-Micro can be ordered from the Questionnaire Service Co., POB 23056, Lansing, MI 48909.

Circle 584 on inquiry card.

Monolithic Dual 8-Bit D/A Converter

Analog Devices has introduced the AD7528, a monolithic dual 8-bit D/A (digital-to-analog) converter. With both converters on the same chip, and with the use of a common data bus to load either D/A register, Analog Devices engineered the dual D/A converter in a 20-pin DIP (dual-inline package). The AD7528 has onboard data latches and a microprocessor interface. Each of the AD7528's D/A converters has its own reference input, which eliminates the need to test and select D/A converters in most applications where precise matching is required.

The AD7528 monolithic dual 8-bit D/A converter is available in various grades for industrial and military applications. Complete grade descriptions and product information can be obtained from Analog Devices, Route 1 Industrial Park, POB 280, Norwood, MA 02062.

Circle 586 on inquiry card.

Data Line Tester

Warren Instrotech's portable W-DLT (data-line tester) can identify seven commonly used RS-232C data lines and show the likely cause of a connection problem. It's provided with a switch that enables it to function as a Null Modem, which is used to interconnect two terminals, modems, or com-

What's New?

puters without rewiring cables. In the Null Modem mode, any standard device can communicate with other devices by means of one standard type of cable.

The W-DLT comes with a full set of instructions and a one-year warranty. It costs \$59.95; quantity and dealer discounts are available. Contact Warren Instrotech Ltd., POB 4500, Ogdensburg, NY 13669; in Canada, POB 5739, Station F, Ottawa, Ontario K2C 3M1, (613) 728-9120. Circle 587 on inquiry card.

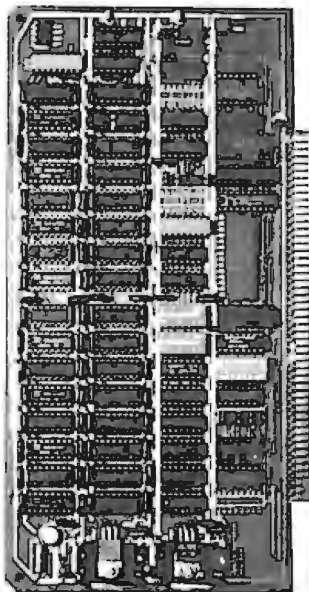

S-100-based Dynamic RAM Board

Sonics Research Corporation recently introduced a low-cost S-100-based 64K-byte bank-selectable dynamic RAM (random-access read/write memory) board. The board provides continuous memory refresh during system resets and long wait states, true bank-selectability in 16K-byte levels, switch-

selectable port assignments, and compatibility with most Z80-based S-100 systems, including Cromemco, North Star, Vector Graphic, TDL, and SD Systems. Other features include the ability to assign 16K-byte banks to any of four locations within the 64K-byte address space and the ability to enable and disable 16K-byte banks under software control. Power requirements are 6½ watts.

The Sonics Research 64K-byte dynamic memory board has a suggested retail price of \$450, assembled and tested. Further information is available from Sonics Research Corp., Suite 505, 1500 Northwest 62nd St., Fort Lauderdale, FL 33309, (305) 776-7177. Circle 588 on inquiry card.

Hug Your Office Equipment

The Huggy System can protect your office equipment from theft. Conventional tools cannot remove the Huggy System's "Tuf-nut," yet removal does not require special tools.

The Huggy System number 101 will secure a single piece of equipment. It's available in kit form for \$10.95. The master Huggy System service kit, number 1020, secures up to 12 machines and is available for \$89.50. Contact the Huggy System, 2660 West Chester Pike, Broomall, PA 19008, (800) 345-1280; in Pennsylvania, (215) 359-1004. Circle 589 on inquiry card.



Hide Your Cables and Wires

Designatron's Organizer places your Radio Shack TRS-80 Model I's components into a single desktop package, hiding the wires and cables. The Organizer is made up of two wood-grain cabinets. The first cabinet, which has a removable front panel for easy rebooting, holds the monitor, expansion interface, power supplies, line

filters, power strip, and fan. The second cabinet can hold up to four disk drives, a tape recorder, fan, floppy disks, and cassettes.

The Organizer costs \$87.50, plus \$8.75 shipping and handling. Orders are being accepted by Designatron, 2794 Hume Rd., Malibu, CA 90265, (213) 456-9023.

Circle 590 on inquiry card.

Align Disk Drives Without a Scope

The Lynx-300 from Lynx Design & Technology lets your field-service personnel make all necessary floppy-disk alignment adjustments without an oscilloscope. The Lynx-300 comes with a color-coded set of probes, which attach directly to a drive's printed-circuit board, and with a series of LEDs (light-emitting diodes) to indicate the proper settings for radial and index/sector ad-



justments and to indicate if the adjustment is not within specifications. The Lynx-300 is powered directly from the drive.

The Lynx-300 comes with a zippered leatherette case and is priced at \$394

What's New?

(U.S. funds) and \$475 (Canadian funds). For complete specifications, contact Lynx Design & Technology Inc., 3880 Chesswood Dr., Downsview, Ontario M3J 2W6, Canada, (416) 638-4875.

Circle 591 on inquiry card.



Products for HP Users

The Hand Held Products Division of F.M. Weaver Associates produces a wide range of products and services for HP (Hewlett-Packard) users. The HHP-16K EPROM (erasable programmable read-only memory) is one such product. It gives HP-41C and -41CV calculator users cost-effective application program storage. The HHP-16K, basically a ROM (read-only memory) emulator, can hold 4K- or 8K-byte programs for storage, or it can hold up to 16K-byte programs, depending on the selection of EPROMs. The HHP-16K costs \$241.

Other products offered include the HHP-41DS user development system and the BURN software program for the HP-85 SDS-II computer. The BURN program is available for a one-time lease fee of \$495. The

Hand Held Products Division will convert to EPROM storage programs stored on magnetic cards or Hewlett-Packard development system tape or disk. The price for this service ranges from \$50 for a 4K-byte program to \$100 for a 16K-byte program. For more information, contact F.M. Weaver Associates Inc., Hand Held Products Division, 6201 Fair Valley Dr., Charlotte, NC 28211, (704) 377-3841. Circle 592 on inquiry card.

Floppy-Disk Controllers

Western Digital Corporation has introduced the FD176X family of 5¼-inch floppy-disk controllers that provides all the features of its industry-standard FD179X family. The FD176X family operates at 1 MHz and is fully compatible with existing minifloppy-disk designs using the FD179X standard. Aimed at soft-sectored systems equipped with automatic track seek with verification and providing DMA (direct memory access) or programmed data-bus transfers, the FD176X family supports single- or multiple-sector reads or writes with automatic sector search in both modes, or it can read and write an entire track. Currently, Western Digital has four members in the family: the FD1761, -63, -65, and -67, which cover all combinations of single- or double-density, true or inverted

data bus, and single- or double-sided drives. The FD176X family can be used with single-density IBM 3740 or double-density IBM System/34 formats.

In production quantities, the FD176X family is available in ceramic or plastic

packages for 40-pin devices for \$36 and \$25.30, respectively. Full product information and applications assistance can be obtained from Western Digital Corp., 2445 McCabe Way, Irvine, CA 92714, (714) 557-3550. Circle 593 on inquiry card.



Keyboard Guard

Plexa-Lok from Last Electronics guards your Apple II keyboard from contaminants and curious fingers. Made of clear 0.080-inch-thick acrylic, Plexa-Lok slips up and over the keyboard, then snaps into position. It

does not affect air circulation.

Plexa-Lok comes with a 60-day warranty and costs \$19.95, postpaid. Contact Last Electronics, POB 1300, San Andreas, CA 95249, (209) 754-1800. Circle 594 on inquiry card.

Where Do New Products Items Come From?

The information printed in the new products pages of BYTE is obtained from "new product" or "press release" copy sent by the promoters of new products. If in our judgment the information might be of interest to the personal computing experimenters and homebrewers who read BYTE, we print it in some form. We openly solicit releases and photos from manufacturers and suppliers to this marketplace. The information is printed more or less as a first-in first-out queue, subject to occasional priority modifications. While we would not knowingly print untrue or inaccurate data, or data from unreliable companies, our capacity to evaluate the products and companies appearing in the "What's New?" feature is necessarily limited. We therefore cannot be responsible for product quality or company performance.

General Software

Mailing Address:
1454 S. 25th St.
Terre Haute, IN 47803
WE HONOR
VISA and MASTERCHARGE

TOLL FREE - Outside Indiana
1-800-457-0517
ORDER DESKS
(812) 234-9421

Best Selection Best Service

Write for our famous CATALOG. Contains many items not in ad. Still only \$1.00 (refund with purchase) Outside US add \$10 plus Air Parcel Postage. Add \$3.50 postage and handling per each item. Indiana residents add 4% sales tax. Allow 2 weeks on checks. COD add \$3.00 per item. Prices subject to change without notice. All items subject to availability.

	Disk with Manual	Manual Only
ARTIFICIAL INTELLIGENCE		
Dental (PAS-3)	\$849/40	
Medical (PAS-3)	\$849/40	
BYROM SOFTWARE		
*BSTAM	\$149	
*BSTMS	\$149	
DIGITAL RESEARCH		
CP/M		
2.2 Intel MDS-800	\$149/25	
Northstar (Horizon)	\$149/25	

Micropolis	\$169/25
TRS Model II	\$159/35
CB-80	\$459/35
CBasic2	\$ 98/20
Pascal MT + Compiler	\$429/30
SPP	\$316/20
SPP Only	\$140/15
FRIENDS	
ACCESS 80 I	\$249/50
ACCESS 80 II	\$429/50
FRONTIER SOFTWARE	
Professional	
Time Accounting	\$549/40
General Subroutine	\$269/40
Application Utilities	\$439/40
ISA	
Spellguard	\$229/25
SP/Law	\$109
PASCAL LANGUAGE	
Pascal Z	\$349/30
Pascal MT + V5.5	\$429/30
Compiler	\$316/20
SPP Only	\$140/15
KEY BITS	
Wordsearch	\$179/50
String 80	\$ 84/20
String 80 (Source)	\$279
String Bit	\$ 65
MICRO AP	
Selector IV	\$269/35
Selector V	\$469/50
SBasic	\$269/25
MICRO TAX	
*Level I	\$249
*Level II	\$995
*Level III	\$749
*Combo II + III	\$1495
Microsoft 5.3	49
Run time module	
MICRO PRO®	
Wordstar	\$309/60
WS Training Guide	20
WS Custom Notes	\$429/na
MailMerge	\$109/25
WS-Mailmerge	\$419/85
Datastar	\$249/60
DS Custom Notes	\$429/na
Calstar	\$259/na
Supersort I	\$199/40
Spellstar	\$175/40
MICROSOFT	
Basic-80	\$298
Basic Compiler	\$329

Fortran-80	\$349
Cobol-80	\$629
M-Sort	\$124
Macro-80	\$144
Edit-80	\$ 84
MuSimp/muMath	\$224
MuLisp-80	\$174
ORGANIC SOFTWARE	
*Textwriter III	\$111/25
*Datebook	\$269/25
*Milestone	\$269/30
PACIFIC SOFTWARE	
Sequitur	
Onyx, Plexus	\$3495/NA
PDP-11	\$5000/NA
PEACHTREE® SOFTWARE	
General Ledger	\$399/40
Accounts Receivable	\$399/40
Accounts Payable	\$399/40
Payroll	\$399/40
Inventory	\$399/40
Mailing Address	\$399/40
for P5 Version	add \$119
Series 6-Peachtree	
CPA	\$799/40
Property Mgt	\$799/40
Passive Payroll	\$449/40
Series 7-Peachtree	
Sales Tracker	\$3049/55
AR-Sales Analysis	\$1299/50
Inventory	\$799/40
Order Entry	\$699/40
SOHO GROUP	
Matchmaker	\$ 97/20
Worksheet	\$177/20
SORCIM	
*Pascal/M 280	\$349/40
Pascal/M 86/88	\$449/40
*Act 65	\$149/20
*Act 68	
*Act 69	
*Act 86/88	\$149/25
*Trans 86	\$119/25
*Supercalc	\$269
SOUTHERN COMPUTERS	
*Raid	\$224/35
*Raid FP	\$349/35
*FFP	\$224/15
*Recover	\$ 75
*RADAR	\$449/25
ISIS	\$224/20

STRUCTURED SYSTEMS GROUP	
GL, AR, AP, PR, OE	\$849/40
Call for others	
SUPERSOFT	
*Diagnostic II	\$ 84/20
*Forth	\$149/30
*SSS Fortran	\$219/30
*Fortran w/RATFOR	\$289/35
*C Compiler	\$175/20
*Disk Doctor	\$ 84/20
*Term I	\$129/25
Term II	\$169/25
Z8000 Assembler	\$449/35
Others less 10%	
WHITESMITHS	
C Compiler	\$700/40
Pascal (incl C)	\$900/45
Cross Compiler 8080/Z80 host	
Target M68000, PDP11, 11/70, VAX	\$1400/50
IBM PERSONAL COMPUTER	
Wordstar 3.0	\$309/60
Mailmerge	\$109/25
Supercalc	\$269/NA
Visicalc (256K)	\$229/NA
Optimizer	\$200/NA
CP/M-86	
Supersoft C	\$500/NA
Pascal MT + 86 w/SPP	\$730/NA
CBasic-86	\$299/NA
SuperCalc	\$369/NA
SuperSoft C Compiler	\$450/NA
Wordmaster	\$Call
MISCELLANEOUS	
*dBASE II	\$575/50
Plan-80	\$269/30
*Fabs (B-Tree)	\$159/25
Ultrasort	\$159/25
*Super vvx	\$ 89/15
*Micro B+	
(Specify Language)	\$229/20
*Mini Model	\$449/50
*Spellbinder	\$349/45
*Statpak	\$439/40
*"The Word"	\$ 75
*Lynx	\$199/20
Mfg. Inventory and Control Program	
T1990, 300 Meg. storage required	
Distributed in Cobol object code	
Call for info.	\$20000/NA
Write for catalog (\$1.00) and other listings	

* Available for Apple with Softcard

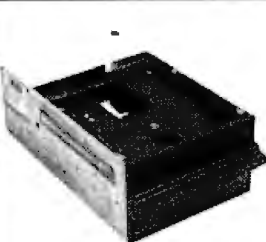

FLOPPY DISK DRIVES

SPECIAL!!!!!! QUME DATATRAK 8

Virtually the industry standard. High quality/reliability. Full featured, double sided, double density.

Tandon TM 848 \$545

\$525 quantity 1, \$499 quantity 2 up.

TANDON DOUBLE SIDED, DOUBLE DENSITY MINIS

TM100-2 48 TPI (500 KBYTES) \$325
Compatible with Northstar, Cromemco, TRS-80

TM100-4 96 TPI (1000 KBYTES) \$425
Compatible with Zenith, Heath, etc.

TANDON 5 1/4" HARD DISKS

TM 602 (5MB) \$1195
TM 603 (10MB) \$1295

CONTROLLERS

Tarbell single density kit	\$195
Tarbell single density A & T	\$310
Tarbell double density A & T	\$425
CCS 2422 w/CPM 2.2	\$350
Godbout Disk 1	\$450
MDA MXV-21 LSI-11 controller (RX-01, RX-02 compatible)	\$1050

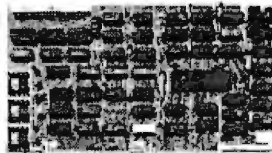

MISCELLANEOUS

2 Disk drive enclosure \$ 95 (fits Siemens, Shugart, Qume)	Cable Kits 2 drives \$ 35
CP-206 power supply \$110 (powers two floppies)	3 drives \$ 40
	4 drives \$ 45
	Diskettes ss \$39/10 — ds \$59/10
Mini-Enclosure with power supply	
1 drive \$ 85	
2 drives \$120	

CPU

CCS 2810	\$ 275
Godbout Z-80A	\$ 275
Godbout 8085A	\$ 295

MEMORY

CCS 2065 64K dynamic	\$ 595
CCS 2116 32K static	\$ 625
Godbout RAM 17 64K	\$ 675

I/O

CCS 2710 4 SIO	\$ 325
Godbout Interfacer 1	\$ 225
Godbout Interfacer 2	\$ 225

NEW !!!!

Qume Sprint 9 DAISY WHEEL PRINTER .. \$2395

45 CPS, R/O. Available in KSR version.

Call for further particulars.

Ribbons: \$125/case

Bidirectional tractor feed \$225

NEW !!!!

ABM 85 Video Terminal .. \$ 895

— Detachable keyboard

— Televideo 920, ADM 3A compatible

— High resolution green phosphor (23 MHZ)

— Extra multi-bus or S-100 slot for stand-alone capability

Terms of sale: cash or checks, MC/VISA. Min. order \$25. CA residents add 6% tax. Prices subject to change without notice. All goods subject to prior sale.

Electrolabs

POB 1608, Palo Alto, CA 94302 (415) 965-7040

Your TRS-80 video screen will come to life.

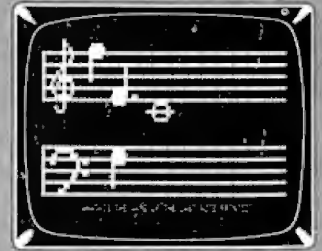
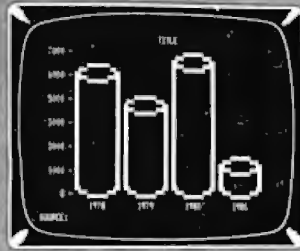
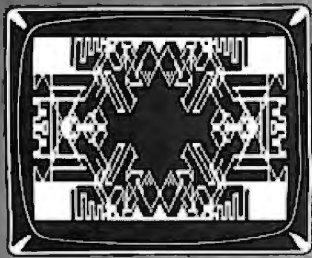

Bring your TRS-80 computer's video screen to life with the many striking graphics displays and functional programming techniques presented in this exciting and easy-to-follow new book!

Beginning with the basics, the authors introduce you to the tools of computer graphics, including the capabilities of the video screen, keyboard and character control, and graphics programming techniques such as concatenation, looping, and using subroutines and strings. The real fun begins as you learn how to create vivid displays ranging from business charts and mathematical function plots to dragons and lions, laser cannons, beautiful artistic designs, and a unique animated figure called Critter. Complete program listings and suggestions for modifications accompany each of the more than 100 graphic displays.

Besides providing guidance to those interested in specific applications, this book also serves the novice as an excellent introduction to programming in BASIC and machine language.

Written in a witty, readable style and complemented by over 100 detailed illustrations, *TRS-80 Graphics for the Model I and Model III* is both a thorough guide and an invaluable reference for anyone interested in the exciting field of computer graphics.

ISBN 0-07-033303-3

288 pages

Softcover

Illustrated

Price \$12.95

Prepayment is required.

Please add \$1.00 to cover shipping cost.

Order Toll-Free 800/258-5420

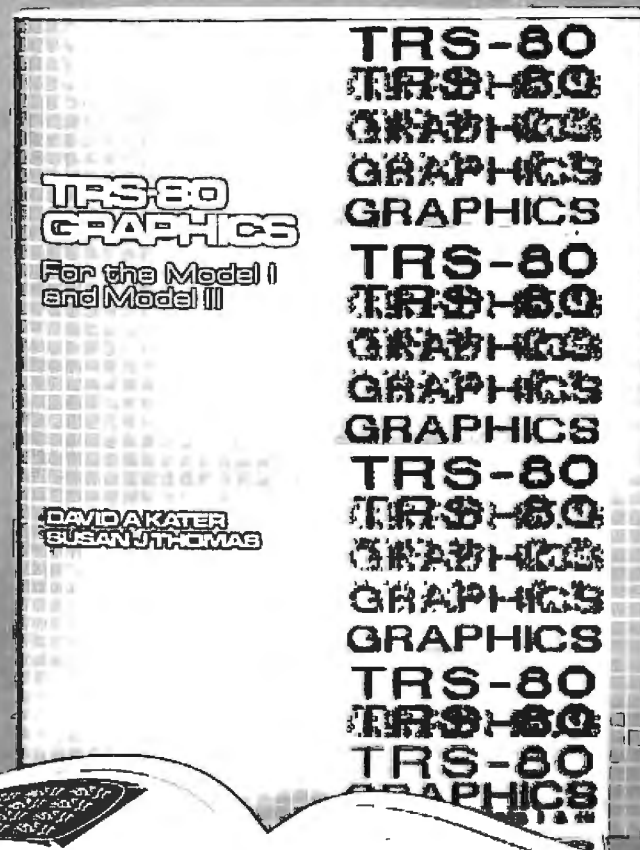

BYTE/McGraw-Hill 70 Main Street Peterborough, NH 03458



NEW 23K PERSONAL COMPUTER

\$239⁰⁰ FACTORY SALE PRICE

You get the NEW APF-IM-1 Full Size Powerful Computer: Includes 14K ROM with Level II BASIC built in, 9K User RAM, Color, Sound, Professional 53 keyboard, Two controllers, Two 10 key numeric pads, High speed cassette, A.C. adapter, RF modulator, T.V. switchbox. Accepts TAPE-DISK-PLUG IN CARTRIDGES. It is PLUG IN EXPANDABLE at low cost. 90 day parts and labor warranty, owners guide, BASIC language manual. All this in a beautiful black and white console case for only \$239⁰⁰.

15 DAY FREE TRIAL Return within 15 days complete and undamaged for refund of purchase price.

PROTECTO ENTERPRIZES
BOX 550, BARRINGTON, IL 60010
TO ORDER PHONE 312/382-2192

Circle 339 on inquiry card.

p-System* + CPR = Word Processing

CPR The Vital Link

CPR is an advanced text formatter offering fast, flexible word processing for the UCSD p-System.

CPR functions include pagination, underlining, proportional spacing and a lot more.

CPR is available now on 8" diskettes for p-System versions II and IV including 175 page users' manual . . . \$199.00.

Users' manual alone . . . \$30.00

* UCSD p-System™ is a trademark of the Regents of the University of California.

Chapin ASSOCIATES

SOFTWARE FOR SYSTEMS AND APPLICATIONS

1155E Sorrento Valley Rd. Suite 11 San Diego, CA 92121
(714) 452-9349

Circle 72 on inquiry card.

* ADDS *

VIEWPOINT TERMINALS

\$495

In addition EPI carries printers DEC & DG compatible terminals and modems. Items in stock are shipped within 24 hours. ALL orders shipped COD. All items are new and in factory cartons with manufacturers warranties.

ECONOMY PERIPHERALS INC.

(404) 952-0213

Circle 158 on inquiry card.

Build and Enhance

your Apple™ software library at affordable prices.

For the FIRST time — PACKED disks with 60 outstanding programs.

Your Apple™ needs programs! At last you have an opportunity to use your Apple™ to its fullest capacity!

PROGRAMS \$1-EACH

APPLEWARE INC. offers on each disk an extensive variety of programs including:

- Business
- Games
- Utilities
- Science
- Printer
- Text
- DataBase
- Engineering
- Graphics
- Music
- Finance
- and many others with 3.3 DOS for easy demuffing.

First 3 disks available at \$59.95 each
Order all 3 for a free bonus disk.

Call now toll free: 1-800-327-8664
Fla. Residents: 305-584-7004

Please add \$3 for postage & handling.

6400 Hayes St.
Hollywood, FL 33024



*TM Apple is a registered trademark of Apple Computer Co.

Circle 30 on inquiry card.

PRICE BREAK

EPSON MX-80 CARTRIDGE RIBBONS

\$9.95 EA.

\$107.46 per dozen

Minimum Order 3 Ribbons

Price Includes Shipping

We accept Mastercard and Visa

CHECK-MATE™
P.O. BOX 103, RANDOLPH, MA 02368
Call Toll Free - 1-800-343-7706
In Massachusetts - 617-963-7694

Circle 74 on inquiry card.



maxell.

Floppy Disks

SAVE 40% Write for your complete list.

5 1/4" Specify soft, 16 or 18 sector Price/10

MD1 or MH1 SS/DD	\$33
MD2 or MH2 DS/DD	47
MD1-DDM SS/QD/96 TP1	43
MD2-DDM DS/QD/96 TP1	53

8" Specify soft or 32 sector

FD1 or FH1 SS/DD	43
FD2 or FH2 DS/DD	53

CHECKS — VISA — MC — O.D.
(313) 777-7780 ADD \$2 SHIPPING

LYBEN COMPUTER SYSTEMS
27204 Harper Ave.
St. Clair Shores, MI 48081

Circle 236 on Inquiry card.

PC/FORTH

Complete FORTH program development systems for the IBM® Personal Computer. Packages include interpreter/compiler with virtual memory management, line editor, custom screen editor, assembler, decompiler, utilities, file and record access modules, and many demonstration programs. 100 page user manual . . . \$100.00

Floating point arithmetic extensions and cross compiler available at additional cost.

Ready to run under PC-DOS or CP/M-86® Standalone version available soon. 64 kbytes RAM and two disk drives recommended. (IBM is a registered trademark of International Business Machines Corp. CP/M is a registered trademark of Digital Research, Inc.)

Laboratory Microsystems

4147 Beethoven Street
Los Angeles, CA 90066
(213) 306-7412

Circle 227 on inquiry card.



Free

Microprocessor Catalog

40 page catalog of 8800 single board computers, interface modules, SPRINT 68 control computer/development system, WIZRD multitasking DOS, assemblers, compilers, BASIC, cross assemblers, cross compilers, custom engineering, OEM applications software

WINTERK

Winterk Corp.
1801 South Street
Lafayette, IN 47904
317-742-8428

Circle 432 on inquiry card.

It's Now Available! The Light Pen For The IBM Personal Computer



Ideal For: ■ Program Interface and menu selection. ■ Interactive graphics for engineering, business and CAD. ■ Very effective educational programs, without keyboard problems. ■ SUPER games, exciting demonstrations and just plain fun. **Professional Quality and Durable Construction, yet Inexpensive. Fully Supported Under IBM Basic for Color/ Graphics Adapter with Monochrome or Color Displays or TV's. (Not for use with IBM Monochrome Display).** Introductory Pricing: FT-156 Light Pen — \$139.95; Demo/Games Diskette — \$29.95. Call or write us, or see your participating IBM® dealer.

FTG DATA SYSTEMS

10801 Dale Street, Suite M-2
P.O. Box 615
Stanton, California 90608
(714) 995-3900 VISA & M/C Accepted

Circle 175 on Inquiry card.

Why use their flexible discs:

BASF, Control Data, Dysan, IBM, Kybe, Maxell, Nashua, Scotch, Syncom, Verbatim or Wabash
when you could be using

MEMOREX

high quality error free discs?

Product Description	Part #	CE quant. 100 price per disc (\$)
8" SSSD IBM Compatible (128 B/S, 26 Sectors)	3062	2.09
8" SSSD Shugart Compatible, 32 Hard Sector	3015	2.09
8" SSSD CPT 8000 Compatible, Soft Sector	3045	2.99
8" SSDD IBM Compatible (128 B/S, 26 Sectors)	3090	2.74
8" DSDD Soft Sector (Unformatted)	3102	3.34
8" DSDD Soft Sector (128 B/S, 26 Sectors)	3115	3.34
8" DSDD Soft Sector (256 B/S, 26 Sectors)	3103	3.34
8" DSDD Soft Sector (512 B/S, 15 Sectors)	3114	3.34
8" DSDD Soft Sector (1024 B/S, 8 Sectors)	3104	3.34
5 1/4" SSDD Soft Sector w/Hub Ring	3481	2.34
5 1/4" SSDD 10 Hard Sector w/Hub Ring	3483	2.34
5 1/4" SSDD 16 Hard Sector w/Hub Ring	3485	2.34
5 1/4" DSDD Soft Sector w/Hub Ring	3491	3.09
5 1/4" DSDD 10 Hard Sector w/Hub Ring	3493	3.09
5 1/4" DSDD 16 Hard Sector w/Hub Ring	3495	3.09
5 1/4" SSDD Soft Sector w/Hub Ring (96 TPI)	3504	2.99
5 1/4" DSDD Soft Sector w/Hub Ring (96 TPI)	3501	3.99

SSSD = Single Sided Single Density; SSDD = Single Sided Double Density
DSDD = Double Sided Double Density; TPI = Tracks per inch

Memorex Flexible Discs... The Ultimate in Memory Excellence

Free Memorex Mini-Disc Offer - Save 10%
Every carton of 10 Memorex 5 1/4 inch mini-discs sold by Communications Electronics, now has a coupon good for a free Memorex mini-disc. For every case of 100 Memorex mini-discs you buy from CE, you'll get 10 free mini-discs directly from Memorex. There is no limit to the number of discs you can purchase on this special offer. This offer is good only in the U.S.A. and ends on December 31, 1982.

Quality
Memorex means quality products that you can depend on. Quality control at Memorex means starting with the best materials available and continual surveillance throughout the entire manufacturing process. The benefit of Memorex's years of experience in magnetic media production, resulting, for instance, in proprietary coating formulations. The most sophisticated testing procedures you'll find anywhere in the business.

100 Percent Error Free
Each and every Memorex Flexible Disc is certified to be 100 percent error free. Each track of each flexible disc is tested, individually, to Memorex's stringent standards of excellence. They test signal amplitude, resolution, low-pass modulation, overwrite, missing pulse error and extra pulse error. Rigid quality audits are built into every step of the manufacturing process and stringent testing result in a standard of excellence that assures you, our customer, of a quality product designed for increased reliability and consistent top performance.

Customer-Oriented Packaging
The desk-top box containing ten discs is convenient for filing and storage. Both box labels and jacket labels provide full information on compatibility, density, sectoring, and record length. Envelopes with multi-language care and handling instructions and color-coded removable labels are included. A write-protect feature is available to provide data security.

Full One Year Warranty— Your Assurance of Quality
Memorex Flexible Discs will be replaced free of charge by Memorex if they are found to be defective in materials or workmanship within one year of the date of purchase. Other than replacement, Memorex will not be responsible for any damages or losses (including consequential damages) caused by the use of Memorex Flexible Discs.

Quantity Discounts Available

Memorex Flexible Discs are packed 10 discs to a carton and 10 cartons to a case. Please order only in increments of 100 units for quantity 100 pricing. We are also willing to accommodate your smaller orders. Quantities less than 100 units are available in increments of 10 units at a 10% surcharge. **Quantity discounts** are also available. Order 500 or more discs at the same time and deduct 1%; 1,000 or more saves you 2%; 2,000 or more saves you 3%; 5,000 or more saves you 4%; 10,000 or more saves you 5%; 25,000 or more saves you 6%; 50,000 or more saves you 7% and 100,000 or more discs earns you an 8% discount off our super low quantity 100 price. Almost all Memorex Flexible Discs are immediately available from CE. Our warehouse facilities are equipped to help us get you the quality product you need, when you need it. If you need further assistance to find the flexible disc that's right for you, call the Memorex compatibility hotline. Dial toll-free 800-538-8080 and ask for the flexible disc hotline extension 0997. In California dial 800-672-3525 extension 0997. Outside the U.S.A. dial 408-987-0997.

Buy with Confidence

To get the fastest delivery from CE of your Memorex Flexible Discs, send or phone your order directly to our Computer Products Division. Be sure to calculate your price using the CE prices in this ad. Michigan residents please add 4% sales tax. Written purchase orders are accepted from approved government agencies and most well rated firms at a 30% surcharge for net 30 billing. All sales are subject to availability, acceptance and verification. All sales are final. Prices, terms and specifications are subject to change without notice. Out of stock items will be placed on backorder automatically unless CE is instructed differently. Minimum prepaid order \$50.00. Minimum purchase order \$200.00. International orders are invited with a \$20.00 surcharge for special handling in addition to shipping charges. All shipments are F.O.B. Ann Arbor, Michigan. No COD's please. Non-certified and foreign checks require bank clearance.

Mail orders to: Communications Electronics, Box 1002, Ann Arbor, Michigan 48106 U.S.A. Add \$8.00 per case or partial-case of 100 8-inch discs or \$6.00 per case or partial case of 100 5 1/4-inch mini-discs for U.P.S. ground shipping and handling in the continental U.S.A. If you have a MasterCard or Visa card, you may call anytime and place a credit card order. Order toll-free in the U.S. Dial 800-521-4414. If you are outside the U.S. or in Michigan, dial 313-994-4444. Order your high quality, error free Memorex discs today.

Copyright ©1982 Communications Electronics Ad #051782

Free disc offer Save 10%



Order Toll-Free!
(800) 521-4414
In Michigan (313) 994-4444

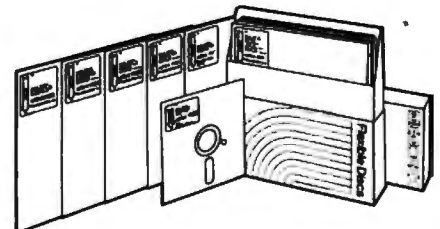

For Data Reliability—Memorex Flexible Discs

COMMUNICATIONS ELECTRONICS™

Computer Products Division

854 Phoenix □ Box 1002 □ Ann Arbor, Michigan 48106 U.S.A.
Call TOLL-FREE (800) 521-4414 or outside U.S.A. (313) 994-4444

Diagnosics and Treatment for your CP/M* Computer

TINYDOC™.....29.95 p.p.
(8 1/4" CP/M Disk)

Tests and diagnoses I/O, Memory, Disk-System, CPU; reads file parameters and mends files under software control; pinpoints bad chips, etc. (If 5 1/4 disk, specify)

MICRO SERVICE GUIDE I

"CP/M Computer System Servicing".....7.95 p.p.

MICRO SERVICE GUIDE II

"SA800/801 Disk Drive Servicing".....9.95 p.p.

MICRO SERVICE GUIDE books are written for anyone with basic electronic knowledge and ability to use screwdrivers. The appendix provides detailed repair techniques for people with soldering iron and an oscilloscope.

US Funds only. Foreign orders add \$8.00. Personal checks take 3-4 weeks. California residents add 6% tax. All orders are confirmed by mail. Write for technical details.

R. F. & ASSOCIATES
1930 Purdue Ave.
Los Angeles, California 90025
(213) 477-8310

*Trademark of Digital Research

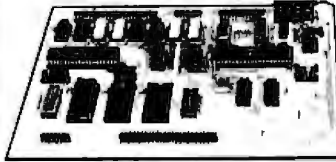

Z8* CONTROL

FEATURES: Zilog Z8671 microprocessor with on chip basic interpreter: 12K of on board user memory with choice of ROM, RAM, or PROM, selectable in 4K increments: RS232 and 20 MA current loop serial I/O: 110 to 9600 baud; 8255 peripheral interface with choice of TTL, R-Pack, or Open Collector I/O buffers; 48 parallel I/O lines total: Pin compatibility with industry standard OPTO I/O modules; Two 8 bit counter timers with 6 bit prescalers; 6 vectored interrupts; Module bus for full expansion; All chips socketed; Industrial grade construction.

Price (1-9) \$295.00

* Z8 a trademark of Zilog Corp.

LEHMANN & ASSOCIATES
P.O. Box 566, Maumee, Ohio 43537
(419) 891-0687

LOOK TO THE FUTURE... EPROM-32

The only EPROM programmer you need!

- IEEE-696 (S-100) EPROM programmer for single supply (+5V) EPROMs.
- Programs current 1K through 16K (byte) EPROMs plus future 32K EPROMs.
- EPROM can be verified through a port or located in memory space for verification and use.
- Personality Modules adapt board to different EPROM types:

PM-1-2508, 2758	PM-3-2732, 2732A	PM-6-68764
2516, 2716	PM-4-2564	PM-7-2528
PM-2-2532	PM-5-2764	PM-8-27128
- Single zero-insertion-pressure socket accommodates both 24-pin and 28-pin EPROM packages.
- On-board DC-to-DC converter with adjustable regulator for programming voltage.
- Double-sided PCB board with solder masks, silkscreen and gold-plated contact fingers.
- 8080/Z80 control software includes commands for programming, verification, disk I/O and editing.
- Comprehensive user's manual contains source listing of control software.

MicroDynamics

Corporation
P.O. Box 17577
Memphis, TN 38117
(901)-755-0619

\$269.95

(assembled & tested)

Price includes EPROM-32, documentation and two Personality Modules (specify). Additional Modules—\$7.95. Control software on 8 inch single density CP/M-compatible diskette—\$9.95.

MasterCard & Visa

TN residents add 6% sales tax.

- High Contrast Black-Stripe Tube
- Ultra Stable Convergence
- 15.7 KHz 50/60 Hz Sync.
- Full Documentation
- 116/220 VAC, 80w.
- 90 Day Warranty
- Analog Inputs

13" - \$359.00

128 pixels x 512 lines, 32 ch.

19" - \$389.00

140 pixels x 525/625 lines, 48 ch.

IBM Cable - \$49.00

Active Circuit displays 16 Colors



boards) accommodates two "utilized" Flats, 810 BOARD, Power Supply, Cooling Fan, I/O outputs for serial, parallel, CRT and various protocols and "RAM" modules



NOT 5 MEGABYTES
BUT 10 !!!
S-100 \$1995 APPLE
TRS-80

5 1/4" 10 MB HARD DISK DRIVE
SMART CONTROLLER
S-100, APPLE OR TRS-80
COMPUTER INTERFACE

POWER SUPPLY - ENCLOSURE - FAN
ALL CABLING
COMPLETELY ASSEMBLED
AND TESTED

ASC W10 CURRENTLY RUNS
ON THE FOLLOWING DISK
OPERATING SYSTEMS: CP/M
2.2, APPLE DOS, TRS-80
LDOS

ASC

P.O. Box 615
Lexington Park, MD 20653
(301) 863-6784

LDOS is a trademark of Logical Systems Inc
TRS-80 is a trademark of Tandy Corp.



- Finest print quality
- Easy installation
- Fits IBM Selectric® and Electronic Typewriters
- Models for all popular computers
- Call or write for more information, today!

IPEX INTERNATIONAL INC.
5115 Douglas Fir Rd.
Calabasas, CA 91302 U.S.A.
(710) 1444 TLX/TWX: 910 494 2101

APPLE TREE GENEALOGY SYSTEM for your APPLE II+ Computer

- Professional-level Family Recordkeeping System
- 1000 Names (variable-length)
- Hierarchical Data-Structure
- Easy to Use
- Fast Memory-Resident Scroll
- Unique Label Control Matrix
- 100 User-Definable Fields
- The Linkage Analyzer™
- Customize Your Own Reports
- Automatic Proofreader Report
- Self-teaching Tutorial
- Backed by 4 Years Gen. Computing
- Apple II + 48k DOS 3.3 (1 or 2 Drives)

JFSS

J.Fiske Software Systems, Inc
One University Place
New York, N.Y. 10003

\$69.95

NYC/NYS Add Tax



Apple™ - Apple Computer
Apple Tree™ / The Linkage An

MEMOREX FLEXIBLE DISCS

WE WILL NOT BE UNDER-SOLD!! Call Free (800)235-4137 for prices and information. Dealer inquiries invited and C.O.D.'s accepted.

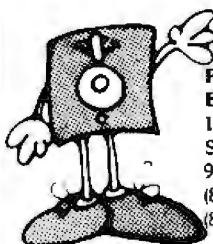

PACIFIC EXCHANGES
100 Foothill Blvd.
San Luis Obispo, CA
93401 In Cal. call
(800)592-5935 or
(805)543-1037

AIM-65 PROM PROGRAMMER

PROGRAM PROMS WITH YOUR AIM-65 FULL FEATURED:

- PROGRAM
- VERIFY
- READ
- DUMP TO PRINTER
- MORE

PROGRAMS THESE 5 VOLT PROMS:
2758, 2716, 2732, 2764, 27128, 2508, 2516, 2532, MORE
USES STANDARD AIM-65 VOLTAGES: +5, +24VDC

ASSEMBLED AND TESTED

* **ONLY \$95.00** *

+ \$4.00 shipping & handling

SOFTech CONSULTANTS
2393 NW 30th ROAD
BOCA RATON, FLA. 33431

TERMS: MONEY ORDER, C.O.D.
PERSONAL CHECK, ALLOW 2 WEEKS
FLA. RESIDENTS: ADD 5% SALES TAX

INTELLIGENT VIDEO I/O FOR S-100 BUS

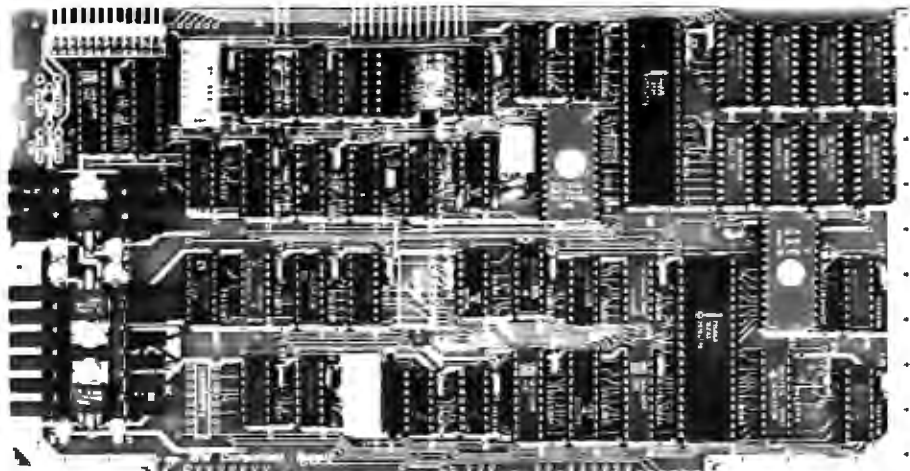

VIO-X

The VIO-X Video I/O interface for the S-100 bus provides features equal to most intelligent terminals both efficiently and economically. It allows the use of standard keyboards and CRT monitors in conjunction with existing hardware and software. It will operate with no additional overhead in S-100 systems regardless of processor or system speed.

Through the use of the Intel 8275 CRT controller with an onboard 8085 processor and 4k memory, the VIO-X interface operates independently of the host system and communicates via two ports, thus eliminating the need for host memory space. The screen display rate is effectively 80,000 baud.

The VIO-X1 provides an 80 character by 25 line format (24 lines plus status line) using a 5 x 7 character set in a 7 x 10 dot matrix to display the full upper and lower case ASCII alphanumeric 96 printable character set (including true descenders) with 32 special characters for escape and control characters. An optional 2732 character generator is available which allows an alternate 7 x 10 contiguous graphics character set.

The VIO-X2 also offers an 80 character by 25 line format but uses a 7 x 7 character set in a 9 x 10 dot matrix allowing high-resolution characters to be used. This model also includes expanded firmware for block mode editing and light pen location. Contiguous graphics characters are not supported.

Both models support a full set of control characters and escape sequences, including controls for video attributes, cursor location and positioning, cursor toggle, and scroll speed. An onboard Real Time Clock (RTC) is displayed in the status line and may be read or set from the host system. A checksum test is performed on power-up on the firmware EPROM.

Video attributes provided by the 8275 in the VIO-X include:

- FLASH CHARACTER
- INVERSE CHARACTER
- UNDERLINE CHARACTER or
- ALT. CHARACTER SET
- DIM CHARACTER

The above functions may be toggled together or separately.

The board may be addressed at any port pair in the IEEE 696 (S-100) host system. Status and data ports may be swapped if necessary. Inputs are provided for parallel keyboard and for light pen as well as an output for audio signalling. The interrupt structure is completely compatible with Digital Research's MP/M.

Additional features include:

- HIGH SPEED OPERATION
- PORT MAPPED IEEE S-100 INTERFACE
- FORWARD/REVERSE SCROLL or
- PROTECTED SCREEN BLOCKS
- CONVERSATIONAL or BLOCK MODE (opt)
- INTERRUPT OPERATION
- CUSTOM CHARACTER SET
- CONTROL CHARACTERS
- ESCAPE CHARACTER COMMANDS
- INTELLIGENT TERMINAL EMULATION
- TWO PAGE SCREEN MEMORY

VIO-X1 - 80 x 25 5 x 7 A & T **\$295.00**

Conversational Mode

VIO-X2 - 80 x 25 7 x 7 A & T **\$345.00**

Conversational & Block Modes

For European enquiries and sales contact:

Fulcrum (Europe) England
Phone 061 828763



FULCRUM
COMPUTER PRODUCTS

Distributed by **WW COMPONENT SUPPLY INC.** 1771 JUNCTION AVENUE • SAN JOSE, CA 95112 • (408) 295-7171

64K STATIC RAM BOARD FOR S-100 BUS

\$425

NEW: Additional Features

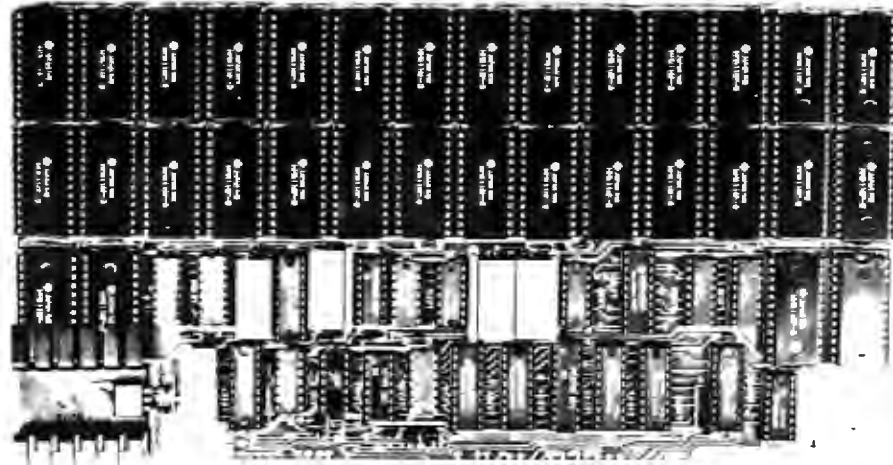

FEATURES

- Conforms to IEEE 696 standard.
- 8 or 16 bit data transfers.
- 24 bit addressing.
- Bank select in 32K-32K or 48-16K.
- Banks selectable/deselectable on DMA.
- Responds to phantom pin 67 or 16.
- 2Kx8 static rams with 2716 pin out.
- Power consumption is typically 600 ma.
- Banks on or off on power up.
- Bank addressable to any of 256 possible ports.
- 8MHz with 150ns parts standard faster speeds available on request.
- Available partially loaded as a 32K board.
- Multiple bank residence.

NEW FEATURES

- Phantoms read only, or read and write.
- Generates onboard M-WRITE, or uses bus M-WRITE.
- Two separate banks, independently addressable on 16K boundaries. Banks may be overlapped.

OMNIRAM REV. C

OMNIRAM INTRODUCTION:

The Fulcrum Computer Products OMNIRAM for the IEEE 696 (S100) bus provides 64 kilobytes of fast static random access memory. Provision is made for 8 or 16 bit transfers, extended 24 bit addressing, and for control via the bus phantom line. In addition, a number of features are included to make the OMNIRAM compatible with systems designed before the IEEE 696 standard was developed. These include bank selection and provision for operation with IMSAI-type front panels. When the bank select option is activated, the board is divided into two parts which can reside in separate banks. The division of the board may be into two 32K sections or into one 16K section and one 48K section. 2K blocks may be disabled in the upper 16K, or 4K blocks in the upper 32K, of memory. Provision is made for DMA override of bank select if needed. The board is also compatible with IEEE 696 or IMSAI-type extended addressing.

Omniram 64 United States & Canada Prices Only	
With Hitachi 6116	64K 32K
150ns. Rams	\$470 \$325
120ns. Rams	\$550 \$395
Board Without Ram	\$200
With Toshiba 2016 Rams	64K 32K
Typical current draw 800mill	\$425 \$275



FULCRUM
COMPUTER PRODUCTS

Distributed by **WW COMPONENT SUPPLY INC.** 1771 JUNCTION AVENUE • SAN JOSE, CA 95112 • (408) 295-7171
For European enquiries and sales contact: **Fulcrum (Europe) England.** Phone 061 828763

ARE YOU OUT OF CONTROL?

OUR 6502 BASED MICROCOMPUTER HAS EVERYTHING UNDER CONTROL.

THE COMPUTER "SLIM"

- 6502 MICROPROCESSOR
 - 2K BYTES RAM
 - 2K OR 4K EPROM
 - FOUR 8 BIT I/O PORTS
 - POWER ON RESET
 - CRYSTAL CLOCK
 - BUFFERED SYM-AIM BUS
- PRICE 81-260A \$199.95 ASSM.
81-260K \$149.95 KIT
81-260B \$ 39.95 BARE BOARD

THE PERIPHERALS

RAM EPROM MEMORY

- 32K BYTES OF RAM OR EPROM
- PRICE 81-330A \$ 99.95 ASSM. W/O MEMORY
81-330B \$ 49.95 BARE BOARD

6 SLOT MOTHER BOARD

- .750" BOARD SPACING 44 PIN BUS
- PRICE 81-320A \$ 99.95 ASSEMBLED
81-320B \$ 49.95 BARE BOARD

24 HOUR REAL TIME CLOCK

- FOUR DIGIT LED DISPLAY
 - ON BOARD POWER SUPPLY
- PRICE 81-350A \$149.95 ASSEMBLED
81-350B \$ 49.95 BARE BOARD

ANALOG I/O INTERFACE

- 16 ANALOG INPUT CHANNELS
 - 2 ANALOG OUTPUT CHANNELS
- PRICE 81-292A \$199.95 ASSEMBLED
81-292B \$ 49.95 BARE BOARD

12 PORT PARALLEL I/O BOARD

- 12 8 BIT I/O PORTS — 6 6522S
- PRICE 82-036A \$169.95 ASSEMBLED
82-036B \$ 49.95 BARE BOARD

MONITOR + TINY BASIC 2532 \$39.95

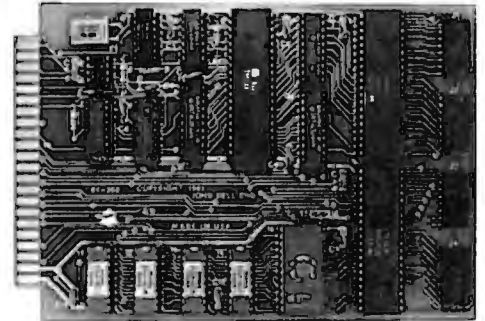

THE COMPUTER "SLIM"

ALL BOARDS ARE 4.5 X 6.5 WITH GOLD EDGE CONNECTORS SOLDER MASK BOTH SIDES

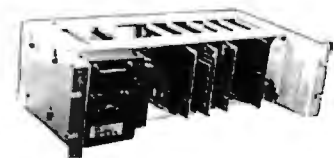
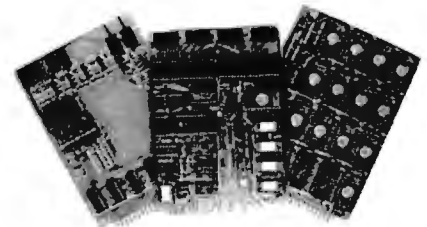

19" RACK MOUNTING

CALL 415 592-8411 FOR MORE INFORMATION.

OUR SALES PEOPLE WILL BE GLAD TO DEMONSTRATE OUR PRODUCTS AT YOUR COMPANY. OEM PRICING AVAILABLE.



JOHN BELL ENGINEERING, INC.

ALL PRODUCTS ARE AVAILABLE FROM JOHN BELL ENGINEERING, INC. • 1014 CENTER ST., SAN CARLOS, CA 94070
ADD SALES TAX IN CALIFORNIA • ADD 5% SHIPPING & HANDLING 3% FOR ORDERS OVER \$100
SEND FOR CATALOG (415) 592-8411 10% OUTSIDE U.S.A.

WILL CALL HOURS: 9am - 4pm

VISA

THIN is IN!

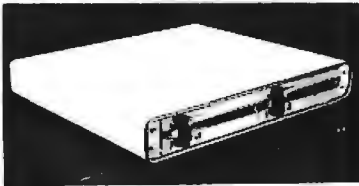

State-of-the-art 8" disk drive subsystems give you a remarkable 2.4 MB in the space of a single-drive cabinet, 4.8 MB storage capacity in the space of a 2-drive cabinet. Perfect add-ons for IBM, Apple, Radio Shack and all 8" Shugart compatible computers.

Systems	Introductory Price	Retail
2-Drive	\$1695	\$1995
4-Drive	\$2995	\$3495
2-Drive Horizontal	\$1750	\$2050

write protect switch option — \$30/drive
Columbia microSystems, Inc.
 905 E. Broadway, Columbia, MO 65201
 (314) 875-8900

Circle 81 on inquiry card.

S-100 VOICE

The ARTICULATOR board allows you to record, store, and playback any vocabulary on your S-100 computer. Input speech is digitized by the ARTICULATOR and sent to the computer via an on-board port for storage at 1K to 2K bytes/sec. This data is then sent back from the computer to the ARTICULATOR for very high quality playback. On-board VOX switching minimizes memory storage requirements.

PRICE - \$350 A&T
 AVAILABLE NOW

Quintrex, Inc.
 4461 Indian Creek Parkway
 PO Box 7384
 Overland Park, KS 66207

Circle 347 on inquiry card.

TIRED OF CHANGING CABLES AND TURNING KNOBS?

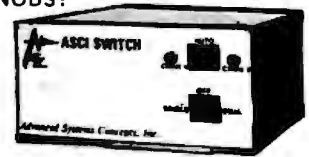

ASCII SWITCH

- Computer Controlled or Manual
- Command Code User Selectable
- Select one of two Peripherals
- Select one of two Computers
- Asynchronous to 19200 Baud
- No External Power Needed

Call or write

ADVANCED SYSTEMS CONCEPTS, INC.
 P.O. BOX Q, ALTADENA, CA. 91001
 (213) 684-5461 or 794-2308

Circle 10 on inquiry card.

Got a computer?

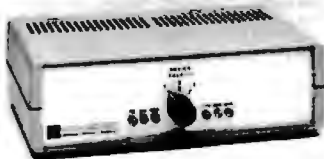

Get a Giltronix Selector Switch.

Eliminate unplugging and re-plugging your CPU's, peripherals, and modems. Eliminate expensive duplication of interconnection hardware. Connect three components to Giltronix Selector Switch #S8AB. Then select your connection with a simple turn of the dial. Only \$79 in OEM quantities. Monitoring options available. Full 5 year warranty on all Giltronix units.

SWITCH TO GILTRONIX.



970 San Antonio Ave., Palo Alto, CA 94303

Circle 186 on inquiry card.



Solve your disc problems, buy 100% surface tested Dysan diskettes. All orders shipped from stock, within 24 hours. Call toll FREE (800) 235-4137 for prices and information. Visa and Master Card accepted.

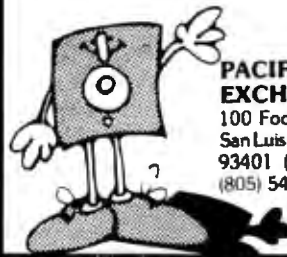

PACIFIC EXCHANGES
 100 Foothill Blvd.
 San Luis Obispo, CA
 93401 (In Cal call
 (805) 543-1037)

Circle 314 on inquiry card.

MICROANGELO Software

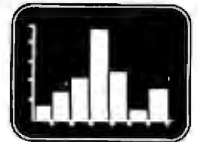

GRAPH-PAK

Fortran compatible interactive plotting package based on CALCOMP standards. Output is to MicroAngelo or to pen plotter. \$270.00 (CP/M and Microsoft Fortran-80 required.)
SPRINT
 Hardcopy program for MicroAngelo. Output is to I.D.S. or EPSON graphics printers. CP/M compatible \$125.00

Laboratory Computer Systems, Inc.
 139 Main Street, Cambridge, MA 02142
 (617) 547-4738

* Trademark of SCION Corp

Circle 226 on inquiry card.

PROBLEM:

How to mate your CP/M or ISIS system to the

Z-8000

(without losing all your present capabilities)

SOLUTION:

ZEX is the software connection which permits Z-8000 applications to run under your current operating system, resulting in portable 16-bit software which runs under CP/M or ISIS! And ZEX is user-configured for any Z-8000 alternate bus master, so that it can support your prototype hardware, as well as commercially available Z-8000 boards.

ZAS is a complete Z-8000 Development Package, which includes a powerful relocatable cross assembler (ZAS), a flexible object task builder (ZLK), and an absolute object loader (ZLD), as well as the ZEX run time module. The package was developed specifically for the Z-8000, and supports the complete Zilog instruction syntax for both the Z8001 and Z8002, including support for mixed segmented and non-segmented code.



ZAS Package CP/M .. \$395
 ISIS-II .. \$495
 Manual Only .. \$25
 Supplied on Single Density 8" Disk
 CP/M: Digital Research, Inc. ISIS-II: InterCorp.
 Box C Norwood, CO 81423 (303)327-4898

Circle 428 on inquiry card.

Convert your TRS-80 into a DEVELOPMENT SYSTEM

Z-80 In-Circuit emulation and EPROM/EEPROM programming in a single compact unit.

Debug stand-alone systems with program in TRS-80 RAM,

then copy working program into PROM.

Only \$329 including personality module for 2716, 2516, 2758, 2508, 2532, 2816, 2808, 48016. (2732A, 2764 PM's \$15 ea.)

ORION INSTRUMENTS

172 Otis Ave, Woodside, CA 94062
 (415) 851-1172



Circle 310 on inquiry card.

Expansion Memory



for

The IBM Personal Computer

• Parity generation & checking • Fully assembled & tested
 • One yr. warranty • All RAM locations socketed on all cards exc. AIM-256-00B • SIMPLE ON-CARD EXPANSION: just plug in RAM chips and change switch settings — no PROM's or PLA's to buy.

PART. NO.	UNIT	PRICE
AIM-256-01B	64KB	\$209.
AIM-256-02B	128KB	\$328.
AIM-256-03B	192KB	\$447.
AIM-256-04B	256KB	\$566.
AIM-256-05B	0KB	\$139.
AIM-256-00B	unit less RAM chips Bare board, Bracket & Schematic	\$ 49.
AIM-256-09B	64KB EXP. KIT (8 RAM chips)	\$129.

APSTEK, INC.

P.O. Box 5306
 Richardson, TX 75080
 (Texas residents add applicable sales tax)
 VISA, M/C 24hr. order line
 (817) 571-7171

Circle 32 on inquiry card.

DoKay Computer Products, Inc.

VISIT OUR RETAIL STORE
AND RECEIVE A 5% DISCOUNT!

3250 KELLER STREET, #9 • SANTA CLARA, CA 95050

8000			
8035	16.00	8239	4.75
8039	19.00	8243	4.75
8080A	3.90	8250	14.90
8085A	8.50	8251	4.50
8088	39.00	8253	8.75
8155	11.00	8253-5	9.75
8156	11.00	8255	4.50
8185	29.00	8255-5	5.20
8741	39.00	8257	8.50
8748	29.00	8259	6.85
8755	44.00	8272	39.00
8202	44.00	8275	29.00
8205	3.45	8279	9.25
8212	1.80	8279-5	10.25
8214	3.75	8282	6.50
8216	1.75	8283	6.50
8224	2.45	8284	5.50
8226	1.80	8286	6.50
8228	4.50	8287	6.50
8237	19.00	8288	25.00
8238	4.75	8289	49.00

16K APPLE RAM CARD

Upgrade your 48K Apple II to full 64K

BARE BOARD 29.95
KIT 59.95
ASSEMBLED & TESTED 79.95

LEDS

Jumbo Red	10/1.00
Jumbo Green	6/1.00
Jumbo Yellow	6/1.00

CONNECTORS

RS 232 Male	3.00
RS 232 Female	3.50
RS 232 Hood	1.20

6500

6502	6.90
6502A	9.45
6504	6.90
6505	7.65
6507	9.90
6520	4.35
6522	9.90
6532	13.95
6551	11.75

UPGRADE YOUR APPLE or TRS-80

4116 200ns
8/12.95

CRYSTALS

32.768 KHZ	3.75	5.185	3.90
1.0 MHZ	4.50	5.7143	3.90
1.8432	4.50	6.5536	3.90
2.0	3.90	8.0	3.00
2.097152	3.90	10.0	3.00
2.4576	3.90	14.31818	3.90
3.2768	3.90	18.0	3.00
3.579545	3.00	18.432	3.00
4.0	3.00	20.0	3.00
5.0	3.00	22.1184	3.00
5.0688	3.90	32.0	3.90

EPROMS			STATIC RAMS		
1702	(1ns)	3.00	2101	(450ns)	1.85
2708	(45ns)	2.99	21L02	(250ns LP)	1.55
2716	(5v 450ns)	3.95	2111	(450ns)	2.49
2716-1	(5v 350ns)	8.50	2114	(450ns)	1.95
2532	(5v 450ns)	8.95	2114L-3	(300ns LP)	2.25
2732	(5v 450ns)	8.95	2114L-2	(200ns LP)	2.30
2764	(5v 450ns)	Call	TMM2016	(200ns)	9.00
			TMM2016	(150ns)	11.00
			HM6116	(200ns)	Call
			HM6116	(150ns)	Call
			HM6116	(120ns)	Call

DYNAMIC RAMS

4027	(250ns)	2.00
4116	(200ns)	1.75
4116	(150ns)	1.85
4164	(200ns)	Call

LP = Low Power

Z80

Z80 A CPU	5.45
Z80 A PIO	5.45
Z80 A CTC	7.00

Call for Complete List

MICROPROCESSOR REAL-TIME CLOCK

MSM 5832
7.25

6800

6800	5.65	6828	14.90	6860	10.90
6802	8.65	6834	16.90	6862	11.90
6808	8.45	6840	7.95	6875	6.90
6809	24.00	6843	41.95	6880	1.80
6809E	29.00	6845	16.90		
6810	3.50	6847	15.90	68B00	10.00
6820	3.50	6850	3.50	68B21	12.00
6821	3.50	6852	3.50	68B50	12.00

74LS00 SERIES

74LS00	.24	74LS123	.95	74LS253	.80
74LS01	.24	74LS124	2.90	74LS257	.80
74LS02	.24	74LS125	.95	74LS258	.80
74LS03	.24	74LS126	.79	74LS259	2.80
74LS04	.24	74LS132	.75	74LS260	.60
74LS05	.24	74LS136	.49	74LS266	.49
74LS08	.24	74LS137	.95	74LS273	1.60
74LS10	.24	74LS138	.75	74LS275	3.25
74LS11	.30	74LS139	.75	74LS279	.49
74LS12	.30	74LS145	1.10	74LS280	1.95
74LS13	.40	74LS147	2.20	74LS283	.95
74LS14	.89	74LS148	1.20	74LS290	1.20
74LS15	.30	74LS151	.75	74LS293	1.79
74LS20	.24	74LS153	.75	74LS295	.99
74LS21	.30	74LS154	1.75	74LS298	.99
74LS22	.24	74LS155	.89	74LS324	1.75
74LS26	.30	74LS156	.89	74LS352	1.49
74LS27	.24	74LS157	.75	74LS353	1.49
74LS28	.30	74LS158	.75	74LS363	1.49
74LS30	.24	74LS160	.95	74LS364	1.95
74LS32	.36	74LS161	.95	74LS365	.89
74LS33	.55	74LS162	.95	74LS366	.89
74LS37	.55	74LS163	.95	74LS367	.69
74LS38	.35	74LS164	.95	74LS368	.69
74LS40	.30	74LS165	.95	74LS373	.99
74LS42	.49	74LS166	1.95	74LS374	1.69
74LS47	.75	74LS168	1.69	74LS377	1.40
74LS48	.75	74LS169	1.69	74LS378	1.15
74LS49	.75	74LS170	1.69	74LS379	1.35
74LS51	.30	74LS173	.75	74LS385	1.89
74LS54	.35	74LS174	.89	74LS386	.59
74LS55	.35	74LS175	.89	74LS390	1.79
74LS63	1.20	74LS181	1.99	74LS393	1.79
74LS73	.39	74LS189	9.50	74LS395	1.59
74LS74	.44	74LS190	.89	74LS399	1.59
74LS75	.49	74LS191	.89	74LS424	2.89
74LS76	.39	74LS192	.89	74LS447	.75
74LS78	.49	74LS193	.89	74LS490	1.89
74LS83	.75	74LS194	.89	74LS668	1.65
74LS85	.95	74LS195	.89	74LS669	1.85
74LS86	.39	74LS196	.79	74LS670	2.10
74LS90	.65	74LS197	.79	74LS674	9.50
74LS91	.79	74LS221	1.10	74LS682	2.99
74LS92	.65	74LS240	.95	74LS683	2.39
74LS93	.59	74LS241	.95	74LS684	2.39
74LS95	.79	74LS242	1.79	74LS685	2.39
74LS96	.79	74LS243	1.79	74LS688	2.39
74LS107	.39	74LS244	.95	74LS689	2.39
74LS109	.39	74LS245	1.89		
74LS112	.39	74LS247	.79	81LS95	1.65
74LS113	.39	74LS248	1.20	81LS96	1.65
74LS114	.49	74LS249	.89	81LS97	1.65
74LS122	.45	74LS251	1.25	81LS98	1.65

MISC.

Disc Controller

1771	20.95
1791	34.95
1793	34.95
1797	49.95

Uarts

AY3-1014	5.85
AY5-1013	3.90
AY5-2376	12.00
TR 1602	4.25

Interface

8T26	1.65
8T28	1.95
8T95	.95
8T96	.95
8T97	.95
8T98	.95
DM8131	2.90
DS8836	1.25

(800) 538-8800

ALL MERCHANDISE IS 100% GUARANTEED

DISKETTES 5 1/4"

ANTHANA SS SD Soft	23.95
WABASH SS SD Soft	23.95
VERBATIM SS SD Soft	28.95

IC Sockets ST W/W

8 PIN	.10	.49
14 PIN	.12	.50
16 PIN	.15	.57
18 PIN	.20	.85
20 PIN	.25	.99
22 PIN	.25	1.30
24 PIN	.25	1.40
28 PIN	.35	1.50
40 PIN	.40	1.80

ST = Soldertail
W/W = Wirewrap

CMOS

4000	.25	4071	.30
4001	.30	4072	.30
4002	.30	4073	.30
4006	.90	4075	.30
4007	.25	4076	.90
4008	.90	4078	.30
4009	.45	4081	.30
4010	.45	4082	.30
4011	.30	4085	.90
4012	.30	4086	.90
4013	.45	4093	.90
4014	.90	4098	2.49
4015	.90	4099	1.90
4016	.45	4502	.90
4017	1.15	4503	.60
4018	.90	4508	1.90
4019	.45	4510	.90
4020	.90	4511	.90
4021	.90	4512	.90
4022	1.10	4514	1.20
4023	.35	4515	2.20
4024	.75	4516	1.50
4025	.35	4518	1.20
4026	1.60	4519	1.20
4027	.60	4520	1.20
4028	.75	4522	1.20
4029	.90	4526	1.20
4030	.45	4527	1.90
4034	2.90	4528	1.20
4035	.85	4531	.90
4040	.90	4532	1.90
4041	1.20	4538	1.90
4042	.75	4539	1.90
4043	.75	4543	2.70
4044	.75	4555	.90
4046	.90	4556	.90
4047	.90	4581	1.90
4049	.50	4582	1.90
4050	.50	4584	.90
4015	.90	4585	.90
4053	.90		
4060	1.39	80C07	.90
4066	.75	80C95	.90
4068	.39	80C96	.90
4069	.30	80C97	.90
4070	.35	80C98	1.15

DoKay Computer Products, Inc.
3250 Keller Street, #9
Santa Clara, CA 95050
(800) 538-8800
Calif. Residents (408) 988-0697



TERMS: For shipping include \$2.00 for UPS Ground. \$3.00 for UPS Blue Label Air. \$10.00 minimum order. Bay Area residents add 6 1/2% Sales Tax. California residents add 6% Sales Tax. We reserve the right to limit quantities and substitute manufacturer. Prices subject to change without notice. Send SASE for complete list.



MICRO SALES

15381 CHEMICAL LANE ★ HUNTINGTON BEACH, CA 92649
★ (714) 891-2677 ★

★ SPECIALS OF THE MONTH ★

64K RAMS

These parts are starting to be short in supply, SO WE GOT 'EM for you. Buy now while the supply lasts.

4164 150NS +5V \$7.85 EA.



ONLY \$55.00

Perfect for 8" or 6" drive power. Comes with Shugart type connectors but 5" type can be put on. These are overstock from our Horizontal Cabinet shown below.
+5V @ 4A ● +24V or +12V @ 3A ● -5V @ 1A

BREAK THE COST BARRIER!

NOW IS YOUR CHANCE TO GET THAT COMPUTER LOOK AT THESE FEATURES!

- 4MHZ Z-80 CPU with 2 Programmable Serial and 3 Parallel Ports
- 64K Dynamic Ram w/Extended Addressing to 1MB
- Floppy Disk Controller with WD1795. Runs 8" or 5" Floppys Error Free
- 30 Amp Power Supply with S-100 MOD 12 Slot Mother with Regulated Floppy Supplies as Shown Below
- Tan and Charcoal Sturdy Steel Cabinet with Space for 2 Floppy Drives at Left (8" or 5")

★ DUAL DRIVE SUBSYSTEMS ★



HORIZONTAL



VERTICAL



MINI

- Power Supply for 2 801/851 DT8 etc.
- 50 Pin Ribbon Cable, 36"
- AC Cord, Fuse, Internal Wiring and Connectors

Assembled and Tested	\$ 245.00
w/2 Empty 5" (no P/S)	\$ 87.00
w/2 Empty 8" (no P/S)	\$ 95.00
w/2 801R Shugart	\$1045.00
w/2 851R Shugart	\$1395.00
w/2 QUME DT-8	\$1295.00
w/2 MPI B-51	\$ 675.00
w/2 MPI B-52	\$ 830.00
w/2 MPI B91	\$ 850.00
w/2 MPI B92	\$ 995.00

UNIVERSAL POWER SUPPLY For Big Board, Apple, Aim 65

- SPECIFICATIONS
- +5V @ 3 Amps
 - +12V @ .750 Amps
 - 12V @ .750 Amps
 - 5V @ .50 Amps



\$69.95

COMING NEXT MONTH — HARD DISK!

S100-12

\$1750 Retail ONLY \$1350.00

SOME MECHANICAL ASSEMBLY REQUIRED IN STOCK FOR IMMEDIATE SHIPMENT

CP/M* \$150
MP/M* \$350
DISC ACCES. \$50

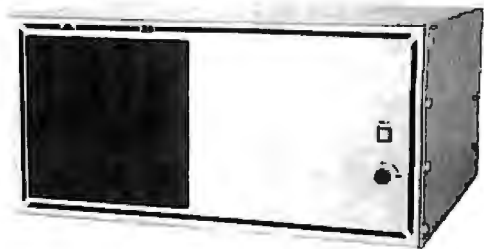

(Less Drives, Cables Pick-up Price)
*CP/M & MP/M are Trademarks of Digital Research

★ NEW ★ NEW ★ NEW ★

S-100-4

Complete 4 slot S-100 computer. Perfect for word processing, small business accounting, inventory control, etc. 1.2 megabytes of storage capacity on two 8" floppy drives. (Expandable to 2.4 megabytes using double sided operation.)

- 4MHZ Z-80A
- 64K Dynamic Ram
- 2 Serial Ports
- 3 Parallel Ports (8255)
- Steel Tan and Charcoal Case
- Includes CP/M*



SPECIAL INTRODUCTORY OFFER
\$1595.00
Complete, ready to attach Terminal and Printer (Offer ends Aug. 30, 1982)

XOR-CPU Z-80 4MHZ, Prom 2 Serial 3 Par	\$255
XOR-DSK WD-1795 MINI and 8"	\$275
XOR-64K Bank SW Memory up to 1 Meg	\$389
XOR-32K Static Ram (Kit)	\$199
XOR-MPM IO MPM Interface Card	\$335
XOR-DTC Hard Disk and DTC Tape	\$225
XOR-SMS Hard Disk Controller	\$750
XOR-SER 4 Channel Serial Board	\$195

★ XOR ★

★ SPECIALS OF THE QUARTER ★

S-100 MOD KIT BY XOR

\$199.00

For test or hobby applications complete S-100 12 Slot Sub-System power for up to 4 Floppy Disk Drives. (6 connectors supplied.)

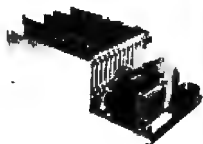

SPECIFICATIONS

UNREGULATED	REGULATED
• 12 Slots S-100	+5VDC @ 5 Amps
• +8VDC @ 30 Amps	+24VDC @ 4 Amps
• ±16VDC @ 6 Amps	-5VDC @ 1 Amp

8" FLOPPY DISK SS/DD FOR S-100-4, S-100-8 S-100-12

Fantastic bargain for our Special Customers!

\$29.95 per pkg of 10!

Guaranteed to work 100% double density on our system!!

S-100 CARD EXTENDER



\$12.50 (Gold Contacts)

As long as there is a price war, we will fight your battle. Compare at your local Deptstore and buy US Micro

S-100 POWER



\$89.50

Simple Brute Force! S-100 Power Supply, 30A @ +8V, 6A @ +16V, 6A @ -16V, PC Board Design.

12 SLOT MOTHER



\$22.50

We have connectors and power supply too. Start your system with quality components. Terminated. Connectors \$2.50 ea.

California Computer Systems



- 2810 CPU Only — \$255.00
- 2422 Dsk Cont Only — \$330.00
- 2065C 64K Only — \$320.00
- 2200A Mainframe Only — \$475.00
- CCS Apple Boards Call for prices
- CCS 2200 System Tested and Assembled Only — \$1,625.00

MICRO SALES

11 EDISON DRIVE ★ NEW LENOX ★ ILLINOIS 60451
 CALL TOLL FREE: 1-800-435-9357 ★ MONDAY thru SATURDAY
 (ILLINOIS RESIDENTS CALL: 815-485-4002) ★ 8:00 a.m. to 6:30 p.m.

TERMS: Prepayment — C.O.D. up to \$100.00 — M/C Visa
 \$5.00 Processing and Handling added to each order PLUS
 Shipping Charges. Please allow personal check to clear before shipment.
 15% Restocking Charge for Non-Defective, Returned Merchandise.
 Prices subject to change without notice.

★ SPECIAL ★ SPECIAL ★ SPECIAL ★

CCS SYSTEM 2410

FEATURES

- * DMA Disk Controller
- * 2-Real Time Clocks
- * 2-Serial/1-Parallel Port
- * Hardware Vectored Interrupts
- * Supports C/PM, M/PM, OASIS
- ***Comes with C/PM***
 only \$2,100.00

CONTROLLER BOARD FOR 8" and 5" DRIVES FOR THE Z-89, Z-90, or H-89 COMPUTERS....

Comes w/CPM 2.2 on 8" and 5" media Only \$550.00

SOFTWARE

ASHTON TATE	
dBASE II	\$560.00
DIGITAL RESEARCH	
C BASIC	\$118.00
MICRO PRO	
WORDSTAR	\$275.00
MAILMERS	\$115.00
DATA STAR	\$265.00
SUPERSORT I	\$190.00
SPELLSTAR	\$190.00
MICROSOFT	
BASIC 80	\$290.00
BASIC COMPILER	\$320.00
FORTRAN 80	\$400.00
COBOL 80	\$600.00
MACRO 80	\$165.00
SORCIM	
PASCAL/M	\$320.00
SUPERCALC	\$235.00
SUPERSOFT	
FORTH	\$170.00
SSS FORTRAN	\$215.00
DISK DOCTOR	\$85.00
C COMPILER	\$175.00

commodore
 computer systems
 CALL FOR PRICES

ZENITH | data systems
 CALL FOR PRICES

FEATURES! TERMINAL

- Feather Touch Capacitance Keyboard
- 60 Key Standard ASCII PLUS + Hex Keypad PLUS + 8 Special Function Keys PLUS + 20 Screen Editing Keys
- SOROC Type Screen Attribute Set
- Half Intensity

S-100-8

INCLUDING CP/M 2.2® AND WORDSTAR®

WITH: 8" SS/DD Drives Only \$2850.00
 5 1/4" SS/DD Drives Only \$2700.00

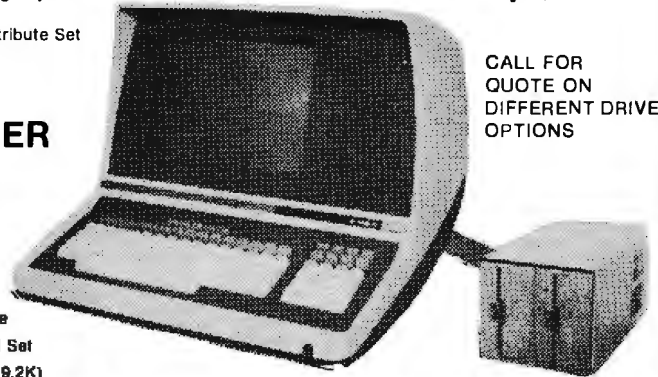

CALL FOR QUOTE ON DIFFERENT DRIVE OPTIONS

COMPUTER

- 8 Slot S-100
- 64K Dynamic Ram
- 4MHZ Z-80
- Double Density Disk Controller
- Programmable Baud Rate
- Programmable Keyboard Set
- Serial Printer Port (150-18.2K)

WORDSTAR is a TM of Micropro Inc. - CP/M 2.2 is a TM of Digital Research Inc.

MONITORS

BMC MONITORS-	
W/GREEN SCREEN	\$ 95.00
ZENITH VIDEO MONITOR-	
ZVM	\$145.00
AMDEK MONITORS-	
AMDEK Color 1	\$399.00
AMDEK Video 300	\$229.00
w/Green Screen	

DISK DRIVES

• Shugart 801's	\$395.00
• Shugart 851's	\$575.00
• Qume DT-8's	\$540.00
• SA 400	\$230.00
• SA 450	\$340.00
• SA 410 SS 96 TPI	\$375.00
• SA 460 DS 96 TPI	\$425.00
• TM 100-1	\$230.00
• TM 100-2	\$340.00
• TM 100-3	\$375.00
• TM 100-4	\$425.00
TANDON SLIMLINE	
• TM 848-1	\$480.00
• TM 848-2	\$550.00

COMPLETE LINE OF ADD ON DRIVES
 FOR APPLE — CALL FOR PRICES

TeleVideo
 SYSTEMS
 CALL FOR PRICES

PRINTERS

• C-I TOH PROWRITER	\$525.00
• C-I TOH F-10 40 CPS	\$1,500.00
• C-I TOH Comet II 132 Column Printer 9x7 Dot Matrix	\$810.00
• MPI-88G	\$600.00
• EPSON MX 80	CALL
• EPSON MX 100	CALL
• Anadex 9501 Graphic Printer	\$1,235.00
• OKIDATA 82A	\$465.00
• 83A and 84A	CALL



Apple 8" Disk Controller Card	
• ZVX4 Dual Density, Single & Double Sided - Auto Boot	\$395.00
• Disk 2 + 2 Single Density Single or Dual Sided	\$300.00

TERMINALS

• Adds Regent 20	\$570.00
• Televideo 910	\$575.00
• Televideo 912C	\$665.00
• Televideo 925C	\$740.00
• Televideo 950	\$950.00
• Ampex Dialog 80	\$895.00
• Zenith Z19	\$745.00

TELEVIDEO 950 & 800

SERIES USERS

Make Your
Televideo
Work
For You



TV-Setup provides a user-friendly menu for setting up the terminal features and programming the function keys. The entire setup - including function keys - is then saved in a file for easy reprogramming each time you start up your system. You can have one setup for Wordstar,™ another for dBase II,™ another for SuperCalc,™... as many different setups as you want.

Price: Only \$75.00 (VISA, MC accepted)

NEW GENERATION SYSTEMS

2153 Golf Course Drive, Reston, VA 22091
Phone: 703/476-9143

ORDER LINE (800) 368-3359

Circle 302 on inquiry card.

PASCAL TOOLS

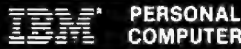

WITH SOURCE CODE

- Common logical and arithmetic procedures including a pseudo random number generator
- All string routines which extend PASCAL and give the capability of advanced BASIC
- Screen handler and command line parser
- Reference documentation, User Manual and source code provided

Send check or money order for \$95.00
(California residents add applicable sales tax)



1465 17th Avenue
San Francisco, CA 94122 (415) 665-4711

Circle 53 on inquiry card.

FROM **789.***



DAISYWHEEL LETTER-QUALITY PRINTER-TERMINAL

With our new Centronics Parallel and RS-232C Serial combination interface: 300/1200 Baud 960 character buffer • full KSR • all in one!

Olivetti PRAXIS 30 and 35 models available as exciting typewriter-printer-terminal complete with 90 day warranty and carrying case.

*Model 30 Parallel only

Test for this ad prepared on a Daisytype!™

SYSTEMED CORPORATION

P.O. Box 18, Shingletown Rd. M1 City, TN 37683
(615) 727-6000

Circle 390 on inquiry card.



VIC-20
\$249

800 COMPUTER (16K)	\$649.00
800 COMPUTER (48K)	\$768.00
400 COMPUTER (16K)	\$275.00
410 PROGRAM RECORDER	\$74.00
810 DISK DRIVE	\$439.00
NEC 8023A-C PRINTER	\$475.00
PERCOM D/D DISK DRIVE	\$589.00
850 INTERFACE MODULE	\$164.00
ENTERTAINER	\$82.00
EDUCATOR	\$119.00
PROGRAMMER	\$52.00
COMMUNICATOR	\$299.00
825 PRINTER (80 Col)	\$579.00
32K RAM (Microtek)	\$119.00
16K RAM (Microtek)	\$69.00
16K RAM (Cx-853)	\$79.00
LESTICK	\$30.00
TYPE 'N TALK	\$319.00

ATARI SOFTWARE

Macro Assem & Editor (D)	\$86.00	Andromeda (D)	\$295.00
MicroSoftBasic (D)	\$86.00	LetterPerfect (D)	\$109.95
PacMan (R)	\$33.00	HIREZ Vixen Princess (D)	\$25.50
Centipede (R)	\$33.00	HIREZ Vikings (D)	\$28.95
Assembler Editor (R)	\$45.00	Crossfire (C/D)	\$22.95
Crush Combs & Ch. (C/D)	\$33.50	Frigger (C/D)	\$26.95
Invasion Dragon (C/D)	\$19.50	Survival Adventure (C/D)	\$19.95
Star Wars (C/D)	\$30.95	ActionQuest (C/D)	\$23.50
Village (D)	\$19.95	Bug Attack (C/D)	\$23.50
Chinthee (D)	\$17.95	Mazy Maze (R)	\$35.95

WRITE FOR FREE CATALOG

COSMIC COMPUTERS

228 N. PROSPECTORS RD.
DIAMOND BAR, CA. 91765
PHONE OPEN SEVEN
DAYS 8 A.M. - 9 P.M.

D = DISK
C = CASSETTE
R = ROM
UNLIMITED
SHIPPING EXTRA \$2 MINIMUM PRICES
SUBJECT TO CHANGE CALIF. RESIDENTS ADD
TAX ATARI IS A TRADEMARK OF ATARI INC.
(714) 861-1265

Circle 119 on inquiry card.



YOU COMMAND
THE EARTH DEFENDER
AND PROTECT THE EARTH FROM
ATTACKING ALIENS, THREATENING
AND NUCLEAR MISSILES!
HURRY! ARM AND FIRE YOUR LASER!
SAVE YOUR PLANET... PERHAPS FROM ITSELF!

Only \$29.95 For Apple II or II+
DOS 3.3 Hi Res Graphics and Sounds
15 Day Money Back Guarantee

New Version 1982 Dept. A1-3 2375 Sandy Oak Dr. Doraville Ga. 30040
Copyright 1982 by NEW VISION 082 (404) 448-7827

Circle 303 on inquiry card.



FOR UCSD PASCAL* SYSTEMS

PDBASE an Entity Relational Data-base. Complete with English query language, formatted screen, procedure language, data security, multiple users, validity checking.

- Introductory Prices
\$245 - Interactive PDBASE
\$100 - Program interface for PDBASE
\$125 - Interactive spelling checker
\$100 - Complete LISP interpreter.

IOTC Inc.
910 Sully/Laramie, WY 82070
*Trademark Regents Univ. of Calif.
(307) 721-5818

Circle 209 on inquiry card.

MAILING LISTS

Reach
computer enthusiasts
interested in your products!

We're specialists in securing mailing lists of computer users and hobbyists. Current clients include some of the largest, most successful publishers and merchandisers selling computer related products by mail. Free consultation! Call or write today!

STEVE MILLARD, INC.
SPRING HILL ROAD — SHARON
PETERBOROUGH, NH 03458

ATTN: STEVE SMITH
603-924-9421

Circle 281 on inquiry card.

MICRO ARCHITECTS (OF TEXAS)

2114	200ns	\$1.72
2732	450ns	\$6.53
4116	200ns	\$1.27
6116	150ns	\$6.93

ADD \$3.50 ship. & hand.
Texas residents add 4% tax.

MICRO ARCHITECTS
P.O. Box 57796
WEBSTER, TEXAS 77598

SEND CHECK OR MONEY ORDER.

WANTED

Medical Office Software

We have a national sales force servicing the physician office marketplace.

If you want your existing practice management software to reach a larger market, contact:

P.O. Box 2096
Glenview, IL 60025

Your software must be compatible with IBM MICRO/MINI computer product lines.

CHIPS & DALE

THE INFLATION FIGHTERS!

4116 300ns 8/\$11.00
 4116 250ns 8/\$12.00
 4116 200ns 8/\$13.00
 4116 150ns 8/\$14.50
 2114L 300ns 8/\$15.00
 2114L 200ns 8/\$16.50
 *4164 200ns \$7.90
 *6116 150ns \$7.75

1791 Disk Controller \$17.00
 Z80A CPU \$5.50 ea.
 8251A \$4.75 ea.
 2716-1 (5V)350ns 8/\$6.50 ea. \$7.50 ea.
 2716 (5V)450ns 8/\$3.75 ea. \$4.15 ea.
 *2732 (5V)450ns 8/\$7.25 ea. \$9.00 ea.
 2532 (5V)450ns 8/\$7.25 ea. \$9.00 ea.
 27645V 300ns 28 pin \$20.00 ea.

Allow up to 3 wks. for personal checks to clear. Please include phone number. Prices subject to change without notice. Add \$3.50 Shipping & Handling. Wash. residents add 6.6% Sales Tax.

CHIPS & DALE
 10655 N.E. 4th St., Suite 400
 Bellevue, WA 98004
 1-206-451-9770

Master Charge
 Visa accepted

Circle 76 on Inquiry card.

PRICE BREAK

EPSON MX-100

ZIP BOX REFILLS DESIGNED TO FIT
 EPSON MX-100 CARTRIDGE

\$995

EA.

\$107.46 per dozen
Minimum Order 3 Ribbons
Price Includes Shipping
We accept Mastercard and Visa

CHECK-MATE™
 P.O. BOX 103, RANDOLPH, MA 02368
 Call Toll Free - 1-800-343-7706
 In Massachusetts - 617-963-7694

Circle 74 on Inquiry card.

E-Z SCReen EDItting with

SCRED™

VERSION 1.0

SCRED is a new editor for CP/M systems with memory mapped video boards.

- Immediate view of changes
- Assignable function keys
- Block move, copy, delete
- Re-definable CRT format
- Automatic BACKUP feature
- 8" SS SD CP/M compatible disk
- Width or length to 255 chrs

PRICE

\$95 - SCRED, the definition routine and manual
 \$15 - manual only
 (refunded if software purchased)

Write **SOFTWEST PRODUCTS**
 7046 Park Mesa Way
 Suite 36
 San Diego, CA 92111

Or phone (714) 571-3217

Calif. res. add 6% tax

Circle 378 on Inquiry card.

YOU'VE JUST
 FOUND



THE MISSING LINK!

Computer Shopper is your link to individuals who buy, sell and trade computer equipment and software among themselves nationwide. No other magazine fills this void in the marketplace chain.

Thousands of cost-conscious computer enthusiasts use Computer Shopper every month through hundreds of classified ads. And new equipment advertisers offer some of the lowest prices in the nation.

Subscribe to Computer Shopper with a **6 month trial for \$6 or 12 months for only \$10.** MasterCard & VISA accepted.
COMPUTER SHOPPER
 P.O. Box F-309 • Titusville, FL 32780
 305-269-3211

Circle 102 on Inquiry card.

Maxell Floppy Disks

The Mini-Disks
 with maximum quality.



Dealer inquiries
 invited. C.O.D.'s
 accepted. Call
 FREE (800) 235-4137.

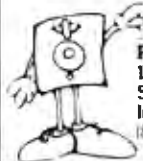

PACIFIC EXCHANGES
 100 Foothill Blvd. San Luis
 San Luis Obispo CA 93401
 In Cal call (800) 592-5935 or
 (805) 543-1037

Circle 314 on Inquiry card.

3D TIC TAC TOE \$14.95 3D TIC TAC TOE
 MOST FORMATS

HARDWARE

ALTOS
 ATARI
 DATA GENERAL
 EAGLE
 HAYES
 IMS
 NEC
 NORTHSTAR
 OKIDATA
 TALLY
 TEXAS INSTRUMENTS
 ZENITH



SOFTWARE

ASHTON TATE
 METASOFT
 MICROPRO
 MICROSOURCE
 CENTA SYSTEMS
 CHANG LAB.
 CONDOR
 CYMA
 DATASOFT
 E.F. HASKELL
 PHASE ONE
 SYSTEMS PLUS

AND MORE

FOR PRICE AND AVAILABILITY CALL

CREVELT COMPUTER SYSTEM, INC.
 3111 S. VALLEY VIEW E-103
 LAS VEGAS, NV. 89102
 702-362-6946

*Plus Shipping

VISA & MC

Circle 123 on Inquiry card.

New Available from Hytor —
 for
 Color Computer Disc System
 owners.

A software development
 system for only **\$60.00**
 includes 6809 Assembler
 Program Editor Loader
 and Memory Dump.

*Unleash the power of
 your Color Computer
 now.* Write or Call Today!

HYTOR INC.

P.O. Box 4996
 Scottsdale, Az. 85261
 (602) 863-3122

Circle 194 on inquiry card.

RS-232 GENDER REVERSERS



Do you always have the wrong sex RS-232 connector? Let us help you convert your males to females and your females to males. A set of both RS-232 Gender Reversers is only **\$34.95**

Send for our catalog of other RS-232
 problem solvers.

B & B ELECTRONICS
 Box 475B/Mendota, IL 61342
 815-539-5827

Circle 42 on inquiry card.

64K Expansion Memory for

**IBM® Personal
 Computer**

ALL THE MEMORY YOU'LL EVER NEED

- Maximize Advanced BASIC Program Capacity
- Increase VisiCalc® Worksheet space to 4 times
- Compile Pascal Programs

RELIABLE PERFORMANCE THAT'S GUARANTEED

- Parity Generate and Check
- Gold Plated Edge Connector
- Fully Tested and Burned In
- Full One Year Warranty

INTRODUCTORY OFFER **\$24500**

DCT Corporation

P.O. BOX 14734
 MINNEAPOLIS, MN 55414-0734
 PHONE (612) 379-9236



IBM IS A REGISTERED TRADEMARK OF IBM
 VISICALC IS A REGISTERED TRADEMARK OF PERSONAL SOFTWARE, INC.

Circle 149 on Inquiry card.

SPECIALS on INTEGRATED CIRCUITS

6502	7.45	10/6.95	50/6.55	100/6.15
6502A/6512A	8.40	10/7.95	50/7.35	100/6.90
6520 PIA	5.15	10/4.90	50/4.45	100/4.15
6522 VIA	6.45	10/6.10	50/5.75	100/5.45
6532	7.90	10/7.40	50/7.00	100/6.60
2114-L200		2.45	25/2.30	100/2.15
2114-L300		2.25	25/2.10	100/2.00
2716 EPROM	4.90	5/4.50		10/4.00
2532 EPROM	8.90	5/8.45		10/7.90
6116 Hitachi 2Kx8 CMOS RAM	8.90	5/8.45		10/7.90
4116-200 ns RAM				8 for 15
Zero Insertion Force 24 pin Socket				2.00
S-100 Wire Wrap Socket				2.40

A P Products 15% OFF
A P Hobby-Blox 15% OFF

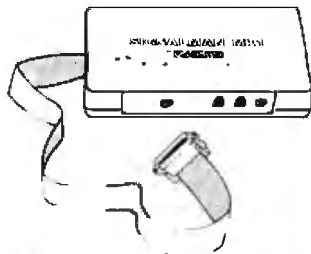

MODEM SPECIAL \$89

SIGNALMAN Mk1 from Anchor Automation
 DIRECT CONNECT Modem with RS232 Cable and Connector included. Fully compatible with all Bell 103 modems. 0 to 300 bps, full duplex, frequency shift keyed modulation, auto-select of ANSW/ORIG, direct connect, audible tone carrier detect indicator, self-contained battery powered.

Anchor ATARI Modem \$89

COMPACT INTELLIGENT TERMINAL PACKAGE \$115
 Combines intelligent RS232 port hardware from cgrs Micro-tech with EHS Intelligent Terminal software to allow you to connect any RS232 Modem to PET/CBM.

DC HAYES Smartmodem \$230
RS232 MODEM - Acoustic \$119

We carry Apple II+ from Bell & Howell



16K RAM Card for Apple	65.75
Thunderclock Plus for Apple	119
T G Products Joystick for Apple	48
D C Hayes Micromodem II	299
Grappler Interface	139
T G Paddles	32
T G Select-A-Port	48
Videx 80 Column Card	259

FLEX-FILE for PET/CBM \$80

Very comprehensive and easily used Data Base, Report Writer with calculation capability, and Mailing Label system.

FORTH for PET by Cargile/Riley \$50

Full FIG model with all 79 Standard extensions.

Metacompiler for FORTH for independent object code 30

KMMM PASCAL for PET/CBM 85

EARL for PET/CBM - disk assembler 65

Editor, Assembler, Relocator, Linkeditor.

SuperGraphics - BASIC Language Extensions 40

Fast Machine Language Graphics routines for PET/CBM.

Commodore



Commodore CBM-PET SPECIALS

Commodore 64		
8023 Wide (136 column) printer	(995)	770
8300 Daisy Wheel Printer (Diablo 630)	(2250)	1775
9000 SuperPET with languages	(1995)	1575
64K Board (extra 64K for 8032)	(500)	380
8050 Dual Disk Drive - 1 megabyte	(1795)	1300
8250 Dual Disk Drive - 2 megabyte	(2195)	1650
9060 5 meg hard disk	(2995)	2350
4016 full size graphics keyboard	(995)	765
4032 full size graphics keyboard	(1295)	965
4040 Dual Disk Drive - 330,000 bytes	(1295)	965
2031 Single Disk Drive - 165,000 bytes	(695)	530
4022 Tractor Feed Printer	(795)	600
C2N External Cassette Deck	(75)	65
Used CBM/PET Computers		CALL

WE WILL MATCH ANY ADVERTISED PRICE

★★★ EDUCATIONAL DISCOUNTS ★★★

PETSCAN I \$345 base price.

Allows you to connect up to 20 CBM/PET Computers to shared disk drives and printers. Completely transparent to the user. Perfect for schools or multiple word processing configurations. Base configuration supports 3 computers.

VIC 20	249	VIC Superlot	24
VIC 1515 Printer	335	VIC Super Alien	24
VIC 3K RAM	32	VIC Maze in 3-D	12
VIC 8K RAM	53	VIC Cosmic Debris	12
VIC 16K RAM	99	VIC Amok (UMI)	17
VIC 1540 Disk Drive	500	VIC Snakman	13
VIC Invaders	24	VIC Rubik's Cube	13
VIC Jupiter Lander	24	VIC Night Rider	11

TNW 488/103 with DAA	450
Compute's First Book of PET /CBM	11
WordPro 3 Plus - 32K CBM, disk, printer	195
WordPro 4 Plus - 8032, disk, printer	300
VISICALC for PET, ATARI, or APPLE	190
SM-KIT -PET ROM Utilities	40
Programmers Toolkit - PET ROM Utilities	35
PET Spacemaker II ROM Switch	36
2 Meter PET to IEEE or IEEE to IEEE Cable	40
Dust Cover for PET	8
IEEE-Parallel Printer Interface for PET	110
IEEE-RS232 Printer Interface for PET	120
The PET Revealed	17
Library of PET Subroutines	12

Programming the PET/CBM (Compute!) 20

Compute! First Book of VIC 11

Best of Midnight Gazette 8

4 PART HARMONY MUSIC SYSTEM for PET

The Visible Music Monitor, by Frank Levinson, allows you to easily enter, display, edit, and play 4 part harmony music. Includes whole notes thru 64ths (with dotted and triplets), tempo change, key signature, transpose, etc. The KL-4M unit includes D to A converter and amplifier ready to hook to your speaker.

KL-4M Music Board with VMM Program \$60

DISK SPECIALS



SCOTCH (3M) 5"	10/2.45	50/2.35	100/2.30
SCOTCH (3M) 8"	10/2.60	50/2.45	100/2.40

WE STOCK VERBATIM DISKS

Try the new Verbatim Head Cleaner Kits

BASF 5" or 8"	10/2.00	20/1.95	100/1.85
Wabash 5"	10/2.00	20/1.95	100/1.85
Wabash 8"	10/2.00	20/1.95	100/1.85

WE STOCK MAXELL DISKS

Diskette Storage Pages		10 for 3.95
Disk Library Cases	8" - 2.85	5" - 2.15
Disk Hub Rings	8" - 50 @ 7.50	5" - 50 @ 6.00

CASSETTES - AGFA PE-611 PREMIUM

High output, low noise, 5 screw housings.

C-10	10/56	50/50	100/48
C-30	10/73	50/68	100/66

SPECIALS

EPSON MX-80 Printer with Graftrax	
EPSON MX-80 F/T Printer	
EPSON MX-100 Printer with Graftrax	
Zenith ZVM-121 Green Phosphor Monitor	115
OKIDATA 82A	465
STARWRITER Daisy Wheel Printer F10	1445
D C Hayes Smartmodem	230
We Stock AMDEK Monitors	
Watanabe Intelligent Plotter 1195 6-Pen	1445
BMC BM12A Green Phosphor Monitor	99
MEMORY for IBM 256K + parity	500
Staticide anti-static spray	6
dBASE II	490

ALL BOOK and SOFTWARE PRICES DISCOUNTED

Synertek Systems

SYM-1 Microcomputer	SALE 199
SYM BAS-1 BASIC or RAE 1/2 Assembler	85
KTM-2/80 Synertek Video and Keyboard	349
KTM-3/80 Synertek Tubeless Terminal	385



Z90-80 64 K	2170
Z90-82 64K, 1 double dens. drive	2395
Z67 10 Megabyte + Floppy Drive	4495
Z37 1.3 Megabyte Dual Floppy	1495
Z25 High Speed Printer	1195
Z19 Video Terminal (VT-52 compatible)	695
ZVM-121 Green Phosphor Monitor	119
All Zenith Software discounted	

ZT-1 Intelligent Communications Terminal 550
Z100 16-bit/8-bit System CALL



800 Computer	675	Microsoft BASIC	72
400 - 16K	330	MISSILE COMMAND	32
810 Disk Drive	440	ASTEROIDS	32
825 Printer	629	STAR RAIDERS	37
850 Interface	170	Space Invaders	32
Inside Atari DDS	18	Music Composer	45
Paddle Pair	19	Chess	30
Joystick Pair	19	Anchor Modem-Atari	89
16K RAM	69	PAC-MAN	36
32K RAM	99	CENTIPEDE	36
Pilot	68	First Book of Atari	11

Write for prices on other Atari items.

WRITE FOR CATALOG

Add \$1.25 per order for shipping. We pay balance of UPS surface charges on all prepaid orders. Prices listed are on cash discount basis. Regular prices slightly higher. Prices subject to change.

252 Bethlehem Pike
 Colmar, PA 18915

215-822-7727

A B Computers

**BASF****Flexy-Disks®****SAVE 40%** Write for our complete list.

5 1/4" Specify soft, Price/10
10 or 16 sector

1 side/single density	\$26.70
1 side/double density	\$31.90
2 sides/double density	\$37.10

8" Specify soft or 32 sector

1 side/single density	\$26.70
1 side/double density	\$31.90
2 sides/double density	\$41.60

CHECKS — VISA — MC — C.O.D.
(313) 777-7780 ADD \$2 SHIPPING

LYBEN COMPUTER SYSTEMS
27204 Harper Ave.
St. Clair Shores, MI 48081

Circle 238 on inquiry card.

SMALL QUANTITIES AVAILABLE

STOCK COMPUTER FORMS

- CHECKS
- INVOICES
- STATEMENTS
- SPEED-O-GRAMS
- BILLS OF LADING
- PURCHASE ORDER
- LEGAL SIZE PAPER
- PAST DUE NOTICE
- C.O.D. TAGS
- LETTERHEADS



STOCK COMPUTER PAPER
STOCK COMPUTER LABELS
SOFTWARE PACKAGE FORMS

DDF DISCOUNT DATA FORMS, INC.
407 EISENHOWER LANE SOUTH
LOMBARD, ILLINOIS 60148
(312) 629-6850

Call or Write for Prices & Samples

Circle 147 on Inquiry card.

PHARMACY

To help you choose and use (and even program) **The PHARMACY MICRO-COMPUTER** — **NEW!** The first—and only—pharmacy microcomputer reference and guidebook. Developed to answer: **Why** do you want a computer? **Why** do you need a computer? **What** should the computer do for you? **How** do you plan your system? **Even how to write your own system!** This new book gives you all of the questions you should ask, and then it gives you all of the answers! **SAVE** with this **SPECIAL** pre-publication offer. The first edition goes to press July, 1982, and carries a list price of \$29.95, plus \$2.50 handling and shipping. **SAVE \$7.50** by sending in your reservation and check for \$24.95 by Aug. 31, 1982 (we'll pay the handling and shipping). *Or write for a subject outline and index.*

SIGNATURE Software Systems, Inc.
5602 Stouder Pl NW, Pickerington, OH 43147

Circle 368 on inquiry card.

SUPER SALE**EPROM's**

	1-7	8 up	50 up
2716 (5V, 450nS)	\$3.95	\$3.55	CALL
2732 (5V, 450nS)	7.85	6.95	CALL
2532 (5V, 450nS)	11.20	9.25	CALL

STATIC RAM

6116P-3 (150nS)	7.50	7.20	CALL
2114L-2 (200nS)	2.10	1.70	CALL

DYNAMIC RAM

4164 (200nS)	7.90	7.49	CALL
--------------	------	------	------

MISC

CPU Z80A	\$5.29 ea.
GDP-1854ACE (UART)	\$4.80 ea.
16K RAM Expansion Kit for TRS-80 Mod III	\$12.95/8



SUNTRONICS CO., INC.
12621 CRENSHAW BOULEVARD
HAWTHORNE, CALIFORNIA 90250

STORE HOURS: Mon.-Fri. 10am to 6:30pm — Sat. 10am to 5pm
IN CALIFORNIA OUTSIDE CALIFORNIA TOLL FREE

(213) 644-1149 1-800-421-5775

Min Order \$10. P.H. \$2. Accept VISA, Mastercard, Check or M.O.

Circle 385 on Inquiry card.

YOU CAN PAY MORE BUT YOU CAN'T GET MORE!

Model III 16K
\$799
Model III 48K
2 disk & RS232c
\$1949

BUY DIRECT. These are just a few of our great offers which include Printers, Modems, Computers, Peripherals, Disc Drives, Software and more. **CALL TOLL FREE 1-800-343-8124**

We have the lowest possible fully warranted prices and a full complement of Radio Shack Software.



Color Computer 16K
\$305
w/16K Ext. Basic
\$399
w/32K Ext. Basic
\$499

Write for your free catalog.
computer plus

245A Great Road
Littleton, MA 01460
617 • 486 • 3193

Circle 450 on Inquiry card.

PAPER

★TOP QUALITY★ BEST PRICE★

BOND PAPER 9 1/2 x 11 **23.95**
Blank, 1-part, 3000 sheets, 18 lb. stock
Perforated both sides, snaps out to 8 1/2 x 11

GREEN BAR 8 1/2 x 11 **23.95**
1-part, 3200 sheets, 15 lb. stock

GREEN BAR 14 3/8 x 11 **35.95**
1-part, 3200 sheets, 15 lb. stock

CARBONLESS 9 1/2 x 11 **45.95**
2-part, 1600 sheets, 15 lb. stock
Perforated both sides, snaps out to 8 1/2 x 11

Send check with order. Add \$6.00 per box for handling and shipping (UPS) within continental U.S. Calif. residents add 6% sales tax. Satisfaction guaranteed.

BOB'S CHARTS 405 E. THIRD, SUITE 206A
Computer Paper Dept. LONG BEACH, CA 90802
(213) 435-3492

Circle 56 on inquiry card.

For the IBM®-PC Exclusively**SOFTWARE**

Alpha Software	Date Base Manager	\$199.00
	Question	43.00
Cowshare Target	Planner Calc	58.00
Ultra	Volkswriter	150.00
Quinn	Blackjack	34.95
Sirus	Call to Arms	23.00
	Space Eggs	23.00

HARDWARE

Electrohome	RGB HI Res Monitor	\$821.00
	Cable for IBM-PC	46.00
Keyes	Smartmodem	237.00
(System Soft)	(PC Modem Software)	(49.95)
MBI	Computer-Mate Desk 4'	346.00
Synpac	Light pen with book of 15 programs for the IBM-PC	126.00
Zedex	Baby Blue CPU -	600.00

Also IDS Prism Printers, IUS, Infocom, McGraw Hill, Micropro, Visicorp, and more.

For a complete list of all the items we have for the IBM-PC, call or write

PC-CONNECTION

MILL STREET MARLOW NH 03456 603/446-3383
HOURS 9:00 to 5:30
VISA AND MASTERCARD ACCEPTED

TRADEMARK OF INTERNATIONAL BUSINESS MACHINES CORPORATION

Circle 318 on inquiry card.

ELIZA IS HERE!

AT LAST! A FULL IMPLEMENTATION of the original ELIZA program is now available to run on your microcomputer!

Created at MIT in 1966, ELIZA has become the world's most celebrated artificial intelligence demonstration program. ELIZA is a non-directive psychotherapist who analyzes each statement as you type it in and then responds with her own comment or question — and her remarks are often startlingly appropriate!

Designed to run on a large mainframe, ELIZA has hitherto been unavailable to personal computer users except in greatly stripped down versions lacking the sophistication which made the original program so fascinating.

Now, our new microcomputer version possessing the **FULL** power and range of expression of the original is being offered at the introductory price of only \$25. And if you want to find out how she does it (or teach her to do more), we will include the complete Source Program for only \$20 additional.

Order your copy of ELIZA today and you'll never again wonder how to respond when you hear someone say "Okay, let's see what this computer of yours can actually do!"

ELIZA IS AVAILABLE IN THE FOLLOWING DISK FORMATS:

1. Standard 8 inch single density for all CP/M based computers \$25 for ELIZA.COM — add \$20 for Microsoft BASIC-80 Source
2. 5 1/4 inch CP/M for Apple II equipped with 2-80 SoftCard \$25 for ELIZA.COM — add \$20 for Microsoft BASIC-80 Source
3. 5 1/4 inch for 48K Apple II with Applesoft ROM and DOS 3.3 \$25 for Protected File — add \$20 for ApplesoftSource
4. 5 1/4 inch for 64K IBM Personal Computer \$25 for Protected File — add \$20 for IBM Disk BASIC-Source
5. 5 1/4 inch for Osborne I Microcomputer \$25 for Protected File — add \$20 for Microsoft BASIC-80 Source

ARTIFICIAL INTELLIGENCE RESEARCH GROUP

921 NORTH LA JOLLA AVENUE
LOS ANGELES, CALIFORNIA 90045
(213) 656-7388 (213) 654-2214



MC, VISA and CHECKS ACCEPTED

Circle 35 on Inquiry card.

64K Dynamic RAM ICs

	200 ns	150 ns
Quantity	64K Ram	64K Ram
0 - 49	@ \$6.99	@ \$7.99
50 - 149	@ \$6.75	
150 +	@ \$6.50	

IN STOCK:

OKI MSM3764-20RS, Prime

UPS COD or VISA, M/C

MICROPROCESSORS UNLIMITED
24,000 SOUTH PEORIA AVENUE
BEGGS, OKLAHOMA 74421
(918) 267-4796

IMPORTANT: Prices shown include cash discount. Shipping & insurance extra. These prices are subject to change! Call for current prices, other brands, other speeds, or volume pricing. I WANT your business: call any hour (almost).

ALSO, HM6116-P3, 150 ns 2Kx8 static @ \$6.50
2114L-3, 200 ns 1Kx4 static @ \$1.65

Circle 275 on inquiry card.

WE WILL NOT BE UNDERSOLD

SOFTWARE

MICROPRO	
Wordstar	\$269.00
MailMerge	\$89.00
Customization Notes	\$359.00
Spellstar	\$239.00
Datastar	\$199.00
Calcstar	\$199.00
MICROSOFT	
Basic Interpreter	\$349.00
Basic Compiler	\$389.00
Fortran 80	\$499.00
Cobol 80	\$695.00
DATA BASE	
FMS80	\$595.00
dBase II	\$599.00

NEW! IBM PC SOFTWARE NEW!

INFORMATION UNLIMITED	
Easy Writer	\$289.00
Easy Speller	\$149.00
Easy Filer	\$319.00
VISICORP	
Visicalc 64K	\$159.00
Visicalc 256K	\$190.00
MICROPRO	
Wordstar	\$299.00
MISCELLANEOUS	
Supercalc by Sorcim	\$229.00
Superwriter by Sorcim	\$289.00
Home Accounting Plus	\$139.00
ENTERTAINMENT	
Deadline	\$39.00
Temple of Apshai	\$29.00
Curse of Ra	\$15.99
Call For More IBM Software And Accessories	

DISK DRIVES

CCI 100 for the TRS-80 Model 1	
5 1/4 40 track	\$299.00
CCI 189 for the Zenith Z-89	
5 1/4 40 track	\$379.00
CORVUS 5M with Mirror	\$3089.00
CORVUS 10M with Mirror	\$4489.00
CORVUS 20M with Mirror	\$5389.00
CORVUS interfaces	CALL
RANA SYSTEMS add-on Disc Drive for the Apple II	
Elite One 40 Track	CALL
Elite Controller	CALL

DISKETTES

Maxell 5 1/4 single side	\$39.00
Maxell 8 single side	\$49.00
Maxell 5 1/4 double side	\$45.00
Maxell 8 double side	\$55.00
BASF 5 1/4	\$26.95
BASF 8	\$36.00
Verbatim 5 1/4	\$26.95
Verbatim 8	\$36.00
Wabash 5 1/4	\$24.95
Wabash 8	\$29.95

IBM PC ACCESSORIES

64K Card by Microsoft	\$435.00
Joystick by T&G	\$49.00
128K Card	\$579.00
192K Card	\$629.00
256K Card	\$699.00
256K Combo by AST	\$1099.00
Combo Card by Apparat	\$249.00
Call for more IBM PC add-ons	

For fast delivery, send certified checks, money orders, or call to arrange direct bank wire transfers. Personal or company checks require one to three weeks to clear. All prices are mail order only and are subject to change without notice. Call for shipping charges.

APPLE SOFTWARE

MICROPRO	
Wordstar	\$239.00
MailMerge	\$99.00
Spellstar	\$149.00
DataStar	\$199.00
Calcstar	\$189.00
Supersort I	\$159.00
VISICORP	
VisiCalc	\$199.00
VisiTerm	\$79.00
VisiDex	\$199.00
VisiPlot	\$169.00
VisiFile	\$199.00
VisiSchedule	\$259.00
VisiTrend/Plot	\$239.00
VisiPac	\$539.00
MISCELLANEOUS	
Micro Courier	\$219.00
Screenwriter II	\$129.00
Executive Briefing System	\$169.00
Supercalc	\$199.00
Personal Filing System	\$115.00
PFS Report Writer	\$75.00
Word Handler	\$169.00
CP/M Power	\$59.00
ENTERTAINMENT	
Wizard and Princess	\$29.00
Space Eggs	\$26.00
Twerps	\$28.00
Borg	\$28.00
Castle Wolfenstein	\$27.00
Beer Run	\$28.00
Epoch	\$32.00
Sneakers	\$27.00
Midnight Magic	\$32.00
Wizardry	\$45.00
Time Zone	\$79.00
Jawbreaker	\$20.00
Tuesday Morning Quarterback	\$24.95
Crush, Crumble & Chomp	\$24.95
Datestones of Ryn	\$15.99
Morloc's Tower	\$15.99
Star Warrior	\$31.99
Snack Attack	\$23.95
Star Blazer	\$24.95
Kabul Spy	\$29.95
Cyclod	\$23.95

APPLE ACCESSORIES

Z-80 Card by Microsoft	\$319.00
16K Card by Microsoft	\$159.00
32K Card by Saturn	\$199.00
Keyboard Enhancer II by Videx	\$125.00
Videoterm by Videx	\$259.00
Game Paddles by TG	\$49.00
Joystick by TG	\$49.00
Numeric Keypad by Keyboard Co.	\$139.00
ALF 9 Voice Board	\$159.00
ALF 3 Voice Board	\$229.00
System Saver by Kensington	\$75.00
Versacard by Prometheus	\$229.00
8088 Card by Coprocessor	\$789.00
Microbuffer II 16K w/graphics	\$259.00
Microbuffer II 32K w/graphics	\$299.00
APPLE INTERFACE CARDS BY CCS	
Serial Asynch. #7710	\$139.00
Serial Synch. #7712	\$149.00
Call for other CCS cards	
ADVANCE LOGIC	
Add-Ram 16K Card	\$99.00
Z-Card CP/M for the Apple II	\$225.00
Smarterm80 Column Board w/Softswitch	\$249.00
The Synergizer	
All of the above plus "The CP/M Handbook"	\$545.00

RAM

16K Ram Kit for Apple II; TRS80	\$17.50
200 nano seconds, 4116 chips	

COMPUTERS

ATARI	
Atari 800	\$699.00
Atari 400	\$369.00
Call For Prices On The Complete Atari Line	
CALIFORNIA COMPUTER SYSTEM	
Mainframe 2200a	\$485.00
Z-80 CPU 2810a	\$265.00
64K RAM 2065	\$569.00
Floppy Controller 2422a	\$359.00
ZENITH	
Z-89 48K	CALL
Z-90 64K	CALL
Call For Prices On The Complete Zenith Line	
Commodore VIC 20	\$249.00
Casio FX702P Pocket Computer	\$179.00

PRINTERS

NEC 7710 Serial	\$2395.00
NEC 7720 KSR	\$2749.00
NEC 7730 Parallel	\$2395.00
NEC 3510 Serial	\$1850.00
NEC 3530 Parallel	\$1850.00
NEC 8023 Dot Matrix 100cps	\$539.00
Olivetti DY211 Letter Quality	
Daisy Wheel Printer	\$1095.00
Parallel Only	\$995.00
Epson MX-80	CALL
Epson MX-80FT	CALL
Epson MX-100	CALL
IDS 560	CALL
IDS Prism 80	CALL
IDS Prism 132	CALL
Okidata Microline 80	CALL
Okidata Microline 82A	CALL
Okidata Microline 83A	CALL
Okidata Microline 84	CALL
Centronics 739	\$675.00
DataSouth 180 cps	CALL
Zenith Z-25 150 cps	CALL

MONITORS

Amdek 12" B&W	\$109.00
Amdek 13" Color	\$329.00
Sanyo 9" B&W	\$135.00
Sanyo 9" Green	\$140.00
Sanyo 12" B&W	\$179.00
Sanyo 12" Green	\$189.00
Sanyo 13" Color	\$359.00
Zenith 12" Green	\$105.00
Zenith 13" Color	\$339.00
Electrohome 13" HI-RES	
Color Monitor	\$829.00
Electrohome 13" Color	\$349.00
Electrohome 12" B&W	\$179.00
Electrohome 12" Green	\$189.00
Electrohome 9" B&W	\$149.00
Electrohome 9" Green	\$159.00

SPECIAL OF THE MONTH
Sanyo MBC 1000 64K Computer
\$1595.00

TERMINALS

ADDS Viewpoint	\$495.00
Zenith Z-19	\$679.00
Televideo 910	\$595.00
Televideo 925	\$779.00
Televideo 950	\$969.00

TELECOMMUNICATIONS

Prentice Star Modem	\$129.00
Novation Cat Modem	\$139.00
Novation D-CAT	\$149.00
Novation AUTO-CAT	\$199.00
Novation APPLE CAT	\$299.00
Hayes Smart Modem	\$249.00
Hayes Micro-Modem	\$295.00
Hayes Chronograph	\$225.00

The CPU Shop

TO ORDER CALL TOLL FREE 1-800-343-6522

420-438 Rutherford Ave., Dept. BY-08, Charlestown, Massachusetts 02129



Hours: 9 AM - 9 PM (EST) Mon.-Fri. (Sat. till 7)
 Technical information call 617/242-3361

TWX- 710-348-1796

Massachusetts Residents call 617/242-3361
 Massachusetts Residents add 5% Sales Tax

Circle 120 on inquiry card.

TELEVIDEO USERS



SMART INTEGRAL
212A MODEM
FOR TELEVIDEO
TERMINALS
950, 925, 920,
910 SERIES

- Single card 5 1/2" x 9 1/2"
- Simple kit for individual installation
- Manual or auto dial with repeat
- Manual or auto answer
- Audio Monitor—listen to connection
- FCC approved direct connect
- Compatible with Bell 212A data set
- Dual speed; 0-300bps and 1200bps, keyboard selectable
- Adaptable to other ASCII terminals

Micro-Baud Systems, Inc.
3393 De La Cruz Blvd.
Santa Clara, CA 95050
(408) 727-5275

Circle 271 on Inquiry card.

STATISTICAL SOFTWARE

ELF—Stepwise regression, factor analysis, correlation coefficients, cross-tabs, simple statistics, t-tests, ANOVA, stepwise discriminant analysis, all BASIC transformations and more. \$200.00.

TWG/ARIMA—Box-Jenkins for seasonal and non-seasonal models. \$300.00.

EASI/ARIMA—Automatic Box-Jenkins program for stock and commodity traders. \$300.00.

All are for the Apple II* with 48K of memory, Applesoft* and DOS 3.3.

Visa and MasterCard accepted.
Call or write:

The Winchendon Group
3907 Lakota Road
P.O. Box 10114
Alexandria, VA 22310
(703) 960-2587

*Trademarks of Apple Computer, Inc.

Circle 431 on Inquiry card.

CP/M COMPATIBLE—CP/M EFFICIENT

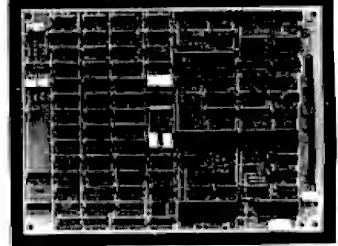

- 4 MHz Z-80A CPU • Two banks of 64K RAM
- Two RS-232 serial ports • Full centronics printer port • True hard disk interface • External DMA I/O • Compatible with 5 inch and 8 inch drives, single/double density • Real time clock • 5 volts only at 1.5 amps • Compact size • Source Listings are included

Special introductory offer
Only 600.00



INSIGHT ENTERPRISES CORPORATION
373 N Western Ave., Suite 12
Los Angeles, CA 90004. (213) 461-3262

Dealer, OEM. International Inquiries Welcome

Circle 202 on inquiry card.

HIGH QUALITY

CONTROL DATA FLEXIBLE DISKS

5 1/4" Soft sector Price/10
1 side/ single density \$23.00
1 side/ double density 26.60

8" Soft sector
1 side/ single density 25.00
1 side/ double density 30.00

Money orders—Checks—Allow two weeks
Add \$ 2.00 Handling charge
California residents add 6.5% sales tax

Creativity Unlimited

Dept. No. BY082 P.O. Box 3304
Saratoga, California 95070-1304

Circle 122 on Inquiry card.

Verbatim® Diskettes



Top-quality Verbatim® Diskettes from **Tech•Data**, your complete word and data processing supply center. Dealer inquiries invited.

Call Toll Free
1-800-237-8931.
In Florida, call
813-577-2794.

Tech•Data Corporation
3251 Tech Drive North
St. Petersburg, FL 33702

Circle 396 on Inquiry card.

SUPER SALE 30%+ DISCOUNTS

SOFTWARE

	LIST SALE
*Micropro® CP/M I	495 276
A1010 WORDSTAR	350 183
A1012 DATASTAR	150 85
A1014 MAILMERGE	250 138
A1015 FELLSTAR	250 138
A1018 SUPERSORT	150 85
A1020 WORDMASTER	250 138
A1022 CALCSTAR	148 811
*MicroSoft® CP/M II	350 231
A1024 BASIC80	250 138
A1026 BASI CCOMPL	250 261
A1028 FORTRAN80	500 330
A1030 COBOL80	750 456
*8" CP/M	448 811
A1110 IS4 SPELLGUARD	250 138
A1120 ORCIMSUPERCALC	250 138
A1130 SELECTWORDPROC	595 340
*VisiCorp® APPLE	448 811
A2000 VISICALC	250 138
A2020 VISIPILOT	300 165
A2040 VISITRENDPLOT	300 215
A2060 VISIDEX	250 138
A2080 VISIFERN	100 75
A2100 DESKTOP PLAN II	250 138
A2120 VISISCHEDULE	300 215
A2160 VISIPAK	700 405
*IBM	448 811
A1216 VISICALC	200 145
A1220 VISICALC256K	250 138
A1225 ORCIMSUPERCALC	295 196
HARDWARE	
A8010 NEC 8023Printer	695 470
A8020 AXIOM GP 100 Printer/Centronics Interface	389 300
A8030 RC A UPD® Terminal	250 250
A8040 FRANKLIN ACE 100	1495 930
A8050 ATARI 8001Bk	899 662
A8070 TI 99-4 COMPUTER	451 282
A8120 EAGLE II Computer w/ SYSTEMS PLUS Business System	4995 3496

DISCOUNT COMPUTER PRODUCTS

205 S. McKemy St., CHANDLER, AZ 85224. Send \$1 for GIANT Catalog, Shipping & Handling; Software—\$2.00 ea. Hardware—\$2.50/#, \$3.00 min. Price includes Cash Discount, Visa/MC/Amx add 3%. ORDER NOW. TOLL FREE OPER. #742 CA. 800-852-7777, HIAK. 800-824-7919. ELSEWHERE 800-824-7888. AD #10

Circle 437 on Inquiry card.

80,000 WORDS!

WORD GRINDER IS AN ASCII DICTIONARY OF OVER 80,000 ENGLISH WORDS WHICH IS COMPATIBLE WITH THE POPULAR PROOF READERS SUCH AS SPELLSTAR, SPELLGUARD, AND ANY OTHER PROOFER WHICH ALLOWS THE COMBINING OF ASCII FILES INTO ITS DICTIONARY. WORD GRINDER REQUIRES 3/4 MEGA-BYTE OF STORAGE AND IS AVAILABLE ON 1 FILE ON EACH OF 4 CP/M DISKS. ALSO AVAILABLE ON ANSI TAPE, TRS-80, RT-11, OR APPLE DISKS. PRICES START AT \$125.00 FOR CP/M. ORDERS: DIGITAL WORD SYSTEMS, DEPT. B, 22713 VENTURA BL., STE. F, WOODLAND HILLS CA. 91364. VISA/M.C. PHONE: 213-992-0514

SPELLSTAR IS A TRADEMARK OF MICROPRO INTERNATIONAL CORP. OF SAN RAFAEL, CALIF. U.S.A.
SPELLGUARD IS A TRADEMARK OF ISA.
TRS-80 IS A TRADEMARK OF TANDY CORP.
CP/M IS A TRADEMARK OF DIGITAL RESEARCH.

Circle 478 on Inquiry card.

YORK 10 BASF-DPS WORLD STANDARD TAPE



MONEY BACK GUARANTEE

COMPUTER GRADE BLANK CASSETTES

"We monitored the output to the computer with a specially built meter and found absolutely no dropouts throughout the tape . . ."
Stace Papadopoulos
Beaverton, OR

ITEM	1 DOZ.	2 DOZ.
C-05	7.50	13.50
C-10	8.00	14.40
C-20	10.00	18.00
HardBox	2.50	4.00
Soft Box	2.00	3.40

Calif. residents add 9% sales tax
Shipping 1 doz. \$2, 2 doz. \$3.50,
3 doz. \$4.50. Each additional doz \$5.00.
Wholesale!! for QUANTITY DISCOUNTS
We IMMEDIATELY PAYMENT by
Credit Card
Order
Call: 213/710-1430

YORK 10 Computerware
24573 Kittridge St. B-3 Canoga Park, CA 91307

Circle 482 on Inquiry card.

Get more out of your Apple with the MICRO on the Apple Series

Vols. 1, 2, & 3 \$24.95 ea.
+ \$2.00 shipping each volume

Each book includes more than 30 programs all on DISKETTE

- Machine Language Aids
- I/O Enhancements
- Runtime Utilities
- Graphics & Games
- Hardware & Reference Information

To order toll free:
1-800-345-8112
In PA 1-800-662-2444
MICRO INK, Inc.
P.O. Box 6502
Chelmsford, MA 01824

Circle 480 on Inquiry card.

FOR ONLY \$129.95 Learn Computing From The Ground Up

Build a Computer kit that grows with you, and can expand to 64k RAM, Microsoft BASIC, Text Editor/Assembler, Word Processor, Floppy Disks and more.

EXPLORER/85

Here's the lowest cost way to learn the fundamentals of computing, the all-important basics you'll need more and more as you advance in computer skills. For just \$129.95 you get the advanced design Explorer/85 computer kit with all the features you need to learn how to write and use programs. And it can grow into a system that is a match for any personal computer on the market. Look at these features: 8085 Central Processing Unit, the microprocessor "the heart" of the Explorer/85. (Join the millions who will buy and use the 8080/8085 in a year alone)... Four 8-bit plus one 6-bit input/output ports from which you can input and output your programs, as well as control exterior switches, relays, lights, etc. a cassette interface that lets you store and load programs you've learned to write... **Unlink 2,000 byte operations system/monitor** makes it easy to learn computing in several important ways... It allows simpler, faster writing and entering of programs... It permits access by you to all parts of the system so you can check on the status of any point in the program... It allows tracing each program step by step, with provision for displaying all the contents of the CPU (registers, flags, etc.)... and it does much more!

You get all this in the starting level (Level A) of the Explorer/85 for only \$129.95. Incredible! To use, just plug in your 8VDC power supply and terminal or keyboard/display... if you don't have them, see our special offers below.

Level A computer kit (Terminal Version) ... \$129.95 plus \$3 P&I.
Level A kit (Hex Keypad/Display Version) ... \$129.95 plus \$3 P&I.*

LEVEL B — This "building block" converts the motherboard into a two-slot S100 bus (industry standard) computer. Now you can plug in any of the hundreds of S100 cards available.
Level B kit ... \$49.95 plus \$2 P&I.*
S100 bus connectors (two required) ... \$4.85 each, postpaid.

LEVEL C — Add still more computing power; this "building block" mounts directly on the motherboard and increases the S100 bus to six slots.
Level C kit ... \$99.95 plus \$2 P&I.*
S100 bus connectors (five required) ... \$4.85 each, postpaid.

LEVEL D — When you reach the point in learning that requires more memory, we offer two choices: either add 4k of a memory directly on the motherboard, or add 16k to 64k of memory by means of a single S100 card... our famous "JAWS."
D kit (CHECK ONE) □ 4k on-board ... \$49.95 plus \$2 P&I.* □ 16k S100 "JAWS" ... \$149.95 plus \$2 P&I.* □ 32k S100 "JAWS" ... \$199.95 plus \$2 P&I.* □ 48k S100 "JAWS" ... \$249.95 plus \$2 P&I.* □ 64k S100 "JAWS" ... \$299.95 plus \$2 P&I.*

LEVEL E — An important "building block," it activates the ROM/EPROM space on the motherboard. Now just plug in our 8k Microsoft BASIC or your own custom programs.
Level E kit ... \$3.95 plus 50¢ P&I.*

Microsoft BASIC — It is the language that allows you to write English to your computer.
□ 8k cassette version of Microsoft BASIC (requires Level B and 12k of RAM minimum; we suggest a 16k S100 "JAWS" — see above) ... \$64.95 postpaid.
□ 8k ROM version of Microsoft BASIC (requires Level B & Level E and 4k RAM; just plus in our Level E kit) ... \$64.95 postpaid.
We suggest either the 4k Level D RAM expansion or a 16k S100 "JAWS" ... \$99.95 plus \$2 P&I.*
□ Disk version of Microsoft BASIC (requires Level B, 32k of RAM, floppy disk controller, 8" floppy disk drive) ... \$325 postpaid.

TEXT EDITOR/ASSEMBLER — The editor/assembler is a software tool (a program) designed to simplify the task of writing programs. As your programs become longer and more complex, the assembler can save you many hours of programming time. This software includes an editor of program that enters the programs you write, makes changes, and saves the program on cassette. The assembler performs the task of translating symbolic code into the computer-readable object code. The editor/assembler program is available either in cassette or a ROM version.
Editor/Assembler (Cassette version, requires Level B and 8k (min) of RAM; we suggest 16k "JAWS" — see above) ... \$59.95 plus \$2 P&I.*
Editor/Assembler (ROM version, supplied on an S100 card; requires Level B and 4k RAM (min) — we suggest either Level D or 16k "JAWS") ... \$99.95 plus \$2 P&I.*

FLOPPY DISK — A remarkable "building block." Add our 8" floppy disk when you need faster operation, more convenient program storage, perhaps a business application, and access to the literally thousands of programs and program languages available today. You simply plug them into your Explorer/85 disk system — it accepts all IBM formatted CP/M programs.
8" Floppy Disk Drive ... \$499.95 plus \$12 P&I.*
Floppy Controller Card ... \$199.95 plus \$2 P&I.*
Disk Drive Cabinet & Power Supply ... \$69.95 plus \$3 P&I.*

Drive Cables (set up for two drives) ... \$25.00 plus \$1.50 P&I.*
CP/M 2.2 Disk Operating System; includes Text Editor/Assembler, dynamic debugger, and other features that give you Explorer/85 access to thousands of existing CP/M-based programs ... \$15.00 postpaid.
NEED A POWER SUPPLY? Consider our AP-1. It can supply all the power you need for a fully expanded Explorer/85 (note: disk drives have their own powersupply). Plus the AP-1 fits neatly into the attractive Explorer steel cabinet (see below).
AP-1 Power Supply kit (8V @ 5 amps) in deluxe steel cabinet ... \$39.95 plus \$2 P&I.*

NEED A TERMINAL? We offer you choices: the least expensive one is our Hex Keypad/Display kit that displays the information on a calculator-type screen. The other choice is our ASCII Keyboard/Computer Terminal kit, that can be used with either



1. Plug in Netronics's Hex Keypad/Display
2. Add Level B to convert it to 64k RAM
3. Add 4k RAM
4. Plug in Level E; here, we connect Microsoft BASIC to the Explorer/85
5. Add two S100 boards
6. Add your own custom circuits (prototyping area)
7. Connect terminal

a CRT monitor or a TV set (if you have an RF modulator).
□ Hex Keypad/Display kit ... \$69.95 plus \$2 P&I.*

FASTERM-64 TERMINAL KIT — Featuring a 56 key ASCII Keyboard, 128 character set upper and lower case 75 ohm output & baud rates 150, 300, 600, 1200, 2400, 4800, 9600, RS232C or 20 mA current loop, 32 or 64 character by 16 line formats, complete with Deluxe Steel Cabinet and Power Supply ... \$199.95 plus \$3 P&I.*

RF Modulator kit (allows you to use your TV set as a monitor) ... \$8.95 postpaid.
12" Video Monitor (10MHz bandwidth) ... \$139.95 plus \$3 P&I.*
Deluxe Steel Cabinet for the Explorer/85 ... \$49.95 plus \$3 P&I.*
Pan for cabinet ... \$15.00 plus \$1.50 P&I.*



ORDER A SPECIAL-PRICE EXPLORER/85 PAK — THERE'S ONE FOR EVERY NEED.

Beginner Pak (Save \$26.00) — You get Level A (Terminal Version) with Monitor Source Listing (\$25 value) AP-1, 5-amp power supply, Intel 8085 Users Manual (Reg. \$199.95) SPECIAL \$169.95 plus \$3 P&I.*
Explorer Pak (Save \$53.40) — You get Level A (Hex Keypad/Display Version) with Hex Keypad/Display, Intel 8085 User Manual, Level A Hex Monitor Source Listing, and AP-1, 5-amp power supply ... (Reg. \$279.95) SPECIAL \$219.95 plus \$6 P&I.*
Special Microsoft BASIC Pak (Saves \$103.00) — You get Levels A (Terminal Version), B, D (4k RAM), E, 8k Microsoft in ROM, Intel 8085 User Manual, Level A Monitor Source Listing, and AP-1, 5-amp power supply (Reg. \$439.70) SPECIAL \$339.95 plus \$7 P&I.*
Add a Rom-Version Text Editor/Assembler (Requires levels B and D or S100 Memory) ... \$99.95 plus \$2 P&I.*

Starter 8" Disk System — Includes Level A, B floppy disk controller, one CDC 8" disk drive, two-drive cable, two S100 connectors; just add your own power supplies, cabinets and hardware ... □ (Reg. \$1065.00) SPECIAL \$999.95 plus \$13 P&I.* □ 32k Starter System, \$1045.95 plus \$13 P&I.* □ 48k Starter System, \$1095.95 plus \$13 P&I.* □ 64k Starter System, \$1145.95 plus \$13 P&I.*
Add to any of above Explorer steel cabinet, AP-1 (five amp power supply, Level C with two S100 connectors, disk drive cabinet and power supply, two sub-D connectors for connecting your printer and terminal ... (Reg. \$279.95) SPECIAL \$199.95 plus \$3 P&I.*
Complete 64k System, Wired & Tested ... \$1650.00 plus \$26 P&I.*
Special! Complete Business Software Pak (Save \$625.00) — Includes CP/M 2.2 Microsoft BASIC, General Ledger, Accounts Receivable, Accounts Payable, Payroll Package ... (Reg. \$1325) SPECIAL \$699.95 postpaid.

*P&I stands for "postage & insurance." For Canadian orders, double this amount.

Continental Credit Card Buyers Outside Connecticut:
TO ORDER
Call Toll Free:
800-243-7428

To Order From Connecticut, or For Technical Assistance, Call (203) 354-9375

CP/M is a reg. trademark of Digital Research

★ (Clip and mail entire ad) ★

SEND ME THE ITEMS CHECKED ABOVE
Total Enclosed (Conn. Residents add sales tax) \$ _____
Paid by:

□ Personal Check □ Cashier's Check/Money Order
□ VISA □ MASTER CARD (Bank No. _____)

Acct. No. _____ Exp. Date _____

Signature _____

Print Name _____

Address _____

City _____

State _____ Zip _____

ANNOUNCING TWO NEW TERMINALS

Smart • Fast • Graphics • Matching Modem and \$295 Printer

Netronics announces a state of the art breakthrough in terminals. Now at prices you can afford, you can go on-line with data-bank and computer phone-line services. It's all yours: "electronic newspapers," educational services, Dow-Jones stock reports, games, recipes, personal computing with any level language, program exchanges, electronic bulletin boards... and more every day!!!



Netronics offers two new terminals, both feature a full 56 key/128 character typewriter-style keyboard, baud rates to 19.2 kilobaud, a rugged steel cabinet and power supply. The simplest one, FASTERM-64, is a 16 line by 64 or 32 character per line unit, with a serial printer port for making hard copy of all incoming data, and optional provisions for block and special character graphics. The "smart" version, SMARTERM-80, features either 24 line by 80 characters per line or 16 by 40 characters per line, 10 characters on-screen adding with page-at-time printing, 12,000 pixel graphics, line graphics, absolute cursor addressing, underlining, reverse video, one-half intensity and much more... simply plug them into your computer or our phone modem and be on-line instantly. Use your TV set (RF modulator required) or our deluxe green-phosphor monitor pictured above. For hard copy just add our matched printer.

Price breakthrough!!! Own the FASTERM-64, a complete terminal kit, ready to plug in for just \$199.95 or order the SMARTERM-80 kit for just \$299.95, (both available wired and tested.) Be on-line with the million-dollar computers and data services today... we even supply the necessary subscription forms.

More good news! All the components in our terminals are available separately (see coupon), so you buy only what you need!!!

FASTERM-64 ... DISPLAY FORMAT: 64 or 32 characters/line by 16 lines ... 96 displayable ASCII characters (upper & lower case) ... 8 baud rates: 150, 300, 600, 1200, 2400, 4800, 9600, 19,200, (switch sel.) ... LINE OUTPUT: RS232C or 20 ma current loop ... VIDEO OUTPUT: 1V P/P (EIA RS-170) ... CURSOR MODES: home & clear screen, erase to end of line, erase cursor line, cursor up & down, auto carriage return/line feed at end of line & auto scrolling ... REVERSE VIDEO ... BLINKING CURSOR ... PARITY: off, even or odd ... STOP BITS: 1, 1.5, 2 ... DATA BITS PER CHARACTER: 5, 6, 7 or 8 ... CHARACTER OUTPUT: 5 by 7 dot matrix in a 7 by 12 cell ... PRINTER OUTPUT: prints all incoming data ... 1K ON BOARD RAM ... 2K ON BOARD ROM ... CRYSTAL CONTROLLED COMPLETE WITH POWER SUPPLY ... OPTIONAL GRAPHICS MODE: includes 34 Greek & math characters plus 30 special graphics characters ... ASCII ENCODED KEYBOARD: 56 key/128 characters.
SMARTERM-80 ... DISPLAY FORMAT: 80 characters by 24 lines or 40 characters by 16 lines 128 displayable ASCII characters (upper & lower case) 8 baud rates: 110, 300, 600, 1200, 2400, 4800, 9600 ... LINE OUTPUT: RS232C or 20 ma current loop ... VIDEO OUTPUT: 1V P/P (EIA RS-170) ... EDITING FEATURES: insert/delete line, insert/delete character, forward/back tab ... LINE OR PAGE TRANSMIT ... PAGE PRINT FUNCTION ... CURSOR POSITIONING: up, down, right, left, plus absolute cursor positioning with read back ... VISUAL ATTRIBUTES: underline, blink, reverse video, half intensity, & blank ... GRAPHICS: 12,000 pixel resolution block plus line graphics ... ON-SCREEN PARITY INDICATOR ... PARITY: off, even or odd ... STOP BITS: 1 to baud 2, all others 1 ... CHAR. OUTPUT: 7 by 11 character in a 12 by 12 block ... LINE OUTPUT: 60 OR 50 Hz VERTICAL REFRESH ... BLINKING BLOCK CURSOR ... CRYSTAL CONTROLLED ... 2K ON BOARD RAM ... ASCII ENCODED KEYBOARD: 56 key/128 character ... 4K ON BOARD ROM ... COMPLETE WITH POWER SUPPLY.

TELEPHONE MODEM 103 O/A ... FULL DUPLEX, FCC APPROVED ... DATA RATE: 300 baud ... INTERFACE: RS232C and TTY ... CONTROLS: talk/data switch (no need to connect and disconnect phone), originate/answer switch on rear panel ... NO POWER SUPPLY REQUIRED.
ASCII KEYBOARD ASCII-3 ... 56 KEY/128 CHARACTER ASCII ENCODED ... UPPER & LOWER CASE ... FULLY DEBOUNCED ... 2 KEY ROLL-OVER ... POS OR NEG LOGIC WITH POS STROBE ... REQUIRES +5 & -12V DC (SUPPLIED FROM VIDEO BOARDS)
PRINTER COMET I ... SERIAL I/O TO 9600 BAUD ... 80 CHARACTER COLUMN (132 COMPRESSED), 10" TRACTOR FEED UPPER/LOWER CASE ... INDUSTRY STANDARD RIBBONS 4 CHARACTER SIZES ... 9 BY 7 DOT MATRIX ... BI-DIRECTIONAL PRINTING



Continental U.S.A. Credit Card Buyers Outside Connecticut
CALL TOLL FREE 800-243-7428

To Order From Connecticut Or For Tech. Assist. Call (203) 354-9375

NETRONICS R&D LTD. Dept.
333 Litchfield Road, New Milford, CT 06778
Please send the items checked below:

- COMPLETE FASTERM-64 TERMINAL (includes FASTVID-64 video board ASCII-3 keyboard, steel cabinet and power supply) ... kit \$199.95 plus \$3 P&I ... wired & tested \$249.95 plus \$3 P&I ... graphics option: add \$19.95 to each of above
- COMPLETE SMARTERM-80 TERMINAL (includes SMARTVID-80 video board, ASCII-3 keyboard, steel cabinet and power supply) ... kit \$299.95 plus \$3 P&I ... wired and tested \$369.95 plus \$3 P&I
- FASTVID-64 VIDEO BOARD (requires +5 & -12V DC) ... kit \$99.95 plus \$3 P&I ... graphics option add \$19.95 ... wired & tested \$129.95 plus \$3 P&I ... graphics option add \$19.95
- SMARTVID-80 VIDEO BOARD (requires +5 & +/-12V DC) ... kit \$199.95 plus \$3 P&I ... wired & tested \$249.95 plus \$3 P&I
- DELUXE STEEL TERMINAL CABINET ... \$19.95 plus \$3 P&I
- ASCII-3 KEYBOARD (requires +5 & -12VDC) ... kit \$69.95 plus \$3 P&I ... wired and tested \$89.95 plus \$3 P&I
- POWER SUPPLY (powers ASCII-3 keyboard & video boards) ... kit only \$19.95 plus \$2 P&I
- ZENITH VIDEO MONITOR (high resolution green phosphor) ... wired & tested \$149.95 plus \$6 P&I
- TELEPHONE MODEM MODEL 103 O/A ... wired & tested \$189.95 plus \$3 P&I
- DOT MATRIX PRINTER Comet I ... wired & tested \$299.95 plus \$10 P&I
- RF MODULATOR MOD RF-1 ... kit only \$8.95 plus \$1 P&I
- 3FT-25 LEAD MODEM/TERMINAL OR PRINTER/TERMINAL CONNECTOR CABLE ... \$14.95 ea plus \$2 P&I

For Canadian orders, double the postage. Conn. res. add sales tax.

Total Enclosed \$ _____

□ Personal Check □ Cashier's Check/Money Order

□ VISA □ MasterCard (Bank No. _____)

Acct. No. _____ Exp. Date _____

Signature _____
Print Name _____
Address _____
City _____ State _____ Zip _____

NETRONICS Research & Development Ltd.
333 Litchfield Road, New Milford, CT 06778

NEW! M-68000
SINGLE BOARD COMPUTER



FEATURES:
16 bit Motorola 68000 CPU operating at 10MHz, 20K bytes of on-board fast static RAM, 16K bytes of on-board EPROM space, 7 levels of prioritized auto-vectored interrupts, 2 memory expansion buses (up to 256K), 2 serial communication ports (RS-232C), 16-bit bidirectional parallel port, 880 peripheral accommodation bus, 516-bit counter/timers with vectored interrupts, on-board real time clock, software compatible with Motorola MEX68KROM board.

PRICE:
Bare board with documentation \$99.95
MEX68KROM compatible monitor in 3704 EPROM's \$129.00
MEX6800 CPU & memory map PROM \$119.00
Shipping and handling (Domestic) \$3.00
(Foreign) \$15.00

EMS Electronical
Microcomputer
Systems
P.O. BOX 16115 IRVINE, CA 92715-1115

714-553-0133

Circle 161 on inquiry card.

NEW!
MEGARAM
IBM COMPATIBLE MEMORY BOARD



*Registered Trademark of IBM

FEATURES:
On Board Memory Expansion from 64K to 1M Byte
Memory Write Protect Command
Program Controlled Banking Capability in 128K or 512K Blocks
Memory Error Detection
Flexible Memory Boundary Selection
On Board Two MDOS Supported Asynchronous RS-232-C Ports
Price Starts at \$495.00

EMS Electronical
Microcomputer
Systems
P.O. BOX 16115, IRVINE, CA 92713
(714) 553-0133 (714) 727-0202

Circle 162 on inquiry card.

NEW! S-100 BUS COMPATIBLE
SINGLE BOARD COMPUTER WITH VIDEO OUTPUT



USES:
This card can function as a stand alone single board computer or as 100 intelligent video interface card

FEATURES:
4 MHz Z 8001, up to 8K of EPROM, up to 1K Static RAM, 8088 BIT input ports, one 8 BIT output port, one 8 BIT active input port with interrupt, compact video output (80x24), video attributes (reverse video, underline), bitmaps, graphic capabilities

PRICE:
Bare board with documentation \$69.95
Monitor and video terminal package on EPROM's \$45.00
Source listings (with Monitor purchase) \$19.00
Hard to find Paris Kit (crystal and late link PROM's) \$19.00

EMS Electronical
Microcomputer
Systems
P.O. BOX 16115, IRVINE, CA 92715-1115
714-553-0133

Circle 163 on inquiry card.

SAVE 25% ON YOUR
IBM PERSONAL COMPUTER

IF YOU ARE BUYING OR UPGRADING WE CAN SAVE YOU A BUNDLE

- *DISK DRIVE TWO SIDED \$305
- *16K MEMORY KIT \$25
- *NEC 8023 & CABLE \$529
- *64K MEM CARD W/2-RS232 + PTR PORTS \$450
- *NECPRI (PRINT UTILITY FOR NEC 8023A) \$15

PLUS A LOT MORE INCLUDING:
*EPSON, OKIDATA & LETTER QUALITY PRINTERS
*MODEMS, COLOR MONITORS, 3M DISKETTES
*KEYBOARD & MONITOR EXTENSION CORDS
*CONDOR DBMS

800-521-0521 IN MICH: 313-429-2678

AEGIS SYSTEMS

P.O. BOX 401
202 W. BENNETT ST.
SALINE, MI 48176

Circle 11 on Inquiry card.

5 Meg Hard Disk
\$600.00

Introductory Offer — expand to Winchester Technology at 1/2 price.

Shugart SA1002 8" Hard Disk Drive. Optional controllers for IBM, S-100, STD BUS and others available.

Call Dave Starr at:
COMPUTER DYNAMICS, INC.
[803] 877-7471
105 S. Main St. Greer, S.C. 29615

Circle 94 on Inquiry card.

ATARI
A Home Computers Company



800 (16K)	\$649.00
400 16K	279.00
400 YOURS to 32K or 48K	CALL
410 RECORDER	79.00
810 DISK DRIVE	449.00
850 INTERFACE	165.00
830 MODEM	149.00
825 PRINTER	575.00
481 ENTERTAINER KIT	79.00
484 COMMUNICATOR KIT	309.00
PRINTERS — Atari, Epson, Smith Corona	CALL

Prices subject to change without notice. Shipping extra. No tax out of state. Ca. residents add appropriate taxes.

WE ARE AN AUTHORIZED ATARI SALES AND SERVICE CENTER

COMPUTERTIME, INC.
P.O. Box 216
Kentfield, CA 94914
CALL TOLL-FREE 800-227-2520
In California 800-772-4064
For product and price list: send \$2.00 for shipping.

Circle 106 on Inquiry card.

Future Shock!

age 65
years worked 40
retirement benefits 0

The U.S. Department of Labor has a free booklet that will help you answer these questions and a lot more. Send for it today.
Write: Pensions, Consumer Information Center, Pueblo, Colorado 81009

U.S. Department of Labor

wabash®

When it comes to Flexible Disks, nobody does it better than Wabash.

MasterCard, Visa Accepted.
Call Free: (800) 235-4137

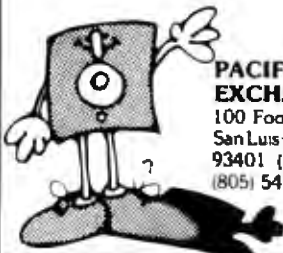

PACIFIC EXCHANGES
100 Foothill Blvd
San Luis Obspo. CA
93401 (In Cal call
(805) 543-1037)

Circle 314 on inquiry card.

Votrax® SC-01A
SPEECH SYNTHESIZER

\$70 Each (5 or more, \$55 each)

Order in Ones or Thousands

The SC-01A Speech Synthesizer is a completely self-contained solid state device. This single chip phonetically synthesizes continuous speech of unlimited vocabulary.

The SC-01A contains 64 different phonemes which are accessed by a 6-bit code. Computer interlaces and text-to-speech algorithms also available for product development.

Votrax is a trademark of Federal Screw Works
Call 1-800-645-3479, in N.Y. 1-516-374-6793

MICROMINT INC.
917 Midway
Woodmere, N.Y. 11598



Call for quantity pricing.

Circle 364 on inquiry card.

We Have It!.. At the best prices.

SUPER COMPUTER VALUE FROM CALIFORNIA COMPUTER SYSTEMS

4MHz, Z-80, 64K RAM, Disk Controller, C/P/M 2.2	
w/dual 5 1/4" SS DD	\$2349
w/dual 5 1/4" DS DD	2599
w/dual 8" SS DD	2995
w/dual 8" DS DD	3595

INTERTEC SUPERBRAIN II Free! MicroSoft Basic 80

Self-contained computer with dual disks and two RS232C ports. Complete with CP/M 2.2. 64K Double Density. **NEW LOW!** \$2099
64K Quad Density. **NEW LOW!** 2495

VIDEO TERMINALS

INTERTEC INTERTUBE III	749
ZENITH Z-19	729
SOROC IQ 120	649
SOROC IQ 130	595
SOROC IQ 135	749
SOROC IQ 135G	799
SOROC IQ 140	1149
HAZELTINE ESPRIT	CALL
1420	CALL
1500	CALL
1510	CALL
1520	CALL
TELEVIDEO 910C	CALL
912C	CALL
920C	CALL
925C	CALL
950C	CALL
TEXAS INST. 940 BASIC	1599
940 Package	2079
745 Portable Terminal	1399
745 Portable Terminal w/U/L/Case	1495

PRINTERS

ANADEX DP-9500	\$1349
DP-9501	1349
PAPER TIGER IDS-560G	1139
PRISM PRINTER IDS-80, w/o color	Call
IDS-80, w/color	Call
IDS-132, w/color	1695
NEC 3510, RO RS232C 35CPS	1945
NEC 3530, RO, Centr. Inter. 35CPS	1945
NEC 7710, RO RS232C 55CPS	2395
NEC 7720, KSR, RS232C 55CPS	2999
NEC 7730, RO, Centr. Inter. 55CPS	2395
QUME	
Sprint 9/45, LTD, 45 CPS, RS232C	2119
C.I.TOH Pro Writer, Parallel	549
Serial and Parallel	629
DIABLO 630, RS232C, 55 CPS	2299
CENTRONICS 730-1, Parallel	399
730-3, RS232C	489
739-1 w/Graphics, Parallel	525
739-3B w/Graphics, RS232C	639
704-11, Parallel	1695
704-9, RS232C	1595
122G, Parallel, 120 CPS	949
EPSON	
MX80	489
MX80FT	589
MX100FT	789
RS232 Serial Interface	65
RS232/2K BufferInterface	125
Graftrax II	90
Apple Printer Interface	75
Ti810 Basic, RS232C	1349
810 Basic, RS232C & Parallel	1395
810 w/full ASCII, vertical forms control compressed print	1599
820 RO, Basic	1645
820 KSR, Basic	1839

OKIDATA

Microline 80	\$465
Tractor-feed option	59
Microline 82A	519
Microline 83A	849
Microline 84	1199

MONITORS

ZENITH-ZYM-121, 12" Green Phos.	\$125
AMDEK 100, 12"	139
100G, 12" Green Phosphor	149
300, 12" Green Phos., Hi. Res.	199
Color, 13"	359
Color II, 13", R.G.B. Hi Res.	799
Apple adapt. for R.G.B.	159
BMC, 12", Green Phosphor	169

NORTH STAR Call For Prices

FLOPPY DISK SYSTEMS

MORROW DESIGNS	
Discus 2D, single drive DD	\$898*
Dual Discus 2D, dual drive DD	1549*
Discus 2 + 2, double sided DD	1239*
Dual Discus 2 + 2	2139
*Includes CP/M 2 + 2 and Microsoft Basic	

HARD DISK SUBSYSTEMS

MORROW DESIGNS	
Discus M-5 5 Meg.	\$1849*
Discus M-10 10 Meg.	3095*
Discus M-20 20 Meg.	4069*
Discus M-26, 26 Meg.	3795*
CORVUS 5 Meg.	3185
10 Meg.	4545
20 Meg.	5499
KONAN David 5 Meg.	2499
10 Meg.	3049
15 Meg.	3295
INTERTEC 10 Meg.	SPECIAL \$3195
*S-100 only w/CP/M 2 + 2 & Microsoft Basic	

FLOPPY DISK CONTROLLER BOARDS

CROMEMCO 16FDC DD	\$499
NORTH STAR DD	479
MORROW Disk Jockey 2D, A&T	329
SD SYS. Versafloppy I, A&T	319
SD SYS. Versafloppy II, A&T	429
DELTA DD Disk Cont., A&T	345
CONDUCTOR DD, A&T	269
INTERSYSTEMS, FDC-2, A&T	439
TARBELL DD, A&T	445
SYSTEMS GROUP DD DMA	439

ESCON CONVERSION FOR IBM SELECTRIC

Complete with microprocessor controller and power supply. Factory built. User installs solenoid assembly or it can be done at ESCON Factory.
RS232 Serial & Parallel. \$534
Cable for above. 25

PROM PROGRAMMERS

SSM PB1 Kit	\$152
SSM PB1, A&T	225

MODEMS

NOVATION CAT Acoustic Modem	\$149
D-CAT Direct Connect	155
AUTO-CAT Auto Ans.	219
APPLE CAT	329
USD 103 LP Direct Connect	175
103 JLP Auto Answer	209
DC HAYES MICROMODEM II (Apple)	299
MODEM 100 (S 100)	339
Smart Modem (RS 232)	239
Potomac Micro Magic (S 100)	339

CALIFORNIA COMPUTER SYSTEMS

Z80 CPU Board	\$269
Disk Controller 2422, w/CP/M	359
16K Static, A&T	259
32K Static, A&T	399
64K Dynamic RAM	335
System 2210 w/64K, CP/M 2.2	1495

CPU BOARDS

(assembled unless noted)

NORTHSTAR Z-80A (ZPB-A/A)	\$269
INTERSYSTEMS (MPU-80)	349
SSM CB1 8080, A&T	214
CB2, Z-80, A&T	289
CB2, Z-80, Kit	219
DELTA Z-80 with I/O	289
SD SYSTEMS, SBC-100, A&T	349
SBC-200, A&T	399
SYSTEMS GROUP Z-80 with I/O	419

MEMORY BOARDS

NORTHSTAR 16K RAM	\$299
HRAM 64K	589
HRAM 32K	419
CROMEMCO 16KZ	419
CROMEMCO 64KZ	595

MEMORY MERCHANT

16K Static, 4MHz	159
64K Static, 4MHz	549

SYSTEMS GROUP

(Measurement Systems & Controls)

DM4800 48K Board	499
DM6400 64K Board	529
DMB6400 64K Board	595
INTERSYSTEMS 64K Dynamic	845

GODBOUT (A&T)

CPU Z	\$249
CPU 8085 88	359
RAM 20 30	359
RAM 17 64	675
RAM 21	1439
Interface 1	210
Interface 2	210
Disk 1	419
System Support 1	335
Enclosure 2 (Desk)	699
Enclosure 2 (Rack)	760

VIDEO BOARDS I/O Mapped

SD SYSTEMS	
VDB-8024, A&T	\$469
SSM VB2 I/O, Kit	169
VB2 I/O, A&T	229
MEMORY MAPPED	
VB1C, 16x64, Kit	152
VB1C, 16x64, A&T	206
VB3, 80 Char. 4MHz, Kit	359
VB3, 80 Char. 4MHz, A&T	419

APPLE BOARDS

CALIFORNIA COMPUTER	
7710A Asynchronous Ser Interface	\$129
7712A Synchronous Der Interface	149
7424A Calendar Clock	99
7728A Centronics Printer Interface	99

MOUNTAIN HARDWARE

CPS Multifunction Board	\$199
Supertalker SD200	259
Romplus w/ keyboard filter	179
Romplus w/o keyboard filter	130
Keyboard filter ROM	49
COPYROM	49
Music System	459
ROMWRITER	149
Apple Clock	239
A/D-D/A	295
Expansion Chassis	625
VISTA	
8" Disk Controller (Apple II)	\$495

All prices, F.O.B. shipping point, subject to change. All offers subject to withdrawal without notice. Advertised prices reflect a 2% cash discount (order prepaid prior to shipment). C.O.D.'s and credits cards are 2% higher.

MiniMicroMart, Inc.

943 W. Genesee St. P.O. Box 2991B Syracuse, N.Y. 13220 (315) 422-4467 TWX 710-542-0431

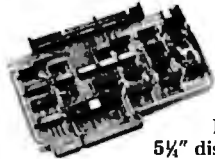

leath Users

**Double Your
5 1/4" disk storage
capacity without adding a drive.**

Get twice as much from your H88 or H89 microcomputer. Our FDC-880H floppy disk controller, in conjunction with your 5 1/4" drives, for example, expands memory capacity from 256 bytes to 512 bytes per sector.

And it handles single and double-sided, single and double-density, 8" and 5 1/4" drives — simultaneously.

Call 714/275-1272 today or write for details.



C.D.R. Systems Inc.

Controlled Data Recording Systems, Inc.
7667 Vickers St., San Diego, CA 92111

Circle 70 on inquiry card.

Electronic Circuit Analysis

- DC and AC analysis
- Very fast, machine language
- Infinite circuits on multiple passes
- Worst case, sensitivity analysis
- Dynamic modification
- 64 Nodes, 127 branches
- Compare circuits
- Log or linear sweep
- Full file handling
- Frequency response, magnitude and phase
- Complete manual with examples
- TRS-80 (TRSDOS) \$90.00
- CP/M \$150.00

Tatum Labs
P.O. Box 722
Hawleyville, CT
06440
(203) 426-2184

Circle 395 on Inquiry card.



NEW

LETTER
QUALITY

- RS232C, Serial Interface
- Parallel Interface
- Smith Corona TP1

\$599

MICRO TECHNOLOGY
7817 Ivanhoe Ave.
La Jolla, CA 92037
(714) 457-2149

5 1/4" Floppy Disk Drives

(Direct IBM Plug in)

TANDON Model TM 100-1 **\$219.95*** ea.
2 or more — \$214.95 ea.*
Floppy Drive Power Connector Kit \$2.00*
Tandon Manual and Schematic \$3.00*
12" Green Phosphor Zenith Monitor \$119.95*
We also stock TM-100-2's, the TM 602S, 603S,
and the 603E Winchester Drives.

CALL NOW - TOLL FREE

800-824-7888 all states except CA.
800-852-7777 for CA residents.
Ask for Operator #99.

MC/VISA or C.O.D. with certified check
or money order. Kansas residents add
3% sales tax.

*Plus shipping.
For info call: 316-683-9225
316-685-9445



923 Longfellow Street
Wichita, KS 67207

GRAPHIC SOFTWARE ON CP/M FOR ENGINEERING & BUSINESS SYSTEMS

ON PLOTTERS, CRT'S, DOT MATRICES, AND D.P. PRINTERS

FOR BUSINESS, ENGINEERING, AND SCIENTIFIC APPLICATIONS

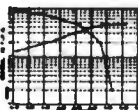
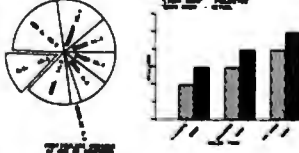

PLOTWARE-Z
TRY IT OUT AND BUY
FROM YOUR DEALER, OR CALL
THE ENERCOMP COMPANY

P.O. Box 28014
186000th St. #200
1303 1988 - 1848

PLOTWARE-Z GIVES YOU HIGHER RESOLUTION GRAPHICS,
NOT A "BUCKLEY" MESSY MAPPED DRAWING WITH BOXES
INTERACTING, MENU DRIVEN, EDIT MODES: PDOWN, LOS, ETC
AND ASCII BINARY FILES, DR, PLOTTERPRINT, SPHERE,
COMPILES LABEL FILES, VERTICENTRIG, SECTION, ETC.
EASY USER INTERFACE AND P. PRINTERS: DOME, DIBLO,
AND TANDON SPHERES (COMPATIBLE), SOLCOMP, DIBLO, PLOTTER
AND TANDON SPHERES (COMPATIBLE), PDP11, PERMIS ELEM, IBM
COMPTON QUALITY CONNECTOR SET (SAME HERE) OR COMPLEX
SCRIPT, ITALICS, GOTHIC, ARABIC, OR NAME YOUR OWN !!
\$399 COMPLETE, \$35 MANUAL ONLY, VISA, M.C.
\$125 NO DRAWING TOTAL BY PLATWARE-Z ON DISPLAY ONLY



BASF FlexyDisks®

5 1/4"

Specify soft, 10 or 16 sector	Price/10	Price/100
1 side/double density	\$20.00	\$185.00
2 sided/double density	34.50	325.00

8"

Specify soft of 32 sector	Price/30	Price/100
1 side/single density	\$21.00	\$195.00
1 side/double density	29.50	275.00
2 sided/double density	34.50	325.00

Certified Check - Money Order - Personal Check
Allow up to 2 weeks for personal checks to clear.
Add \$1.50 to each order for U.P.S. shipping charges.

**DATA
EXCHANGE, INC.**

280 Dukas Parkway, P.O. Box 85
Somerville, N.J. 08876 • (201) 725-6680



Scotch DISKETTES

SAVE 40% Write for our
complete list.

5 1/4"	Specify soft, 10 or 16 sector	Price/10
#744	1 side/sgl dens.	\$26.70
#744D	1 side/dbl dens.	31.20
#745	2 sides/dbl dens.	38.40

8"	Specify soft or 32 sector	Price/30
#740	1 side/sgl dens.	27.30
#741	1 side/dbl dens.	35.80
#743	2 sides/dbl dens.	43.60

CHECKS — VISA — MC — C.O.D.
(313) 777-7780 ADD \$2 SHIPPING

LYBEN COMPUTER SYSTEMS
27204 Harper Ave.
St. Clair Shores, MI 48081

Authorized Distributor
Information Processing Products



Circle 239 on inquiry card.

EDGE-86 AN INDUSTRIAL QUALITY 8086 OEM SYSTEM

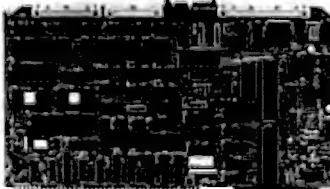

- **HARDWARE**
 - A Multibus® COMPATIBLE 8086 CPU BOARD WITH DMA FLOPPY CONTROLLER, INTERRUPT CONTROLLER, PROGRAMMABLE TIMERS, 3 SERIAL PORTS, TWO PARALLEL I/O PORTS, AND 8K BYTES OF PROM WITH BOOT STRAP LOADER FOR CP/M/86™.
 - 128K BYTES DYNAMIC RAM BOARD.
 - 4-SLOT MULTIBUS CARD CAGE, WITH COMPLETE DOCUMENTATION AND SCHEMATICS: ALL FOR..... \$1250.
- **SOFTWARE**
 - CP/M/86 O.S. WITH COMPLETE UTILITIES... \$250.
 - OFF THE SHELF DELIVERY.

EDGE MICRO SYSTEMS
195 W. EL CAMINO REAL, SUNNYVALE, CA 94086
TELEPHONE: 408-738-4729

* Multibus™ of 1982. ** CP/M™ of Digital Research

T.H.E. SMART TERMINAL®



Software that turns your Atari 400 or 300 into a real smart terminal. Send and receive data from all popular data services. Works with cassette or disk for upload/download. 16K min. Available at Atari Dealers Worldwide or directly from Binary. VISA/MC/AMEX/COD/CHECK. Cassette \$49.95 Disk \$49.95 add \$2.50 P & H U.S.. \$5.00 overseas.

BINARY™

Computer Software
3237 Woodward Ave.
Berkley, MI 48072
(313) 548-0533

BINARY CORPORATION

Printer & Disk Drive Sale

Dot Matrix Printers

NEW EPSONS with GRAFTRAX-plus

Epson has improved and upgraded their best selling line of printers to include their new GRAFTRAX-plus graphics package. Features now include: 9 x 9 matrix, bi-directional logic seeking, line spacing to n/216, programmable forms length and horizontal tabs, skip over perf, italics fonts, international symbols, superscript/subscript, normal, emphasized, double-strike, and double-emphasized print, underlining, line drawing graphics, 60/120 DPI bit image, software reset, adjustable right margin, and true back space.

MX-80 with GRAFTRAX-plus 80/132 column, 80 CPS, adjustable pin feed, parallel interface.
PRM-28080 MX-80 w/GRAFTRAX-plus \$479.95

MX-80FT with GRAFTRAX-plus same as MX-80 with friction feed and pin feed.
PRM-28082 MX-80FT w/GRAFTRAX-plus \$559.95

MX-100 with GRAFTRAX-plus 132/232 column, correspondence quality, up to 15" paper, friction feed & adjustable pin feed, 18 x 18 dot matrix, 80 CPS.
PRM-28100 MX-100 w/GRAFTRAX-plus \$754.95

PRA-27084 Serial interface \$54.95
PRA-27088 Serial int'l & 2K buffer \$99.95
PRA-27081 Apple card \$39.95
PRA-27082 Apple cable \$19.95
PRA-27086 IEEE 488 card \$59.95
PRA-27087 TRS-80 cable \$24.95
PRA-27097 GRAFTRAX-plus MX-80, FT \$59.95
PRA-27197 GRAFTRAX-plus MX-100 \$64.95
PRA-27090 MX-80, FT print head \$44.95
PRA-27190 MX-100 print head \$49.95
PRA-27083 MX-80 ribbon cart. \$13.95
PRA-27101 MX-100 ribbon only \$9.95

BETTER THAN EPSON! - Okidata

Microline 82A 80/132 column, 120 CPS, 9 x 9 dot matrix, friction feed, pin feed, adjustable tractor feed (optional), handles 4 part forms up to 9.5" wide, rear & bottom feed, paper tear bar, 100% duty cycle/200,000,000 character print head, bi-directional logic seeking, both serial & parallel interfaces included, front panel switch & program control of 10 different form lengths, uses inexpensive spool type ribbons, double width & condensed characters, true lower case descenders & graphics
PRM-43082 Friction & pin feed \$499.95

Microline 83A 132/232 column, 120 CPS, forms up to 15" wide, removable tractor, plus all the features of the 82A.
PRM-43083 with FREE tractor \$744.95

Microline 84 132/232 column, Hi-speed 200 CPS, full dot graphics built in, plus all the features of the 83A.
PRM-43084 Centronics parallel \$1149.95
PRM-43085 Serial with 2K buffer \$1249.95

PRA-27081 Apple card \$39.95
PRA-27082 Apple cable \$19.95
PRA-27087 TRS-80 cable \$24.95
PRA-43081 2K hi speed serial card \$99.95
PRA-43082 Hi-res graphics ROMs 82A \$49.95
PRA-43083 Hi-graphics ROMs 83A \$49.95
PRA-43088 Tractor option for 82A \$49.95
PRA-43080 Extra ribbons pkg. of 2 \$9.95

8023 DOT MATRIX - NEC

100 CPS, proportional spacing, hi-resolution graphics, correspondence quality printing, bi-directional tractor & friction feed.

NEC-8023A 8023 parallel \$499.95
NEC-8023-01 8023 ribbon \$11.95

PRINTER PALS - F.M.J. Inc.

Desk top printer stand and continuous form paper holder.
PRA-99080 for MX-80, MX-80FT, Oki 82A, NEC .. \$29.95
PRA-99100 for MX-100, Oki 83A & 84 \$34.95
PRA-99700 for letter quality printers \$49.95

Jade Bus Probe

THE BUS PROBE - Jade

Inexpensive S-100 Diagnostic Analyzer

Double-high S-100 board which displays all 96 IEEE S-100 signals without the expense of an oscilloscope or a front panel
TSX-200B Bare board \$59.95
TSX-200K Kit \$119.95
TSX-2300A A&T \$149.95

Dual Disk Sub-Systems

Disk Sub-Systems - Jade

Handsome metal cabinet with proportionally balanced air flow system, rugged dual drive power supply, power cable kit, power switch, line cord, fuse holder, cooling fan, never-mar rubber feet, all necessary hardware to mount 2-8" disk drives, power supply, and fan, does not include signal cable.

Dual 8" Sub-Assembly Cabinet

END-000420 Bare cabinet \$59.95
END-000421 Cabinet kit \$225.00
END-000431 A & T \$359.95

8" Sub-Systems - Single Sided, Double Density

END-000423 Kit w/2 FD100-8Ds \$975.00
END-000424 A & T w/2 FD100-8Ds \$1175.00
END-000433 Kit w/2 SA-801Rs \$999.95
END-000434 A & T w/2 SA-801Rs \$1195.00

8" Sub-Systems - Double Sided, Double Density

END-000426 Kit w/2 DT-8s \$1224.95
END-000427 A & T w/2 DT-8s \$1424.95
END-000436 Kit w/2 SA-851Rs \$1274.95
END-000437 A & T w/2 SA-851Rs \$1474.95

5 1/4" Disk Drives

Tandon TM100-1 single-sided double-density 48 TPI
MSM-551001 \$248.95 ea 2 for \$219.95 ea

Shugart SA400L single-sided double-density 40 track
MSM-104000 \$234.95 ea 2 for \$224.95 ea

Shugart SA455 half-size double-sided 48 TPI
MSM-104550 \$349.95 ea 2 for \$329.95 ea

Shugart SA465 half-size double-sided 96 TPI
MSM-104650 \$399.95 ea 2 for \$379.95 ea

Tandon TM100-2 double-sided double-density 48 TPI
MSM-551002 \$324.95 ea 2 for \$298.95 ea

Shugart SA450 double-sided double-density 35 track
MSM-104500 \$349.95 ea 2 for \$329.95 ea

Tandon TM100-3 single-sided double-density 96 TPI
MSM-551003 \$324.95 ea 2 for \$298.95 ea

Tandon TM100-4 double-sided double-density 96 TPI
MSM-551004 \$448.95 ea 2 for \$419.95 ea

MPI B-51 single-sided double-density 40 track
MSM-155100 \$234.95 ea 2 for \$224.95 ea

MPI B-52 double-sided double-density 40 track
MSM-155200 \$344.95 ea 2 for \$334.95 ea

MPI B-91 single-sided double-density 77 track
MSM-155300 \$369.95 ea 2 for \$359.95 ea

MPI B-92 double-sided double-density 77 track
MSM-155400 \$469.95 ea 2 for \$459.95 ea

5 1/4" Cabinets with Power Supply

END-000216 Single cab w/power supply \$69.95
END-000226 Dual cab w/power supply \$94.95

8" Disk Drives

Shugart SA810 half-size single-sided double-density
MSF-108100 \$424.95 ea 2 for \$394.95 ea

Shugart SA860 half-size double-sided double-density
MSF-108600 \$574.95 ea 2 for \$549.95 ea

Shugart SA801R single-sided double-density
MSF-10801R \$394.95 ea 2 for \$389.95 ea

Shugart SA851R double-sided double-density
MSF-10851R \$554.95 ea 2 for \$529.95 ea

Tandon TM848-1 single-sided double-den thin-line
MSF-558481 \$424.95 ea 2 for \$394.95 ea

Tandon TM848-2 double-sided double-den thin-line
MSF-558482 \$574.95 ea 2 for \$549.95 ea

Qume DT-8 double-sided double-density
MSF-750080 \$524.95 ea 2 for \$498.95 ea

Mitsubishi M2894-63 double-sided double-density
MSF-289463 \$549.95 ea 2 for \$524.95 ea

Siemens FDD 100-8 single-sided double-density
MSF-201120 \$384.95 ea 2 for \$349.95 ea

Prices may be slightly higher at our retail locations. Please contact the store in your area for exact pricing.

Hard Disk Drives

12 MEGABYTE SUB-SYSTEM - DayStar

12 Megabyte Winchester sub-system for most CP/M based microcomputers including Apple II, S-100, IBM PC, NEC, Xerox, TRS-80 II, Heath H-89, and others. Sub-system includes interface, controller, cabinet, power supply, CP/M software patch, & cables - ready to just plug in and run. A 1 Megabyte back-up drive is also available.

MSH-531010 S-100 sub-system \$2095.00
MSH-531020 Apple II sub-system \$2095.00
MSH-531030 NEC sub-system \$2095.00
MSH-531040 Xerox sub-system \$2095.00
MSH-531050 TRS-80 II sub-system \$2095.00
MSH-531060 IBM PC sub-system \$2095.00
MSH-531099 1 Megabyte back-up \$699.95

12 MEGABYTE WINCHESTER - Tandon

5 1/4" hard disk drive for hi-speed mass storage.

MSH-550603 Bare 5 1/4" drive \$1094.95

Letter Quality Printers

TP-1 LETTER QUALITY - SCM

10 CPS daisy wheel printer from Smith Corona.

PRD-45101 Centronics parallel \$699.95
PRD-45102 RS-232C serial \$749.95

LETTER QUALITY PRINTER - Jade

Uses standard daisy wheels and ribbon cartridges, 16 CPS bi-directional printing, semi-automatic paper loader (single sheet or fan fold), 10/12/15 pitch, up to 16" paper, built-in noise suppression cover.

PRD-11001 Centronics parallel \$899.95
PRD-11002 RS-232C serial model \$999.95

STARWRITER F-10 - C. Itoh

New 40 CPS daisy wheel printer with full 15" carriage, uses standard Diablo print wheels and ribbons, both parallel and serial interfaces included.

PRD-22010 Starwriter F-10 \$1495.95

80 CPS LETTER QUALITY - Fujitsu

High speed daisy wheel printer with both RS-232C serial & Centronics parallel interfaces, emulates NEC 5510, Diablo 630, Qume, and will interface to the IBM Personal Computer, features include Z-80 CPU, 16K buffer (48K optional), bi-directional printing, & baud rates up to 19.2K

PRD-86100 Fujitsu with 16K \$2895.00
PRD-86200 Fujitsu with 48K \$3195.00
PRA-86000 Adjustable tractor \$190.00

Software

PLANNER CALC - Target Software

Spread sheet (what if ?) program designed with the user in mind, user oriented (simple english) commands allow you to quickly master this powerful software package, supplied on disk for most CP/M based systems.

SFA-12251052M Apple II 5 1/4" CP/M \$49.95
SFC-12251050F SS SD 8" CP/M \$49.95
SFC-12251053F Xerox 8" CP/M \$49.95
SFC-12251053M Xerox 5 1/4" CP/M \$49.95
SFX-12251051M NEC 5 1/4" CP/M \$49.95

PAC MAN - Atari

Atari's best selling game for your 800 or 400 computer.

SFI-31254022E Pac Man cartridge \$37.95

Place Orders Toll Free

Continental U.S. Inside California

800-421-5500 800-262-1710

For Technical Inquiries or Customer Service call:

213-973-7707

JADE

Computer Products

4901 W. Rosecrans, Hawthorne, Ca 90250

TERMS OF SALE: Cash, checks, credit cards, or Purchase Orders from qualified firms and institutions. Minimum Order \$15.00. California residents add 6% tax. Minimum shipping & handling charge \$3.00. Pricing & availability subject to change

Circle 216 on inquiry card.

Disk Drive for Apple \$319.95

Diskettes

PREMIUM DISKETTES - Jade

We proudly put our name on these high quality diskettes -

5 1/4" Diskettes, Box of Ten		
MMD-5110103	SS, SD, 01S	\$29.00
MMD-5111003	SS, SD, 10S	\$29.00
MMD-5111603	SS, SD, 16S	\$29.00
MMD-5120103	SS, DD, 01S	\$31.00
MMD-5121003	SS, DD, 010	\$31.00
MMD-5121603	SS, DD, 16S	\$31.00

8" Diskettes, Box of Ten

MMD-8110103	SS, SD, 01S	\$31.00
MMD-8120103	SS, DD, 01S	\$39.00
MMD-8220103	DS, DD, 01S	\$48.00

BARGAIN DISKETTES

MMD-5110105	5 1/4" SS, DD, 01S	\$19.95
MMD-5220105	5 1/4" DS, DD, 01S	\$32.95
MMD-8110105	8" SS, SD, 01S	\$24.95
MMD-8120105	8" SS, DD, 01S	\$32.95
MMD-8220105	8" SS, DD, 01S	\$35.95

Video Monitors

HI-RES 12" GREEN - Zenith

15 MHz bandwidth with 700 lines/inch, P31 green phosphor, switchable 40 or 80 columns, small, light-weight & portable.
VDM-201201 List price \$189.95 \$129.95

12" GREEN SCREEN - NEC

20 MHz bandwidth, P31 phosphor ultra-high resolution video monitor with audio.
VDM-561200 List price \$289.95 \$199.95

12" COLOR MONITOR - NEC

High resolution color monitor with audio.
VDC-651212 Color monitor \$389.95
NEC-1202D RGB color monitor \$999.95

13" COLOR MONITORS - BMC

18 MHz RGB & composite video color monitors.
VDC-421320 13" RGB Color \$329.95
VDC-421310 13" Composite video \$299.95
VDX-420090 RGB card for Apple \$149.95

COLOR MONITORS - Amdek

Reasonably priced color video monitors.
VDC-80130 13" Color I \$379.95
VDC-801320 13" Color II \$894.95
IOV-2300A DVM board for Apple \$199.95

AMBER or GREEN MONITORS - Jade

High resolution 18 MHz compact video monitors.
VDM-751210 12" Amber phosphor \$149.95
VDM-751220 12" Green phosphor \$139.95
VDM-750910 9" Amber phosphor \$149.95
VDM-750920 9" Green phosphor \$139.95

Modems

SIGNALMAN - Anchor

Direct-connect automatic answer/originate selection, 300 Baud full duplex, Bell 103, includes RS-232 cable
IOM-5600A Signalman \$98.50

SMARTMODEM - Hayes

Sophisticated direct-connect auto-answer/auto-dial modem, touch-tone or pulse dialing, RS-232C interface, programmable
IOM-5400A Smartmodem \$248.95
IOM-1500A Hayes Chronograph \$218.95
IOM-2010A Micromodem II \$328.95
IOM-1100A Micromodem 100 \$368.95

EPROM Erasers

ULTRA-VIOLET EPROM ERASERS

Inexpensive erasers for industry or home.
XME-3100A Spectronics w/o timer \$69.50
XME-3101A Spectronics with timer \$94.50
XME-3200A Economy model \$39.95

Single User System

THREE BOARD SET - SD Systems

4 MHz Z-80A CPU, 64K RAM (optional 256K), serial I/O port, parallel I/O port, double density disk controller, CP/M 2.2 & manual set, system monitor, control & diagnostic software. Includes SBC-200, 64K ExpandoRAM II, Versafloppy II, & CP/M 2.2 - all boards are assembled & tested.

Board set with 64K of RAM \$1095.00
Board set with 256K of RAM \$1295.00

Apple II Accessories

16K RAM CARD - for Apple II

Expand your Apple to 64K, 1 year warranty
MEX-16700A Save \$125.00 !!! \$69.95

ADD-ON DISK DRIVE - for Apple II

Inexpensive direct replacement for Apple Disk II, works with Apple II controller as first or second drive.

MSM-123200 Add On Drive \$319.95
MSM-123100 Controller \$94.95

Z-80 CPU CARD - for Apple II

Two computers in one, Z-80 & 6502, more than doubles the power and potential of your Apple, includes Z-80 CPU card CP/M and complete manual set.

CPX-62800A A & T with software .. \$249.95

8" DISK CONTROLLER - Vista

New from Vista Computer, single or double sided, single or double density, compatible with DOS 3.2/3.3, Pascal, & CP/M 2.2, Shugart & Qume compatible
IOD-2700A A & T \$499.95

2 MEGABYTES for Apple II

Complete package includes: Two 8" double-density disk drives, Vista double-density 8" disk controller, cabinet, power supply, & cables, DOS 3.2/3.3, CP/M 2.2, & Pascal compatible.

1 MegaByte Package Kit \$1495.00
1 MegaByte Package A & T \$1695.00
2 MegaByte Package Kit \$1795.00
2 MegaByte Package A & T \$1995.95

APPLE-CAT - Novation

Software selectable 1200 or 300 baud, direct connect, auto-answer/auto-dial, auxiliary 3-wire RS232C serial port for printer.

IOM-5232A Save \$50.00!!! \$325.95

VISION 80 - Vista Computer

80 column x 24 line video card for Apple II, 128 ASCII characters, upper and lower case, 9 x 10 dot matrix with 3 dot descenders, standard data media terminal control codes, CP/M Pascal & Fortran compatible, 50/60 Hz

IOV-2400A Vista Vision 80 \$299.95

CPS MULTICARD - Mtn. Computer

Three cards in one! Real time clock/calendar, serial interface, & parallel interface - all on one card.

IOX-2300A A & T \$179.95

HI-RES GRAPHICS CARD - Genie

Intelligent printer interface and control card allows full high resolution graphics and screen dumps.

IOP-2405A Genie for Epson \$119.95
IOP-2410A Genie for Okidata \$119.95
IOP-2415A Genie for NEC/C. Itoh \$119.95

Power Strips

ISOBAR - GSC

Isolates & protects your valuable equipment from high voltage spikes & AC line noise, inductive isolated ground, 15 amp circuit breaker, U.L. listed

EME-115103 3 socket \$39.50
EME-115105 4 socket \$49.50
EME-115100 8 socket \$54.50
EME-115110 9 socket rackmount \$74.50

Single Board Computer

SUPERQUAD - Adv. Micro Digital

Single board, standard size S-100 computer system, 4 MHz Z-80A, single or double density disk controller for 5 1/4" or 8" drives, 64K RAM, extended addressing, up to 4K of EPROM, 2 serial & 2 parallel I/O ports, real time interrupt clock, CP/M compatible.

CPC-30800A A & T \$724.95
IOX-4232A Serial I/O adapter \$29.95

Z-80 STARTER KIT - SD Systems

Complete Z-80 microcomputer with RAM, ROM, I/O, keyboard, display, kludge area, manual, & workbook.

CPS-30100K Kit with workbook \$299.95
CPS-30100A A & T with workbook \$469.95

AIM-65 - Rockwell International

Complete 6502 microcomputer with alphanumeric display, printer, keyboard, & instruction manual.

CPK-50165A 1K AIM-65 \$424.95
CPK-50465A 4K AIM-65 \$474.95
SFK-74600008E 8K Basic ROM \$64.95
SFK-64600004E 4K assembler ROM \$43.95
SFK-746000020E PL/65 ROM \$84.95
SFK-74600010E Forth ROM \$64.95
SFK-74600030E Instant Pascal \$99.95
PSX-030A Power supply \$64.95
ENX-000002 Enclosure \$54.95

SPECIAL PACKAGE

4K AIM-65, 8K Basic, power supply, & enclosure
Special Package Price \$649.95

S-100 EPROM Boards

PROM-100 - SD Systems

2708, 2716, 2732 EPROM programmer with software.
MEM-99520K Kit with software \$189.95
MEM-99520A A & T with software \$249.95

PB-1 - SSM Microcomputer

2708, 2716 EPROM board with on-board programmer.
MEM-99510K Kit with manual \$154.95
MEM-99510A A & T with manual \$219.95

EPROM BOARD - Jade

16K or 32K uses 2708 or 2716 EPROMs, 1K boundary.
MEM-16230K Kit w/o EPROMs \$79.95
MEM-16230A A & T w/o EPROMs \$119.95

S-100 Video Boards

SPECTRUM COLOR - CompuPro

Full-function color graphics board, up to 8 colors, 256 x 192 graphics, parallel I/O port, 8K RAM.

IOV-1870A A & T \$348.95
IOV-1870C CSC \$398.95

MICROANGELO - Scion

Ultra-high-resolution 512 x 480, 256 color or black & white S-100 video board
IOV-1500A A & T \$999.95

S-100 MotherBoards

ISO-BUS - Jade

Silent, simple, and on sale - a better motherboard
6 Slot (5 1/4" x 8 1/2")

MBS-061B Bare board \$19.95
MBS-061K Kit \$39.95
MBS-061A A & T \$59.95

12 Slot (9 1/4" x 8 1/2")

MBS-121B Bare board \$29.95
MBS-121K Kit \$49.95
MBS-121A A & T \$69.95

18 Slot (14 1/2" x 8 1/2")

MBS-181B Bare board \$49.95
MBS-181K Kit \$99.95
MBS-181A A & T \$139.95

ACTIVE TERMINATOR - CompuPro

A true mother's helper.
TSX-100A A & T \$59.45

CompuPro Boards on Sale

S-100 CPU Boards

8086/8087 - CompuPro

16 bit, 8 or 10 MHz 8086 CPU with provisions for 8087 & 80130.

CPU-70520A 8 MHz 8086 A & T	\$624.95
CPU-70520C 8 MHz 8086 CSC	\$764.95
CPU-70530A with 8087 A & T	\$1224.95
CPU-70530C with 8087 CSC	\$1455.95

8085/8086 - CompuPro

Both 8 & 16 bit CPUs, standard 8 bit S-100 bus, up to 8 MHz, accesses 16 Megabytes of memory.

CPU-20510A 6 MHz A & T	\$398.95
CPU-20510C 6/8 MHz CSC	\$497.95

CPU-Z - CompuPro

2/4 MHz Z80A CPU, 24 bit addressing.

CPU-30500A 2/4 MHz A & T	\$279.95
CPU-30500C 3/6 MHz CSC	\$374.95

SBC-200 - SD Systems

4 MHz Z-80A CPU with serial & parallel I/O, 1K RAM, 8K ROM space, monitor PROM included.

CPC-30200A A & T	\$399.95
------------------------	----------

THE BIG Z - Jade

2 or 4 MHz switchable Z-80 CPU board with serial I/O, accommodates 2708, 2716, or 2732 EPROM, baud rates from 75 to 9600.

CPU-30201B Bare board w/manual	\$35.00
CPU-30201K Kit with manual	\$149.95
CPU-30210A A & T with manual	\$199.95

CB-2 - SSM Microcomputer

2 or 4 MHz Z-80 CPU board with provision for up to 8K of ROM or 4K of RAM on board, extended addressing, IEEE S-100, front panel compatible.

CPU-30300K Kit with manual	\$229.95
CPU-30300A A & T with manual	\$274.95

2810 Z-80 CPU - C.C.S.

2 or 4 MHz Z-80 CPU with serial I/O port & on-board monitor PROM, front panel compatible.

CPU-30400A A & T with PROM	\$289.95
----------------------------------	----------

2820 Z-80 DMA CPU - C.C.S.

4 MHz Z-80 CPU board with 2 serial I/O ports & Centronics parallel I/O port, separate data & status ports, DMA daisy chain compatible.

CPU-30420A A & T with manual	\$569.95
------------------------------------	----------

S-100 Disk Controllers

DISK 1 - CompuPro

8" or 5 1/4" DMA disk controller, single or double density, single or double sided, 10 MHz.

IOD-1810A A & T	\$449.95
IOD-1810C CSC	\$554.95
SFC-52506580F 8" CP/M 2.2 for Z-80	\$174.95
SFC-52506586F 8" CP/M 2.2 for 8086	\$299.95
SFO-54159000F Oasis single user	\$499.95
SFO-54159002F Oasis multi-user	\$849.95

VERSAFLOPPY II - SD Systems

Double density disk controller for any combination of 5 1/4" and 8" single or double sided, analog phase-locked loop data separator, vectored interrupts, CP/M 2.2 & Oasis compatible, control/diagnostic software PROM included.

IOD-1160A A & T with PROM	\$359.95
SFC-55009047F CP/M 2.2 with VF II	\$99.95

2242 DISK CONTROLLER - C.C.S.

5 1/4" or 8" double density disk controller with on-board boot loader ROM, free CP/M 2.2 & manual set.

IOD-1300A A & T with CP/M 2.2	\$399.95
-------------------------------------	----------

DOUBLE D - Jade

High reliability double density disk controller with on-board Z-80A, auxiliary printer port, IEEE S-100, can function in multi-user interrupt driven bus.

IOD-1200B Bare board & hdwr man	\$59.95
IOD-1200K Kit w/hdwr & stwr man	\$299.95
IOD-1200A A & T w/hdwr & stwr man	\$359.95
SFC-59002001F CP/M 2.2 with Double D	\$99.95

S-100 Memory Boards

256K RAMDISK - SD Systems

ExpandoRAM III expandable from 64K to 256K using 64K x 1 RAM chips, compatible with CP/M, MP/M, Oasis, Cromemco, & most other Z-80 based systems, functions as ultra-high speed disk drive when used with optional RAMDISK software.

MEM-65064A 64K A & T	\$474.95
MEM-65128A 128K A & T	\$574.95
MEM-65192A 192K A & T	\$674.95
MEM-65256A 256K A & T	\$774.95
SFC-55009000F RAMDISK stwr CP/M 2.2	\$44.95
SFC-55009000F RAMDISK with EXRAM III	\$24.95

128K RAM 21 - CompuPro

128K x 8 bit or 64K x 16 bit static RAM board, 12 MHz, 24 bit addressing.

MEM-12810A A & T	\$1609.95
MEM-12810C CSC	\$1794.95

64K RAM 17 - CompuPro

64K CMOS static RAM board, 10 MHz, low power less than 4 watts, DMA compatible, 24 bit addressing.

MEM-64180A 64K A & T	\$549.95
MEM-64180C 64K CSC	\$698.95

64K RAM 16 - CompuPro

32K x 16 bit or 64K x 8 bit low power static RAM board, 10 MHz, 24 bit addressing.

MEM-32180A RAM 16 A & T	\$598.95
MEM-32180C RAM 16 CSC	\$698.95

64K STATIC RAM - SSM

IEEE 6961S-100 standard, up to 6MHz/8 Bit, 12MHz/16 Bit, 24 Bit extended addressing, disable-able in 2K increments

MEM-64300A A & T	\$499.95
------------------------	----------

64K STATIC RAM - Mem Merchant

64K static S-100 RAM card, 4 to 16K banks up to 8 MHz.

MEM-64400A 64K A & T	\$499.95
----------------------------	----------

2065 64K RAM - C.C.S.

4 MHz bank port/bank byte selectable, extended addressing, 16K bank selectable, front panel compatible.

MEM-64565A 64K A & T	\$349.95
----------------------------	----------

2066 64K RAM - C.C.S.

64K RAM board with bank and block select switching functions for Cromemco Cromix & Alpha Micro.

MEM-64566A 64K A & T	\$424.95
----------------------------	----------

64K EXPANDORAM II - SD Systems

Expandable RAM board from 16K to 64K using 4116 RAM chips.

MEM-16630A 16K A & T	\$344.95
MEM-32631A 32K A & T	\$364.95
MEM-48632A 48K A & T	\$384.95
MEM-64633A 64K A & T	\$399.95

MEMORY BANK - Jade

4 MHz S-100 bank selectable expandable to 64K.

MEM-99730B Bare board w/manual	\$49.95
MEM-99730K Kit with no RAM	\$179.95
MEM-32731K 32K kit	\$199.95
MEM-64733K 64K kit	\$249.95
Assembled & Tested	add \$50.00

32K RAM 20 - CompuPro

32K static RAM, up to 10 MHz, disable-able in 4K banks, bank select or 24 bit addressing.

MEM-16180A 16K A & T	\$259.95
MEM-16180C 16K CSC	\$324.95
MEM-24180A 24K A & T	\$324.95
MEM-24180C 24K CSC	\$384.95
MEM-32185A 32K A & T	\$384.95
MEM-32185C 32K CSC	\$449.95

16K STATIC RAM - Mem Merchant

4MHz io-power static RAM board, IEEE S-100, bank selectable, addressable in 4K blocks, disable-able in 1K segments extended addressing.

MEM-16171A 16K A & T	\$149.95
----------------------------	----------

S-100 I/O Boards

SYSTEM SUPPORT 1 - CompuPro

Real time clock, three 16 bit interval timers, dual interrupt controllers (15 levels), up to 4K EPROM/RAM, RS-232C serial channel, provision for 9511A/9512 math chip.

IOX-1850A SS1 A & T	\$359.95
IOX-1850C SS1 CSC	\$459.95
IOX-1855A with 9511 A & T	\$554.95
IOX-1855C with 9511 CSC	\$654.95
IOX-1860A with 9512 A & T	\$554.95
IOX-1860C with 9512 CSC	\$654.95

INTERFACER 1 - CompuPro

2 serial I/O ports 50-19.2K baud.

IOI-1810A A & T	\$218.95
IOI-1810C CSC	\$288.95

INTERFACER 2 - CompuPro

3 parallel, 1 serial, & interrupt timer.

IOI-1820A A & T	\$218.95
IOI-1820C CSC	\$288.95

INTERFACER 3 - CompuPro

5 or 8 channel serial I/O board for interrupt driven multi-user systems up to 250K baud.

IOI-1835A 5 port A & T	\$558.95
IOI-1835C 5 port CSC	\$628.95
IOI-1838A 8 port A & T	\$628.95
IOI-1838C 8 port CSC	\$749.95

INTERFACER 4 - CompuPro

3 serial, 1 parallel, 1 Centronics parallel.

IOI-1840A A & T	\$314.95
IOI-1840C CSC	\$414.95

MPX - CompuPro

Multi-user I/O multiplexer & interrupt controller with on-board 8085A-2 CPU & 4K or 16K of RAM.

IOI-1875A 4K MPX A & T	\$444.95
IOI-1875C 4K MPX CSC	\$534.95
IOI-1880A 16K MPX A & T	\$584.95
IOI-1880C 16K MPX CSC	\$674.95

I/O-8 - SSM Microcomputer

Eight software programmable serial I/O ports, 110 -19.2K Baud, ideal for multi-user systems

IOI-1018A A & T	\$469.95
-----------------------	----------

I/O-5 - SSM Microcomputer

Two serial & 3 parallel I/O ports, 110-19.2K Baud

IOI-1015A A & T	\$289.95
-----------------------	----------

MPC-4 - SD Systems

Intelligent 4-port serial I/O card, on-board Z-80A, 2K RAM, 4K PROM area, on-board firmware, fully buffered, vectored interrupts, four CTC channels, add to SD Board set for powerful multi-user system

IOI-1504A A & T w/software	\$485.00
----------------------------------	----------

I/O-4 - SSM Microcomputer

2 serial I/O ports plus 2 parallel I/O ports.

IOI-1010B Bare board w/manual	\$35.00
IOI-1010K Kit with manual	\$179.95
IOI-1010A A & T with manual	\$249.95

2830 6 PORT SERIAL - C.C.S.

Six asynchronous RS-232C serial I/O ports with programmable baud rates.

IOI-1040A A & T with manual	\$529.95
-----------------------------------	----------

2710 4 PORT SERIAL - C.C.S.

Four RS-232C serial I/O ports with full handshaking.

IOI-1060A A & T with manual	\$319.95
-----------------------------------	----------

2719 2 SER & 2 PAR - C.C.S.

Two RS-232C serial I/O ports plus two 8 bit parallel I/O ports.

IOI-1080A A & T with manual	\$349.95
-----------------------------------	----------

Mini Stereo AM/FM Receiver

WITH HEADPHONES — For Joggers, Cyclists, Skaters & Sports Enthusiasts



FEATURES: Lightweight headphones. Left/right balance control. Full fidelity stereo sound. Additional black soft carrying case & shoulder strap. Belt clip (hands free). Operates on 3 AA cell batteries (not incl.). Compact size: 3 1/2" x 4 1/4" x 1". Wt. 6 oz.

Model 2830 List Price \$69.95 **\$34.95**

SPEAKERS



2 1/2" Round — 8 Ohm
25 Watt (4 mount. holes)
Size: 2 1/4" x 3 1/4"

2 1/2" Square — 16 Ohm
25 Watt (4 mount. holes)
Large Ceramic Magnet
Size: 2 1/4" x 2 1/4" x 3/4"

Part No. Price
A0201 \$1.25 or 2/1.98

Part No. Price
SF-2501B \$1.39 or 2/2.98

MOTOROLA AM/FM Stereo Push Button CAR RADIO

FOR VOLKSWAGEN SCIROCCO, RABBIT, AUDI 5000 AND FOX
(with minor adjustments, can be used in any automobile)



Includes bezel trim and everything pictured. Two each 4x6 speakers and grille (1/4" deep). All cables and leads for hook-up. Includes all instruction Manuals for easy installation. Cut-out dimensions: 7" W x 1 1/4" H x 6 1/2" L.

Model 5VW3901 **\$49.95**

UV-EPROM Eraser



Erases 2708, 2716, 2732, 2764, 2515, 2532, 2564. Erases up to 8 chips within 51 minutes (1 chip in 37 minutes). Maintains consistent exposure distance of one inch. Special conductive foam liner eliminates static build-up. Built-in safety lock to prevent UV exposure. Compact — only 8.00" x 3.70" x 2.80". Complete with holding tray for 8 chips.

UVS-11EL Replacement Bulb **\$16.95**

DE-4 UV-EPROM Eraser **\$79.95**

JOYSTICKS



JS-4K **\$5.25**

JS-100K **\$4.95**

JS-150K **\$4.75**

JVC-40 **\$4.95**

5K Linear Taper Pots **\$5.25**

100K Linear Taper Pots **\$4.95**

150K Linear Taper Pots **\$4.75**

40K 2 Video Controller in case **\$4.95**

JE215 Adjustable Dual Power Supply

General Description: The JE215 is a Dual Power Supply with independent adjustable positive and negative output voltages. A separate adjustment for each of the supplies provides the user unlimited applications for IC current voltage requirements. The supply can also be used as a general all-purpose variable power supply.

FEATURES:

- Adjustable regulated power supplies, pos. and neg. 12VDC to 150VDC.
- Power Output (each supply): 5VDC @ 500mA, 10VDC @ 750mA, 12VDC @ 500mA, and 15VDC @ 175mA.
- Two, 3-terminal adj. IC regulators with thermal overload protection.
- Heat sink regulator cooling.
- LED "on" indicator.
- Printed Board Construction.
- 120VAC input.
- Size: 3-1/2" W x 5-1/16" L x 2" H

JE215 Adj. Dual Power Supply Kit (as shown) **\$24.95**

(Picture not shown but similar in construction to above) JE200 Reg. Power Supply Kit (5VDC, 1 amp.) **\$14.95**

JE205 Adapter Brd. (to JE200) \$5.49 & 12V. **\$12.95**

JE210 Var. Sply. Kit, 5-15VDC, to 1.5amp. **\$19.95**

JE215 Adj. Dual Power Supply Kit (as shown) **\$24.95** (Picture not shown but similar in construction to above) JE200 Reg. Power Supply Kit (5VDC, 1 amp.) **\$14.95** JE205 Adapter Brd. (to JE200) \$5.49 & 12V. **\$12.95** JE210 Var. Sply. Kit, 5-15VDC, to 1.5amp. **\$19.95**

KEYBOARDS — POWER SUPPLIES

JE610 ASCII Encoded Keyboard Kit

The JE610 ASCII Keyboard Kit can be interfaced into most any computer system. The kit comes complete with industrial grade keyboard switch assembly (62-keys), IC's, sockets, connector, electronic components and a double-sided printed wiring board. The keyboard assembly requires +5V @ 150mA and -12V @ 10mA for operation. Features: 60 keys generate the 128 characters, upper and lower case ASCII set. Fully buffered. Two user-definable keys provided for custom applications. Case lock for upper-case only alpha characters. Utilizes a 2376 (40-pin) encoder read-only memory chip. Outputs directly compatible with TTL/DTL or MOS logic arrays. Easy interfacing with a 16-pin (dip) 18-pin edge connector. Size: 3 1/2" H x 14 1/2" W x 8 1/2" D.

JE610/DTE-AK (After assembly as pictured above) **\$124.95**

JE610 Kit 62-Key Keyboard, PC Board & Components (no case) **\$ 79.95**

K62 62-Key Keyboard (Keyboard only) **\$ 34.95**

DTE-AK (case only) — 3 1/2" H x 14 1/2" W x 8 1/2" D **\$ 49.95**

JE212 — Negative 12VDC Adapter Board Kit for JE610 ASCII KEYBOARD KIT
Provides — 12VDC from incoming 5VDC **\$8.95**

JE600 Hexadecimal Encoder Kit

FULL 8-BIT LATCHED OUTPUT
19-KEY KEYBOARD

The JE600 Encoder Keyboard Kit provides two separate hexadecimal digits produced from sequential key entries to allow direct programming for 8-bit microprocessor or 8-bit memory circuits. Three additional keys are provided for easier operations with one having a bistable output available. The outputs are latched and monitored with 8 LED readouts. Also included is a key entry strobe. Features: Full 8-bit latched output for microprocessors. Debounce circuit provided for all 19 keys. Nine LED readouts to verify entries. Easy interfacing with standard 16-pin IC connector. Only +5VDC required for operation. Size: 3 1/2" H x 8 1/2" W x 8 1/2" D.

JE600/DTE-HK (After assembly as pictured above) **\$99.95**

JE600 Kit 19-Key Hexadecimal Keyboard, PC Board & Components (no case) **\$59.95**

K19 19-Key Keyboard (Keyboard only) **\$14.95**

DTE-HK (case only) — 3 1/2" H x 8 1/2" W x 8 1/2" D **\$44.95**

ALPS 26-KEY CALIBRATED KEYBOARD

Gray Key Caps with blue, green and white back drop. Mechanical SPST Switching: 22-pin Edge Card Connect. Ion.

Part No. **KB26** **\$2.95 each or 2/\$4.95**

MICRO SWITCH 69-KEY KEYBOARD

Data Entry Keyboard, Encoded Output: 8-bit Parallel EBC DIC. Switching: Hall Effect. 24-pin Edge Card Connection. Complete with Pin Connector.

Part No. **KB69SD12-2** **\$19.95 each**

DATANETICS 74-KEY KEYBOARD

ASCII Encoded Keyboard, Output: Even Parity ASCII. Supply voltage: +5, -12 volt. Switching: Mechanical SPST — 50-pin Connection. Complete with Pin Connector.

Part No. **KB74** **\$29.95 each**

MICRO SWITCH 85-KEY KEYBOARD

Data Entry Keyboard. Switching: Hall Effect. 13-pin Edge Card Connection. Metal frame, dark brown keycaps.

Part No. **KB85D1B-1** **\$29.95 each**

MICRO SWITCH 88-KEY KEYBOARD

Data Entry Keyboard with a Dialable 160 Terminal. Supply Voltage: +5V, -12V. Switching: Hall Effect — 10-pin Edge Card Connection. Schematic Included.

Part No. **KB88SD2** **\$69.95 each**

POWER SUPPLIES

POWER SUPPLY — 5VDC @ 1 AMP REGULATED

Transaction Tech Output: +5VDC @ 1 amp (also +30VDC) req. input 115VAC 60Hz. Two-tone (black/balge) self-enclosed case, 6 in. 3 cond. black power cord. Size: 6 1/2" W x 7 1/2" D x 2 1/4" H. Wt. 3 lbs.

Part No. **PS51194** **\$19.95 each**

POWER SUPPLY — 5VDC @ 1 AMP REGULATED

D International Output: +5VDC @ 1 amp, +28-28VDC reg. 400mA or less, 30VAC (max.) @ 1.5 amp. Input 115VAC 60Hz. Circ. break, reset button. 6 in. self-enc. case w/4 rubber feet. 3 cond. 6 ft. power cord. Size: 6 1/2" W x 7 1/2" D x 2 1/4" H. Wt. 3 lbs.

Part No. **PS407D** **\$24.95 each**

POWER SUPPLY — 5VDC @ 7.5 AMP, 12VDC @ 1.5 AMP SWITCHING

Input: 115VAC, 60-60Hz @ 3 amp/230VAC, 50Hz @ 1.6 amp. Fan vbl. / power supply cabinet suitable (115/230VAC). Output: 5VDC @ 7.5 amp, 12VDC @ 1.5 amp. For vbl. power cord. 1 1/2" W x 1 1/2" D x 1 1/2" H.

Part No. **PS84V0** **\$49.95 each**

POWER PAC — Heavy Duty Multi-Voltage Power Supply — 5VDC, 12VDC, 6VDC

Output: +5VDC @ 3A, +12VDC @ 2A, -12VDC @ 4A & +24VDC @ 2A. Input: 115VAC, 7A, 230VAC, 3 A. Reg. & .1% max. 4 cond. power. Regulator: 100% pass to pass (30V/800). Overvoltage: 115V @ 1.25V. Overvoltage protection: 115V @ 1.25V. Size: 11 1/2" W x 11 1/2" D x 4 1/2" H. Wt. 40 lbs.

Part No. **PS5-016** **\$89.95 each**

★ SHIPMENT IN 24 HOURS ★
6:00 AM to 6:00 PM (PST)
Call: (415) 592-8097

JUMPER AND CABLE ASSEMBLIES

STANDARD DIP JUMPERS

Part No.	Length	Price
JD1A-1	16 single end	1.37
JD1A-2	16 single end	2.08
JD1A-3	16 single end	2.79
JD1A-4	16 single end	3.50
JD1A-5	16 single end	4.21
JD1A-6	16 single end	4.92
JD1A-7	16 single end	5.63
JD1A-8	16 single end	6.34
JD1A-9	16 single end	7.05
JD1A-10	16 single end	7.76
JD1A-11	16 single end	8.47
JD1A-12	16 single end	9.18
JD1A-13	16 single end	9.89
JD1A-14	16 single end	10.60
JD1A-15	16 single end	11.31
JD1A-16	16 single end	12.02
JD1A-17	16 single end	12.73
JD1A-18	16 single end	13.44
JD1A-19	16 single end	14.15
JD1A-20	16 single end	14.86
JD1A-21	16 single end	15.57
JD1A-22	16 single end	16.28
JD1A-23	16 single end	16.99
JD1A-24	16 single end	17.70
JD1A-25	16 single end	18.41
JD1A-26	16 single end	19.12
JD1A-27	16 single end	19.83
JD1A-28	16 single end	20.54
JD1A-29	16 single end	21.25
JD1A-30	16 single end	21.96
JD1A-31	16 single end	22.67
JD1A-32	16 single end	23.38
JD1A-33	16 single end	24.09
JD1A-34	16 single end	24.80
JD1A-35	16 single end	25.51
JD1A-36	16 single end	26.22
JD1A-37	16 single end	26.93
JD1A-38	16 single end	27.64
JD1A-39	16 single end	28.35
JD1A-40	16 single end	29.06
JD1A-41	16 single end	29.77
JD1A-42	16 single end	30.48
JD1A-43	16 single end	31.19
JD1A-44	16 single end	31.90
JD1A-45	16 single end	32.61
JD1A-46	16 single end	33.32
JD1A-47	16 single end	34.03
JD1A-48	16 single end	34.74
JD1A-49	16 single end	35.45
JD1A-50	16 single end	36.16
JD1A-51	16 single end	36.87
JD1A-52	16 single end	37.58
JD1A-53	16 single end	38.29
JD1A-54	16 single end	39.00
JD1A-55	16 single end	39.71
JD1A-56	16 single end	40.42
JD1A-57	16 single end	41.13
JD1A-58	16 single end	41.84
JD1A-59	16 single end	42.55
JD1A-60	16 single end	43.26
JD1A-61	16 single end	43.97
JD1A-62	16 single end	44.68
JD1A-63	16 single end	45.39
JD1A-64	16 single end	46.10
JD1A-65	16 single end	46.81
JD1A-66	16 single end	47.52
JD1A-67	16 single end	48.23
JD1A-68	16 single end	48.94
JD1A-69	16 single end	49.65
JD1A-70	16 single end	50.36
JD1A-71	16 single end	51.07
JD1A-72	16 single end	51.78
JD1A-73	16 single end	52.49
JD1A-74	16 single end	53.20
JD1A-75	16 single end	53.91
JD1A-76	16 single end	54.62
JD1A-77	16 single end	55.33
JD1A-78	16 single end	56.04
JD1A-79	16 single end	56.75
JD1A-80	16 single end	57.46
JD1A-81	16 single end	58.17
JD1A-82	16 single end	58.88
JD1A-83	16 single end	59.59
JD1A-84	16 single end	60.30
JD1A-85	16 single end	61.01
JD1A-86	16 single end	61.72
JD1A-87	16 single end	62.43
JD1A-88	16 single end	63.14
JD1A-89	16 single end	63.85
JD1A-90	16 single end	64.56
JD1A-91	16 single end	65.27
JD1A-92	16 single end	65.98
JD1A-93	16 single end	66.69
JD1A-94	16 single end	67.40
JD1A-95	16 single end	68.11
JD1A-96	16 single end	68.82
JD1A-97	16 single end	69.53
JD1A-98	16 single end	70.24
JD1A-99	16 single end	70.95
JD1A-100	16 single end	71.66
JD1A-101	16 single end	72.37
JD1A-102	16 single end	73.08
JD1A-103	16 single end	73.79
JD1A-104	16 single end	74.50
JD1A-105	16 single end	75.21
JD1A-106	16 single end	75.92
JD1A-107	16 single end	76.63
JD1A-108	16 single end	77.34
JD1A-109	16 single end	78.05
JD1A-110	16 single end	78.76
JD1A-111	16 single end	79.47
JD1A-112	16 single end	80.18
JD1A-113	16 single end	80.89
JD1A-114	16 single end	81.60
JD1A-115	16 single end	82.31
JD1A-116	16 single end	83.02
JD1A-117	16 single end	83.73
JD1A-118	16 single end	84.44
JD1A-119	16 single end	85.15
JD1A-120	16 single end	85.86
JD1A-121	16 single end	86.57
JD1A-122	16 single end	87.28
JD1A-123	16 single end	87.99
JD1A-124	16 single end	88.70
JD1A-125	16 single end	89.41
JD1A-126	16 single end	90.12
JD1A-127	16 single end	90.83
JD1A-128	16 single end	91.54
JD1A-129	16 single end	92.25
JD1A-130	16 single end	92.96
JD1A-131	16 single end	93.67
JD1A-132	16 single end	94.38
JD1A-133	16 single end	95.09
JD1A-134	16 single end	95.80
JD1A-135	16 single end	96.51
JD1A-136	16 single end	97.22
JD1A-137	16 single end	97.93
JD1A-138	16 single end	98.64
JD1A-139	16 single end	99.35
JD1A-140	16 single end	100.06
JD1A-141	16 single end	100.77
JD1A-142	16 single end	101.48
JD1A-143	16 single end	102.19
JD1A-144	16 single end	102.90
JD1A-145	16 single end	103.61
JD1A-146	16 single end	104.32
JD1A-147	16 single end	105.03
JD1A-148	16 single end	105.74
JD1A-149	16 single end	106.45
JD1A-150	16 single end	107.16
JD1A-151	16 single end	107.87
JD1A-152	16 single end	108.58
JD1A-153	16 single end	109.29
JD1A-154	16 single end	110.00
JD1A-155	16 single end	110.71
JD1A-156	16 single end	111.42
JD1A-157	16 single end	112.13
JD1A-158	16 single end	112.84
JD1A-159	16 single end	113.55
JD1A-160	16 single end	114.26
JD1A-161	16 single end	114.97
JD1A-162	16 single end	115.68
JD1A-163	16 single end	116.39
JD1A-164	16 single end	117.10
JD1A-165	16 single end	117.81
JD1A-166	16 single end	118.52
JD1A-167	16 single end	119.23
JD1A-168	16 single end	119.94
JD1A-169	16 single end	120.65
JD1A-170	16 single end	121.36
JD1A-171	16 single end	122.07
JD1A-172	16 single end	122.78
JD1A-173	16 single end	123.49
JD1A-174	16 single end	124.20
JD1A-175	16 single end	124.91
JD1A-176	16 single end	125.62
JD1A-177	16 single end	126.33
JD1A-178	16 single end	127.04
JD1A-179	16 single end	127.75
JD1A-180	16 single end	128.46
JD1A-181	16 single end	129.17
JD1A-182	16 single end	129.88
JD1A-183	16 single end	130.59
JD1A-184	16 single end	131.30
JD1A-185	16 single end	132.01
JD1A-186	16 single end	132.72
JD1A-187	16 single end	133.43
JD1A-188	16 single end	134.14
JD1A-189	16 single end	134.8

MICROPROCESSOR COMPONENTS

INTERMIL

Table listing various microprocessor components with part numbers and prices.

Table listing static RAM components with part numbers and prices.

Table listing dynamic RAM components with part numbers and prices.

Table listing EPROM components with part numbers and prices.

Table listing PROMS components with part numbers and prices.

Table listing microprocessor chips with part numbers and prices.

Table listing ROM's components with part numbers and prices.

Table listing various Intersil components with part numbers and prices.

Table listing various 74LS components with part numbers and prices.

MICROPROCESSOR MANUALS

Table listing microprocessor manuals with part numbers and prices.

8000/8800 SUPPORT DEVICES

Table listing 8000/8800 support devices with part numbers and prices.

8080/8080-A SUPPORT DEVICES

Table listing 8080/8080-A support devices with part numbers and prices.

DATA ACQUISITION

Table listing data acquisition components with part numbers and prices.

SPECIAL FUNCTION

Table listing special function components with part numbers and prices.

TELEPHONE/KEYBOARD CHIPS

Table listing telephone/keyboard chips with part numbers and prices.

Table listing various 74C components with part numbers and prices.

LINEAR

Table listing linear components with part numbers and prices.

Table listing various 74S/PROMS* components with part numbers and prices.

Advertisement for shipping services: SHIPMENT IN 24 HOURS, 6:00AM to 6:00PM (PST), Call: (415) 592-8097.

IC SOCKETS

Table listing IC sockets with part numbers and prices.

Table listing CA-LINEAR components with part numbers and prices.

Table listing CA3089N components with part numbers and prices.

Table listing wire wrap sockets with part numbers and prices.

Table listing CD-CMOS components with part numbers and prices.

Table listing solderless standard components with part numbers and prices.

Table listing solderless standard components with part numbers and prices.

Table listing various CD4000 components with part numbers and prices.

Table listing various CD4000 components with part numbers and prices.

Table listing various CD4000 components with part numbers and prices.

CAPACITOR CORNER

Table listing various capacitor components with part numbers and prices.

DIGITAL RESEARCH COMPUTERS

(214) 271-3538

32K S-100 EPROM CARD

NEW!

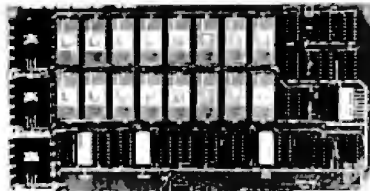

\$79.95
KIT

USES 2716's
Blank PC Board - \$34
ASSEMBLED & TESTED
ADD \$30

SPECIAL: 2716 EPROM's (450 NS) Are \$9.95 Ea. With Above Kit.

KIT FEATURES

- 1 Uses +5V only 2716 (2Kx8) EPROM's
- 2 Allows up to 32K of software on line!
- 3 IEEE S-100 Compatible
- 4 Addressable as two independent 16K blocks
- 5 Cromemco extended or Northstar bank select
- 6 On board wait state circuitry if needed
7. Any or all EPROM locations can be disabled
8. Double sided PC board, solder-masked, silk-screened.
9. Gold plated contact fingers
10. Unselected EPROM's automatically powered down for low power.
11. Fully buffered and bypassed.
- 12 Easy and quick to assemble.

64K S100 STATIC RAM

\$349⁰⁰
KIT

NEW!

LOW POWER!
RAM OR EPROM!
BLANK PC BOARD
WITH DOCUMENTATION
\$55

SUPPORT ICs + CAPS
\$17.50

FULL SOCKET SET
\$14.50

FULLY SUPPORTS THE
NEW IEEE 696 S100
STANDARD
(AS PROPOSED)

FOR 56K KIT \$299
ASSEMBLED AND
TESTED ADD \$40



FEATURES:

- * Uses new 2K x 8 (TMM 2016 or HM 6116) RAMs.
- * Fully supports IEEE 696 24 BIT Extended Addressing.
- * 64K draws only approximately 500 MA.
- * 200 NS RAMs are standard. (TOSHIBA makes TMM 2016s as fast as 100 NS. FOR YOUR HIGH SPEED APPLICATIONS.)
- * SUPPORTS PHANTOM (BOTH LOWER 32K AND ENTIRE BOARD).
- * 2716 EPROM's may be installed in any of top 48K.
- * Any of the top 8K (E000 H AND ABOVE) may be disabled to provide windows to eliminate any possible conflicts with your system monitor, disk controller, etc.
- * Perfect for small systems since BOTH RAM and EPROM may co-exist on the same board.
- * BOARD may be partially populated as 56K.

16K STATIC RAM KIT-S 100 BUSS

PRICE CUT!

\$149⁹⁵
KIT

FOR 4MHZ
ADD \$10

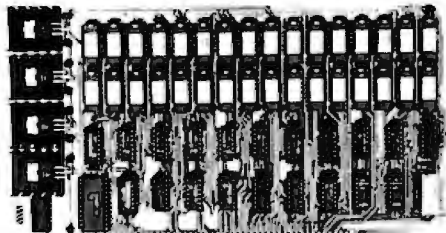

KIT FEATURES

- 1 Addressable as four separate 4K Blocks
- 2 ON BOARD BANK SELECT circuitry (Cromemco Standard) Allows up to 512K on line!
- 3 Uses 2114 (450NS) 4K Static RAMs
- 4 ON BOARD SELECTABLE WAIT STATES
- 5 Double sided PC Board, with solder mask and silk screened layout Gold plated contact fingers
- 6 All address and data lines fully buffered
- 7 Kit includes ALL parts and sockets
- 8 PHANTOM is jumpered to PIN 87
- 9 LOW POWER under 1.5 amps TYPICAL from the +5 Volt Buss
- 10 Blank PC Board can be populated as any multiple of 4K

BLANK PC BOARD W/DATA-\$33
LOW PROFILE SOCKET SET-\$12
SUPPORT IC'S & CAPS-\$19.95
ASSEMBLED & TESTED-ADD \$35

**OUR #1 SELLING
RAM BOARD!**

64K SS-50 STATIC RAM

\$259⁰⁰
(48K KIT)

NEW!

LOW POWER!
RAM OR EPROM!
BLANK PC BOARD
WITH
DOCUMENTATION
\$52

SUPPORT ICs + CAPS
\$18.00

FULL SOCKET SET
\$15.00

56K Kit \$309

64K Kit \$359

ASSEMBLED AND
TESTED ADD \$40

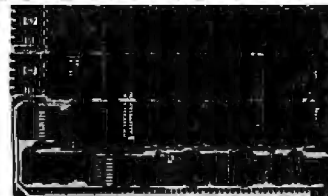

FEATURES:

- * Uses new 2K x 8 (TMM 2016 or HM 6116) RAMs.
- * Fully supports Extended Addressing.
- * 64K draws only approximately 500 MA.
- * 200 NS RAMs are standard. (TOSHIBA makes TMM 2016s as fast as 100 NS. FOR YOUR HIGH SPEED APPLICATIONS.)
- * Board is configured as 3-16K blocks and 8-2K blocks (within any 64K block) for maximum flexibility.
- * 2716 EPROMs may be installed anywhere on Board.
- * Top 16K may be disabled in 2K blocks to avoid any I/O conflicts.
- * One Board supports both RAM and EPROM.
- * RAM supports 2MHZ operation at no extra charge!
- * Board may be partially populated in 16K increments.

STEREO! S-100 SOUND COMPUTER BOARD

NEW!

At last, an S-100 Board that unleashes the full power of two unbelievable General Instruments AY3-8910 CMOS computer sound IC's. Allows you under total computer control to generate an infinite number of special sound effects for games or any other program. Sounds can be called in BASIC, ASSEMBLY LANGUAGE, etc.

KIT FEATURES:

- * TWO GI SOUND COMPUTER IC'S.
- * FOUR PARALLEL I/O PORTS ON BOARD.
- * USES ON BOARD AUDIO AMPS OR YOUR STEREO
- * ON BOARD PROG TYPING AREA
- * ALL SOCKETS, PARTS AND HARDWARE ARE INCLUDED.
- * PC BOARD IS SOLDERMASKED, SILK SCREENED, WITH GOLD CONTACTS
- * EASY, QUICK, AND FUN TO BUILD WITH FULL INSTRUCTIONS
- * USES PROGRAMMED I/O FOR MAXIMUM SYSTEM FLEXIBILITY.

Both Basic and Assembly Language Programming examples are included

SOFTWARE:

SCL™ is now available! Our Sound Command Language makes writing Sound Effects programs a SNAP! SCL™ also includes routines for Register-Examine-Modify, Memory-Examine-Modify, and Play-Memory. SCL™ is available on CP/M™ compatible diskette or 2708 or 2716 Diskette - \$24.95 2708 - \$18.95 2716 - \$29.95. Diskette includes the source. EPROM'S are ORG at E000H. (Diskette is 8 Inch Soft Sector)

COMPLETE KIT!

\$84⁹⁵

(WITH DATA MANUAL)

BLANK PC
BOARD W/DATA
\$31

SPECIAL PURCHASE!

UART SALE!

TR1602B — SAME AS TMS6011,
AY5-1013, ETC. 40 PIN DIP

TR1602B

\$2⁹⁵
EACH

4 For \$10⁰⁰

CRT CONTROLLER CHIP

SMC #CRT 5037. PROGRAMMABLE FOR 80 x 24, ETC. VERY RARE
SURPLUS FIND. WITH PIN OUT. \$12.95 EACH.

4K STATIC RAM

National Semiconductor AY3-8910. Arranged 4K x 1. +5V, 18 PIN DIP. A Lower Power Alternative Replacement for TMS 4044. 450 NS. Several Boards on the way. We Accept Pre-Paid Orders. SUPER SURPLUS PURCHASE! PRIME NEW

8 FOR \$16 32 FOR \$59.95

NEW! G.I. COMPUTER SOUND CHIP

AY3-8910. As featured in July, 1979 BYTE! A fantastically powerful Sound & Music Generator. Perfect for use with any 8 Bit Microprocessor. Contains: 3 Tone Channels, Noise Generator, 3 Channels of Amplitude Control, 16 bit Envelope Period Control, 2-8 Bit Parallel I/O, 3 D to A Converters, plus much more! All in one 40 Pin DIP. Super easy interface to the S-100 or other busses. **\$11.95 PRICE CUT!**

SPECIAL OFFER: ~~\$14.95~~ each Add \$3 for 60 page Data Manual.

Digital Research Computers
(OF TEXAS)

P.O. BOX 401565 • GARLAND, TEXAS 75040 • (214) 271-3538

TERMS: Add \$2.00 postage. We pay balance. Orders under \$15 add 75¢ handling. No C.O.D. We accept Visa and MasterCard. Tex. Res. add 5% Tax. Foreign orders (except Canada) add 20% P & H. Orders over \$50, add 85¢ for insurance.

ALL SALES ARE MADE SUBJECT TO THE TERMS OF OUR 90 DAY LIMITED WARRANTY. A COPY OF THIS WARRANTY IS AVAILABLE FREE, ON REQUEST.

NEW LOWER PRICES

"THE BIG BOARD"
 OEM - INDUSTRIAL - BUSINESS - SCIENTIFIC
SINGLE BOARD COMPUTER KIT!
 Z-80 CPU! 64K RAM!

NEW!

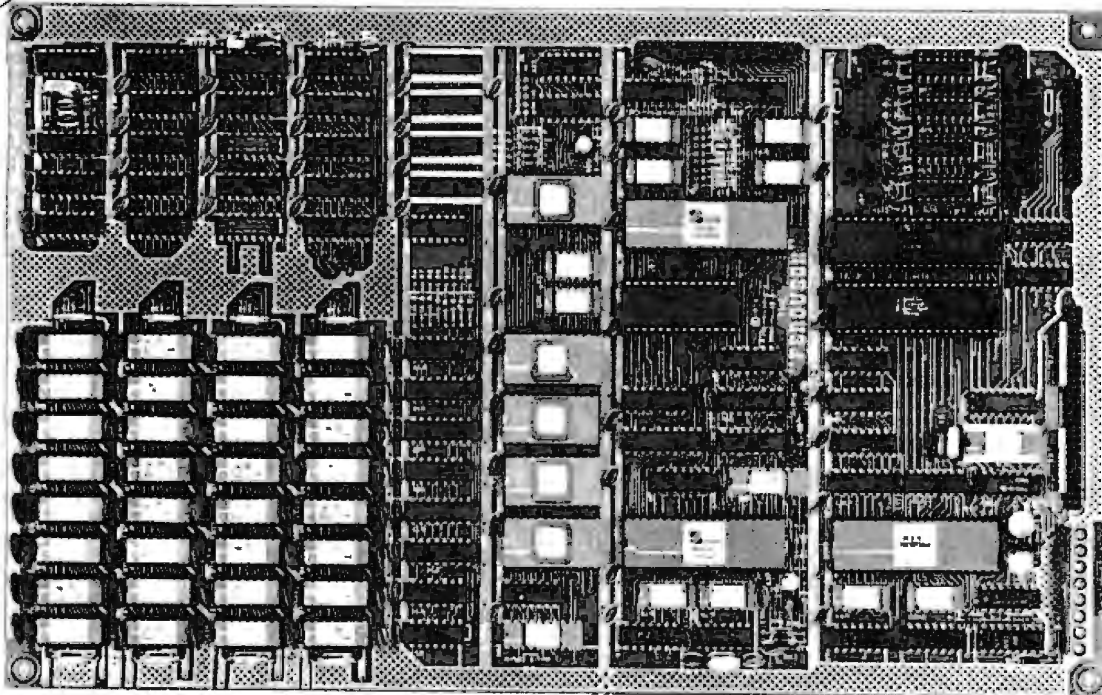

PARTIALLY ASSEMBLED KITS
 For All Sockets Installed
 And Soldered Add \$50.

WANT MORE INFO?
 Full Documentation and
 Schematics — \$5.

THE BIG BOARD PROJECT: Three years in the works, and maybe too good to be true. A tribute to hard headed, no compromise, high performance, American engineering! The Big Board gives you all the most needed computing features on one board at a very reasonable cost. The Big Board was designed from scratch to run the latest version of CP/M*. Just imagine all the off-the-shelf software that can be run on the Big Board without any modifications needed! Take a Big Board, add a couple of 8 inch disc drives, power supply, an enclosure, C.R.T., and you have a total Business System for about 1/3 the cost you might expect to pay.

\$399.00 (64K KIT BASIC I/O)

SIZE: 8 1/2 x 13 3/4 IN.
 SAME AS AN 8 IN. DRIVE.
 REQUIRES: -5V @ 3 AMPS
 + 12V @ .5 AMPS.

FULLY SOCKETED! FEATURES: (Remember, all this on one board!)

64K RAM

Uses industry standard 4116 RAM'S. All 64K is available to the user, our VIDEO and EPROM sections do not make holes in system RAM. Also, very special care was taken in the RAM array PC layout to eliminate potential noise and glitches.

Z-80 CPU

Running at 2.5 MHZ. Handles all 4116 RAM refresh and supports Mode 2 INTERRUPTS. Fully buffered and runs 8080 software.

SERIAL I/O (OPTIONAL)

Full 2 channels using the Z80 SIO and the SMC 8116 Baud Rate Generator. FULL RS232! For synchronous or asynchronous communication. In synchronous mode, the clocks can be transmitted or received by a modem. Both channels can be set up for either data-communication or data-terminals. Supports mode 2 Int. Price for all parts and connectors: \$49

BASIC I/O

Consists of a separate parallel port (Z80 PIO) for use with an ASCII encoded keyboard for input. Output would be on the 80 x 24 Video Display.

BLANK PC BOARD — \$149

The blank Big Board PC Board comes complete with full documentation (including schematics), the character ROM, the PFM 3.3 MONITOR ROM, and a diskette with the source of our BIOS, BOOT, and PFM 3.3 MONITOR.

24 x 80 CHARACTER VIDEO

With a crisp, flicker-free display that looks extremely sharp even on small monitors. Hardware scroll and full cursor control. Composite video or split video and sync. Character set is supplied on a 2716 style ROM, making customized fonts easy. Sync pulses can be any desired length or polarity. Video may be inverted or true. 5 x 7 Matrix - Upper & Lower Case

FLOPPY DISC CONTROLLER

Uses WD1771 controller chip with a TTL Data Separator for enhanced reliability. IBM 3740 compatible. Supports up to four 8 inch disc drives. Directly compatible with standard Shugart drives such as the SA800 or SA801. Drives can be configured for remote AC off-on. Runs CP/M* 2.2.

TWO PORT PARALLEL I/O (OPTIONAL)

Uses Z-80 PIO. Full 16 bits, fully buffered, bi-directional. User selectable hand shake polarity. Set of all parts and connectors for parallel I/O: \$19.95

REAL TIME CLOCK (OPTIONAL)

Uses Z-80 CTC. Can be configured as a Counter on Real Time Clock. Set of all parts: \$9.95

CP/M* 2.2 FOR BIG BOARD

The popular CP/M* D.O.S. to run on Big Board is available for \$159.00.

PRICE CUT!

PFM 3.3 2K SYSTEM MONITOR

The real power of the Big Board lies in its PFM 3.3 on board monitor. PFM commands include: Dump Memory, Boot CP/M*, Copy, Examine, Fill Memory, Test Memory, Go To, Read and Write I/O Ports, Disc Read (Drive, Track, Sector), and Search. PFM occupies one of the four 2716 EPROM locations provided. Z-80 is a Trademark of Zilog.

Digital Research Computers
 (OF TEXAS)
 P.O. BOX 401565 • GARLAND, TEXAS 75040 • (214) 271-3538

TERMS: Shipments will be made approximately 3 to 6 weeks after we receive your order. VISA, MC, cash accepted. We will accept COD's (for the Big Board only) with a \$75 deposit. Balance UPS COD. Add \$4.00 shipping. USA AND CANADA ONLY

ADVANCED COMPUTER PRODUCTS

SEND \$2.00 for 104 PAGE CATALOG



Vista COMPUTER

Vision 80

as reviewed in May BYTE pg. 266

This is the widely discussed Cadillac 80 column card for the Apple II. The Vision 80 responds to more Apple text screen commands than any other board. It supports PASCAL, Microsoft's Z80 Softcard and can be used as an intelligent terminal.

List Price... \$395.00 Special Low Price... \$269.00

The Vision 80 can also be used in conjunction with the Vision 40 (allows enhanced character sets) and the Vision 20 for lower case.

IBM COMPARE

- ### UNBEATABLE ADD-ON PRICES!
- MEMORY
 - VISTA 576K Expandable in 64K Increments
 - w/256K populated only \$999
 - w/512K populated only 1599
 - w/576K populated only 1799
 - VISTA/SUPERCALC/SUPERCACHE*
 - 192K with IBM SUPERCALC 799
 - MICROSOFT RAMCARD
 - 64K w/RAMDRIVE (expandable) 419
 - 256K w/RAMDRIVE 899
 - AST MEMORY CARD
 - 64K EXPANDABLE 499
 - 256K w/PARTY 899
 - AST "COMBO CARD"
 - MEMORY, ASYNCH COMM, PARALLEL
 - 64K SP 525
 - 256K SP 1049
 - INTERFACE CARDS
 - AST ADVANCED COMMUNICATIONS
 - 2 RS232 PORTS 269
 - BABY BLUE Z80 CARD 550
 - PROTOTYPE CARD 69
 - EXTENDER CARD 19
 - DISK DRIVES - ADD-IN (Compatible) 239
 - EPSON ADD-ON PRINTER 429
 - SUPR'MOD V RF MODULATOR 49
 - EPSON TO IBM CABLE 49

EPSON

MX80 \$429.00
 MX80FT 529.00
 MX100FT 725.00
 Apple I/O w/cable 54.95
 Serial I/O w/cable 95.00
 Serial I/O w/25' cable 129.00
 Serial Fax 89.00
 Printer Exp./Ribbon 29.95
 Printer Exp./Ribbon 39.95

OLYMPIA

Letter quality Daisy Wheel Typewriter interfaces to Apple, Atari, NEC, TRS80 and RS232 Serial ports.

ES1000R Comp. Print. \$1900 \$1395
 ES100 Typewriter Print. 1195 1050
 GO 10 Apple I/O card 349 188
 GO11 Other I/O's 349 229
 I/O Cable 48 29

C. Itoh

STARWRITER F-10
 40 LPI's Daisy Wheel, 18pg
 PRD-Writer 8510A
 20 CPS Dot Matrix Printer 589

DIABLO 630

OKIDATA

- 120 cps
- Logic seeking
- Double width & condensed print
- Font selection, character pitch & line spacing program controllable
- Bi-directional printing

82A 120 cps w/tractor \$499.00
 83A 120 cps 136 columns 740.00
 84A-R 200 cps 136 col. 999.00
 84A-S Serial w/2K Buffer 1199.00
 Apple Card 39.95
 Apple Cable 19.95
 Serial Card w/2K 129.95
 Graphics ROM (82A/83A) 75.00

DIABLO 630

DIABLO 630RD \$2095

NEC 8023

144 x 160 dots/inch Proportional spacing
 Lower case descenders • Nx9 dot matrix • 8 char sizes • 5 unique alphabets
 Greek character set • Graphic symbols
 100 cps • Bi-directional logic seeking
 Adjustable characters • Single-sheet friction feed • Vertical & horizontal tabbing

NEC 8023 List \$795 ACP \$549

IDS PAPER TIGER

Dot Resolution Graphics • 9-wide 18pg printhead
 Lowercase descenders
 Over 150cps
 Bi-directional, logic seeking & 6

ENGLISH, SPANISH, FRENCH, GERMAN, ITALIAN, GREEK, JAPANESE, HEBREW, ARABIC, PUNYAN, CYRILLIC, BALTIC, VIETNAMESE, THAI, HANGUL, KOREAN, CHINESE, JAPANESE, HEBREW, ARABIC, PUNYAN, CYRILLIC, BALTIC, VIETNAMESE, THAI, HANGUL, KOREAN, CHINESE

Prism 80 \$899 \$ 699
 IDS Paper Tiger 560G 1395 1099
 Prism 132 (color) 1995 1875

TERMINALS

TELEVIDEO

910C	8399
920C	789
925C	749
950	969

SOROC

10 120	8995
10 130	595
10 140	999

OTRONA ATTACHE

- Truly Portable 16 lbs
- Includes CP/M*
- Wordstar-plus* Basic 80, Visi & Chartlet
- Includes 1/2 Double Density, Double Sided thin drives
- 380K Bytes each

ACP PRICE \$3595.00

KAYCOMP II

- Full 9" Green Screen
- CP/M Based
- Portable Business Computer

Complete w/CP/M 2.2 BASIC, Magic Worksheet, Select Word Processing and Teach

ACP Price only \$1699

ATARI

MODEL	LIST	ACP
800 with 16K	\$1090.00	\$689.95
800 with 48K	1280.00	789.95
800 with 32K + 128K		1295.00
810 Disk Drive	600.00	469.95
825 Printer	999.00	699.95
830 Acoustic Modem	199.00	159.95
850 Interface Module	219.95	189.95
Atari Visicalc	200.00	169.00
Atari PAC-MAN		CALL
Microtek 16K RAM	99.00	75.00
Microtek 32K RAM	199.00	149.00
Microtek 64K RAM		CALL

Commodore

VIC-20 Complete Personal Computer

- 5K RAM
- Full Color
- 81 Key keyboard
- 4 Dual Special-Function keys
- Serial Ports
- Cassette Port
- Expansion Port
- BASIC Language
- Composite Video Output (connects to standard color TV set)

VIC-20 only \$279.95

XEROX

ASK ABOUT FREE SOFTWARE OFFER!

MODEL	LIST	ACP
820-II 8" Disks	\$3795	\$2995
820-I 5 1/4" Disks	2995	2495
820-III with CP/M	3595	2895

SANYO EQUIVALENT

MODEL	LIST	ACP
P 1 9" Green	\$199	\$159
P 1 12" Green	199	149
P 1 12" Orange	249	199

TERMINALS

TELEVIDEO

910C	8399
920C	789
925C	749
950	969

SOROC

10 120	8995
10 130	595
10 140	999

TERMINALS

TELEVIDEO

910C	8399
920C	789
925C	749
950	969

SOROC

10 120	8995
10 130	595
10 140	999

TOLL FREE 800-854-8230

910-595-1565

FOURTH DIMENSION SYSTEMS

Apple II Compatible Disk Drive

Totally compatible to Apple Drives.

only \$379.00

Controller \$119.00

Just plug in and run.

Vista Computer Company

Add 8" Disk Drives To Your Apple II Up To 2.4 Megabyte!

Now "TRIMLINE V1100" with Tandem Thinline DS DD Drives.

Tandem Dual DS DD	\$1995.00
Quame Dual DS DD	1895.00
Strugart Dual 801R	1495.00

Apple Computer

Authorized Dealer

ON DISK FOR APPLE SAVE UP TO 40% OFF

MODEL	ACP
Visicalc 3.3	\$189
Supercalc	189
Visi Trend/Visi Plot.	235
Visi Dex	199
Visi File	199
Visi Plot	159
Desk Top Plan II/III	199
Visi Schedule	239
Visi Term	89
Zork	34
Verax Form	287
dBase II Ashton-Tate.	489
WordStar	235
Mail Merge	82
Spell Star	159
Data Star	189
Calc Star	189
Super Sort	132
Spellguard	219
DB Master (new)	178
DB Utility	72
PFS II/III	69
Report II/III	69
Locksmith 4.0	74
Accounting Plus	1195
Microcenter	229
Microtelegraph	229

Apple Computer

Authorized Dealer

ON DISK FOR APPLE SAVE UP TO 40% OFF

MODEL	ACP
Visicalc 3.3	\$189
Supercalc	189
Visi Trend/Visi Plot.	235
Visi Dex	199
Visi File	199
Visi Plot	159
Desk Top Plan II/III	199
Visi Schedule	239
Visi Term	89
Zork	34
Verax Form	287
dBase II Ashton-Tate.	489
WordStar	235
Mail Merge	82
Spell Star	159
Data Star	189
Calc Star	189
Super Sort	132
Spellguard	219
DB Master (new)	178
DB Utility	72
PFS II/III	69
Report II/III	69
Locksmith 4.0	74
Accounting Plus	1195
Microcenter	229
Microtelegraph	229

HEWLETT PACKARD

HP85A Computer \$1985
 HP87 Computer 1945
 • 82907A 32K Model 239
 • 82908A 64K Model 349
 • 82909A 128K Model 599
 • 82900A CP/M with 64K 425

HP125 Computer 1985
 7470 Low Cost Plotter 1265
 8985A 8" Dual Floppy 5135

HEWLETT PACKARD

CALCULATORS

HP41C Prog Scientific	\$189
HP41CV w/2.2K Memory	256
HP41 Memory Module	26
HP41 Quad RAM	83
HP41 Card Reader	169
HP41 Printer	292
HP41 Optical Wand	99
HP-IL Interface Loop	119
HP11C Advanced Scientific	119
HP12C Financial	129
HP34C Prog Scientific	112
HP38C Prog Business	116

Apple Computer

Authorized Dealer

MODEL	LIST	ACP
Apple II Plus w/48K	\$1530.00	\$1099.00
Apple II Plus w/64K	1729.00	1199.00
Apple II System Special w/64K, Z80 Card, Visiplot 80	2519.00	1775.00
Apple II w/128K	2495.00	2695.00
Apple II w/256K	4295.00	3495.00
Profile Hard Disk Drive	3499.00	2899.00
Vista Apple II Teletext	195.00	169.00

*Apple Products Available In-store Only!

APPLE HARDWARE

MODEL	LIST	ACP
Apple II Disk II w/Control'r	\$525.00	\$325.00
Apple II Disk II w/c	525.00	449.00
Apple Family System	2495.00	1995.00
Prototype Card	24.00	21.95
IEEE-488 Interface	450.00	375.00
Extended Warranty - 1 yr	225.00	199.00
Super Serial Card	195.00	174.95
Language Card	195.00	169.95
Graphic Tablet w/I/O	795.00	695.00

*Available In-store Only!

MORE HARDWARE

MODEL	LIST	ACP
MICROSOFT Z80 Softcard	349.00	\$256.00
16K Ramcard	195.00	129.00
The Premium Package	899.00	579.00

SSM

ATC II 4 Function Serial/Parallel	225.00	179.00
AIO Serial/Parallel	195.00	165.00

KEYBOARD COMPANY

Numeric Keypad	149.95	124.95
Apple II Joystick	49.95	44.50
Apple II Handcontrollers	29.95	25.95

PROMTHEUS

VERSAbox Spool/Buf'r	249.00	199.00
VERSAcard Four-in-1	199.00	166.00
AUTO-DOC diagnostics	99.00	82.00

VISTA COMPUTER CO.

Visiplot 80x24 Card	395.00	269.00
Visiplot 40 col. enhance	199.00	149.00
Visiplot 20 L case ROM	29.95	25.00
A800 8" DS, DD, Controller	595.00	499.00
PB7M Development Bd	595.00	399.00
16M IBM typewriter I/O	195.00	169.00
40 Char Type-ahead Buffer	49.95	35.00

INDEX

Videoterm 80x24 Card	345.00	279.00
Keyboard Enhancer II	149.00	129.00
Soft Switch	25.00	30.00
Function Strip Keys	79.00	69.00

PRACTICAL PERIPHERALS

16K Microbuffer	259.00	220.00
32K Microbuffer	299.00	253.00
Snapshot Option	69.00	59.00

VETROX

Type n' Talk Speech	375.00	339.00
---------------------	--------	--------

SCOTT INSTRUMENTS

Voice Recogn'n VET80	799.00	675.00
----------------------	--------	--------

CORVUS

5 Mb Hard Disk	3750.00	2995.00
10 Mb Hard Disk	5350.00	4325.00
20 Mb Hard Disk	6450.00	5240.00

ORANGE MICRO

The Grappler I/O	195.00	135.00
------------------	--------	--------

SATURN SYSTEMS

32K RAM Card	239.00	189.00
64K RAM Card	425.00	355.00
128K RAM Card	599.00	505.00

NOVATION

Apple-Cat II	369.00	329.00
--------------	--------	--------

HAYES MICROCOMPUTER

Hayes Chronograph	249.00	229.00
Microdrom II	349.00	289.00
Smartwriter	299.00	229.00

MOUNTAIN COMPUTER

CPS Multifunction	239.00	169.00
RAM Plus	189.00	139.00
Expansion Chassis	750.00	699.00
Music System	395.00	335.00
100,000 Day Clock	375.00	340.00
The Clock	280.00	249.00
A/D plus D/A	350.00	299.00
SuperTalker	199.00	169.00
Infol X-10 Controller	200.00	175.00
ROM Plus	155.00	129.00
Keyboard Filter ROM	55.00	44.00
Copy ROM	55.00	44.00
ROM Writer	175.00	159.00

M&R ENTERPRISES

Sup'r 80x24 Card	395.00	279.00
Sup'r Switcher 6 Amp Power Supply	295.00	239.00
Sup'Mod II RF Modulator	35.00	28.00
Apple Fan	55.00	43.00

ALS

The "Z" Card Z80 card	295.00	219.00
Smart Plotter	349.00	279.00
The Synergizer Package	699.00	549.00

Apple II 16K

Compatible with Z80 Softcard* ... PASCAL CP/M**

Full 1 year Warranty. Top Quality by COEX

NEW LOW PRICE

\$74.95

Also from COEX NEW EPSON Parallel Interface for Apple.

With cable \$54.95

TERMS: MD Company's Check, Bank Wire, Personal Checks, A/C, VISA, MC, AMEX, CB add 3% service charge. Add 3% shipping & handling. 1% w/charge is greater. Add 10% to non-US Parcel Post. Include telephone number MD COEX. Prices subject to change without notice. Some items subject to prior sale. We reserve the right to adjust the manufacturer's retail prices.

ADVANCED COMPUTER PRODUCTS

SEND \$2.00 for 104 PAGE CATALOG

16K Apple™ Ramcard



LIST 195
ACP
\$74.95

- Full 1 year warranty
- Top quality — gold fingers
- Expand Apple II 48K to 64K
- Compatible with Z-80 Softcard™
- Allows system to run with CP/M™, PASCAL, DOS 3.3, COBAL, Visicalc, etc.
- Supplied with extra 16K RAM & has (2) LED's

32K STATIC RAM

- 2 or 4 MHz
Expandable
Uses
2114L's
- 16K 4 MHz Kit \$159.95
 - 16K 4 MHz A/T 217.95
 - 32K 4 MHz Kit \$199.95
 - 32K 4 MHz A/T 339.00
 - BARE BOARD 39.95
 - Bare Board w/altipartsless mem. 99.95

Astec RF Modulator

- for
COLOR
&
B/W
- P/N 1082 Channel 3 or 4 \$6.95
 - P/N 4151 UHF Channel 33 8.95

MOSTEK 4K RAMS

29¢ ea.
200,000 pieces in stock — priced to move
Same as MK4015 except 1ms refresh MK4015 4Kx1 RAM

PMI "Super Beta" LOW POWER AMPLIFIER

INTERNALLY COMPENSATED
P/N OP12GJ

Voltset = 1.0 mV
Ibias = 5.0mA
Gain = 40V/mV
(quantity limited)

BARE BOARDS

- S-100 Sound Board \$34.95
- 8080A CPU 34.95
- 32K Static RAM (2114) 34.95
- 8K EPROM (2708) 24.95
- 2708/2716 EPROM 24.95
- ACP Proto Board 32.95
- Vector 8800 Proto 22.20
- 8800 8803 11 slot MB 29.95
- ACP Extender with connector 18.95
- 13 Slot Mother Board (WMC) 32.95
- 9 Slot Mother Board (WMC) 29.95
- 8 Slot Mother Board (Expandable) 34.95
- Floppy PCB (8" SHUGART) 39.95
- S100(A5-8910) Sound Board 34.95
- Apple Sound Board 24.95

UV "EPROM" ERASER

Model UVs-11E
\$79.95
Holds 4 EPROM's at a time.
\$325.00

16K Memory Expansion Kits for Apple/TRS-80

8 pins 4116 16K
200/250S
Specify computer
CALL FOR VOLUME PRICING

"D" SUB CONNECTORS

Unreal price. DB37 male, DB25 female. Gold PC mount with mounting holes. Mfg. AMP. Specify 25 or 37 pins.

BD37 \$2.50 DB25 \$1.95

Stepper Motor

USED IN DATA PRODUCTS PRINTER
\$19.95 ea.

12 VOLT BUZZER/HORN

2" DIAMETER ALL METAL
2/\$1.99

GE D43C3

PNP power
HFE = 40-120
VCE = 30
IC = 3A
6,000 pcs available
69¢ ea.

4K STATIC RAM

SELL-OFF
10/\$9.90
Same as TMS4044 but designed specifically for Z-80 based systems. This is a full spec 4Kx1 RAM, 4500-5. Order P/N Zsig6104-4 while supplies last.

Zilog Z8 CPU

with TINY BASIC
Debug prog. \$49.95
Plus 6132 companion quasi-static RAM 29.95

"BLINKER" LED's

Respond to sound. Complete, ready to wear (2" x 2"). Sold at Newman Marcus for 69¢ ACP \$49.95 red, yellow, green LEDs

CONNECTORS

DB25P (RS232) \$3.25
DB25S Female 3.75
Hood 1.25
Set with Hood, Sale 7.50
22/44 S/T. KM 2.95
43/86 S/T. M/T 6.95
50/100 S-100 Connector W/W 4.95
50/100 S-100 Connector S/T 3.95

Full ASCII Encoded Keyboards

RG1128-Character, 58-Key Typewriter Format for Alphabetic Entry
VP-606 Async serial output. Reg. \$99.00
ACP SALE ... \$69.95

MICROPROCESSORS

Z8001	\$98.00	8008-1	\$14.95	8002P	14.95
Z8002	69.00	2901	9.90	8035	14.95
Z80	9.95	2901A	14.95	8039	12.95
Z80A	11.95	8000A	49.95	8073W	34.95
741 (Z80C)	1.95	8002	9.95	8755	49.95
2650	18.95	8002A	19.95	8746	49.95
1802	9.75	8000	26.95	8006	30.00
8000A	4.75	8000	11.75	8006	49.95
8005	14.95	8000B	19.95	8000Q	129.95

RAMS

6116/2016	\$7.95	2147	\$5.99	5290	\$1.99
6254-64K	8.50	411	5.99	5298	1.49
4116-2	1.99	414	4.69	6500	4.50
4116-2 8/12	9.50	1101	.99	6510	6.79
2101	3.99	1103	.99	6561	3.79
2102	.79	4027	4.69	6604	3.99
21L02-2	1.49	4044	3.99	6605	7.99
21L02-4	1.29	4050	4.69	9130	8.99
2111	3.49	4060	4.69	9140	8.99
2112	3.49	4066	3.99	93415	6.99
2114	1.99	4115	1.49	93425	6.99
2114L-2	1.29	4400	7.95		
2114L-4	2.29	4402	1.99		
2125	6.99	5280	4.60		

SUPPORT

8155	\$9.95	825988	95	66047	\$22.95
8156	9.95	8275	19.95	68488	19.95
8202	29.95	8279	9.50	46505	22.95
8205	26.99	6890	4.75	6520	6.95
8212	2.75	6820	6.50	6522	9.95
8214	4.95	6821	6.50	6520-X	24.95
8216	2.75	6828	10.50	6532	17.95
8224	2.95	6834	16.95	6551	19.95
8226	2.95	6845	22.95	Z80-PIO	6.50
8228	3.95	6847	27.95	Z80-PIO	9.50
8243	9.95	6820	5.25	Z80-CTC	6.50
8250	14.95	6852	5.25	Z80-CTC	9.50
8251	6.50	6660	10.95	Z80-DMA	19.95
8253	11.95	6662	10.95	Z80-DMA	27.95
8255	4.50	6675	5.95	Z80-SIO	24.95
8257	9.50	6680	2.49	Z80-SIO	29.95

MOS PROMS

2784 (8Kx8) TS	\$69.95	2708 (450nS)	\$5.75
2732 (4Kx8) TS	12.85	2708 (650nS)	5.25
2716/2516:5V	1.25	1702A	5.75
(2Kx8) TS	7.95	MM5204Q	14.50
2752/16:5V, 12V	17.95	MM5204Q	9.95
2752:5V, (450nS)	3.95		

HI-TECH

2531-001 (5V) Upper	\$9.50	DA008	\$9.95
2531-003 (5V) Lower	10.95	DA010	9.95
2531-ADM3 (5V) Lower	14.95	8038 Function Generator	4.50
MC6616 (MOS) Shifted 125K	MC4021 VCO	2.95	
MC6617 (MOS) Synthesized 135K	MM556VC	1.95	
MC6616/17 (MOS) Control 13.45	XR2205 Function Generator	3.25	
1771-011 "S" Amplifier	TR1602B (SV, 12V)	5.95	
1781 Dual Floppy	AY1510 (SV, 12V)	4.95	
1791-01 Dual Floppy	AY1510A/1812 (5-14V)	6.95	
1794-02 Dual Floppy	AY1510A/1812 (5V)	8.95	
175320 3S Floppy	4A842	8.95	
175700 DS Floppy	5A95	IM643	9.95
1691 Data Separator	1895	2350SRT	9.95
2143 Clock Generator	1895	16718 Astros	24.95
87008 Bit Binary	1350	MC14411	11.95
8701 10bit Binary	2102	WD141	14.95
8703 8 bit	1350	WD141	11.95
9400 Voltage Freq Conv	725	CM5016	16.95
875031 DigiBRC	1395	MM5250	15.95
1408L6 bit	5.95	AY5-2376	13.75
1408L8 bit	3.95	AY5-3900	13.75
0A001 016A	5.95	MM5740AC	8.95

SOCKETS

LOW PROFILE SOCKETS (TIN)

8 pin LP	.16	.15	.14
14 pin LP	.20	.19	.18
16 pin LP	.22	.21	.20
18 pin LP	.29	.28	.27
20 pin LP	.34	.32	.30
22 pin LP	.29	.27	.24
24 pin LP	.28	.26	.23
28 pin LP	.45	.44	.43
40 pin LP	.60	.59	.58

3L WIREWRAP SOCKETS (GOLD)

8 pin WW	.55	.54	.49
10 pin WW (Tin)	.65	.63	.57
14 pin WW	.75	.73	.67
16 pin WW	.90	.77	.70
18 pin WW	.95	.90	.81
20 pin WW	1.15	1.08	.99
22 pin WW	1.45	1.35	1.23
24 pin WW	1.35	1.26	1.14
26 pin WW	1.60	1.53	1.38
40 pin WW	2.20	2.09	1.89

SUPER IC CLOSEOUT SPECIALS

ULN2003	2/\$1.99	2N6121	3/\$1.00	8080A CPU	2.95	5027 CRT	\$9.95
74LS668	3/1.99	SIG 2652	3.95	2102 RAM	.75	11C24	2.89
74LS377	2/1.99	74S287	1.95	4080 RAM	1.49	95H03	2.89
8K5241	2/1.99	2758 EPROM	2.95	8K300 CPU	14.95	MM520	5.99
8259	6.95	74173/8T/10	5/1.99	74S387	1.96	9131 RAM	1.99
6581 RAM	2.95	280A CPU	4.95	2708 EPROM	8/29.95	EMM4402	1.99
LM733CN	3/1.99	6522	6.95	74LS93	3/1.00	1103 RAM	3/1.50
MC1414	3/1.99	6502 CPU	5.95	2114	8/14.50	8700A/D	2/16.95

TOLL FREE 800-854-8230

Mail Order: P.O. Box 17329 Irvine, CA 92713
Retail: 13108 E. Edinger, Santa Ana CA 92705 (714) 558-8913
542 W. Trimble, San Jose, CA 95131 (408) 946-7010

LINEAR

78H05K	\$5.95	LM1414N	\$1.90
78M06	1.49	LM1458CN	4.90
78M06	1.49	MC1488N	.99
LM108AH	2.95	MC1489N	.99
LM300CN	.99	LM1456N	.69
LM301CN	.35	LM1555N	.59
LM304H	1.98	LM1820N	.95
LM305H	1.89	LM1850N	.95
LM306H	3.25	LM1899N	3.10
LM307CN	.29	LM2111N	1.75
LM309CN	.99	LM2909N	2.99
LM309K	1.49	LM2950N	2.50
LM310CN	1.25	LM2917N	2.95
LM311D/CN	.89	CA3013T	2.19
LM312H	1.75	CA3018T	1.99
LM317T	1.70	CA3021T	3.49
LM318CN	1.19	CA3023T	2.99
LM319N/H	.25	CA3035T	2.75
LM320K-XX	1.35	CA3039T	1.29
LM320T-XX	1.39	CA3046N	1.29
LM320H-XX	1.25	LM3053N	1.49
LM323K	4.95	CA3059N	3.19
LM324N	3.75	CA3069N	3.19
LM337K	5.95	CA3082T	5.95
LM339K	6.95	LM3065N	1.49
LM339N	.95	CA3080T	1.29
LM340K-XX	1.75	CA3081N	1.69
LM340T-XX	1.25	CA3082N	1.69
LM340H-XX	1.25	CA3083N	1.55
LM344H	1.49	CA3086N	1.49
LM348N	1.20	CA3089N	2.99
LM350K	5.60	CA3096N	3.49
LM358CN	.98	CA3097N	1.99
LM360N	1.49	CA3130T	1.30
LM372N	1.95	CA3140T	1.19
LM376N	3.75	CA3146N	2.49
LM377N	2.75	CA3160T	1.19
LM3800CN	1-2.25	CA3190N	1.95
LM381N	1.79	CA3410N	.59
LM383T	1.95	MC3423N	1.49
LM386N	1.25	MC3460N	3.95
LM387N	1.25	CA3165N	1.40
LM390N	1.95	CA3600N	3.99
NE531T/3T	3.75	LM3900N	5.95
NE555V	.39	LM3905N	1.19
NE556N	.98	LM3909N	.98
NE561T	19.95	LM3914N	3.75
NE565N/H	1.40	CA3165N	2.49
NE566V/H	1.75	RC1391N	2.95
NE567V/H	1.50	RC4131N	3.75
NE592N	2.75	RC4136N	1.10
LM702H	1.99	RC4151N	3.70
LM709N/H	.29	RC4184T	4.95
LM710N/H	.75	RC4191T	4.40
LM711N/H	.39	ULN2001	1.25
LM715N	1.95	ULN2003	1.50
LM723N/H	6.95	SN75450N	.59
LM733N/H	.98	SN75451N	.35
LM739N	1.15	SN75452N	.49
LM740N/H	.33	SN75453N	.49
LM741CN-14	.19	SN75454N	.49
LM747N/H	.75	SN75491N	.89
LM748N/H	.39	SN75492N	.89
LM760CN	2.95	SN75493N	.89
LM1310N	1.80	SN75494N	.89
LM1330	1.40	SN75495N	1.40
MC1350	1.95	TL49CP	1.65
MC1358	1.75		

74S00

74S00	\$.39	74S124	3.69	74S244	\$2.99
74S02	.43	74S133	.54	74S251	1.35
74S03	.45	74S134	.66	74S253	1.35
74S04	.52	74S135	1.15	74S257	1.29
74S05	.52	74S136	1.69	74S258	1.29
74S06	.49	74S138	1.29	74S260	.75

CALIFORNIA Digital

Post Office Box 3097 B • Torrance, California 90503

California Digital STATIC • 64

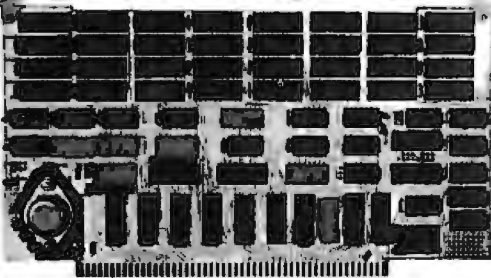

RELIABILITY OF STATIC ... PRICE OF DYNAMIC

Sixteen Bit Memory

\$595

February Price \$850
30% Price Reduction

Utilizing the new Hitachi 6167/2167 main chip, the Static 64 is the most current technology available in S-100 memory products. 24 bit extended addressing, 8 or 16 bit data paths along with 16 bit request and acknowledge make this unique board completely compatible with the IEEE 696 S-100 bus standard.

The Static 64 has been engineered to allow each 16K segment of memory to be bank selectable supporting multuser systems. Other selectable features allow the board to fully integrate with all current bank selecting schemes including Cromex and Alpha-Micro. Operates with all 16 bit computers including Seattle Computers, Tecmar and Lomas. Designed for DMA operations at clock frequencies in excess of 10 MHz. Standby power consumption less than one Amp.

To add to the total integrity of the product, each board is subjected to extensive high temperature burn-in and test procedures. CAL-6400



ZENITH \$119

GREEN PHOSPHOR MONITOR

The new Zenith ZVM-21 monitor features a P-31 green phosphor tube along with 15 MHz bandwidth.

Switch selectable for 40 and 80 character per line screen formats.

Accepts composite video and is fully compatible with 80 column Apple cards. VDM-21 20 lbs.



EPSON MX80

NEC PC-8023A

\$450

\$535

Epson MX80T friction/tr \$595.00
Epson MX100 132 column \$70.00
Creative 80 option \$129.00
Apple I/O & cable (8131) \$79.00
Serial Inter. '86 buf. (8151) \$145.00
Cable for TRS-80 \$35.00
IEEE 488 interface (8161) \$65.00
Replacement head \$1.00
Replacement Ribbon \$1.00
Paper 3500 sheets 9 1/2" \$35.00

Dot-matrix, bi-directional, logic-seeking, friction or tractor feed, impact printer. Complete graphics, upper and lower case ASCII, Greek, mathematics along with the ability to print dot graphic screen images directly onto paper.
Proportional spacing and 132 column compressed print make this low cost machine the best value in today's printer market.



PRINTRONIX P-300 \$4500

P-600 \$6150

PRINTERS

Epson MX80	PRINX80	\$475	NEC/Sellum 1	PRN5510ps	2695
Epson MX80T	PRINX80F	595	NEC/Sm 16K	PRN5510ps	2755
Epson MX100	PRINX100		TEC/Stawrtr.	PRV300	1395
Anadex 9500	PR49500	1295	Okidata 80	PRO80	419
Anadex 9501	PR49501	1295	Okidata 82	PRO82	919
Anacom 150	PR4150	1075	Okidata 83	PRO83	895
IDS Paper Tiger	PRC480C	1095	Teletype 43K	PTT4320K	1095
IDS Tiger 560	PRC580C	1350	Texas Ins. 810	PRT810B	1450
Diablo 830	PRD830	2150	Tex. Ins 810C	PRT810C	1795
Diablo 1650	PRD1650	2850	Centronics 730	PRT730P	529
Diablo 1840	PRD1840	2495	Centronics 737	PRT737P	885
Datsouth 180	PRD180	1350	Centronics 739	PRT739P	795
Printronix 300	PRP300	4500	Centrmx 704-9	PRC704-9	
Printronix 600	PRP600	6150	Centrmx.704-11	PRC704-11	

SYSTEMS



HEWLETT
PACKARD
HP 85 COMPUTER
BELOW OUR COST
\$2295

Apple
48K Memory
\$1150



IBM 3101 Display Terminal

IBM Direct Price \$1395
California Digital

discount price **\$1295**



AMPEX
DIALOGUE 80
REDUCED PRICE

\$795

New from the Amplex Corporation. The Dialogue 80 features removable keyboard, displayable two pages (four optional) dual program keys, half intensity protected fields and status line. Transmits data either block, line or character mode. Excellent value. VDT-080 shipping 47 lbs.

VIDEO TERMINALS

ADDS Viewpoint	VDT-RVP	595
ADDS Regent 25 numeric cluster	VDT-R25	850
ADDS Regent 30 25th status line	VDT-R30	950
ADDS Regent 40 limited graphics	VDT-R40	1195
ADDS Regent 60 Block mode	VDT-R60	1495
Amplex Dialogue 80 two page/detach	VDT-D80	
Digital Equipment VT-100	VDT-V100	1595
Digital Equipment VT-132	VDT-V132	1895
IBM 3101-10 character mode green	VDT-3101	1195
IBM 3101-20 block mode	VDT-31012	1395
Visual 200	VDT-V200	995
Televideo 910C (new)	VDT-T910	595
Televideo 912C	VDT-T912	665
Televideo 920C	VDT-T920	745
Televideo 950C detachable keybd.	VDT-T950	985
Zenith Z-19	VDT-Z-19	

VIDEO MONITORS

BMC KG-12C 20MHz	
P31 green phosphor	\$169
NEC gm. 1201	189
Zenith gm ZVM121	119
BMC color composit	339
Zenith color 13"	395
NEC RGB 1202DH	895

EPROM ERASER

Ultra Vilot Products
\$65
UVP-11E



ACCESSORIES FOR THE APPLE COMPUTER

CALIFORNIA COMPUTER SYSTEMS	
Arithmetic Processor 7811 B/C	\$318
Asynchronous serial interface 7710	129
Centronics interface card 7778	89
12K PROM Module 7114	89
Calendar/Clock. Bat. back-up 742-1	99
Parallel Interface 7700A	89
Programmable Timer 7740A	99
Analog/Digital converter 7470A	99
MICROSOFT PRODUCTS	
Apple to Z-80 CPU card	319
D.C. HAYES PRODUCTS	
Microprogram for Apple	319
COMPUTER STOP PRODUCTS	
Double Vision 180 Column Video	250
INTERACTIVE STRUCTURES	
16 Channel A/D card A102	275
MOUNTAIN COMPUTER PRODUCTS	
Intro X-10 system for BSR	\$239
Intro X-10 card only	165
16 channel A/D/D/A 8 bit	319
Apple Clock battery back-up	225
Supertaker SD300	245
ROM Plus with filter	165
ROM Writer/Programmer	119
APPLE BRAND PRODUCTS	
Apple Language card	\$59
Floppy disk with controller	\$59
Floppy disk without controller	\$49
Apple parallel interface	\$79
SSM MICROCOMPUTER	
Dual serial parallel interface A10	
SORRENTO VALLAY ASSOCIATES	
8" floppy controller (Pascal)	\$59

S-100 BOARDS

CPU BOARDS	
Calif. Computer 2810A Z-80	\$250
2 x 2 1MHz BUC-C2810	
Godbout -80 4 bit, 2MHz	239
BUC-CZ40	
Godbout 8082/8088 dual 16 bit	375
processor BUC-G88	
Measurement System S-2-80	395
4 serial 2 parallel real time	
clock, 8 vector BUC-N240	
SU Systems SBC-800 Z-80	385
with serial a parallel	
I/O ports BUC-SBC2	
Teletex PDC-1 single board	695
CPU & floppy disk controller	
plus I/O BUC-PDC1	
FLOPPY DISK CONTROLLER	
Calif. Computer 2125A with	329
2 serial/2 par I/O BUC-C252	
Godbout "Disk One" features the	
BUC-765 controller, DMA	399
arbitration BUC-G14	
Measurement Systems 765 chip,	
single & double density. Error	419
correction BUC-765	
SU Systems Versafloppy II	419
double density BUC-VF2	
1 1/2" BUC-VF2	419
3 1/2" BUC-VF2	419
3 1/2" BUC-VF2	419
single density BUC-UJ1	159
Norrow Design Disk Jockey I	159
double density BUC-DJ2	159
INTRFACE BOARDS	
Calif. Computer 2718 I/O	279
2 serial/2 par I/O BUC-C2718	
Norrow Design Switchboard	279
2 serial/4 par I/O BUC-SWB	279
Norrow Design Multiboard	279
2 serial/3P, 4 BUC-MB18	279
Godbout Interface One	199
2 serial/2 par I/O BUC-GE1	
Godbout Multiboard Two	149
1 serial/2 par I/O BUC-GB2	
SPECIALTY BOARDS	
GT Computer read time clock/	125
calculator BUC-GCK	
Artec Elec. Wire wrap proto-	25
type board BUC-AW	
Artec Elec. General Purpose	25
proto board BUC-AGP	
Godbout Spectrum color	25
board BUC-SGC	
D.C. Hayes S-100 Micro-	49
modem BUC-HMI	
Multi Products extender board	49
& logic probe kit BUC-MT101	
Multi Products Opto-com-	49
board kit BUC-AOC	

Rotron Muffin Fan

\$1477 \$12.00 @ 100
10.50 @ 1000
115 VAC. 7 Watts WR2A1
Factory fresh Muffin fans
NOT pull-outs. EMF-4M



All merchandise sold by California Digital is premium grade. Shipping: First five pounds \$2.00; each additional add \$1.40. Foreign orders 10% shipping. Excess will be refunded. California residents add 8% sales tax. COD's discouraged. Open accounts extended to state supported educational institutions and companies with a "Strong Dun & Bradstreet." Warehouse: 15808 Inglewood Blvd. Visitors by appointment.

TOLL FREE ORDER LINE
(800) 421-5041
TECHNICAL & CALIFORNIA
213 679-9001
TWX 910 325-6212

CALIFORNIA DIGITAL

Post Office Box 3097 B • Torrance, California 90503

DISKETTES

FREE PLASTIC LIBRARY CASE INCLUDED WITH THE PURCHASE OF EVERY BOX OF DISKETTES

\$24.95



Private labeled for California Digital by one of the most respected producers of magnetic media. Each diskette is certified double density at 40 tracks. To insure extended media life each diskette is manufactured with a reinforced substrate. And of course, a plastic library case is included with every box of diskettes. **MSD-21000 (10)** (Prices apply to computer or required sectors.) Ten boxes \$22.75 One hundred boxes \$21.50

5 1/4" DISKETTES WITH LIBRARY CASE

\$26.50

Your Choice
SCOTCH MEMOREX VERBATIM

	Soft Sector	10 Sector	16 Sector	
SCOTCH	744-0	744-10	744-16	\$26.50
MEMOREX	3401	3403	3405	26.50
VERBATIM	525-01	525-10	NA	26.50
DYSAN	104/1	107/1	NA	39.50

Single Side Double Density

DYSAN	104/1D	107/1D	NA	45.00
-------	--------	--------	----	-------

Double Side Double Density

SCOTCH	745-0	745-10	745-16	42.50
DYSAN	104/2D	107/2D	NA	49.50
DYSAN 96	204/2D	NA	NA	59.50

EIGHT INCH DISKETTES

Single Side Single Density		Single Side Double Density		
SCOTCH	740-0	29.50	SCOTCH 741-0	39.00
MEMOREX	3060	29.50	MEMOREX 3090	35.00
DYSAN	3740/1	39.50	DYSAN 3740/D	57.50

Thirty Two Sector

Thirty Two Sector		Double side Double Density		
SCOTCH	740-32	29.50	SCOTCH 743-0	47.50
MEMOREX	3114	39.50		
DYSAN	3740/2D	65.00		

PLEASE PHONE FOR VOLUME PRICING.



BSR SYSTEM X-10

The new BSR timer runs your home just like clockwork. Turns on lamps and appliances while you're away from home. Completely compatible with your existing systems 20-10 devices.

BSR Timer night channel \$63.00
Master control console 34.85
Ultraquiet Controller 18.95

Appliance Module 500 W. \$13.95
Lamp Module 300 Watts 13.95
NEW full control wall switch 14.50

WINCHESTER SUBSYSTEM

\$1250

Includes seven magnetic Winchester hard disk, dual enclosure and power supply. Floppy backup drive \$199.00 additional.

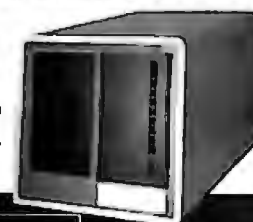

MEMORY

64K DYNAMIC \$9.95 4164 100-	16K STATIC \$13.95 2167 70ns.
16K DYNAMIC \$2.10 4116 100-1.85	2716 EPROM \$4.95 100-14.50 1K-14.00



2732 EPROM SALE \$7.95

STATIC

	ea.	32+	100+	1K+
21L02 1K	1.19	1.09	1.05	.99
2114 300ns.	2.95	2.75	2.50	1.99
4044-4 450ns.	4.50	4.19	4.00	3.75
4044-2 250ns.	4.95	4.65	4.50	4.25
6116 16k 24 pin	7.95	7.50	6.75	5.45
2167/6167 20 pin	11.95	10.75	9.65	9.25

EPROM

2708 450ns.	3.95	3.50	3.25	3.00
2716 5V.	4.95	4.00	3.75	3.30
2716 tri-volt	8.50	7.95	7.35	7.25
2732 Intel/P15ac.	7.95	7.50	7.00	6.65
2532 Texas Inst	12.95	11.50	10.00	9.50
2764 64K Epron	29.95	27.00	25.00	23.50



direct connect **MODEM** Your Choice **\$169**

Direct connect modems eliminate loss of information due to the carbon copy compression associated with acoustic modems. Choose either of these two great units.

The Universal Data Systems 1031 is a switch selectable between answer and originate modes. Fully Bell 103 compatible. Directly connects to the new modular telephone jack, 100% lowered from the telephone line. No need to locate modems in proximity to A.C. power receptacle. 3100-1031P 2 points.

Novation "M" Cat connects to most of the new "Bell" modular handsets. Ideal for multiple line office telephones. Requires external A.C. power. MOD-DCA 2 Lb.

SWITCHES

DIP SWITCHES			TOGGLE		ea. 100+
pos.	ea.	100+	1b+		
4	.98	.75	.69	7101 on/on	1.19 .98
7	.99	.83	.79	7103 on/off/on	1.39 1.39
6	1.85	.91	.87	7107 mt./on	1.39 1.19
12	1.19	.89	.91	7108 mt./on	1.39 1.19
				7205 up/down	1.85 1.65

CONNECTORS



GOLD EDGE CONNECTORS			"T" Type	
S-100 .125" centers	each	10+	DB9P male	each 10-34
insmt solder .200" row	\$2.95	\$2.30	DB9S female	2.25 2.00 1.00
insmt wire wrap (FD)	3.95	3.50	DB15P male	3.15 3.15 2.00
Sullins Hi-Hel. 250	4.50	4.00	DB15S female	3.25 3.00 2.00
Sullins Hi-Hel. W/W	5.35	4.00	DA head 2/P	1.60 1.35 1.30
Sullins/Altair .140"	4.95	4.50	DB25P male	3.50 3.35 2.25
.156" Centres (standard)	2.50	2.15	DB25S female	3.35 3.15 2.05
22/44 Kim Eyed.	5.05	5.00	DB hood 2/P	1.35 1.15 1.05
36/72 Digital Group S/T	5.05	5.00	DC37P male	-1.20 -1.00 3.70
36/72 Digital Group W/W	6.60	6.15	DC37S female	5.00 5.75 3.30
43/88 Motorola 88005/T	0.60	0.15	DC hood 2/P	2.25 2.00 1.75
43/88 Moto. 8800 W/W	7.00	6.85	DD50P male	5.50 5.10 4.15
			DD50S female	6.10 5.60 4.60
			DD50 hood 2/P	2.60 2.40 3.10

INTEGRATED CIRCUIT SOCKETS			CENTRONICS	
Low Profile	Wire Wrap	each 100+	57-3090A	7.00 6.75 5.75
14 pin	8.10	8.00		
16 pin	10.00	9.50		
18 pin	12.00	11.50		
24 pin	16.00	15.50		
40 pin	42.00	40.00		

MINI-CABLE CONNECTORS		
17/24 5' dia	4.65	4.15 3.95
20/28 TRS-90	3.65	3.05 4.70
23/20 5' dia	3.90	3.15 4.90



NEW OLIVETTI 801 \$295

		ONE	TWO	TEN
★ OLIVETTI 801	single	\$319	309	295
★ OLIVETTI 802/851	double	425	419	410
SHUGART 801/R	single	395	385	375
SHUGART 851/R	double	525	495	475
QUME DATA TRACK 8	double	525	495	475

★ The 8" Olivetti drives are approx. 1/2" wider than the Shugarts.

Five inch Disk Drives

OLIVETTI 501/400	single	199	185	175
OLIVETTI 502/451	double	235	225	215

Upon request, all drives are supplied with power connectors and one manual per order.

230 volt 50Hz. 8" add \$50.00 per drive.



\$995 Eight inch Subsystem

Two Olivetti 801 disk drives with power supply, 4" exhaust fan complete in dual enclosure with all necessary power cables. Documentation included. 50 Lbs. CAL-2801

Signal cable add \$35.00 WCA-6500

Same as above but with

Shugart 801R	MSD2801	\$1195	Olivetti 802	CAL2802	\$1250
Shugart 851R	MSD2851	1450	Qume DT8	MSD80T	1450

SPECIAL \$895



Seagate Compatible 7.5 MEGABYTE Winchester Hard Disk Drive

We have priced this so low that the manufacturer has asked not to use their brand name in our advertising. Industry standard Seagate compatible. Drive fits into the same space as a 5 1/4" floppy disk drive. CAL-561/2

S-100 MOTHER BOARD \$35

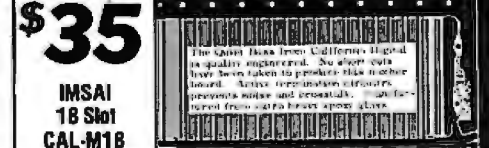

IMSAI 18 Slot CAL-M1B

TOLL FREE ORDER LINE
(800) 421-5041
TECHNICAL & CALIFORNIA
213 679-9001
TWX 910 325-6212

All merchandise sold by California Digital is premium grade. Shipping: First five pounds \$3.00; each additional add \$4.40 Foreign orders 10% shipping. Excess will be refunded. California residents add 8% sales tax. COD's discouraged. Open accounts extended to state supported educational institutions and companies with a "Strong Dun & Bradstreet." Warehouse: 15605 Inglewood Blvd. Visitors by appointment.

4116 16K DYNAMIC RAMS 250 NS 8/\$11⁹⁵ SET

ALL MERCHANDISE 100% GUARANTEED!

CALL US FOR VOLUME QUOTES

LINEAR

LM301	.34	LM350K	5.60	NE570	4.75		
LM301H	.79	LM350T	4.60	NE571	3.95		
LM307	.45	LM358	.98	NE592	2.75		
LM308	.98	LM359	1.79	LM703	.89		
LM308H	1.15	LM376	3.75	LM709	.59		
LM309H	1.95	LM377	2.29	LM710	.75		
LM309K	1.49	LM378	2.50	LM711	.79		
LM310	1.75	LM379	4.50	LM723	.49		
LM311	.64	LM380	1.29	LM723H	.55		
LM311H	.89	LM380N-8	1.10	LM733	.98		
LM312H	1.75	LM381	1.60	LM741N-8	.35		
LM317K	3.95	LM382	1.60	LM741N-14	.35		
LM317T	1.95	LM383	1.95	LM741H	.40		
LM318	1.49	LM384	1.95	LM747	.79		
LM318H	1.59	LM386	1.50	LM748	.59		
LM319H	1.25	LM387	1.40	LM1014	2.75		
LM319	1.25	LM389	1.35	LM1303	1.95		
LM320 (see 7900)	LM390	1.95	LM1304	1.19	LM3909	.98	
LM322	1.65	LM392	.69	LM1305	1.49	LM3911	2.25
LM323K	4.95	LM394H	3.60	LM1307	.85	LM3914	3.95
LM324	.59	LM399H	5.00	LM1310	2.90	LM3915	3.95
LM329	.69	NE531	3.75	MC1330	1.89	LM3916	3.95
LM331	3.95	NE536	6.00	MC1349	1.89	MC4024	3.95
LM334	1.30	NE555	.39	MC1350	1.29	MC4044	4.50
LM335	1.40	NE556	.69	MC1358	1.79	RC4136	1.25
LM336	1.75	NE558	1.50	LM1414	1.59	RC4151	3.95
LM337K	3.95	NE561	19.95	LM1458	.69	LM4250	1.75
LM337T	2.95	NE562	6.00	LM1488	.99	LM4500	3.25
LM338K	6.95	NE564	3.95	LM1489	.99	LM13080	1.29
LM339	.99	LM565	.99	LM1496	.85	LM13600	1.49
LM340 (see 7800)	LM566	1.49	LM1558H	3.10	LM13700	1.49	
LM348	1.20	LM587	1.29				

H = TO-5 CAN

BI FET EXAR

LM1800	2.99	TL071	.79	XR 2206	3.75
LM1812	8.25	TL072	1.19	XR 2207	3.85
LM1815	5.20	TL074	2.19	XR 2208	3.90
LM1818	2.90	TL081	.79	XR 2211	5.25
LM1820	3.50	TL082	1.19	XR 2240	3.25
LM1830	3.50	TL083	1.19		
LM1871	5.49	TL084	2.19		
LM1872	5.49	LF347	2.19		
LM1877	3.25	LF351	.60	CA 3010	.99
LM1889	2.49	LF353	1.00	CA 3013	2.00
LM1896	1.75	LF355	1.10	CA 3023	2.75
LM2877	2.05	LF356	1.10	CA 3035	2.49
LM2878	2.25	LF357	1.40	CA 3039	1.29
LM2900	.85			CA 3046	1.25
LM2901	1.00			CA 3053	1.45
LM3900	.59			CA 3059	2.90
LM3905	1.25	TL494	4.20	CA 3060	2.90
LM3909	1.19	TL496	1.65	CA 3065	1.75
LM3911	2.25	TL497	3.25	CA 3080	1.10
LM3914	3.95	75107	1.49	CA 3081	1.65
LM3915	3.95	75188	1.25	CA 3082	1.65
LM3916	3.95	75189	1.25	CA 3083	1.55
MC4024	3.95	75450	.59	CA 3086	.80
MC4044	4.50	75451	.39	CA 3089	2.99
RC4136	1.25	75452	.39	CA 3096	3.49
RC4151	3.95	75453	.39	CA 3130	1.30
LM4250	1.75	75454	.39	CA 3140	1.15
LM4500	3.25	75491	.79	CA 3146	1.85
LM13080	1.29	75492	.79	CA 3160	1.19
LM13600	1.49	75493	.89	CA 3401	.59
LM13700	1.49	75494	.89	CA 3600	3.45

TI

T = TO-220

RCA

K = TO-3

VOLTAGE REGULATORS

7805T	.89	7905T	.99
7800T	.89	7908T	.99
7812T	.89	7912T	.99
7815T	.89	7915T	.99
7824T	.89	7924T	.99
7805K	1.39	7905K	1.49
7812K	1.39	7912K	1.49
7815K	1.39	7915K	1.49
7824K	1.39	7924K	1.49
78L05	.69	79L05	.79
78L12	.69	79L12	.79
78L15	.69	79L15	.79
78H05K	9.95	LM323K	4.95
78H12K	9.95	UA78S40	1.95

T = TO-220 K = TO-3
L = TO-92

TRANSISTORS DIODES

PN2222	TO-92	10/1.00	100/8.99
PN2907	TO-92	10/1.25	100/10.99
2N2222	TO-18	.25	50/10.99
2N2907	TO-18	.25	50/10.99
2N3055	TO-3	.79	10/6.99
3055T	TO-220	.69	10/5.99
2N3904	TO-92	10/1.00	100/8.99
2N3906	TO-92	10/1.00	100/8.99
1N4148 (1N914)		25/1.00	1000/35.00
1N4004		10/1.00	100/8.99

AUGUST CPU SALE

8 BIT

Z-80 CPU 2MHZ	\$3 ⁹⁵	(10/ 3.75 EA)
6502 1MHZ	\$5 ⁹⁵	(10/ 5.75 EA)
6809 INT. CLOCK	\$12 ⁹⁵	(10/11.25 EA)

16 BIT

8086	\$29 ⁹⁵
68000 8MHZ	\$99 ⁹⁵

SALE ABSOLUTELY ENDS
AUGUST 31, 1982
YOU MUST STATE
"AUGUST CPU SALE"
WHEN ORDERING

ORDER TOLL FREE

800-538-5000

800-662-6279

(CALIFORNIA RESIDENTS)

IF YOU CAN FIND A PRICE LOWER ELSEWHERE. LET US KNOW AND WE'LL MEET OR BEAT THEIR PRICE! (SEE TERMS BELOW)

- * Computer managed inventory—virtually no back orders!
- * Very competitive prices!
- * Friendly staff!
- * Fast service — most orders shipped within 24 hours!

CABINET FOR 5 1/4" DISK DRIVE

- * COLOR MATCHES APPLE
- * FITS SHUGART

SPECIAL — \$29⁹⁵

THE MICROPROFESSOR

FROM MULTITECH \$149

Complete microprocessor training course — Teaches both hardware and machine language programming techniques — Includes Z80 computer!

- * Z80 based microcomputer with 36 key pad, 6 digit display, up to 4K on board RAM or 8K Eprom.
- * 140 page manual describes theory of operation and includes many experiments
- * Optional Eprom programmer and speech synthesizer boards available.

MICROCOMPUTER HARDWARE HANDBOOK

FROM ELCOMP — \$14.95

Over 800 pages of manufacturers data sheets on most commonly used IC's.

- Includes:
- * TTL — 74/74LS and 74F
 - * CMOS
 - * Voltage Regulators
 - * Memory — RAM, ROM, EPROM
 - * CPU's — 6800, 6500, Z80, 8080, 8085, 8086/8
 - * MPU support & interface — 6800, 6500, Z80, 8200, etc.

HOURS:
M-F, 9-5; Sat. 11-3
VISIT OUR
RETAIL STORE



JDR MICRODEVICES, INC.

1224 S. Bascom Avenue
San Jose, CA 95128
800-538-5000 • 800-662-6279 (CA)
(408) 995-5430 • Telex 171-110

PLEASE USE YOUR CUSTOMER NUMBER WHEN ORDERING
TERMS: For shipping include \$2 for UPS Ground or \$3 for UPS Blue Label Air. Items over 5 pounds require additional shipping charges. Foreign orders, include sufficient amount for shipping. There is a \$10 minimum order. Bay Area and Los Angeles Counties add 8% Sales Tax. Other California residents add 8% Sales Tax. We reserve the right to substitute manufacturer. Not responsible for typographical errors. Prices are subject to change without notice. We will match or beat any competitor's price, provided it is not below our cost.

APPLE* II COMPUTER USERS DISK DRIVE \$375⁰⁰

- ★ Includes metal cabinet
- ★ Color matches Apple
- ★ 35 Tracks/single side
- ★ Includes cable
- ★ Use with Apple II Controller

16K RAM CARD \$69⁹⁵

- ★ Upgrade your 48K Apple II to full 64K of RAM.
- ★ Fully software and hardware compatible with the Apple language card and microsoft Z80 card.
- ★ Eliminates the need for the Applesoft or Integer Basic ROM card when used in conjunction with DOS 3.3.
- ★ Allows you to run Apple Fortran or Pascal with no difficulty.
- ★ Available as bare board, kit, or assembled and tested board.

BARE PC CARD — \$28.00 KIT — \$59.95

COOLING FAN \$69⁹⁵

- ★ Easy installation.
- ★ No modification of Apple required.
- ★ Color matches Apple.
- ★ Switch on front controls fan, computer and monitor.
- ★ Ultra-quiet, reliable fan.
- ★ Completely eliminates problems caused by overheating.



*Apple is a trademark of APPLE COMPUTER, INC.

EPSON PRINTERS

MX-80
MX-80FT
MX-100

CALL FOR PRICE

WE HAVE APPLE AND TRS-80
INTERFACE CARDS AND CABLES

MONITORS

NEC JB-1201 M \$169⁰⁰
ZENITH ZVM-121 \$119⁹⁵

DISKETTES

5 1/4"

ATHANA SS SD SOFT 24.95
MEMOREX SS SD SOFT 26.95
VERBATIM SS SD SOFT 29.95
VERBATIM 10 SECTION HARD . . . 29.95

8"

VERBATIM SS SD SOFT 44.95

IBM* PERSONAL COMPUTER USERS

MEMORY EXPANSION CARD

- ★ 64K - 192K.
- ★ Full single-bit error correction circuitry (ECC) assures reliable memory.
- ★ Fully IBM hardware and software compatible.
- ★ Highest quality PC card.
- ★ Price includes: PC card, card guide, ECC ROM, and manual

BARE PC CARD \$120.00

DUAL SERIAL CARD WITH GAME ADAPTER

- ★ 2 Asynchronous RS232 Serial Ports.
- ★ Game adapter port.
- ★ Fully IBM compatible.
- ★ Replaces 2 IBM Asynchronous Communication Adapter cards.
- ★ Price includes: PC card, Prom, Mounting Bracket and Manual.

BARE PC CARD \$60.00

TM100-1 DISK DRIVE \$229⁰⁰

*IBM is a trademark of INTERNATIONAL BUSINESS MACHINES

HOURS:
M-F, 9-5; Sat. 11-3

VISIT OUR
RETAIL STORE



JDR MICRODEVICES, INC.

1224 S. Bascom Avenue
San Jose, CA 95128

800-538-5000 • 800-662-6279 (CA)
(408) 995-5430 • Telex 171-110

PLEASE USE YOUR CUSTOMER NUMBER WHEN ORDERING
TERMS: For shipping include \$2 for UPS Ground or \$3 for UPS Blue Label Air. Items over 5 pounds require additional shipping charges. Foreign orders, include sufficient amount for shipping. There is a \$10 minimum order. Bay Area and Los Angeles Counties add 6% Sales Tax. Other California residents add 6% Sales Tax. We reserve the right to substitute manufacturer. Not responsible for typographical errors. Prices are subject to change without notice. We will match or beat any competitor's price provided it is not below our cost.

4116 16K DYNAMIC 250NS **8/\$11⁹⁵** SET

2114 1KX4 STATIC LOW POWER 200NS **8/\$15⁹⁵** SET

ALL MERCHANDISE 100% GUARANTEED!

CALL US FOR VOLUME QUOTES

STATIC RAMS

Part No.	Capacity	Speed	Each	pcs
2101	256 x 4	(450ns)	1.95	1.85
5101	256 x 4 (cmos)	(450ns)	4.95	3.95
2102-1	1024 x 1	(450ns)	.89	.85
2102L-2	1024 x 1	(LP) (250ns)	1.69	1.55
2102L-4	1024 x 1	(LP) (450ns)	1.29	1.15
2111	256 x 4	(450ns)	2.99	2.49
2112	256 x 4	(450ns)	2.99	2.79
2114	1024 x 4	(450ns)	8/16.95	1.95
2114L-2	1024 x 4	(LP) (200ns)	8/15.95	1.90
2114L-3	1024 x 4	(LP) (300ns)	8/18.95	2.25
2114L-4	1024 x 4	(LP) (450ns)	8/17.95	2.10
2147	4096 x 1	(55ns)	9.95	call
TMS4044-4	4096 x 1	(450ns)	3.49	3.25
TMS4044-3	4096 x 1	(300ns)	3.99	3.75
TMS4044-2	4096 x 1	(200ns)	4.49	4.25
MK4118	1024 x 8	(250ns)	9.95	call
TMM2016-200	2048 x 8	(200ns)	call	call
TMM2016-150	2048 x 8	(150ns)	call	call
HM6116-4	2048 x 8 (cmos)	(200ns)	call	call
HM6116-3	2048 x 8 (cmos)	(150ns)	call	call
HM6116-2	2048 x 8 (cmos)	(120ns)	call	call
HM6116LP-4	2048 x 8 (LP)(cmos)	(200ns)	call	call
HM6116LP-3	2048 x 8 (LP)(cmos)	(150ns)	call	call
HM6116LP-2	2048 x 8 (LP)(cmos)	(120ns)	call	call
Z-6132	4096 x 8	(Qstat)(300ns)	34.95	call

LP = Low Power Qstat = Quasi-Static

Z-80
2.5 Mhz

Z80-CPU	3.95
Z80-CTC	5.95
Z80-DART	15.25
Z80-DMA	17.50
Z80-PIO	5.75
Z80-SIO/0	18.50
Z80-SIO/1	18.50
Z80-SIO/2	18.50
Z80-SIO/9	16.95

4.0 Mhz

Z80A-CPU	6.00
Z80A-CTC	8.65
Z80A-DART	18.75
Z80A-DMA	27.50
Z80A-PIO	6.00
Z80A-SIO/0	22.50
Z80A-SIO/1	22.50
Z80A-SIO/2	22.50
Z80A-SIO/9	19.95

6.0 Mhz

Z80B-CPU	17.95
Z80B-CTC	15.50
Z80B-PIO	15.50

ZILOG

Z6132	34.95
Z8671	39.95

8200

8202	34.95
8205	3.50
8212	1.85
8214	3.85
8216	1.80
8224	2.50
8226	1.80
8228	4.90
8237	19.95
8238	4.85
8243	4.45
8250	14.95
8251	4.75
8253	9.25
8253-5	9.85
8255	4.75
8255-5	5.25
8257	8.50
8257-5	8.95
8259	6.90
8259-5	7.50
8272	39.95
8275	29.95
8279	9.50
8279-5	10.00
8282	8.85
8283	6.65
8284	5.70
8286	6.65
8287	6.50
8288	25.00
8289	49.95

8000

8035	7.25
8039	7.95
INS-8060	17.95
INS-8073	29.95
8080	3.95
8085	7.95
8085A-2	11.95
8086	29.95
8088	39.95
8089	69.95
8155	7.95
8156	8.95
8185	29.95
8185-2	39.95
8741	39.95
8748	29.95
8755	32.00

6800

68000	99.95
6800	4.95
6802	10.95
6808	13.90
6809E	19.95
6809	12.95
6810	2.95
6820	4.95
6821	4.95
6828	14.95
6840	12.95
6843	34.95
6844	25.95
6845	16.95
6847	12.25
6850	3.45
6852	5.75
6860	10.95
6862	11.95
6875	6.95
6880	2.95
6883	24.95
68047	24.95
68488	19.95

6800 = 1MHZ

68B00	10.95
68B02	22.25
68B09E	29.95
68B09	29.95
68B10	7.95
68B21	12.95
68B45	35.95
68B50	12.95

6800 = 2 MHZ

DYNAMIC RAMS

Part No.	Capacity	Speed	Each	pcs
TMS4027	4096 x 1	(250ns)	2.50	2.00
MK4108	8192 x 1	(200ns)	1.95	call
MMS298	8192 x 1	(250ns)	1.85	call
4116-120	16384 x 1	(120ns)	8/29.95	call
4116-150	16384 x 1	(150ns)	8/18.95	1.95
4116-200	16384 x 1	(200ns)	8/13.95	call
4116-250	16384 x 1	(250ns)	8/11.95	call
4116-300	16384 x 1	(300ns)	8/13.80	call
2118	16384 x 1	(5v) (150ns)	4.95	call
MK4616	2048 x 8	(5v) (300ns)	24.95	call
4164-200	65536 x 1	(5v) (200ns)	call	call
4164-150	65536 x 1	(5v) (150ns)	call	call

ORDER TOLL FREE
800-538-5000
800-662-6279
(CALIFORNIA RESIDENTS)

IF YOU CAN FIND A PRICE LOWER ELSEWHERE. LET US KNOW AND WE'LL MEET OR BEAT THEIR PRICE!
(SEE TERMS BELOW)

- * Computer managed inventory—virtually no back orders!
- * Very competitive prices!
- * Friendly staff!
- * Fast service — most orders shipped within 24 hours!

AUGUST SPECIALS

SA-400L (NEW)	199.95		
1771	20.95	MMS8187	8.95
1791	29.95	MSM5832	6.95
1793	38.95	32.768 CRYSTAL	1.95

68000-8MHZ 99.95

SMALL BYPASS CAPS	TV BUILDERS
.01uf DISC . . . 100/ 6.00	MC1330 . . 1.49
.1uf DISC . . . 100/ 8.00	MC1350 . . 1.19
.1uf MONO . . . 100/15.00	MC1358 . . 1.39
	LM1800 . . 1.99

Prices Good for the Month of August Only!

DISC CONTROLLERS

1771	20.95
1791	29.95
1793	39.95
1795	54.95
1797	54.95
6843	34.95
8272	39.95
UPD765	39.95
1681	18.95
2143	18.95

INTERFACE

8T26	1.89
8T28	2.49
8T95	.99
8T96	.99
8T97	.99
8T98	.99
DM8131	2.95
DP8304	2.29

MISC.

3341	4.85
76477	3.95
AY3-8910	12.85
MC3340	1.49
95H90	7.99
11C90	13.95
8202A	34.95
3242	7.95
MC3480	9.00
8038	3.85
2513-001 UP	9.95
2513-002 LOW	9.95
3205	3.50

BIT-RATE GENERATORS

14411	11.95
BR1941	11.95
4702	12.95
COM5016	16.95
MMS307	10.95

UARTS

AY3-1014	6.95
AY5-1013	3.95
PT1472	9.95
TR1602	3.95
2350	9.95
TMS6011	5.95
IM6402	7.95
IM6403	8.95
INS8250	14.95

KEYBOARD CHIPS

AY5-2376	11.85
AY5-3600	11.95
74C922	5.25
74C923	5.50

CLOCK CIRCUITS

MMS314	4.95
MMS389	3.95
MMS375	4.85
MMS8187	8.95
MMS8174	11.95
MMS8932	6.95

6500
1 MHZ

6502	5.95
6504	6.95
6505	8.95
6507	9.95
6520	4.35
6522	6.75
6532	11.25
6545	22.50
6551	11.85

2 MHZ

6502A	9.95
6522A	11.70
6532A	12.40
6545A	28.50
6551A	12.95

3 MHZ

6502B	14.95
-------	-------

CRYSTALS

32.768 khz	1.95
1.0 mhz	4.95
1.8432	4.95
2.0	3.95
2.097152	3.95
2.4576	3.95
3.2768	3.95
3.579535	3.95
4.0	3.95
5.0	3.95
5.0688	3.95
5.185	3.95
5.7143	3.95
6.0	3.95
6.144	3.95
6.5536	3.95
8.0	3.95
10.0	3.95
14.31818	3.95
15.0	3.95
16.0	3.95
18.0	3.95
18.432	3.95
20.0	3.95
22.1184	3.95
32.0	3.95

HOURS:
M-F, 9-5; Sat. 11-3

VISIT OUR
RETAIL STORE



JDR MICRODEVICES, INC.

1224 S. Bascom Avenue
San Jose, CA 95128

800-538-5000 • 800-662-6279 (CA)
(408) 995-5430 • Telex 171-110

PLEASE USE YOUR CUSTOMER NUMBER WHEN ORDERING
TERMS: For shipping include \$2 for UPS Ground or \$3 for UPS Blue Label Air. Items over 5 pounds require additional shipping charges. Foreign orders, include sufficient amount for shipping. There is a \$10 minimum order. Bay Area and Los Angeles Counties add 6% Sales Tax. Other California residents add 6% Sales Tax. We reserve the right to substitute manufacturer. Not responsible for typographical errors. Prices are subject to change without notice. We will match or beat any competitor's price provided it is not below our cost.

2716 16K EPROMS **8/\$3.95** EACH

2732 32K EPROMS **8/\$7.95** EACH

ALL MERCHANDISE 100% GUARANTEED!

CALL US FOR VOLUME QUOTES

74LS00

74LS00	.25	74LS85	1.15	74LS168	1.75	74LS295	1.05
74LS01	.25	74LS86	.40	74LS169	1.75	74LS298	1.20
74LS02	.25	74LS90	.65	74LS170	1.75	74LS324	1.75
74LS03	.25	74LS91	.89	74LS173	.80	74LS352	1.55
74LS04	.25	74LS92	.70	74LS174	.95	74LS353	1.55
74LS05	.25	74LS93	.65	74LS175	.95	74LS363	1.35
74LS08	.35	74LS95	.85	74LS181	2.15	74LS364	1.95
74LS09	.35	74LS96	.95	74LS189	9.95	74LS365	.95
74LS10	.25	74LS107	.40	74LS190	1.00	74LS366	.95
74LS11	.35	74LS109	.40	74LS191	1.00	74LS367	.70
74LS12	.35	74LS112	.45	74LS192	.85	74LS368	.70
74LS13	.45	74LS113	.45	74LS193	.95	74LS373	1.75
74LS14	1.00	74LS114	.50	74LS194	1.00	74LS374	1.75
74LS15	.35	74LS122	.45	74LS195	.95	74LS377	1.45
74LS20	.25	74LS123	.95	74LS196	.85	74LS378	1.18
74LS21	.35	74LS124	2.99	74LS197	.85	74LS379	1.35
74LS22	.25	74LS125	.95	74LS221	1.20	74LS385	1.90
74LS26	.35	74LS126	.85	74LS240	1.29	74LS386	.65
74LS27	.35	74LS132	.75	74LS241	1.29	74LS390	1.90
74LS28	.35	74LS136	.55	74LS242	1.85	74LS393	1.90
74LS30	.25	74LS137	.99	74LS243	1.85	74LS395	1.65
74LS32	.35	74LS138	.75	74LS244	1.29	74LS399	1.70
74LS33	.55	74LS139	.75	74LS245	1.90	74LS424	2.95
74LS37	.55	74LS145	1.20	74LS247	.75	74LS447	.37
74LS38	.35	74LS147	2.49	74LS248	1.25	74LS490	1.95
74LS40	.35	74LS148	1.35	74LS249	.99	74LS624	3.99
74LS42	.55	74LS151	.75	74LS251	1.30	74LS668	1.69
74LS47	.75	74LS153	.75	74LS253	.85	74LS669	1.69
74LS48	.75	74LS154	2.35	74LS257	.85	74LS670	2.20
74LS49	.75	74LS155	1.15	74LS258	.85	74LS674	9.65
74LS51	.25	74LS156	.95	74LS259	2.85	74LS682	3.20
74LS54	.35	74LS157	.75	74LS260	.65	74LS683	2.30
74LS55	.35	74LS158	.75	74LS266	.55	74LS684	2.40
74LS63	1.25	74LS160	.90	74LS273	1.65	74LS685	2.40
74LS73	.40	74LS161	.95	74LS275	3.35	74LS688	2.40
74LS74	.45	74LS162	.95	74LS279	.55	74LS689	2.40
74LS75	.50	74LS163	.95	74LS280	1.98	74LS783	24.95
74LS76	.40	74LS164	.95	74LS283	1.00	81LS95	1.69
74LS78	.50	74LS165	.95	74LS290	1.25	81LS96	1.69
74LS83	.75	74LS166	2.40	74LS293	1.85	81LS97	1.69
						81LS98	1.69

74S00

74S00	.44	74S85	2.39	74S169	5.44	74S274	19.95
74S02	.48	74S86	1.44	74S174	1.09	74S275	19.95
74S03	.48	74S112	1.59	74S175	1.09	74S280	2.90
74S04	.79	74S113	1.98	74S181	4.47	74S287	4.75
74S05	.79	74S114	1.50	74S182	2.95	74S288	4.45
74S08	.48	74S124	2.77	74S188	3.95	74S289	6.98
74S09	.98	74S132	1.24	74S189	14.95	74S301	6.95
74S10	.69	74S133	.98	74S194	2.95	74S373	3.45
74S11	.88	74S134	.69	74S195	1.89	74S374	3.45
74S15	.70	74S135	1.48	74S196	4.80	74S381	7.95
74S20	.68	74S138	1.08	74S197	4.25	74S387	5.75
74S22	.98	74S139	1.25	74S201	14.95	74S412	2.98
74S30	.48	74S140	1.45	74S225	8.95	74S471	9.95
74S32	.98	74S151	1.19	74S240	3.98	74S472	16.85
74S37	1.87	74S153	1.19	74S241	3.75	74S474	17.85
74S38	1.68	74S157	1.19	74S244	3.98	74S482	15.60
74S40	.44	74S158	1.45	74S251	1.90	74S570	7.80
74S51	.78	74S161	2.85	74S253	7.45	74S571	7.80
74S64	.79	74S162	3.70	74S257	1.39		
74S65	1.25	74S163	3.75	74S258	1.49		
74S74	.69	74S168	4.65	74S260	1.83		

LED DISPLAYS

HP 5082-7760	.8"	CC	1.29
MAN 72	.3"	CA	.99
MAN 74	.3"	CC	.99
FND-357 (359)	.375"	CC	.75
FND-500 (503)	.5"	CC	.99
FND-507 (510)	.5"	CA	.99

LED LAMPS

		1-99	100-up
Jumbo	Red	.10	.09
Jumbo	Green	.16	.15
Jumbo	Yellow	.18	.15

IC SOCKETS

8 pin ST	.13	1.00
14 pin ST	.15	.12
16 pin ST	.17	.13
18 pin ST	.20	.18
20 pin ST	.29	.27
22 pin ST	.30	.27
24 pin ST	.30	.27
28 pin ST	.40	.32
40 pin ST	.49	.39
ST = SOLDERTAIL		
8 pin WW	.59	.49
14 pin WW	.69	.52
16 pin WW	.69	.58
18 pin WW	.99	.80
20 pin WW	1.09	.98
22 pin WW	1.39	1.28
24 pin WW	1.49	1.35
28 pin WW	1.69	1.49
40 pin WW	1.99	1.80
WW = WIREWRAP		
16 pin ZIF	6.75	call
24 pin ZIF	9.95	call
ZIF = TEXTTOOL (Zero Insertion Force)		

7400

7400	.19	74136	.50
7401	.19	74141	.65
7402	.19	74142	2.95
7403	.19	74143	2.95
7404	.19	74145	.60
7405	.25	74147	1.75
7406	.29	74148	1.20
7407	.29	74150	1.35
7408	.24	74151	.65
7409	.19	74152	.65
7410	.19	74153	.55
7411	.25	74154	1.40
7412	.30	74155	.75
7413	.35	74156	.65
7414	.55	74157	.55
7416	.25	74159	1.65
7417	.25	74160	.85
7420	.19	74161	.70
7421	.35	74162	.85
7422	.29	74163	.85
7423	.29	74164	.85
7425	.29	74165	.85
7426	.29	74166	1.00
7427	.29	74167	2.95
7428	.45	74170	1.65
7430	.19	74172	5.95
7432	.29	74173	.75
7433	.45	74174	.89
7437	.29	74175	.89
7438	.29	74176	.89
7440	.19	74177	.75
7442	.49	74178	1.15
7443	.65	74179	1.75
7444	.69	74180	.75
7445	.69	74181	2.25
7446	.59	74182	.75
7447	.69	74184	2.00
7448	.69	74185	2.00
7450	.19	74132	.45
7451	.23	74190	1.15
7453	.23	74191	1.15
7454	.23	74192	.79
7460	.23	74193	.79
7470	.35	74194	.85
7472	.29	74195	.85
7473	.34	74196	.79
7474	.35	74197	.75
7475	.49	74198	1.35
7476	.35	74199	1.35
7480	.59	74221	1.35
7481	1.10	74246	1.35
7482	.95	74247	1.25
7483	.50	74248	1.85
7485	.65	74249	1.95
7486	.35	74251	.75
7489	4.95	74259	2.25
7490	.35	74265	1.35
7491	.40	74273	1.95
7492	.50	74276	1.25
7493	.49	74279	.75
7494	.65	74283	2.00
7495	.55	74284	3.75
7496	.70	74285	3.75
7497	2.75	74290	.95
74100	1.00	74293	.75
74107	.30	74298	.85
74109	.45	74351	2.25
74110	.45	74365	.65
74111	.55	74366	.65
74116	1.55	74367	.65
74120	1.20	74368	.65
74121	.29	74376	2.20
74122	.45	74390	1.75
74123	.55	74393	1.35
74125	.45	74425	3.15
74126	.45	74426	.85
74128	.55	74490	2.55

CONNECTORS

RS232 MALE	3.25
RS232 FEMALE	3.75
RS232 FEMALE	
RIGHT ANGLE	5.25
RS232 HOOD	1.25
S-100 ST	3.85
S-100 WW	4.95

DIP SWITCHES

4 POSITION	.85
5 POSITION	.90
6 POSITION	.90
7 POSITION	.95
8 POSITION	.95

9000 SERIES

9316	1.00
9334	2.50
9368	3.95
9401	9.95
9601	.75
9602	1.50
96502	1.95

DATA ACQUISITION

ADC0800	15.55
ADC0804	4.95
ADC0809	5.25
ADC0817	10.95
DAC0800	4.95
DAC0806	4.95
DAC1020	8.25
DAC1022	8.25
MC1408L8	4.95

INTERSIL

ICL7103	9.50
ICL7106	9.95
ICL7107	12.95
ICL8038	3.95
ICM7107A	5.59
ICM7208	15.95

FUNCTION GENERATORS

MC4024 Dual VCO	3.95
LM568 Function Gen.	1.49
XR2206 Function Gen.	3.75
8038 Waveform Gen.	3.95

CMOS

4000	.35	4528	1.25
4001	.35	4531	.95
4002	.25	4532	1.95
4006	.95	4538	1.85
4007	.29	4539	1.95
4008	.95	4543	2.70
4009	.45	4555	.95
4010	.45	4556	.95
4011	.35	4581	1.95
4012	.25	4582	1.95
4013	.45	4584	.95
4014	.95	4585	.95
4015	.95	4702	12.95
4016	.45	74C00	.35
4017	1.15	74C02	.35
4018	.95	74C04	.35
4019	.45	74C08	.35
4020	.95	74C10	.35
4021	.95	74C14	1.50
4022	1.15	74C20	.35
4023	.35	74C30	.35
4024	.75	74C32	.50
4025	.35	74C42	1.75
4026	1.65	74C48	1.20
4027	.65	74C73	.65
4028	.80	74C74	.85
4029	.95	74C76	.80
4030	.45	74C83	1.85
4034	2.95	74C85	1.95
4035	.85	74C86	.95
4040	.95	74C89	4.50
4041	1.		



PALOMAR

...Join the thousands



EPSON

Feature disposable print heads, Graphtrax. All models print text in two directions. MX80F/T and MX-100 have both friction and tractor feed. Unparalleled dot placement accuracy. All print 80 CPS.

- MX-80 (80 col.) CALL
- MX-80 F/T (80 col.) CALL
- MX-100 (136 col.) CALL
- Interface Cards CALL
- Cables CALL

C. ITOH Pro-Writer

Offers 8 character sizes, 5 different alphabets proportional spacing, bidirectional, vert and horiz. tabs, high resolution graphics, nx5 matrix, 100 CPS 136, col. max. Friction and tractor feed.

- 8510 Serial \$645.
- 8510 Parallel 495.

HUGE SAVINGS!

NOVELL

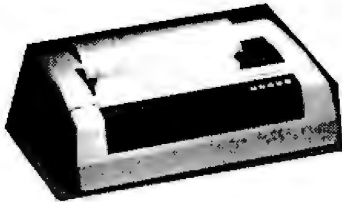

Heavy duty, 9x9 dot matrix printer. 150 CPS, bidirectional tractor feed. 6 or 8 lines per inch. Serial or parallel interface. 80, 136, 224 col. To 15" wide. 12 different printing modes. 11 VFU channels for forms flexibility. Front or bottom feed. Hurry! Priced to sell quickly.

- IMAGE 800 \$995.

NEC 8023-A Matrix

High resolution dot graphics. Proportional spacing. Correspondent quality printing. Bidirectional tractor and friction feed. 80, 136 col. Greek and math symbols, 100 CPS matrix printer.

- 8023A Parallel List \$ 780 \$499.

Just Arrived!

COMRITER CR-1 Daisy Wheel

Typewriter quality printing for your word processing computer system. Wide 16.5" paper width, serial or parallel interface. Full control panel MTBF 2,500 hours. Designed with few mechanical parts so high reliability. 17 CPS, 10, 12 and 15 CPI. Bidirectional 132, 158, 198 col. Incredibly low priced.

- CR-1-C List \$ 1195 CALL

OLYMPIA Daisy Wheel



Letter quality typewriter interfaces to Apple Atari, NEC, TRS80 and RS232 Serial ports 17.5 CPS., 10, 12 CPI.

- ES 100KRO Computer printer
List \$ 1690 SAVE \$400
- ES 100 Typewriter Only
List \$ 1195 SAVE \$ 200
- Interface Card only \$ 250
(specify serial or parallel)
- I/O Cable (specify serial or parallel) 25
- Apple Serial Card 139

SMITH-CORONA TP-1 Daisy Wheel

Letter quality price breakthrough! Serial or parallel data interface, 12 CPS, 10 or 12 CPI. Smith-Corona TP-1 List \$ 895 CALL

NEC Spinwriters

Letter quality printers: 7700 serial print 55 CPS, 3500 series print 33 CPS. Both series offer up to 128 char., take paper up to 16 in wide. 7700 series: 136 col. at 10 CPI, 163 col. at 12 CPI. Same for 3500 series plus 204 col. at 15 CPI.

- 7710/7730 RO w/tractor \$2475.
- 7720 KSR w/tractor 2850.
- 3510/3530 RO 1695.
- Bidirectional tractor 200.
- Push tractor 350.



MPI 88G/99G/150G

High resolution dot-addressable graphics for Apple. Enhanced "correspondence quality" printing. Tractor and friction feed. Serial and parallel input. Bidirectional printing. 88G, 99G have 10, 12, 16.5 CPI. 150G has 10, 12 17 CPI. 88G: 100 CPS, 80, 96, 132 col. 99G: 100 CPS, 80, 96, 136 col. 150G: 150 CPS, 136, 163, 226 col., 16" wide.

- 88G List \$ 749 \$519.
- 99G List \$ 849 569.
- 150G List \$ 1095 995.
- Apple parallel I/O Card/Cable/Disk
with Graphics Prom (Ap-Pak) 145.
- IEEE I/O Card 55.
- Single Sheet Feeder 25.
- QT Cover 30.

OKIDATA

Microline 82A—80/132 col., 120 CPS, 9x9 dot matrix, friction, pin feed or tractor feed (optional) rear and bottom feed. Includes bi-directional/logic seeking and serial parallel or IEEE interfaces. Double width and condensed characters, true lowercase descenders and graphics.

- 82A \$519

Microline 83A—132/232 col., 120 CPS, handles forms up to 15 inc. wide, plus all the features of the 82A.

- 83A \$745.

Microline 84SP—132/232 col., 200 CPS with full dot graphics built-in. Takes forms up to 15 in. wide, plus all the features of the 83A.

- 84SP \$1150.

C. ITOH F10 Daisy Wheel

Letter quality printer. Friction feed or bidirectional tractor. 40 or 55 CPS. 136, 163 and variable col.

- F10 List \$ 1795 CALL

ADLER Printer Typewriter

11 or 17.5 CPS, 10, 12, 15 CPI and proportional spacing. 2 line correcting memory, interchangeable print wheels.

- SE 1010 List \$1295 \$995.
- Interface Card ADD 350.



PALOMAR

Computer Products

WRITE OR CALL (714) 744-7314
910-105 W. San Marcos Blvd., Dept. 8B, San Marcos, CA 92069

OUT OF MAIL ORDER BUYING

from us with confidence and know you'll receive the same guaranteed satisfaction — at **UNBEATABLE PRICES!**



APPLE AND ACCESSORIES

Apple II Plus & 48K ... CALL	A-D Card ... \$99.
Disk II w/control, DOS 3.3 ... CALL	ROM Plus ... 129.
Disk Add-On ... CALL	CP5 Multifunction Card 179.
Z80 Softcard ... \$259.	Paymar L/C Adapt ... 35/45.
16K RAMcard ... 109.	Videx Videoterm ... 299.
Par. Printer Card ... 89.	Dana Fan ... 399.
Serial Card ... 109.	TC Game Paddles ... 32.
Clock Calendar Card ... 99.	TC Joy Stick ... 47.
IEEE Card ... 249.	Select A Port ... 47.

APPLE SOFTWARE

BUSINESS	MISC.
Financial Partner ... \$191.	Applesoft Compiler ... \$144.
Pascal Tutor ... 97.	Basic Computer ... 27.
Pro Easy Writer ... 137.	Apple-Doc ... 41.
Easy Writer 40 col. ... 78.	D.B. Master ... 189.
Word Star (Req. SC) ... 241.	D.B. Utility Pack ... 81.
SuperSort (Req. SC) ... 129.	
Mail Merger ... 80.	GAMES
Data Star (Req. SC) ... 192.	Raster Blaster ... \$24.
Spell Star (Req. SC) ... 129.	Air Traffic Controller ... 9.
Calc Star (Req. SC) ... 129.	Temple of Apschal ... 31.
Super Text II ... 117.	Datestones of Ryn ... 15.
The Address Book ... 38.	Morloc's Tower ... 15.
Form Letter Module ... 78.	Rescue at Rigel ... 23.
VisiFile ... 229.	Hell Fire Warrior ... 31.
Desktop Plan III ... 275.	Star Warrior ... 31.
Desktop Plan II ... 229.	Crash, Crumble & Chomp 23.
Visiplot ... 185.	Upper Reaches of Apschal 15.
Visitrend/Visiplot ... 275.	The Keys to Acheron ... 15.
Visidex ... 289.	Snack Attack ... 23.
Visitem ... 229.	The Prisoner ... 23.
Infotory ... 198.	Zonk I ... 31.
Superspell (Req. SC) ... 435.	Zonk II ... 31.
WordProcessor(Req. SC) 255.	Robot Wars ... 31.
PERSONAL/HOME	Three Mile Island ... 31.
Typing Tutor ... \$19.	A.B.M. ... 19.
Elementary Math ... 31.	Castle Wolfenstein ... 23.
Personal Filing System ... 74.	Wizard and Princes ... 25.
Personal Report System ... 74.	Missile Defense ... 23.
Algebra I ... 31.	Cranston Manor ... 27.
Compu-Math: Arith. Skill II ... 39.	Warp Destroyer ... 23.
Compu-Math: Fractions ... 31.	Cyber Strike ... 31.
Compu-Math: Decimals ... 31.	Phantoms Five ... 23.
Compu-Speaks (Req. Data Disk) ... 23.	Space Eggs ... 23.

ATARI SOFTWARE

Adventure #1,2,3(D) ... \$32.	Compu-Math/Frac.(D) ... 32.
Adventure #4,5,6(D) ... 32.	Compu-Math/Frac.(C) ... 24.
Adventure #7,8,9(D) ... 32.	Compu-Math/Dec.(D) ... 32.
Adventure #10,11,12(D) 32.	Compu-Math/Dec.(C) ... 24.
Atari Mailing List(D) ... 19.	Letter Perfect(D) ... 119.
Text Wizard ... 79.	Mail Merger/Utility(D) ... 24.

Better Than Grappler!

APPLE GRAPHICS CARD



- Dump Screen 1 or 2
 - Double size • Emphasize
 - Inverse or normal • Rotate
 - Set left margin or center image.
- This improved intelligent printer interface card enables you to print either of the Apple's h-res. screens with just a few keystrokes. Compatible with Epson, Nec, C. Itoh, Anadex, Centronics, Okidata, IDS, 15 commands.
- Genie Interface Card ... CALL

MODEMS

BIZCOMP

Superlow introductory price. Save over other modems! Apple-direct connect via game port. No serial card needed. Save \$139 or more. Apple package includes software on disk. Atari-direct connect via interface module and telelink cartridge. Each pkg. contains cable with connectors and phone T-adaptor.

Apple Comm Pkg ... \$99.
VIC Comm Pkg ... 99.
Atari Comm Pkg ... 99.

UDS, HAYES NOVIATION CAT

UDS 103 LP, direct ... \$169.
103 JLP Auto Answer ... 209.
202 LP 1200 BAUD ... 259.
NOVIATION CAT, acoustic ... 145.
D-Cat, direct ... 155.
Auto Cat ... 219.
Apple Cat ... 275.
HAYES S100 Micromodem ... 349.
Apple Micromodem ... 299.
Smart Modem ... 245.

ANCHOR

Automation	only
Signalman Mark 1	\$99.
RS232 300 BAUD, Bell 103 compatible, Automatic selection of originate or answer modes.	
Signalman Mark 1	\$99.

RIBBONS

NEC ... \$77/Doz.
Gume ... 45/Doz.
Diablo ... 66/Doz.
Anadex ... 135/6 ea.
Tritel ... 95/Doz.
TI/DEC/TTY ... 45/Doz.
Epson 80/FT ... 12.99
MPI/Axdom/Base 2 ... 13.95/ea.

NEC PC-8000 Series Microcomputer



- Z-80A CPU 4 MHz
 - 5 user programmable function keys
 - 82 keys with numeric keypad
 - 160 x 100 resolution
 - 80 character screen
- PC-800 1A Microcomputer w/32K RAM ... \$750.
- PC-8012A I/O Unit with 32K RAM Expansion slots ... 480.
- PC-8031A Dual Mini-Disk Drive Unit ... 750.

CENTRONICS AND OSBORNE CABLES

Centronics to Osborne 6 ft. ... \$30.
Centronics to Centronics 6 ft. ... 30.

RS232 CABLES

4 wire male-male 10 ft. ... \$25.
9 wire male-male 10 ft. ... 30.
4 wire male-female 10 ft. ... 25.
9 wire male-female 10 ft. ... 30.

RS-232 SWITCH BOX

RS232 Switch Box (Use 2 terminals or printers from one output port) ... 109.
--

VIDEO TERMS, MONITORS

Ampex Dialog 80 ... \$995.
Ampex Dialog 30 ... 795.
Televideo 920C ... 845.
Televideo 950 ... 995.
SOROC IQ 120 ... 499.
Zenith 12" Green ... 119.
NEC 12" Green ... 169.

SAVE \$100s

COMREX Video Monitors

CR-5500—Monochrome Display Monitor—12" green screen, 80 char. wide x 24 rows. CR-5500 List \$179. ... CALL

CR-6500 Color Display Monitor—13" in-line color. Hi-Resolution 260H x 300V. CR-6500 List \$445. ... CALL

CR-6600 Color Display Monitor—13" in-line color with RGB signal for higher resolution graphics. 380H x 240V. CR-6600 List \$619. ... CALL

FAN FOLD PAPER

(Prices F.O.B. S.P.)

9 1/2 x 11-20# Bond White (2700 ct.) ... \$29.
14 1/2 x 11-20# Bond White (2400 ct.) ... 37.
14 1/2 x 11-20# Bond 1/2" Green Bar (2400 ct.) ... 37.

TERMS OF SALE: Cash, check, money order, bank wire transfer, credit card or purchase orders from qualified firms, and institutions. Please include telephone number with order and expiration date on credit card orders. California residents add 6% sales tax. Advertised prices are for prepaid orders. F.O.B. shipping point. Add 3% for shipping in U.S. Pricing and availability subject to change without notice.

WE CARRY LOTS MORE THAN LISTED HERE! INQUIRIES WELCOME.

PALOMAR
Computer Products



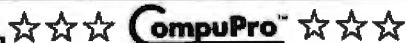

5 REASONS WHY YOU SHOULD SPEND AN EXTRA 5¢ WITH PRIORITY ONE

Some of you may have noticed that some other vendors have started to advertise CompuPro products. Frankly, we're amused that it has taken them this long to see that you want state-of-the-art IEEE/696 S-100 products. The discriminating user wants boards that meet the IEEE standard, not just any board with 100 pins that is obsolete before it is sold. We've known this for years, that is why we have continued to grow while others have had to cut back. To attract your business, they try to copy us and cut the price, often by as little as five cents. Rather than cut price, we offer the best combination of price, performance, and support in the business. We at Priority One are proud of what we offer for that extra five cents. Priority One Electronics is more than just a computer store or mail order house — we're an Authorized CompuPro Systems Center. Priority One is the first place you should turn to for business, scientific, and industrial computing solutions. Here are just five examples of what that extra five cents buys:

- As an Authorized Systems Center, we provide custom system integration from board level components
- We maintain full documentation on all CompuPro hardware and software
- We attend and hold periodic factory training seminars on CompuPro products
- We have factory trained Sales Engineers available to answer your questions after the sale is made. When you call Priority One, you'll speak with a professional, not an answering machine or answering service
- We buy directly from the factory, not from two step distributors, so we're always first to receive new products and new information about enhancements for existing products. When we buy direct, we buy in volume. Whether you need one board or one hundred, we can usually deliver for stock

When you're ready for professional level, state-of-the-art micro-computing, turn to Priority One, the world's largest Authorized CompuPro Systems Center. We're ready for you

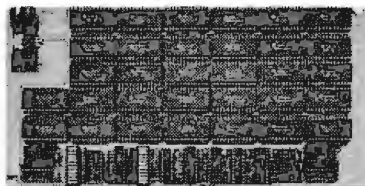

CMOS STATIC RAM

For a complete analysis of the advantages of CMOS memory, see the "Product Description" on page 416 of the January Issue of BYTE

RAM 17 - 64K CMOS STATIC RAM

RAM 17, 10 MHz, 2 Watt, DMA Compatible 24 Bit Addressing

Part No.	Description	List Price	Our Price
BHGBT175A64	64K A&T	\$599.00	\$550.00
BHGBT175C64	64K CSC	\$750.00	\$689.00

RAM 16 - 32K x 16 BIT CMOS STATIC RAM

8 and/or 16 Bit

⑩ RAM 16 10 MHz, 32K x 16 or 64K x 8 IEEE/696 16 Bit 2 Watt, 24 Bit Addressing

BHGBT180A	64K A&T	\$650.00	\$589.00
BHGBT180C	64K CSC	\$750.00	\$689.00

NEW! RAM 21 - 128K STATIC RAM

⑩ RAM 21 12 MHz, 128K x 8 or 64K x 16

IEEE/696 8 or 16 Bit 1.2 Amps, 24 Bit Addressing

BHGBT180A	128K A&T	\$1695.00	\$985.00
BHGBT180C	128K CSC	\$1895.00	\$1785.00

M-DRIVE SOLID STATE DISK DRIVE, 3500% FASTER!

Not Really, But the Next Best Thing for CompuPro 8085/88 Users. Call for Details on M-Drive.

M-Drive requires a 6MHz CPU 8085/88 dual processor, Disk 1 DMA disk controller and System Support 1 Multifunction Board

BHGMT0128KA	128K of A&T memory & M-Drive Software	\$1198.00	
BHGMT0128KC	128K of CSC memory & M-Drive Software	\$1388.00	
BHGMT0256KA	256K of A&T memory & M-Drive Software	\$2395.00	
BHGMT0256KC	256K of CSC memory & M-Drive Software	\$2785.00	

STATIC MEMORY BOARDS

RAM 20 - 32K STATIC RAM

RAM 20 10 MHz, 4K byte block disable, bank select or 24 bit addressing available 8, 16, 24 or 32K

BHGBT164A48	8K A&T	\$210.00	\$190.00
BHGBT164A8	8K CSC	\$280.00	\$260.00
BHGBT164AA16	16K A&T	\$285.00	\$260.00
BHGBT164AC16	16K CSC	\$355.00	\$325.00
BHGBT164AA24	24K A&T	\$355.00	\$325.00
BHGBT164AC24	24K CSC	\$425.00	\$385.00
BHGBT164AA32	32K A&T	\$425.00	\$385.00
BHGBT164AC32	32K CSC	\$495.00	\$450.00

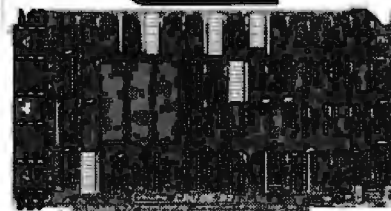

CPU BOARDS CO-PROCESSOR 8086/8087 (16)

16 bit 8 or 10 MHz 8086 CPU with sockets for 8087 and 80130

Part No.	Description	List Price	Our Price
BHGBT186A	A&T 8MHz 8086 only	\$695.00	\$ 825.00
BHGBT186C	CSC 10MHz 8086 only	\$850.00	\$765.00
BHGBT186A87	A&T with 8087 option*	\$1295.00	\$1225.00
BHGBT186C87	CSC with 8087 option*	\$1550.00	\$1456.00

*8087 Limits clock speed to 5MHz

DUAL PROCESSOR 8085-8088

6 or 8 MHz Provides true 16 Bit Power with a standard 8 bit S-100 bus

BHGBT1612A	A&T 6MHz	\$425.00	\$398.00
BHGBT1612C	CSC 6/8 MHz	\$525.00	\$488.00

CPU-Z Z80 CPU

2/4 MHz Z80 CPU 24 Bit Addressing

BHGBT160A	A&T	\$295.00	\$280.00
BHGBT160C	CSC 3-6 MHz	\$395.00	\$375.00

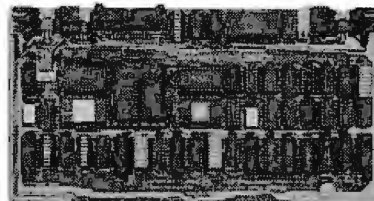

I/O BOARDS

SYSTEM SUPPORT 1 MULTIFUNCTION BOARD

Serial port (software prog. baud), 4K EPROM or RAM provision, 15 levels of interrupt, real time clock, optional math processor

Part No.	Description	List Price	Our Price
BHGBT162A	Assembled & Tested	\$399.00	\$360.00
BHGBT162C	CSC	\$495.00	\$460.00
BHGBT6231	Math Chip		\$185.00
BHGBT6232	Math Chip		\$185.00
BHGBT162AM1	A&T with 8231 Math Chip		\$555.00
BHGBT162CM1	CSC w/8231 Math Chip		\$655.00
BHGBT162AM2	A&T w/8232 Math Chip		\$555.00
BHGBT162CM2	CSC w/8232 Math Chip		\$655.00

MPX CHANNEL BOARD

I/O Multiplexer, using 8085A-2 CPU on board with 4K RAM

BHGBT166A4	Assembled & Tested	\$495.00	\$445.00
BHGBT166C4	CSC	\$595.00	\$535.00

With 16K RAM

BHGBT166A16	Assembled & Tested	\$649.00	\$585.00
BHGBT166C16	CSC	\$749.00	\$675.00

INTERFACER 1

Two Serial I/O

BHGBT133A	Assembled & Tested	\$249.00	\$219.00
BHGBT133C	CSC	\$324.00	\$288.00

INTERFACER 2

Three parallel, one serial I/O board

BHGBT150A	Assembled & Tested	\$249.00	\$219.00
BHGBT150C	CSC	\$324.00	\$288.00

INTERFACER 3

Eight channel multi-use serial I/O board

BHGBT1748A	Assembled & Tested	\$699.00	\$628.00
BHGBT1748C	CSC 200 hr. 8 Port	\$849.00	\$750.00
BHGBT1745A	Assembled & Tested	\$599.00	\$558.00
BHGBT1745C	CSC 200hr. 5 port	\$699.00	\$628.00

INTERFACER 4

Three Serial, 1 Parallel, 1 Centronics Parallel

BHGBT187A	Assembled & Tested	\$350.00	\$315.00
BHGBT187C	CSC	\$450.00	\$415.00

SPECTRUM COLOR GRAPHICS

Color Graphics board with Parallel I/O

BHGBT144A	Assembled & Tested	\$399.00	\$348.00
BHGBT144C	CSC	\$449.00	\$398.00
BHGBT20	Sublogic Universal Graphics Interpreter Software		\$35.00

S-100 MOTHERBOARDS

Active termination, 6-12-20 Slot

BHGBT153A	A&T 6 slot, 2 lbs.	\$140.00	\$128.00
BHGBT153C	CSC 6 slot, 2 lbs.	\$190.00	\$175.00
BHGBT154A	A&T 12 slot, 3 lbs.	\$175.00	\$155.00
BHGBT154C	CSC 12 slot, 3 lbs.	\$240.00	\$220.00
BHGBT155A	A&T 20 slot, 4 lbs.	\$265.00	\$235.00
BHGBT155C	CSC 20 slot, 4 lbs.	\$340.00	\$310.00

ACTIVE TERMINATOR

Allows older S-100 motherboards to run faster and quieter

BHGBT106A	Assembled & Tested		\$59.50
-----------	--------------------	--	---------

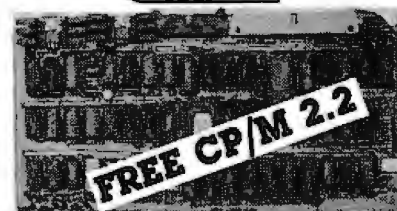

FREE CP/M 2.2

DISK CONTROLLERS

DISK 1 FLOPPY CONTROLLER

Fast DMA, Soft Sector, Controls 8" or 5 1/4" Single or Double Density. OUR BEST!

BHPOBT171ACP	A&T w/CP/M2.2 & BIOS\$670.00	\$450.00
BHGBT171C	CSC \$595.00	\$555.00
BHGBTCPMB0*	CP/M 2.2 for Z80/8085 with manuals & BIOS 8" S/D disk	\$175.00
BHGBTCPMB6	CP/M for 8086 with manuals & BIOS 8" S/D disk	\$300.00

NEW! DISK 2/SECTOR CHANNEL HARD DISK CONTROLLER

Fast DMA 2 board set. Controls 4 Shugart 4000 series or Fujitsu 2300 type drives. Includes CP/M 2.2*

BHGBT177A	Assembled & Tested	\$795.00	\$750.00
BHGBT177C	CSC	\$895.00	\$850.00

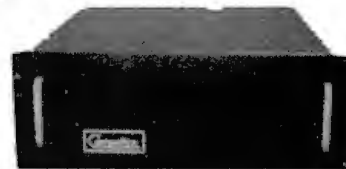

S-100 MAINFRAME

110V 60Hz CVT Mainframe uses famous 20 slot COMPUPRO Motherboard, 55 lbs.

BHGBTENC20RM	20 Slot Rack Mount	\$895.00	\$825.00
BHGBTENC20DK	20 Slot Desk Top	\$825.00	\$760.00

Turn page for complete CompuPro Systems

MORROW DESIGNS

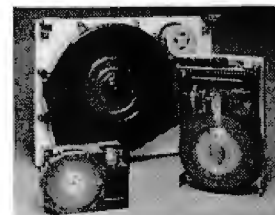

NEW! S-100 5-26 MB HARD DISK SUBSYSTEMS

5 - 10 Mb DMA SUBSYSTEMS

Each subsystem includes DMA Hard Disk Controller, Seagate ST506 5 Mb or ST412 10 Mb 5 1/4" Hard Disk, Cabinet, power supply, CP/M™2.2 and Microsoft BASIC.

BHMOSOMAM*	Software supplied on 8" IBM 3740 disk with blank I/O and INSTALL program		
BHMOSOMAM*2B	Software configured for Morrow DJ/2B controller and Multi I/O as console		
BHMOSOMAM*DMA	Software configured for Morrow DJ/DMA controller and Multi I/O as console		
BHMOSOMAM*NS	Software supplied on 5 1/4" 10 sector North Star disk with blank I/O and INSTALL Program		

Replace * in above part numbers with 5 for 5Mb Subsystems or 10 for 10Mb Subsystems.

DISCUSM5	5 Mb Subsystems	\$2195.00	\$1875.00
DISCUSM10	10Mb Subsystems	\$3195.00	\$2875.00

(order by part numbers listed above)

DISCUS HDC 20-26 Mb SUBSYSTEMS

Each subsystem includes HDCA I/O mapped controller, Shugart SA4008 14" 26Mb or Fujitsu 2308 8" 20Mb Hard Disk, cabinet, power supply, CP/M™2.2 & Microsoft BASIC.

BHMOSHOC20	Discus M20 A&T	\$4495.00	\$3804.00
BHMOSHOC26	Discus M26 A&T	\$4495.00	\$3894.00

I/O BOARDS

MULTI I/O

Three Serial, Two Parallel

BHMOSMB3200	Assembled & Tested	\$359.00	\$329.00
-------------	--------------------	----------	----------

SWITCHBOARD

Two serial I/O, four parallel I/O,

one status port, one strobe port

BHMOSB2411		\$299.00	\$269.00
------------	--	----------	----------

Call for complete DECISION 1 Systems

* Call for complete information on the new Micro Decision 2-80 based computer breakthrough!

SUMMER CASH AND CARRY SALE

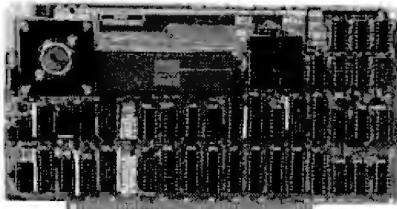

CPU BOARDS

CPU/68000 - 8MHz 68000 CPU

16 bit 68000 CPU with on board ROM containing MACSUBG Monitor or Motorola 68541 Memory Management Unit (MMU).

Part No.	Description	List Price	Our Price
BNDULCP68000	A&T with Monitor	\$1195.00	\$1075.00
BNDULCP68000M	A&T with MMU	\$1495.00	\$1395.00

MEMORY BOARDS

DMEM256KP-256K DYNAMIC MEMORY MODULE

256Kb with byte parity error detection for 8 or 16 bit computers

BNDULMEM258	256K A&T	\$1495.00	\$1395.00
-------------	----------	-----------	-----------

CMEM NONVOLATILE CMOS MEMORY

Nonvolatile CMOS memory with 3-10 year battery backup on board.

BNDULCMEM8	8K A&T	\$695.00	\$629.00
BNDULCMEM16	16K A&T	\$795.00	\$725.00
BNDULCMEM32	32K A&T	\$995.00	\$940.00

2716/2732 EPROM BOARD WITH 16 BIT DATA PATHS

Designed to hold 32Kb of 2716 type or 64Kb of 2732 type EPROMs, or ROMs for read only use with 16 bit CPU systems.

BNDULEPROM32	2716 EPROM Board A&T	\$295.00	\$260.00
BNDULEPROM64	2732 EPROM Board A&T	\$295.00	\$260.00

REAL TIME & DATA ACQUISITION

SIO4/DMA INTELLIGENT CONTROLLER

4 port RS232 interface with DMA transfers for output. 256b FIFO input buffer; On board 8085A-2 processor; 16 program selectable baud rates and occupies only 16 I/O addresses. Ideal for DUAL UNIX® or other multi-user systems.

NEW!

BNDULSIO4DMA	Assembled & Tested	\$695.00	\$650.00
--------------	--------------------	----------	----------

AIM 12-12 BIT A/D CONVERTER

A/D input module with 12 bit accuracy, 32 input channels and optional instrumentation amplifier

BNDULAIM12	A&T with Instrumentation Amp.	\$745.00	
BNDULAIM12B	A&T without Instrumentation Amp.	\$680.00	

AOM 12-12 BIT D/A CONVERTER

D/A output module, 4 channels, 12 bit accuracy. Optional VIC420 industrial output module (4-20Ma), 4 channels, used in conjunction with AOM12.

BNDULAOM12	Assembled & Tested	\$675.00	\$640.00
BNDULVIC420	Assembled & Tested	\$675.00	\$640.00

CLK24-NONVOLATILE CLOCK/CALENDAR

Day, date, hours, minutes, seconds, and 3-5 year battery backup on board. Read or write directly from I/O port. Jumperable for 64Hz UNIX® or real time applications.

BNDULCLK24C	A&T w/64Hz Interrupt	\$300.00	\$285.00
-------------	----------------------	----------	----------

SOFTWARE

DIGITAL RESEARCH

BNDIRCPM	CP/M® 2.2 Control Program/ Microcomputers	\$150.00	
BNDIRMAC	MAC® Macro Assembler	\$ 90.00	
BNDIRRMAC	RMAC® Relocating MAC	\$200.00	
BNDIRSID	SID® Symbolic Instruction Debugger	\$100.00	
BNDIRTEX	TEX® Text Formatter	\$100.00	
BNDIRDES	DESPOOL® Background Print Utility	\$ 50.00	
BNDIRC680	CBASIC® Programming Language	\$150.00	
BNDIRC8086	CBASIC-86® Programming Language	\$325.00	

MICROPRO INTERNATIONAL

BNDMSWOSTR	Wordstar Version® 3.0	\$249.00	
BNDMSMLMRG	Mail Merge®	\$100.00	
BNDMSSPSTR	Spell Star®	\$150.00	
BNDMSCALSTR	Calc Star®	\$200.00	
BNDMSDATSTR	Data Star®	\$200.00	
BNDMSSUPSET	Supersort®	\$150.00	

*Trademark of Micropro International

SORCIM

BNSDRSCAL	SUPERCAL® a Superior Electronic Worksheet	\$229.00	
BNSORACTI	ACT I® 8080/Z80 Assembler	\$175.00	
BNSORACTII	ACT II® 8086/8088 Assembler	\$175.00	
BNSORTRNS	TRANS® 8086/8088 Translator	\$125.00	
BNSORPMB0	PASCAL/M® REL4 8080/8085/Z-80	\$395.00	
BNSORPMB6	PASCAL/M® 8086	\$495.00	

*Trademark of Sorcim

MICROSOFT

BNDMSBAS00	BASIC-80® Version 5.X Extended Disk Basic	\$300.00	
BNDMCPBASC	BASIC® Compiler Version 5.X	\$395.00	
BNDMSMFT	FORTRAN-80®	\$500.00	

*Trademark of Microsoft/Consumer Products



110V 60Hz CVT Mainframes, the best money can buy!
12 Slot ±8V 17±16V @2A
22 Slot ±8V @ 30A± 16V @ 4A

PART NO.	DESCRIPTION	LIST PRICE	SALE
BHTEIMCS112	12 Slot Desk	\$755.00	\$520.00
BHTEIMCS122	22 Slot Desk	\$910.00	\$745.00
BHTEIRM12	12 Slot Rackmount	\$800.00	\$550.00
BHTEIRM22	22 Slot Rackmount	\$965.00	\$790.00

Shipping Weight: On 12 Slot Mainframes: 45 lbs.
On 22 Slot Mainframes: 55 lbs.

S-100 MAINFRAME WITH 12 SLOT MOTHERBOARD AND CUTOUPS FOR 3 - 5 1/4" FLOPPY DISK DRIVES

+8V @ 17A ±16V @ 2A +12V @ 1.2A Internal Power Cable

BHTEIF12F	12 Slot Desk	\$745.00	
BHTEIF12R	12 Slot Rackmount	\$855.00	

Shipping Weight: On 12 Slot Desk: 40 lbs.
On 12 Slot Rackmount: 45 lbs.

DUAL 8" DISK DRIVE CHASSIS

For two Shugart 801R or two Qume DT-8 size drives with internal power cables provided
+24V @ 1.5A +5V @ 1.0A -5V @ 25A

BHTEIOFDD	Desk Top	\$565.00	\$480.00
BHTEIRFDD	Rackmount	\$725.00	\$650.00

Shipping Weight: On Desk Top: 40 lbs.
On Rackmount: 45 lbs.

PRIORITY ONE ELECTRONICS is a master distributor for TEI. Dealers & OEM's call for quantity pricing.



SMARTMODEM

• Auto Answer, Auto Dial, Full or Half-Duplex, Loop Back • Serial binary, and asynchronous data formats with 7 or 8 data bits; 1 or 2 stop bits; odd, even or no parity • 0-300 baud • RS232C interface • Z8 Microprocessor with 2Kb control program • 40 character command buffer • Size: 1.5" x 5.5" x 9.6"

BHCHO200P	Smartmodem (Sh. Wt. 6 lbs.)	\$279.00	\$225.00
BHCHO300P	Chronograph (Sh. Wt. 3 lbs.)	\$249.00	\$205.00
BHCHO100P	Microdemon 100 (Sh. Wt. 4 lbs.)	\$399.00	\$325.00
BHCH2901D	CP/M® B* Terminal Program for above	\$ 25.00	
BHCHO000P	Microdemon II	\$379.00	\$299.00
BHCH2401D	Datacom (PASCAL patch) for above	\$ 50.00	



WORLD'S BEST SELLING TERMINAL!

Extra Memory Pages!

FREE!!

BNDPOTLRES25P	\$749.00	
*TeleVideo 925 w/true 2nd page memory kit, a \$95.00 value!		
BNDPOTLRES04P	\$949.00	
*TeleVideo 950 w/true 2nd, 3rd & 4th page memory kit, \$285.00 value!		
BNDLP010 Sh. Wt. 43 lbs.	\$699.00	

BEST BUY!

SEND \$1.00 TODAY FOR THE NEW, FULL COLOR SPRING 1982 ENGINEERING SELECTION GUIDE!



SBC MASTER PROCESSOR

This is absolutely the most complete single board computer available
NO EXTERNAL INTERFACE BOARDS ARE NEEDED!

• Z80ACPU • 64K BankSwitchable Memory • 4K EPROM • Auto Boot • NEC 765 FDC with PLL interface to all Shugart compatible drives (5 1/4" or 8") • 2 RS-232C Serial ports (Z80ASIO, up to 19.2k Baud) • 2 Parallel Ports (Z80APIO) • 4 Timers (Z80ACTC) • IEEE 696/S-100 Compatible • CP/M® and TURBODOS® compatible • Full One Year Warranty
BHP0BSBCPM A&T w/BIOS & CP/M®2.2 \$1095.00 \$895.00

SBC SLAVE PROCESSOR

Similar to above with 16K EPROM, X-Buss Expansion Interface, and optional on board EPROM burner
BHS0SBCS Assembled & Tested \$795.00 \$750.00

SDS MICROPOLIS HARD DISK INTERFACE

Micropolis 1220/1250 MICRODISK series interface adapter with software drivers, cabling, and mounting hardware. (A&T Sh. Wt. 50 lbs.)
BHS0SHI Assembled & Tested \$150.00

MICROPOLIS 12531 45MB 8" WINCHESTER DISK

8" 3 platter MICRODISK with 36Mb formatted capacity. Drive is shock mounted in attractive Micropolis desk top enclosure with power supply
BHMCP12531 Assembled & Tested \$5384.00 \$3995.00

SIERRA/MICROPOLIS SBC PACKAGE

Sierra SBC, CP/M®, Micropolis Interface, and Micropolis 12531 MICRODISK.
BHP0BSBCSYS1 (Sh. Wt. 50 lbs.) \$6629.00 \$4405.00

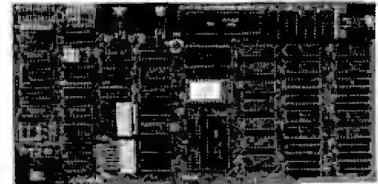

VIDEO AND I/O

VB 3 - HIGH RESOLUTION VIDEO

80 x 25 or 50 character video display Memory Mapped Parallel Keyboard port
BHSSMVB3A24 80 x 24 A&T \$499.00 \$440.00
BHSSMVB3UP 80 x 50 Line Upgrade \$ 29.00

I/O 4

Two serial I/O, two parallel I/O
BHSSMIO4A Assembled & Tested \$290.00 \$260.00

NEW!

I/O 5

2 Serial, 3 parallel Including 1 Centronics
BHSSMIO5I Assembled & Tested \$329.00 \$300.00

NEW!

I/O 8

8 Port Serial I/O with Timer
BHSSMIO8A Assembled & Tested \$550.00 \$495.00

CPU, RAM & PROM

CB2 Z80 CPU

2/4 MHz will accept 2716, or 2732, or RAM
BHSSMCB2A Assembled & Tested \$299.00 \$275.00
BHSSMZ00M SSM Z80 Monitor \$ 09.00

MB10A 16/8K 8/16 BIT STATIC RAM

16K byte /8K word, 24 bit extended addressing, "M write", Phantom disable, addressable in 4K blocks
BHSSMMB10A Assembled & Tested \$299.00 \$275.00

MB8A 1K/16K EPROM BOARD

1K/16K 2708 EPROM board, disable in 1K increments
BHSSMNB8A Assembled & Tested \$179.00 \$159.00

FBI PROM PROGRAMMER

Programs 2708 or 2716's, operates as a 4K/8K EPROM BOARD AS WELL
BHSSMP61A Assembled & Tested \$285.00 \$260.00



ORDER TOLL FREE (800) 423-5922 CA, AK, HI CALL (213) 709-5464

Terms: U.S. VISA, MC, Bank, Check, Money Order, U.S. Funds Only. CA residents add 6 1/2% Sales Tax. MINIMUM PREPAID ORDER \$15.00. Include MINIMUM SHIPPING & HANDLING of \$3.00 for the first 3 lbs. plus 25¢ for each additional pound. Orders over 50 lbs. send freight collect. Just in case, please include your phone number. Prices subject to change without notice. We will do our best to maintain prices through August, 1982. Credit Card orders will be charged appropriate freight. If you haven't received your Spring '82 Engineering Selection Guide, send \$1.00 for your copy today! Sale prices are for prepaid orders only.

CompuPro™



PERFORMANCE, QUALITY, RELIABILITY, HIGH PERFORMANCE SYSTEMS DESIGNED TO EXPAND WITH YOUR NEEDS

All CompuPro systems have been designed with your future in mind. Each system is expandable so you can upgrade your system as your needs continue to grow. Single user systems may be upgraded into multi-user systems for under \$3,000.00. Additional users may be added to multi-user systems at any time. Hard disk storage is also available with the new DISK 2 DMA Winchester disk controller. Unlike many "personal" computers, your CompuPro system will not become obsolete when it is time to expand. The modular design of the IEEE 696/S-100 bus allows you to plug in additional boards when they are needed. CompuPro system components feature the latest state-of-the-art technology to prevent obsolescence.

Each CompuPro system component is fully assembled and tested under rigorous burn-in conditions at the factory and then shipped to Priority One Electronics, your authorized CompuPro Systems Center, for final integration and configuration. CompuPro systems carry the best warranty in the business: 1 year on A & T systems, 2 years on CSC systems. The Oume drives have a full six month warranty, the best drive warranty anywhere. The components are integrated into a complete system by a factory trained Priority One Electronics technician. The systems are then partially disassembled for shipping. After a short time for unpacking and check-out, your CompuPro system will be ready to load and go!

SYSTEM COMPONENTS

Each CompuPro system includes the following:

- CPU 8085/88 6MHz Dual Processor CPU (8088 runs at 8MHz in CSC systems)
- Disk 1 Lightning Fast DMA Floppy Disk Controller
- CP/M® 2.2 and CP/M 86™ Operating Systems
- Sorcim's SUPERCALC-86 Electronic Spreadsheet program
- Two double-sided, double-density Oume DT-8 disk drives in an attractive desk top enclosure
- Rugged Desk Enclosure 2 with 20 slot actively terminated motherboard, fan, air and line filters, and constant voltage power supply for years of reliable operation
- Internal I/O cables and floppy disk data cable
- Complete documentation for each system component as well as a system integration guide

060ENTRY LEVEL SINGLE-USER SYSTEM — The system is designed for high performance at a minimal cost. It may be upgraded at any time by additional memory. Each system includes the common components listed above and the following:

- 128K 10MHz Low Power Static Ram for low power consumption and reliability
- Interfacer 4 I/O board with three RS232 Serial ports, one bi-directional parallel port, and one Centronics parallel port

BHGBTSYS1DKA Single User System Desk Top, A&T **\$5495.00**
BHGBTSYS1DKC Single User System Desk Top, CSC **\$5995.00**

SINGLE USER M-DRIVE SYSTEM — This system may be operated with CP/M® 2.2 in 8 bit mode as a 128K M-Drive system or in 16 bit mode with CP/M 86™ to give the user maximum flexibility. This system includes the common components listed above and:

- 192K 10MHz Low Power Static RAM for low power consumption and reliability
- System Support 1 Multifunction Board
- Interfacer 3 Eight port RS232 Serial Interface Board
- M-Drive Software for use in 8 bit mode

BHGBTSYS2DKA M-Drive System Desk Top, A&T **\$6995.00**
BHGBTSYS2DKC M-Drive System Desk Top, CSC **\$7745.00**

ENTRY LEVEL MULTI-USER SYSTEM — This system is designed for two or three users depending upon user memory allocation size. This system includes everything in the above Single-User M-Drive System plus:

- 8MHz 8088 standard on Dual Processor CPU board
- 192Kb of additional memory for a total of 384Kb of low power 10MHz static memory

• MP/M [®] Multi-user software. MP/M [®] is a CompuPro proprietary implementation of Digital Research's MP/M 86™ 16 bit multi-user operating system. This software package includes CP/M® V2.2, CP/M86™, and MP/M 86™. The beauty of this software is that both 8 bit CP/M® 2.2 and 16 bit CP/M 86™ programs may be run on the system at the same time by different users. This allows the user to take advantage of the vast library of 8 bit software as well as the growing selection of 16 bit software without being limited to one or the other. When running CP/M® 2.2 programs under MP/M [®] there is 60K of user memory rather than the usual 48K for better system performance; another CompuPro exclusive! This unique software package, ideal for software development or scientific applications, is available only as part of a CompuPro system.

BHGBTSYS3DKA Multi-User System Desk Top, A&T **\$8995.00**
BHGBTSYS3DKC Multi-User System Desk Top, CSC **\$9945.00**

Rack mount systems are also available; please call or write for details. All CompuPro systems are shipped via motor or air freight collect; please specify at time of order. All boards are shipped in standard configurations

CP/M, CP/M 86, and MP/M 86 are trademarks of Digital Research. MP/M [®], a proprietary implementation of MP/M 86, is a trademark of CompuPro under license from Digital Research. [®] is a trademark of CompuPro.

5" DISKETTES!

SOFT SECTOR
40 TRACK SINGLE SIDED
DOUBLE DENSITY WITH
HUB REINFORCING RINGS
PKG. OF 10 \$19.95

BONUS!

FREE! CASSETTE 10
LIBRARY CASE WITH
PACKAGE OF 10 DISKETTES
A \$4.25 VALUE Part No. BHPRI55DD



PRI58D package of 80 less Library Case **\$120.00**

PRI8SD package of 10 8" S.S./D.D. Diskettes no sleeves **\$20.00**
5 or more packages **\$18.00**

SMITH-CORONA TP-1

LETTER QUALITY -
ELECTRONIC TEXT
PRINTER



\$649.00
SCMTP1510

- 12 CPS • 10 CPI • 6LPI • SERIAL INTERFACE
- 50-19.2K Baud • Friction Feed • 88 Character
- BHSCM12625** TP1 Black Milar Ribbon **\$3.50**
- BHSCM12658** TP1 Black Fabric Ribbon **\$7.50**

SANYO

FCC CLASS 2
APPROVED
DATA DISPLAY
MONITORS



SPECIFICATIONS:

Viewing Screen 12" diagonal, 75 square inches
DM2112: P31 phosphor
525 lines; 60 fields/second; overscan
600 lines, center

Scanning System Horizontal Resolom
Signal Input 1.0 volt p-p composite video; 75 ohms

BHSYODM2112

List Price: \$160.00 **SALE: \$119.00**

OTHER SANYO MONITORS ON SALE TOO!!

Part No.	Description	List Price	SALE
BHSYODM4509	9" B&W P4, 10MHz (15 lbs.)	\$215.00	\$149.00
BHSYODM4509CX	9" Green, P31, 10MHz (15 lbs.)	\$200.00	\$159.00
BHSYODM6012C	12" B&W P4, 18MHz (24 lbs.)	\$250.00	\$195.00
BHSYODM6112CS	12" Green, P31, 18MHz (24 lbs.)	\$260.00	\$199.00
BHSYODM60813	13" Color, 16 x 64 (35 lbs.)	\$470.00	\$375.00
BHSYODM6113*	13" RGB Color (35 lbs.)	\$995.00	\$895.00

*As used with IBM P.C.

APPLE DISK DRIVES



Give your APPLE II® a Fourth Dimension — the totally compatible 5 1/4" drive that takes your system farther, faster. With read/write electronics so advanced that reading errors are virtually eliminated. With a track zero microswitch that keeps boot and track access smooth and quiet. With the ability to read half-track software and up to 143,360 bytes on DOS 3.3®. With similar performance on DOS 3.2.1®, Pascal® or CP/M® operating systems. And, the disk enclosure mates perfectly with APPLE cabinetry.

EXTENDED WARRANTY

Fourth Dimension offers a 12 month parts and labor warranty at no cost to you! (Gee, this really looks good!)

BHFDSD40A List Price: \$419.00 **SALE: \$369.00**

2 or More, only \$350.00 each

BHFDSD40C* APPLE II® Disk Drive Controller **\$115.00**

*Sold only with purchase of Fourth Dimension Drive

HOW CLEAN IS YOUR POWER?

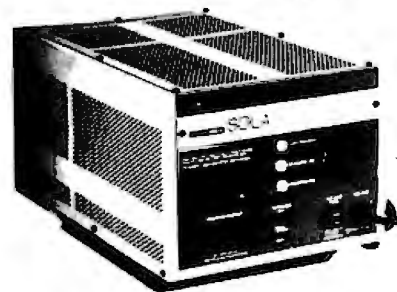

The Sola Micro/Mini Computer Ultra Isolated Regulator provides instantaneous voltage regulation, and ultra isolation from both transverse and common mode noise for any type of load. It also suppresses transients, protects against overloads and serves as a portable dedicated line. It is the ultimate in AC line conditioning equipment.

The Sola "Micro/Mini" is particularly applicable in systems involving mini or micro computers, POS equipment, microprocessors, or data terminals — where noise and transients cause errors, or low voltage and short term disruptions can result in loss of memory. The output waveshape is sinusoidal and contains less than 3% harmonic distortion, making it ideal for any electronic load.

Common mode noise rejection exceeds 120 dB for the regulator, while transverse noise rejection is better than 60 dB — true ultra isolation. Brownout protection is a real bonus feature. Input line voltage variations as great as ±15% are instantaneously regulated to a maximum output deviation of ±3%. And, the output will remain within NEMA voltage specifications for input voltages as low as 65% of nominal.

Especially designed for office type environments, the Sola "Micro/Mini" is truly portable and has a low sound level of 43 dB.

- Instantaneous regulation
- Regulator common mode noise rejection of 120 dB
- Regulator transverse mode noise rejection of 60 dB
- Completely portable — no installation costs
- Matches Micro/Mini computer packaging
- Complete isolation from power line - less than 3pFd
- Quiet operation — below normal office levels
- Operating range from -20°C to +50°C
- No loss of output for line loss up to 3 msec
- Line cord
- On-off switch
- Dual output receptacles

MINICOMPUTER REGULATORS

PORTABLE 120VAC 60 Hz SINGLE PHASE

Part No.	Maximum Output VA Rating	Dimensions L x W x H (Approx.)	Approx. Shipping Weight	Price List	Price Ord
BHSLA6313070	70	12 x 6 x 6	6	\$186.85	\$159.00
BHSLA6313114	140	12 x 6 x 6	18	\$244.90	\$208.40
BHSLA6313250	250	14 x 8 x 8	31	\$291.00	\$248.05
BHSLA6313150	500	17 x 9 x 9	47	\$404.20	\$344.00
BHSLA6313175	750	17 x 9 x 9	60	\$515.60	\$438.80
BHSLA6313210	1000	17 x 9 x 9	75	\$597.20	\$508.25
BHSLA6313220	2000*	17 x 11 x 11	108	\$1015.60	\$864.35

Output voltage is 120VAC ±3% for an input voltage of 95-120VAC *Unit has 30 Amp twist receptacle.

Also available are Hard Wired and 50Hz Models.

MINI UPS

A mini UPS goes one step further than a minicomputer regulator. It provides the same voltage, noise and brownout protection plus maintains power to keep equipment running smoothly during a blackout. When a power failure occurs, the internal maintenance free battery continues powering the inverter without the use of any switching devices. This provides uninterrupted, conditioned AC power to the critical load.

A true UPS always between the AC line and critical load providing complete protection from brownouts and blackouts as well as line noise and transients. Output waveshape is sinusoidal with less than 3% single harmonic and 5% total harmonic distortion. Regulated output is ±3% when operating from either AC line or battery. Handles load surges and fault clearing providing 125% overload for 10 minutes, 150% overload for 10 cycles and 200% in short circuit with 2 automatic retriangles before shutdown. Maintenance-free battery automatically recharges upon return of AC line. Oper. Temp. 0°C to 40°C. Especially designed for small, sensitive electronic equipment such as minicomputers, data terminals, P.O.S. systems. Input voltage, 115VAC.

PORTABLE 120VAC 60Hz

UNINTERRUPTIBLE POWER SYSTEMS

Part No.	Maximum Output VA Rating /Time	Dimensions L x W x H (Approx.)	Approx. Shipping Weight	Price List	Price Ord
BHSLA260050400300	400/10Min	12x19x11	85	\$1544.00	\$1314.00
BHSLA260050480301	400/20Min	12x19x11	95	\$1574.00	\$1339.00
BHSLA260050750300	750/10Min	12x19x11	125	\$1674.00	\$1425.00

Also available are 220V 50Hz models of the above.

Call for all SOLA products not listed.

SUMMER CASH AND CARRY SALE

FUJITSU FROM SELLUM

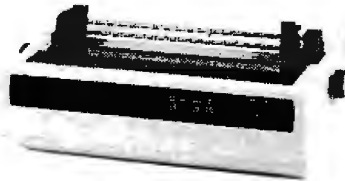

Speed and Unmatched Performance

Interfaces: • RS232C and Current Loop • Centronics type parallel interface • IEEE488 All are DIP switch selectable.
Personality Protocols: • NEC5510 • DIABLO630 • QUME Sprint9 • IBM Personal Computer • ATARI (Centronics 737).
Special Features: • 280 CPU • 12K ROM • Standard 16K Buffer • Optional 48K Buffer • 50 - 19.2K baud • Micro-coded alarm differentiates error conditions with pulse combinations • Intelligent bi-directional printing with logic seeking • Complete word processing features • Self test • Auto reprint • Auto clear error • Proportional spacing • Supports Automatic justification • Complete Vector plotting routines • Sheet feeder mode allows easy interface to most mechanical sheet feeders • 6 month warrantee • Quiet - 60db • Front panel forms control • Universal power supply 115/220V 50/60 Hz.

BEST BUY! 80 Characters per Second! **WOW!**
LETTER QUALITY!
USING THE FUJITSU SP830

Part No.	Description	List Price	Our Price
BHSLMF88	Intelligent Printer	\$3495.00	\$2795.00
OPTIONS			
BHSLMF88VFT	Vertical forms tractor		\$200.00
BHSLMF884K*	48K RAM buffer		\$300.00
Call for pricing on sheet feed options *Must be ordered with the printer			
INTERFACE CABLES			
BHCPAM572	Centronics IBM/NEC Cable		\$80.00
BHSCDB251	RS232C Serial Cable		\$80.00
Call for other cables not listed			

Para Dynamics

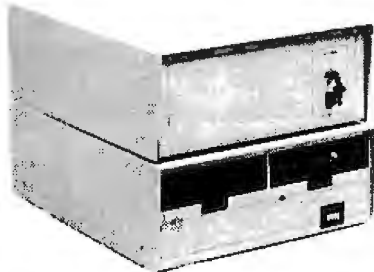

18 SLOT S-100 MAINFRAME

CVT Power Supply, forced air cooling; security lock 120 or 220V AC at 50 or 60Hz +8V@20A, ±16@3.5

BHPDN20180	Desk Top	\$799.00	\$699.00
BHPDN2018A	Rack Mount	\$849.00	\$749.00

8 SLOT S-100 MAINFRAME WITH CUTOUTS FOR 2 5 1/4" DISK DRIVES

+5@5A, -5@500MA, +8@15A, +12@6A, +16@2, -16@2			
BHPDN25080	Desk Top	\$899.00	\$789.00
BHPDN2508R	Rack Mount	\$949.00	\$839.00

DISK DRIVE FACILITY

Accommodates two 8" floppy drives, of Shugart, Qume, or similar design and dimensions. 110 or 220V AC at 50 or 60Hz CVT power.

BHPDN22000	Desk Top	\$659.00	\$578.00
BHPDN2200R	Rack Mount	\$679.00	\$595.00

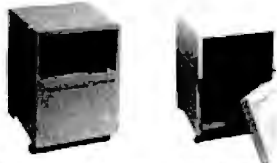

PRONTO

Free standing cabinet. Will accept 2, 8" Floppy disks and 1, 8" Rigid disk. 18 slot card cage will accept the double height 10" x 10" S-100 cards (Alpha Micro and others) CVT Power Supply.

BHPDN2818	PRONTO	\$1295.00	\$1129.00
PRONTO COMPLETE WITH POWER SUPPLY POWER-UP SEQUENCER			
BHPDN2818S	with sequencer	\$1395.00	\$1249.00
Shipped motor freight collect			

R AND FREE OKIGRAPH!! OKIDATA

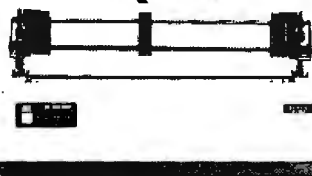

COMPARE

TO ANY OTHER PRINTER!
COMPARE PRIORITY ONE'S PRICES
TO ANY - THEN DECIDE!

Don't be fooled by those who try to "soak" you for the options

- Bi-DIRECTIONAL-120 CPS • Both Parallel and 1200
- 9 x 9 Matrix (Alphanumeric) baud Serial I/O (82A & 83A)
- 6x9or12 Matrix for graphics • Self Test
- 5.8.3, 10, 16 Characters • Out of Paper Switch Per Inch
- 80 CPL @ 10 CPI for 82A • Friction or Optional Tractor
- 132 CPL @ 100CPI for • Feed (Tractor Standard on 84, 83A & 84
- 10 different character sets

All three printers feature front panel switch selectable for lengths; 10 lengths: from 3" to 14". Front or bottom aper loading for up to 4 part forms and tea bar. All of these features make OKIDATA the best value in low cost printers

BHPDUBKIB2A16	OKIDAT82A w/tractor and graphics	\$538.00
BHPDDBKIB3A16	OKIDAT83A w/tractor & graphics	\$750.00
BHOKISER2KBF	9600 Baud 2K serial buffer/interface	\$149.00
BHOKIDAT84AP	132 col. printer parallel interface with graphics and tractor (35 lbs.)	\$1095.00
BHOKIDAT84AS	132 col. printer 9600 baud serial 2K interface, graphics and tractor (35 lbs.)	\$1250.00
BHMBAPLWTWC*	Apple Parallel Interface w/Cable	\$75.00

*Sold only with printer

COMPARE PRICES!!

ADDS

Applied Electronics Systems Inc.

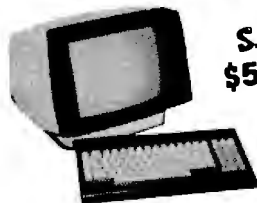

SALE!
\$525.00

VIEWPOINT - ADDS

Detachable keyboard, RS232 interface and auxiliary port 80 x 24 display, tiltable screen.

BHADQVWPR	Sh. weight: 30 lbs.	\$699.00	\$525.00
-----------	---------------------	----------	----------

DISK CABINETS

V-100 - VISTA

- Desk or rack mountable • Internal power and data cable:
- Drives pull out for easy service and maintenance

BHVISV100	Disk Drive Cabinet (43 lbs)	\$495.00	\$449.00
BHVISV100	With purchase of two 8" Disk Drives		\$399.00

SINGLE 8" - Q.T.

BHQTCDC8	Single 8" cabinet with power supply (22 lbs.)	\$249.00	\$225.00
----------	---	----------	----------

DUAL 8" - Q.T.

BHQTCDC88	Dual 8" cabinet with power supply (24 lbs.)	\$395.00	\$349.00
-----------	---	----------	----------

5" CABINETS - VISTA

BHVIS5801	Single 5" with P.S.	\$85.00
BHVIS5802	Dual 5" with P.S.	\$110.00

FOR THE NEW, FULL COLOR SPRING 1982 ENGINEERING SELECTION GUIDE!

PRIORITY

ONE

ELECTRONICS

9161 DEERING AVE • CHATSWORTH, CA 91311

ORDER TOLL FREE (800) 423-5922 - CA, AK, HI CALL (213) 709-5464

Terms: U.S. VISA, MC, BAC, Check, Money Order, U.S. Funds Only. CA residents add 6 1/2% Sales Tax. MINIMUM PREPAID ORDER \$15.00. Include MINIMUM SHIPPING & HANDLING of \$3.00 for the first 3 lbs., plus 25¢ for each additional pound. Orders over 50 lbs. sent freight collect. Just in case, please include your phone number. Prices subject to change without notice. We will do our best to maintain prices through August, 1982. Credit Card orders will be charged approximately \$1.00 for your copy today! Sale prices are for prepaid orders only.

Tandon

Tandon TM-800 Thinline is exactly half the size of conventional 8" floppy disk drives

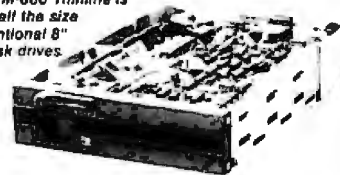

exactly one-half the height of any other model. Proprietary, high-resolution, read-write heads patented by Tandon

D.C. only operation - no A.C. required Industry standard interface.

Three millisecond track-to-track access time (9 lbs.)			
BHTNDTM8481	Single Sided \$380.00	2 or more	\$370.00
BHTNDTM8482	Double Sided \$495.00	2 or more	\$485.00
BHTNDTM8M	Manual - not included with drive		\$10.00

TANDON 5 1/4" DRIVES

BHTNDTM1001	Single Sided, 250KB (5 lbs.)	\$220.00	* ea
2 or More \$200.00			
BHTNDTM1002	Double Sided, 500KB	\$295.00	ea.
2 or More \$270.00			
BHTNDTM1003	Single Sided, 500KB	\$295.00	ea.
2 or More \$270.00			
BHTNDTM1004	Double Sided, 1000KB	\$395.00	ea.
2 or More \$375.00			
BHTNDTM5M	manual, not included with drive		\$10.00

*As used in the IBM P.C.

MITSUBISHI ELECTRIC

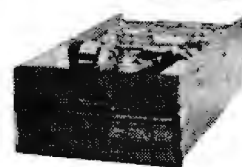

Better Than QUME!
 Better Than SHUGART!

8", Double-sided, double-density, interchangeable with QUME & Shugart			
BHMIM289463	Sh. Weight 16 lbs.		\$495.00
BHMIM289463 M	Manual		\$10.00
2 or More \$475.00 each			

Shugart 801R

Single sided, double density - most popular 8" drive
 BHSN801R \$394.90 ea. or 2 or more (16 lbs) for \$389.00
 QHSN801RM Manual for 801R drives \$10.00



INTERNATIONAL INSTRUMENTATION, INC.

OUR BEST!!



UNIVERSAL DISK ENCLOSURES

- Accepts any combination of 8" drives (QUME/Shugart 801R type or 1/2 size Tandon type) • Also accepts hard disks • Positive pressure • Optional Disk environment monitor shows supply voltage and internal cabinet temperature • Internal power and data cables provided.

UNIVERSAL DRIVE CABINET complete with power supply, fan and filter, and all internal cables for attachment of two 8" floppy drives.

BHUIUDE004	Dual Drive Cabinet (Sh. Wt. 40 lbs)	\$495.00	\$450.00
BHUIUDE004	With purchase of two 8" Disk Drives		\$399.00

BHUIUDE004EM w/Environmental Monitor installed \$584.95 \$535.00

BHUIUDE004EM With purchase of two 8" Disk Drives \$485.00

BHUIUDE004AUG Dual Drive cabinet with Augmentation power supply module to increase 5V supply from 6 amps to 9 amps for use with two hard disks or 4 Tandon drives. Also includes Disk Environment Monitor (45 lbs.) \$733.00 \$650.00

19" Rack Mount kit UDE004 \$89.95

TWIN THREE DRIVE CABINET complete with power supply, and all internal cables for attachment of three thin 8" floppy drives (Tandon type). One AC power connector is also provided for use with full size drive.

BHUIUDET Three Drive Cabinet (Sh. Wt. 35 lbs) \$495.00 \$450.00

BHUIUDETTEM with Environmental Monitor installed \$584.95 \$535.00

SPECIAL PURCHASES!



64K IEEE-S100 DYNAMIC MEMORY CARD

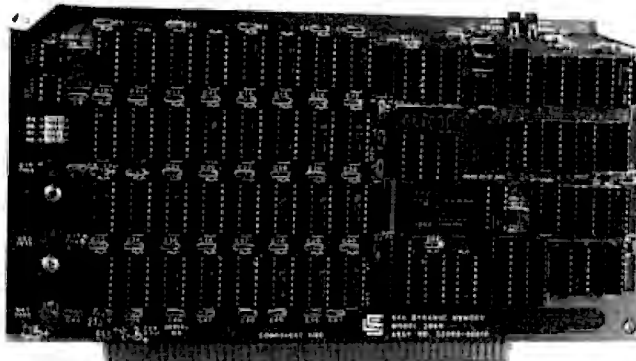

- 2 or 4 MHz operation
- Designed to IEEE proposed S-100 bus standards
- Supports IMSAI-type front panels
- Operates with either an 8080 or Z-80 based S-100 system providing processor-transparent refreshes with both
- Bank-select system allows system memory expansion
- Bank-select port's address is jumper selectable
- Any 16K block can be made bank-independent
- All 64K can be made bank-enabled on power-on and reset
- Fully buffered address and data lines

- Configuration as a 16K, 32K, or 48K board without the removal of RAMs
- Fail-safe refresh circuitry for extended Wait States
- Board configuration with reliable easy-to-configure Berg jumpers
- Supports DMA
- Jumper-selectable Phantom input
- Uses Popular 4116 RAMs
- Assembled & tested
- All ICs in sockets
- Full Factory Warranty

BHCCS20653

SHIPPING WEIGHT 2 lbs.

LIST PRICE: \$350.00

SAVE \$130.00!!

\$249.00 ea or 4/\$880.00

CompuPro **RAM 21**

128K 12MHz S-100 STATIC MEMORY 8 OR 16 BIT

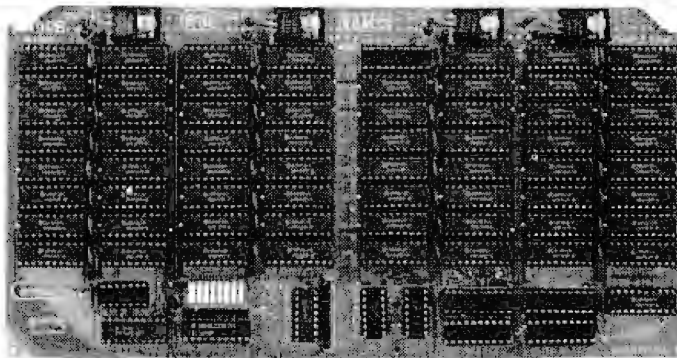

The days of "Out of Memory" are gone at last! CompuPro has introduced the largest static S-100 IEEE/696 RAM board ever to be produced.

The RAM 21 is arranged either as a 128K x 8 bit wide or 64K x 16 bit wide board, using a high speed, ultra low power proprietary static RAM. CompuPro has also included 24 bit addressing for up to 16 megabyte capability and power consumption so low your mainframe will never know it's there!

- Meets or exceeds all IEEE 696/S-100 specifications
- Fully static design uses less power than dynamics (1.2 amps typical)
- 24 bit extended addressing
- 8 bit (128K) or 16 bit (64K) operation
- Addressable as one block
- 16K window deselect, dip switch selectable
- Switch selectable PHANTOM disable
- 12 MHz CPU operation
- 16K x 1 static RAM
- Thorough bypassing of all supply lines
- Capable of DMA processing
- 128K Static, 1.2 amps
- NMOS high speed low power memory ICS

BHGBT190A

List Price: \$1695.00

SALE PRICE:

\$995.00

SAVE \$700.00!!



SUMMER CASH AND CARRY SALE



NEW 4 1/2 DIGIT HANDHELDS!

The FLUKE 8060A and 8062A offer the most powerful combination of capabilities ever in a handheld DMM, including these:

- 4 1/2 digit resolution
- 10 V, 10mA, 10M sensitivity
- 100KHz True RMS (8060A)
- 30KHz True RMS (8062A)
- Relative Reference
- Constant current diode test
- Self diagnostics
- Basic DC accuracy of 0.04% (8060A), 0.05% (8062A)

The 8060A also offers dBm, relative dB, frequency measurements to 200KHz, Autoranging megohms to 300k, and conductance (2000 nS).

BHFLUB060A with safety designed test leads \$349.00
BHFLUB062A with safety designed test leads \$279.00

3 1/2 DIGIT HANDHELDS: THE WORLD STANDARD

- dc voltage
- ac voltage
- dc current
- ac current
- resistance
- diode test
- conductance
- high-speed continuity beeper
- 11 functions:
- temperature (via K-type thermocouple)
- peak hold on voltage and current functions
- 0.1% basic dc accuracy (8024B & 8020B)
- 0.25% basic dc accuracy (8021B & 8022B)
- visual logic level detection
- and continuity indicators

Extensive overload 3 1/2-digit resolution protection with 600V double-fused current input. Safety-designed test leads. Two-year parts and ear labor warranty. Calibration Cycle.

BHFLUB024B (All 11 functions) \$239.00
BHFLUB020B (First 8 functions) \$189.00
BHFLUB021B (First 7 functions) \$149.00
BHFLUB022B (First 6 functions) \$139.00

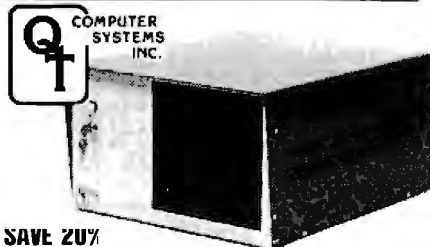

SAVE 20% S-100 MAINFRAMES FOR DUAL 8" HARD AND FLOPPY DISKS

The D.T. MFDD series mainframe is designed to be the most versatile and the most compact system enclosure on the market today. In addition to a 6, 8, or 12 slot S-100 card cage, the mainframe is designed to support two 8" floppy or hard disk drives. It is ideal for the new generation of Single Board Computers and high density RAM cards that do not require many slots. Now you can have a complete dual floppy or hard disk system in one convenient enclosure at a remarkably low price.

FEATURES:

- Accommodates any combination of standard 8" floppy or hard disk drive (801R, DT8, Fujitsu hard disk, etc.)
- IEEE S-100 Silence+ 6, 8, or 12 slot motherboard available for quiet operation with high speed processors.
- Keyed power Switch
- Reset Switch on Front Panel
- Anodized 6, 8, or 12 slot card cages
- Quiet fan with filter provides cool clean systems operation featuring positive air pressure
- Detachable line cord plugs directly into EMI noise filter for electrical noise suppression
- Two AC convenience outlets on rear panel for peripherals
- 15-DB25 cut outs for mounting I/O connectors
- 2-50 pin plug cut outs
- Dimensions: 9 1/2" x 17" x 21" (HxWxD) (Sh. Wt. 48 lbs.)
- Power Supply: +5V@7A, +24V@7A, +8@18A, ±16@3A, -5@1A

Part No. Description List Price SALE Price

RS232 and "D" SUB-MINIATURE CONNECTORS

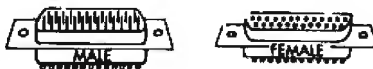

SOLDER TYPE

P=Plug, Male Type — S=Socket, Female Type — C=Cover, Hood

Part No.	Description	Price	Price	Price
BHCN00E9P	9 Pin Male	\$ 2.10	\$ 1.90	\$1.70
BHCN00E9S	9 Pin Female	\$ 2.70	\$ 2.40	\$2.10
BHCN00E9C	9 Pin Cover	\$ 1.50	\$ 1.25	\$1.10
BHCN00A15P	15 Pin Female	\$ 2.75	\$ 2.45	\$2.15
BHCN00A15S	15 Pin Female	\$ 3.95	\$ 3.60	\$3.20
BHCN00A15C	15 Pin Cover	\$ 1.50	\$ 1.30	\$1.10
BHCN00A25P	25 Pin Male	\$ 3.00	\$ 2.75	\$2.25
BHCN00A25S	25 Pin Female	\$ 4.00	\$ 3.75	\$3.00
BHCN00B51212	1 Pc. Grey Hood	\$ 1.60	\$ 1.45	\$1.30
BHCN0025H	2 Pc. Grey Hood	\$ 1.50	\$ 1.25	\$1.10
BHCN00B51226	2 Pc. Black Hood	\$ 1.90	\$ 1.65	\$1.45
BHCN00C37P	37 Pin Male	\$ 5.80	\$ 5.10	\$4.45
BHCN00C37S	37 Pin Female	\$ 8.70	\$ 7.70	\$6.70
BHCN00C37C	37 Pin Cover	\$ 1.80	\$ 1.55	\$1.30
BHCN00050P	50 Pin Male	\$ 8.75	\$ 7.75	\$6.70
BHCN00050S	50 Pin Female	\$11.65	\$10.25	\$8.90
BHCN00050C	50 Pin Cover	\$ 2.00	\$ 1.80	\$1.60
BHCN002041B	Hardware Set 2/P/RS232, DB25P, EIA	\$ 1.00	\$.80	\$.70
BHCN0RS2328F	Class 1 Cable 8 Con 8 Ft	\$19.95	\$17.95	\$15.95
BHCN0S73036	Cent. 700 Series/Epson Printer Conn.	\$ 9.00	\$ 7.50	\$6.00
BHIDC5730860	IDC Version of Above	\$ 9.95	\$ 9.00	\$8.00

NEW FROM Vector



IBM® PC PROTOTYPING BOARDS

Description	1-5	6-24	25*
BHVCT4613 3 Hole Solder Board	\$59.00	\$53.10	\$47.20
BHVCT4613-1 Bare Board	\$37.00	\$33.30	\$29.60
BHVCT4613-2 Wire Wrapping Board	\$59.00	\$53.10	\$47.20
BHVCT3690-22 Extender	\$22.35	\$20.12	

*IBM is a trademark of International Business Machines

PRENTICE

THE STAR

We've Sold Thousands!

- U to 300 baud
- Bell 103 and 113
- Exclusive triple seal acoustic chamber
- Self Test
- ±0.3% frequency stability; crystal controller
- Receiver Sensitivity of -50dB on, -53dB off
- FSK Modulation
- RS232 Compatible
- Switches: Originate/Off/Answer: Full Duplex/Test/Half Duplex
- Indicators: Transmit Data, Receive Data, Carrier Ready/Alert

Part No.	Description	List Price	SALE
BHNP810A	RS232, 113, ZUMA Current Loop	\$199	

SEND \$1.00 TODAY FOR THE NEW FULL COLOR, SPRING 1982 ENGINEERING SELECTION GUIDE

PRIORIT



MICROCOMPUTER PRODUCTS MEMORY 8080 SERIES

PART NO.	PRICE	PART NO.	PRICE
BH4116AC20	8/\$16.00	BHINS8080A	\$5.50
BH2016P3	8/\$72.00	BHINS8085A	\$19.95
BH2114N3L	8/\$28.00	BHDP8212N	\$2.95
BH5257N3L	8/\$50.00	BHDP8214N	\$2.25
BH2732	8/\$96.00	BHDP8216N	\$2.95
BH2716	8/\$48.00	BHDP8224N	\$3.25
BH2708	8/\$20.00	BHDP8224-4N	\$9.95
		BHDP8226N	\$3.50
		BHDP8228N	\$5.55
		BHDP8238N	\$5.55
		BHNS8250N	\$15.85
		BHNS8251N	\$7.50
		BHNS8253N	\$17.95
		BHNS8255N	\$6.80
		BHNS8257N	\$16.45
		BHNS8259N	\$18.00
		BHNS8259H	\$59.95
		BHNS8275H	\$59.95
		BHNS8279H	\$24.95

FLOPPY DISC CONTROLLER

BHAY51013A	\$5.95	BHF01771B-01	\$24.95
BHTR1602B	\$4.95	BHF01791B-01	\$44.95
BHTR1863	\$6.95		
BHIM6402	\$7.95		

PROTECT YOUR INVESTMENT! PROTECT YOUR DATA WITH



With Built-In Noise Filters and Surge Suppressors



USE THE GSC ISOBAR TO ISOLATE: Microprocessor from peripherals - Lab instruments from noisy equipment - Sensitive pre-amp or tape deck from power amplifier.

THE GSC ISOBAR ELIMINATES: Equipment interaction - Equipment damage from power line spikes and surges - Errors - False printouts - Disk Skips - Audio or video hash

FEATURES: Inductive isolated ground - Sockets individually filter isolated - Circuit breaker protected at 15A.

VOLTAGE TRANSIENT SPIKE PROTECTION: 2000 A peak for up to 6 Sec duration spikes. 1000A, 8/20 Sec protection from repeated spikes.

LOAD HANDLING: 1875 W max. total load; 15A per socket. INPUT: 125 VAC, 15 amps; standard 3-prong plug.

IBAR 3 - Three common outlets built-in circuit breaker, pilot light, hang-up bracket and a 6-foot cord.

Part No.	Sh. Wt.	List Price	Our Price
BHG0FIBAR3	3 lbs.	\$59.95	\$42.00
IBAR 46 - Four independently isolated outlets. Built-in 15A breaker, pilot light, switch, and 6-foot cord.			
BHG0FIBAR46	4 lbs.	\$79.95	\$48.85
IBAR 86 - 8 outlets, grouped to form 4 independently isolated sets of two. Built-in 15A circuit breaker, on/off switch, pilot light.			
BHG0FIBAR86	5 lbs.	\$84.95	\$54.95
IBAR 88M - Eight rear-mounted outlets grouped to form four independently isolated sets of two, plus one non-isolated convenience outlet on front face. 19" rack mount cabinet. Built-in 15A circuit breaker, pilot light, on/off switch, and 6-foot cord.			
BHG0FIBAR88M	6 lbs.	\$99.95	\$74.95

RS232 Breakout Box

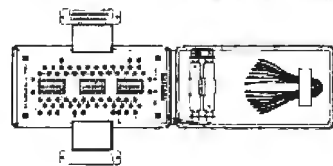

A must for every technician, repair man or systems integrator

Databox is contained in a tough, plastic case and is powered by two 1.5 volt penlight batteries. No power is consumed by the tester when not in use. Dimensions: 2.9" x 5.55" x 1.45". Weight: 10 oz. w/batteries
BHDNM23280X \$190.00 \$159.00

Ti SPECIAL PURCHASE GUILD 16 PIN LOW PROFILE IC, C95 SOCKETS

BHTIG16LP	package of 100	\$16.00
BHTIG16LP	package of 1000	\$120.00

OEMS Stock up at this low price!

ELECTRONICS

HATSWORTH, CA 91311

ORDER TOLL FREE (800) 423-5922 -

AK, HI CALL (213) 709-5464

Terms: U.S. VISA, MC, BAC, Check, Money Order, U.S. Funds Only, CA residents add Sales Tax. MINIMUM PREPAID ORDER \$15.00. Include MINIMUM SHIPPING & HANDLING of \$3.00 for the first 3 lbs., plus 25¢ for each additional pound. Orders over 50 lbs. sent freight collect. Just in case, please include your phone number. Prices subject to change without notice. We will do our best to maintain prices through August, 1982. Credit Card orders will be charged approval fee. If you see any error in our Engineering Dept. please call (213) 709-5464.

INCREDIBLE? BELIEVE IT!

Washington Computer Services

an affiliate of **WASHINGTON ELECTRIC COMPANY** est. 1912
INCORPORATED

CUSTOM COMPUTER ROOM WIRING SINCE 1960

97 Spring Street, New York, New York 10012

TO ORDER: CALL OUR TOLL-FREE NUMBER: (800) 221-5416 In N.Y. State and for technical information: (212) 226-2121

HOURS: 9 AM-5:30 PM (EST) Monday-Friday TELEX: 12-5606 CABLE: WASHCOMP NYK

PRINTERS

 Teletype 40, 300 LPM-typewriter quality, RS-232 interface. This quality printer is available in many configurations including forms access, quietized case, etc. from Only \$3200

Teletype 43 from \$995

Teletype AP-200, 340 cps dot matrix (similar to Data Prod. M-200) \$2799

NEC Spinwriter-55 cps, bidirectional, letter quality R.O. 7710 \$2560 KSR 7720 \$2799

DIABLO 630-40 cps, bidirectional, daisy wheel, plot/graph \$2349

QUME Sprint 9/35 cps, daisy wheel \$1944

C. ITOH Starwriter, 40 cps, daisy wheel, F10 \$1550

EPSON MX-80, 100, 80 cps, 9x9 dot matrix \$CALL

ANADEX 9500/9501A, up to 200 cps, high resolution dot \$1451

DKIDATA Microline 82A \$525 Microline 83A \$799

TI-810, 150 cps, Basic \$1449 Package-CP,VFC \$1630

MANNESMANN MT 1705 200 cps, 7x9, 132 col \$CALL

TALLY MT 1805 200 cps, 7x9 + NLQ 40x18 matrix \$CALL

CENTRONICS 739 100 cps, nx9 dot matrix, Full Graphics \$567

122 120 cps, International set, Full Graphics \$987

DEC LA-34 \$1085

IDS PRISM, 132 col., color \$1785

Similar savings for our C. ITOH, NEC, QANTEX, DATA GEN. lines

TERMINALS

PMMI MODEM \$359

AMPEX DIALOGUE 30, 80, 81 *Lowest Prices* \$CALL

TELEVIDEO 910 C (multi-terminal) \$610

925C \$795

950C \$985

AMPEX Dialogue 81[™] \$799

SORDC IQ 120 \$618

HAZELTINE ESPRIT \$1575

DEC VT-100 \$669

WYSE WY-100 (ALTD5 1) **NEW!** \$894

Zenith ZT-1 80x24, autodial modem VT-52 \$669

Similar savings for our ADDS, HAZELTINE and LEAR SIEGLER lines



SOFTWARE

DBASE II	\$525	WORDSTAR	\$300
MBASIC-80	\$275	MAILMERGE	\$110
MBASIC COMPILER	\$316	DATASTAR	\$230
FORTRAN-80	\$349	CONDOR III	\$716
COBOL-80	\$574	MILESTONE	\$235
PL/1-80	\$425	SUPERCALC	\$221
PASCAL MT + V5.5	\$398	FMS-80	\$649
WHITESMITH'S C	\$660	SELECTOR V	\$396
CB-80	\$420	SPELLGUARD	\$236
PEARL (LEVEL 3)	\$549	SUPERSOFT	\$CALL
LIFEBOAT SOFTWARE	\$CALL	AMERICAN BUS. SYST.	\$CALL
PEACHTREE	\$CALL	ACCDUNTING PLUS	\$CALL
GRAHAM-DORIAN	\$CALL	BSTAM,BSTMS	\$200
STRUCTURED SYST.	\$CALL	VANDATA/DSBORNE	\$500
DBASE II	\$525	8" S DSS; Call For Other Formats	

8" DISK DRIVE SALE

8" SHUGART SA801R \$450 8" SHUGART SA 851R \$669 2 for \$1289

QUME DATATRACK 8 \$550 2 for \$1050

Enclosure, power supply for 2 8" drives A & T \$350

MORROW DISCUS 2D + CP/M[®], MICROSOFT BASIC, CONT. \$950

HARD DISK SPECIALS

CORVUS 5MB, 10MB, 20MB Constellation Multiplexer and Mirror Backup

MORROW 26MB + controller + CP/M 2.2[®], M basic \$4495 \$3821

controller, CDC Hawk Drive (5 fix, 5 rem) \$7995 \$6795

controller, Western Dynex (5 fix, 5 rem) \$5995 \$5099

 5 1/4", 8" and 14" Winchester/tape subsystems available

FULLY CONFIGURED BUSINESS SYSTEMS

The following are some examples of the fully assembled and tested business and scientific computer systems which we offer.

The Premier Multi-User Computer System

IMS 8000 SX, multi-user, multi-processor, turbo DOS \$CALL

CPM 2.2. FULL 2 YEAR WARRANTY!

INTERNATIONAL On-Site Service Contracts Available

Corvus Concept—68000, 32 bit, 256k, network. 15" 120x56

+ HiRes screen, W.P. software, CP/M Emulator from less than \$5000

 68000 16 bit multi-user UNIX V.7 \$CALL

 8086 16 bit, 128K RAM, Syst. #2 \$3499

Systems Group Call us for best prices on these high quality 2nd generation boards and systems.

 These high quality, reliable products have made CCS defacto industry standard for S-100 products

Assembled and tested: \$CALL

InterSystems Fast 6 Mhz, Cache Bios Computers \$CALL

ADVANCED MICRO DIGITAL Single Board S-100 Computers \$CALL

BODBOUT We offer generous discounts on the Compupro line of [™]fast, quality 8 and 16 bit boards

NorthStar ADVANTAGE & HORIZON \$CALL

NEC PC-8000 The Professional's Work Station.

APC-8086, 16 bit, 128K, 8" DRIVES, GRAPHICS \$CALL

ALTOS single and multi-user systems

MORROW DESIGNS Decision 1, CP/M Microsoft Basic, UNIX \$CALL

XEROX 820 Desktop computer-64K, 2 floppys. (CP/M avail.) List \$2995 \$CALL

Similar savings on the full lines of SSM, DELTA, OYNABYTE, TELEVIDEO, DIGIAC, ZENITH, ADDS, DEC, DATA GEN., ATARI, TECMAR AND MANY OTHERS

PLEASE! Do not confuse us with mail order dealers. We are a full service distributor serving the data processing & installation needs of business & industry from micros to mainframes. System houses, Educational institutions & governmental agencies given special consideration.

N. Y. State agencies, municipalities, and schools — call us for information on our O.G.S. term contracts on hardware & software.

DEALER and INTERNATIONAL INQUIRIES WELCOME

For fast delivery, send certified check, money order or call to arrange direct bank wire transfer. Personal or company checks require two to three weeks to clear. Prices subject to change without notice; call for latest prices. Prices include 3% cash discount. N.Y. residents add sales tax. Qantex is a trademark of North Atlantic industries, Inc. Radio Shack[®] is a trademark of the Tandy Corp. CP/M[®] is a trademark of Digital Research. All sales subject to our standard sale conditions (available on request). Call for shipping charges. Above prices do not include customization or installation.

Unclassified Ads

WANTED: Software that will run on Cromemco 5-inch single-density systems. Need an RS-232C terminal for myself, less than \$500 please. I am also interested in any projects that use Cromemco's A/D-D/A board. John Hirst, POB 801, College Branch, TN 37115.

TRADE: Teledisk Model 2020 floppy-disk system with serial and modem ports to be used for data storage and entry at a remote terminal. Consider trades for 1200 bps modems, terminals, and the following Apple II cards: 80-column, 280 Soft-Card, 16 K RAM, serial, or SSM AIO. Mike Cariveau, C.E.D., POB J, Osseo, MN 55369, (612) 425-2181.

WANTED: The schematic for a Novation Model DC 101 A3 modem. Herbert Aldrich, 19 Churchill Dr., New Hyde Park, NY 11040.

FOR SALE: Two Alpha-Micro computer systems, each with double 8-inch floppy disks, four I/O serial ports and memory for four users, AM-100, AM-200, and AM-300. \$3500. Has Vector S-100 bus with 18 slots. Desire trade for LSI-1 system. Russell N. Cassel, 717 3rd Ave., Chula Vista, CA 92010, (714) 420-2764.

FOR TRADE: Public-domain software for Apple II and Sorcerer. Mrs. V. Mancuso, 25/2 Brown St., Newtown, 2042 Australia.

WANTED: To correspond with those interested in using micro-computers in Bible translation. Desire help in developing programs in BASIC or Pascal to manage culture files and dictionary, as well as word processing. I am especially interested in corresponding with someone who has used an Osborne I. Russell Reed, 84260 North Enterprise Rd., Pleasant Hill, OR 97401.

WANTED: Historic common stock price data for equity research project. Will share results with contributors. Robert W. Slemmer, 550 East Fourth St., Cincinnati, OH 45202, (513) 579-1000 or 231-1000.

FOR SALE: North Star Horizon computer 56K, SOROC IO-120 terminal, NEC Spinwriter printer Model 5510, double-density double-disk drive, and system software. Excellent condition, used very little. \$4000. John Vanderwoude, 2626 North Semoran Blvd., Winter Park, FL 32792, (305) 671-3700.

WANTED: High school student needs surplus, used, or damaged computers and related equipment. Will pay shipping costs. Richard Thompson, 127 West 19th St., McMinnville, OR 97128.

FOR SALE OR TRADE: GRI keyboard with 10 keys in case with parallel interface. Used one year and is in excellent shape. Vector Graphic Flashwriter: 16 by 64, S-100 video, works fine. Sell keyboard for \$75 and video board for \$125, or both for \$175. I pay shipping. David Getz, 13317 Broadmeade Ave., Round Rock, TX 78664.

FOR SALE: GE Terminus 300 letter-quality ASCII terminal, 110, 150, and 300 bps, uppercase and lowercase, RS-232 interface, extra ribbons, friction and tractor feeds, and service manual. Only \$480. Harold Wood, 2002 Rookwood Rd., Silver Spring, MD 20910, (301) 589-4171.

FOR SALE: Jade IOH-1046 S-100 I/O board. Works fine with IEEE-696 280 processor, but not with CCS 2810A. Will ship anywhere in the world for \$160, postage included. Rolf Aalberg, Riislokka 58, 1600 Fredrikstad, Norway.

FOR SALE: SwTPC CT-82 terminal, SwTPC 6800 computer, three 4K cards, GIMIX 16K card, AC-30 tape I/O, Exatron Stringy/Floppy/dual, SwTPC PR-40 printer and I/O, Witek 6800 processor card, TSC 6800 software, Computer Aid 3M3 data cartridge recorder—never used, and miscellaneous extras. Items in storage: used, functional, and clean. \$1000 takes all or offer. Please send SASE. A. N. Hicks II, POB 4508, Santa Clara, CA 95054.

FOR SALE: Digital Group peripherals. Three BK static-memory boards at \$65 each (or all three for \$150) Phi-Decks (4 + 1 spare), cabinet, cable, and controller card (in working order) for \$300. Graph-2 (Graphic-256) graphics board, partly assembled, for \$195. Carl Bignell, 600 Western Ave., Socorro, NM 87801.

FOR SALE: S-100 boards: Polymorphic VTI video interface, 64 by 16, graphics, keyboard port; \$125. BYTE 8080A processor; \$60. Vector Graphic 1702A PROM/RAM board with 1K RAM; \$50. Vector Graphic monitor PROM for Poly VTI and 8080 on three 1702As; \$30. Godbout 18-slot motherboard with seven connectors; \$35. 12-inch green P3 video monitor; \$50. Modular Devices power supply, regulated, OV, OC, MP, etc., +15 V @ 14 A, +5 V @ 16.5 A, -15 V @ 2 A, voltages can be changed; \$80. All working. Bob Kitzberger, 7668 Saratoga Rd., Cleveland, OH 44130, (216) 234-6441.

FOR SALE: Complete set of BYTE through August 1979 (plus December 1979, January 1980, and January 1981). Microcomputing from January 1977 to December 1980. 80 Microcomputing from January 1980 to December 1980. Personal Computing No. 1, October, November, and December 1980, and January to April 1981. Best offer for all (or sets) within 30 days after this issue of BYTE comes out. J. C. Madsen, POB 2005, Fresno, CA 93718.

WANTED: Software that will graphically display vortex rings in 3-D. Vortex motion is like a smoke ring that moves circularly and curls as it moves. T. Johnson, Devonshire B-3, Mankato, MN 56001.

FOR SALE: Percom data separator; \$20. 3G light pen for Model I. Plugs into processor or expansion interface. No battery needed. Plus software. \$20. First cashier's check takes either one. John Ratzliff, Mount Pisgah Academy, Candler, NC 28715.

FOR SALE: XTEL (RCA 141) 75 bps printer and Xerox I copier. Both new. Immediate sublease or direct sale on west coast only. Maintenance subcontract as is. Hanna, 5235 Toluca Court, Santa Barbara, CA 93111, (805) 967-1640.

WANTED: Contributions of computers, software, or whatever. Community Action Agency has been hard-hit by federal cuts and wants to computerize to better use existing funds to help poor and elderly. Will gladly accept any donations (tax deductible—we are a recognized nonprofit organization). Will work with manufacturers or dealers in testing, applications, etc. All letters answered. John R. Armstrong, Resource Coordinator, Springfield & Sangamon County Community Action Inc., 1101 South 15th St., Springfield, IL 62703, (217) 788-0757.

WANTED: To correspond with users of Thinker Toys keyed-up 8080 processor and Speakeasy I/O boards. Would like to swap hardware/software modifications and information. G. Seweryniak, 12 Kathy Dr., Poquoson, VA 23662, (804) 868-7682.

BUY SWAP SELL: Back issues of BYTE to complete my collection. Paul Gray, 780 West Main, Platteville, WI 53818.

FOR SALE: Back copies of BYTE from 1977 and 1978. 2 pounds each. K. Roche, 20 Stocker Close, Basingstoke, Hants, England.

SOFTWARE HELP: I will, at no charge, help solve your software problems. All programs will be written on an Apple II 48K 3.3 DOS system. I have three years of programming experience. I am most interested in solving high-resolution graphics problems. Scott Ayers, 432 Debby Lane, Montgomery, AL 36109.

FOR SALE: 36 issues of BYTE (December 1977 through November 1980) in good condition. Highest bid takes them; I'll pay shipping. Joe Wrobel, 233 El Mar Dr., Rochester, NY 14616.

FOR SALE: 32 K North Star memory boards with 100 hours use. Great buy at \$400 for reliable board. Money-back guarantee. Marcia, (404) 367-9191 after 5 p.m.

FOR SALE: NEW/DOS Plus for TRS-80. 40-track version with original documentation. \$40 ppd. TRS-80 and Other Mysteries. \$14 ppd. Also have many back issues of various computing magazines to trade. SASE gets current list or send your list along. Mel Mauck, 16 Edmondson Ave., Lexington, VA 24450.

FOR SALE: Two Siemens FD-100 floppy-disk drives with power supplies and cabinets. \$300 each. One TI-59 programmable calculator. \$135. R. Abbott, 414 Jackson Ave., Cape Canaveral, FL 32920.

FOR SALE: Due to TI-770 to 771 terminal conversion, the following TI computer parts are available in as-new condition: magnetic tape cartridge transport assembly and control board; main memory and memory-expansion board. Best offer. Edwin Langberg, 107 Fairway Terrace, Mt. Laurel, NJ 08054, (609) 778-0850 work, 983-8572 home.

FOR SALE: Exatron Stringy/Floppy with software; \$200 or best offer. Radio Shack direct connect module; \$100 or best offer. Jeff Madura, 2629 Covington St., West Lafayette, IN 47906, (317) 463-5218.

FOR SALE: S-100 bare circuit boards. SSM CB1A 8080 processor board, SSM VB2 video board, and Vector VCT8800V prototyping board. Manuals and many ICs and sockets included. \$50 takes all. M. Ingebreton, 247 Carolann St., Eyota, MN 55934, (507) 545-2931.

FOR SALE: Digital Group 280 with 64K. Audio cassette board. 20 parallel ports. Dual Phi-Deck tape drives. Full ASCII keyboard. Sanyo 9-inch monitor. Phimon 2.0, Business BASIC, assembler, disassembler, and much more software. Complete documentation. A postcard gets full details. \$2500 or best offer. Mel Hagen, 109 11th St. SE, Altoona, IA 50009, (515) 967-6362.

FOR SALE: Cromemco Z-2H computer with 10-megabyte hard disk, 64K RAM, two double-sided minifloppy-disk drives, 4-MHz 280 processor, two serial and two parallel I/O ports, 12-slot chassis, power supply (30 A @ 8 V and 15 A @ ±15 V), and a rack-mountable case. Also, CP/M-compatible operating system and other software. \$5000 or best offer. D. Schreier, 5301 Old Baumgartner Rd., St. Louis, MO 63129, (314) 773-0196.

FOR SALE: Shugart Model 850 8-inch floppy-disk drives: soft-sectored, IBM-compatible, double-sided, double-density. Unused. \$1050/pair. Dick Worban, (312) 735-2606.

FOR SALE: All brand new and unused. Unopened with original guarantees. Apple: Visicalc (retail \$200), \$140; Visifile (retail \$250), \$172; VisiTerm/Visiplot (retail \$260), \$181. Take all three and I'll pay shipping and reduce the total price by \$25. Desktop Plan II (retail \$200), \$140; Visidex (retail \$200), \$139.65; Visiplot (retail \$180), \$127; VisiTerm (retail \$150), \$118. Take all seven and I'll pay shipping and reduce the total by \$40. Visicalc (for Atari 800 or Commodore 2001, retail \$200), \$139.80. D. Solomon, 208 Overbrook, Freehold, NJ 07728.

WANTED: Programs, experiments, interfacing projects, games, etc., applicable to the Heathkit ET-3400 microcomputer trainer not already included in the EE-3401 home-study course. Charles Miller, Electronics Dept., Anne Arundel Community College, Arnold, MD 21012.

UNCLASSIFIED POLICY: Readers who are soliciting or giving advice, or who have equipment to buy, sell or swap should send in a clearly typed notice to that effect. To be considered for publication, an advertisement must be clearly noncommercial, typed double spaced on plain white paper, contain 75 words or less, and include complete name and address information.

These notices are free of charge and will be printed one time only on a space available basis. Notices can be accepted from individuals or bona fide computer users clubs only. We can engage in no correspondence on these and your confirmation of placement is appearance in an issue of BYTE.

Please note that it may take three or four months for an ad to appear in the magazine.

Unclassified Ads

FOR SALE: Ohio Scientific hardware. C2-8P with 20K (500, 520, 540 boards). Has 8-slot backplane, 32 by 64 display, separate keyboard, and RS-232C. Also, two 527 24K 2 MHz memory boards and 470 disk controller (new). Original prices were \$999 for C2-8P, \$450 for each memory board, and \$100 for the disk controller. Make an offer for some or all. Mike Bassman, 39-65 52 St., Woodside, NY 11377, (212) 639-3530 evenings.

WANTED: To get in touch with North Star users in the Reading, Allentown, and Harrisburg area. George Schemel, S.J., Jesuit Center, Box 223, Wernersville, PA 19565, (215) 678-3886.

FOR SALE: CB1A 8080 microcomputer with 1K RAM, 2K ROM monitor, and keyboard port. \$100. ID4 two parallel and two serial ports. \$90. Both boards are for S-100 systems, come with complete documentation, and work well. Steve Moore, 2541 Chestnut Court, Visalia, CA 93277, (209) 734-3969 after 6 p.m.

FOR SALE: Percom disk controller board and cable (for SS-50). \$125. Two SA-400 disk drives. \$225 each. Above as a package deal. \$550. Tim Tibbott, 1812F Woodmar Dr., Houghton, MI 49931, (906) 482-8806.

WANTED: A Dutronics Z80 board for a Processor Technology SOL-20 computer. The board and documentation are preferred, but I will accept just the documentation. Will pay a reasonable price. Rich Obermeyer, 2025 Hall, Santa Ana, CA 92704, (714) 730-2567 days.

FOR SALE: Two used IMSAI VDP-80. Both are in excellent physical condition. One operates, one does not. \$3750 or best offer. D. M. Sandler, 701 South 23rd St., Arlington, VA 22202, (703) 521-7800.

FOR SALE OR TRADE: SwTPC GT-6144 graphics terminal with power supply, enclosure, and documentation. Best offer or trade for two MP-LA or equivalent parallel interfaces for SS-50 bus. William E. Summers, 11 Homestead Ave., Southington, CT 06489, (203) 621-7001.

WANTED: Need documentation/manuals for a MITS Altair PROM programmer card #8800 PPRG-INT Rev. 0. Chris Lyons, 15620 North 24th Ave., Phoenix, AZ 85023, (602) 942-7224.

FOR SALE OR TRADE: A brand-new UDS 103 direct-connect answer modem. I will sell it or trade for an originate modem of similar type. I am also interested in software and hardware for the TI-99/4 computer and would like to correspond with other users. Ralph Fowler, 2348 Oriole Lane, South Daytona, FL 32019.

FOR SALE: Lear-Siegler terminal, Heath H-11 computer with 48K bytes of memory, two serial interfaces, parallel interface and extended arithmetic chip, and Heath H-27 dual floppy with FORTRAN and BASIC operating systems. Package price of \$5000. C. A. Potter, POB 266, Warren, MI 48090, (313) 574-9273.

FOR SALE: AJ-360 acoustic modem in good shape. \$100. IBM Selectric with solenoids in good shape. New York City area preferred. \$300. Mike Steckman, 215 West 91 St., New York, NY 10024, (201) 457-0511.

FOR SALE: Cromemco Bytesaver; \$100. Two IMSAI 1702 PROM boards, populated; \$300. Associated Electronics 1702 PROM programmer; \$200. IMSAI MIO; \$125. Micromation disk interface; \$325. Please write before sending money. J. Williams, 902 Anderson Dr., Fredericksburg, VA 22405.

HELP: Need schematics and information on International Computer Products (ICP) Digicorder dual digital cassette drive. Model #270. Stephen D. Hammack, 1618 South Highway 12J, Lewisville, TX 75067, (214) 221-3425.

WANTED: SwTPC MPA or MPA2 processor board. Also, MPB motherboard. Bare boards or assembled. Roger Steedman, POB 98, Bairnsdale, 3875 Australia, (051) 568291.

FOR SALE: Alpha Micro system. AM100 with 96 K memory, PerSci 277 1.2 megabytes dual floppy drive, SOROC IC120 terminal with 10-key pad, and TH-810 printer with miscellaneous software utilities. Asking \$5250. Jim Turner, 151 North Fourth St., Springfield, OR 97477, (503) 747-1261.

FOR SALE: Digital Group Version "A" printer (Practical Automation) with cabinet, cables, spares, and full documentation. The second to the top needle has worn out. I will provide a sample printout. 100 cps and capable of full dot graphics. Asking \$100 plus shipping. Larry Langrehr, 2069 North Humboldt Blvd., Chicago, IL 60647.

FOR SALE: BYTE from June 1980 through the current issue. \$30 or best offer. A. Williams, 47 Duffield Dr., South Orange, NJ 07079.

FOR SALE: 2012 A-4 static RAMs. Low power (40 mA) and fast (250 ns typical). \$9.60 per set of eight chips, sockets, and decoupling caps, or \$290 for all 32 K. Just buy a Wameco PC board and you're in business. Also, TI Silent 700 printer. Comes with all documentation, extra print heads, PC boards, and rolls of paper. \$200 plus shipping. J.C. Hassall, PO Drawer H, Blacksburg, VA 24060, (703) 552-0599 after 5 p.m.

FOR SALE: Paper Tiger 460G printer. Barely used. With graphics. Best offer over \$850. Valued over \$1300. E. Siguel, POB 5, Brookline, MA 02146, (617) 739-4887.

FOR SALE: Do you need a TV camera interface? Here is a fast Video Graphic board that could do the job. Three boards make a set: A/D, DMA, and D/A. New. \$900; sell for \$500 or best offer. Deluxe camera also available. Dan Fellers, 2512 Maryland, Topeka, KS 66605, (913) 232-4977.

WANTED: Professional programmer to implement CP/M for a Cromemco Z2D 48 K computer. Will pay reasonable charge. Billy Pinkerton, 33 West Strawbridge Apt. E9, Melbourne, FL 32901.

BOMB

BYTE's Ongoing Monitor Box

Article #	Page	Article	Author(s)
1	38	Program Generators	Stewart
2	57	High-Resolution Sprite-Oriented Color Graphics	Ciarcia
3	88	A Beginner's Guide to Logo	Abelson
4	116	Logo in the Schools	Watt
5	138	Designing Computer-Based Microworlds	Lawler
6	163	Why Logo?	Harvey
7	196	Introducing Logo to Children	Solomon
8	210	Logo—A Cultural Glossary	Goldenberg
9	230	Logo for the Apple II, the TI-99/4A, and the TRS-80 Color Computer	Williams
10	291	A General-Purpose I/O Board for the TRS-80 Models I and III	Barden
11	324	Learning Physics from a Dynaturtle	d'Sessa, White
12	325	Logo Music	Bamberger
13	328	Leading Fish to Water	Higginson
14	329	Logo Project PROKOP	Boecker, Fischer
15	330	The Group of the Turtle	Leron
16	331	The Lamplighter Project	Gorman
17	332	Logo Research at Bank Street College	Jewson, Pea
18	333	Young People's Logo Association	Muller
19	334	Logo Update	Lemmons
20	342	User's Column: Semidisk, Software Tools, the BDOS Blues, Power, and LISPs	Pournelle
21	366	The Commodore 8032 Business System	Dickerman
22	398	The Heath/Zenith Model 47 Dual Floppy-Disk Drive	Kern
23	408	Assisted Instructional Development System	Wolfe

Team Effort Wins BOMB

Christopher P. Kocher and Michael Keith's team effort in reviewing six new entries in the microcomputer arena in "Six Personal Computers from Japan" earned them the number one spot this time. Our congratulations to these authors for their report. They will share the \$100 prize. Second place goes to Steve Ciarcia for describing how to build a simple and inexpensive real-time clock in "Everyone Can Know the Real Time." He will receive \$50. And Steve Leibson's fourth part of his highly successful six-part I/O series, "The BCD and Serial Interfaces," brought him a close third.

Reader Service

Inquiry No.	Page No.	Inquiry No.	Page No.	Inquiry No.	Page No.	Inquiry No.	Page No.
1	47th STREET PHOTO 421	95	COMPUTER EXCHANGE 378, 379	*	HEATH COMPANY 320	273	MICRODYNAMICS 466
2	800 SOFTWARE 419	96	COMPUTER FURN. & ACCSS. 334	192	HERTZ CORP. 439	*	MICROHOUSE 12, 13
3	A.M.ELECTRONICS 30	97	COMPUTER INNOVATIONS 439	193	HEWLETT-PACKARD 27	274	MICROMAIL 96
4	A.S.T.RESEARCH 121	98	COMPUTER MAIL ORDER 326, 327	194	HYTOR, INC. 476	275	MICROPROCESSORS UNLTD. 478
5	AB COMPUTERS 477	450	COMPUTER PLUS 478	474	I.B.C. 33	276	MICROSOFT 21
6	ABM PRODUCTS 401	101	COMPUTER SHOPPER 433	476	I.B.C. 33	277	MICROSOFT 192
7	ACTION COMPUTER 119	102	COMPUTER SHOPPER 476	196	I.Q.SYSTEMS 47	278	MICROSTAT 123
8	ADV.COMP.PROD. 492, 493	103	COMPUTER SPCLISTS. 248, 249	197	I.T.A.T. ASSOCIATES 140	279	MICROTECH EXPORTS 356
9	ADV.MICRO DIGITAL CORP. 159	104	COMPUTER TOOLBOX, INC. 372	198	IBM 216, 217	280	MIKOS 316
10	ADV.SYS.CONCEPTS 470	*	COMPUTER WRHSE. 243	199	IMPERIAL MICRO SUPPLY 386	281	MILLARD, STEVE INC. 474
11	AEGIS SYSTEMS 482	105	COMPUTERS WHOLESAL 294	200	INMAC 419	282	MILLER MICROCOMP.SERV. 220
466	ALF PRODUCTS, INC. 151	106	COMPUTERTIME INC. 482	202	INSIGHT ENTERPRISES 480	283	MINI COMP.SUPPLIERS 415
12	ALIEN GROUP 415	*	COMPUTERWARE 429	203	INT'L SOFTWARE ALLIANCE 317	284	MINI MICRO MART 238
13	ALLENBACH IND. 144	108	COMPUTERWORLD INT'L. 147	204	INTEGRAL DATA SYS. 105	285	MINI MICRO MART 483
14	ALPHA BYTE COMP.PROD. 36, 37	109	COMPUTERWORLD INT'L. 213	204	INTERGRAND 260	286	MORROW DESIGNS 168, 169
15	ALPHA BYTE COMP.PROD. 205	110	COMPVIEW PROD. INC. 74, 75	153	INTELLIGENT ARTIFACTS 439	287	MOUNTAIN COMPUTER 19
16	ALPHA MICRO 350, 351	111	CONCORD COMP.PROD. 437	205	INTERACTIVE MICROWARE. 423	288	MOUNTAIN VIEW PRESS 357
17	ALSPA COMP.SYS. 39	112	CONCURRENT CORP. 176	206	INTERCONTN.MICROSYS. 383	289	MPC PERIPHERALS 113
18	ALTOS COMP.SYS. 124, 125	113	CONDOR COMP.CORP. 309	207	INTERFACE INC. 278	290	MTI SYSTEMS CORP. 272
19	AMEK CORP. 287	114	CONSUMER COMP. 276, 277	208	INTERSTATE TELEPHONE CO. 270	291	MULTITECH ELECTR. INC. 127
20	AMER.SMALL BUSN.COMP 355	116	CONTEXT MANGMNT.SYS. 22	460	INTERTEC DATA SYS. 11	292	MUSYS CORP 14
21	AMER.SQUARE COMP. 156, 157	117	CONTEXT MANGMNT.SYS. 23	*	INTEX SYSTEMS 162	294	NAT'L INTEGRATED SFTW. 32
22	AMERICAN MOTOR CORP. 298	118	CONTROL DATA 109	209	IOTC 474	295	NAT'L SOFTWARE SYS. 198
23	ANCIE LABS 423	119	COSMIC COMP.UNLTD. 474	210	IPEX INT'L. 466	296	NATIONAL TECH SALES 416
24	ANDERSON JACOBSON 433	120	CPU SHOP, THE 479	484	ICR FUTURESOF 237	297	NEBS 438
25	ANSWER IN COMPUTERS, THE 407	122	CREATIVITY UNLTD. 480	211	ISA CO.LTD. 400	55	NEC HOME ELECT. USA 231
26	ANTEX DATA SYS. 290	123	CREVELT COMP.SYS. INC. 476	212	ISE 254, 255	298	NEECO 343
27	APPARAT INC 48, 49	124	CROMEMCO CII, 1	214	J.C.SYSTEMS 427	*	NETRONICS 236
28	APPLE COMPUTER INC 136, 137	125	CROMEMCO 2	215	J.FISKE SFTW.SYS. 466	*	NETRONICS 481
29	APPLE COMPUTER INC 239	127	CUSTOM COMP.SYS. 221	216	JADE COMP.PROD. 485	300	NETWORK CONSULTING CORP 133
30	APPLEWARE, INC. 464	*	CYBERNETICS INC 53	217	JADE COMP.PROD. 486, 487	*	NEW GENERATION SYS. 262
31	APPLIED ANALYTICS 335	128	DATA ACCESS CORP 359	218	JAMECO ELECTR. 488, 489	302	NEW GENERATION SYS. 474
32	ASPEK INC. 470	129	DATA EXCHANGE 484	220	JDR MICRODEVICES 496, 497	303	NEW VISION 474
33	ARBA 126	130	DATA SOURCE SYS.CORP. 399	221	JDR MICRODEVICES 498, 499	304	NORTH STAR COMPUTERS 252
34	ARCHIVE 395	131	DATA-ED 40	222	JOURNAL OF PASCAL&ADA 361	486	NORTHWEST INSTR.SYS. 222, 223
35	ARTIFICIAL INT'L. RESRCH 478	132	DATA-RITE INDUSTRIES 367	223	KAI SYSTEMS 174	305	NOVATION 143
36	ASAP COMP.PROD. INC. 412, 413	133	DATAFACE 338	224	KRELL SOFTWARE 348	306	OASIS SYSTEMS 155
37	ASC ASSOCIATES 466	135	DATASMITH 435	225	KROWN COMPUTING 386	307	OMEGA SALES 152, 153
38	ASHTON-TATE 232, 233	136	DATASOUTH COMP.CORP. 271	226	LABORATORY COMP.SYS. 470	308	ORANGE MICRO 166
*	ASPEN SFTW.CO. 102	137	DATASOUTH COMP.CORP. 402	227	LABORATORY MICROSYS. 464	309	ORANGE MICRO 211
39	ATLANTIC CABINET CORP. 468	138	DAY STAR TECHNOLOGY 89	470	LANGLEY-ST.CLAIR 450	310	ORION INSTRUMENTS 470
40	AUDIO-LIGHT INC. 98	139	DAY STAR TECHNOLOGY 241	228	LANIER BUSN.PROD. 319	311	ORX SOFTWARE 302
41	AUTO-TROL TECH.CORP. 289	140	DEALIN' ELECTR. 466	229	LEADING EDGE PROD CIII	*	OSBORNE COMPUTERS 31
*	AVOCET 310	141	DELPHIC SYSTEMS 352	230	LEHMANN & ASSOC. 466	312	OSBORNE/MCGRAW-HILL 95
42	B&B ELECTR. 476	142	DELTA PRODUCTS 422	472	LEGEND INDUSTRIES 409	313	OSM COMPUTER 199
43	BAUSCH & LOMB INSTR.SYS. 15	24	DIGITAL DIMENSIONS 182	232	LNW RESEARCH 77	*	OWENS ASSOC. 346, 347
44	BAY TECHNICAL ASSOC. 417	143	DIGITAL EQUIPMNT.CORP 304, 305	233	LOGICAL DEVICES 442	314	PACIFIC EXCHANGES 376, 466, 470, 476, 482
46	BELL JOHN ENGR. 469	144	DIGITAL MARKETING 6	234	LOMAS DATA PRODUCTS 229	315	PALOMAR COMP.EQUIP. 500, 501
47	BINARY CORP. 484	145	DIGITAL MICROSYS 279	235	LYBEN COMP.SYS. 372	316	PAN AMERICAN ELEC INC. 429
48	BISON PRODUCTS 187	146	DIGITAL RESEARCH 35	236	LYBEN COMP.SYS. 464	317	PC* 112
49	BISON PRODUCTS 187	478	DIGITAL RESRCH COMP. 490, 491	237	LYBEN COMP.SYS. 468	318	PC CONNECTION 478
50	BISON PRODUCTS 187	147	DIGITAL WORD SYS 480	238	LYBEN COMP.SYS. 478	319	PC MAGAZINE 175
51	BISON PRODUCTS 187	148	DISCOUNT DATA FORMS 478	239	LYBEN COMP.SYS. 484	320	PCD SYSTEMS INC. 42
52	BIT 3 COMP CORP. 354	149	DISCOUNT SOFTWARE 337	*	M.I.A. 18	321	PEACHTREE SOFTWARE 184, 185
53	BLAIS COMPUTING INC. 474	149	DISTRIBUTED COMP.TECH 476	240	MACROTECH COMP.PROD. 45	322	PEGASUS DATA SYS 407
54	BLAT RESRCH & DEVELP. 411	150	DOKAY COMP.PROD. INC. 471	241	MACROTECH INT'L. 100	*	PERCOM DATA 7, 259
55	BOB'S CHARTS 478	151	DRAKE, R.L. CO. 430	242	MAGNETRONICS 372	323	PERIPHERALS UNLTD. 189
56	BOTTOM LINE, THE 251	152	DUAL SYS.CONTROL CORP. 349	243	MAGNOLIA MICROSYS. 376	324	PERIPHXP INC. 180
57	BOWER-STEWART 468	154	DYMARC IND. 403	244	MAILCOMP INC. 269	325	PERSONAL COMP.SYS 339
58	BRIDGE COMPUTER 179	155	DYSAN CORP. 312, 313	245	MANNESMANN TALLY 135	326	PERSONAL COMPUTER AGE 165
59	BUSINESS SOLUTIONS 425	156	EIZ ASSOC. 186	246	MARYMAC INDUSTRIES 411	327	PERSONAL SYS.TECHN. 275
64	BYTE BOOKS 463	157	EARTH SCIENCE ASSOC. 386	247	MASTER COMPUTING INC. 120	328	PHASE ONE SYS. INC. 341
*	BYTE BACK ISSUES 428	158	ECONOMY PERIPHERALS 464	248	MAXELL DATA PRODUCTS 103	329	PI-TECH 78
65	BYTE SUBSCRIBER 419	159	ECOSOFT 431	249	MAXTEK 434	330	PICKLES & TROUT 321
66	BYTEK COMP. SYS. 441	160	EDGE MICROSYS 484	250	MCGRAW-HILL BOOK CO. 167	121	POPULAR COMPUTING 225
67	BYTEWRITER 224	161	EDUCATIONAL MICROCOMP. 482	251	MEDIA DISTRIBUTING 393	331	POWER ONE 209
68	CALIF DATA CORP 468	162	EDUCATIONAL MICROCOMP. 482	252	MEMOREX MEDIA PROD. 201	333	PRACTICAL PERIPH. 24, 25
69	CALIF. DIGITAL 494, 495	163	EDUCATIONAL MICROCOMP. 482	253	MEMORY MERCHANT 9	333	PRIORITY ONE 502, 503
70	CDR SYSTEMS 484	164	ELECTROLABS 462	254	METACOMET SOFTWARE 132	334	PRIORITY ONE 504, 505
71	CENTENNIAL SOFTWARE 218	165	ELECTRONIC CONTROL 437	256	METASOFT CORP 426	335	PRIORITY ONE 506, 507
72	CHAPIN ASSOCIATES 484	166	ELECTRONIC SPCLISTS 401	488	METASOFT CORP 426	336	PROCESSOR INTERFACES INC. 468
73	CHATSWORTH DATA CORP 267	167	ELECTRONIC SYS.FURN 315	489	MFJ ENTERPRISES INC 228	337	PROFESSIONAL DATA SYS. 345
74	CHECK-MATE 464, 468, 476	168	ELLIS COMPUTING 384	257	MICRO AGE COMP.STORE 306	338	PROGRAMMERS SFTW. EX 10
75	CHECKS-TO-GO 363	169	EMPIRICAL RESRCH GRP. 150	258	MICRO ARCHITECTS-TX 474	115	PROMPT DOC. 311
76	CHIPS & DALE 476	170	ENERCOMP 484	260	MICRO BUSINESS WORLD 139	339	PROTECTO ENTERPR. 464
77	CHRISLIN INDUSTRIES 283	171	EPSON AMERICA 396, 397	261	MICRO BUSN.SFTW. INC. 447	340	PURCHASING AGENT THE 34
78	CMC, INT'L. 235	172	ESSEX PUBLISHING 433	262	MICRO CONTROL SYS. 181	341	QUADRAM CORP. 364, 365
79	COLONIAL DATA SERV. 134	174	EXPOTEK 206	456	MICRO COMP. SERV. CTR 423	342	QUALITY SOFTWARE 261
80	COLUMBIA DATA PROD. 129	175	F.T.G.DATA SERV. 464	261	MICRO DATA-TEK 435	343	QUASAR DATA PROD. INC. 265
81	COLUMBIA MICROSYS. INC. 470	176	FIRST SYSTEMS 285	262	MICRO DEVELOPMENTS 257	434	QUBIE DISTRIBUTING 353
82	COMMODORE BUSN.MACH. 101	178	FORMULA INT'L. 322	454	MICRO EXPRESS 268	344	QUCES 244, 245
83	COMMUNICAL, INC. 158	179	FOURTH DIMENSION 93	480	MICRO MAGAZINE 480	345	QUENTIN RESEARCH INC 301
84	COMMUNICATION RESEARCH 266	180	FRANKLIN COMP.CORP. 114, 115	264	MICRO MANAGEMENT SYS. 417	346	QUEST ELECTR. 475
85	COMMUNICATIONS ELECTR. 465	181	FREDERICK COMP.PROD. 429	*	MICRO METRIC 415	347	QUINTREX, INC. 470
86	COMPONENTS EXPRESS 399	182	FUJITA, RICHARD & ASSOC 466	265	MICRO MINT 371	348	QUME CORP. 51
88	COMPUPUN 437	183	G & G ENGINEERING 173	364	MICRO MINT 482	349	R.C.ELECTRONICS 414
89	COMPULINK CORP. 188	184	G-H COMPUTER SYS. 484	266	MICRO PRINTER MKRTG 141	350	RACET COMPUTES 425
90	COMPUMOTOR CORP. 404, 405	184	GENERAL SOFTWARE INC. 462	267	MICRO PRO INT'L. 99	351	RADGO 427
91	COMPUPRO/GODBOU 97	185	GENSTAR REI SALES CO. 468	268	MICRO SCI 79	352	RADIO SHACK CIV
92	COMPUSERVE 295	186	GILTRONIX, INC. 470	269	MICRO TECHNOLOGY 484	353	RANA SYSTEMS 28, 29
93	COMPUTER AGE 403	187	H&E COMPUTRONICS 381	270	MICRO WORKS, THE 427	355	RCA SOLID STATE 73
94	COMPUTER CHANNEL 431	188	HAVA COMPUTER 417	271	MICRO-BAUD, INC. 480	356	RCE 435
95	COMPUTER DYNAMICS 482	189	HAYDEN BOOK CO INC 203	272	MICROCOMP.BUSN.IND. 273	357	RED BARON COMP.PROD. 148, 149
		190	HAYES MICROCOMP.PROD. 161			358	S C DIGITAL 292

To get further information on the products advertised in BYTE, fill out the reader service card with your name and address. Then circle the appropriate numbers for the advertisers you select from the list. Add a 18-cent stamp to the card, then drop it in the mail. Not only do you gain information, but our advertisers are encouraged to use the marketplace provided by BYTE. This helps us bring you a bigger BYTE. The index is provided as an additional service by the publisher, who assumes no liability for errors or omissions. *Correspond directly with company.

Reader Service

Inquiry No.	Page No.	Inquiry No.	Page No.	Inquiry No.	Page No.	Inquiry No.	Page No.
* SINCLAIR RESEARCH 82, 83, 303		386 SUPERSOFT 208		231 TEXAS INSTRUMENTS 55		422 VYNET CORP. 411	
369 SLUDER 10		387 SYNCOM SYSTEMS 26		406 THREE M COMPANY 145		423 WARN ELECTRONICS 468	
370 SMOKE SIGNAL BRDCSTG 41		388 SYSCON CORP. 52		407 THREE M STATIC CONTROL 318		424 WASHINGTON COMP.SERV. 508	
371 SOFTECH CONSULTANTS 466		389 SYSTEM SOLUTIONS 376		408 THUNDERWARE 111		425 WERTHEIM & CO. 340	
373 SOFTECH MICROSYS 191		390 SYSTEMED 474		* TINNEY,RBT.GRAPHICS 391		426 WESPER MICROSYSTEMS 8	
374 SOFTECH MICROSYS 193		392 SYSTEMS PLUS INC. 131		409 TNW CORP. 361		427 WEST STAR MICRO 332	
375 SOFTECH MICROSYS 194, 195		393 SZ SOFTWARE SYSTEMS 468		410 TRANSNET CORP. 399		428 WESTERN WARES 470	
376 SOFTWARE DISTR. 389		394 TARBELL ELECTR. 401		411 TRISTAR DATA SYS. 360		429 WESTINGHOUSELIGHTING DIV 190	
377 SOFTWARE HOUSE,THE 373		395 TATUM LABS 484		412 U.S. MICRO SALES 472, 473		* WHITESMITHS LTD 202	
378 SOFTWEST PROD. 476		396 TECH-DATA 480		413 US ROBOTICS 108		431 WINCHENDON GRP.,THE 480	
468 SONICS MICRO SYS 444		* TECHNICAL SYS.CONSLTNS. 314		414 UNISOURCE ELECTR.INC 80		432 WINTEK CORP. 464	
* SOLID STATE SALES 436		TECMAR INC 263		416 VERBATIM CORP 71		433 WINTERHALTER & ASSOC. 425	
464 SPECTRA MARKETING 234		TECMAR INC 369		462 VICTOR BUSN.MACH. 280, 281		435 WW COMPONENTS SUPPLY 467	
379 SSM MICRO COMP PROD 407		* TEKTRONIX INC. 81		417 VIDEX 17		* XITEN SYSTEMS 377	
* STACKWORKS 440		400 TELETEK 183		* VISICORP INC. 207		436 XAVAX CORP. 118	
380 STANDARD SFTW.CORP. 16		401 TELEVIDEO INC 296, 297		418 VISTA COMPUTER CO 177		482 YORK-10 480	
381 STATIC MEMORY SYS 387		402 TERCER MEDIO 385		419 VISTA COMPUTER CO 177		437 ZEPHYR INC. 480	
383 SUBLOGIC 264		403 TERMINALS TERRIFIC 128		420 VISTA COMPUTER CO 177		438 ZOBEX 227	
384 SUNNY INT'L. 403		404 TERRAPIN INC. 293		421 VOTRAX 171			
385 SUNTRONICS 478		405 TEXAS COMP.SYS. 375		* VR DATA 219			

*Correspond directly with company.

National Advertising Sales Representatives:

Northeast (617) 444-3946
ME, NH, VT, MA, CT, RI, DE, MD, VA,
WV, OK, TX, Upstate NY, Eastern
Canada

Hajar Associates
280 Hillside Ave.
Needham Heights, MA 02194

Mid Atlantic (201) 741-7744
NY, NYC, NJ, PA

Hajar Associates
321 Broad St.
Red Bank, NJ 07701

Southeast (305) 628-3525
NC, SC, GA, FL, AL, MS, TN,
KY, LA

Hajar Associates
Diplomat Bldg.
5400 Diplomat Circle
Suite 205
Orlando, FL 32810

Midwest (312) 966-0160
MN, WI, MI, IA, IL, IN, OH,
MO, NE, KS, ND, SD, AR

Hajar Associates
5225 Old Orchard Rd.
Suite 50
Skokie, IL 60076

Northwest (415) 964-0706
AK, HI, WA, OR, ID, MT, WY,
Northern California, Nevada Ex-
cept Las Vegas, Western Canada

Hajar Associates
1000 Elwell Ct.
Suite 124
Palo Alto, CA 94303

Southwest (714) 540-3554
UT, CO, AZ, NM, Las Vegas,
Southern California

Hajar Associates
3303 Harbor Blvd.
Suite H-4A
Costa Mesa, CA 92626

European Advertising Sales Representatives:

Mr. Simon Smith
McGraw-Hill Publishing Co.
34 Dover St.
London W1X 3RA
England
01 493 1451

Mr. Andrew Karnig
Andrew Karnig & Associates
Kungsholmsgatan 10
112 27 Stockholm, Sweden
08 51-68-70

Mr. Hans Csokor
Publmedia
Relsnerstrasse 61
A-1037 Vienna, Austria

Mr. Fritz Krusebecker
McGraw-Hill Publishing Co.
Liebigstrasse 27C
D-6000 Frankfurt/Main 1
West Germany
72-01-81

Mr. Michael Sales
McGraw-Hill Publishing Co.
17 rue Georges Bizet
F 75116 Paris
France
720-33-42

Mr. Elio Gonzaga
McGraw-Hill Publishing Co.
Via Bracchini 1
20123 Milan, Italy
88-90-617

Mrs. Gurit Gepner
McGraw-Hill Publishing Co.
115 Yosephal St.
Bat Yam, Israel
866-561

BYTE

SUBSCRIPTIONS

For a subscription to BYTE, please complete this card.

Name _____

Address _____

City _____

State _____ Zip _____ Country _____

Card No. _____

Expiration date _____

Four digits above name—Master Charge only _____

Signature _____ Date _____

Please allow eight weeks for processing. Thank you.

USA

Canada
Mexico

- 1 year
 2 years
 3 years

- \$19
 \$34
 \$49

- \$21
 \$38
 \$55

- \$43 Europe (air delivery) payment enclosed
 \$35 Elsewhere (surface mail) payment enclosed

(Air mail rates available upon request)

Please remit in US funds drawn on a US bank. Thank you.

- Check enclosed (**Bonus:** [North America only] one EXTRA issue—receive 13 issues for the price of 12)



- Bill me (North America only)

4182

BYTE

SUBSCRIPTIONS

For a subscription to BYTE, please complete this card.

Name _____

Address _____

City _____

State _____ Zip _____ Country _____

Card No. _____

Expiration date _____

Four digits above name—Master Charge only _____

Signature _____ Date _____

Please allow eight weeks for processing. Thank you.

USA

Canada
Mexico

- 1 year
 2 years
 3 years

- \$19
 \$34
 \$49

- \$21
 \$38
 \$55

- \$43 Europe (air delivery) payment enclosed
 \$35 Elsewhere (surface mail) payment enclosed

(Air mail rates available upon request)

Please remit in US funds drawn on a US bank. Thank you.

- Check enclosed (**Bonus:** [North America only] one EXTRA issue—receive 13 issues for the price of 12)



- Bill me (North America only)

4182

Don't Miss An Issue!

Have BYTE delivered to your door.

Each month BYTE will bring you the latest in microcomputer technology.

DISCOVER and IMPLEMENT new ideas. Don't miss the original information presented in the pages of BYTE.

With BYTE you'll always be among the first to know about the important breakthroughs, worthwhile new equipment, and innovative projects in the world of computing.

CHALLENGE US to deliver the very best ideas in microcomputers and advanced technology to you. Return the attached card today!

Subscribe to BYTE—the world's leading computer magazine.

Note our special offer! Send cash with your order and receive 13 issues for the price of 12 for each year you subscribe. (North America only, please.)

PLACE
STAMP
HERE

BYTE SUBSCRIPTIONS
PO Box 590
Martinsville NJ 08836
USA

PLACE
STAMP
HERE

BYTE SUBSCRIPTIONS
PO Box 590
Martinsville NJ 08836
USA

THE LEADING EDGE IN PRINTERS

Finally, there's one full family of printers that covers every business or word processing application— all from C. Itoh, a company known for packing more product into less price, and all distributed exclusively by Leading Edge, a company known for searching out and providing that very thing. Which means that one call to one source can get you any printer, any time you need it, for any purpose.

THE PRO'S.

The Prowriters: business printers—and more. The "more" is a dot-matrix process with more dots. It gives you denser, correspondence quality copy (as opposed to business quality copy, which looks like a bad job of spray-painting).

Prowriter: 120 cps. 80 columns dot matrix compressable to 136. 10" carriage. Parallel or serial interface.

Prowriter 2: Same as Prowriter, except 15" carriage allows full 136 columns in normal print mode. Parallel or serial interface.



THE STAR.

The Starwriter F-10. In short (or more precisely, in a sleek 6" high, 30-pound unit), it gives you more of just about everything—except bulk and noise—than any other printer in its price range. It's a 40 cps letter-quality daisy-wheel with a bunch of built-in functions to simplify and speed up word processing.

It plugs into almost any micro on the market, serial or parallel.



AND THE MASTER.

The Printmaster F-10. Does all the same good stuff as the Starwriter except, at 55 cps, the Master does it faster.



Distributed Exclusively by Leading Edge Products, Inc., 225 Turnpike Street, Canton, Massachusetts 02021.
Call: toll-free 1-800-343-6833; or in Massachusetts call collect (617) 828-8150. Telex 951-624.

Circle 229 on Inquiry card.

SAVE \$361 RADIO SHACK PROFESSIONAL PRINTER



Now Only
Reg. 1160.00 **799⁰⁰**

Hurry—Sale Ends August 24, 1982

Add the Efficient Line Printer VI to Your TRS-80[®] Today!

Our most affordable professional-grade line printer is now even more affordable! We've slashed the price over 30% on the Line Printer VI. You can get fast reports and listings in your own home or office.



Protect Your LP VI with a Dust Cover (#26-507,\$5.95)

Seven-wire dot-matrix head is bi-directional and logic-seeking to maximize printing speed—100 characters per second, thirty-three 132-column lines per minute! It prints a full set of upper and lower case alphanumerics, plus European letters, symbols and block graphics in four software-selectable print densities.

Seven-wire dot-matrix head is bi-directional and logic-seeking to maximize printing speed—100 characters per second, thirty-three 132-column lines per minute!

The adjustable, removable tractor-feed (included) makes using fanfold paper a breeze, yet lets you convert to single sheets in seconds. You can use any size paper from 4" to 15" wide, original and two copies, and there's an automatic "paper-out" sensor. It's designed and built especially for connection to TRS-80 Model I, II, III and 16—just add a parallel interface cable. The Line Printer VI is on sale now at Radio Shack Computer Centers, stores and participating dealers nationwide.

Print Head: 7-wire, dot-matrix, bi-directional, logic-seeking.

Carriage: 15" wide, 132-columns at 10 cpi.

Character Set: Full ASCII English and European upper and lower case, plus symbols and graphics.

Print Density: 10 characters per inch; 5, 7.5, 15 cpi optional.

Print Speed: 100 characters/second; thirty-three 132-col. lines/minute, forty 80-col. lpm.

Manual Controls: line feed, 1/2 line feed, self-test, reset, on-line/off-line.

Radio Shack
The biggest name in little computers™
A DIVISION OF TANDY CORPORATION

Circle 352 on inquiry card.

Send me your free TRS-80 Computer Catalog.

Mail To: Radio Shack, Dept. 83-A-29
1300 One Tandy Center, Fort Worth, Texas 76102

NAME _____

ADDRESS _____

CITY _____ STATE _____ ZIP _____

Retail prices may vary at individual stores and dealers. Special order required at most stores.