

BYTE®

FEBRUARY 1983 Vol. 8, NO. 2
\$2.95 in USA
\$3.50 in Canada/£2.10 in U.K.
A McGraw-Hill Publication

the small systems journal

Exclusive! Apple Lisa and IIe Reviewed



STANDARDS



Z-80A
 64 K RAM
 390 K DISK DRIVE
 12" CRT
 COMPLETE SOFTWARE

\$1785

CROMEMCO



How to buy a computer by the numbers.

Introducing the Cromemco C-10 Personal Computer. Only \$1785, including software, and you get more professional features and performance for the price than with any other personal computer on the market. We've got the numbers to prove it.

The C-10 starts with a high-resolution 12" CRT that displays 25 lines with a full 80 characters on each line. Inside is a high-speed Z-80A microprocessor and 64K bytes of on-board memory. Then there's a detached, easy-to-use keyboard and a 5¼" disk drive with an exceptionally large 390K capacity.

That's the C-10, and you won't find another ready-to-use personal computer that offers you more.

But hardware can't work alone. That's why every C-10 includes software—word processing, financial spread sheet, investment planning and BASIC. Hard-working, CP/M[®]-based software that meets your everyday needs. Software that could cost over \$1000 somewhere else. FREE with the C-10. There's really nothing else to buy.

But the C-10's numbers tell only part of the story. What they don't say is that Cromemco is already known for some of the most reliable

business and scientific computers in the industry. And now for the first time, this technology is available in a personal computer.

One last number. Call **800 538-8157 x929** for the name of your nearest Cromemco dealer, or to request literature. In California call 800 672-3470 x929. Or write Cromemco, Inc., 280 Bernardo Avenue, P.O. Box 7400, Mountain View, CA 94039.

CP/M[®] is a registered trademark of Digital Research, Inc. All Cromemco products are serviced by TRW.

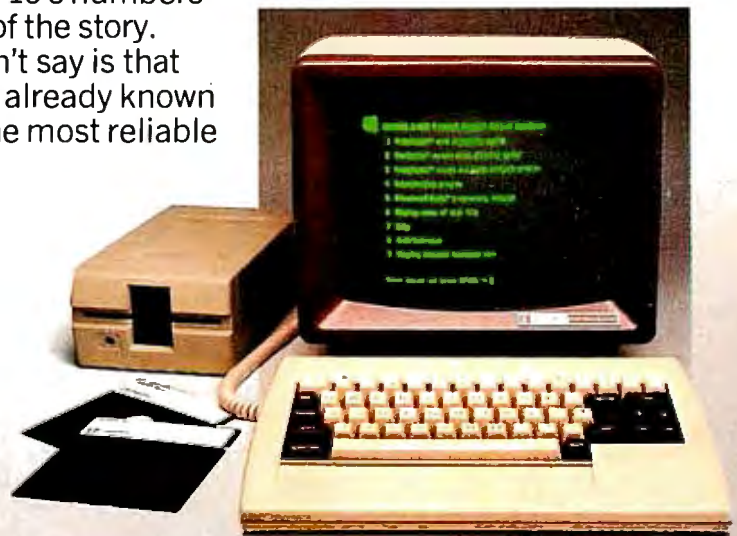

Cromemco
Tomorrow's computers today

Circle 126 on Inquiry card.

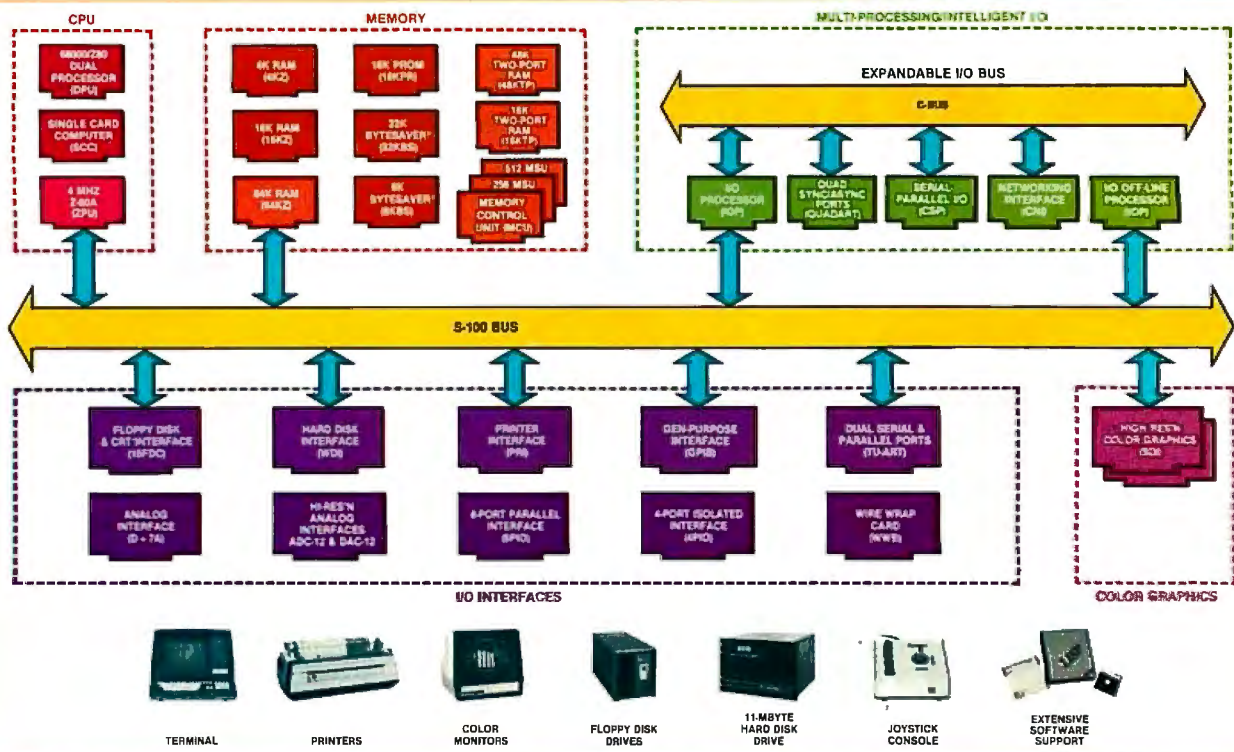

What Cromemco computer card capability can do for you

The above diagram shows in a functional way one of the most complete lines of computer cards in the industry.

Look it over carefully. It could be well worth your while.

These are all cards that plug into our S-100 bus microcomputers.

You can also assemble them into a custom system in convenient Cromemco card cages.

MULTI-PROCESSING AND INTELLIGENT I/O

The range of capabilities and versatility you can draw upon is enormous.

In processors, for example, you have a choice of CPU's including our extremely useful new I/O Processor. This can be used as a satellite processor to do off-line processing, multi-processing, and to form intelligent I/O. It opens the door to a whole new group of applications and tasks. Ask us about it.

HIGH RESOLUTION COLOR GRAPHICS

Again, you can have beautiful high-resolution color graphics with our color graphics interface. You can select from over 4000 colors and have a picture with a resolution at least equal to quality broadcast-TV pictures.



You have an unprecedented selection of memory including our unusual 48K and 16K two-port RAMs which allow high-speed color graphics.

LOTS OF STORAGE

These days you often want lots of disk storage. So you can select from our disk controller card which will operate our 5" and 8" floppy disk drives (up to 1.2 megabytes). Or select our WDI interface to operate our 11-megabyte hard disk drives.

POWERFUL SOFTWARE AND PERIPHERAL SUPPORT

There's much more yet you can do with our cards. And, of course, there's an easy way to put them to work in our 8-, 12-, and 21-slot card cages. Our PS8 power supply makes it simple to get the system into operation.

Finally, Cromemco offers you the strongest software support in the industry

with languages like FORTRAN, C, COBOL, ASSEMBLER, LISP, BASIC and others. There is also a wide choice from independent vendors.

To top it all off, you can draw from a substantial array of peripherals: terminals, printers, color monitors and disk drives.

There is even more capability than we're able to describe here.

NOW AT HALL-MARK AND KIERULFF

For your convenience Cromemco products are now available at Hall-Mark Electronics and Kierulff Electronics. Contact these national distributors for immediate product delivery.

CROMEMCO COMPUTER CARDS

- PROCESSORS — 4 MHz Z-80 A CPU, single card computer, I/O processor
- MEMORY — up to 64K including special 48K and 16K two-port RAMs and our very well known BYTESAVERS® with PROM programming capability
- HIGH RESOLUTION COLOR GRAPHICS — our SDI offers up to 754 x 482 pixel resolution.
- GENERAL PURPOSE INTERFACES—QUADART four-channel serial communications, TU-ART two-channel parallel and two-channel serial, 8PIO 8-port parallel, 4PIO 4-port isolated parallel, D+ 7A 7-channel D/A and A/D converter, printer interface, floppy disk controller with RS-232 interface and system diagnostics, wire-wrap and extender cards for your development work.



Cromemco™
Incorporated

280 BERNARDO AVE., MOUNTAIN VIEW, CA 94040 • (415) 954-7400
Tomorrow's computers today

Circle 127 on inquiry card.

Features

33 **The Lisa Computer System** by Gregg Williams / State-of-the-art hardware and software are combined in this new machine that literally anyone can use.

54 **Build a Handheld LCD Terminal** by Steve Ciarcia / A single-line display is quite adequate for many troubleshooting and monitoring applications.

68 **Apple's Enhanced Computer: The Apple IIe** by Robin Moore / For about the same price as the II, the IIe gives you a variety of exciting new features and capabilities.

90 **An Interview with Wayne Rosing, Bruce Daniels, and Larry Tesler** by Chris Morgan, Gregg Williams, and Phil Lemmons / Three key members of Apple's engineering staff discuss the development of the Lisa computer system.

118 **The Enhanced VIC-20, Part 1: Adding a Reset Switch** by Joel Swank / How to add a convenient feature to your VIC-20.

130 **The World of Standards** by Chuck Card, R. Donald Prigge, Josephine L. Walkowicz, and Marjorie F. Hill / The process for producing American National Standards is full of checks and balances.

146 **Welcome to the Standards Jungle** by Ian H. Witten / An in-depth look at the confusing world of computer connections.

182 **A Proposed Floppy-Disk Format Standard** by Chuck Card / A brief description of a proposed format that will allow you to interchange disks from several systems.

194 **The Proposed ANSI BASIC Standard** by Ronald Anderson / The committee asks for your opinion.

203 **NAPLPS: A New Standard for Text and Graphics, Part 1: Introduction, History, and Structure** by Jim Fleming and William Frezza / A close look at an important and controversial new communications standard.

256 **Realizing Graphics Standards for Microcomputers** by Fred E. Langhorst and Thomas B. Clarkson III / Use of the Virtual Device Interface graphics system will make portable graphics application software possible.

272 **The IEEE Standard for the S-100 Bus** by Mark Garetz / Standardization helps manufacturers design compatible components independently.

314 **Problem Oriented Language, Part 3: Assembling the Modules** by Mark Finger / The final segment of this article describes assembling the modules into a complete programming system.

347 **User's Column: Confessions, Pascal Prime, Wescon, and Perfect Writer** by Jerry Pournelle / Our resident critic comments on Wescon and text editors.

392 **Shape-Table Graphics for the TRS-80** by Dan Rollins / Draw complex shapes with a single command.

452 **Passing Untyped Parameters in UCSD Pascal** by Eliakim Willner / An assembler-language function and a "trick" combine in a parameter-passing method.

458 **A Terminal Program for the TRS-80 Model III** by Ralph L. James / A world of information is just a phone call away.

Reviews

302 The Scribble Text Processor by Christopher O. Kern

366 LDOS Utilities by Tim Daneliuk

Nucleus

6 Editorial: Standards: The Love/Hate Relationship

14 Letters

28, 127, 370, 433, 441 BYTE's Bits

370, 374 Book Reviews: 68000 Assembly Language Programming; A Practical Introduction to Computer Graphics

371 Technical Forum: The Magic of the Monte Carlo Method

378 System Notes: A High-Resolution Analog-to-Digital Converter for the TRS-80

428 BYTELINES

434 Event Queue

441 Books Received

442 Ask BYTE

444 Clubs and Newsletters

446 Software Received

468 What's New?

525 Unclassified Ads

526 BOMB, BOMB Results

527 Reader Service



Page 33

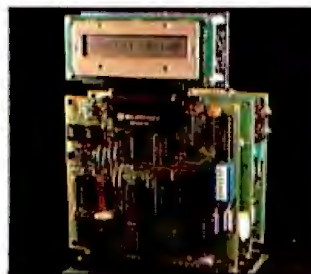

Page 54

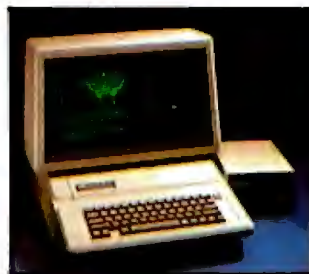

Page 68

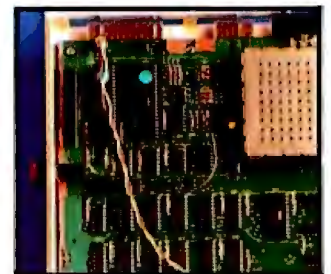

Page 118



Managing Editor

Mark Haas

Technical Editors

Gregg Williams, Senior Editor;
Richard S. Shuford, Curtis P. Feigel,
Arthur Little, Stanley Wszola,
Pamela Clark, Richard Malloy;
Phillip Lemmons, West Coast Editor; Steve
Ciarcia, Mark Dahmke, Consulting Editors;
Jon Swanson, Drafting Editor

Copy Editors

Beverly Cronin, Chief;
Faith Hanson, Warren Williamson, Anthony J.
Lockwood, Hilary Selby Polk, Elizabeth Kepner,
Nancy Hayes, Cathryn Baskin, Tom McMillan;
Margaret Cook, Junior Copy Editor

Assistants

Faith Kluntz, Beverly Jackson, Lisa Jo Steiner

Production

David R. Anderson, Assoc. Director;
Patrice Scribner, Jan Muller, Virginia Reardon;
Sherry McCarthy, Chief Typographer; Debi
Fredericks, Donna Sweeney, Valerie Horn

Advertising

Deborah Porter, Supervisor;
Marion Carlson, Rob Hannings, Vicki
Reynolds, Cathy A. R. Drew, Lisa Wozmak;
Patricia Akerley, Reader Service Coordinator;
Wai Chiu Li, Advertising/Production
Coordinator; Linda J. Sweeney

Circulation

Gregory Spitzfaden, Manager;
Andrew Jackson, Asst. Manager;
Agnes E. Pery, Barbara Varnum, Louise
Menegus, Jennifer Price, Sheila A. Bamford;
James Bingham, Dealer Sales; Deborah J.
Cadwell, Asst; Linda Ryan

Marketing Communications

Horace T. Howland, Director;
Wilbur S. Watson, Coordinator;
Timothy W. Taussig, Graphic Arts Manager;
Michele P. Verville, Research Manager

Controller's Office

Kenneth A. King, Asst. Controller;
Mary E. Fluhr, Acct. & DIP Mgr.; Karen
Burgess, Jeanne Cilley, Linda Fluhr, Vicki
Bennett, L. Bradley Browne, Vern Rockwell

Business Manager

Daniel Rodrigues

Traffic

N. Scott Gagnon, Manager;
Scott Jackson, Kathleen Reckart

Receptionist

aters

Virginia Londoner, Gordon R. Williamson;
John E. Hayes, Associate Publisher;
Cheryl A. Hurd, Publisher's Assistant

Officers of McGraw-Hill Publications Company: Paul F. McPherson, President; Executive Vice President: Gene W. Simpson; Senior Vice President-Editorial: Ralph R. Schulz; Vice Presidents: R. Bernard Alexander; Kemp Anderson, Business Systems Development; Shel F. Asen, Manufacturing; Harry L. Brown, Special Markets; Robert B. Doll, Circulation; James E. Hackett, Controller; Eric B. Herr, Planning and Development; H. John Sweger, Jr., Marketing.
Officers of the Corporation: Harold W. McGraw Jr., Chairman and Chief Executive Officer; Joseph L. Dionne, President and Chief Operating Officer; Robert N. Landes, Senior Vice President and Secretary; Ralph J. Webb, Treasurer.



In This Issue

Microcomputer enthusiasts have been eagerly awaiting the release of Apple's new machines, the Lisa and the IIe (featured in our cover photo by Mike Blake). Officially announced on January 19, these computers, especially the Lisa, are big news. Rumors have been rife about Apple's new products for quite a while, but now the speculation has come to an end and BYTE features three exclusive articles about them. Gregg Williams writes an in-depth description of "The Lisa Computer System," Robin Moore reviews "Apple's Enhanced Computer: The Apple IIe," and Chris Morgan, Gregg Williams, and Phil Lemmons interview three key members of the Lisa design team.

A boon to microcomputer users and a bane to many manufacturers, standards are a current hot topic within the computer industry. This month we feature several articles on the topic of standards, including "The IEEE Standard for the S-100 Bus" by Mark Garetz, "Realizing Graphics Standards for Microcomputers" by Fred E. Langhorst and Thomas B. Clarkson III, "A Proposed Floppy-Disk Format Standard" by Chuck Card, and part 1 of "NAPLPS: A New Standard for Text and Graphics" by Jim Fleming and William Frezza. Also featured this month: Steve Ciarcia tells how to "Build a Handheld LCD Terminal," Jerry Pournelle writes about "Confessions, Pascal Prime, Wescon, and Perfect Writer," and Joel Swank starts our new series on the Commodore VIC-20.

BYTE is published monthly by McGraw-Hill, Inc., with offices at 70 Main St., Peterborough NH 03458, phone (603) 924-9281. Office hours: Mon-Thur 8:30 AM - 4:30 PM, Friday 8:30 AM - Noon, Eastern Time. Address subscriptions, change of address, USPS Form 3579, and fulfillment questions to BYTE Subscriptions, POB 590, Martinsville NJ 08836. Second class postage paid at Peterborough, N.H. 03458 and additional mailing offices. USPS Publication No. 528890 (ISSN 0360-5280). Postage Paid at Winnipeg, Manitoba. Registration number 9321. Subscriptions are \$21 for one year, \$38 for two years, and \$55 for three years in the USA and its possessions. In Canada and Mexico, \$23 for one year, \$42 for two years, \$61 for three years. \$53 for one year air delivery to Europe. \$37 surface delivery elsewhere. Air delivery to selected areas at additional rates upon request. Single copy price is \$2.95 in the USA and its possessions, \$3.50 in Canada and Mexico, \$4.50 in Europe, and \$5.00 elsewhere. Foreign subscriptions and sales should be remitted in United States funds drawn on a US bank. Printed in United States of America.

Address all editorial correspondence to the editor at BYTE, POB 372, Hancock NH 03449. Unacceptable manuscripts will be returned if accompanied by sufficient first class postage. Not responsible for lost manuscripts or photos. Opinions expressed by the authors are not necessarily those of BYTE. Entire contents copyright © 1983 by BYTE Publications Inc. All rights reserved. Where necessary, permission is granted by the copyright owner for libraries and others registered with the Copyright Clearance Center (CCC) to photocopy any article herein for the base fee of \$1.00 per copy of the article or item plus 25 cents per page. Payment should be sent directly to the CCC, 21 Congress St., Salem MA 01970. Copying done for other than personal or internal reference use without the permission of McGraw-Hill is prohibited. Requests for special permission or bulk orders should be addressed to the publisher.

BYTE® is available in microform from University Microfilms International, 300 N Zeeb Rd, Dept PR, Ann Arbor MI 48106 USA or 18 Bedford Row, Dept PR, London WC1R 4EJ England.

Subscription questions or problems should be addressed to:

BYTE Subscriber Service
P.O. Box 328
Hancock, NH 03449





Add Multi-Transparency Color Graphics to Your S-100 or Multibus System

The system builder's best choice for color graphics is a CS5000 color system from SCION. Its basic component is MicroAngelo[®], the single board graphics display computer that has revolutionized monochrome display capability with low cost 512x480 pixel graphics resolution and 40 line by 85 character text capacity.

When MicroAngelo boards are combined, they create high resolution color graphics that have a unique advantage. The displayed image is a combination of transparencies. So you can add, modify or delete images by transparency rather than as an entire image.

SCION's Series CS5000 builds an image with up to 8 bit planes, each generated by a MicroAngelo board. You select the assignment of those bit planes to transparencies. Each transparency can display $2^n - 1$ colors where n is the number of bit planes it uses... 2 bit planes would make a three color transparency, 8 bit planes would make a 255 color transparency. Once each transparency has been defined, your host can work with it independently, generating and modifying its graphics and text without interacting with the others. The independent transparencies are combined by the Color Mixer board which also assigns one of 16.8 million possible colors to each color of each transparency.

Your computer talks to the SCION Color System in SCREENWARE[™], SCION's high level display firmware language. SCREENWARE commands are used by the computer in each MicroAngelo bit plane to generate graphics and text primitives. User interface is made simple with prompted system set-up using SCION's ColorPak.

MicroAngelo based color graphics systems are easy to use. Just plug the boards into your Multibus or S-100 host. Or use the freestanding work station configuration with its RS-232 interface. In each case, you get high resolution color graphics for such a low price you can't afford to design your own.

Think SCION for your graphics display needs. Think MicroAngelo. Call us at (703) 476-6100.

System shown is a Model CS5050S.
*A trademark of Intel Corp.

SCION

if the image is important.

12310 Pinecrest Rd./Reston, VA 22091
(703) 476-6100 TWX: 710-833-0684

MILESTONE[®] WHEN TIME IS MONEY



As a project manager, you know the value of meticulous planning. Oversights and miscalculations can cost you crucial time and money.

Milestone is a project management and time scheduling program. It is a powerful "critical path" program for planning and analyzing virtually any project, from a cost estimate for a construction project to a schedule for installing a computer system. The applications are unlimited.

Milestone uses PERT, Performance Evaluation and Review Technique, and CPM, Critical Path Method, to plan a project, yet Milestone is one of the easiest software packages to use.

The Milestone user can change a variable and instantly Milestone will display the effect on the entire project. For instance, the estimated completion date of a particular time-critical task may be changed. All scheduling, manpower costs and associated reports will be re-tabulated.

TIME IS MONEY. SAVE BOTH WITH MILESTONE.

The price is \$295. CP/M[®] and CP/M-86[™] versions require 64K and 128K RAM respectively. Manual alone is \$30.

For more information see your local computer dealer or contact Digital Marketing directly.

SOFTWARE
SOFTWARE
DIGITAL MARKETING
DIGITAL MARKETING[™]



DIGITAL MARKETING CORPORATION

2670 CHERRY LANE • WALNUT CREEK • CALIFORNIA • 94596
(415) 938-2880 • Telex: 17-1852 (DIGMKTG WNCK)

Dealer inquiries invited. Dealers outside California call
(501) 442-0864. Inside California call (415) 938-2883

Milestone is a registered trademark of Organic Software.

CP/M is a registered trademark of Digital Research, Inc.

CP/M-86 is a trademark of Digital Research, Inc.

Editorial

Standards The Love/Hate Relationship

Richard S. Shuford, Special Projects Editor

When you begin to study the history of technology, you learn about Eli Whitney's famous demonstration in 1801 of his mechanized process for making interchangeable firearms parts: the first successful attempt at industrial standardization.

Or so he claimed. According to Edwin Battison, director of the American Precision Museum in Windsor, Vermont, Whitney's demonstration was faked. To be sure, some gun parts were interchanged under the watchful eyes of United States War Department officials, but the parts had been specially made for the event by hand. Whitney couldn't deliver on the promises he made, and the 10,000 badly assembled muskets his company delivered (several years later) turned out to be the bane of the infantry.

The essence of this story may sound sadly familiar to computer users. Too often we see a computer product advertised as possessing a feature that incorporates some industry standard, but when it comes time to use the feature, we find annoying restrictions. Sometimes we have to pay more to get another feature that supports the standard feature, or the feature does not really work at all in the standard way. Disgruntled souls may conclude that the computer industry follows no standards at all.

Those of us who work with computers have a love/hate relationship with standards. According to Robert Rountree of the National Bureau of Standards, "Computer users love standards; computer manufacturers hate them."

How Standards Emerge

A standard, in theory, represents a consensus of expert opinion on how to perform a given technological function. The standards process, in the words of Dr. John A. N. Lee, vice-chairman of the Standards Committee of the ACM (Association for Computing Machinery), is "putting current technology into systematized form, available to everybody, and it's also developing a consensus in a peer-review process."

Some standards are born casually; others come into being after lengthy, formal give-and-take in carefully appointed committees. Many standards in the computer industry are de facto, that is, they emerged because one person or company invented a way of performing some function that has been near-universally imitated by everyone else in the industry. Other computer standards are devised formally by an accredited standards-making organization or by the government; many of these latter standards are compromises worked out among representatives of parties that originally invented incompatible methods of performing the same function.



We've Got More Than A Fond Attachment For Your ATARI We've Got A Disk Drive For \$488.

Percom Data Corporation believes your Atari® home computer is more than just fun and games. We believe you should be able to get a single-density, floppy-disk-system for your Atari 400 or 800 at a price that will take you into the future without knocking you into the next galaxy.

Percom Data has been manufacturing disk-drive systems, and other accessories for personal computers since the mid-1970's and is the industry standard to follow when it comes to data separation and system compatibility.

The Percom Data AT-88 combines Percom Data quality and reliability at a price that is not a budget-buster.

The Percom Data AT-88 offers 88 Kbytes (formatted) in single-density, with plug-in ease of attachment to your Atari. The AT-88 has integral power supply, "no-patch" to Atari DOS and critical constant speed regulation.

Take advantage of this low introductory price of \$488 by calling Percom Data now to get more information, or the name of an authorized dealer nearby. Call toll-free

1-800-527-1222

PERCOM DATA
CORPORATION

Expanding Your Peripheral Vision

DRIVES • NETWORKS • SOFTWARE

11220 Pagemill Road Dallas, Texas 75243 (214) 340-7081
1-800-527-1222

The most tempting approach to standardization is that of the "Lone Ranger." And it works, sometimes. In this approach, one individual, group, or company develops a method for performing a technological function, presents it to the world, and says, "Please do this my way." Occasionally a proposed standard graduates from Lone-Ranger status to general approval and use, but most such attempts languish in obscurity, unless the proposing person or organization has lots of clout, regardless of the technical merits of the proposal.

We find that technical merit often has nothing to do with whether one of several competing technological developments becomes an accepted standard. In standards work, to mix metaphors a bit, a bird in the hand is usually worth the whole ball game. The first product of a given type to achieve widest commercial distribution usually sets the standards. Thus, we have the S-100 bus (now the IEEE 696 bus) derived from the first successful microcomputer, and we have many de facto standards: the IBM 3740 disk format, Digital Research's CP/M-80 operating system, and Microsoft BASIC.

Pure political and financial muscle also helps establish a standard. AT&T will probably overwhelm all competition in videotex encoding with its NAPLPS (North American Presentation-Level-Protocol Syntax), which

was presented to ANSI (American National Standards Institute) on a silver platter for formal acceptance. Even for corporate giants having a bird in the hand helps. IBM will probably have no chance of getting its own graphics/videotex system adopted, simply because NAPLPS got there first.

Forces Hindering Standardization

It's fairly obvious why computer users like standards. Standards make their life easier in thousands of ways. But the reasons standards may be disliked by the people who make computers or peripherals are more obscure.

A creative engineer designing a new computer may feel that following a standard specification is too restrictive. And some companies fear that manufacturing standardized products makes for humdrum marketing and lack of attention from potential customers. They want to differentiate their products from what has gone before. Then, too, there are the costs involved in finding out what standards exist and are appropriate for a certain product, in obtaining the technical specifications and enforcing their use during the design phase, and in testing for compliance. Products designed before the standard was developed may prove difficult or prohibitively expensive to adapt. Furthermore, some existing standards were poorly thought out or froze technology before it matured. These and other reasons can discourage manufacturers from complying with standards.

As well, the making of standards themselves has its own problems and costs. Most American National Standards ultimately cost tens or even hundreds of thousands of dollars, either as direct or indirect expenses, to develop and distribute. Standards work is largely done by volunteers, and sometimes obviously useful efforts to develop standards are delayed or abandoned because of manpower shortages.

In addition to economic problems, the politics of decision making by committee and legal obstacles sometimes muddy the waters of standardization. The most dramatic example is the Supreme Court's ruling last year against the American Society of Mechanical Engineers (*Hydrolevel v. ASME*) that the Society was liable under antitrust law for abuses by its representative of its own standards-interpretation process. Although the *Hydrolevel* decision hung on the intentional abuse that occurred (it seems unlikely that a standards-making organization would have the same liability if its representatives acted in good faith), the case has caused some review of procedures in other organizations.

Another obstacle is time. The standards-making process is lengthy and slow. The amount of time required by ANSI for public comment and peer review is intended to prevent any abuse of ANSI's standard-making procedures, but it also drags out the process. Some individuals and organizations have tried, with varying degrees of success, different means of avoiding the slow ANSI procedures. One way to avoid having to make an

PROGRAMMERS FLIGHT SIMULATOR Apple II Plus DOS 3.3 48K



This total IFR System disk features gobs of menu selectable flight programs each with breath taking realistic picture graphics, moving scenery, airport approaches, holding patterns and much much more.

\$50.00 At your Computer Store or direct from
Visa Mastercard

Programmers Software
2110 N. 2nd Street
Cabot, Arkansas 72023
(501) 843-2988

Introducing SooperSpooler's™ Little Brother

Who knows spoolers better than Consolink? We pioneered this industry with our revolutionary SooperSpooler, the Intelligent Printer Interface.

Now meet the newest family addition:
MicroSpooler™

especially designed and engineered for those who need cost-effective solutions to their spooler requirements without sacrificing quality and sophistication.

No More Waiting on the Printer

The new MicroSpooler stores data and then feeds it to a printer as fast as the printer can handle it.

That means no down time: in a matter of seconds, your computer is free for the next job **without waiting** for the printer to finish the last job.

Quality, Reliability, Flexibility

As with the SooperSpooler, the new MicroSpoolers are the product of the highest engineering standards to insure trouble-free operation. Now Consolink offers a complete line of stand-alone spoolers that can be installed in-line between virtually any printer and any computer.

Easy to install. Easy to use. Easy on the budget.

Features include:

- 16K Memory: User or factory expandable to 32K or 64K
- Multiple Copy Function
- Status Readout: Tells you how much data is stored or how many copies are left to run
- Pause Function: To let you change paper, make adjustments
- Self-Test Routine: Performs a comprehensive check of most internal functions and memory
- Internal Power Supply: No bulky plug adapters
- Vertical Mount Configuration: Saves desktop space
- Plug-in connections to most computer combinations

- Independently Selectable Baud Rates on Serial Ports
- One Year Limited Warranty**
- Thirty-Day Money Back Guarantee**
- Four Models: Any Combination of Parallel or Serial I/O
- \$199 for 16K parallel to parallel unit with an internal power supply

And When You Need the Very Best...

Remember SooperSpooler, the Intelligent Printer Interface with a remarkable range of software controlled features and formatting capabilities.

See our new MicroSpoolers at quality dealers everywhere. For immediate answers to your questions, call Toll Free **800-525-6705**

**Spoolers by Consolink—
Now you have an Intelligent
Choice.**

Circle 89 on Inquiry card.

**CONSOLINK
CORPORATION**



**Without MicroSpooler
21 Minutes**

CPU time for 20 pages†
80 CPS Bidirectional



**With MicroSpooler
16 Seconds**

CPU time for 20 pages†

For immediate answers to your questions, call Toll Free: 800-525-6705

Consolink Corporation, 1840 Industrial Circle, Dept. MLI-200 Longmont, CO 80501 (303) 652-2014

*Formerly Compulink Corporation
**Consult your dealer or Consolink for details.

†60 lines per page, random line lengths, 40 char/line.
Assumes CPU can output text at a minimum of 3000 char/sec.

ANSI standard is to go through the IEEE (Institute of Electrical and Electronics Engineers). Although a member of ANSI, the IEEE has been developing standards on its own authority using its own committee process (sometimes a joint ANSI/IEEE standard emerges). IEEE standards have been well received by the industry, but even these typically take years to gel.

Contributions Are Needed

Are you now asking, "Can something be done to improve the standards process?" Yes, within limits.

Although the computer-standards community at first seems like an intimidating monolith, it is composed, for the most part, of men and women who are sincerely doing what they can to systematize the rapidly changing technology of computing. They possibly could use your help.

You can get involved in several ways. The simplest is to use existing standards in your current work and promote their use among your associates. When buying computer products, favor those that employ industry standards.

If you have expertise in a field where standards are being developed, you should obtain copies of the proposed standards documents during the public-comment period and send your written comments to the appropriate bodies (for a list of addresses, see page 142). If you are a member of a professional society, such as the IEEE or the ACM, you can work through your society, informing members of its standards committees about your preferences and telling them if you think certain new standards need to be made or old ones changed. This is especially important for those of us who work with microcomputers, because many of the members of formal

standards committees have experience only with larger computers.

Better yet, inquire about becoming a member of an appropriate committee. You can join the thousands of people working in the standards process and share their pride in helping to make advanced technology more available to everyone. ■

References and Periodicals

- American National Standards Cover the Wide World of Information Processing: SP X7J*. New York: American National Standards Institute. Copies available free from ANSI.
- American National Standards Institute Procedures for Management and Coordination of American National Standards*. New York: ANSI. Single copies free from ANSI.
- Catalog of American National Standards*. New York: ANSI, 1982.
- Catalog of EIA and JEDEC Standards and Engineering Publications*. Washington, DC: Electronic Industries Association, 1982.
- Folts, Harold C. (ed.) *McGraw-Hill's Compilation of Data Communications Standards*, Edition II. New York: McGraw-Hill Publications Co., 1982.
- Hill, I. D. and B. L. Meek. *Programming Language Standardisation*. New York: Halsted Press, John Wiley & Sons, 1980.
- Infocomm Standards*. Newsletter of information standards published by *Data Communications* magazine. McGraw-Hill Publications Co., 1221 Avenue of the Americas, New York, NY 10020.
- Morgan, Christopher P. "Can We Agree on Standards?" November 1981 BYTE, page 6.
- NBS Publications List 88: The Computer Science and Technology Series*. Washington, DC: Institute for Computer Sciences and Technology, National Bureau of Standards, 1982.
- NBS Update*. Biweekly newsletter of the National Bureau of Standards.
- Pittman, Tom. "A Recipe for Standards." April 1982 BYTE, page 26.
- Prigge, R. Donald, Marjorie F. Hill, and Josephine L. Walkowicz. *The World of EDP Standards*, 3rd ed. Blue Bell, PA: Sperry-Univac, 1978.

From the Publishers

These are exciting times for the microcomputer industry and for BYTE in particular. During 1982 the industry once again exceeded even the most optimistic predictions of economists, and the performance of BYTE exceeded even the most optimistic predictions of its management. Our audited paid circulation was 324,000 by year-end and we know that at least twice as many readers see each issue. The tremendous results that advertisers have obtained by placing their messages in BYTE magazine led to the first ever (according to some publishing industry commentators) 1000-page increase in a single year.

Fortunately, even if we were somewhat conservative in our predictions of BYTE's performance in 1982, we were aggressive in our efforts in maintaining the strength and quality of the BYTE staff. Nowhere is this more evident than in the BYTE editorial department which, of course, is solely responsible for the indisputable fact that BYTE has become the most respected and trusted voice in computer publishing.

It is because of our strong staff that we can calmly wish

Editor in Chief Chris Morgan the best of luck as he begins to devote the lion's share of his time to a new software company. Because Chris has planned out a year's worth of theme issues in advance, has guided the selection of specific articles for many months in advance, and has developed an editorial staff that for more than a year has produced editorial content up to the high standards for which BYTE has become famous (all this with Chris on the road much of the time), we can guarantee the continued unstinting editorial excellence you have come to expect in BYTE.

We remain guided by the thought expressed on the occasion of our fifth anniversary in September 1980: "Although the trappings of success are pleasant for us to contemplate, we would be foolish to forget the philosophy that has produced them: giving both readers and advertisers good value for their dollar."

Virginia Londoner
Gordon R. Williamson



TOUGH TO OUTGROW

It's no surprise so many businesses today are using our CompuStar® multi-user microcomputer. All sorts of businesses, those at the top and those on the way, know that only CompuStar can give them the big system performance they'll need as they grow. And they know that *only* CompuStar can deliver that performance at a fraction of the cost of most other systems.

CompuStar® solves the small business computer dilemma. It's ideal for those first time business users who need only single-user capability. But it's also perfect when those small businesses grow into large corporations. That's because CompuStar is *truly* expandable... all the way up to 255 workstations, each with its own processor and internal computer memory. And that means fast, fast response, even when many users are on-line at the same time.

Whether you're a small business with big plans or a big business with an eye for economy, CompuStar® has the performance and versatility that's tough to outgrow... the price/performance ratio that's impossible to beat!

STANDARD FEATURES

- 350K/750K/1.5 MB workstation disk capacities
- 64K RAM and twin processors in each workstation
- An easy-to-read 12-inch non-glare screen
- Operator convenience features - numeric keypad and visual text highlighting
- Microsoft® Basic
- CP/M1 operating software
- Truly multi-user and multi-processor

STORAGE OPTIONS

- 10 MB - compact, low-cost and tabletop
- 96 MB - 80 fixed and 16 removable megabytes
- 144 MB - reliable, rugged Winchester storage

CompuStar® is built and backed by the company that's been in the microcomputer business as long as microcomputers have been in business. Would you trust *your* business to anything less? CompuStar® Tough to beat. Tough to outgrow!

Microsoft is a trademark of Microsoft Corp.
Registered trademark of Digital Research.

**INTERTEC
DATA
SYSTEMS®**

CORPORATE HEADQUARTERS: 2300 BRIDLE RIVER ROAD • COLUMBIA, SOUTH CAROLINA 29210 • (803) 798-8100 • TWX 810-666-2115

GREAT PRICES!

COMPUTERS

TIMEX	\$89
FRANKLIN W /monitor	1098
VIC 20	189
CALIFORNIA	
COMPUTER SYSTEM	CALL!
INDUST. MICRO SYSTEMS	CALL!
MORROW MICRODECISION	CALL!

PRINTERS

Smith Corona TP-1	\$599
C Itoh PROWRITER-P	489
C Itoh PROWRITER-S	639
C Itoh PROWRITER 15"	789
C Itoh F-10	1399
C Itoh F-10 TRACTOR	229
OKIDATA 80	359
OKIDATA 82A	489
OKIDATA 83A	739
OKIDATA 84A	1179
IDS PRISM 132	1649
4 color, 200 cps, auto-sheet feeder, graphics	
IDS PRISM 80	1149
IDS MICROPRISM	599
ANADEX 9501	1299
MICROFAXER 32K S-S	229
MICROFAZER 32K P-P	199

TERMINALS & MONITORS

ADDS VIEWPOINT	\$559
AMDEK VIDEO 100	99
AMDEK VIDEO 100C	137
AMDEK VIDEO 300	179
AMDEK COLOR I	399
AMDEK COLOR II	719
TELEVIDEO 910	649
TELEVIDEO 912C	799
TELEVIDEO 920C	868
TELEVIDEO 925	825
TELEVIDEO 950	949

GAMES

SPACE CADET	\$29
SNACK ATTACK FOR IBM	39
NEMESIS	39
DUNGEON MASTER	39
ANALIZA II	39

APPLE HARDWARE

Videx VIDEOTERM	\$299
Videx KEYBOARD ENHANCER	119
Microsoft Z-80 SOFTCARD	279
Microsoft 16K RAMCARD	149
Microsoft PREMIUM PACK	599
Includes: Z-80 Softcard, 16K Ramcard, Videx Videoterm, and CPLM USER GUIDE.	
RANA I-163K	\$379
RANA II-326K	529
RANA III-652K	699
RANA with controller additional	99
Hayes MICROMODEM II	289
SVA 256K APP-L-CACHE	949
Mountain MULTI I/O	178
Mountain SUPERTALKER	262
M&R SUPERFAN	38
GRAPPLER PLUS	125
PKASO	135
CCS	129
Asynchronous interface	
CCS	149
Synchronous interface	
CCS Calendar Clock	105
CCS Printer Interface	129

IBM ACCESSORIES

Quadram 128K RAMCARD	649
Quadram 192K RAMCARD	749
Quadram 256K RAMCARD	829
Quadram Includes RS232, parallel port, real time clock	
Microsoft 64K RAMCARD	399
Microsoft 64K RAMCARD	599
Microsoft 192K RAMCARD	699
Microsoft 256K RAMCARD	799
Tandon SGL. SIDED FLOPPY	249
Tandon DBL. SIDED FLOPPY	289
Davong HARD DISK SYSTEM	1599

Maxell MD-1	\$31.25
Maxell MD-2	47.10
Maxell FD-1	41.50
Maxell FD-2	48.95

MISC. SOFTWARE

MATHEMAGIC	\$79
GRAPHMAGIC	79
DIAGNOSTICS II	84
DISK DOCTOR	84
UTILITIES I, II	53

WORDPROCESSING

WORDSTAR	\$279
MAILMERGE	149
SPELLSTAR	144
PERFECT WRITER	239
PERFECT SPELLER	139
WORD HANDLER	199
SPELLBINDER	279
SPELLGUARD	179
EASYWRITER II	269
EASYSPELLER	159
PIEWRIITER	123
WORD PLUS	129
MATHSTAR	99

DATA BASE MANAGEMENT

DBASE II	\$529
PERFECT FILER	279
EASYFILER	349
FMS 80	750
TIM III	399
FAST GRAPH	189
THE ANSWER	219
QUICKCODE	229
dUTIL	68
D GRAPH	239
DATASTAR	171
SUPERSORT	145
VISIFILE	228
VISIDEX	184

FINANCIAL SOFTWARE

EAGLE MONEY DECISIONS	\$119
SUPERCALC	189
PLANNER CALC	69
MASTER PLANNER	249
MULTIPLAN	219
PERFECT CALC	139
VISICORP VISICALC	184
DEKTOP PLAN	184
VISISCHEDULE	228
VISITREND / PLOT	228
SCRATCHPAD	259
STATSGRAPH	169

ACCOUNTING SOFTWARE

ACCOUNTING PLUS	\$385
ACCOUNTING PLUS II	299
For Apple II	
EASY EXECU. ACCOUNTING	579
TCS	79
THE HOME ACCOUNTANT	129
IUS-IBM ACCT. SYS.	CALL!

LANGUAGES

Microsoft BASIC COMPILER ..	\$299
Microsoft BASIC INTERPRETER	279
Microsoft FORTRAN 80	379
Microsoft COBOL 80	559
Microsoft muSIMP / mumATH.	199
Microsoft TASC	149
Supersoft ADA	269
Supersoft FORTH	149
Supersoft A.L.D.S.	99
Supersoft FORTRAN /RATFOR.	284
Sortim PASCAL M.	129
Whitesmith's C	690
Whitesmith's PASCAL	850

CALL TOLL-FREE
1-800-523-9511

1-215-868-8219

NEW PRODUCTS!

INFOSTAR

MICROPRO'S DATABASE MANAGEMENT SYSTEM NOT ONLY COMBINES THE ALREADY RENOWNED FEATURES OF DATASTAR AND SUPERSORT BUT ALSO FEATURES A REPORT GENERATOR. THIS MEANS YOU CAN ENTER, SORT, RETRIEVE, ORGANIZE, AND PRINT DATA QUICKLY AND EASILY...AND WITH NO NEED TO PROGRAM! BUT THAT'S NOT ALL...YOU CAN EDIT YOUR REPORTS WITH WORDSTAR, THE WORLD'S NO. 1 SELLING WORDPROCESSOR.

LIST PRICE: \$495.00

MICROHOUSE PRICE: CALL

T/MAKER III

WITH THE T/MAKER III YOU CAN EDIT YOUR TEXT, COMPUTE YOUR NUMBERS, TALLY YOUR RESULTS, AND PRODUCE FINISHED REPORTS EVEN IF YOU WANT IT ALL IN ONE FILE! T/MAKER III ALLOWS BAR CHARTING FROM A FULL ELECTRONIC SPREAD SHEET.

LIST PRICE: \$275.00

MICROHOUSE PRICE: \$245.00

RANDOM HOUSE ELECTRONIC THESAURUS

THE RANDOM HOUSE ELECTRONIC THESAURUS IS THE FIRST REFERENCE SOFTWARE THAT ALLOWS YOU TO DO "IDEA PROCESSING" WITHIN YOUR WORD PROCESSOR BASED ON THE POPULAR RANDOM HOUSE THESAURUS. IMPROVES YOUR WRITING SKILLS BY FINDING THE RIGHT WORD YOU NEED AND INSERTING IT IN THE TEXT.

LIST PRICE: \$150.00

MICROHOUSE PRICE: \$129.00

RANDOM HOUSE ELECTRONIC PROOFREADER

PROOFREADER ALLOWS ACCESS TO THE RANDOM HOUSE DICTIONARY WITH FULL INTERACTIVE CORRECTION TO CHECK ALL YOUR SPELLING ERRORS. IBM VERSIONS ALLOW ACCESS UP TO 32,000 AVAILABLE WORDS.

MICROHOUSE PRICE: \$50.00

GRAPHMAGIC

GRAPHMAGIC ALLOWS YOU TO DRAW VISUAL REPRESENTATIONS OF GRAMS AND LINE GRAPHS FROM SPREAD SHEET PROGRAMS INCLUDING MATHEMAGIC, SUPERCALC OR VISICALC.

LIST PRICE: \$99.00

MICROHOUSE PRICE: \$79.00

C. ITOH 1550

ANOTHER NEW PRINTER FROM C. ITOH WITH THE SAME GREAT QUALITIES AS ALWAYS BUT INTRODUCING A NEW WIDER CARRIAGE THAT CAN ACCOMMODATE PAPER SIZES UP TO 15" (132 COLUMNS). AVAILABLE IN BOTH SERIAL OR PARALLEL VERSIONS.

LIST PRICE: \$875.00

MICROHOUSE PRICE: \$789.00

WORDSTAR, DATASTAR, SUPERSORT, INFOSTAR ARE TRADEMARKS OF MICROPRO, INC. RANDOM HOUSE IS A REGISTERED TRADEMARK OF RANDOM HOUSE, INC. THE RANDOM HOUSE ELECTRONIC THESAURUS IS A TRADEMARK OF RANDOM HOUSE, INC., DICTRONICS PUBLISHING INC. EXCLUSIVE LICENSEE. TP-1 KS A TRADEMARK OF SCM, INC. IBM IS A REGISTERED TRADEMARK OF INTERNATIONAL BUSINESS MACHINES.

Prices may vary with different formats. All prices and specifications are subject to change without notice. Please call or write for specifics.

MICROLINESM

MICROHOUSE OFFERS 24 HOUR COMPUTER SHOPPING WITH MICROLINE. MICROLINE IS A COMPUTERIZED ORDER-ENTRY SYSTEM THAT ENABLES YOU TO ACCESS SPECIFIC INFORMATION ON OVER 1000 MICROCOMPUTING HARDWARE AND SOFTWARE PRODUCTS, IN ADDITION TO NUMEROUS SUPPLIES AND ACCESSORIES.*

1-215-868-1230

MICROLINE OPERATES AT 300 BAUD. 8 BITS, NO PARITY, 1 STOP BIT.

PRICES MAY VARY WITH DIFFERENT FORMATS. ALL PRICES AND SPECIFICATIONS ARE SUBJECT TO CHANGE WITHOUT NOTICE. PLEASE CALL OR WRITE FOR SPECIFICS.

1444 LINDEN ST./BOX 499 BETHLEHEM, PA 18016

DEALERS INQUIRIES WELCOME

Circle 272 on inquiry card.

WE WANT YOU TO KNOW ...

MICROHOUSE

For the Record

Peter Callamaras's review of our Executive Briefing System (November 1982 BYTE, page 164) was greatly appreciated here at Lotus. However, the article was incorrect in the At a Glance section, which listed Mitchell Kapor as the author of EBS.

While Mitchell designed the program and supervised its implementation, EBS was coded by Todd Agulnick, a 15-year-old resident of Newton, Massachusetts. Todd was first employed by Mitchell at the age of 12, and he continues to be a source of inspiration for all of us here at Lotus. His great skill and intellect are appreciated almost as much as his fine sense of humor.

Mary Lynn Davis, Graphics Project
Manager
Lotus Development Corp.
55 Wheeler St.
Cambridge, MA 02139

More on BASIC Standards

I read with interest Howard G. Drake's letter dealing with the current and proposed standards for BASIC (October 1982 BYTE, page 18) and wish to comment on two points raised in the letter.

First, the requirement to have DIM statements preceding their use in line-numbered sequence is not new. It has been in the ANSI (American National Standards Institute) Minimal BASIC Standard since the approval of that standard in January of 1978.

The requirement to recognize the existence of DIM statements in line-numbered sequence (rather than in logical sequence) stems from the desire to have the one BASIC program give the same result when that program is run under two implementations, one of which is an interpreter and the other a compiler.

Another point raised by Mr. Drake concerned the need for the interpreter to do a pre-scan in order to recognize the presence of DIM statements.

The X3J2 BASIC Committee was very careful to assure that a pre-scan was *not* required. The suggested technique when a forward transfer-of-control is indicated (as in Mr. Drake's example) is to examine the statements passed over "at the time that they are passed over," to see if they

include any of the statements that must appear in line-numbered sequence prior to their use. These statements include the DIM statement, as well as any OPTION statements (OPTION BASE, OPTION ARITHMETIC, etc.), and any function-definitions.

By taking this approach, BASIC processors need only look at those statements up to and including the one being referenced and need not do a pre-scan of the entire program.

I heartily agree that any interested parties should obtain a copy of the Proposed ANSI BASIC Standard, read it, and comment on it, if they find anything that they believe should be changed.

M. O. Duke
IBM
Santa Teresa Laboratory
555 Bailey Ave.
San Jose, CA 95150

Credit Where It's Due

I recently saw the October 1982 BYTE editorial in which Chris Morgan described videotex and teletext. I'd like to correct one statement regarding closed-captioning. The three networks broadcasting closed-captioned programs are PBS, NBC, and ABC; not CBS. CBS has steadfastly refused to provide captions on its programs for the benefit of hearing-impaired people.

Your omission of ABC is most unfortunate because that network was instrumental in the development of the closed-captioning technology. It leads the way in providing closed-captioning services. For example, ABC recently added closed captions to all broadcasts of ABC's "World News Tonight."

Jane Edmondson, Director
Products Promotion and Public Relations
National Captioning Institute
5203 Leesburg Pike, Suite 1500
Falls Church, VA 22041

This Thing Called NAPLPS

With regard to Chris Morgan's editorial discussing "This Thing Called Videotex" "Some Answers to Frequently Asked Questions," October 1982 BYTE, page 10), let me respond with one definition of what videotex is today.

The North American Presentation Level

Protocol Syntax (NAPLPS) allows text and graphics to be encoded in a manner independent of the display apparatus on which it will be presented. Virtually any micro-, mini-, or mainframe computer can be configured to generate NAPLPS pages, and any communications medium—whether it be telephone, broadcast, cable television, microwave, or satellite transmission—can be used.

What does this mean to microcomputer users today? Throughout North America microcomputers from virtually any manufacturer have a common format for text and color graphics that can be communicated universally. NAPLPS is a simple, highly efficient and economical color graphics generator in combination with a decoder. Here are some examples of what is being accomplished today:

- Users of Hewlett-Packard 80 Series, Commodore PET, and other microcomputers are now being offered a color-graphics program for Visicalc. The software digests raw Visicalc data files and automatically draws color charts and graphs including exploded pie charts.

- IBM Personal Computer users can obtain an electronic slide show program that simulates the 35-millimeter slide carousel but has additional features such as random-access retrieval of individual slides and the synchronizing of a sound track for a full audio-visual presentation. These slides can be displayed on a color monitor or even a large screen using a video projector.

- North Star computers are being used as hosts to drive large screen displays of electronic billboard advertising in shopping malls.

Other microcomputers are incorporating color graphics into computer-aided learning courseware and public-access market-research terminals, and marketing presentations are being prepared and, through the decoder, transferred onto video tapes.

Hard-copy service bureaus will soon be available that will provide any page creator the capability to download NAPLPS-encoded pages by telephone and have 35-millimeter slides, overhead transparencies, and other film media produced for them overnight and delivered the next day. Furthermore, paper hard copy is obtainable with the use of jet ink plotters—ideal for charts and graphs that



PrintMate™ 150

THE MOST ADVANCED PRINTER IN ITS CLASS.

Good news for microsystem and personal computer users! MPI offers four wide carriage printers with excellence in price and performance. The two "A" versions of PrintMate™ 150 feature a factory installed "SoftSwitch™" front panel keypad, with a 4K buffer on PrintMate™ 150 model A1 and a 16K buffer on model A2. PrintMate™ 150 models B1 and B2 are factory equipped with a 2K and 16K buffer, respectively. PrintMate™ 150 models have an exceptional set of outstanding graphics and font capabilities, optional expansion, and other advanced features that differentiate the PrintMate™ 150 from its competitive rivals as the superior performer. A bold claim? The strong and widespread acceptance of the excellent PrintMate™ 150 is based on outstanding user features:

HIGH SYSTEM THRUPUT—150 characters per second advanced logic seeking impact printing with an accelerated print head slew rate and turnaround makes PrintMate™ 150 a high speed performer.

WIDE CARRIAGE VERSATILITY—The PrintMate™ 150's wide carriage can accommodate print lines from 136 to 231 characters in length and can easily handle forms from 3' to 15 inches wide and as long as 31 inches.

LARGE SELECTION OF PRINT CAPABILITIES—The 7x9 dot matrix allows user selection

of 10, 12, 15 or 17 characters per inch or the 11x9 serif font provides document quality printing at 10 characters per inch.

"SoftSwitch™" FRONT PANEL CONTROL—The PrintMate™ 150 A models have SoftSwitch™ front panel keypads for externally changing forms length, print density, horizontal and vertical tabs, baud rate and character set. A simple "SoftSwitch™" entry will display the operating mode you have selected and PrintMate™ 150 responds to every entry with a pleasant tone of confirmation. With the "SoftSwitch™", you can turn off the printer—even unplug it—and PrintMate™ 150 will retain every detail in its non-volatile memory. The "SoftSwitch™" may be added to the PrintMate™ B models.

EXPANDABLE PRINT BUFFER—PrintMate™ 150 models A2 and B2 have a factory installed 16K buffer. Both the 4K buffer model A1 and the standard 2K buffer model B1 are optionally expanded in increments to 16K. The PrintMate™ 150's expanded buffer allows application extensions for high speed interleaved printing and spooling, greatly improving the host computer's performance in applications that are print bound.

DOWNLINE LOADABLE FONTS—The powerful microprocessor based command set of the PrintMate™ 150 allows a custom character set to be developed in the host computer and downloaded to any Print-

Mate™ 150 model with a 4K or larger buffer.

GRAPHICS—The standard graphics capabilities of all PrintMate™ 150 models allow printing of up to 6,120 individually addressable dots per square inch giving exceptional resolution for graphics and special characters.

PrintMate™ APPLICATIONS PACKAGES—Turn-key graphics and display fonts can be implemented with an extensive line of MPI supported and maintained AP-PAK™ applications packages providing specialized fonts, custom graphs, tables, and picture graphics. Specialized characters such as logos may be easily defined and edited for printing directly from your computer.

CONSIDER THE FEATURES—Only PrintMate™ 150 offers so many ways to get your message across: graphics; display fonts; downline loadable character sets; high print speed; advanced logic seeking; 15 inch wide carriage; a variety of forms and paper capabilities and; friendly "SoftSwitch™" interaction. The PrintMate™ 150 is the responsive performer that perfectly mates with your microsystem or personal computer. With prices beginning at \$995, it is evident that the PrintMate™ 150 is the superior performer in function and price.



The Printer People

™

Micro Peripherals, Inc.
4426 South Century Drive
Salt Lake City, UT 84107
Phone 1-800-821-8848

Circle 291 on inquiry card.

need to be inserted into textual reports.

Because NAPLPS is display-resolution insensitive, these same files, although created at a lower resolution, can be redisplayed through a higher-resolution decoder with no modification to the original file. The hard copy, whether film or paper, becomes a higher-quality image. Additionally, broadcast-quality graphics and NTSC- (National Television System Committee) standard video tapes are being used by broadcasters to augment their

graphics requirements. Even audio-visual producers are using this same method to bring down the costs of their productions while preserving the quality.

What other color-graphics system can provide a universal communications coding format for virtually any micro-computer? What other color-graphics protocol specification is in the public domain? What other color-graphics display generator (decoder) has a choice of over 32,000 colors, 16 of which are displayable

simultaneously, among a host of other features? What other color-graphics system can boast the use of a conventional color television as a display monitor and can be purchased for a price starting at \$1100?

Only decoders implementing full NAPLPS can satisfy these features and others. With this capability now within the reach of the majority of microcomputers, the challenge of creative, interactive graphics software lies with all microcomputer users, whether they be hobbyists or professional programmers. The challenge is here today at a price competitors can really only dream about.

Zal Press, Manager
Business Graphics
Marketing Group
Norpak Ltd.
1351 Washington Blvd., Suite 3000
Stamford, CT 06902

Soup to Nuts.



Some would have you think that a matrix printer is a mere side dish that comes with your computer

Don't believe it.

What you get out of your printer is what you get out of your computer. If your printer is small, slow, noisy or unreliable, your computer will be limited, sluggish, irritating, or inoperable. Just telling it like it is.

That's why Infoscrite has come up with a gourmet line of multifunction matrix printers specifically for business and professional users.

You can switch from high-speed data processing to business letters, at will; handle up to 16-inch-wide paper; make up to five crisp carbons; generate gorgeous graphics in up to eight colors; and enjoy truly elegant and incredibly quiet operation, day-in and day-out.

Check the menu for the printer that meets your exact needs. Why go with the computer manufacturer's combo plate when the same money will let you buy Infoscrite, a la carte?

Your favorite computer dealer or systems specialist will be delighted to arrange a demonstration for you. Or contact the *matrix d'*: Infoscrite, 2720 South Croddy Way, Santa Ana, California 92704, USA, Phone (714) 641-8595, Telex 692422.

Menu					
MODEL	DRAFT (CPS)	CORRESPONDENCE (CPS)	LETTERS (CPS)	GRAPHICS (72 x 72)	GRAPHICS (344 x 344)
500	160	75			
1000	200	100	X	X	
1100	200	100	40	X	X
1200	200				
400					

In Defense of User Protection

In the last year I have read several articles regarding software piracy. Due to this piracy, the creators of software are becoming more and more reticent about making available the source documents and code for a program.

Their caution is well placed because of the wholesale program theft that has taken place in some instances. Then, too, it's possible that the creator stole some major part of the program from someone else, and the lack of an available source listing prevents anyone from proving it.

Before we get too far down the road to complete nonavailability of source code, may I propose some protection for the legitimate user?

First, companies can and do go out of business every day. While one software creator may not, another may. Without the source code to update the program for system and language enhancements yet to come, that program will become worthless and be lost.

Second, because of market conditions, a developer may cease to offer the software or cease to update it. As a result, the software eventually becomes worthless without source to allow the updating of it.

Third, the program offered may have been almost worthless to start with due to errors. The developer made a fast buck, and the buyer was taken. At least with source, some corrections can be made.

A fourth reason for some user protection is that a successful creator may decide

PRINT WITH INFOSCRIBE

TIME-PROVEN PERFORMANCE



While new printers with impressive specifications are introduced on an almost daily basis, only time will tell the true quality of the product. Over the past 2 years our customers have continued to buy the DS180 printer, not only because of its impressive performance and competitive price, but also because of our outstanding track record for product reliability and customer support.

We have continually improved on the performance of the DS180 by incorporating such enhancements as dot addressable graphics, 6 user-selectable print sizes and a 2000 character buffer. These features coupled with 180 cps printing, parallel and serial interfaces, adjustable tractor feed and over 40 other programmable features, make the DS180 one of the most versatile matrix printers available today.

Before you select your next printer, why not take a look at a time-proven performer—the Datasouth DS180.

The DS180 printer is available nationwide through our network of sales/service distributors.

datasouth computer corporation

P.O. Box 240947 • Charlotte, NC 28224 • 704/523-8500

Telex: 6843018 DASOU UW

Circle 143 on inquiry card.

that creation is what he is good at and he'd rather not be bothered by support, sales, etc., and so he enters into a royalty agreement for the program with an independent dealer. Now suppose this dealer wants to sell packages but not help you, the buyer, recover from a system crash or a program bug. Without source or even data on file structures being available, you have to start over after every crash.

There is a way out of this morass of uncertainty, and that is an industry-wide uniform software trust agreement, enforced by a trade journal's refusal to accept advertising of software unless the creator or vendor has placed the source code in trust with an independent third party who holds both the names of the legitimate licensees and the latest source files and documentation.

Vendors should be responsible for pro-

viding copies of all user licenses and regularly update the source code on file with the trustee. In return, the trustee agrees to hold source documentation inviolate (sealed) unless a vendor commits certain acts (I'll discuss these acts later on). Thus, protection exists for the vendors (in that the source is still protected) and for the legitimate user as well.

To the legitimate user, source becomes available, for a fee, in the event that the vendor ceases to function.

The trustee has these responsibilities: (1) to hold source code and related documentation sealed and inviolate unless certain acts are committed, (2) to notify only licensed users at their last known address by first class mail as to the acts committed, and (3) to provide to the licensed users only, for a fee related to the reproduction cost, the source code and documentation, when permissible.

What are these vendor acts and subsequent trustee actions? First, in the event of total sale of program rights to another vendor, the trustee should notify licensees of the event and the name and address of the buyer who has assumed the support obligation. In the event of adjudgment of the developer as bankrupt, ceasing of the vendor to do business, decision by the vendor to cease to offer support, or sale of program rights without an obligation to assume existing package support, the trustee shall so notify licensed users and make available for one year source and documentation for a fee.

There remains the question of users who find program vendors/creators either unwilling or unable to provide adequate support for their packages to licensed users. For this some mechanism should allow licensed users to petition the trustee if they feel that a vendor is providing inadequate support. If some threshold level (say 5 percent) of the licensed users of a program complain to the trustee of inadequate service, the trustee should be required to notify all licensees that complaints have been received. If the trustee gets a positive response from a majority of the users that such is the case, the trustee should then provide source code and documentation to users for a fee.

Such an agreement can adequately protect vendors as long as they want to be protected and will probably protect the user for longer than the economic life of the package.

Whatever methodology is created to protect both the user and the creator, total and permanent unavailability of source to

★ ★ ★ FEATURING 8 AND 16 BIT SYSTEMS ★ ★ ★

EPSON VALDOCS: Extremely user friendly! See review Sept. BYTE HX 80: look-sized battery operated Z 80 computer, up to 256K RAM, built in hard copy, LCD scrollable screen.

MASTER MAX: S-100 system, Z-80, INTERCONTINENTAL CPZ48000 singl card computer with four channels of DMA, dual 8" double density drive: CP/M \$2,540.
Options: double sided drives, Winchester, TURBODOS, 2 user, 220v/50hz.

IMS 8X MULTIUSER SYSTEMS: Z-80, S-100. Each user has own Z-80, 64K RAM, 2 I/O. TURBODOS multiuser CP/M compatible operating system cuts link/edit time in half. Z-80 code. Interrupt driven. 8088 upgrade w/256K RAM has been announced.

TARBELL: Empire systems, Z-80, S-100.
CROMEMCO: C-10 personal computer w/software package

8088: COLUMBIA DATA: IBM-PC look alike, multiuser option.

8086 S-100 SYSTEMS:
LOMAS: with MS-DOS or CP/M-86. Winchester op
SEATTLE: with simultaneous 8" and 5" drives. Will accept IBM/PC software.

DUAL PROCESSOR SYSTEMS:
GODBOUT 816 A,B,C: 8085/8088. MP/M 816 allows simultaneous operation of both processors.
CROMEMCO DPU: 68000 and Z 80. CROMIX operating system.

MAX BOX 8" DRIVE SUBSYSTEMS w/QUMES, SHUGARTS, MITSUBISHI, NEC.

PRINTERS (dot matrix and LQ): EPSON, NEC, QUME, C.ITOH, IDS, FLORIDA DATA. TELETYPE.	GRAPHICS: MICROANGELO GRAPHICS. MIRAGE: new from SCION. AUTO-CAD Interactive graphics software; for engineers, architects, designers. HOUSTON INSTRUMENTS PLOTTERS, DMP-29 \$1,775.
TERMINALS: WYSE, HAZELTINE, IBM 3101, TELEVIDEO. Voice recognition board for TELEVIDEO 950.	IBM PC ACCESSORIES: Extensive line including QUADRAM, SEATTLE 8080/8086 EMULATOR (software).
PER SCI 277/299 DRIVES.	IBM 3270: compatible equipment from Teletype Corp. Fast delivery! Cost effective!
MODEMS: U.S. ROBOTICS DC HAYES compatible.....	
S-100 MAINFRAMES: PARADYNAMICS, ECT, some TEI 12 slot still in stock.	

We have an extensive product line including systems, peripherals, software, boards, drives, consulting services. Write or call for detailed specifications. We have knowledgeable technical staff.

WE EXPORT Overseas Callers: Phone (212) 448-6298

Cdex™ Training for VisiCalc® Makes VisiCalc Easy.



In an hour, Cdex Training for VisiCalc can make you a VisiCalc user. Or for the experienced VisiCalc user Cdex Training for VisiCalc acts as an instantaneous electronic reference and review system.

It's a computer-assisted training program that *works*. It's highly interactive. So it creates a dialogue with you and serves as

your personal tutor. It's completely self-paced. So you set your own learning time. And it's graphically-oriented. So you see what you're learning. Remember, a picture is worth 1000 words. Cdex Training for VisiCalc runs on the same Apple® II or IBM® Personal Computer as your VisiCalc program.

So see how easy VisiCalc can be. See your nearest computer dealer for a demonstration.

Cdex™ Training for VisiCalc®

We don't make VisiCalc.
We just make it easy.

cdex™
Cdex Corporation

5050 El Camino Real Suite 200
Los Altos, CA 94022

VisiCalc® is a registered trademark of VisiCorp™

a legitimate user is not an acceptable answer.

William E. Young, CPA
13901 Jefferson Davis Hwy.
Woodbridge, VA 22191

Minspeak Applauded

I read with great attention the "Minspeak" article by Bruce Baker (September 1982 BYTE, page 86). Minspeak is the most exciting use of computer technology that I have encountered because it goes beyond the use of the computer to manipulate data and/or symbols and deals with the fundamental issues of human communication and the way we think.

While Mr. Baker deals almost exclusively with the application of Minspeak to the nonspeaking population, the fundamental idea behind his invention, I believe, has a great deal to say about how we think and how we communicate whole thoughts to one another in speech and nonspeech worlds.

I commend Mr. Baker and BYTE for moving beyond hardware and software

into the genuinely exciting new realms of electronic technology and its applications to human problems and potentials.

David O. Justice, Dean
School for New Learning
DePaul University
23 East Jackson Blvd.
Chicago, IL 60604

Computer Poetry: Art or Craft?

Kevin McKean's article "Computers, Fiction, and Poetry" (July 1982 BYTE, page 50) nearly supplies some important implications about the nature of creativity. The examples of computer-written poetry suggest that computers can now make many judgments rapidly but cannot make them wisely. The reason seems to be that the computer, unlike the poet, uses programmed instruction to apply types of judgments to many words. The poet makes individual judgments on a word-by-word basis. Thus, in writing "And delves the parallels in Beauty's brow," Shakespeare probably thought "delves" a

good word for its "l" and "e" sounds, matched in "parallels," and for the overall dreamlike, wistful quality that the word contributes to the line. Of course, he may have had other reasons as well.

Today, because western culture seems to have weaker ties with tradition than in the past, and because ours is more than ever a culture without a sense of history, it is understandable that considerations of creativity focus on the ceaseless fluctuations common to the thought process, rather than on the decisions that artists make after much thought. Still, an artist may draw upon any or all of his life's history in order to pass judgment on a single word. His intellect, his moral integrity, his honesty, his passion, his love, his hope, his hate, his fear, his skepticism, his faith—in short, the sum of the poet's whole existence gives him the ability to make artistic judgments. And a sense of tradition supports the artist's individuality, which includes his powers of artistic discernment. Thus, in our ever-changing, prone-to-forgetfulness world, the popularity of computers is assured, but computers still lack what Keats called "the

Did You Hear the One About the Computer That Talks?

It's no joke.

With the ECHO speech synthesizer from Street Electronics whatever you type on the keyboard, your computer can say. The ECHO's text-to-speech system gives your computer an unlimited vocabulary while using a minimum of memory. And now a diskette of fixed, natural sounding words is available to enhance the ECHO II's voice output.

Nearly 400 language rules are contained in the ECHO's text-to-speech algorithm. These rules enable the computer to pronounce most correctly spelled words. When in the text-to-speech mode the user can select any of 63 different pitch levels, and have words spoken either monotonically or with intonation by using simple control character sequences. The rate of speech can be fast or slow; words can be spoken in their entirety or spelled letter by letter. The ECHO's also pronounce punctuation and numbers. Words can be encoded using phonemes and diphthongs when the text-to-speech or fixed vocabulary is not required.

Applications are unlimited, ranging from phone answering, educational and training programs, to games and aiding the sight and speech impaired. The ECHO is a complete stand alone unit which is compatible with most any computer; it sells for \$299.95. The ECHO II, which plugs into the Apple II, is priced at \$149.95.

Street Electronics Corporation
1140 Mark Avenue, Carpinteria, CA 93013
Telephone (805) 684-4593



Call toll free for demonstration (800) 221-0339

897 N.W. Grant Ave. • Corvallis, Oregon 97330 • 503/758-0521

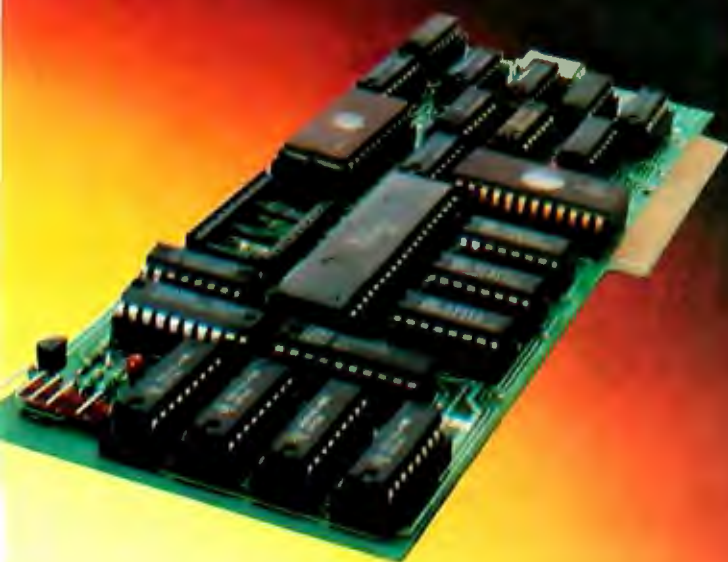

VIDEOTERM

Expanding Horizons in Text Display

Videoterm increases your Apple][[®] display to a full capacity 80 columns. Proofreading text problems are a thing of the past. With Videoterm your text is displayed in upper and lower case characters with true descenders utilizing a 7 by 9 character matrix. The time-tested Videoterm is compatible with most word processors and is available with alternate character fonts. Once you've explored the advantages of Videoterm, you'll discover a whole new world for you and your Apple][.

Suggested retail price: \$345.00

ACCESSORIES

Videoterm Utilities Disc includes:

- Graphics Template System
- Font Editor
- Mid-Res Graphics
- Applesoft Read Screen Utility
- Top & Bottom Scrolling
- Pascal Vidpatch

Suggested price \$37.00



Videoterm Character Set EPROMs

- French
- German
- Inverse
- Katakana (Japanese)
- Math & Greek Symbols
- Norsk



- N. European
- Russian
- Spanish
- Super & Subscript

Suggested price \$29.00 each.

Dvorak EPROM (Enhancer)—\$29.00
Lower Case Chip (Rev 7 & up)—\$29.00

SOFT VIDEO SWITCH

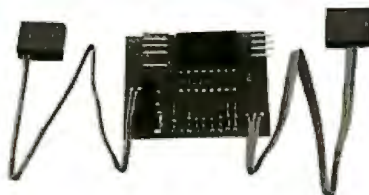

The Soft Video Switch is an automatic version of the popular Switchplate. It knows whether it should display 40 or 80 columns or Apple graphics. It does the tedious work of switching video-out signals so you don't have to. The Soft Video Switch can be controlled by software. May be used with any Videoterm with Firmware 2.0 or greater. The single wire shift mod is also supported. Package price is \$35.00.

ENHANCER][



The Enhancer][features a typeahead buffer. Your keyboard has upper and lower case, and will auto repeat any key held down. A single keystroke can become a word or an entire sentence. Controlled by a powerful microprocessor, Enhancer][allows you to re-map your keyboard or add specialized features. Changing a chip creates a totally different keyboard. Enhancer][Utilities Disc included. Suggested retail price \$149.00.

Circle 427 on Inquiry card.

ARE YOU STILL LETTING YOUR PRINTER TIE UP YOUR COMPUTER?

While your printer is running, your computer is tied up. You can't use it for processing, computing, data entry. Nothing. All you can do is twiddle your thumbs until the program is finished.

Pretty ridiculous.

MICROBUFFER ALLOWS YOU TO PRINT AND PROCESS SIMULTANEOUSLY.

You just dump your printing data directly to Microbuffer, whoosh!, and continue processing. No waiting.

Microbuffer accepts data as fast as your computer can send it. It stores the data in its own memory buffer then takes control of the printer.

It's that easy.

THERE IS A MICROBUFFER FOR ANY COMPUTER/PRINTER COMBINATION.

Whatever your system, there is a specific Microbuffer designed to accommodate it.

FOR APPLE II COMPUTERS, Mircobuffer II features on-board firmware for text formatting and advanced graphics dump routines. Both serial and parrel versions have a power-efficient low-consumption design. Special functions include Basic listing formatter, self-test, buffer zap, and

transparent and maintain modes. The 16K model is priced at \$259 and the 32K, at \$299.

FOR EPSON PRINTERS, Microbuffer/E comes in two serial versions — 8K or 16K (upgradable to 32K) — and two parallel versions — 16K or 32K (upgradable to 64K). The serial buffer supports both hardware handshaking and XON-XOFF software handshaking at baud rates up to 19,200. Both interfaces are compatible with standard Epson commands, including GRAFTRAX-80 and GRAFTRAX-80+. Prices range from \$159 to \$279.

ALL OTHER COMPUTER/PRINTER COMBINATIONS can be untied by the stand-alone Microbuffer In-line.

The serial stand-alone will support different input and output baud rates and different hand-shake protocol. Both serial and parallel versions are available in a 32K model at \$299 or 64K for \$349. Either can be user-upgraded to a total of 256K with 64K add-ons — just \$179 each.

SIMPLE TO INSTALL.

Microbuffer II is slot-independent. It slips directly inside the Apple II in any slot except zero.

Microbuffer/E mounts easily inside the existing auxiliary slot directly inside the Epson printer.

The stand-alone Microbuffer is

installed in-line between virtually any computer and any printer.

MICROBUFFER FROM PRACTICAL PERIPHERALS.

So what are you waiting for? Write to us for more information or ask your dealer for a demonstration.

When you see how much freedom Microbuffer will allow, you'll understand why it's so silly to be without one.

PRACTICAL PERIPHERALS, INC.™
31245 LA BAYA DRIVE
WESTLAKE VILLAGE, CA 91362
(213) 991-8200





MICROBUFFER FREES COMPUTERS.

Circle 340 on inquiry card.

PRINTER OPTIMIZER

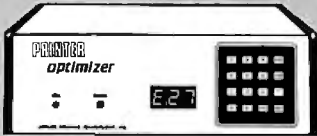

Why buy a mere "spooler" when you can have THE PRINTER OPTIMIZER?

- * 64k to 256k spooling buffer
- * adapts different brands - can mix Serial and Parallel
- * character conversion: 1 to 1, 1 to many, many to 1, ignore
- * pushbutton automated access to your printer's various type styles and printing modes
- * several ways to PAUSE printing
- * access any character, graphic design or printer "trick" from any program at any time
- * special features for use as a MODEM buffer

ETI²

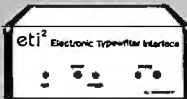

The cost effective alternative. Converts IBM, Adler/Royal, Olympia and other Electronic Typewriters into letter quality printers.

- * 2K memory buffer
- * access all typewriter characters and automated features
- * Serial or Parallel versions
- * Many proprietary features and commands insure compatibility with your system and software
- * Typesetting capability!

PETI²



Super low cost adaptor for: new inexpensive portable Electronic Typewriters can yield typewriter and letter quality printer combination for around \$500 total!

- * perfect for "personal use"
- * easy "plug-in" Parallel connection to most computers
- * compatible with popular word processing programs

APPLIED CREATIVE TECHNOLOGY INC.

2723 Avenue E East, Suite 717
Arlington, Texas 76011
(817)-261-6905
(800)-433-5373

Letters

knowledge of contrast, feeling for light and shade, all that information (primitive sense) necessary for a poem."

If you could accurately enter your whole life into a computer without leaving the minutest fact out, then the computer could possess a chance of becoming artistic. But even then the computer would have to be considered the protégé of its programmer. For now, computers may be profitably used as electronic thesauri, as servants to the new *craft* of electronic poetry-writing. As far as the *art* of poetry is concerned, computers will have to wait.

Rob Zselezcky
19 Tanglewood Lane
Chatham, NJ 07928

Not-So-Standard Automobiles

In part 1 of his article "An Introduction to the Human Applications Standard Computer Interface" (October 1982 BYTE, page 291), Chris Rutkowski used the early development of the automobile as a case study to explain how microcomputer technology is still in its formative years because it has not come up with a standardized, easy-to-use format. This is a viable analogy, but Chris was a little off on his time frame. He says "you would be able to climb into the typical automobile of 1925 and drive it away." For most readers of BYTE today this would not be true. In 1925 approximately 50 percent of the cars being sold in the United States were Model T Fords. The Model T Ford used a pedal-controlled planetary transmission that a modern driver would not understand without instruction or prior use. Other 1925 makes also had irregular controls, such as spark levers, hand throttles, oddly placed starter buttons, etc. Actually, the standardization of most automobile operations took much longer than Chris surmised. Hopefully, the process will not take so long in the microcomputer industry.

Fred K. Fox
13150 El Capitan Way
Delhi, CA 95315

Total Talk Talks Back

In response to David Stoffel's article "Talking Terminals" (September 1982 BYTE, page 218), I would like to thank BYTE for giving this subject the attention it deserves. However, as the manufacturer

of one of the products described by Mr. Stoffel, I'd like to state that numerous inaccuracies appear in his article.

Contrary to the impression given in the article, Total Talk from Maryland Computer Services Inc. (MCS) offers both a user-definable vocabulary and full numbers capabilities (it can speak 123 as "one two three" or "one hundred and twenty-three"). To my knowledge, MCS was the first to offer these features. It is also false that Total Talk does not have a cursor locator. Total Talk has had this since the product was introduced in June of 1980.

The author fails to mention many of the advantages of incorporating speech into an existing terminal. Total Talk offers an Enunciation key to tell you the terminal's status and the function of a key without executing the function; the device can vocalize the terminal's communication parameters and can set tabs and margins. Also you can define keys to perform specific tasks, such as say the line, say the word, and spell the word. This is essential to the nontechnical user in that escape codes do not have to be memorized.

The approach that places the speech box between the terminal and the host has several disadvantages. What is displayed on the screen is not an accurate representation of what is stored in the speech box's buffer. This is a severe disadvantage when the blind operator must interact with sighted co-workers or instructors. Full-page editing cannot be accomplished.

Capabilities that are very useful to Total Talk's users but were not mentioned in Mr. Stoffel's article are notification that the cursor is at the end of the line, moving the cursor forward and backward either a word at a time or a line at a time without speaking the word or line, and reading up and down columns.

Mr. Stoffel's comment that "Total Talk loses data after receiving 120 characters" shows a lack of understanding of the terminal. Total Talk has three sophisticated handshaking capabilities—XON/XOFF, Data Terminal Ready, and Inquire/Acknowledge. If your host computer does not support these capabilities, then you simply cannot use "Log Bottom," a feature that reads the data as it appears on the screen. If the terminal is configured correctly, data is not lost.

The article states that screen-oriented programs like Wordstar are not practical using speech output. We take exception to this because our customers are using Total Talk and Information Thru Speech (our

The ultimate under \$1000 printing machine.



The one machine solution to every application.

For word processing, plotting and just plain printing.

Save the expense of a costly daisy wheel. Eliminate the limited capability of cheap matrix printers. And get plotting in the process!! Get the all new, advanced MT 160 multifunctional micro printer. You'll be amazed that such a small printer can house so much horsepower.

Capability? You name it, this printer's got it. A resident Report Package puts you in the Word Processing world... letter quality characters, proportional spacing, margin justification, auto centering. A resident Graphics Package

lets you plot whatever your micro wants to portray. The standard print mode lets you generate reports fast—speeds up to 200 lines per minute. Also, print eight different resident character widths.

There's more. Clip-on paper handling attachments let you use fan-fold forms, letterhead, cut sheets or continuous roll paper. The control panel has a "menu select" for machine configuration. When you look under the hood, you'll see what is meant by "solid construction." And the MT 160 is

plug compatible to your micro.

In short, the MT 160 is the epitome of engineering excellence. And it should be. After all, Mannesmann Tally is the technology leader in matrix printing.

MANNESMANN TALLY

8301 South 180th St.
Kent, Washington 98032
Phone (206) 251-5524

IN DISTRIBUTION NOW!

WEST
Anacomp
(206) 881-1113
Byte Industries
(415) 783-8272

Kieruff Electronics
(213) 725-0325
PGI Distribution
(602) 967-1421
Waybern
(714) 554-4520
Western Micro Technology
(408) 725-1660
Acorn Data Products
(303) 779-6644

CENTRAL
Hall-Mark Electronics
(214) 341-1147
Information Systems
(312) 228-5480
D.L. MacNeil, Inc.
(312) 952-8300

Sysprint
(214) 669-3666
Tek-Aids
(312) 870-7400

EAST
Computermx
(904) 878-4121
Digital Solutions
(404) 955-4488
Hansen & Hughes
(201) 652-7055

US Plus
(203) 234-0444
Mannesmann Tally Canada
(416) 661-9783

talking microcomputer/terminal) for this purpose every day. This also raises the question of why our Information Thru Speech terminal, which has been on the market since January of 1982, was never mentioned.

Finally, Mr. Stoffel hopes that the price of talking terminals will go down or their capabilities will increase. This is exactly what happened this year when MCS announced more powerful machines and a decrease in prices from 15 to 50 percent.

J. Michael Mason, Vice-President Marketing
Maryland Computer Services Inc.
 2010 Rock Spring Rd.
 Forest Hill, MD 21050

Terminology Correction

The use of terminology in Jack L. Abbot's review "Systems Plus: FMS-80" (October 1982 BYTE, page 447) was disturbing. The article was well written, informative, and provided a reasonable set of data from which to draw some conclusions and comparisons to other systems. However, to call FMS-80 a "relational"

DBMS (database-management system) is appalling. It is bad enough that vendors misuse terminology, but a publication should not further perpetrate such misguidance. Some purists might argue that FMS-80 is not even a DBMS. And there are purists who have strict rules on the definition of a relational DBMS. In either case, most experts agree that a relational DBMS has, at a minimum, specific functional (e.g., project and join) and representational (e.g., tabular user view) components as its foundation. What will you tell your readers when the true relational DBMS is developed for microcomputers? As the leading journal for small-systems users, BYTE should attempt to use standard systems terminology when appropriate and not allow vendors to mislead the public any further than their advertisements do.

I do not want to detract from an extremely powerful personal computer tool such as FMS-80. I am currently evaluating file-management software for personal computers and have been surprised by the comprehensiveness and depth of functions of such packages. These rival many of the tools offered on larger systems and

should virtually eliminate for most users the need to create their own programs.

Michael Lutz, Manager
Data Administration
Davis Chemical Division
W.R. Grace & Co.
 POB 2117
 Baltimore, MD 21203

User's Column Under Fire

As a subscriber to BYTE, I am compelled to write questioning the professionalism of your monthly User's Column written by Jerry Pournelle.

BYTE is an informative computer magazine that stands head and shoulders above any other small systems journals. All the hardware reviews are concise and informative. Steve Ciarcia does an excellent job of breaking hardware design down to a simple process for most hobbyists. Sol Libes keeps the latest information on new products available for all readers.

However, I find Mr. Pournelle's monthly column neither useful nor coherent. All I understand from his column is that he is always very busy and has many friends that allow him access to free hardware and software. In the September 1982 BYTE, he explained that he belongs to a large number of clubs and organizations and doesn't know how to do all the activities he does each month.

That kind of text has no place in BYTE. As a reader, I am concerned with the topics covered in the column, not with what the author did while preparing it. When reading User's Column I feel that I am reading a letter from a long lost friend who is trying to tell me everything that has happened during the last three years.

User's Column is both useful and necessary, but please keep it up to the fine standards that BYTE is known for. In future issues, don't allow Mr. Pournelle to ramble incoherently page after page.

Ron Dyer
 40 Godstone Rd., Suite 305
 Willowdale, Ontario
 M2J 3C7 Canada

I was appalled by Jerry Pournelle's recent defense of software hacking (see "User's Column: A BASIC and Pascal Benchmark, Elegance, Apologies, and FORTH," October 1982 BYTE, page 254). I defy you to name any other engineering discipline in which disorganized, patch-as-you-go approaches are considered to be acceptable practice.

BYTEWRITER®
DAISY WHEEL PRINTER



- Full Olivetti typewriter warranty
- U.L. Listed

\$695 plus shipping

FEATURES

- Typewriter operation with nothing to disconnect
- 10, 12 or 15 characters per inch switch selectable
- Portable with carrying case
- Entire interface mounted internally in the Olivetti Praxis 30 typewriter
- Underlining
- Cables available for most computers
- Service from Olivetti dealers
- Centronics compatible parallel input
- Built in self test
- Cartridge ribbon
- 2nd keyboard switch selectable.

BYTEWRITER

125 NORTHVIEW RD., ITHACA, N.Y. 14850
 (607) 272-1132

Now! A 60 MHz Tektronix scope built for your bench.

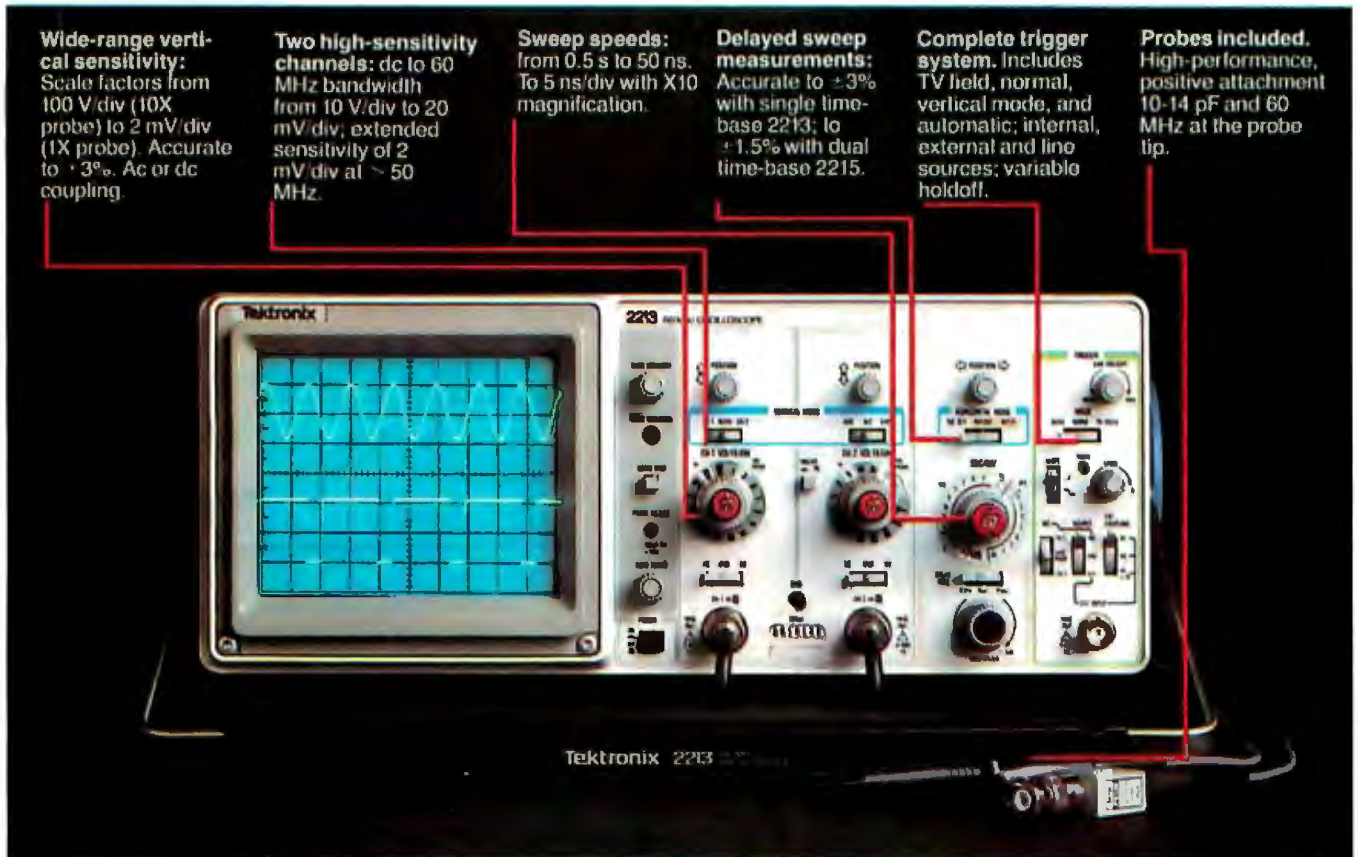

Wide-range vertical sensitivity: Scale factors from 100 V/div (10X probe) to 2 mV/div (1X probe). Accurate to $\pm 3\%$. Ac or dc coupling.

Two high-sensitivity channels: dc to 60 MHz bandwidth from 10 V/div to 20 mV/div; extended sensitivity of 2 mV/div at > 50 MHz.

Sweep speeds: from 0.5 s to 50 ns. To 5 ns/div with X10 magnification.

Delayed sweep measurements: Accurate to $\pm 3\%$ with single time-base 2213; to $\pm 1.5\%$ with dual time-base 2215.

Complete trigger system. Includes TV field, normal, vertical mode, and automatic; internal, external and line sources; variable holdoff.

Probes included. High-performance, positive attachment 10-14 pF and 60 MHz at the probe tip.

In 30 years of Tektronix oscilloscope leadership, no other scopes have recorded the immediate popular appeal of the Tek 2200 Series. The Tek 2213 and 2215 are unapproachable for the performance and reliability they offer at a surprisingly affordable price.

There's no compromise with Tektronix quality: The low cost is the result of a new design concept that cut mechanical parts by 65%. Cut cabling by 90%. Virtually eliminated board electrical connectors. And eliminated the need for a cooling fan.

Yet performance is written all over the front panels. There's the bandwidth for digital and analog circuits. The sensitivity for low signal measurements. The sweep speeds for fast logic families. And delayed sweep for fast, accurate timing measurements.

The cost: \$1200* for the 2213. \$1450* for the dual time base 2215.

You can order, or obtain more information, through the Tektronix National Marketing Center, where technical personnel can answer your questions and expedite delivery. Your direct order includes

probes, operating manuals, 15-day return policy and full Tektronix warranty.

For quantity purchases, please contact your local Tektronix sales representative.

**Order toll free:
1-800-426-2200
Extension 45**

In Oregon call collect:
(503) 627-9000 Ext. 45

*Price F.O.B. Beaverton, OR. Price subject to change.

CAST BETTER, FASTER SPELLS WITH OUR CI-C86 C COMPILER



Weave
a spell with
the CI-C86 C Compiler,
especially designed for use with:

- CPM86 and MPM86
- MS-DOS
- IBM Personal
- IBM Displaywriter
- DEC Rainbow
- Victor 9000
- Sirius
- NEC APC
- Zenith Z100
- Lomas 8086
- Altos 8600
- Compupro 86/87
- Seattle
- Eagle
- Columbia 1600
- And Many More

CI puts all the magic of C at your fingertips with all of K&R, a full support library, 8087 support and much more.

Merlin would approve!

Disk and documentation \$395.
Overseas airmail \$20.

For further information, please contact:



Computer Innovations, Inc.
75 Pine Street
Lincroft, New Jersey 07738
Telephone: (201) 530-0995



C86 and CI-C86 are trademarks of Computer Innovations, Inc.
CPM and MPM are trademarks of Digital Research.
MS-DOS is a trademark of Microsoft.
IBM is a trademark of International Business Machines.
DEC is a trademark of Digital Equipment Corp.

Letters

Clear thought solves problems. Code does not solve problems. Code implements the solutions to problems.

Computer languages form a class of tools to aid in clear thought. Other tools include formal mathematics, eloquent English, and analysis techniques specific to the problem area.

Office buildings, bridges, dams, oil pipelines, rapid transit systems, some large ships, new forms of life created by means of recombinant DNA, movies, newspaper articles, and letters to the editor of BYTE, all are one-of-a-kind creations. Their creators undoubtedly work under as much pressure as that experienced by computer programmers. Which of these creations would Mr. Pournelle like to see built by the same techniques he advocates for software?

Daniel Ross
Succinct Systems
1346 River St.
Santa Cruz, CA 95060 ■

BYTE's Bits

Data General Opens Customer Center In Dallas

Data General recently opened a customer training center in Dallas, Texas. The center was established to provide local access to the firm's training services for end-users and OEMs (original equipment manufacturers) in the southwestern United States. The center has three classrooms, administrative offices, and a systems training laboratory housing an Eclipse computer and linked Dasher terminals capable of accommodating 18 users simultaneously.

Through the center, nearby users will have access to hardware and software training at their sites, self-paced instructional training, and other training alternatives offered by the company. In addition, free educational planning and consulting services and an ongoing schedule of lecture courses on Data General software, utilities, and programming languages are provided by the center.

Data General maintains training centers in Atlanta, Boston, Chicago, Los Angeles, Washington, D.C., six European countries, and Australia-New Zealand. For more information on the newest training center, contact Customer Education, Data General Corp., 4350 Alpha Rd., Dallas, TX 75234, (214) 458-2945. ■

GREAT IDEAS... Down to Earth Products



(Available Soon)



SDS-ZS10/4
4 RS232 Channels
Full Duplex
Real Time Clock



SDS-HARD DISK INTERFACE
Micropolis 1220 Series
or ST-506
Interface Adapter

A Shining New Star



• 5 1/4" Hard Disk
• 5 1/4" TPI Floppy

• 6 Slot S-100 Mainframe
See page for details



NEC-FLOPPY DISK DRIVE
Double Sided
Single Density/Double Density
Up to 2.4 Megabyte
(Come Now Available)



SDS-MULTIPLEXER/DISPLAY
Three RS232C 1 to 2 Switches
Two Seven Segment Status Display
(Can be used as a line monitor for data
communications link)
(route RS232 to one of two devices)

*TURBODOS TANDEM



SDS-MASTER



SDS-SLAVE

SDS-SINGLE BOARD COMPUTERS
Z80 CPU 64K Bank Switch Memory
2 RS232 Channels 4 Timers IEEE 696 Buss
4 Parallel ports
NEC 765 FDC with PLL to all Shugart
compatible drives (SDS-Master only)
*CP/M 2.2 & 3.0

*CP/M Registered trademark of
Digital Research

*TurboDOS Registered trademark of
Software 2000

HARDWARE
SOFTWARE



SIERRA DATA SCIENCES

Fresno CA/Marketing Division
21162 Lorain Ave., Fairview Park, Ohio 44126
(216) 331-8500 Telex. 980131 WDMR

**Rana's disk drive was
twice as good as Apple's
with one head.**



Now we have two.

We added another head so you won't have to buy another disk.

That's the beauty of a double sided head. A floppy disk which allows you to read and write on both sides. For more storage, for more information, for keeping larger records,

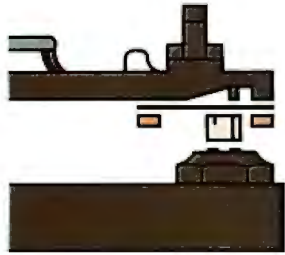

Rana's double sided heads give Apple II superior disk performance power than second generation personal computers such as IBM's.

That's what our new Elite Two and Elite Three offers. It's the first double headed Apple® compatible disk drive in the industry. And of course, the technology is from Rana. We're the company who gave you 163K bytes of storage with our Elite One, a 14% increase over Apple's. And now with our high tech double sided heads, our Elite Two and Three offers you two to four times more storage than Apple's. That's really taking a byte out of the competition.

We put our heads together to give you a superior disk drive.

We designed the Elite Three to give you near hard disk capacity, with all the advantages of a minifloppy system. The double sided head operates on 80 tracks per side, giving you a capacity of 652K bytes. It would take 4½ Apples to give you that. And cost you three times our Elite Three's reasonable \$849 pricetag.

It takes 4½ Apples to equal the capacity of our superior Elite Three.

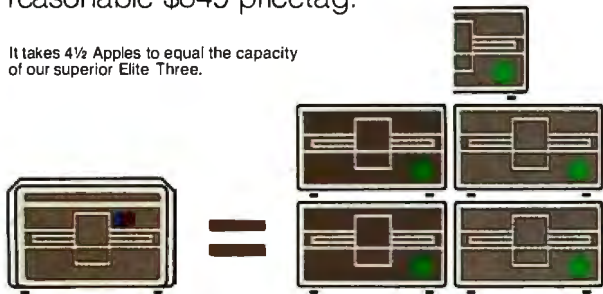

The Elite Two offers an impressive 326K bytes and 40 tracks on each side. This drive is making a real hit with users who need extra storage, but don't require top-of-the-line capacity. Costwise, it takes 2½ Apple drives to equal the performance of our Elite Two. And twice as many diskettes. Leave it to Rana to produce the most cost efficient disk drive in the world.

We've always had the guts to be a leader.

Our double sided head may be an industry first for Apple computers, but nobody was surprised.



They've come to expect it from us. Because Rana has always been a leader. We were the first with a write protect feature, increased capacity,

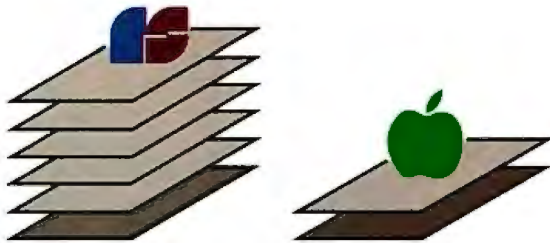

Your word processor stores 5 times as many pages of text on an Elite Three diskette as the cost ineffective Apple.

and accurate head positioning. A first with attractive styling, faster access time, and the convenience of storing a lot more pages on far fewer diskettes. We were first to bring high technology to a higher level of quality.

So ask for an Elite One, Two, or Three. Because when it comes to disk drives, nobody uses their head like Rana.

RanaSystems



20620 South Leapwood Avenue, Carson, CA 90746 213-538-2353. For dealer information call toll free: 1-800-421-2207. In California only call: 1-800-262-1221. Source Number: TCT-654

Circle 365 on Inquiry card.

Available at all participating Computerland stores and other fine computer dealers.

"...faithfully captures
the look, spirit and
play of arcade
'Space Invaders'"

-John Anderson,
Creative Computing

"All are excellent versions
of the arcade games
with super graphics
and sound."

-Mark Benjoff
A.N.A.L.O.G.

"The graphics display,
sounds and game logic are
so close to the original,
that you might find yourself
looking for the coin slot
on your computer."

-Gary and Marcia Rose

"'Deluxe Invaders'
is by far the best
Space Invaders program
ever released for a
personal computer."

-Leigh Goldstein,
Electronic Games



Raklan Software

We are Serious About Our Games!

The Lisa Computer System

Apple designs a new kind of machine.

Gregg Williams
Senior Editor

I had an interesting conversation with an engineer on a recent flight from San Francisco to New York. He knew only a little about microcomputers, but he was aware that their presence is slowly becoming more common in the workplace. "Sure, the industry is healthy, but it's still only reaching a few people," he said. "Most people won't use computers—they're afraid of them, they don't know what to use them for, or it's too much trouble to use them. Before computers become *really* profitable, they're going to have to be very easy to use. They have to be simple^r. They've got to be useful in the office."

He continued, "We've got to stop using paper—which means the computer has to do word processing, filing, electronic mail, *everything*—or it'll be too much trouble having some things on the computer and others on paper. Then you've got to be able to talk to other computers—other computers like yours and some big corporate computer that's halfway across the country. Sure, it's a lot of stuff, but when you get all that together, *then* you'll see computers really take off."

What could I say? Not very much, for two reasons. First, he was absolutely right—we need all that and more before computers become as commonplace as color TVs and electric typewriters. Second, I had agreed not to talk about a computer I had just seen that meets many of his points: Apple Computer's highly secret Lisa computer (see photo 1).



Photo 1: *The Lisa computer system.*

The Lisa at Work

Before we take a detailed look at what the Lisa is and how it came about, let's look at an example of what it can do. Suppose I'm writing a report for my boss and I want to prepare a chart to illustrate a certain point. With a few movements of the *mouse* (more on this pointing device later), I "tear off" a sheet of Lisa Graph "paper" (thus activating a program called Lisa Calc and displaying an empty grid on the screen) and give it the heading "Annual Sales." I then type my numbers into the grid, name the graph and the *x* and *y* axes, and request a bar graph.

Voilà: I get the bar graph (superimposed on top of the data) shown in photo 2a. At this point, I can simply print the graph or save it for inclusion with my report, but I'm not satisfied with the way it looks. I then use the mouse to "cut" the graph from the Lisa Graph paper and put it in a temporary storage place called the *clipboard*. I can then "throw away" the Lisa Graph "paper" I was using.

My next step is to "tear off" a sheet of Lisa Calc "paper" and paste my "Annual Sales" bar chart from the clipboard onto it. Photo 2b shows the result.

I want to make the bars darker, so I use the mouse to move the cursor (the arrow pointing diagonally up in photo 2b) onto the rectangle and tell the computer that I want to work on that bar by clicking the button on top of the mouse twice. (I could almost as easily have selected all four bars, but I'll just do one here.) As a result, the bar

(2a)

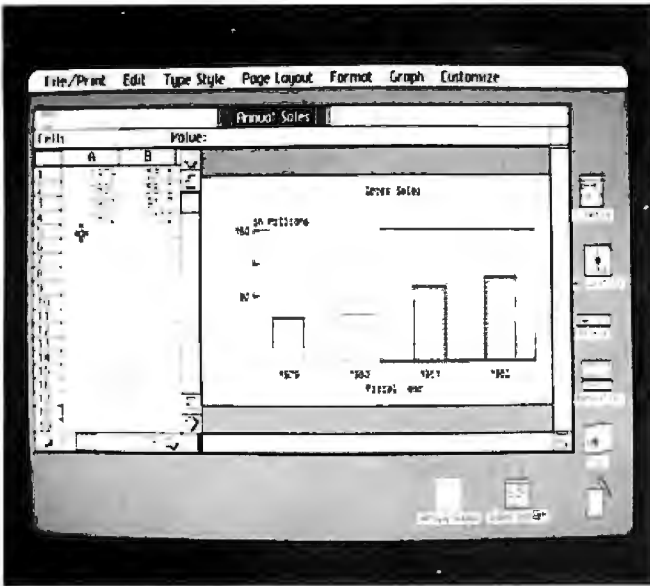

(2b)

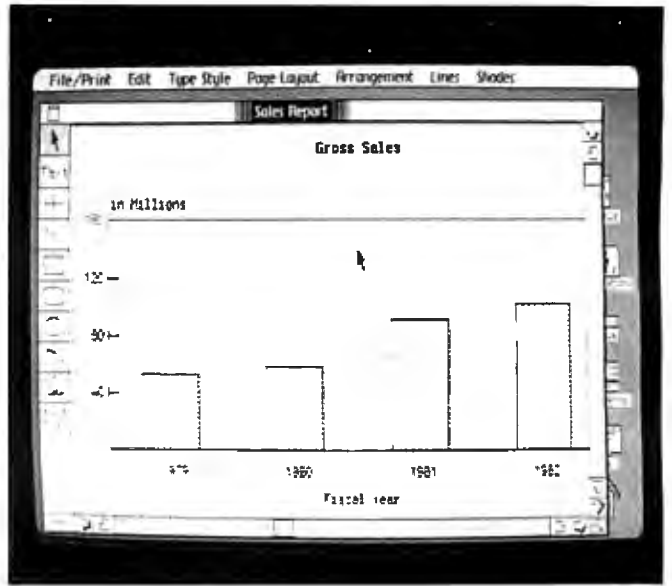

Photos 2a-j: Creating a chart using the Lisa Graph and Lisa Draw programs. See the text for details of how the image is generated and changed.

is selected, as shown in photo 2c. (In the Lisa system, you first select what you want to work on, then you select the action you want performed.) The small black squares that appear on the edge of the object are called *handles*; not only do they show which object has been selected, they also serve as "handles" by which the cursor can move or alter a shape.

Now that the bar is selected, I move the cursor to one of the menu titles at the top of the screen (also shown in photo 2c). I see the menu of possible actions by pointing the cursor at the menu title and holding down the mouse button (photo 2d). Here, the menu is a grid of 36 varieties of shading that can be used to fill the selected area. When I move the cursor to the desired shade box and let up on the mouse button, the pop-up menu, as it is called,

(2g)

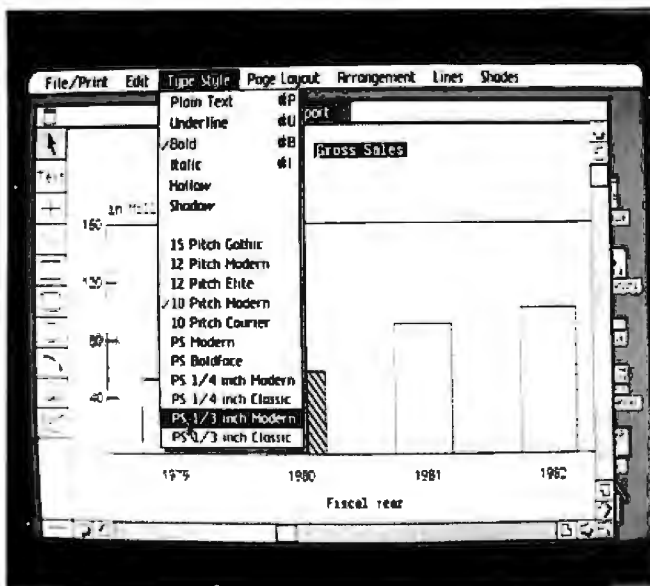

(2h)

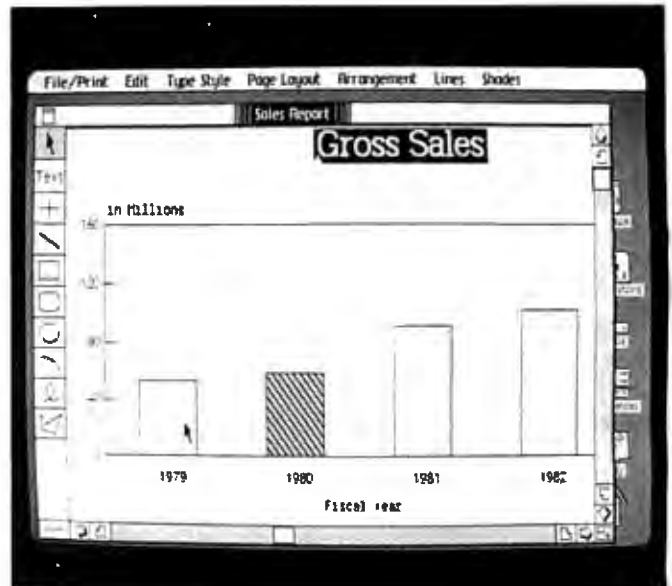

(2c)

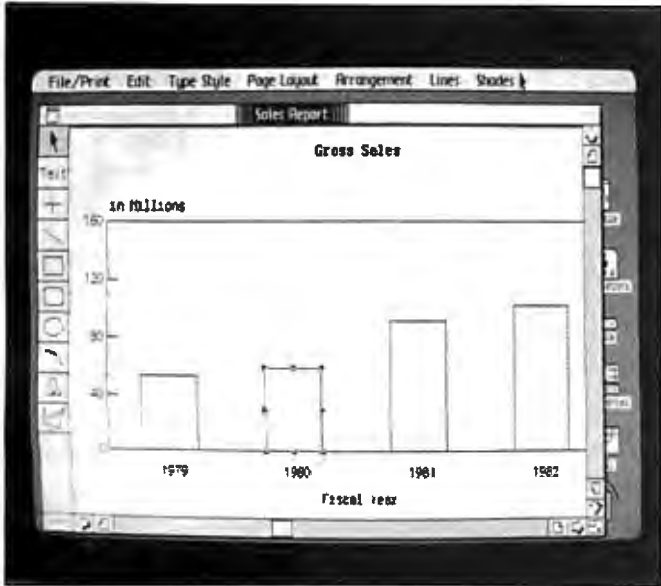

(2d)

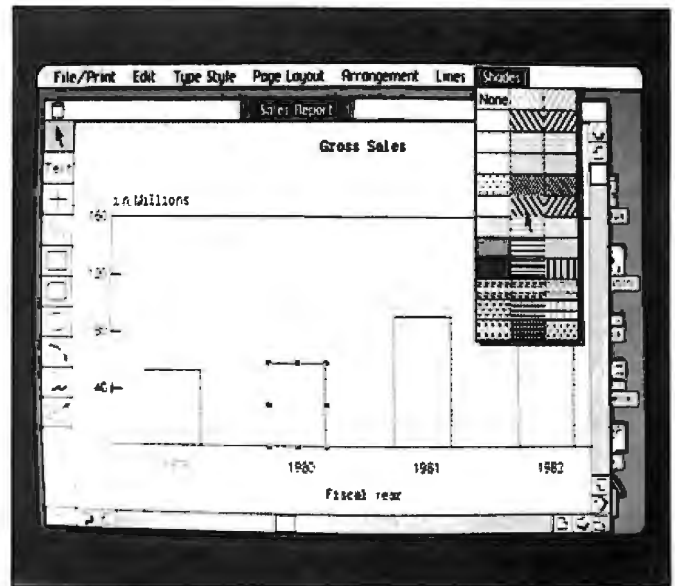

disappears and the shading fills the box (photo 2e).

It is equally simple to change the size, type style, and position of the title "Gross Sales." By holding down the mouse button when the cursor points just to the left of the first letter and letting it up when the cursor points just past the last letter, I can select an area of text that the Lisa then puts in reverse video (photo 2f). When I select an option from the "Type Style" menu (photo 2g), the text is redisplayed in its new size and style (photo 2h). I then modify the title to an italic font in a similar way (photo 2i). Finally, I pick up the title with the cursor, "drag" it to a new location, and leave it there (photo 2j). Many other alterations are possible. When I'm satisfied with the graph, I can print it, save it, or do both.

This example conveys only a fraction of the speed and the ease of use associated with the Lisa computer and the programs that go with it. Now that we've seen the system at work, let's take a look at what makes it so different.

(2f)

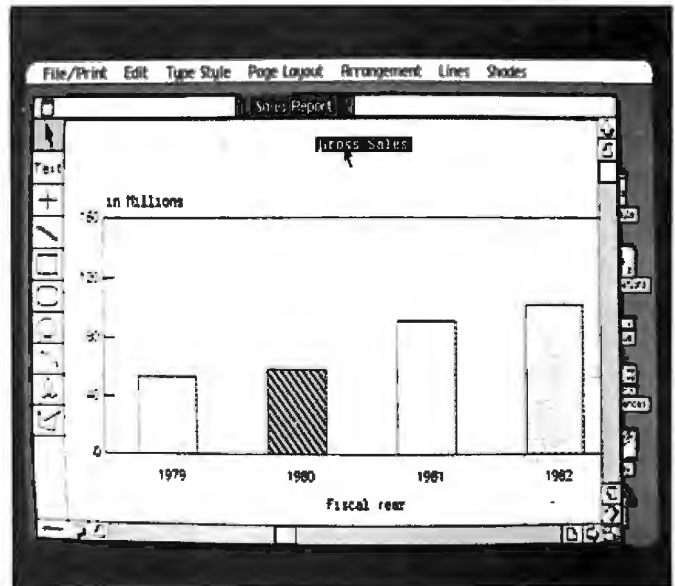

(2i)

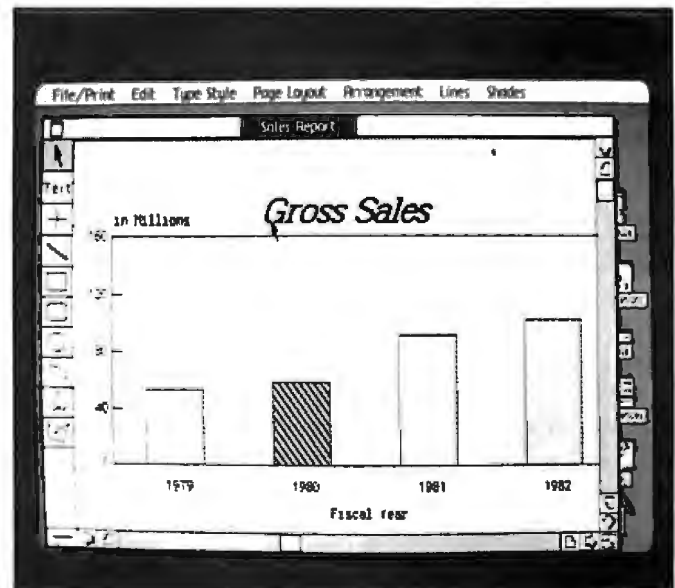
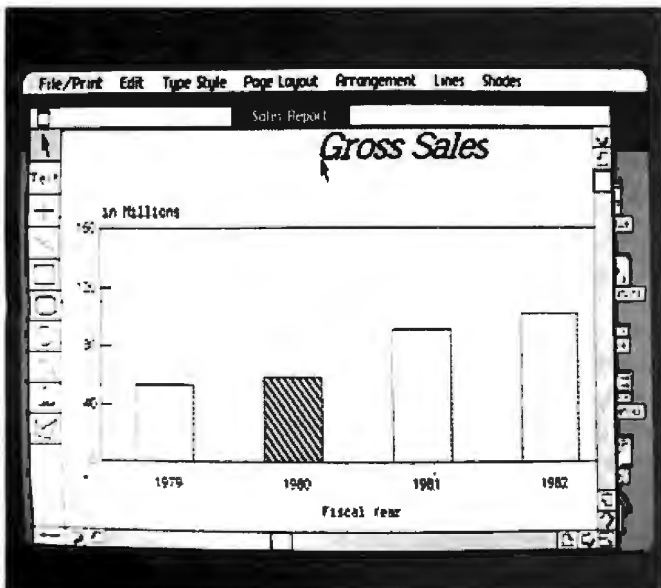

The Evolution of Software

It is instructive to see to what degree software is a part of Apple products. The basic Apple II, released in 1977, comes with about 16K bytes of object code. The Apple III, released in 1980, has about 200K bytes of code. The Lisa has more than 2 megabytes (2048K bytes) of code, a staggering figure that hints at the tremendous effort that goes into implementing a good piece of software.

The history of microcomputing has been exciting so far because it has enabled individuals working in their spare time to make significant contributions to the state of the art. But that has changed: now most state-of-the-art software is the province of teams of programmers hired by companies, as opposed to individual programmers working for themselves. As programs grow more sophisticated (requiring teams of programmers) and have to be more carefully planned to meet users' needs (requiring experts in given fields to be added to the team of designers), the implementation of programs is becoming a team effort. The days of the successful entrepreneur/programmer are probably gone.



Photo 3: The "mouse" pointing device is about the size of a package of cigarettes and has one button on top.

Foundations of the Lisa Design

The design effort that resulted in the Lisa computer is remarkably innovative because the designers did what designers *should* do—define the product's prospective customers, determine their needs, and *then* design a product to meet those needs. Apple was also willing to give its designers enough time and money (with no marketing restrictions attached) to first design and then create a computer that redefines the expression "state of the art." Granted, the Lisa's designers drew heavily on previous work done at Xerox PARC (Palo Alto Research Center), but they refined several borrowed elements and combined them with numerous innovations. (For further information on the design process, see "An Interview with Wayne Rosing, Bruce Daniels, and Larry Tesler" on page 90.)

Apple started this project with the intention of creating not only a product but the foundation for a whole new computer technology, one that would create computers literally anybody can use. The company's first task was to devise a new *user interface*—that is, a new and better way for humans to interact with the computer. The result was an internal (to Apple Computer Inc.) "User Interface Standards" document that describes how a user interacts with the Lisa system.

Although the Lisa design has several important elements, four stand out: the machine's graphics-mouse orientation, the "desktop" and "data-as-concrete-object" metaphors, and the integrated design of the hardware and software. Let's look at each of these in turn.

The graphics-mouse orientation: The traditional text display and keyboard input device make for a computer that is—let's face it—not too easy to use. Apple decided that the graphics resolution of the machine had to be high enough to use pictures (often called *icons* by Apple) in place of text. (For example, see the icons on the right-hand side of photo 2a.) Pictures are more easily recognized and understood than text. Because of this, you can

probably figure out that the garbage-can icon in photo 2a is used to throw something away.

Apple also knew that it needed a new, easier-to-use input device to move the frequently used arrow-shaped cursor. The designers passed over such devices as light pens and touch-sensitive video panels in favor of the *mouse*, a pointing device used in several Xerox PARC machines. The mouse, which is about the size of a pack of cigarettes, has a small bearing on the bottom and one or more buttons on the top (see photo 3). When you hold it in your hand and slide it across a flat surface, the mouse sends signals to the computer, which guide the video cursor in the direction that you've moved the mouse. The mouse Apple designed has only one button; Apple broke with the conventional wisdom of two- and three-button mice after user tests indicated that people aren't always sure which button to push on a multiple-button mouse.

With graphics of sufficient quality and a mouse, the Lisa lets you get what you want by pointing at it. Because the video cursor moves in direct response to the way the hand moves the mouse, you feel as if you're actually pointing at something on the screen. This has the positive psychological effect of making you feel in control.

The "desktop" metaphor: When you turn on the Lisa system, the screen is empty except for the presence of several icons. The Lisa computer depends on the metaphor that the video display is a desktop, while the icons are objects on the desktop. Each peripheral connected to the Lisa (floppy and hard disks, printers, and other peripherals connected by interface cards) is represented on the desktop by either an icon (if it is not in use) or a rectangular area called a *window* (if it is available for use). The Lisa computer normally replaces the conventional file directory with a collection of objects displayed in the window of the associated mass-storage device. Each file is represented by an object of some sort—usually a report, a tool, or a document—and objects can be grouped together in folders, which are also treated as objects. (Actually, the

(4a)

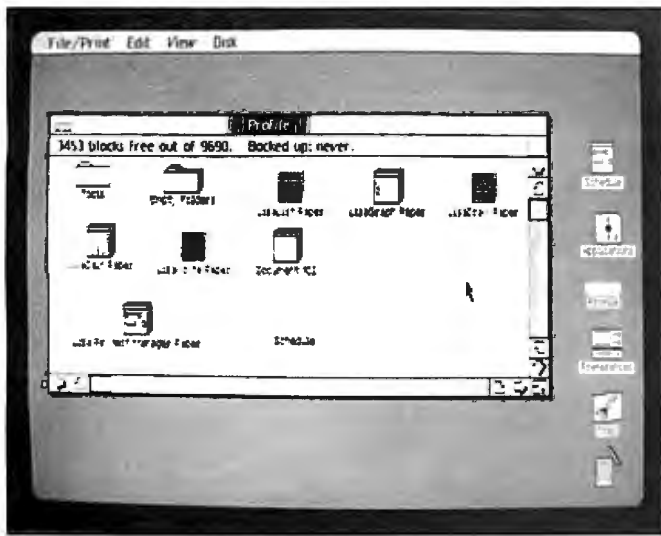

(4b)

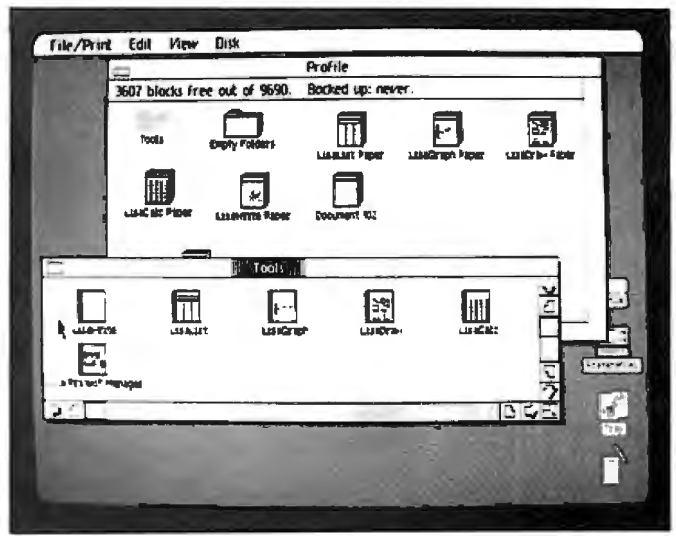

(4c)

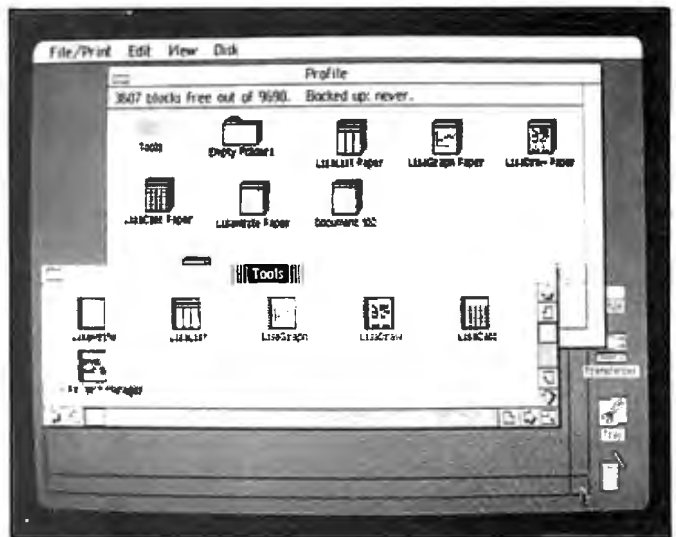

(4d)

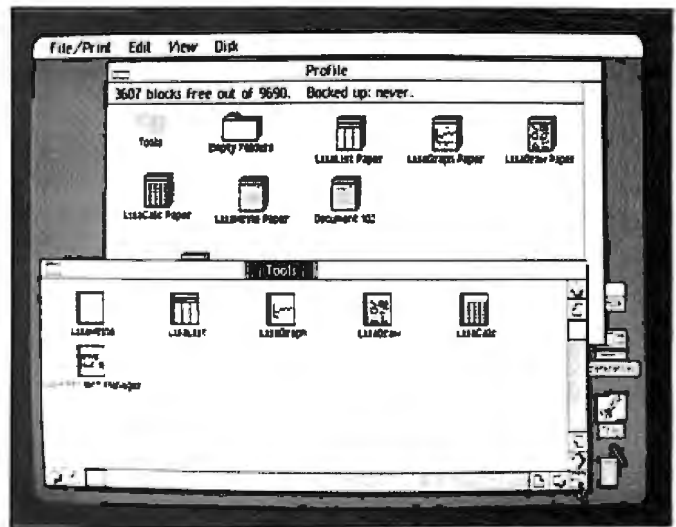

computer can give you a conventional directory on request, but only traditional computer users will ask for this option.)

An example of the Lisa file system will illustrate how useful this metaphor is. From a cleaned-up desktop with nothing but icons on the right of the screen, I use the mouse to point to the Profile (hard disk) icon and click the mouse button twice; this has the effect of "opening" the Profile and displaying its contents. The Profile icon changes to a white silhouette and its original black-on-white shape expands to a window named "Profile." (Photo 4a was taken after three items—shown as black icons—had been selected for manipulation. When the Profile icon is first opened, all of the icons inside it are white—that is, unselected.)

To view and then work with the contents of the Tools folder, I put the cursor on the folder and click the mouse button twice. The icon expands, leaving a gray silhouette and a window named "Tools," as shown in photo 4b. The window is just that—a window into whatever the Tools folder contains. The symbols on the margin of each window are points from which the cursor can direct several operations on the window. For example, when the cursor points to the small folder icon in the upper left-hand corner of the Tools window and the mouse button is clicked twice, the folder "closes" and the video display reverts to the image it had before the folder was opened.

If the Tools folder contains more than the window can show, you can do one of two things to see the additional contents. First, you can scroll the window either horizontally or vertically. Second, you can put the cursor on the expand/contract icon (in the lower right-hand corner of the window), hold down the mouse button, and move the cursor. An outline of the window follows the cursor (photo 4c); when the mouse button is released, the window grows to its new size (photo 4d).

Once you've been shown the mechanics of manipulating objects and windows, you have a working knowledge of

Photo 4a-d: File management on the Lisa system. Files, collections of files, and peripherals appear as pictures or icons (4a). When you open the Tools icon, its contents appear in a separate window (4b). The user can dynamically manipulate the window in several ways; in photo 4b-d, the window is enlarged.

(5a)

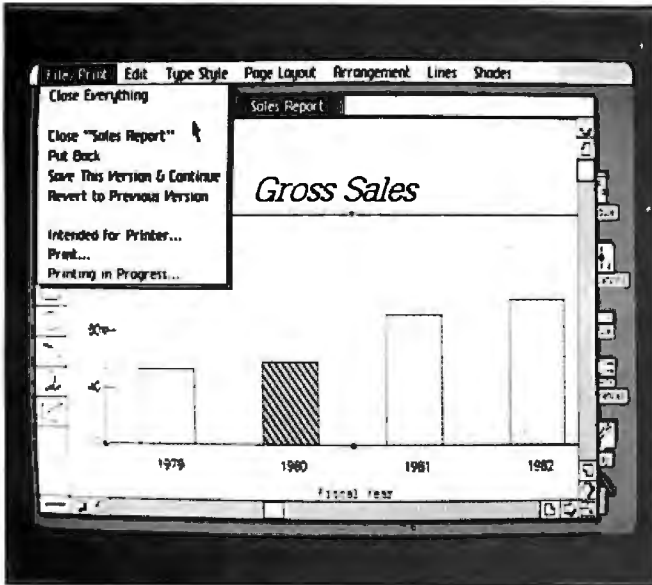

(5b)

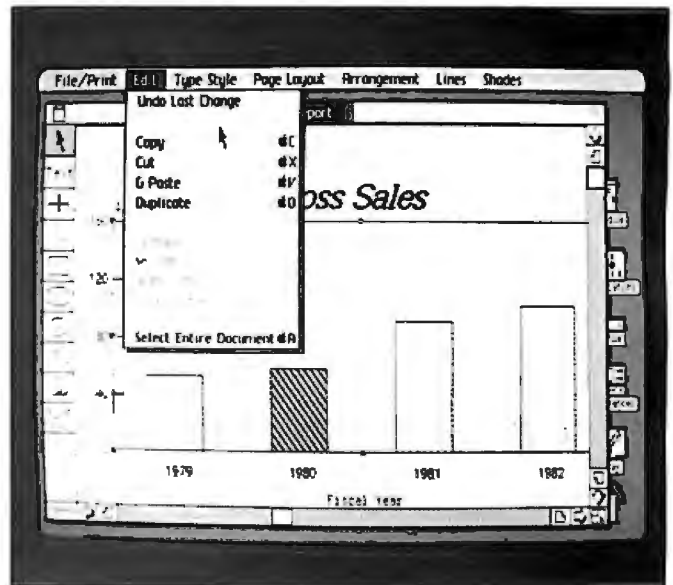

Photo 5a-d: Additional pop-up menus for the Lisa Draw program.

several essential operations of the Lisa file system (called the "Desktop Manager"). The desktop metaphor does two things for you. It helps you to remember certain operations because they make sense in the context of the object-related icons. Second, it draws on your general knowledge of office supplies and how they are used. These elements help Apple achieve its objective of creating a system that people can learn to use some aspect of in under 30 minutes.

The "data-as-concrete-object" metaphor: More than anything else, this metaphor is the foundation of the Lisa computer design and its probable success. As you can see from the example above, the Lisa file system makes you feel as if you are actually moving and changing objects, not merely manipulating abstract data. The Lisa Graph/Lisa Draw example shown in photos 2a through 2j creates the same illusion, as do all the other Lisa application programs.

The "data-as-concrete-object" metaphor depends on a condition most computer programs don't fulfill: that intuitively reasonable operations can be performed on objects *at any time*. Most computer programs have modes that restrict your activities at any given time; for example, many word-processing programs don't let you do numeric calculations and then incorporate them into the document you're writing. With the Lisa application programs, however, you can switch your attention from a sheet of Lisa Write "paper" to a sheet of Lisa Calc "paper" and back with no problem, just as you could if they were two sheets of paper on your desk.

Because you deal with recognizable objects such as folders and reports, you feel secure in the knowledge that your data will not disappear. "After all," it seems to be telling you, "computer files can mysteriously disappear, but folders, reports, and tools do not. If a file disappears, there's a logical explanation—either you threw it away or

(5c)

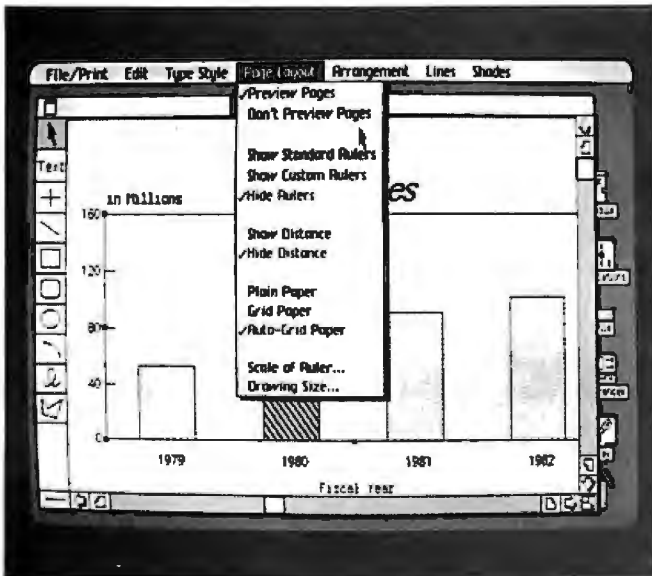

(5d)

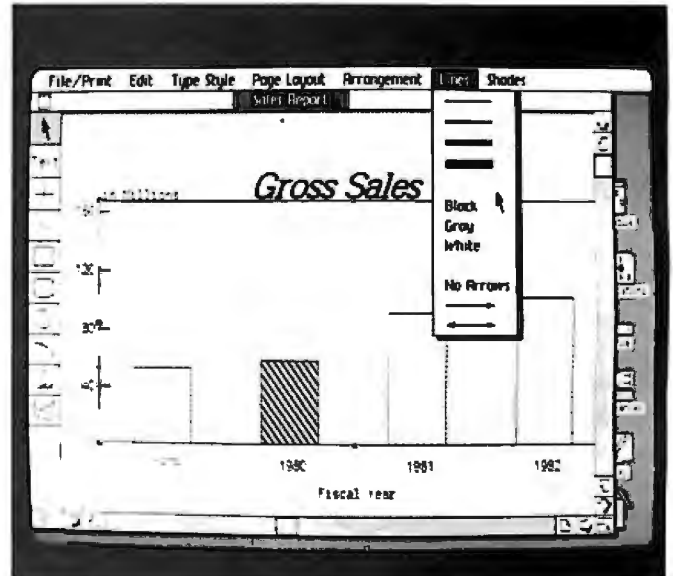

you filed it elsewhere. In either case, the situation is still under your control." In other words, the "data-as-concrete-object" metaphor *demystifies* the computer by transforming data into physical objects that behave in a predictable and reasonable way.

Integrated design: Not only is the Lisa computer the result of an integrated design, it is also the result of an *iterated* one. The Lisa hardware and software were designed only after Apple had identified the needs of its target users. Once a given version of the system was implemented, it was tested by the kind of people who would eventually be using it. The test findings dictated hardware and software changes, and Apple went through the design/test/revise cycle several times until everybody was satisfied with the result. This ensures that the Lisa does not fall prey to a problem common to microcomputers: being technologically sophisticated, but still hard or inconvenient to use.

During the iterations of the design process, the Apple design team looked for opportunities to have separate Lisa programs do their tasks in the same way. It then incorporated these common operating procedures into the Apple user-interface standard and tried to apply them to other Lisa programs. The result is a large amount of common behavior and structure among all the Lisa programs. For example, you enlarge or move a window the same way whether it is a Lisa Calc window or a Lisa Draw window. You also open, close, copy, and rename objects the same way throughout the system.

According to Apple, this attempt at standardization has two advantages. First, it shortens the time an average person takes to become comfortable with a system from a range of 20 to 40 hours (Apple's estimate, based on tests it conducted) to several hours. Second, it lets you apply what you learn in one program to all other programs. This commonality among Lisa programs is largely responsible for the ease with which beginners learn how to do something useful on the Lisa computer; it usually takes less than half an hour, even for people who have never sat in front of a computer before.

The Lisa Application Programs

The Lisa system will be offered with six application programs. Both new packages and improved versions of the first six programs will be offered at a later date, and in

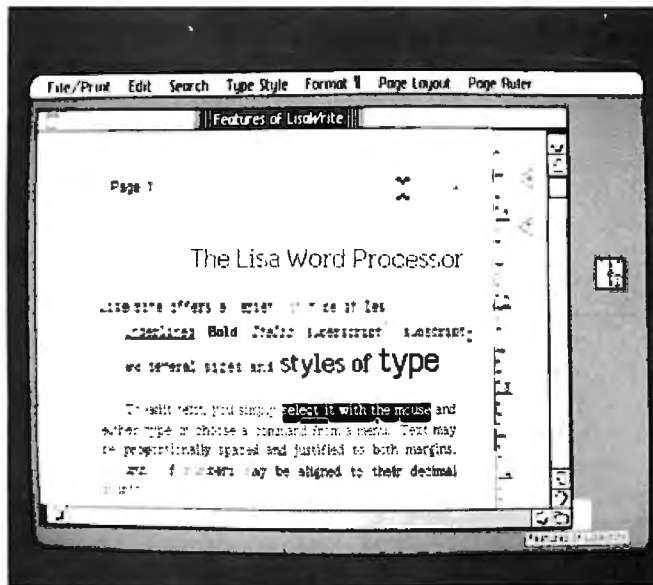

Photo 6: A document being prepared using Lisa Write.

time third-party software developers working with cooperation from Apple will create additional programs. At this writing, no price had been set for the programs, but Apple expects them to cost between \$300 and \$500 each, a justifiable price for programs of this caliber.

I don't have room here to describe all the features of each program. Instead, I will comment briefly on each one and say that, in general, all of them have more options and features than most people will use. (See photos in which pop-up menus are visible for an

idea of some of the commands available.) One in particular deserves mention: the "Undo Last Change" command, which is available in every program. This wonderful command lets you undo the effects of the last one you issued. It's a tremendous security blanket that enables you to experiment and work without worrying about making an irrevocable mistake.

Here are the six application programs (a telecommunications program, Lisa Terminal, is covered in the section on "Communications and Databases."):

The "Undo Last Change" command allows you to undo the effects of the last command you issued.

Lisa Draw is easily the showpiece of the Lisa system. The example in photos 2b through 2j shows only a small part of what it can do. See photos 2d, 2g, and 5a through 5d for some of the pop-up menus. Lisa

Draw enables you to draw lines, boxes, circles and ellipses, arcs, and polygons—all with the mouse. You can add text at any place in any of 11 typeface/size combinations. In addition, you can modify any typeface with any combination of underline, bold, italic, hollow, and shadow styles for a combination of 11 × 2⁵ or 352 distinct kinds of type. Lisa Draw has grids and rulers that can be displayed to help make drawings neat. Shapes can be selected and centered by a given horizontal or vertical edge. You also put Lisa Draw in an "auto-grid" mode that causes lines and shapes to align themselves with the grid you have chosen. Drawings can cover as many as 25 pages; Lisa Draw prints them out a page at a time and you join the edges together to make a larger drawing—a convenient feature if your drawing can't fit on one page. This program is a joy to use.

Lisa Write is the best "what-you-see-is-what-you-get" word processor I've seen. Between the keyboard and the mouse, you can add, change, delete, and move text, change its appearance, reformat it, and do just about

(7a)

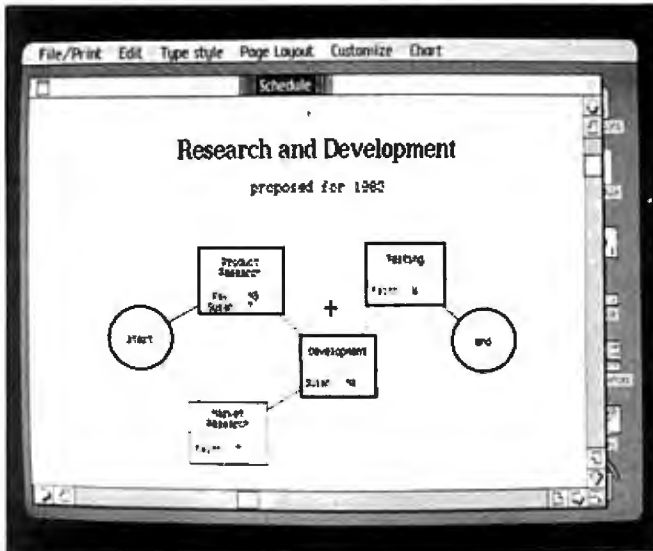

(7b)

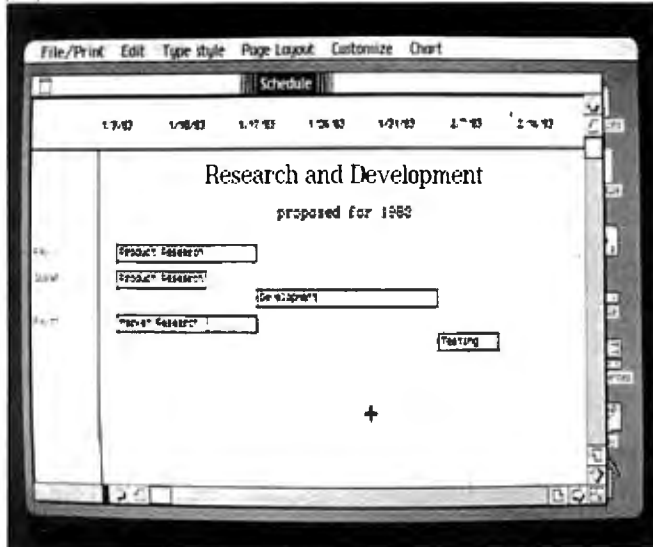

(7c)

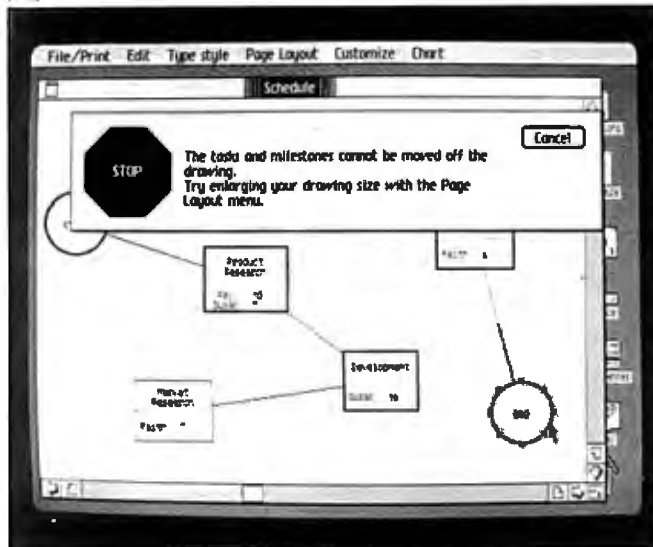

Photo 7a-c: The Lisa Project Manager program. Photo 7a shows a simple PERT chart with tasks on the critical path being heavily outlined; 7b shows a Gantt chart, which shows personnel utilization; 7c shows the kind of typical error message used throughout the Lisa system.

anything you'd want to in a word processor. Of course, you can see each page exactly as it will appear on paper (see photo 6). My only criticism of the program is that the version I saw paused a second or so between when I typed a phrase and when it appeared on the screen. The delay is due to the large amount of processing the machine has to do before it can display the new text (and perhaps scroll other text down), but the designers are aware of the problem and are working on minimizing the time delay in the final version.

Lisa Project is used to keep track of projects and personnel, and it does so using PERT (Program Evaluation and Review Technique), Gantt, and task charts. Using the mouse and the keyboard, you can add, delete, move, change, and label activity boxes. Each box contains the activity name and its personnel and time requirements. The Lisa Project program displays the PERT chart (see photo 7a), drawing a heavy outline around the activity boxes on the *critical path* (a path of activities for which delays will lengthen the duration of the project). The program can also optionally use such information as worker vacation times and the length of the work week to influence the final chart. You can also have the program show the early-start, early-finish, late-start, and late-finish dates associated with the PERT method. The Gantt chart (photo 7b) shows resource utilization over time, including unutilized resources (shown in gray). The task chart (not shown) displays tasks by their early-start date.

Like the rest of the Lisa system, Lisa Project gives you incredibly clear error messages. For example, when you try to take the "end" circle off the screen, you get the error shown in photo 7c, which must be answered before you can continue.

Lisa Calc is as sophisticated a spreadsheet program as any other on the market. In this instance, I don't think the mouse improves on cursor keys because one hand has to alternate between the mouse (to move the spreadsheet cursor) and the keyboard (to enter data into the spreadsheet cells). In any case, most people who want a Lisa computer are interested in the kind of structured numeric recalculation that spreadsheets are good at, and Lisa Calc certainly fills this need. Of course, data can be traded between Lisa Calc and other Lisa programs without restriction, which means, for example, that you can "paste" a section of spreadsheet data into a document being prepared by Lisa Write. Photos 8a and 8b show the process of displaying the formula of each cell along with its value.

Lisa List, a single-user database that permits records of up to 100 fields totaling 1000 bytes, probably illustrates best the "data-as-concrete-object" metaphor. When you add, change, or search for records, you work directly on the list visible in the window, not on an auxiliary display (like a data-entry screen) that limits you to working on the current record only. Record fields are defined as being one of eight data types (text, number, date, money, time, social-security number, phone number, or zip code), and Lisa List does automatic type-checking during data entry. Photo 9 shows an example of a Lisa List window. One

slight problem is that the social-security number, phone number, and zip code fields have fixed formats—for example, zip codes are limited to five digits. You must revert to the general-purpose text format if you want to be able to convert to 9-digit zip codes or use foreign telephone numbers.

Lisa List has many attractive features. Of course, you can display or print parts of the list in many ways; you can sort the list in several ways or select records according to given criteria. You can move the cursor with either the mouse or the arrow keys. The contents of fields are stored internally in a compact form to increase the overall storage capacity of the program. In addition, Lisa List has two very useful features that every database should have: the ability to add fields to or change field widths in an existing file and the ability to put any amount of information in a field regardless of its stated width (field width influences only how much data is visible).

Lisa Graph is an application program that creates a bridge between the number-oriented Lisa Calc and the picture-oriented Lisa Draw. Lisa Graph takes a matrix of numbers (entered either by the user from Lisa Graph or transferred from another source) and creates virtually instantly a bar, line, mixed bar and line, scatter (*x-y* plot), or pie chart. Photo 2a shows a typical Lisa Graph window, and the sequence of photos 2a through 2j shows how Lisa Draw can customize a drawing from Lisa Graph.

Reliability

Computers are worthless if nobody uses them, and the Lisa system has made great strides toward eliminating that possibility. Certainly, it has been designed to be easy to use. But the Lisa system will probably be used by computer novices because of its *reliability*, both in the physical and psychological sense.

Physical reliability is the kind that makes an engineer feel secure. Apple IIs, for instance, have a reputation for being very reliable, and I'm sure that the Lisa computer was engineered with even more care. (For example, the Lisa is constructed as a series of modules, any one of which you can pull out without tools. And despite its internal complexity, it was engineered to dissipate excess heat without a cooling fan—*that's* engineering!)

I can't say how reliable the Lisa is overall because I don't have enough direct experience with it. But I do know that Apple has concentrated on improving the reliability of the source of a great many problems: the floppy disk. Despite the features of the Lisa disk drive that put it at the leading edge of disk technology (see the text box "The Lisa Hardware" for more details), Apple claims that the hardware (assisted by its sophisticated disk-accessing software) has an error rate so low that Apple couldn't quantify it during tests. Apple said, however, that the hardware makes less than one error in one trillion (10^{12}) operations.

Apple has also adopted a redundant data structure for information on the disk that lessens (or sometimes eliminates) the effect of losing a sector of information. This redundancy is on three levels—blocks, files, and

(8a)

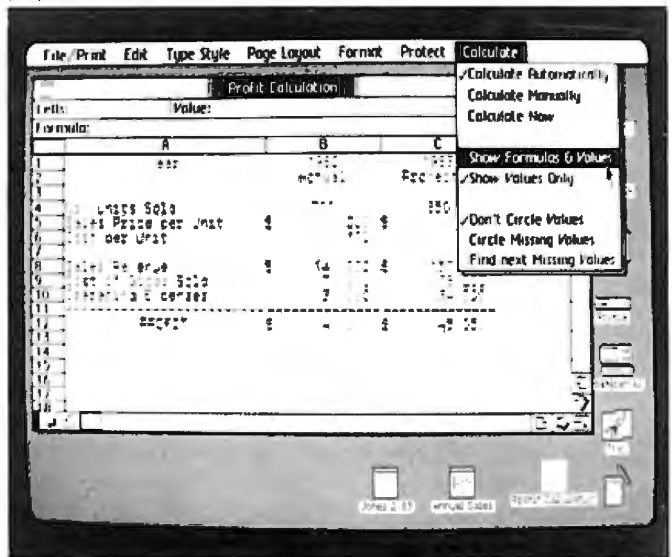

(8b)

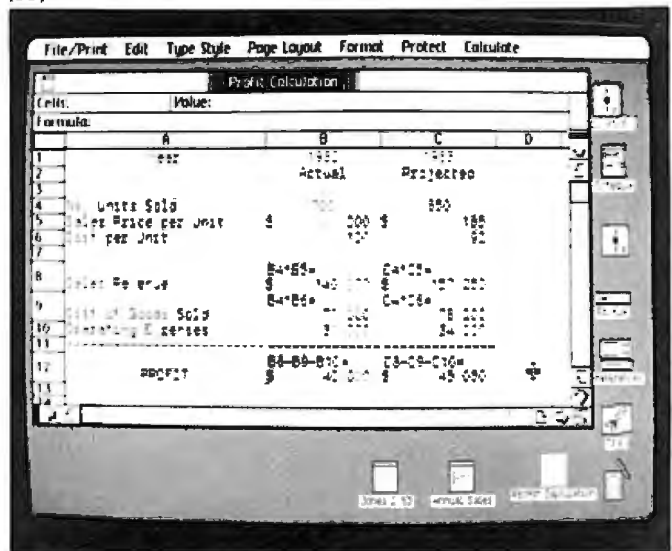

Photo 8a-b: The Lisa Calc program. Photo 8a shows a simple spreadsheet; 8b shows the same spreadsheet after the "Show Formulas and Values" command is executed.

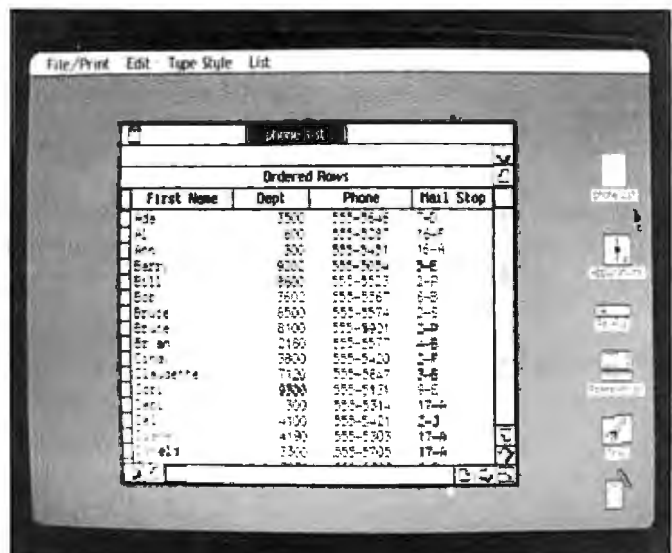

Photo 9: The Lisa List program, a single-user list-management program.

The Lisa Hardware

Reporting on the technical specifications of a computer toward the end of an article is unusual for BYTE, but it emphasizes that the why of Lisa is more important than the what. For part of the market, at least, the Lisa computer will change the emphasis of microcomputing from "How much RAM does it have?" to "What can it do for me?" For example, it is almost misleading to say that the Lisa comes with one megabyte of RAM, even though the fact itself is true. That doesn't mean that the Lisa is sixteen times better than machines that have 64K bytes of RAM. Nor does it necessarily mean that the Lisa can work on much larger data files than other computers; its application programs each take 200K to 300K bytes, which significantly reduces the memory available for data. It's more instructive to say, for example, that the Lisa with one megabyte can hold a 100-row by 50-column spreadsheet (as its advertisements state). With this in mind, let's take a look at the Lisa.

"Lisa" stands for Local Integrated Software Architecture, but it's really just an excuse to retain Apple's pet name for the project. The Lisa has a 68000 microprocessor, which is a true 16-bit microcomputer that has a 16-bit data bus, a 24-bit address bus (giving access to 16 megabytes of memory), and 32-bit-wide registers (all but the 16-bit status register). The 68000 in the Lisa runs at a frequency of 5 MHz. It can have up to 1 megabyte of memory with parity and comes standard with one megabyte (1024K bytes).

The video display is a 12-inch monochrome monitor (black and white, not tinted) with a resolution of 720 by 364 pixels. The interlaced image is refreshed at 60 Hz, which eliminates the possibility of eyestrain from subliminal flickering. The video display is completely generated by internal software, so the Lisa can use multiple character sizes and fonts without restriction. It also means that Apple is not restricted to any one style of video image; the designers can radically change the behavior of the system with a new release of software.

The Apple 871 disk drives design (called "twiggy drives" inside the company) are significantly different from conventional floppy-disk drives. Each one uses a 6504 microprocessor as a "smart" interface between it and the Lisa. The drives use special high-density, double-sided floppy disks that have two oval cutouts in the jacket (see photo below). These are essential because the two disk heads, in addition to being on opposite sides of the flat magnetic media, are not pointed at each other with the magnetic media between them, as is the case in all other double-sided floppy-disk drives. Instead, a pad presses the rotating magnetic media to the disk head on the opposite side of the media as is conventionally done with single-headed floppy disks.

Each formatted disk holds 860K bytes of information at a density of 62.5 tracks per inch; together the two drives (standard on the Lisa) hold 1.72 megabytes of data. Each drive also contains a mechanism that releases the disk for removal under program control, which prevents the user from removing a floppy disk prematurely. As with other Apple products, the floppy disks rotate only when the drives are reading or writing data, thus extending the lives of both the drives and the medium.

Apple has done several things to achieve its unusually high data density. The designers used an encoding scheme that keeps a constant data density of 10,000 bits per linear inch; this allows the outer floppy-disk tracks, which have a larger circumference, to store more data than the tracks nearest the

center of the disk. In addition, the disk-access system software can move the disk heads in fractions of a track width to search for and find the middle of the track. That's an important feature when you're reading disks with small variations in track width.

In addition, the Lisa comes with one Profile (Apple's 5¼-inch Winchester-type hard disk) to the Lisa through its parallel port. It adds 5 megabytes of magnetic storage to the Lisa system, and speeds up the overall operation of the system. Additional Profiles can be added via interface cards.

The Lisa computer is never really turned off. It stores "system preferences" (things like speaker volume and video contrast) and system-configuration information inside the computer. Even when it is turned "off," it draws enough power to keep the clock/calendar and CMOS memory containing the above information working. When it's unplugged (for example, when it's being moved to another location), internal batteries preserve the clock/calendar status and CMOS memory for up to 20 hours.

The Lisa includes two programmable serial ports and one parallel port as well as three expansion-board slots, each of which connects directly to the system bus and has direct memory access (DMA) capabilities. Because none of these slots is filled in any "basic" configuration of the Lisa, they are available for future expansion (unlike the IBM Personal Computer's five slots, most or all of which are used for much-needed video-display and memory cards). Other features include a built-in speaker and a real-time clock (which can be programmed to execute tasks or turn the computer itself on or off at a given time), a microprocessor-controlled detachable Selectric-style keyboard, and a mouse.

I must thank Apple for including something I've wanted to see for a long time: unique serial numbers encoded into memory. The Lisa has two of these: an actual serial number



The Lisa keyboard.



The Lisa floppy-disk drive, along with the special floppy disks it uses.

and a 48-bit number meant to be used as a "mail address" identification number for a network of Lisa computers. Two unique identification numbers will help to prevent the unfortunate but very real problems of software piracy and the existence of copy-protected disks that won't work for even their legal user. Software can be "mated" to the serial number of a given machine so that it can be backed up endlessly but will not run on another Lisa computer. True, a persistent few will outwit even this scheme, but it will practically eliminate a manufacturer's sales losses from copied software.

An interesting aspect of the Lisa is that it abandons hardware graphics chips like the NEC 7220 for system software that requires the 68000 micro-processor to generate and maintain the video image. At first, I questioned the wisdom of this decision because it makes the 68000 assume a heavy computational burden that could be transferred from software to hardware. But according to the designers, the use of a dedicated hardware graphics chip would itself limit and slow down the system (for a discussion of this, see the interview on page 90). In particular, the 68000 clock was set at 5 MHz instead of the usual 8 MHz to give the hardware just enough time to access the 32K bytes of screen memory during the machine cycles in which the 68000 is not using the address lines. This gives the Lisa access to the video memory that is transparent to the 68000 (hardware

Ease of use is the first thing that a novice Lisa user experiences.

A reproduction (at 80 percent) of printing from the Apple Dot Matrix Printer.



Inside the Lisa computer. Note the three connectors for expansion boards.

graphics chips severely limit access to the video memory) and results in a static-free image. (Much of the static or "hashing" in graphic video images results from the system accessing the video memory while the circuitry is using it to generate the video image.)

Apple will also be offering the Apple Dot Matrix Printer

and the Apple Letter Quality Printer. Apple's engineers tested many existing printers, chose two (from C. Itoh and Qume, respectively) that best met their needs, then had the companies produce modified versions with Apple-specified hardware and soft-

ware changes. Apple needed such exacting print quality because the Lisa software is very demanding of both printers. For example, both printers will reproduce almost exactly both the text and graphics that can be displayed on the Lisa screen. In addition, Apple has created special print wheels for its Letter Quality Printer so that you can print normal, italic, underlined, and bold characters without changing print wheels (quite a nice move—who's going to change print wheels several times a page just to get true italics?). The amazing thing about the Apple Dot Matrix Printer is that Apple plans to sell it for around \$700 (the Letter Quality Printer will sell for about \$2100). Unfortunately for Apple II and III owners, these printers' tricks are done entirely in software on the Lisa and won't transfer to other Apple computers.

disks—and a given level in error is correctable by data in the next lower level. On the block level, each 512-byte block of data has a 24-byte area of *hint bytes*. These identify the file to which the block belongs and its block number within the file. On the file level, each file contains a header that duplicates information in the disk catalog. On the disk level, each floppy disk keeps a file of information about the status of each file on the disk. The Lisa system software automatically tries to reconstruct

information that is lost, so it recovers from errors that would halt other computers.

Psychological reliability is the kind that makes an office worker secure. The Lisa floppy-disk drive is unique in this respect. On the Lisa computer, you can't yank your floppy disk out any time you want to (if you could, you might, for example, remove the disk before files on it are updated). Instead, you press the Disk Request button beside the disk-drive slot. The software in the Lisa com-

When one terminal is not enough

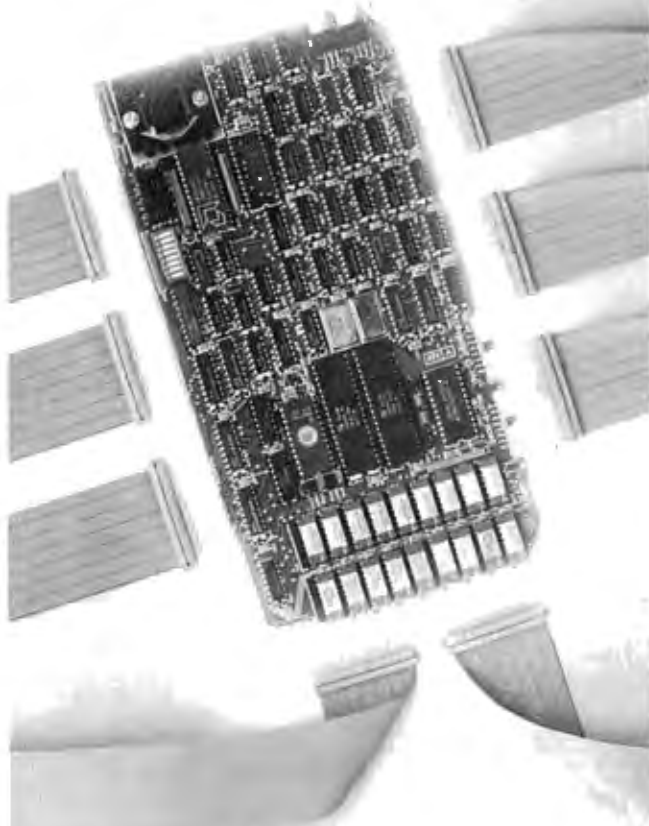

Add a MuSYS Slave!

Expand your Z80A/S-100 based micros with MuSYS slaves and TurboDOS*. Our NET/82 slave board has everything you need for another station: Z80A CPU, up to 128K bytes of RAM, two serial ports, a priority interrupt controller, memory parity checking, and many other features. There isn't a more cost-effective way to add complete, hardware-isolated network slaves to your system. And TurboDOS makes it even better. It's faster than CP/M®* for systems functions, supports larger files (134 MB) and disks (1048 MB), and unlike CP/NET* it's compatible with nearly all 2.2 applications software. Many features which are optional, extra-cost, or not available at all in CP/M are standard with TurboDOS. Call today for all the details. Generous dealer/OEM discounts available.

*TurboDOS is a trademark of Software 2000, Inc.; CP/M and CP/NET are trademarks of Digital Research, Inc.; NET/82 is a trademark of MuSYS Corp.

MUSYS
CORP
Specialists in Multi-user Microsystems

1752 B Langley
Irvine, CA 92714
(714) 662-7387
TWX: 910-595-1967
CABLE: MUSYSIRIN

puter checks your work space, closes any files belonging to that disk (thus updating the file), then ejects the floppy disk so you can remove it.

A similar thing happens when you turn the Lisa "off" (actually, it's never completely off; it just goes into a low-power mode). In any case, when you hit the Off button, system software automatically closes all open files, thus transferring the information in them to their respective floppy disks, and releases the disks from the Lisa disk drives. In addition, the software records the status of the "desktop" so that, when the computer is reactivated, Lisa automatically returns it to the appearance and state it was in when the Lisa was turned "off." Although those who have worked with computers before will find these features hard to get used to, most newcomers will be reassured by them.

The design of the Lisa application programs (which are the only things most Lisa users will see) is another example of psychological reliability. Many people have vague fears of computer programs because they think they'll do something wrong and cause a catastrophe that will make them look foolish. This won't happen with the Lisa system for two reasons. First, the Lisa software is designed to be very understandable. The metaphors make people comfortable with the manipulation of data, error messages are both clear and complete and tell you what alternatives you have, and, in general, the programs let you know where you stand and the consequences of a given action. Second, the Lisa computer has the "Undo Last Change" command mentioned earlier. With this command, even the most uncertain users will not hesitate to act in a way they think is appropriate. The way Lisa programs work, the user probably *is* right, and if he isn't, he knows he can undo whatever happens. People who won't trust most computer programs will trust Lisa programs.

Communications and Databases

As the engineer I talked to pointed out, no computer is going to be the most important piece of equipment in an office unless it can easily interact with other computers. This need has been integrated into the design of the Lisa system in several ways.

First, a communications program called Lisa Terminal allows the Lisa computer to emulate several popular terminals (Digital Equipment Corporation's VT52 and VT100 terminals and Teletype Corporation's ASR-33). The Lisa Terminal program includes all the options that a given terminal allows, even down to simulated status lights. A future Apple terminal program will enable the Lisa to emulate the IBM 3270 family of terminals.

Second, Lisa computers can be connected together via a new local network called Apple Net, which Apple hopes to promote as an industry standard because it feels that other networks have major cost or performance problems. According to Apple, Apple Net meets four criteria that it thinks are important: it can be easily installed by the user, it is highly reliable, it is easily extendable to include more nodes or to interface with other networks (like Ethernet and other Apple Net networks), and it has a low per-node

TIME SPECTRUM®

Only the new TIME SPECTRUM brings you a galaxy of expansion options for your IBM-PC® with the new VERSAPAK® family of expansion modules.

COMPAK SERIAL EXPANSION MODULE - Adds a second serial asynchronous port to the TIME SPECTRUM foundation module.

SNAP ON STANDOFFS - For mounting VERSAPAK modules to foundation modules.

SYNCPAK SYNCHRONOUS EXPANSION MODULE - Adds two serial synchronous ports to the foundation module.

RAMPAK MEMORY EXPANSION MODULE - Adds memory expansion to 512KB and an optional second serial asynchronous port to the foundation module.

CLIFFHANGER® - Proprietary mounting hardware simplifies installation of I/O lines.

\$475

64KB RAM, calendar clock, 1 serial port installed.

TIME SPECTRUM FOUNDATION MODULE - Contains a Real Time Clock, 64KB RAM (expandable to 256KB), serial asynchronous port, optional parallel printer port, and interface connections for VERSAPAK modules.

Watch for new VERSAPAK modules to be introduced soon.

For more information on the revolutionary new TIME SPECTRUM and VERSAPAK expansion modules, see your nearest IBM-PC authorized dealer or contact:

PERSYST

15801 Rockfield, Ste. A, Irvine, CA 92714
714-859-8871

Circle 335 on Inquiry card.

(under \$500) cost. A-Net has a bandwidth of 1 megabit per second, can have up to 128 nodes, uses a shielded two-conductor wire for interconnecting nodes, and can have a maximum node-to-node distance of 2200 feet. Apple Net uses the same method as Ethernet to avoid message collisions (CSMA/CD—carrier-sense, multiple access with collision detection) and is compatible with the Ethernet on the top five of the seven levels of communication protocol. For those who want it, though, Apple will also make Ethernet interfaces available at a cost of about \$1500 per node.

Third, Apple has distant plans to make it possible for Lisa computers to talk to non-Lisa computers and to shared or remote databases. Although the people at Apple did not discuss specific products, they told me enough to assure me that they are planning extensions in this direction that will make it even more useful.

When these items are available for the Lisa, Apple will have overcome a very big problem: really integrating the computer into the full office environment. That usually includes both local and remote computers. Whatever the needs of a given office, the above products ensure that the Lisa computer will be as useful as any other "office automation" product available from other companies.

Service

The people I talked to at Apple made it clear that, with regard to Lisa, they were going to offer better service options than any other computer company, including IBM,

DEC (Digital Equipment Corporation), and Wang. A diagnostic program called Lisa Test (supplied with the Lisa) enable it to isolate the computer failure to a single board or component; in the case of severe problems (when the disk drives aren't working, for example), a built-in test program that runs whenever the Lisa is turned on will diagnose and report on the problem. As I mentioned before, the Lisa is designed so that you can take it apart without tools (a detailed manual explains how).

Apple offers several service options. If you have on-site service (available through a joint agreement with RCA), you simply call Apple and let a service person fix the problem. For large-quantity customers, Apple can provide training to teach employees how to do in-house repairs. For individuals, Apple Care Carry-In Service is available.

In addition, Apple is planning what it calls Direct Phone Support. For a yearly fee, the user will have access to a toll-free number that is answered by a highly trained support person. Apple has high standards for this service, and I'm sure that, once the service has started and is running smoothly, Apple will deliver what it promises. The company expects its representatives to answer 90 percent of the calls received; people whose problems cannot be answered immediately will be called back when the answer is found. If equipment needs to be repaired, the Direct Phone Support person will call the

computational value through unequaled performance



A LMC MC68000 system with 1.5 megabytes of error-correcting RAM.

LMC

The Logical MicroComputer Company

The Logical MicroComputer Company 16-bit microcomputers are general purpose computer systems designed for maximum performance and reliability using state-of-the-art technology. Our systems bridge the gap between single-user personal computer systems and much more costly minicomputers. They are ideal for applications requiring either more processing power or more memory than "personal" computers. In addition, they support many more users simultaneously—for example, LMC systems can support up to 32 users simultaneously and soon will be available with virtual memory. With approximately ten times the throughput of the older 8-bit microcomputers, they are suitable for tasks ranging from pure engineering and scientific applications (arithmetic processing and process-control) to business applications requiring multiple users or large data files. And, since these systems are the most expandable microcomputers available, they are an excellent choice for any application where future growth in computational requirements is likely.

140 South Dearborn, Chicago, Illinois 60603 USA, 312.580.0250

Write or call for LMC's product brochure or technical specifications.

BASF QUALIMETRIC™ A TOTALLY NEW DIMENSION OF QUALITY.



From BASF comes a totally new level of excellence in magnetic media—the Qualimetric standard, a standard so advanced that BASF FlexyDisks® are confidently backed by an extraordinary new lifetime warranty.* The Qualimetric standard is maintained without compromise through every step of BASF design, production, inspection, and testing...reflecting an unwavering BASF commitment to media fidelity and durability.

Our FlexyDisk jacket incorporates a unique two-piece liner that not only traps damaging debris away from the media surface, but also ensures precise media-to-head alignment. The result—certified 100% error-free performance, backed by BASF's exclusive lifetime warranty.*

For information security, tomorrow and beyond, look for the distinctive BASF package with the Qualimetric seal. Call 800-343-4600 for the name of your nearest supplier.

Circle 44 on Inquiry card.

ENTER TOMORROW ON BASF TODAY



BASF

appropriate repair people and dispatch working modules, so that one call will usually solve the problem. Different support-option plans available will range from 9 a.m. to 5 p.m. weekday service to 24-hour-a-day, 7-day-a-week call-in support. Apple also plans to provide software revisions and support through this option, although details had not been decided on at this writing.

Documentation and Training

I have seen only drafts of miscellaneous pieces of Lisa documentation, but they indicate that the final documentation will be superb. Apple plans to provide the *Lisa Guide*, an interactive teaching program about the Lisa system, and reference books for each application package; each reference book will begin with a short tutorial section that will get users doing useful tasks in under half an hour. Other documentation may be included, but the information was not available at the time we went to press.

Even though the Lisa is meant to be a very easy product to use, Apple will provide training to make sure that people learn how to use it. As one Apple spokesperson put it, "Training is part of the Lisa product." Apple will offer extensive training to all Apple dealers and to selected groups from companies that make large-volume Lisa purchases. Apple will also make training kits available to multiple-unit purchasers to help them train their

employees. Individual Apple dealers may offer additional special training.

Future Plans

In the microcomputer industry, products are generally announced early (sometimes before they are designed) and released in preliminary versions before all the features have been integrated into them. Apple is to be commended for resisting this practice. In fact, the company seems to have released a more complete first version of the Lisa than most companies do with their products; the first Lisa sold will be a fine machine.

However, the ambitious and talented people who designed and implemented the Lisa computer have already envisioned and planned for quite a bit more than they can implement by release date. I'm sure they have some ideas they don't want to publicize (and rightly so), but here are some things they were willing to talk about:

- By 1984, Apple plans to replace its 512K-byte memory card (two of which can be fitted into the Lisa computer) with 1-megabyte cards, thus increasing the memory capacity from 1 to 2 megabytes.

As for languages, Apple plans to introduce version: of BASIC, Pascal, COBOL, and even the language/operating system Smalltalk as soon as possible, and others will follow.

- As soon as possible, Apple plans to introduce versions of BASIC, Pascal, and COBOL for the Lisa. The BASIC will be compatible with Digital Equipment Corporation's BASIC Plus (unlike IBM Personal Computer BASIC, it will be able to use the extra memory above the first 64K bytes). The first releases of these languages will be "plain vanilla" versions that don't interact with the computer's special features (e.g., mouse control of the cursor, windows, the "desktop" metaphor), but later versions will probably integrate these languages into the Lisa system.

- Another language that will be available for the Lisa computer is Smalltalk. I was pleased to see Smalltalk working on a Lisa computer—a year and a half has passed since our special Smalltalk issue in August 1981, and no commercially available computer to date has used it. Smalltalk on the Lisa computer will change that. It is a very "possessive" language that directly controls the machine it is implemented on, so it will probably never be integrated into the Lisa environment—but then, it doesn't need to be.

- Smalltalk is just one example of a language/operating system that can occupy the Lisa machine. The Lisa will also support Digital Research's CP/M family of operating systems and Microsoft's Xenix (a licensed version of Unix that includes business-related extensions). Outside developers will be encouraged to carry operating systems

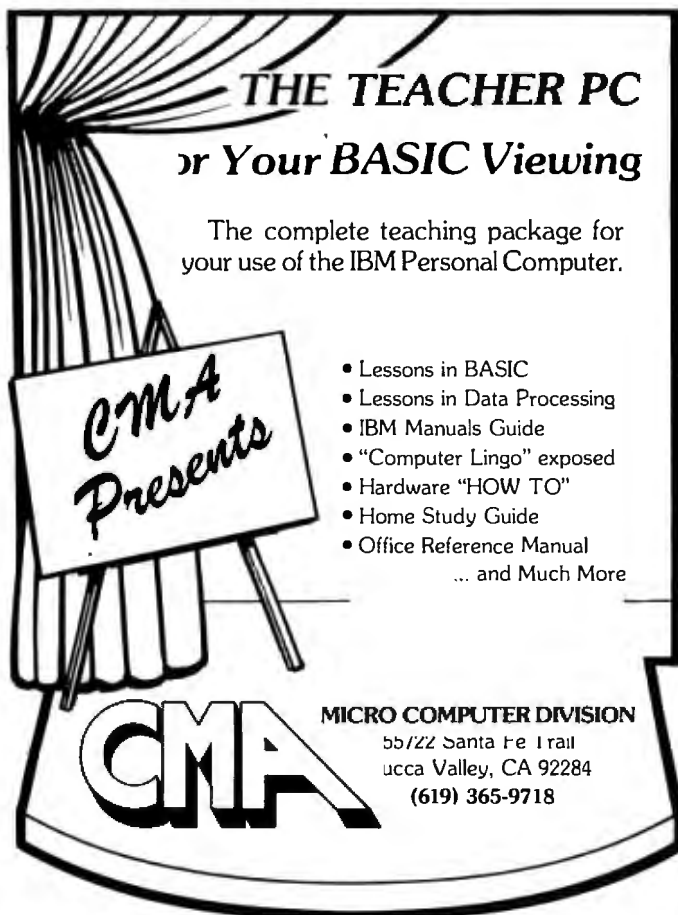

THE TEACHER PC
or Your BASIC Viewing

The complete teaching package for your use of the IBM Personal Computer.

- Lessons in BASIC
- Lessons in Data Processing
- IBM Manuals Guide
- "Computer Lingo" exposed
- Hardware "HOW TO"
- Home Study Guide
- Office Reference Manual
- ... and Much More

CMA

MICRO COMPUTER DIVISION
55722 Santa Fe Trail
UCCA Valley, CA 92284
(619) 365-9718

CP/M[®] GRAPHICS[™]

Your ticket to success.

Take the lead in microcomputer applications with powerful graphics software from Digital Research. CP/M and GSX are the keys to your graphic future. GSX is a logical extension of CP/M which many OEMs are adopting to standardize graphic device I/O. Computers with GSX allow your programs to take advantage of integrated graphic displays and peripherals like plotters, printers and CRT terminals. Together, CP/M and GSX deliver the same vital portability for your programs and data that has made CP/M the most accepted operating system in microcomputer history.

We also supply GSS-KERNEL[™], a library of graphic commands for drawing lines, polygons, and text according to the emerging ISO standard: GKS (Graphical Kernel System). We also offer GSS-PLOT[™], a library designed to let you create bar graphs, pie charts, histograms, and scatter plots. Both of these

libraries can be linked with CBASIC[®] Compiler, Pascal/MT +[™], PL/I and FORTRAN on 8- and 16-bit systems. When you put it all together, the Digital Research graphics family is the most complete system you can buy for development and execution of graphic-oriented applications. Whether you're an application developer, OEM or user of microcomputers, call Digital Research for your ticket to graphic success. (408) 649-5500, 160 Central Ave. Pacific Grove, California 93950.

Circle 147 on inquiry card.

**DIGITAL
RESEARCH[™]**
The creators of CP/M[™]



GSS-KERNEL and GSS-PLOT are trademarks of Graphic Software Systems, Inc. The logo, tagline and names of DRH products are other trademarks or registered trademarks of Digital Research.

across—one such possibility is Softech Microsystems' UCSD p-system.

• Apple will be making enhancements to the existing Lisa application programs. On first release, the only limitation in sharing data among Lisa application programs is that you won't be able to "paste" graphic images into a Lisa Word text document (you can, however, add text to a Lisa Draw drawing). Bruce Daniels, one of the Lisa designers, told me that the design allows for adding graphics to a text document but that they simply can't implement the feature in time for the first software release. It will be added by the next release.

• Apple is very conscious of the fact that the success of the Lisa will be heavily influenced by the availability of good third-party software. To encourage such software, the company will make available a "programmer's toolkit" package of software and documentation sometime this year. This toolkit will give third-party programmers all the information they need to build on the considerable utility software (window-control, disk-accessing, intelligent graphic-redrawing, and memory-management routines, for example) already available in the Lisa operating system. (The operating system itself is about half a megabyte of code, though only 200K to 300K bytes of it are resident in memory at the same time.) In addition, the toolkit will list the user-interface conventions that were used to create the existing six application packages and will strongly suggest that third-party software

will be better received (by both Apple and the consumer) if it follows these conventions. The Apple-generated application programs are so wonderful that most programmers will consider it an achievement to create similar software.

Caveats

I wrote this article after working with a Lisa computer for several hours and studying various Lisa documents. The application packages were completely functional, but I was told changes were still being made to them. The released versions of software may be faster because debugging aids were probably slowing down the version I saw.

Performance

The Apple Lisa was faster than I remembered a similar machine being (an experimental Xerox machine running Smalltalk) and faster than I expected it to be. Granted, a 68000 microprocessor is in the computer, but it was being asked to do a lot—including the manipulation of 32K bytes of video-display memory. Objectively, I must report some delays (30 seconds, maybe) when loading in files, but these were shorter than what I usually encounter using CP/M-based business programs. In any case, I didn't notice any delays while actually using a given program, which is where you spend most of your time, anyway. I expect that the Lisa computer you'll see in Apple showrooms will be slightly faster than the one I saw.

Conclusions

As you can tell, I am very impressed with the Lisa. I also admire Apple for deciding to make the system without being unduly influenced by cost or marketing constraints. The Lisa couldn't have been developed without such a deep commitment, and no other company I can think of could afford such a project or would be interested in doing it this way (the Lisa project reportedly cost over \$50 million and used more than 200 person-years of effort!). In terms of the actual, as opposed to symbolic, effect it will have on both the microcomputer and the larger-computer market, the Lisa system is the most important development in computers in the last five years, easily outpacing IBM's introduction of the Personal Computer in August, 1981.

As this went to press, Apple announced that the Lisa will be sold in one configuration only: the computer with 1 megabyte of RAM, two floppy-disk drives, the Profile hard disk, the six application programs (Lisa Draw, Lisa Write, Lisa Project, Lisa Calc, Lisa List, and Lisa Graph), and Lisa Test diagnostic program; the price of this package is \$9995; it will be available in the U.S. this spring, and modified foreign-language versions will be available this summer.

Fortunately for us, the history of computing does not stop with the Lisa. Technology, while expensive to create, is much cheaper to distribute. Apple knows this machine is expensive and is also not unaware that most people would be incredibly interested in a similar but less expensive machine. We'll see what happens. ■

DEVELOPMENT HARDWARE/SOFTWARE
GTEK MODEL 7128 EPROM PROGRAMMER

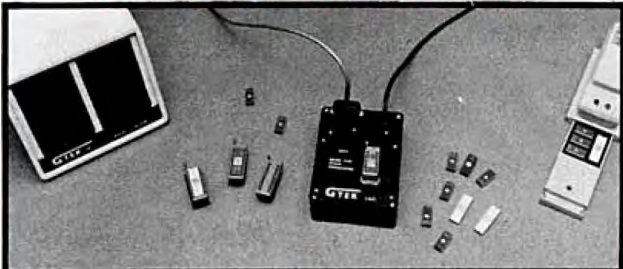

- Microprocessor based intelligence for ease of use and interface. You send the data, the 7128 takes care of the rest.
- RS-232 interface and ASCII data formats make the 7128 compatible with virtually any computer with an RS-232 serial interface port.
- Auto-select baud rate.
- Use with or without handshaking. Bidirectional Xon/Xoff supported. CTS/DTR supported.
- Devices supported as of DEC 82.

NMOS	NMOS	CMOS	EEPROM	MPU'S
2758	2508	27C16	5213	8748
2716	2516	27C32	X2816	8749
2732	2532	C6716	48016	8741
2732A	2564	27C64		8742
2764	68766			8751
27128	8755			8755
- Read pin compatible ROMS also.
- Automatic use of proper program voltage based on type selected.
- Manu driven eprom type selection, no personality modules required. (40 pin devices require adapter)
- INTEL, Motorola and MCS-86. Hex formats. Split facility for 16 bit data-paths. Read, program, and formatted list commands also.
- Interrupt driven type ahead, program and verify real time while sending data.
- Program single byte, block, or whole eprom.
- Intelligent diagnostics discern between eprom which is bad and one which merely needs erasing.
- Verify erasure and compare commands.
- Busy light indicates when power is being applies to program socket.
- Complete with TEXTTOOL zero insertion force socket and integral 120 VAC power supply. (240 VAC/50HZ available also)
- High Performance/Cost ratio.

●●● Model 7128 PRICE \$389.00 ●●●

MODEL 7128 SOCKET ADAPTERS
MODEL 481 allows programming of 8748, 8749, 8741, 8742 single chip processors. Price \$98.00

MODEL 511 allows programming the 8751, Intel's high powered single chip processor. Price \$174.00

MODEL 755 allows programming the 8755 EPROM/I/O chip. Price \$135.00

MODEL 7128/24 - budget version of the 7128. Supports 24 pin parts thru 32K only. Upgradable to full 7128 capacity. Price \$289.00

Non-expandable, very low cost models available for specific devices.
MODEL 7128-L1 for 2716 only \$149.00
MODEL 7128-L2 for 2732 only \$179.00

Also available from stock:
Eprom Erasers UVP model DE-4 . . . \$78.00
Avocet Systems Cross Assemblers . . . \$200.00
RS-232 Cable Assemblies \$25.00
Programmable Devices call
Complete development systems . . . \$3240.00

Post Office Box 289
Waveland, Mississippi 39576
(601) 467-8048

GTEK INC.

Bored Waiting?

Here's The Board You've Been Waiting For.



Teletek's HD/CTC

A hard disk **and** cartridge tape controller together on one board? Magic? Not really. It's Teletek's HD/CTC. The hard disk and cartridge tape drive controller provide the support necessary to interface both a rigid-disk drive and a cartridge tape deck to the S-100 bus.

A colorful addition to Teletek's already impressive line of S-100 boards, the HD/CTC's specifications include:

- A Z-80A CPU providing intelligent control of the rigid-disk and cartridge tape drives.

- Support of 5 1/4" rigid-disk drives with transfer rates of 5 megabits per second. Minor changes in on-board components allow the support of other drive types/sizes and transfer rates up to 15 megabits per second. (Interface to disk drive is defined by software/firmware on board.)
- Controller communications with the host processor via 2K FIFO at any speed desirable up to the limit of 2 megabytes per second for a data block transfer. Thus the controller does not constrain the host processor in any manner.
- Two 28-pin sockets allowing the use of up to 16k bytes of on-board EPROM and up to 8k bytes of on-board RAM.
- Individual software reset capability.
- Conforms to the proposed IEEE-696 S-100 standard.
- Controller can accommodate two rigid-disk drives and one cartridge tape drive. Expansion is made possible with an external card.

Teletek's HD/CTC Offers A Hard Disc Controller, Plus Cartridge Tape Controller,
All In One Board.

TELETEK

9767F Business Park Drive Sacramento, CA 95827 (916) 361-1777 Telex #4991834. Answer back-Teletek

Here's just a taste of our great prices.

To really feast your eyes, send for our catalog.

16K RAM KITS.....13.95

Set of 8 NEC 4116 200 ns. Guaranteed one year.

DISKETTES

ALPHA DISKS.....21.95

Single sided, certified Double Density 40 Tracks, with Hub-ring. Box of 10. Guaranteed one year.

SCOTCH 3M

S.S.D.DEN 40 TRK.....23.50
D.S.D.DEN 40 TRK.....36.50

VERBATIM DATALIFE

MD 525-01, 10, 16.....26.50
MD 550-01, 10, 16.....44.50
MD 557-01, 10, 16.....45.60
MD 577-01, 10, 16.....34.80
FD 32 or 34-9000.....36.00
FD 32 or 34-8000.....45.60
FD 34-4001.....48.60

DISKETTE STORAGE

5 1/4" PLASTIC LIBRARY CASE.....2.50
8" PLASTIC LIBRARY CASE.....3.50
PLASTIC STORAGE BINDER w/ Inserts.....9.95
PROTECTOR 5 1/4" (50 Disk Capacity).....21.95
PROTECTOR 8" (50 Disk Capacity).....24.95
DISK BANK 5 1/4".....5.95
DISK BANK 8".....5.95

NEC PERSONAL COMPUTERS

Call Alpha Byte for our low NEC prices.

ALTOS COMPUTER SYSTEMS

Call Alpha Byte for our low Altos prices.

ATARI COMPUTERS

SIGNALMAN MODEM.....85.00
ATARI 800.....659.00
ATARI 400 (16K).....\$CALL
ATARI 810 DISK DRIVE.....445.00
ATARI 850 INTERFACE.....169.00
ATARI 410 PROGRAM RECORDER.....75.00
EPSON CABLE.....35.00
MEMORY MODULE (16K).....89.95
JOYSTICK CONTROLLER.....10.00
PADDLE CONTROLLERS.....17.50
STAR RAIDERS.....32.00
MISSILE COMMAND.....32.00
ASTERIODS.....32.00
PACMAN.....32.00
CENTIPEDE.....32.00
PERCOM DISK DRIVE.....684.00
See Apple-Atari Software.

INTEC PERIPHERALS RAM MODULES

48K FOR ATARI 400.....145.00
32K FOR ATARI 800.....67.00

PRINTERS

ANADEX 9501A.....1390.00
RIBBONS FOR MX-80.....8.95

RIBBONS FOR MX-100.....24.00
C-I-TOH F-10 40 CPS PARALLEL.....1390.00
C-I-TOH F-10 40 CPS SERIAL.....1390.00
C-I-TOH PROWRITER PARALLEL.....480.00
C-I-TOH PROWRITER SERIAL.....590.00
EPSON MX-80 W/GRAFTRAX PLUS.....\$CALL
EPSON MX-80 F/T W/GRAFTRAX PLUS.....\$CALL
EPSON MX-100 W/GRAFTRAX PLUS.....\$CALL
EPSON GRAFTRAX PLUS.....60.00
COMREX CR-1 PARALLEL.....839.00
COMREX CR-1 SERIAL.....859.00
COMREX TRACTOR FEED.....109.00
IDS PRISM 80.....859.00
IDS PRISM 80 W/ COLOR/OPTIONS.....1599.00
IDS MICROPRISM 480.....\$CALL
NEC 8023A.....485.00
NEC SPINWRITER 3530 P. RO.....1995.00
NEC SPINWRITER 7710 S. RO.....2545.00
NEC SPINWRITER 7730 P. RO.....2545.00
NEC SPINWRITER 7700 D SELLUM.....2795.00
NEC SPINWRITER 3500 SELLUM.....2295.00
OKIDATA MICROLINE 80.....389.00
OKIDATA MICROLINE 82A.....460.00
OKIDATA MICROLINE 83A.....700.00
OKIDATA MICROLINE 84.....1170.00
OKIGRAPH 82.....49.95
OKIGRAPH 83.....49.95
MICROBUFFER IN-LINE 32K.....299.00
MICROBUFFER IN-LINE 64K.....349.00
MICROBUFFER 64K EXPANSION MOD.....179.00

WICO

JOYSTICK.....23.50
TRACKBALL (Specify Atari or Apple).....54.00
APPLE ADAPTOR (For Joystick).....17.50

BOOKS

THE CUSTOM APPLE.....24.95
BASIC BETTER & FASTER DEMO DISK.....18.00
THE CUSTOM TRS-80.....24.95
MICROSOFT BASIC FASTER & BETTER.....24.95
CUSTOM I/O MACHINE LANGUAGE.....24.95
TRS-80 DISK & MYSTERIES.....16.95
MICROSOFT BASIC & DECODED.....24.95

APPLE HARDWARE

APPLEMATE DRIVE.....269.00
SUPER CLOCK II.....129.00
VERSA WRITER DIGITIZER.....259.00
ABT APPLE KEYPAD.....119.00
SOFTCARD PREMIUM SYSTEM.....569.00
MICROSOFT Z-80 SOFTCARD.....249.00
MICROSOFT RAMCARD.....79.00
VIDEX 80x24 VIDEO CARD.....260.00
VIDEX KEYBOARD ENHANCER II.....129.00
VIDEX FUNCTION STRIP.....74.00
VIDEX ENHANCER REV D-6.....99.00
M & R SUPERTERM 80x24 VIDEO BD.....315.00
M & R COOLING FAN.....44.95
T/G JOYSTICK.....44.95
T/G PADDLE.....29.95
T/G SELECT-A-PORT.....54.95
T/G TRACKBALL.....47.50
VERSA E-Z PORT.....21.95
THE MILL-PASCAL SPEED UP.....270.00
PROMETHEUS VERSACARD.....165.00
LAZAR LOWER CASE +.....59.00
MICROBUFFER II 16K W/GRAPHICS.....259.00
MICROBUFFER II 32K W/GRAPHICS.....299.00

SUPERFAN II.....62.00
SUPERFAN II W/ZENER.....84.50
RANA CONTROLLER.....104.00
RANA DRIVE ELITE I.....335.00
SNAPSHOT.....119.00
GRAPPLER +.....145.00
7710A ASYNCHRON. SER. INTERFACE.....149.00
7712A SYNCHRON. SER. INTERFACE.....159.00
7742A CALENDAR CLOCK.....99.00
7728A CENTRONICS INTERFACE.....105.00
APPLE VISION 80-80 COL CARD.....259.00
APPLE 8" DISK DRIVE CONTROLLER.....549.00

MONITORS

AMBER 12".....165.00
NEC 12" GREEN MONITOR.....169.00
NEC 12" COLOR MONITOR.....399.00
SANYO 12" MONITOR (B & W).....198.00
SANYO 13" COLOR MONITOR.....402.00
BMC GREEN MONITOR.....89.00
AMOEK COLOR I.....355.00
AMOEK RGB COLOR II.....774.00
AMOEK RGB INTERFACE.....169.00
TAXAN RGB.....359.00

MOUNTAIN HARDWARE

CPS MULTIFUNCTION BOARD.....154.00
ROMPLUS W/ KEYBOARD FILTER.....165.00
ROMPLUS W/O KEYBOARD FILTER.....125.00
KEYBOARD FILTER ROM.....49.00
COPYROM.....49.00
MUSIC SYSTEM.....369.00
ROMWRITER.....149.00
A/D + D/A.....299.00
EXPANSION CHASSIS.....580.00
RAMPLUS 32K.....160.00

S-100 HARDWARE

Alpha Byte is your new S-100 headquarters! We've expanded our line of S-100-compatible hardware. Here's just a few of the lines we carry:

QT COMPUTER PRODUCTS
18 SLOT M/F W/P.S.....430.00
12 SLOT M/F W/CUTOUTS FOR 2-5/4".....500.00
12 SLOT M/F W/CUTOUTS FOR 2-8".....600.00
8 SLOT M/F W/CUTOUTS FOR 2-8".....550.00

STATIC MEMORY SYSTEMS
"LAST MEMORY" BOARD 64K.....500.00
"LASTING MEMORY" PROM PROG.....299.00

ADVANCED MICRODIGITAL SINGLE S-100 BOARD COMPUTER
SUPERQUAD-8.....820.00
SUPERQUAD-5.....820.00

COMREX
"THE TIMEPIECE" S-100 CLOCK.....125.00

CALIFORNIA COMPUTER SYSTEMS
2200A MAINFRAME.....459.00
2065C 64K DYNAMIC RAM.....539.00
2422 DISK CONT. & CP/M*.....359.00

2710 4 SERIAL I/O.....279.00
2718 2 SERIAL / 2 PARALLEL I/O.....269.00
2720 4 PARALLEL I/O.....199.00
2810 Z-80 CPU.....259.00

SIERRA COMPUTER PRODUCTS

S-100 PROM PROGRAMMER A/T.....240.00
S-100 PROM PROGRAMMER KIT.....195.00
S-100 PROTOTYPE MODULE SEMI KIT.....90.00

MODEMS

NOVATION CAT ACOUSTICS MODEM.....140.00
NOVATION D-CAT DIRECT CONNECT.....156.00
NOVATION AUTO-CAT AUTO ANS.....219.00
NOVATION O-CAT (1200 Baud).....619.00
NOVATION APPLE-CAT (300 Baud).....310.00
NOVATION APPLE-CAT (1200 Baud).....605.00
UDS 212 LP (1200 Baud).....429.00
UDS 103 JLP AUTO ANS.....209.00
HAYES MICROMODEM.....289.00
HAYES 100 MODEM (S-100).....325.00
HAYES SMART MODEM (300 Baud).....227.00
HAYES SMART MODEM (1200 Baud).....540.00
HAYES CHRONOGRAPH.....199.00
SIGNALMAN MODEM W/RS-232C.....85.00

TERMINALS

TELEVIDEO 920C.....830.00
TELEVIDEO 950C.....995.00
ADDS-VIEWPOINT.....599.00
HAZELTINE ESPRIT.....510.00
VISUAL-50 GREEN.....690.00

BARE DRIVES

TANDON 5 1/4 INCH
100-1 SINGLE HEAD 40 TRK.....195.00
100-2 DUAL HEAD 40 TRK.....262.50
100-3 SINGLE HEAD 80 TRK.....250.00
100-4 DUAL HEAD 80 TRK.....369.00

TANDON THINLINE 8 INCH
848-1 SINGLE SIDE.....379.00
848-2 DUAL SIDE.....490.00

TRS-80 MOD I HARDWARE

PERCOM DATA SEPARATOR.....27.00
PERCOM DOUBLER II W/DOS 3.4.....159.00
4 DRIVE CONTROLLER P/S.....259.00
TANDON 40 TRK DISK DRIVE W/P.S.....289.00
LNW DOUBLER W/DOSPLUS 3.3.....138.00
LNW 5/8 DOUBLER W/DOSPLUS 3.4.....181.00
MOD III DRIVE KIT W/DRIVES.....638.00

IBM HARDWARE

SEATTLE 64K RAM +.....355.00
DUADBOARD 64K.....430.00
64K MEMDRY UPGRADE.....80.00

ALPHA BYTE IBM MEMORY EXPANSION BOARDS

256K W/RS-232C.....349.00
256K W/RS-232C & SUPERCALC.....529.00
512K W/RS-232C.....599.00
512K W/RS-232C & SUPERCALC.....749.00

IBM DISK DRIVES

Alpha Byte's add-on drive kits for the IBM-PC — each kit includes installation instructions.

1 Tandon TM100-1 Single head 40 trk.	195.00
1 Tandon TM100-2 Double head 40 trk.	262.50
QUENTIN DOUBLE HEAD 40 TRK.	289.00

HARD DISK DRIVE SPECIAL MEDIA DISTRIBUTORS

5 1/4" Winchester, cabinet, P.S. controller, assembled and tested. Attaches to your Z-80 CPU system in minutes. Runs on Northstar, Heath/Zenith, TRS-80 Mod II, Apple w/ CP/M[®], CCS and others. Hardware must be Z-80 /CPM[®] system. The included self-installing software attaches to your CP/M[®] system. 6-month warranty. No effect on your present floppy disk system. Includes all cables and installation instructions.

10 MEGABYTES.	2370.00
20 MEGABYTES.	3180.00

ISOLATORS

ISO-1 3-SOCKET.	49.95
ISO-2 6-SOCKET.	49.95

MICRO PRO

APPLE CP/M[®]

WOROSTAR*†	279.00
SUPERSORT*†	179.00
MAILMERGE*†	174.00
DATASTAR*†	207.00
SPELLSTAR*†	174.00
CALCSTAR*†	109.00

MICROSOFT

APPLE

FORTRAN*	150.00
BASIC COMPILER*	296.00
COBOL*	550.00
Z-80 SOFTCARD.	249.00
RAMCARD.	79.00
TYPING TUTOR.	17.95
OLYMPIC DECATHLDN.	24.95
TASC APPLESOFT COMPILER.	125.00
ALDS.	95.00
MULTIPLAN NATIVE DR CP/M.	209.00

IBM SOFTWARE

VOLKSWRITER V 1.2.	145.00
WRITE ON.	90.00
EASYWRITER II.	247.00
HOME ACCOUNTANT+.	105.00
VISICALC / 256K.	189.00
SUPERCALC.	179.00
WORDSTAR.	279.00
MAILMERGE.	174.00
DATASTAR.	207.00
SPELLSTAR.	174.00
SUPERSORT.	179.00
d BASE II.	429.00
SPELLGUARD.	230.00
JFORMAT.	39.00

Call for additional IBM software prices.

APPLE SOFTWARE

MAGIC WINDOW.	79.00
MAGIC WORDS.	59.00
MAGIC MAILER.	59.00
DB MASTER.	169.00
DB MASTER UTILITY PACK I OR II.	69.00
DATA CAPTURE 4.0/80.	59.95
PFS: GRAPH.	89.95
PFS: (NEW) PERSONAL FILING SYSTEM.	85.00
PFS: REPORT.	79.00
Z-TERM*	89.95
Z-TERM PRO*	129.95
ASCHI EXPRESS PRO.	98.00
EASY WRITER-PRO.	199.00
EASY MAILER-PRO.	79.00
A-STAT COMP. STATISTICS PKG.	99.00
BEAGLE BROTHERS UTILITY CITY.	23.00
APPLE MECHANIC.	23.00
TIP DESK#1.	15.95
SUPER TEXT 40/56/77.	97.50
LISA 2.5.	59.95
TRANSCEND II.	115.00
SCREENWRITER II.	99.00
DICTIONARY.	79.00
GENERAL MANAGER.	179.00

VISICORP

DESKTOP PLAN II.	189.00
VISIPILOT.	158.00
VISITREND/VISIPILOT.	229.00
VISIOEX.	189.00
VISITERM.	79.00

TRS-80 SOFTWARE

NEWSOOS/80 2.0 MOD I,III.	139.00
LAZY WRITER MOD I,II.	165.00
PROSOFT NEWSOFT MOD I,III w/labels	109.00
SPECIAL DELIVERY MOD I,III	119.00

WORD PROCESSOR SPECIAL

(Limited Quantities)

FRANKLIN ACE 1000.	1595.00
FRANKLIN ACE SYSTEM DISK DRIVE W/ CONT.	539.00
ACE WRITER WORD PROCESSOR.	129.00
MICROBUFFER II 32K.	299.00

EPSON MX 80 FT W/ GRAFTRAX.	695.00
NEC HI RES GREEN.	285.00
SCOTCH 3M DISKETTES.	44.50
STORAGE BOX.	2.50

~~\$3324~~

Now \$2392

This system may be modified to your needs. Call for special price quote.

VISICALC.	189.00
VISIFILES.	189.00

CONTINENTAL SOFTWARE

G/L.	165.00
A/R.	165.00
A/P.	165.00
PROPERTY MGMT.	399.00
THE HOME ACCOUNTANT.	59.95
FIRST CLASS MAIL.	55.00

CP/M[®] SOFTWARE

We carry CP/M[®] software in all popular disk formats. Call for availability and price. Most software also available on IBM.

SUPERFILES.	170.00
THE WORD PLUS.	117.00
d BASE II.	429.00
QUICKCODE.	230.00
DUTIL.	91.00
SUPER CALC.	189.00
SPELLGUARD.	230.00
P & T CP/M [®] MOD 2 & 16 TRS-80.	175.00
COMM X TERMINAL PROG.	82.50
PASCAL Z.	349.00
PASCAL MT+.	439.00
PASCAL/M.	295.00
ACCOUNTING PLUS** — G/L, A/R, A/P, P/R.	1799.00
CONDOR I.	579.00
CONDOR II.	849.00
BADLIM.	62.00

DIGITAL RESEARCH

MAC.	89.00
SID.	69.00
ZSID.	97.00
PL/1-80.	439.00
C BASIC 2.	96.00

SUPERSOFT

DIAGNOSTIC I.	69.00
DIAGNOSTIC II.	89.00
"C" COMPILER.	179.00
UTILITIES I.	59.00
UTILITIES II.	59.00
RATFOR.	89.00
FORTRAN.	239.00
DISK DCCTOR.	78.00

MICROPRO

WORDSTAR.	265.00
SUPERSORT.	160.00
MAILMERGE.	95.00
OASTAR.	220.00
SPELLSTAR.	150.00
CALCSTAR.	195.00

MICROSOFT

BASIC 80.	249.00
BASIC COMPILER.	299.00
FORTRAN 80.	359.00
COBOL 80.	419.00
MACRO 80.	185.00
mu MATH/mu SIMP.	200.00
mu LISP/mu STAR.	165.00

X-TRA SPECIAL DELIVERY MOD I,III.	199.00
TRACKCESS MOD I.	24.95
OMNITERM SMART TERM. MOD I,III.	89.95
MICROSOFT BASIC COMP. FOR MOD I.	165.00
LDOS 5.1 MOD I,III.	119.00

TRS-80 GAMES

INVADERS FROM SPACE.	17.95
PINBALL.	17.95
MISSILE ATTACK.	18.95
STAR FIGHTER.	24.95

Call for more TRS-80 games.

APPLE & ATARI GAMES

Spinnaker in stock, call for prices.

BRODERBUND

APPLE PANIC.	23.61
MIDNIGHT MAGIC.	27.29
CHOPFLIFTER.	27.20

AUTOMATED SIMULATIONS

INVASION ORION.	20.95
STAR WARRIOR.	31.35
CRUSH, CRUMBLE AND CHOMP.	24.95
TEMPLE OF APSHAI.	31.35
HELLFIRE WARRIOR.	31.35
RESCUE AT RIGEL.	23.36

ON-LINE SYSTEMS

WIZARD AND PRINCESS.	27.26
SOFT PDON ADVENTURE.	23.36
THRESHOLD.	31.16
JAW BREAKER.	23.36
CROSSFIRE.	24.95
ULYSSES & GOLDEN FLEECE.	25.95
FROGGER.	24.50

INFOCOM

ZORK I, II, III.	28.00
STARCROSS.	28.00
DEADLINE.	35.00

EDU-WARE

COMPU-READ.	24.95
COMPU-MATH FRACTIONS.	34.95
COMPU-MATH DECIMALS.	34.95

MORE GREAT APPLE GAMES

DARK CRYSTAL.	31.61
TUBEWAY.	27.26
ARCADE MACHINE.	32.95
TUES. MORNNG QUARTERBACK.	25.95
THE SPACE VIKINGS.	38.50
COMPUTER QUARTERBACK.	31.16
SEA FOX.	24.00
THE SHATTERED ALLIANCE.	49.95
POOL 1.5.	27.26
ULTIMA.	31.16
RASTER BLASTER.	23.36
FLIGHT SIMULATOR.	26.61
INTERNATIONAL GRANO PRIX.	25.95
SARGON II.	28.95

PINBALL SUBLOGIC.	24.50
SPACE KADETT.	28.00
SNACK ATTACK.	23.36
BUDGECO PINBALL CONST. SET.	31.61
THIEF.	24.95
MARS CARS.	23.00
KAMIKAZI.	27.26
THE WARP FACTOR.	31.16
COSMO MISSION.	23.36
WIZARDRY.	37.95

SIRIUS SOFTWARE

SPACE EGGS.	23.36
GORGON.	31.16
SNEAKERS.	23.36
PHANTOMS FIVE.	22.00
BANDITS.	25.00

EDU-WARE

PERCEPTION PKG.	19.95
COMPU-MATH: ARITHMETIC.	39.95
COMPU-SPELL (REC. DATA DISK).	24.95
COMPU-SPELL DATA DISKS 4-8. ea.	17.95
RENDEZVOUS.	28.50

ON-LINE SYSTEMS

ULTIMA II.	42.00
MISSILE DEFENSE.	27.26
PEST PATROL.	23.36
TIME ZONE.	77.96
CRANSTON MANOR.	25.95
CANNON BALL BLITZ.	25.95

MUSE SOFTWARE

ROBOT WARS.	32.95
THREE MILE ISLAND.	31.61
A.B.M.	19.46

To order or for information call

In New York:

(212) 509-1923

In Los Angeles:

(213) 706-0333

In Dallas:

(214) 744-4251

By Modem:

(213) 883-8976

CALL OUR MODEM LINE FOR WEEKLY SPECIALS!

Alpha Byte
COMPUTER PRODUCTS

31245 LA BAYA DRIVE
WESTLAKE VILLAGE, CA 91362

Circle 15 on inquiry card.

We guarantee everything we sell for 30 days — no returns after 30 days. Defective software will be replaced free, but all other software returns are subject to 15% restocking fee and must be accompanied by RMA slip. No returns on game software, unless defective. We accept VISA and MasterCard on all orders; COD orders, up to \$300. Shipping charges: \$3 for all prepaid orders, actual shipping charges for non-prepays; \$3 for COD orders under 25lbs. (\$6 for over) plus a \$4 surcharge; add 15% for foreign. FPO and APO orders. Calif. add 6% sales tax, in L.A. County add 6 1/2%. Prices quoted are for stock on hand and are subject to change without notice.

Build a Handheld LCD Terminal

A single-line display is quite adequate for many troubleshooting and monitoring applications.

Steve Ciarcia
POB 582
Glastonbury, CT 06033

The Circuit Cellar was a lonely place after the tumult of finishing up the complicated and seemingly endless MPX-16 project, which had occupied almost my every waking moment for months. I was dreading a call from my editor at BYTE, who was sure to ask what my next project would be. For once, I was stuck without an idea.

As the wind whistled outside, I decided to check how hard it was blowing. I turned on the radio, expecting to hear a synthesized computer voice describing the current weather conditions, but got only static. I groaned as I realized that something must be wrong with my automatic talking weather station.

The talking weather station was my project exactly a year ago (see reference 1). It combined a single-board Zilog-Z8-based computer with various weather instruments and a speech synthesizer in a machine that could transmit weather information in the form of English speech using a low-power FM radio transmitter. It worked flawlessly through its first New England winter, chattering ceaselessly for many months. I've

used it to collect reams of data concerning average wind speeds and temperatures on my little hill here in the wilds of Connecticut.

The computerized weather station is only about 50 feet from the Circuit Cellar, but it might as well have been 10 miles. I didn't know if the problem was in the transmitter, the weather instruments, or the computer. To troubleshoot it, I had to drag about half of my test equipment out under the station's lofty perch, find plugs for everything, and balance a Tele-video 925 video terminal on the fender of my truck.

But matters turned out to be not so bad as I had feared. Once the equipment was set up, I had little trouble; it took only a single line of output displayed on the terminal to diagnose the problem, which was easily remedied. And as I carried the equipment back to its home, I realized that I had an article idea.

Analyzing the Problem

Not all computer troubles are so simple that they can be diagnosed by one line of display, but many are. I had found it necessary to drag out an AC-powered 24-line by 80-column terminal to observe just the one line. But wouldn't it have been nice to have a portable one-line terminal for such simple situations? I could have saved the heavy stuff for applications

requiring a more complex display.

The Z8- (actually Z8671-) based brain of my weather station, if you will recall, is the Z8-BASIC Microcomputer (a device sometimes called the Z8-BASIC Computer/Controller or simply the Z8 board), presented in the July and August 1981 Circuit Cellar articles (see reference 3). Since that time, many of you have built Z8 boards (mostly by using the kit available from The Micromint) and reported to me on how you are using them. The feedback I get is that many Z8-BASIC Microcomputers are being used in dedicated control or data-reduction applications in which a terminal is often not required, or if one is attached to the system, it only monitors the system's functions, perhaps displaying error codes or computed results.

A Portable Terminal

Why not small displays for small computers? For many years, experimenters had only 6-digit LED (light-emitting diode) hexadecimal displays. Is there nothing between this and a full 24 by 80 terminal?

This month I'd like to present a relatively simple project that might serve to fill the gap between little hexadecimal displays and full-function terminals. The Circuit Cellar Handheld LCD Terminal consists of a single-line 16-character liquid-crystal

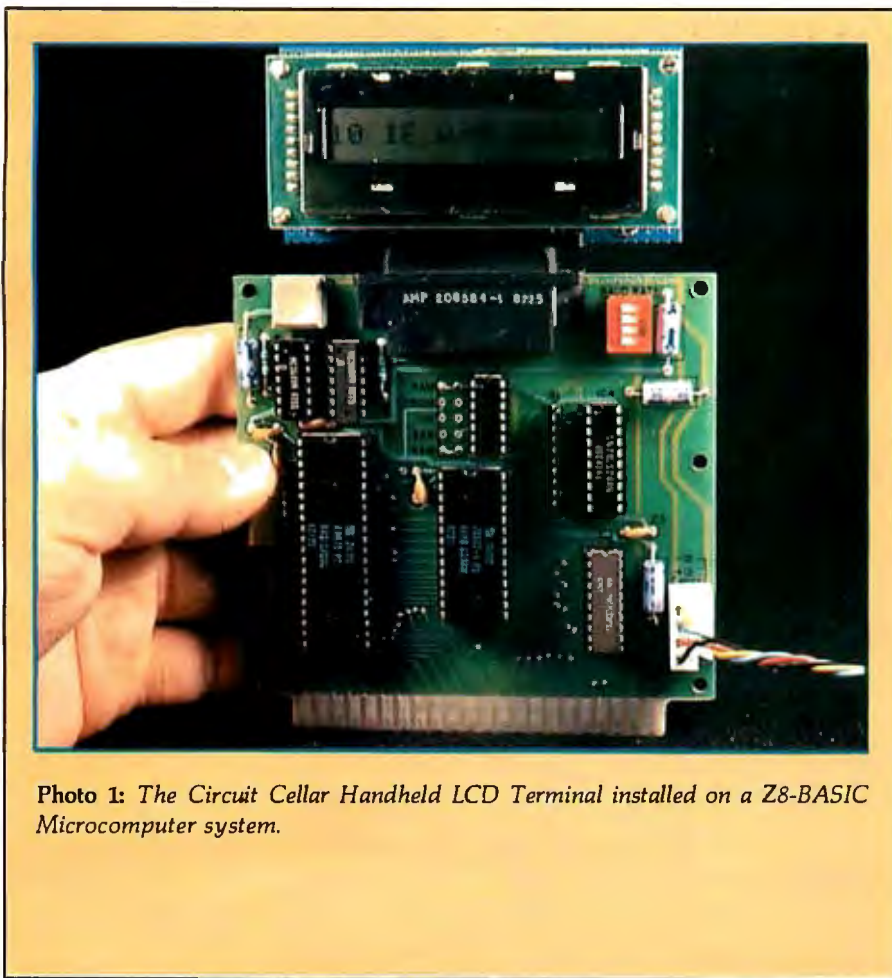

Photo 1: The Circuit Cellar Handheld LCD Terminal installed on a Z8-BASIC Microcomputer system.

display (LCD) with additional components added to form a full-duplex serially interfaced computer terminal suitable for attachment to any small control computer. The CY300 LCD-controller integrated circuit from Cybernetic Micro Systems encapsulates the entire display circuitry in a single chip and requires only 15 mA (milliamps) at 5 V (volts). Two additional chips are required to convert TTL (transistor-transistor logic) voltage levels to RS-232C voltage levels.

The display can be configured for serial or parallel input, and by attaching a parallel ASCII (American National Standard Code for Information Interchange) keyboard, you can configure a complete terminal for the Z8-BASIC Microcomputer (or some other small computer). The unit (excluding the keyboard) measures 3½ by 1½ by 1½ inches.

I'd like to start by discussing the CY300's general features, and then we can look at a description of a terminal built using the CY300.

Cybernetic Micro Systems CY300

The CY300 Dot-Matrix LCD Controller is designed to provide an easy-to-use peripheral device that displays ASCII characters and allows cursor editing operations. The CY300 provides several modes of operation to provide various levels of display capability. Its pinout specifications are shown in figure 1a on page 56.

The CY300 is a TTL-compatible CMOS (complementary metal-oxide semiconductor) 40-pin device configured to control 16-character alphanumeric dot-matrix liquid-crystal displays that use the Toshiba T3891 LCD-driver chip, as shown in the block diagram of figure 1c on page 56. The CY300 accepts parallel and serial data inputs and can generate 64 different ASCII characters, as shown in figure 2 on page 57.

A blinking-block cursor normally indicates the position in the display where a character will next appear, but the cursor can be moved to

highlight a particular character. The CY300 displays the characters it receives, storing them in a buffer until it gets a Return character. It then outputs the contents of the buffer on a serial channel. The CY300 is designed to drive a console display for small microcomputers, and as I have suggested, such a display can be used to replace a CRT (cathode-ray tube) terminal in many systems.

The CY300 contains the circuitry to perform several different functions. Two types of input interfaces are offered. The first is a parallel input port. You can connect a keyboard to this, which will enable you to enter commands or messages to the display and make typing corrections before sending the text out to the host computer. In simple display-only applications, the parallel input can be used to generate display messages.

The second interface is a serial data link, consisting of two lines, a serial input and a serial output. Generally, the host computer would be connected to these lines, with the serial output used to send short strings of characters (entered from the parallel keyboard input) to the computer, and the serial input used to receive messages or responses from the computer. The serial interface operates at 5-V logic levels only, so connection to an RS-232C port requires the use of external driver and receiver circuits to translate the voltage levels.

The CY300 also contains an internal 32-character line buffer for storing the messages shown on the display and control logic for generating the proper dot patterns for the displayed characters.

Parallel Input Operation

The CY300 can display data from either its parallel or serial input. The general scheme for parallel interfacing of the CY300 is shown in figure 3.

In parallel input, the circuitry sending the data simply places logic states representing the bits of an ASCII character on the 7 lines of the input bus, waits until the Ready line is high, and then lowers the \overline{WR} (write) strobe line. As the \overline{WR} strobe is held low, the Ready line goes low (indicating a busy state) and then returns to

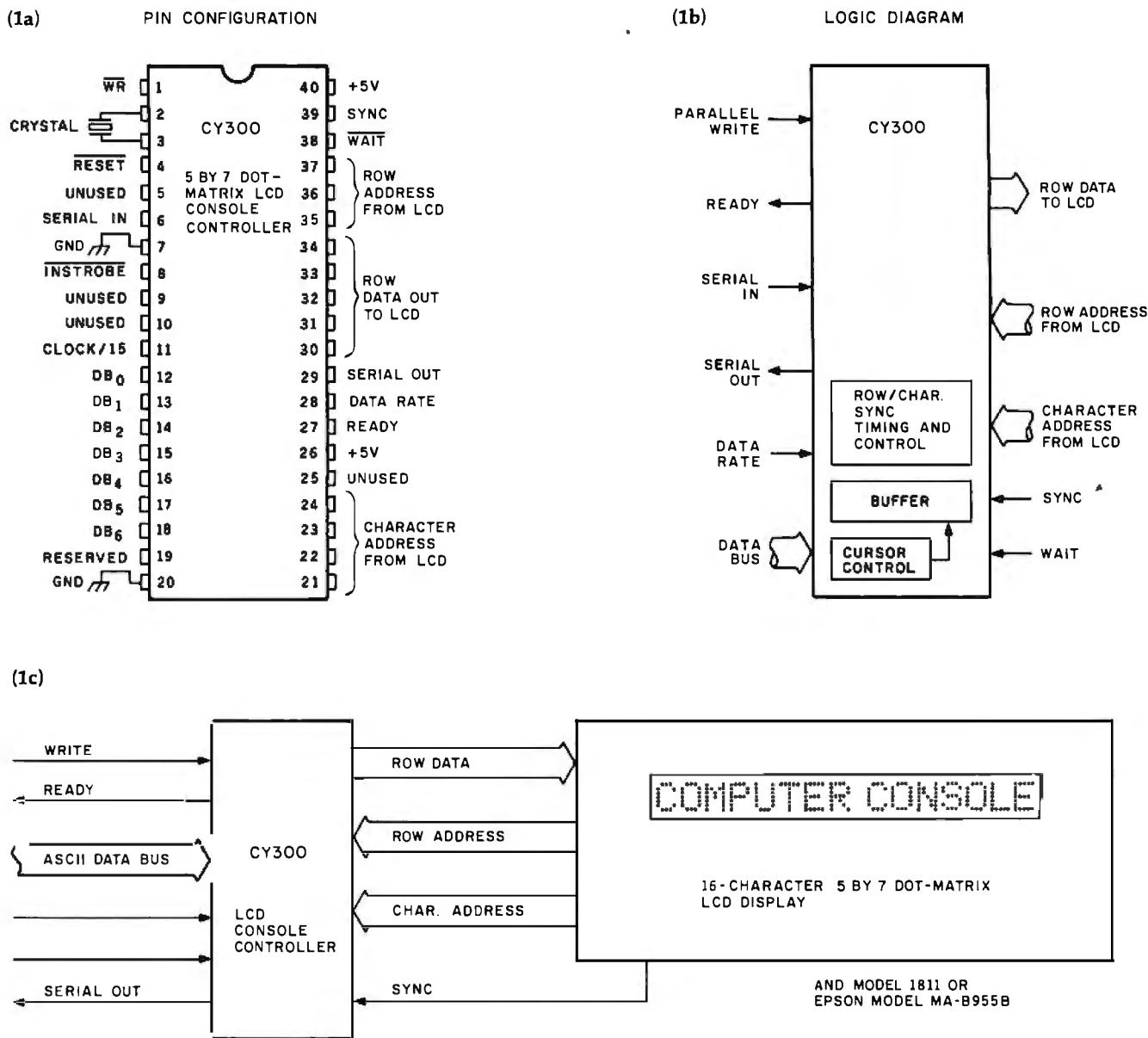

Figure 1: Descriptive information on the Cybernetic Micro Systems CY300 LCD Console Controller. Figure 1a shows the pinout specification of the CY300, 1b is a functional logic diagram of the CY300, and 1c shows a block diagram of a display system using the CY300.

the high state. When the Ready line is high again, the CY300 is prepared to receive the next character by repeating the process.

In manual-input mode, the blinking cursor indicates the location of the next character to be entered. A character can be erased by using the ASCII Rubout code (hexadecimal 7F), which causes the cursor to move left one space; an ASCII space (hexadecimal 20) is then written into the new cursor location.

The cursor can be moved left one position using the cursor-control character Control-A (hexadecimal 01) and can be moved right one position with Control-B (hexadecimal 02). These control characters do not delete any displayed characters but may place the cursor over a character already entered. The cursor always indicates the location where the next character entered will be displayed. Thus if the cursor is over a character that has already been entered, the

next input character will overwrite the existing one, and the cursor will move one position to the right.

Serial Input Operation

The CY300 can accept data from a serial source as well; the setup is shown in the block diagram of figure 4. Unlike the parallel mode, in which the sending circuit waits for a Ready signal, the serial input mode is asynchronous. The normal RS-232C 8-data-bit format is used for both serial input

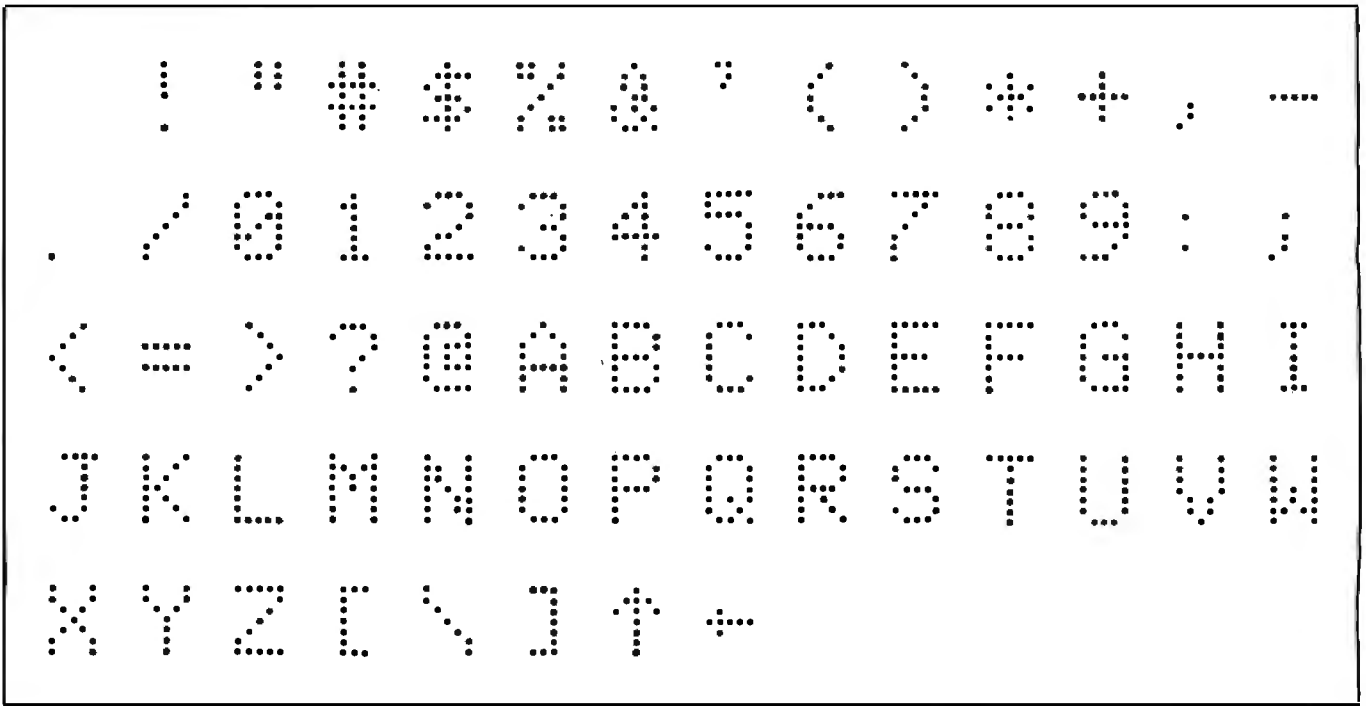

Figure 2: Dot-matrix character set produced by a liquid-crystal display driven by the CY300.

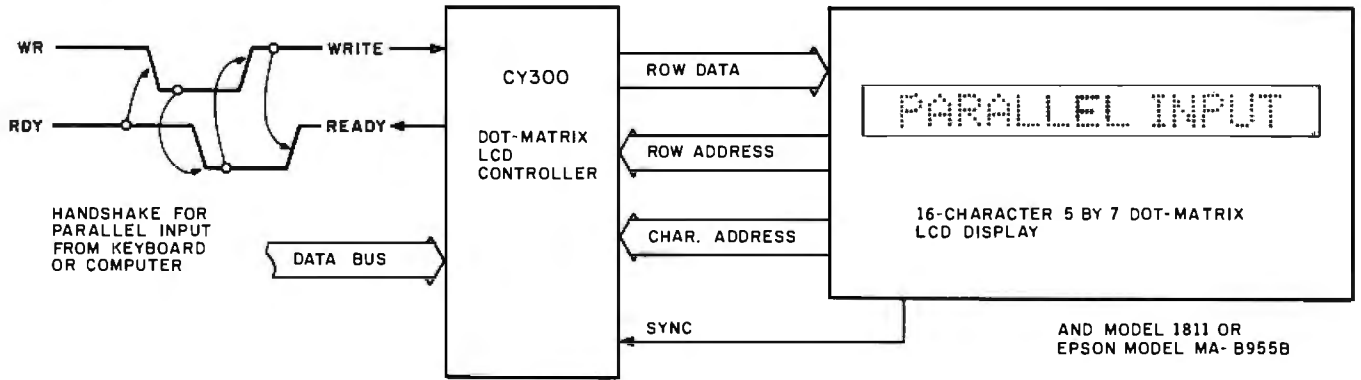

Figure 3: Block diagram of a parallel interfacing and timing requirements for the CY300.

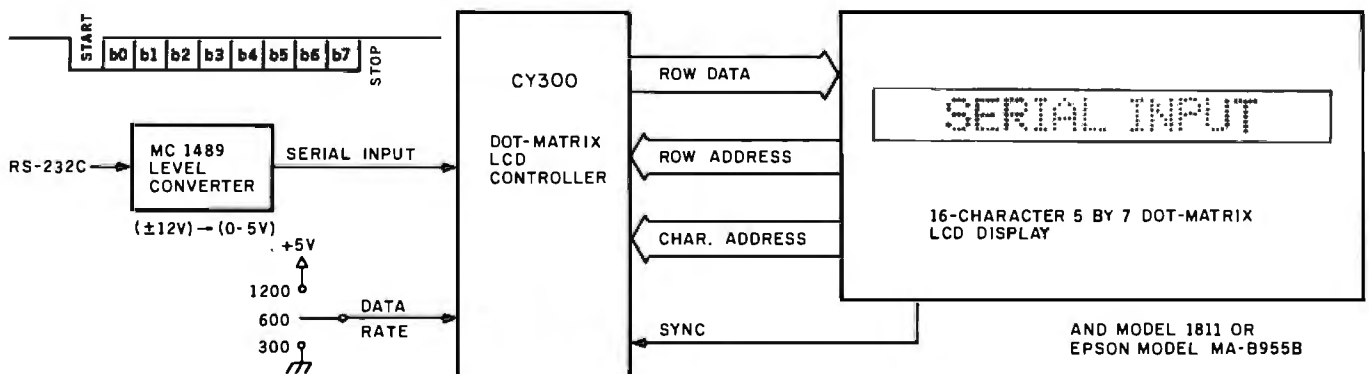

Figure 4: Block diagram of a typical serial-input arrangement used by the CY300.

and output: that is, a low-going start bit, followed by 8 data bits (least significant first, most significant last) and at least 1½ stop bits (1½ bit periods in the high state). After the stop bits have been sent, the CY300 is ready to receive the start bit for the next transmitted character.

The serial communication protocol of the CY300 is compatible with the RS-232C character format. However, the transistor-transistor logic of the CY300 operates between 0 and 5 volts (allowing the CY300 to be powered by a single +5-V supply), and RS-232C interfaces normally operate at ±12 V, so the serial input and output lines are typically routed through voltage-level translators if the CY300 is to be connected over any significant distance to an RS-232C port. However, in the case where the CY300 and host computer are physically adjacent, they can be connected directly together, operating at 5-V logic levels, without the translator circuits between them.

Other voltage protocols, such as

RS-422A and RS-423A, also can be used for serial communication. These require different driving circuits, but the logical format of the characters is the same for all the common serial protocols, so we need only supply the appropriate driver and receiver circuits for the interface in use. For an RS-232C interface, the MC1488 driver chip and MC1489 receiver chip are the most popular. The CY300 serial output line would be connected to the 1488, while the 1489 would be connected to the serial input line.

The CY300 gives us a choice of three different data rates for the transmission of characters over the serial link. This choice is controlled by the Data-Rate-Select line, pin 28. If the line is connected to +5 V, 1200 bps (bits per second) is selected (the line should be connected directly to the power supply without a pull-up resistor; otherwise, the CY300 may choose the wrong rate). If the line is left unconnected to anything, 600 bps is selected. If the line is connected to ground, 300 bps is selected. These

data-rate selections assume the use of a 6-MHz (megahertz) crystal.

Display Driver Interface

The 16-character display module I chose for this project is not just a bare LCD but includes its own controller/driver circuitry. The CY300 is specifically designed to work with 16-character LCDs driven by the Toshiba T3891 LCD-driver chip or its equivalent. Examples of such displays are the AND Model 1811 and the Epson MA-B955B.

Electronically, the 16-character 5-by 7-dot-matrix display appears to the interface circuitry as 16 sets of 7 rows (each row containing 5 data bits, 1 bit for each dot). The T3891 is designed to coordinate the reception of this row data with the information source and drive a dot-matrix LCD. Thirteen signals passing between the CY300 and the T3891 accomplish this. They are:

Sync: synchronizes dot pattern between T3891 and CY300

ADx lines: 4-bit character-position address from T3891

Sx lines: 3-bit row-position address from T3891

Dx lines: 5-bit row data from CY300 to T3891

The dot-pattern control logic is synchronized to the display's clock signal using the Sync line, which indicates when the display is ready for the next dot pattern. The CY300 uses the row- and character- (column) address information from the display to generate the proper dot pattern, based on its internal character generator and the contents of the line buffer.

When the T3891 begins its display sequence, it merely sets a character and row address of the specific display point. The CY300 examines its display buffer and simply outputs the 5 data bits that should go in that addressed location. Using the T3891 greatly simplifies the LCD interface.

Circuit Cellar Handheld Terminal

Figure 5 is a schematic diagram of the Circuit Cellar CY300-based terminal (shown in photo 2 on page 62).

DUCES TECUM LAWMATE™

Bring Justice To Your Documents, Briefs, Pleadings and Contracts.

LAWMATE Features:

- Creates Table of Authorities Cited
- Multiple Document Indexes
- Word Use and Consistency Analysis
- Concordance Generation
- Document Line Numbering
- Wordstar* Compatible

Legal Aid at an (Almost) Unlawfully Low Price.

Try **LAWMATE** at Your Local Osborne Computer Dealer, or Call Us for the Name of the Nearest Authorized **ORTHO CODE** Textware Dealer.

ORTHO CODE
The Textware Company

THE ORTHOCODE CORPORATION
P.O. Box 6191
Albany, CA 94706
(415) 753-3222

*LAWMATE is a Trademark of ORTHOCODE CORPORATION
*Wordstar is a Trademark of MicroPro International

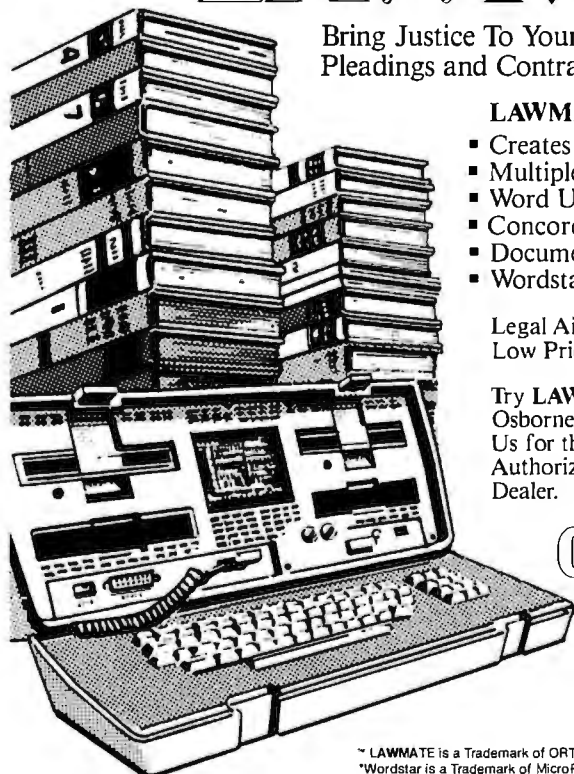

INCREASE YOUR PRODUCTIVITY WITH OUR WORD PROCESSING KEYBOARD FOR THE IBM PC.

We improved the keyboard and added some features
to make your keyboard more "finger friendly".



- Left hand SHIFT key properly placed.
- Lighted Indicators on:
CAPS LOCK key, NUMERAL LOCK key
- RETURN key in standard typewriter position.
- ENTER key next to ten key pad for adding machine like data entry.
- Sculptured key tops with "finger homing" position on:
F, J, and 5 key of the ten key pad.

From the design of the case to colors of the keys, to the plug on the cable, the keyboard is 100% IBM compatible. This keyboard is the most productive way you will ever spend \$199.

30 DAY SATISFACTION GUARANTEE

We are so sure you will like this keyboard we will give you 30 days of use to be sure. If you are not completely satisfied return it for a full refund including freight.

TO ORDER BY MAIL SEND:

- quantity desired @ \$199 each.
- your name and shipping address
- daytime phone number
- add \$5 for UPS 2 day air service
- California residents add \$11.94 sales tax.
- Company check or credit card and expiry date.
(Personal checks take 18 days to clear)

TO ORDER BY PHONE:

In California (805) 482-9829
Outside California Toll Free (800) 821-4479
Dealer Inquiries Invited

**QUBIE'
DISTRIBUTING**

4809 Calle Alto
Camarillo, CA 93010

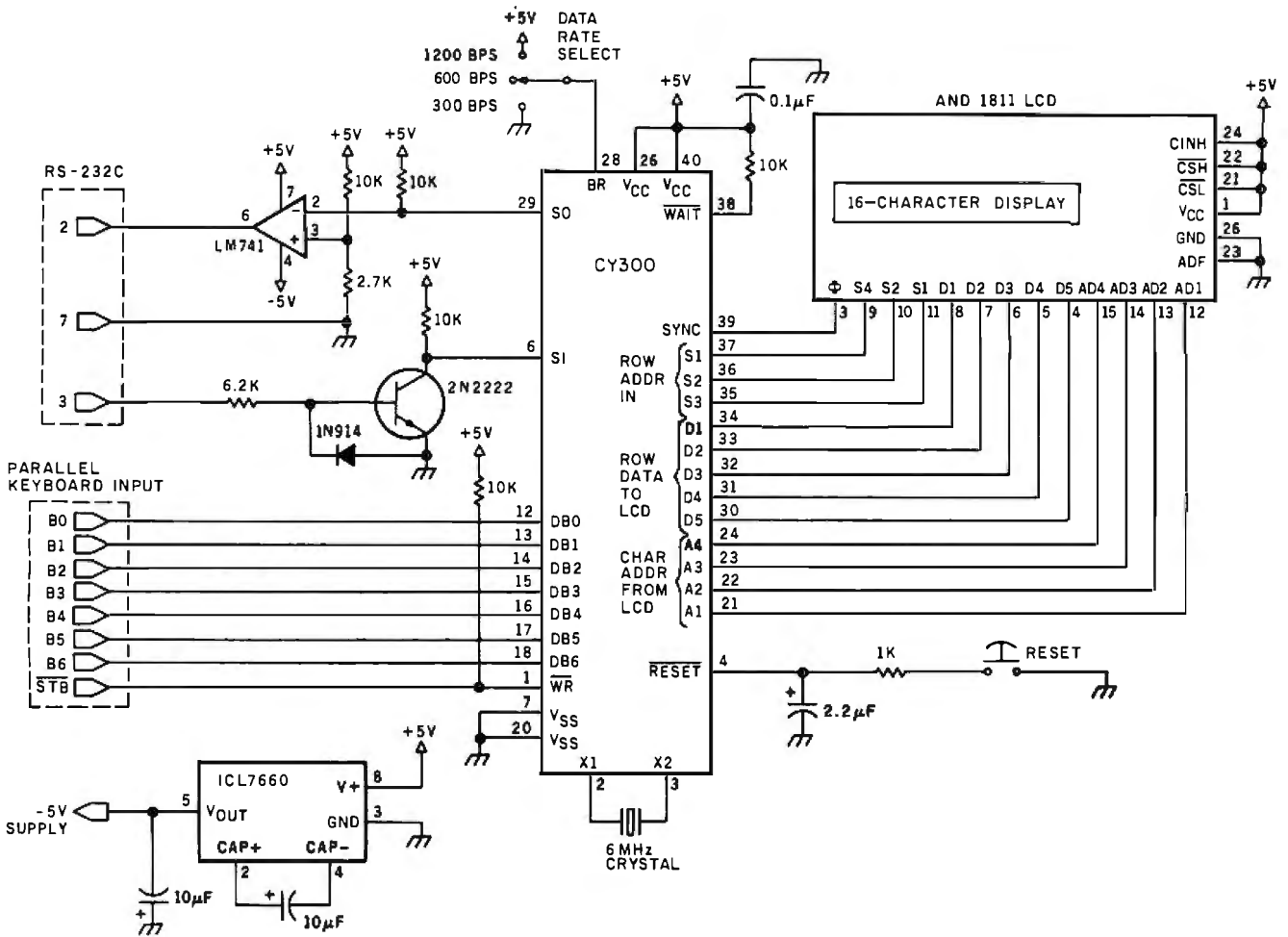

Figure 5: Schematic diagram of a single-line LCD computer terminal built around the CY300 and the AND 1811 display module. This style of RS-232C driver circuit was designed to use minimal ± 5 -V power, so it's not guaranteed to work through a long cable to the host computer.

With minor exceptions, it is configured much like the examples shown in the block diagrams presented earlier. It can function as a serially interfaced display or, if equipped with a parallel keyboard, as a full-duplex ASCII terminal.

In assembling my prototype, I used an AND 1811 display and mounted all the rest of the components behind it (as shown in photo 2b). This specific form of prototype construction was employed so that the finished display could be plugged directly into the RS-232C DB-25 connector on top of a Z8-BASIC Microcomputer.

Normally, when I am connecting a TTL-level device to an RS-232C port, I would install level-converters such as the MC1488 driver and MC1489 receiver in between. The dual-polarity (± 12 V) power required for

the driver could be derived from the Z8 board's power supply. However, the useful portability of the terminal would be suspect if it required you to either drag along an extension cord for AC power to a separate power supply or hook up three separate battery cells.

I pondered this impasse briefly and then decided to take advantage of a little-known part of the RS-232C signal specification.

RS-232C signals have two defined states: marking and spacing. The marking state extends from -3 V to -15 V, and the spacing state extends from $+3$ V to $+15$ V. The transition region between is undefined. (See Ian Witten's article "Welcome to the Standards Jungle" on page 146 for more information on RS-232C's idiosyncrasies.)

Note that the defined regions of

marking and spacing fall within the 5-V range that TTL parts can generate. Especially for short cable lengths and at low data rates, RS-232C works just fine at these lower voltages. With that fact in mind, I designed this terminal to use as little power as possible, drawing that power from a single $+5$ -V source.

So that it could receive full-voltage RS-232C levels, I used a transistor level-converter on the input line. For output, an operational amplifier (op amp) is configured as a "rail-to-rail" saturation switch, with a -5 -V supply provided by an Intersil ICL7660 DC-to-DC-converter chip. This CMOS device converts $+5$ V to -5 V at currents up to 15 mA. Using this combination of components, the RS-232C output level is generally about ± 4 V.

The major advantage of this ap-



**INTRODUCING THE NEWEST
CREATION FROM XCOMP:**

**THE TOASTER.
TWO REMOVABLE 3.9", 5 MEGABYTE
HARD DISK CARTRIDGES MAKES IT THE
GREATEST THING SINCE SLICED BREAD!**

Now you can start the day by knowing you can get everything you've always dreamed of. In fact, it's the answer everyone's been looking for!

The Toaster, from XCOMP.

The Toaster is a Hard Disk Subsystem with a twist. It contains **TWO** 3.9", 5 Megabyte Hard Disk Cartridges that are **REMOVABLE!**

The Toaster provides unlimited storage and convenient back-up with a full **5 Megabytes** per cartridge...**10 Megabytes** per application! In addition to XCOMP's quality, reliability and industry leadership, you'll be benefiting from the ultra simplicity of a floppy and the fantastic speed of a hard disk.

And what about security? What can be more secure than being able to pull out your cartridge and take it home with you?

Even though the Toaster is revolutionary, XCOMP

also offers 16-MB Fixed, 5-MB Removable and 8 or 16 Fixed Hard Disk Subsystems. We consider them the best in the industry. **ALL** XCOMP products attach to the Apple II and III, IBM-PC, NEC PC8000, OSBORN, KAYPRO and other popular single-board computers.

The Toaster is just one of the many ideas coming from the people at XCOMP today.

Tomorrow, who knows what may pop up.

31 SALES OFFICES TO SERVE YOU: Richard Dean & Assoc. Woburn, MA (617) 933-8435 Paston-Hunter Company Inc. Syracuse, NY (315) 437-2992
EASTERN SEABOARD: TMC Sales Corp., Fort Lee, NJ (201) 944-8340r (212) 563-5185
AB&I Sales Corp. King of Prussia, PA (215) 783-7011 **SOUTHEAST:** Cartwright & Bean Atlanta, GA (404) 233-2939 **MIDWEST:** J. Malcolm Flora Inc. Plymouth, MI (313) 453-4296
Incom Marketing Inc. Columbus, OH (614) 445-8431 **New Horizons Electronic Marketing,** Bannockburn, IL (312) 234-5911 **SOUTHWEST:** J.Y. Schoemaker Co. Inc. Dallas, TX (214) 349-1650 **ROCKY MOUNTAINS:** B&B Electronics Inc. Englewood, CO (303) 773-6700
WESTCOAST: Berman Gravelley Co. Inc. Costa Mesa, CA (714) 549-2122 **Moultrop Sales, Inc.** San Francisco, CA (415) 846-0550 **Earl & Brown** Portland, OR (503) 245-2283
MINNESOTA: Please call XCOMP **KANSAS:** Please call XCOMP

\$2795.

Special Offer: With every Toaster sold, you'll receive TWO Cartridges FREE! That's a \$150. value! Order now!



XCOMP

7566 Trade St., San Diego, CA 92121; (619) 271-8730/TLX 182786

Circle 444 on inquiry card.

(2a)

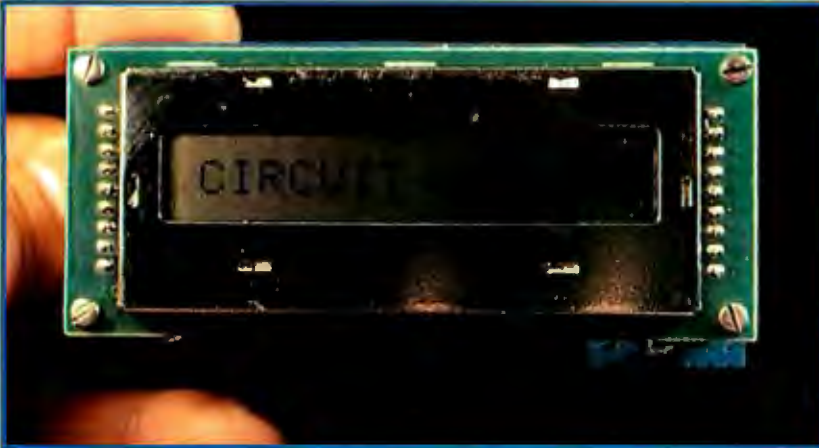

(2b)

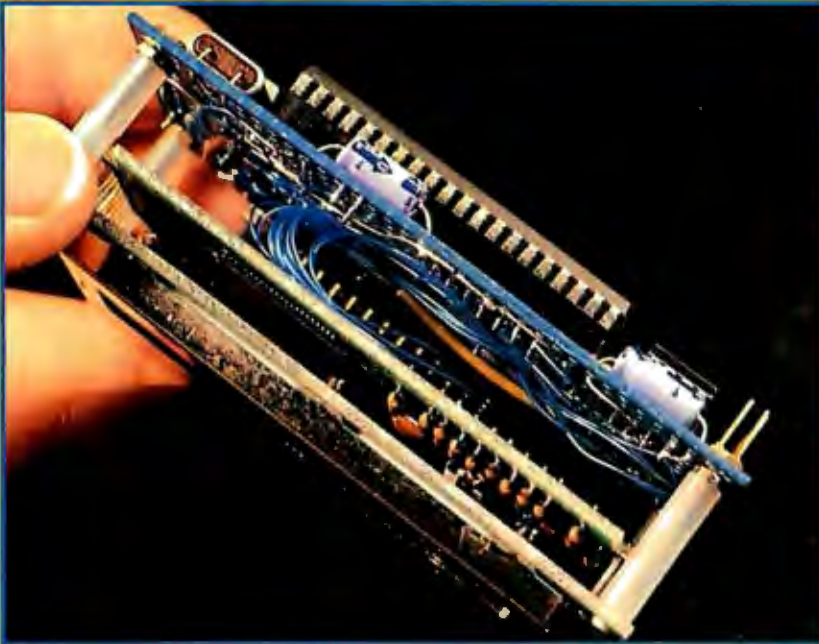

(2c)

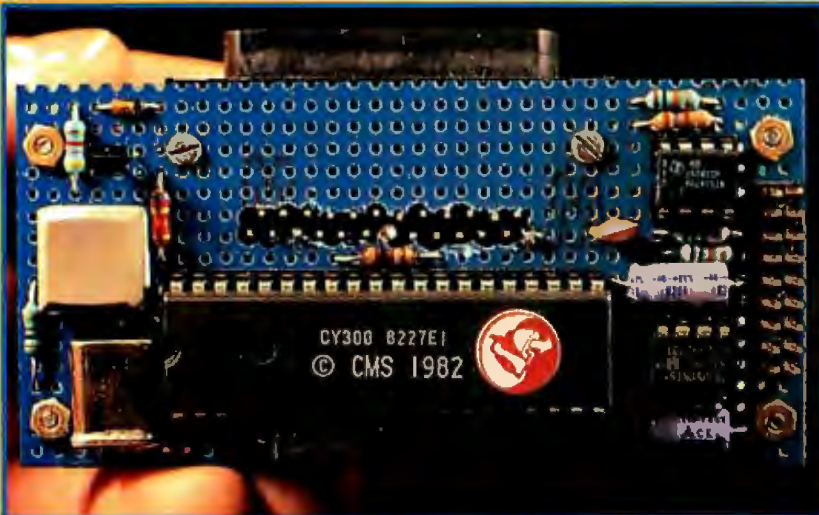

Photo 2: Close-up views of the LCD-terminal prototypes: front (2a), side (2b), and rear (2c).

proach is that it uses only a single voltage with very low power consumption. The terminal circuit requires less than 15 mA (excluding power for the keyboard). Given the power-supply voltage tolerances of the components and the communication line, the entire package could be powered by four 1.2-V nickel-cadmium (NiCd) AA cells (providing a total potential of 4.8 V) or five 1.5-V alkaline cells (6 V total) driving a type-7805 regulator.

Finally, while you might use this handheld terminal just for its display, a keyboard can be attached. The keyboard should present 7 bits of ASCII data in parallel, with the data-ready condition signaled by a negative-going (high-to-low transition) strobe.

There are two ways to correct typing errors: the first is to use the ASCII Rubout character; the second is to use the Control-A and Control-B characters, which move the cursor without modifying the display.

Terminal-Mode Operation

The Circuit Cellar Handheld LCD Terminal can replace a standard video terminal for simple BASIC-language programming on a computer such as the Z8-BASIC Microcomputer. Using the keyboard, you can type statements into the CY300; these are immediately displayed on the LCD. The CY300 provides cursor editing to correct mistakes before you type the Return character. When Return is typed, the contents of the CY300's buffer (the current display on the LCD) are sent to the computer over the serial channel. If a computer response is called for, the computer sends the response over the serial input channel to the CY300, which then displays the response characters on the LCD.

The normal operation of the Z8

NEC's new letter-quality printer gets personal with IBM.

The Spinwriter™ 3550 lets the IBM PC get down to business.

NEC's new Spinwriter letter-quality printer is the *only* one plug-compatible with the IBM Personal Computer. So you get the business applications you've been wishing for. Letter-quality output for word and data processing. Multi-language, scientific, and technical printing. Simple forms handling. Quiet operation. And the reliability of the industry's most popular printer line.

NEC designed the new Spinwriter especially for the IBM PC. It comes complete with documentation and training materials to fit your PC user's handbook. Just plug the Spinwriter in and your PC instantly becomes more versatile and flexible.

More than 8 forms handlers and 50 print thimbles boost PC versatility.

NEC designed the Spinwriter's 8 modular forms handlers to accommodate a wide range of paper and document sizes and types. The easily mounted handlers let your computer print out the forms you

need for data processing, word processing, graphics, accounting or other business applications.

The Spinwriter's 50 print thimbles can more than triple your PC's usefulness. They come in both constant pitch and proportional-spaced fonts, plus in foreign language, technical and scientific versions. They snap in and out in seconds, and let you print up to 203 columns on 16-inch paper. They each last for more than 30 million impressions.

This printer's special features make everything look better on paper.

The Spinwriter's software-invoked features include automatic proportional spacing; bidirectional, bold and shadow printing; justification; centering; under-scoring; and sub/super scripting, all at speeds up to 350 words per minute.

That big extra, Spinwriter reliability.

Spinwriters have the industry's best mean-time-between-failure rating, in excess of 3,000 hours. In terms of average personal computer usage, that's more than five years.

The Spinwriter 3550 is available at **ComputerLand** stores, **Sears Business Systems Centers** and **IBM Product Centers** nationwide.

NEC Information Systems, Inc. BE0283		
5 Militia Drive, Lexington, MA 02173		
Send me more information on the Spinwriter 3550.		
Name _____		
Title _____	Telephone _____	
Company _____		
Address _____		
City _____	State _____	Zip _____

NEC

NEC Information Systems, Inc.

Spinwriter is a trademark of Nippon Electric Co., Ltd.

Circle 295 on Inquiry card.

We're Made



for Each Other.



To receive a complete list of Ciarcia's Circuit Cellar project kits available from the Micromint, circle 100 on the reader service inquiry card at the back of the magazine.

BASIC interpreter is as follows: upon power-up the interpreter sends a user-prompting character (a colon) to the console display to inform you that the system is ready for command entry.

You can enter a command or statement at any time by typing ASCII characters into the CY300. The first input from the keyboard (over the parallel channel) will clear the liquid-crystal-display buffer and appear left-justified.

The input line is terminated by a Return character. At the occurrence of the Return, the contents of the display buffer are transmitted to the computer over the serial channel, and then the display buffer is cleared.

Editing Operations

With the keyboard connected to the parallel interface on the CY300, you have the ability to correct typing mistakes before sending commands to the Z8 board (or other host computer). Note that you can no longer edit the command after the Return character is typed, but until then any corrections can be made.

There are two ways to correct typing errors. The first and probably more often employed way is to use the ASCII Rubout character. (On some keyboards this character may be produced by a key labeled "Delete".) When the Rubout character is typed, the CY300 cursor moves one space to the left and replaces the character at that space with a blank. The cursor remains at this new position until another character is entered, allowing you to back up the cursor, remove what has been typed, and reenter the corrected text. Multiple Rubouts will continue moving the cursor to the left, removing any characters that were in the display, until the leftmost position is reached.

The second way to correct typing mistakes uses the control characters that move the cursor without modifying the display. The Control-A character moves the cursor one character position to the left, while the Control-B character moves the cursor one character position to the right. The display is not modified as the cursor is moved. However, if you enter new

characters after moving the cursor, the new characters appear at the current cursor position, overwriting any characters that were there previously. This method of correction allows you to save typing if only a single character need be changed near the beginning of a line. Before typing the Return character, though, you must put the cursor back at the end of the input line, because the CY300 transmits only the characters from the beginning of the display until the character just before the current position of the cursor.

In Conclusion

I don't expect you to junk your video-display terminals after reading this article. Obviously, you'll need a 24 by 80 (or similar size) screen for many purposes. But there are applications for which a portable, battery-operated single-line display is more suitable than a large, full-feature terminal. The sophistication of the CY300 represents a major advance in LCD technology, and I'm sure many of you have applications ready for just such a device.

Oh yes . . . about my weather station. After moving the mountain to Mohammed I was a bit displeased to find that someone had accidentally unplugged the power to the weather instruments. Of course, the problem was not hard to remedy. And if anything like it ever happens again, I'll be ready with my Handheld LCD Terminal.

Next Month:

A new integrated circuit from Texas Instruments makes it easy to build a reliable low-speed modem. ■

Editor's Note: Steve often refers to previous Circuit Cellar articles as reference material for each month's current article. Most of these past articles are available in reprint books from BYTE Books, McGraw-Hill Book Company, POB 400, Hightstown, NJ 08250.

Ciarcia's Circuit Cellar, Volume I, covers articles that appeared in BYTE from September 1977 through November 1978. Ciarcia's Circuit Cellar, Volume II, contains articles from December 1978 through June 1980. Ciarcia's Circuit Cellar, Volume III, contains articles that were published from July 1980 through December 1981.

References

1. Ciarcia, Steve. "Build a Computerized Weather Station." February 1982 BYTE, page 38.
2. Ciarcia, Steve. "Build a Low-Cost, Remote Data-Entry Terminal." September 1980 BYTE, page 26.
3. Ciarcia, Steve. "Build a Z8-Based Control Computer with BASIC." Part 1, July 1981 BYTE, page 38. Part 2, August 1981 BYTE, page 50.
4. Ciarcia, Steve. "Make Liquid-Crystal Displays Work for You." October 1980 BYTE, page 24.
5. Ciarcia, Steve. "No Power for Your Interfaces? Build a 5 W DC to DC Converter." October 1978 BYTE, page 22.
6. Leibson, Steve. "The Input/Output Primer, Part 4: The BCD and Serial Interfaces." May 1982 BYTE, page 202.

The following items are available from:

Micro Projects Inc.
POB 420
South Windsor, CT 06074

1. Cybernetic Micro Systems CY300 Dot-Matrix LCD Controller chip \$65
2. Intersil ICL7660 DC-to-DC voltage converter chip \$4

For orders outside the continental United States, please add \$5 for shipping. Connecticut residents please add 7½ percent sales tax.

Sources of liquid-crystal displays are:

AND Inc.
770 Airport Blvd.
Burlingame, CA 94010
(415) 347-9916
TWX (910) 374-2353

and

Epson America Inc.
LCD Division
23155 Kashiwa Court
Torrance, CA 90505
(213) 534-0360
Telex 182412

The manufacturer of the CY300 LCD-controller integrated circuit is:

Cybernetic Micro Systems
445-203 South Antonio Rd.
Los Altos, CA 94022
(415) 949-0666

Now for Concurrent CP/M-86, Zenith Z100 & NEC APC

VEDIT-THE CLEAR CHOICE FOR PROGRAMMING

PLUS FEATURES FOR FAST, EFFICIENT WORD PROCESSING

Increasing your productivity is what a good text editor is all about. VEDIT excels with a unique combination of powerful and easy to use editing features, customizability and complete hardware support. Compare VEDIT - you'll find everything you expect in a good editor plus many time saving features which only VEDIT offers.

VEDIT fully utilizes all function keys, or configures to any keyboard layout you are familiar with. VEDIT has helpful aids such as directory display, and you won't lose text if you run out of disk space - you can delete files or change disks.

Powerful TECO style command macros let you perform editing tasks you might otherwise not even attempt. Nearly impossible tasks for other editors (such as translations or extensive search/replace on many files), can be done automatically from a command file.

For program development VEDIT surpasses any other editor - with more

extensive file handling, powerful command macro capability and special features for Pascal, PL/1, 'C', Cobol, Assembler and others. VEDIT reduces program editing time by 30% as compared to the best word processor.

For word processing, VEDIT has word wrap, adjustable margins, paragraph reformatting, word and paragraph functions, simple printing and more.

VEDIT supports practically every CRT terminal, video board, 8080, Z80 and 8086 computer. We have been consistently first to support new computers. And we support you with any technical assistance you need.

For the full story, purchase VEDIT risk free. Evaluate the 125 page manual - if you are not satisfied, return the package (disk unopened) for a courteous refund.

Please specify your microcomputer, video board or the CRT terminal version, 8080, Z80, or 8086 code, operating system and disk format.

Compare VEDIT's features:

- True Full Screen Editing
- Edit files one disk in length
- Automatic Disk Buffering
- Compact and Fast
- Display of line and column #
- Set/Goto text markers
- 'Undo' key to restore line
- Automatic Indent/Undent
- Adjustable Tab positions
- Repeat function key
- Text Move and Copy
- 10 Scratchpad Buffers
- Load/Save buffers on disk
- Powerful command macros
- Directory display
- Edit additional (small) files simultaneously
- Insert another disk file
- Unlimited file handling
- Recovery from 'Full Disk'
- Change disks while editing
- Word Wrap, format paragraph
- Simple Printing
- Menu driven installation
- Startup command file
- Setup CRT function keys
- Support newest CRT terminals
- Support smart CRT functions
- Customizable keyboard layout

VEDIT - Disk and Manual
 8080, Z80 or IBM PC \$150
 CP/M-86 or MSDOS . . . \$195
 Manual only \$18



CP/M and MP/M are registered trademarks of Digital Research Inc. Apple II is a registered trademark of Apple Computer, Inc. MS-DOS and Softcard are trademarks of Microsoft. TRS-80 is a trademark of Tandy Corporation. IBM is a trademark of International Business Machines.

CompuView
 PRODUCTS, INC.

1955 Pauline Blvd., Suite 200 ° Ann Arbor, Michigan 48103 ° (313) 996-1299

Circle 117 on inquiry card.

Introducing GENIE™

5-10-15-20

Megabyte 5.25" GENIE Winchester Drives

I.B.M. • APPLE II PLUS • RADIO SHACK

5 MEGABYTES
\$2295⁰⁰

10 MEGABYTES
\$2595⁰⁰

15 MEGABYTES
\$2895⁰⁰

20 MEGABYTES
\$3195⁰⁰



Talk about user friendly...

Comprehensive system utilities package.

Allows eight-character names to be assigned to virtual volumes.

User can back-up to either our 5 + 5™ removable Cartridge Drive or to diskettes. Mix & match different system file types on the same disk. System status screen messages.

Up to 16 volumes on-line at a time.

FEATURES

- Precision Manganese-zinc heads
- Average access time 77 ms.
- File sizes 5-20 megabytes
- Power-on self test
- Built-in error detection and correction
- System expandable to eight drives
- Comes complete with all necessary software and hardware
- No preventative maintenance required
- Built-in fan
- Operates 110/220 VAC 50-60 Hz
- One year warranty

Excellence in Engineering

Genie Drives were built with the user in mind. A design backed by many years of experience, the Genie Drive is everything a user ever wanted in a hard disk. We offer the ultimate in hard disk mass storage systems that money can buy.

IBM	APPLE II PLUS	RADIO SHACK
<ul style="list-style-type: none"> • Supports IBM-DOS, CP/M-86, PASCAL 	<ul style="list-style-type: none"> • Supports DOS 3.3, CP/M, and PASCAL 	<p>available soon</p>
<ul style="list-style-type: none"> • Ultra High Speed DMA data transfers • Only uses one slot in your IBM-PC • Allows you to run with up to four floppy disk drives 	<ul style="list-style-type: none"> • Boot from Hard Disk • Can assign Hard Disk volume to any slot or drive number in the system 	<p>S-100</p> <p>available soon</p>

*Manufacturer's suggested retail price. Includes all required components. IBM DOS Personal Computer is a registered trademark of IBM Corporation. Apple is a registered trademark of Apple Computer, Inc. Radio Shack is a registered trademark of Tandy Corporation. CP/M and CP/M-86 are registered trademarks of Digital Research.

Available at your local computer dealer

GENIE COMPUTER CORPORATION

31125 Via Colinas #908 • Westlake Village, CA 91362 • (213) 991-6210

Circle 182 on Inquiry card.

Introducing

GENIE™



5.25" Removable GENIE Winchester Cartridge Drive IBM • APPLE II PLUS • RADIO SHACK • S-100

The **Genie Cartridge Drive** is a revolutionary new 10 Megabyte Hard Disk Drive that includes a 5 Megabyte removable Winchester cartridge. The cartridge Drive system simply plugs into your computer, and includes all necessary software and hardware. Genie Drives are compatible with most popular software, and each cartridge replaces over 30 double-density floppy disks.



FEATURES

- 10 Megabytes of on-line storage.
- File sizes to 5 Megabytes.
- Power-on self-test.
- Easy back-ups in minutes.
- System expandable to eight drives.
- Built-in error detection and correction.
- No preventative maintenance required.
- Comes complete with all necessary software and hardware.
- MTBF 8000 Hours.
- Built-in fan.
- Operates 110/220 VAC 50-60 Hz.
- One year limited warranty.

Removable Cartridge. Imagine, 5 Megabytes in the palm of your hand. These small Winchester cartridges are only .75 inches thick and 5.50 inches square. The disk itself is completely sealed from the outside and all its hazards by a sliding door that opens only once the cartridge is firmly seated inside the drive. Long term availability of this cartridge is assured by its adoption by several well known manufacturers including **Dysan** and **Memorex**, the world leaders in computer mass storage media.

Talk about user friendly • • •

Comprehensive system utilities package. Allows eight-character names to be assigned to virtual volumes. User Can back-up to any Genie REMOVABLE Cartridge Drive, or to diskettes. Mix & Match different system file types on the same disk. System status screen messages. Up to 16 volumes on-line at a time.

Available at your local computer dealer

Manufacturer's suggested retail price. Includes all required components. Concurrent CP/M-86 is a registered trademark of Digital Research. IBM Personal Computer is a registered trademark of IBM Corporation. Apple is a registered trademark of Apple Computer, Inc. Radio Shack is a registered trademark of Tandy Corporation. Dysan is a registered trademark of Dysan Corp.

Only **\$3995⁰⁰***

GENIE COMPUTER CORPORATION

31125 Via Colinas #908 • Westlake Village, CA 91362 • (213) 991-6210

Circle 182 on Inquiry card.

Apple's Enhanced Computer, the Apple IIe

It's like having an Apple II with all the extras built in.

Robin Moore
Warner Hill Rd. RFD #5
Derry, NH 03038

It all began in the summer of 1977 at the West Coast Computer Faire. A fledgling computer company with an unusual name—Apple Computer—introduced a new hobby computer called the Apple II. The new Apple II was an impressive machine. It had BASIC in ROM (read-only memory), a built-in Teletype-style keyboard, high-resolution color graphics, and, once the new 16K-bit semiconductor memory devices became available, its memory could be expanded all the way up to 48K bytes. One of the first true home computers, it was completely self-contained, needing only a TV set for a display and a common cassette recorder for data storage.

Today, almost everyone is familiar with the Apple II. It can be found in homes, schools, laboratories, and businesses, and is being used in a wide variety of ways. During the past five years, an entire subindustry has sprung up around it that has, in turn, stimulated further Apple II sales.

It had been obvious for a while at Apple Computer that a replacement for the Apple II was needed. The Teletype-style keyboard, uppercase only 40-column display, and the

maximum of 64K bytes of memory were becoming limitations as the marketplace changed and software became more sophisticated. The design was getting old and technology had changed enough to allow a redesign with significantly fewer parts. A new design could also address foreign requirements for special keyboards, displays, and video signals better than the Apple II. Although the Apple II was a tremendous success, it was clearly time to design a successor.

Enter the Apple IIe

For about the same price as the Apple II, the Apple IIe (e for enhanced) provides a variety of exciting new features and capabilities. Rather than start from scratch and design an entirely new machine, Apple Computer Inc. chose to make a very careful series of enhancements and improvements while keeping the flavor and style of the Apple II. Although completely redesigned internally, the Apple IIe is clearly a member of the Apple II family.

Even though it looks almost the same as the Apple II, the Apple IIe (see photo 1) gives you a great deal more for your money. The base-priced machine includes 64K bytes of memory (expandable to 128K bytes), Applesoft BASIC in ROM, a 63-key keyboard that produces both upper-

case and lowercase characters and has special-function keys, seven expansion slots for I/O (input/output) devices, and a video interface that can display 24 lines in a 40-column-wide format with both uppercase and lowercase characters (this can be easily and inexpensively expanded to 80 columns). In addition to the standard Apple II I/O expansion slots, the main circuit board also holds a special auxiliary connector that is used primarily for various video- and memory-expansion options. Along with Applesoft BASIC, the internal 16K bytes of ROM hold an improved monitor, built-in self-test routines, extended memory-management routines, and an 80-column firmware package with extended editing features that can be used with the 40-column display.

The quality of the product is highly

Design Credits

Although it is impossible to give credit to all the people involved, three people deserve special mention. Peter Quinn, the POS Hardware Section Manager, was responsible for the team that designed the Apple IIe. Walt Broedner designed the Apple IIe hardware, including its two custom integrated circuits. Rick Auricchio is Broedner's software counterpart—he modified the original Apple II Plus firmware and added all the new code that is in the Apple IIe firmware.

About the Author

Rob Moore is a design engineering manager who also maintains a strong interest in FORTH, graphics, and computer music.



Photo 1: An Apple IIe system made up of the Apple Monitor III, the Apple IIe computer, and a Disk II 5¼-inch floppy-disk drive.



Photo 2: The rear panel of the Apple IIe. Instead of the plastic slots found in the Apple II, the Apple IIe's metal back panel is designed to mount 9-pin, 19-pin, and 25-pin D-type connectors in pre-cut recesses, providing more reliable connections and reduced RF interference. The built-in game-paddle connector has also been changed to a 9-pin D-type; however, the older-style connector is still available inside the case to accommodate existing devices.

evident. The case is rugged structural foam, the keyboard has a nice touch and dished keytops, and the back panel (see photo 2) has an array of openings that fit the 9-pin, 19-pin, and 25-pin D-type connectors commonly used for serial I/O devices. It appears obvious that the Apple IIe was designed from the ground up to meet the new FCC (Federal Communications Commission) RFI (radio-frequency interference) regulations.

The computer has a metal bottom pan, a metal back panel (rather than plastic as in the present model), and the removable cover is shielded with conductive paint and grounded with metal gaskets at the front and back edges. Some other nice touches include: the "D" and "K" keys (the ones that the middle fingers of a touch-typist's hands fall on) have small bumps on their surfaces; the connector openings on the back panel come

with plastic caps to cover them if connectors aren't installed; the top cover has tabs in the rear to help lift it open, and screw holes to help keep it shut when desired (schools should like this feature).

The Keyboard

The keyboard is the most obvious difference between the Apple II and the Apple IIe. It is essentially an enhanced version of the Apple III's keyboard without the numeric pad; the keyboard on the Apple IIe (see photo 3) has 63 keys, while the Apple II has 53, and the layout is slightly different. Although the changes seem minor, they make the new keyboard significantly easier to use, especially in word-processing or screen-editing applications.

One of the most significant changes is indicated only by the Caps Lock key. The Apple IIe keyboard provides full uppercase and lowercase operation. When Caps Lock is latched down, however, it operates much like the original Apple II keyboard and produces only uppercase characters. If the two solder pads on the main board labeled X6 are connected, programs can check to see if the Shift keys are pressed by reading the PB2 input in the game-paddle port. (This supports a common Apple II modification and many existing word-processing programs.)

To correct a limitation of the old Apple II keyboard, the new keyboard can produce all 128 ASCII (American National Standard Code for Information Interchange) character codes. This was accomplished in the Apple IIe by adding some new character keys, along with Tab and Delete keys, to improve its word-processing capability. (The added keys, with different keycaps, will be used in European versions to provide an ISO [International Organization for Standardization] standard keyboard layout.)

Two interesting additions are the Open-Apple and Solid-Apple keys, which are positioned one on each side of the space bar. If you press Control, Open-Apple, and Reset simultaneously, the Apple IIe will write some arbitrary data into each page of memory and then simulate a power-up

cold start. This eliminates the need to turn the Apple off and then on again to exit a protected program (a definite annoyance), but prevents people from making unauthorized copies of protected software.

Pressing Reset while holding Control and Solid-Apple invokes the built-in self-test software, which responds with "KERNEL OK" if the memory and circuitry pass the tests. Open-Apple and Solid-Apple may also be read individually and used as special-purpose keys by various programs—they are internally connected to the game-paddle port inputs PBO and PB1. Other improvements in-

clude a full set of cursor-control keys positioned to the right of the space bar, auto-repeat on all keys after a 0.9-second delay, and a relocated Reset key. (The Reset key is placed apart from the main keyboard to keep it from being pressed accidentally. In addition, the Control key must be pressed simultaneously with the Reset key to have an effect; this behavior, standard on the Apple IIe, was an option on later models of the Apple II Plus.)

Internally, the keyboard is completely different from that on the Apple II. The Apple IIe keyboard is a simple array of switches—the key-

board-scanning circuitry has been moved to the main printed-circuit board, which also holds a special numeric pad connector. A ROM on the main board maps the keyboard-switch closures into the appropriate ASCII codes and can be changed to provide foreign or special keyboards. (Incidentally, the American version of the ROM is only half used. The other half holds a Dvorak keyboard map that can be accessed with a few jumpers and etch cuts.) For programmers, the keyboard provides an additional "Any key down" flag; it can be read by examining location C010 hexadecimal. This will allow pro-

At a Glance

Product

The Apple IIe computer

Manufacturer

Apple Computer Inc.
20525 Mariani Ave.
Cupertino, CA 95014
(408) 996-1010

Components

System Unit

Size: width 15.2 inches (38.6 cm); depth 18 inches (45.7 cm); height 4.5 inches (11.4 cm)

Power Required: 107 to 132 VAC, 60 Hz, 60-80 watts maximum

Processor: 1-MHz 6502 8-bit microprocessor

Memory: 64K bytes of memory; 16K bytes of monitor in ROM (includes self-test, Applesoft BASIC, and 80-column routines)

Standard: keyboard for text and data entry; internal and external video connectors; 1-bit programmable audible speaker; audio cassette recorder input and output connectors; seven I/O expansion slots to hold peripheral devices and interfaces; external game control connector with four analog inputs and three TTL or switch inputs (similar internal connector includes three TTL-level outputs)

Video Display: Two Upper-case/lower-case Text Modes

- 24v by 40h standard
- 24v by 80h optional
- character set stored in ROM

Two Standard Graphics Modes

- 40h by 48v sixteen-color graphics (40 by 40 with four text lines)
- 280h by 192v bit-mapped array with half-dot-shift logic (280 by 160 with four text lines)—with appropriate software this can provide:
 - 560 by 192 monochrome graphics with some limitations
 - 280 by 192 monochrome graphics
 - 140 by 192 six-color graphics with some limitations
 - 140 by 192 four-color graphics

Video Outputs: Both outputs provide NTSC-compatible video, negative sync, 2-V peak-to-peak

Keyboard: 63 keys for text and data entry; N-key rollover; auto-repeat on all keys (15 Hz) after 0.9 seconds; four cursor-control keys; Caps Lock; two special-function keys; keyboard allows input of all 128 ASCII characters

Disk Drives: System supports up to six 140K-byte 5¼-inch floppy-disk drives; data is stored using Apple Computer's 6/8 GCR (group-coded-recording) encoding

Operating System

Apple's DOS 3.3 single-user, single-task, program-driven operating system provides multiple file types, random-access and sequential text files, random disk allocation, individual file protection, and slot-based I/O

Options

Standard options include 80-column text card; extended 80-column text card with 64K bytes of additional bank-switched memory; Apple Disk II floppy-disk drives and controllers

Available Software

Includes almost all existing Apple II software. New software includes Applesoft II word processor (\$195) and Quickfile IIe database system (\$100)

Hardware Prices

Apple IIe main unit	\$1395
Apple IIe system with main unit, Disk II and controller, Monitor III, monitor stand, and 80-column text card	\$1995
Apple Monitor III (green screen)	\$249
Apple Disk II (with controller/without controller)	(\$545/\$395)
80-Column Cards (standard/Extended card with 64 K memory)	(\$125/\$295)

Optional Documentation

Apple IIe Owner's Manual	\$20*
Applesoft Reference Manual (two volumes)	\$30
Applesoft Tutorial	\$25
Applesoft package (both books plus disk of software)	\$50
BASIC Programming Manual (Integer BASIC)	\$7
The DOS Manual (DOS 3.3)	\$10* **
DOS Programmer's Manual (available March, 1983)	n/a
DOS User's Manual with Tutorial (March, 1983)	n/a
Apple IIe Reference Manual	\$30
Apple IIe 80-Column Text Card Manual	\$20*
Apple IIe Extended 80-Column Text Card Supplement	\$15*

* included with associated Apple product, available optionally

** one-page errata sheet available free from dealers



LAST NIGHT WE EXCHANGED LETTERS WITH MOM, THEN HAD A PARTY FOR ELEVEN PEOPLE IN NINE DIFFERENT STATES AND ONLY HAD TO WASH ONE GLASS...

That's CompuServe, The Personal Communications Network For Every Computer Owner

And it doesn't matter what kind of computer you own. You'll use CompuServe's Electronic Mail system (we call it Email™) to compose, edit and send letters to friends or business associates. The system delivers any number of messages to other users anywhere in North America.

CompuServe's multi-channel CB simulator brings distant friends together and gets new friendships started. You can even use a scrambler if you have a secret you don't want to share. Special interest groups meet regularly to trade information on hardware, software and hobbies from photography to cooking and you can sell, swap and post personal notices on the bulletin board.

There's all this and much more on the CompuServe Information Service. All you need is a computer, a modem,

and CompuServe. CompuServe connects with almost any type or brand of personal computer or terminal and many communicating word processors. To receive an illustrated guide to CompuServe and learn how you can subscribe, contact or call:

CompuServe

Information Service Division, P.O. Box 20212
5000 Arlington Centre Blvd., Columbus, OH 43220
800-848-8990
In Ohio call 614-457-8650

An H&R Block Company



Photo 3: The Apple IIe keyboard. With uppercase and lowercase characters, N-key rollover, auto-repeat on all keys, and special-function keys, it provides a mix of functions found on both typewriter-style and computer keyboards. Unfortunately, the left-arrow key is inconveniently placed for its use as a backspace key while using BASIC. The special Open-Apple and Solid-Apple keys are used to invoke the self-test routines, simulate a power-up cold start, and may be read as paddle push buttons 0 and 1.



Photo 4: The Apple IIe video display. Photo 4a is an example of the 40-column text display showing both uppercase and lowercase characters available. Photo 4b shows the Apple IIe 80-column display. The plus sign within the cursor shows that you are in Escape mode, which provides expanded editing and cursor-control functions.

grams to provide their own auto-repeat or special pause functions, overriding the auto-repeat built into the keyboard.

Text-Display Modes

The standard Apple IIe displays 24 rows of 40 characters (see photo 4a). It provides normal (white on black) and inverse-video (black on white) modes for all characters, and a flashing mode for the uppercase characters and special symbols. If you try to display a lowercase character in flashing mode, the display shows a flashing special character instead. Although this may seem strange, it emulates exactly what is displayed by Apple IIs that have been modified with added lowercase adapters, and is done this way for compatibility with those machines. The Apple IIe also provides an alternate character set where there are only two modes—normal and inverse—but the characters are always displayed correctly.

Although the ability to display both uppercase and lowercase characters is a definite improvement, I suspect that few users will stay with the 40-column display. The two 80-column options are just too useful—and too inexpensive—to be ignored.

The 80-Column Display Options

To accommodate users who need a display wider than 40 columns, the Apple IIe offers two 80-column option cards: the 80-column text card and the extended memory 80-column card, which includes 64K bytes of additional memory. Either of these cards can be plugged into the auxiliary connector, and they are both just memory cards. Photo 4b shows an example of the 80-column text display.

The actual 80-column display circuitry and firmware are already built into the Apple IIe. In fact, by setting the appropriate soft switches, you can see an 80-column display on any Apple IIe—every character in the normal 40-column display will be displayed twice. Both of the 80-column cards (see photo 5) provide the additional display memory required for 80-column operation; however, the 80-column text card is inexpensive

Performance Breakthrough...

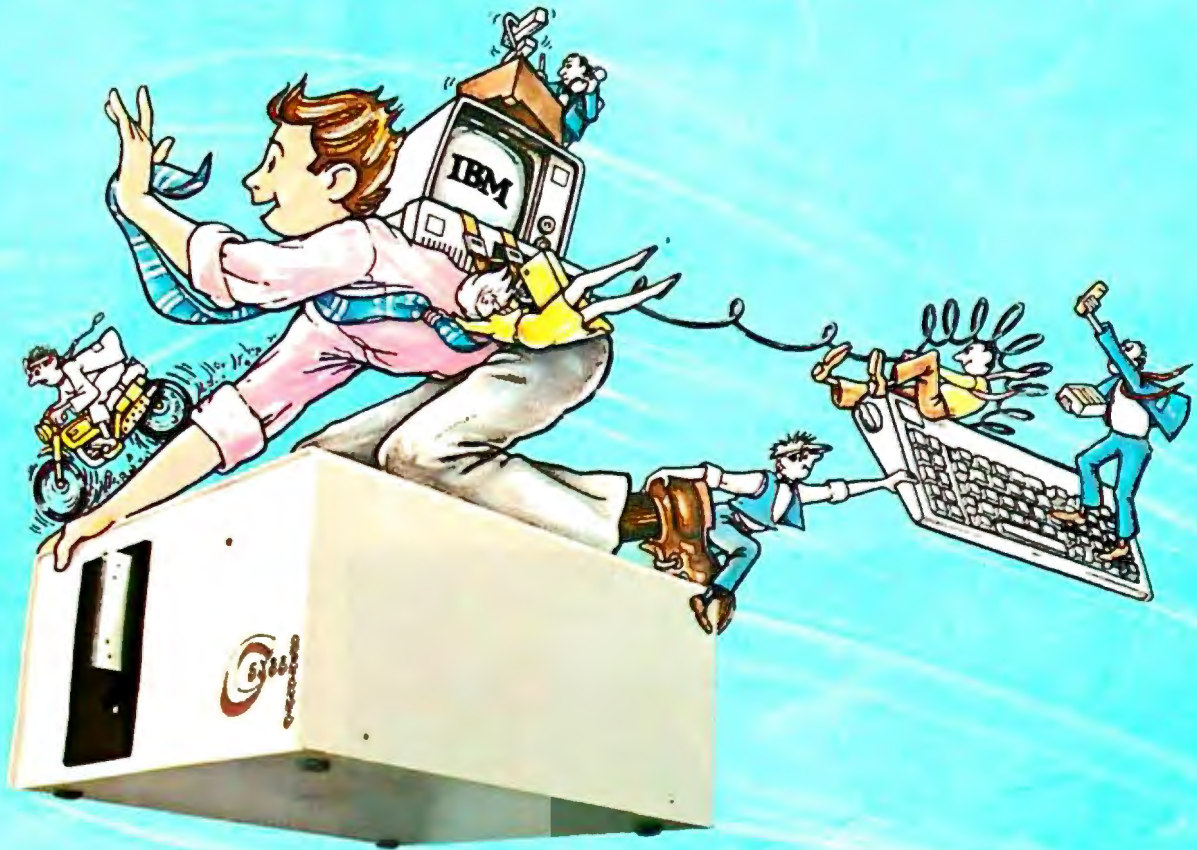

... the CYBERDRIVE™ for the IBM Personal Computer 13.5 or 27 million bytes of disk capacity in a single cabinet with an integrated mini-cartridge tape for secure data backup.

Setting an exciting new microcomputer standard, the CYBERDRIVE¹ combines a full package of features.

It offers new, higher performance levels, with an integrated business-oriented backup device.

As the CYBERDRIVE is made available for other systems, media transfer is assured regardless of the host hardware or Operating System.

The CYBERDRIVE slashes the seek time dramatically—e.g. the usual 5 Megabyte stepper-motor Winchester disk offers average seek time typically in the range of 100 to 200 milliseconds (incl. head settling).

With the CYBERDRIVE, the average seek time across more than five times as much data is only 33 milliseconds (incl. head settling).

This basic speed, coupled with disk cache buffering and a peak transfer rate of 1 million bytes per second, make the CYBERDRIVE a performance champ!

The integrated mini-cartridge tapes used for backup of data allow dumping of (for example) 10 million bytes of data in about 10 minutes... much faster than other tape or floppy disk backup techniques. Hardware read-after-write error checking is incorporated in the tape device.

... And don't fail to ask about our superb lineup of serious business software (also offered in CYBERDRIVE format) including:

RM/COBOL² compiler—the micro industry standard.

MBSI³ RM/COBOL general business applications (derived from **MCBA⁴** minicomputer packages)... thousands in use... money back guarantee... source program license.

CRTI¹ from Cybernetics (COBOL Reprogramming Tool!)- Program generator for RM/COBOL to ease program development and maintenance... an alternative to a Data Base System.

CBASIC² & CBASIC86⁵ compilers... for aficionados of a useful BASIC.

The software is available on a variety of industry-standard Operating Systems including CP/M⁵-MP/M⁵ (both -80 & -86), OASIS⁶, PC DOS, and UNIX⁷. Inquire for specific details and prices.

Trademarks of:

1. Cybernetics, Inc. 2. Ryan-McFarland Corp. 3. Micro Business Software, Inc.
4. Mini-Computer Business Applications, Inc. 5. Digital Research, Inc. 6. Phase One Systems, Inc. 7. Bell Laboratories

© Copyright 1982 by Cybernetics Inc. All rights reserved.
Prices and specifications subject to change without notice.

CYBERNETICS

8041 NEWMAN AVE., SUITE 208
HUNTINGTON BEACH, CA 92647
714/848-1922



Photo 5: The Apple IIe 80-column text card (bottom) and extended memory 80-column card (top). The 80-column text card provides an additional 1K-byte text/low-resolution graphics display page, while the extended memory 80-column card duplicates the entire Apple IIe 64K-byte address space.



Photo 6: Apple IIe graphics. See the text for a full explanation of the modes available.

because it is simply a 1K-byte memory card.

The extra (separate) display memory is needed because the 80-column circuitry displays twice as many characters in the same period of time as the 40-column circuitry. This doubles the rate at which the display accesses memory; if the Apple's main memory was used, this wouldn't allow the processor any memory cycles. The designers found an ingenious solution to this dilemma. The Apple IIe's display

always accesses memory at the 40-column rate, allowing the processor all the memory cycles needed. When in 80-column mode, however, the display circuitry reads both the main memory and auxiliary display memory simultaneously, saving the character that is read from the auxiliary memory and displaying it after the character read from the main memory. This allows the display to operate twice as fast but doesn't affect the operation of the processor.

One of the nicest things about the Apple IIe 80-column option is that it is compatible with all other Apple IIe display modes. In the old Apple II, people often used two monitors with 80-column cards—one for the 80-column display and one for 40-column text and graphics—because the available 80-column cards had separate video outputs for the 80-column text.

The 80-Column Firmware

The 80-column routines built into the Apple IIe ROMs provide a number of advanced cursor-control and editing features. One of the most interesting is the lowercase restrict mode. If you type a Control-R when the 80-column firmware is active, the keyboard input is restricted to uppercase only (just as if Caps Lock was pressed) unless you are between quotes. This mode is handy because Applesoft BASIC and DOS 3.3 won't accept lowercase commands—it locks you into uppercase except when typing in BASIC string constants (which can accept lowercase).

To maximize its compatibility with existing software, the Apple IIe 80-column firmware emulates an 80-column card installed in I/O slot 3 (the standard location). If one of the two 80-column option cards is installed, typing PR#3 will activate the internal 80-column routines and disable any firmware installed in slot 3. Once activated, the 80-column firmware and its extended editing features can be used in either 40-column or 80-column mode. In fact, by setting one of the soft switches, you can use the 80-column firmware even if you don't have the 80-column card installed.

To help you keep track of which display software is active, the Apple IIe displays three different types of cursors. A small checkerboard cursor indicates that the 80-column firmware is inactive. A larger block cursor is displayed when the firmware is on, and a + (plus sign) within the block indicates that the firmware is in "Escape mode" and is waiting for another keystroke, which will be interpreted as a cursor-movement command.

The 80-column software is also

No Waiting For Software.

Now that the Sage II has sparked the 16-bit super-micro revolution, you might wonder when software will become available.

The answer is now, because the Sage II's p-System operating system accommodates vast libraries of programs already produced for 8-bit machines.

What's more, this exciting micro has fired the imagination of programmers who are busy developing new software to take full advantage of its performance capabilities.

No Wait States.

The Sage II is based on the incredible 68000 processor.

One advantage is the total elimination of memory access wait states so that interaction between the processor, RAM and disk drives is speeded up.

If you've been blaming your floppy for tardiness, consider this: The Sage II loads a 20K program in about a second—from its 5¼" floppy.

The Specs You've Been Waiting For.

8 Mhz 68000 • up to ½ Mb on board RAM • 24-bit bus addresses up to 16 Mb • one or two built-in 5¼" floppy drives—320K to 1.3 Mb • RS-232C ports • Parallel port • IEEE-488 interface • Call or write for full specifications.

No Waiting Until You Can Afford It.

A Sage II with one disk drive and 128K on board RAM is priced at just \$3,600.

It represents more computing power for the money than ever before.



No Waiting For Delivery.

Our assembly, testing, and shipping departments are currently achieving a 4 day turnaround time on incoming orders. Order direct or through your dealer.

A Free P-System For Those Who Don't Wait.

The p-System operating system and Pascal, FORTRAN 77 and BASIC compilers which alone lists for \$1,475, we're now including free with the Sage II.

So see your dealer or give us a call. We'll be waiting to hear from you.

35 North Edison Way, Suite 4, Reno, Nevada 89502, (702) 322-6868.

SAGE

COMPUTER TECHNOLOGY

Circle 375 on Inquiry card.

16 Bits, No Waiting



compatible with other languages. If you have Apple's Pascal 1.1 or one of the Apple II CP/M systems, these both can load in 80-column mode and operate correctly without any additional patches or modifications.

Graphics

Like the Apple II, the Apple IIe offers two standard graphics modes. The low-resolution mode produces 16-color graphics, with either 40 by 48 pixels (picture elements) or 40 by 40 pixels and four lines of text. The standard high-resolution mode provides a 280 by 192 bit-mapped pixel array with half-dot-shift logic (see photo 6). Depending upon the software used, this mode can be used to provide limited 560 by 192 monochrome graphics, 280 by 192 monochrome graphics with no limitations, 140 by 192 six-color graphics with limitations, or 140 by 192 four-color graphics. (The vertical dimension is reduced to 160 pixels if you want four lines of text at the bottom.)

The 80-column options are the keys

to the new Apple IIe graphics features. With the proper software, the Apple IIe can provide double-density graphics in both low-resolution and high-resolution modes. Either of the 80-column cards will support the double-density low-resolution graphics, but you will need the extended memory 80-column card if you want to use the double-density high-resolution mode, which can also provide 140 by 192 graphics with 16 colors! At the time this article was written (November 1982), no software was available to support these new graphics modes; however, it will undoubtedly be available soon, either from commercial vendors or user's groups.

The double-density graphics modes are provided by the 80-column display circuitry. Instead of simply displaying bytes sequentially from the main memory, it displays bytes alternately from the main memory and the auxiliary memory, at twice the normal rate. Although this capability was designed to provide an 80-col-

umn text display, the designers soon realized that it could also be used to provide additional graphics modes.

Use of the double-density graphics has three requirements. First, you need a Revision "B" main circuit board; this will probably be the only type shipped after the first month of production. Second, you must connect two pins on your 80-column card; this is explained in the *Apple IIe Reference Manual*. Third, you must turn on the AN3 output to the gamepaddle connector; this can be used to switch between normal and double-density mode. (Unfortunately, the Apple IIe sent to BYTE for review had a Revision "A" main board. Thus, there is no photo of the new graphics modes included with this article.)

Inside the Box

The most significant differences between the Apple II and the Apple IIe are internal. The main printed-circuit board has been totally redesigned and incorporates many new features and options unavailable in the Apple II.

It's not Magic, it's NEC.

NEC distributors pull miracles out of a thimble.

NEC Spinwriters.™ Their supernatural reliability and versatility have made them the world's most popular letter-quality printers. Here are some of the miracles they can perform for you.

The Spinwriters' rapidly growing catalog of print thimbles give you incredible versatility. One NEC thimble can print in 35 different languages. Another has complete technical and mathematical symbols. Another a full scientific symbol font. The thimbles snap in and out in seconds. And they each last for more than 30 million impressions.

Of all printer companies, *only* NEC designs and manufactures its own comprehensive family of forms handlers. We've got eight of them, enough to handle any form you can conjure up. They're all user-changeable, too.

Spinwriters have remarkable reliability, more than two years between failures in normal usage. And they need no preventive maintenance or



routine lubrication. Ever. With only 3 major spares, mean time to repair is only 15 minutes.

The NEC Spinwriters. Reliable, quiet, compact, flexible and easy to use. For more information on NEC Spinwriters, or to find out how to become an NEC distributor yourself, contact the authorized NEC distributor nearest you.

Spinwriter is a trademark of Nippon Electric Co., Ltd.

NEC
NEC Information Systems, Inc.

The power supply is unchanged, but there are now seven I/O expansion slots instead of the eight found in the Apple II. Part of the Apple IIe memory emulates a 16K-byte RAM (random-access read/write memory) card (commonly installed in Apple IIs), and the card's former location, I/O slot 0, is no longer present.

The most obvious change is a reduction in the number of ICs (integrated circuits). Where an Apple II with a keyboard enhancer, a 16K-byte memory card, and an 80-column card included about 120 ICs, the Apple IIe provides the same features with just 31 ICs. A large part of this reduction is due to the use of 64K-bit dynamic memories, rather than 16K-bit ones. The entire 64K-byte memory of the Apple IIe occupies just 8 ICs.

Another significant reduction in IC count is provided by two custom-designed MOS (metal-oxide semiconductor) ICs—the IOU (input/output unit) and MMU (memory-management unit)—that manage memory

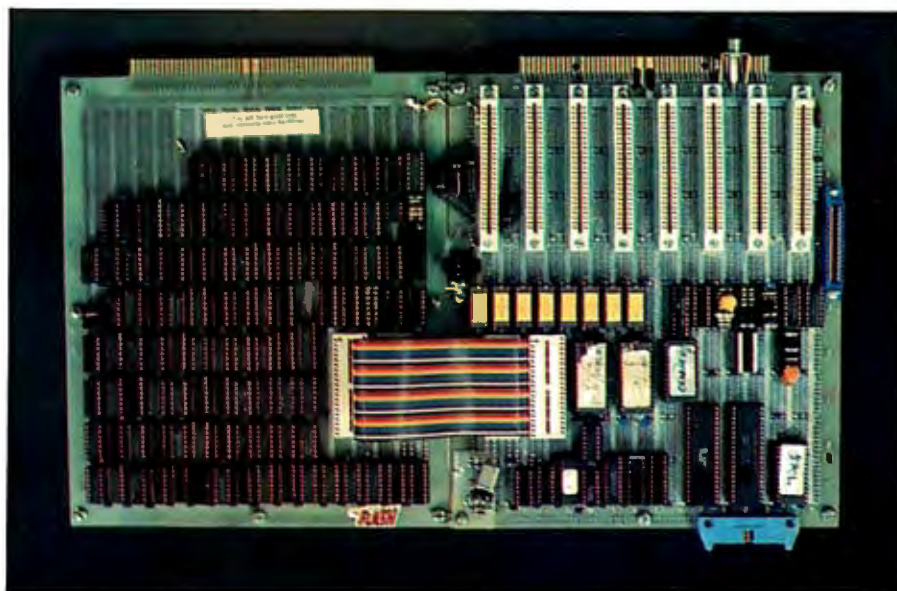

Photo 7: The Apple IIe engineering prototype wire-wrap boards. The custom MOS IOU and MMU ICs are emulated with discrete logic on the board to the left, while the Apple IIe main board prototype is on the right.

and I/O decoding and provide many of the new internal features. Photo 7 shows the engineering breadboard of the Apple IIe main board and a second board that emulates the IOU and

MMU with standard 7400-series ICs, so that the designs could be completely tested before committing them to silicon. The IOU and MMU emulations required about 50 and 60 ICs

ALABAMA

W.A. Brown Instruments, Inc.
(205) 883-8660
Hall-Mark Electronics Corp.
(205) 837-8700
Huntsville, AL

ALASKA

Transalaska Data Sys., Inc.
Anchorage, AK
(907) 276-5616

ARIZONA

Hall-Mark Electronics Corp.
(602) 243-6601
International Data Systems
(602) 231-0888
Phoenix, AZ
The Phoenix Group, Inc.
Tempe, AZ
(602) 894-9247
Spirit Electronics
Scottsdale, AZ
(602) 998-1533

CALIFORNIA

Byte Industries
(415) 783-8272
ComputerLand Corp.
(415) 487-5000
Hayward, CA

Consolidated Data Terminals
Oakland, CA
(415) 638-1222

Data Systems Marketing
San Diego, CA
(619) 560-9222

Eakins Associates, Inc.
Mountain View, CA
(415) 969-4533

Electronic Mktg. Specialists
Tustin, CA
(714) 832-9920

Electronic Mktg. Specialists
Sunnyvale, CA
(408) 245-9291

Electronic Mktg. Specialists
Reseda, CA
(213) 708-2055

Electronic Mktg. Specialists
San Diego, CA
(619) 560-5133

Emerson Enterprises
San Ramon, CA
(415) 837-8728

Hall-Mark Electronics Corp.
Sunnyvale, CA
(408) 773-9990

Hall-Mark Electronics Corp.
San Diego, CA
(619) 268-1201

Leasametric
Foster City, CA
(415) 574-4441

Leasametric
Culver City, CA
(213) 670-0461

Micro Business World
Tarzana, CA
(213) 996-2252

RC Data, Inc.
San Jose, CA
(408) 946-3800

Renaissance Tech. Corp.
Concord, CA
(415) 676-5757

Terminal Rentals, Inc.
Tustin, CA
(714) 832-2414

Terminal Rentals, Inc.
San Jose, CA
(408) 292-9915

United States Data Systems
San Mateo, CA
(415) 572-6600

Vitek
San Marcos, CA
(714) 744-8305

Waybern Corp.
Garden Grove, CA
(714) 554-4520

Western Microtechnology
Cupertino, CA
(408) 725-1662

COLORADO

Acorn Data Products
Englewood, CO
(303) 779-6644

Data Design & Development
(303) 296-3807
Hall-Mark Electronics Corp.
(303) 934-3111
Denver, CO

FLORIDA

W.A. Brown Instruments, Inc.
Orlando, FL
(305) 425-5505

W.A. Brown Instruments, Inc.
Fort Lauderdale, FL
(305) 776-4800

W.A. Brown Instruments, Inc.
Melbourne, FL
(305) 723-0766

W.A. Brown Instruments, Inc.
Tampa, FL
(813) 985-0394

Cain & Bullman, Inc.
Jacksonville, FL
(904) 356-4812

Hall-Mark Electronics Corp.
Fort Lauderdale, FL
(305) 971-9280

Hall-Mark Electronics Corp.
Orlando, FL
(305) 855-4020

Hall-Mark Electronics Corp.
St. Petersburg, FL
(813) 576-8691

GEORGIA

W.A. Brown Instruments, Inc.
Atlanta, GA
(404) 455-1035

Digital Solutions, Inc.
Marietta, GA
(404) 955-4488

Hall-Mark Electronics Corp.
Norcross, GA
(404) 447-8000

HAWAII

Gray Associates
Kailua, HI
(808) 261-3751

ILLINOIS

Dytec/Central, Inc.
Arlington Heights, IL
(312) 394-3380

Hall-Mark Electronics Corp.
Bensenville, IL
(312) 860-3800



Photo 8: The Apple IIe main circuit board. The 31 ICs on this board replace the 120 ICs found in a standard Apple II, including a memory card, 80-column card, and keyboard enhancer, as well as providing a number of new features not available in the Apple II.

respectively. In the final board (shown in photo 8), these 110 ICs are replaced with just two components.

Working together, the IOU and MMU generate all memory-address-

ing and I/O-decoding signals. The MMU is primarily responsible for supporting the 6502 processor. It accepts addresses from the processor, does any necessary memory-bank

switching, and converts the address to the multiplexed form required by the dynamic memories. The IOU provides similar functions for the video display. It also includes the video-timing logic, keyboard control, and other miscellaneous functions. To support foreign versions of the Apple IIe, the IOU includes video circuitry to provide both the American-standard NTSC (National Television System Committee) signals and European-standard PAL signals. The IOU ICs are customized during assembly by the manufacturer by connecting the internal bonding wires to the appropriate set of pads on the IC chip inside the package.

The Auxiliary Connector

Although I/O slot 0 is no longer present, a new "auxiliary connector" can be used in a variety of ways. In the factory, the auxiliary connector is used to connect special test equipment to the Apple IIe. With this equipment and the signals available at the auxiliary connector, problems

Information Systems, Inc.
Arlington Heights, IL
(312) 228-5480

Kaltronics
Northbrook, IL
(312) 291-1220

Nabl's, Inc.
Evanston, IL
(312) 869-6140

Tek-Aids Industries, Inc.
Arlington Heights, IL
(312) 870-7400

INDIANA

Dytec/Central, Inc.
Indianapolis, IN
(317) 247-1316

General Microcomputer
South Bend, IN
(219) 277-4972

Graham Elec. Supply, Inc.
Indianapolis, IN
(317) 634-8202

Star-Tronic Distributor Co.
Carmel, IN
(317) 844-0102

IOWA

Dytec/Central, Inc.
Lenexa, KS
(319) 363-9377

KANSAS

Hall-Mark Electronics Corp.
Lenexa, KS
(913) 888-2747

Inland Associates, Inc.
Olathe, KS
(913) 764-7977

LOUISIANA

W.A. Brown Instruments, Inc.
Mandeville, LA
(504) 626-9701

MARYLAND

Bartlett Associates, Inc.
Bethesda, MD
(301) 856-3061

Hall-Mark Electronics Corp.
Baltimore, MD
(301) 796-9300

M/A-Com Atlanta's
(301) 770-1150

Mera Distributors, Inc.
(800) 638-6621
Rockville, MD

The Zamolski Co.
Baltimore, MD
(301) 644-2900

MASSACHUSETTS

Bartlett Associates, Inc.
Framingham, MA
(617) 879-7530

The Computer Store, Inc.
Sudbury, MA
(617) 879-3700

Continental Resources, Inc.
Bedford, MA
(617) 275-0850

CPU Computer Corp.
Charlestown, MA
(617) 242-3350

Microamerica Distr. Co., Inc.

Needham, MA
(617) 449-5807

Sims, Inc.
Natick, MA
(617) 655-6415

MICHIGAN

General Data Company, Inc.
Brighton, MI
(313) 227-3046

Star-Tronic Distributor Co.
Farmington Hills, MI
(313) 477-7586

WKM Associates, Inc.
Madison Heights, MI
(313) 598-2300

MINNESOTA

Hall-Mark Electronics Corp.
Bloomington, MN
(612) 854-3223

Inland Associates, Inc.
Minneapolis, MN
(612) 379-5354

Kaltronics Distributing, Inc.
St. Paul, MN
(612) 293-0385

Yeann Central, Inc.
Minneapolis, MN
(612) 623-3650

Tele-Terminals, Inc.
Brooklyn Park, MN
(612) 536-6000

MISSOURI

Hall-Mark Electronics Corp.
Maryland Heights, MO
(314) 291-5350

Inland Associates, Inc.
St. Louis, MO
(314) 391-6901

NEW JERSEY

Hall-Mark Electronics Corp.
Cherry Hill, NJ
(609) 424-7300

Hall-Mark Electronics Corp.
Fairfield, NJ
(201) 575-4415

Logan, Inc.
Hackensack, NJ
(201) 646-9222

TransNet Corporation
Union, NJ
(201) 888-7800

WP Perich & Supply Co., Inc.
Matawan, NJ
(201) 946-4995

NEW YORK

Bartlett Associates, Inc.
White Plains, NY
(914) 949-6476

Bartlett Associates, Inc.
Hempstead, NY
(716) 651-6300

The Computer Factory
New York, NY
(212) 687-5000

Erin Computer Distr. Corp.
Farmingdale, NY
(516) 293-4114

Ossmann Computer Tech., Inc.
East Syracuse, NY
(315) 437-6886

Ossmann Computer Tech., Inc.
Rochester, NY
(716) 473-5720

Ossmann Computer Tech., Inc.
Vestal, NY
(607) 785-9947

can be localized to one or two ICs.

Once in the customer's hands, the auxiliary connector is used to hold various video and memory options. Its set of signals provides access to a number of areas in the Apple IIe and can, in fact, be used to totally disable the internal video-generation circuitry, so that an alternate video generator can be installed. Currently, the only options supplied by Apple Computer Inc. for the auxiliary slot are the two 80-column cards. However, other devices should soon be available from Apple and other manufacturers.

The Extended Memory 80-Column Card

Besides an 80-column display, the extended memory 80-column card provides an additional 64K bytes of memory. Rather than switching blocks of auxiliary memory into a fixed address range, the designers chose to replicate the entire 64K-byte addressing space on the auxiliary card and provide a series of soft switches that enable either the main

memory or auxiliary memory in various address ranges. The documentation points out that "even though an Apple IIe with an extended memory 80-column card has a total of 128K bytes of programmable memory in it, it is not appropriate to call it a 128K-byte system. Rather, there are 64K bytes of auxiliary memory that can be swapped for main memory under program control."

To help programmers use the auxiliary memory, the Apple IIe 80-column firmware provides two special routines: AUXMOVE and XFER. Using these two routines, you can store and retrieve data in the auxiliary memory or transfer control to a program that resides there.

AUXMOVE is used to copy data from main memory to auxiliary memory or vice versa. You simply store the data's starting address, ending address, and destination address in memory locations; set or clear the processor's carry flag to indicate direction; and call AUXMOVE. XFER is used in a similar fashion in order to

jump from programs in main memory to others in auxiliary memory (or vice versa). XFER may also be used to switch stacks and zero pages as you transfer from one section of memory to the other.

These two routines, and the auxiliary memory, open up some interesting possibilities. It appears to be possible, for example, to have an entire Pascal system residing in main memory, while a DOS 3.3/BASIC system is in auxiliary memory, and be able to transfer control between the two systems at will.

Soft Switches

To support the auxiliary memory and 80-column display software, the Apple IIe provides a number of new soft switches and adds a few new features to the old ones. (A soft switch, in an Apple II or Apple IIe, is a memory location that can be accessed to cause some hardware change to take place.)

Existing soft switches in the Apple II were used to select various video

NORTH CAROLINA

W.A. Brown Instruments, Inc.
Durham, NC
(919) 683-1580

Hall-Mark Electronics Corp.
Raleigh, NC
(919) 832-4465

OHIO

General Data Co., Inc.
Cincinnati, OH
(513) 851-2585

General Data Co., Inc.
Lakewood, OH
(216) 226-8833

General Data Co., Inc.
Fostoria, OH
(419) 435-1191

Hall-Mark Electronics Corp.
Highland Heights, OH
(216) 473-2907

Hall-Mark Electronics Corp.
Westerville, OH
(614) 891-4555

Midwest Microcomputer
Defiance, OH
(419) 782-1115

WKM Associates
Cleveland, OH
(216) 524-5930

National Instr. Distr. Inc.
Dayton, OH
(513) 435-4503

Star-Tronic Distributor Co.
Fairview Park, OH
(216) 779-9660

Star-Tronic Distributor Co.
Englewood, OH
(513) 836-0951

OKLAHOMA

Data Applications Corp.
(918) 250-8686

Hall-Mark Electronics Corp.
(918) 665-3200
Tulsa, OK

OREGON

Microware Distributing
Aloha, OR
(503) 642-7679

PENNSYLVANIA

Bartlett Associates, Inc.
Norristown, PA
(215) 666-7100

General Data Company
Pittsburgh, PA
(412) 788-4800

Star-Tronic Distributor Co.
Monroeville, PA
(412) 372-3340

WKM Associates
Pittsburgh, PA
(412) 892-2953

SOUTH CAROLINA

W.A. Brown Instruments, Inc.
Columbia, SC
(803) 798-8070

TENNESSEE

W.A. Brown Instruments, Inc.
Oak Ridge, TN
(615) 462-5761

TEXAS

Data Applications
Addison, TX
(214) 931-1100

Data Applications
Houston, TX
(713) 686-8413

Data Applications
San Antonio, TX
(512) 732-7176

D&B Data Systems
Piano, TX
(214) 422-7910

D&B Data Systems
Houston, TX
(713) 463-7661

Hall-Mark Electronics Corp.
Dallas, TX
(214) 343-5000

Hall-Mark Electronics Corp.
Austin, TX
(512) 258-0848

Hall-Mark Electronics Corp.
Houston, TX
(713) 781-6100

Southern Micro Distributors
Irving, TX
(214) 258-6636

UTAH

Acorn Data Products
Salt Lake City, UT
(801) 973-7958

VIRGINIA

Nine Associates
Fairfax, VA
(703) 273-1803

Terminals Unlimited
Falls Church, VA
(703) 237-6666

WASHINGTON

Micro Technology, Inc.
Tacoma, WA
(206) 272-3347

Sigma Distributing
Bellevue, WA
(206) 454-8307

WISCONSIN

Hall-Mark Electronics Corp.
Oak Creek, WI
(414) 761-8000

NEC

NEC Information Systems, Inc.

Circle 296 on inquiry card.

(1a)

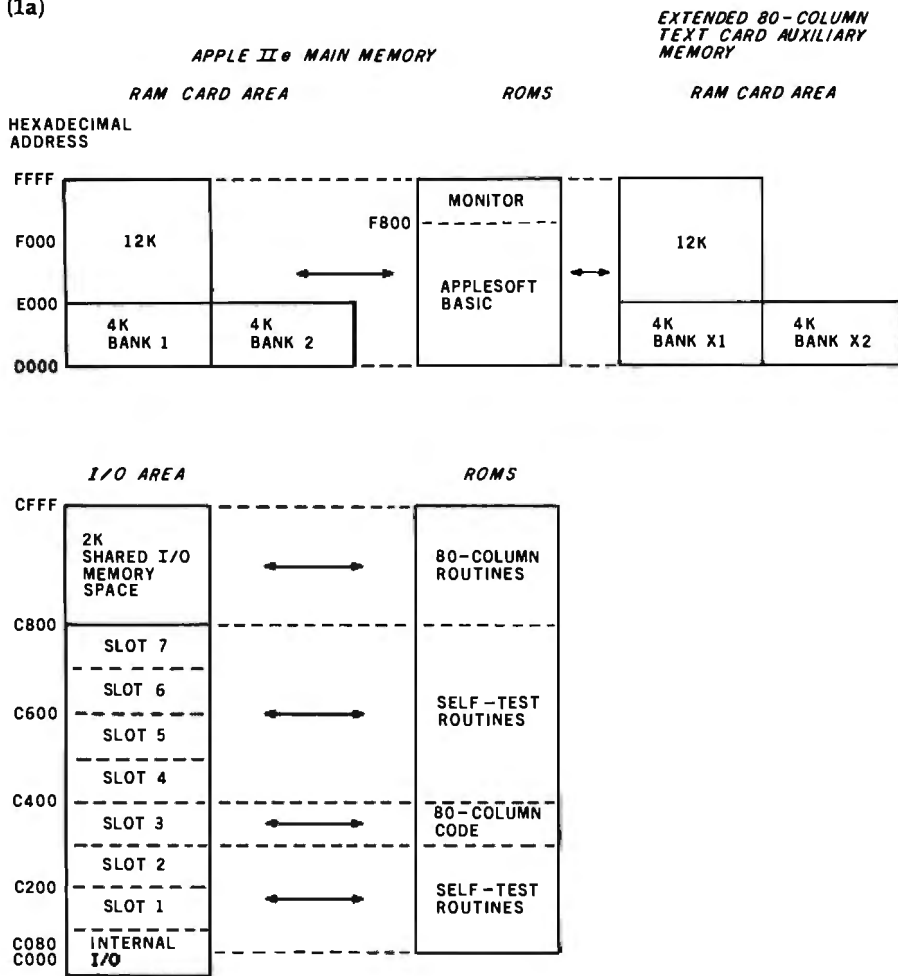

Figure 1: Apple IIe memory maps. Within the Apple IIe's main memory, ROM can be switched to replace RAM in various address ranges. When the extended 80-column text card is used, it adds 64K bytes of switched memory. Areas of RAM and ROM that can be switched are indicated with arrows. In the 80-column text and double-wide graphics modes, the computer's main memory and the auxiliary memory on the card are accessed simultaneously to double the display density. Figure 1a (above) shows the language-card RAM and I/O areas, while figure 1b (on page 82) shows the main RAM and display areas of memory. The 80-column text card includes the alternate text page x1 only.

modes and control the internal I/O devices (keyboard, game paddles, speaker port, and cassette port). If a 16K-byte memory card was added, it included additional switches to disable the card or to enable areas on the card as read-only or read-write memory. When using the switches, however, the programmer had to keep track of them. There was no way to read them back.

The Apple IIe makes many of the existing soft switches, and all the new ones, readable. Specifically, you can read back the states of the video-mode switches, the 16K-byte memory-card-area switches, and all the new auxiliary-memory switches by examining locations between hexa-

decimal C010 and C01F. To help provide better graphics animation, you can also read the "vertical blanking" from the video display, thus allowing you to change the contents of memory while it is not being used to create the video display.

The auxiliary memory is supported by several new switches that change the display from main to auxiliary memory, enable display areas in both memories at once for 80-column text or double-density graphics, and control reads and writes to the auxiliary memory. Other switches allow you to overlay portions of the I/O-slot memory space with the internal ROM 80-column firmware or self-test routines, and select either the standard or

alternate display character sets. (Figures 1a and 1b provide memory-switching maps for the Apple IIe.)

Apple II Compatibility

One of the major concerns during the design of the Apple IIe was its level of compatibility with the Apple II. Literally thousands of programs are written for the Apple II, and numerous hardware products are designed to plug into Apple II I/O slots. User surveys had shown that the volume of available software was a prime consideration among purchasers. It was therefore obvious that the new machine had to be compatible with virtually all existing Apple II hardware and software products, while still including the desired new features and design improvements.

The designers succeeded admirably. The Apple IIe is physically a complete redesign; logically, however, it is compatible with almost all existing Apple II software and hardware add-ons. This goal was not met simply—more than 150 software products and numerous peripheral devices were tested for compatibility during the Apple IIe development process.

Unfortunately, a few Apple II-based products from other manufacturers won't work properly in an Apple IIe—primarily because their designers did not follow Apple's interface guidelines. In general, accessory cards that occupy one of the I/O slots and do not connect directly to an IC socket will operate correctly. Others that connect directly to the main circuit board or to the keyboard will not be compatible without redesign.

Examples of cards that *will* work in an Apple IIe include 80-column cards, serial and parallel interfaces, graphics tablets, disk controllers, and memory cards that do not connect to an IC socket. To maximize compatibility, Apple II-style video- and game-paddle connectors are provided inside the case, even though the new-style connectors are now on the back panel. This allows existing video switches, joysticks, and game controls to be used with the Apple IIe (although they may cause excessive

INFORMA X

Beyond DBMS

Eventually microcomputers will all use programmer-less information management systems like **INFORMA X®**. The next generation in software. The first in multi-user.

Your microcomputer, no matter how expensive or well designed, is no better than the program it uses. And most programs are limited to only one or two functions. They are for accounting, or payroll, or inventory, or mailing, or filing, or computing, or whatever . . . and usually for just one user, as well.

Soon after buying a first computer every businessman or professional finds he needs to do more than one procedure with it. He also discovers that more than one person in his office will need to use it at the same time.

INFORMA X is the first information management system professionally engineered from its inception to operate in the multi-user, multi-tasking, and multi-processing environment. It is **the only database software you will ever need.**

The unique achievement of **INFORMA X** is an information system which structures data for storage and retrieval. It is the most efficient framework for an elegant computer filing system. Usually these systems require a programmer to fit them to the particular tasks of your business. **INFORMA X** provides a programmer-less system for even the **first time user** to create programs which fit exactly his own business needs.



Menu driven, screen oriented tutorial response techniques allow anyone to create, modify or customize programs to their own exact requirements. No "computerese" or cryptic languages are used; only single keystroke command structure has been used through the system's five components: **THE DATABASE, THE REPORTER, THE APPLICATION WRITER, THE SECURITY SYSTEM and THE MENU MAKER.** Automate your information storage, retrieval and transmittal . . . your way . . . and step into the next generation of business life.

ABACUS DATA is committed to creating software to enhance your business today and tomorrow. We welcome questions and comments. Use our toll free service numbers. **1-800-874-8555** and in Florida call collect **904-398-8547.**



abacus data, inc.™
1920 San Marco Boulevard
Jacksonville, Florida 32207

CURRENT SPECIFICATIONS: Z80, 8085, 8080A
Minimum Memory 52K. CP/M®, MP/M®, MmmOST®, TurboDOS®
Operating Systems. Current delivery customized for TeleVideo®,
Osborne®, Molecular®, Action®, and Altos®
(Call for others)

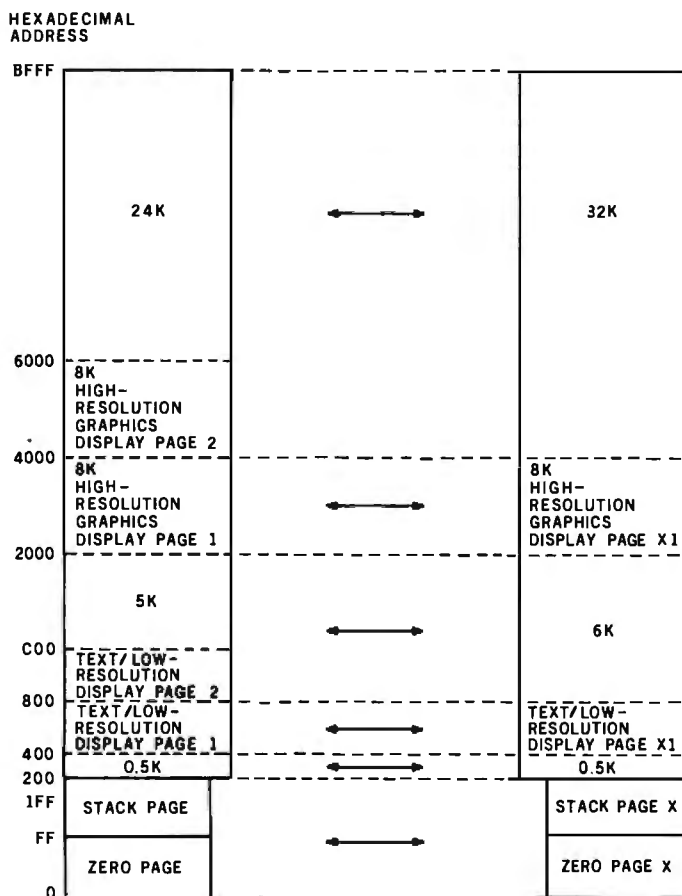

Figure 1: (continued)

RF interference).

Devices that won't work in an Apple IIe include keyboard enhancers, lowercase display adapters, numeric pads (existing designs), and memory cards that connect to an IC socket with a small flat cable. Fortunately, the capabilities of most of these devices are already included in the Apple IIe.

It is much harder to quantify which Apple II software products will or will not work in an Apple IIe. To support the new hardware features, certain changes had to be made to the ROM monitor routines, and these changes may affect programs that use the monitor. Approximately 40 standard entry points and routines in the monitor have been documented by Apple Computer, and all these have been left intact and operate correctly, even though the actual code may have changed somewhat. However, some programs use undocumented entry points and these may or may not run properly.

It seems safe to assume that all programs written in higher-level languages will work. Thus, software written in Integer or Applesoft BASIC, FORTRAN, PILOT, Logo, and Pascal should run correctly (providing that no strange monitor CALLs were made), along with CP/M programs that use the standard BIOS (basic input/output system) CALLs. Also, any software sold by Apple Computer will be compatible with the Apple IIe. In addition, a great deal of commercial software has been tested at Apple Computer, and your local dealer should know which products are compatible with the new machine. (If in doubt, you should ask the dealer to demonstrate the program on an Apple IIe before purchase.)

Software

As with most new computers, a great deal of software isn't available yet specifically for the Apple IIe, but the machine doesn't require it. Most

of its new features can be applied to make existing Apple II software easier to use. At least initially, the Apple IIe will use the same DOS 3.3 disk operating system that is currently used in the Apple II, although it will probably be repackaged on a new master disk.

Apple Computer Inc. has done a great deal to make writing programs for the Apple IIe as easy as possible. The *Apple IIe Reference Manual* provides precise technical descriptions of every area of the machine, and the built-in memory-management routines will encourage programmers to take advantage of the extended memory option. Because the 80-column firmware acts like a conventional 80-column card in I/O slot 3, programs that use 80-column displays can easily be compatible with both the Apple IIe and the Apple II.

To help programmers identify the type of machine and which options are present, the *Apple IIe Extended 80-Column Text Card Supplement* to the reference manual provides an identification routine, with examples in assembly language, BASIC, and Pascal. To aid outside developers (Apple considers them extremely valuable), 120 Apple IIes were lent to various vendors during the eight months prior to the product introduction. This allowed a large number of software and hardware suppliers to prepare a variety of new products—eighteen programs from ten companies are scheduled for introduction coincidentally with the Apple IIe.

One interesting new program for the Apple IIe is simply called "Apple presents Apple IIe." Primarily a keyboard tutorial, it uses humorous text and excellent graphics to guide you in a friendly fashion through the features of the Apple IIe keyboard. The section that teaches the cursor keys includes two simple but well-designed maze games where you guide a rabbit or gnome through a maze with the cursor-control keys. These made an immediate hit with our 3-year-old, who within 15 minutes was guiding the rabbit through the maze and laughing at its antics when it hit the walls.

TO ORDER CALL:
1-800-451-2502
617-641-1241

Technical Support
617-641-1235

SoftwareBanc

661 Massachusetts Ave, Arlington, Ma. 02174

*So, what good is your IBM
Personal Computer anyway?
Yours is the only computer that can run..*



One program combining three essential productivity tools:
Spreadsheet Information Management Graphics
for only \$495!

*"We are determined to provide the same level of support for 1-2-3™
that has made SoftwareBanc the nation's leading dBASE II™ dealer."*

*Adam B. Green
President
SoftwareBanc*

1-2-3 is a registered trademark of Lotus Development Corporation
dBASE II is a registered trademark of Ashton-Tate, Inc.
IBM Personal Computer is a registered trademark of International Business Machines

Circle 388 on Inquiry card.

Applewriter and Quickfile

Applewriter IIe and Quickfile IIe are Apple Computer's first two major software products that are designed to use all the new Apple IIe features. Both are enhanced versions of the same programs for the Apple III, and both are characterized by being extremely friendly to the user—they provide clear, simple prompts, multiple menus to select options, and numerous "help" screens to guide you through the program operations. Although at the time this article was written (with Applewriter) the documentation was preliminary, it appears to follow the format of the other Apple IIe manuals—clear and friendly.

Applewriter IIe is a document-oriented word processor with numerous editing and print-formatting features. It will run with or without the 80-column display and extended memory options, but will use them if they're present. One of the more interesting features of Applewriter IIe is called WPL (word-pro-

cessing language). WPL allows you to compose and execute a series of Applewriter commands that are stored in a disk file. It provides looping, conditional execution, and sub-routine calls, effectively allowing you to automate the production of form letters, invoices, or other repetitive tasks. WPL also provides a turnkey capability that can be used to automatically execute a WPL program after you load the Applewriter IIe disk.

To get familiar with Applewriter IIe, I used it to prepare this article. I was particularly impressed with the print-formatting capabilities. It was very easy to set up a standard manuscript page—double-spaced, one-inch margins, with headers and footers—and I could preview the actual appearance of the result by printing to the display rather than the printer. It did, however, take me a while to get used to some of the editing features. When you delete characters, words, or paragraphs, Applewriter deletes from right to left. This is fine if you

are correcting a mistyped character immediately but seems a little awkward otherwise. On the whole, I liked Applewriter and recommend that you look it over if you are considering purchasing a word processor for your Apple IIe.

Quickfile IIe is an information-filing system (or database manager) that allows you to store and retrieve information, search and sort your files, and print reports in formats that you define. It also has math capability—you could set it up, for example, to file a list of checks and their amounts, and it could also balance your checkbook for you.

Quickfile IIe is also compatible with Applewriter IIe. Quickfile reports can be included in Applewriter documents, and Quickfile files can guide the production of Applewriter form letters. I didn't get a chance to spend much time with Quickfile, but it appears to be very well done, as is most of Apple's software.

Documentation

The new Apple IIe manuals are so good they must be seen to be believed. In a spiral-bound format, slightly larger than the Apple II manuals, they are extremely clear and readable—presenting their information in an easy step-by-step manner. It is obvious that Apple spared no effort or expense when designing them.

The *Apple IIe Owner's Manual* is an excellent example of the right way to introduce a beginner to a first computer. Using clearly written text and numerous color photos, it starts out by telling you how to unpack and set up the computer and then explains the various parts of the system in layman's terms. As you read through the manual, points of special interest and warnings are clearly noted and possible error messages are explained. Nine pages are devoted to the keyboard alone—they describe how to use each of the functions available and how they are commonly used in programs. Further chapters introduce you to the system hardware, the DOS 3.3 disk operating system, the display features, and various computer applications. Other chapters describe

WICAT 68000 computers with integral™ database

Concurrent's integral™ database boasts features usually found only on "mainframes".

- quick design through graphic techniques
- structures that model real world complexities (see example at right)
- large capacity and expandability
- rapid access of all related records
- automatically maintained structure
- efficient use of disk space
- easy to learn and use

MenuSystem™

MenuSystem's screen definition capability provides the environment to build "user friendly" systems easily. Screens are "painted" on the terminal and are ready to use with no programming.

Application systems are developed quickly using Concurrent's software on the powerful WICAT computers. For more information, please write or call (513) 281-1270

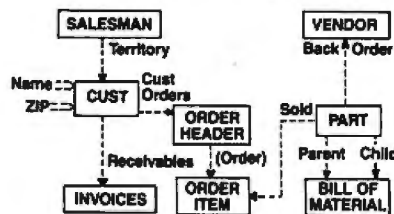

integral™ database and MenuSystem \$2,000

- (substantial discount when ordered with computer)
- (integral™ and MenuSystem are trademarks of Concurrent Corporation)

WICAT System 150

- Motorola 68000, 256K memory, 10MB Winchester
- 760KB floppy, terminal, system software, language

Single user \$9,450
 Three users \$10,850
 Six users (512K) \$12,850



Concurrent™ Corporation
 1870 Madison Road Cincinnati, Ohio 45206

HIGH TECHNOLOGY MICROCOMPUTERS FOR SCIENCE AND INDUSTRY

THE NEW DAS SERIES 500 FOR THE IBM PC:

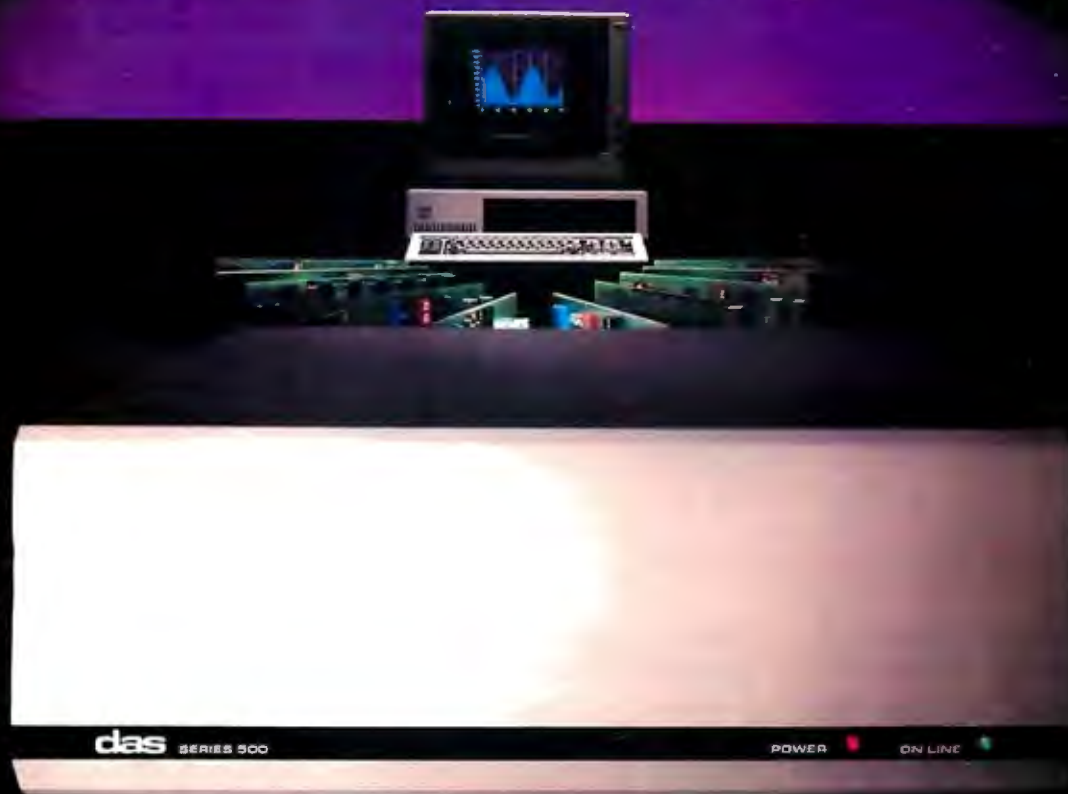

THE DATA ACQUISITION & CONTROL SYSTEM YOU SHOULD CONSIDER OVER A MINI. EVEN IF MONEY IS NO OBJECT.

Let's say you have enough money to buy nearly any data acquisition and control system you might want. What will you choose?

If sheer power is your main requirement, you might choose an expensive minicomputer system. But, then again, you might just as well choose the new DAS Series 500.

Simply plug the Series 500 into any off-the-shelf IBM Personal Computer and you'll have up to 336 channels of analog input, 60 channels of analog output and 192 channels of digital I/O (even AC/DC device control). And with measurement speeds as high as 25,000 analog data points per second, and true 12 or 14 bit precision, you'll have enough power and accuracy for the most demanding applications.

If you need flexibility, you'll want to compare other, more costly systems to the fully modular Series 500. It comes supported by an extensive library of integrated plug-in modules that let you custom tailor almost any

combination of inputs and outputs, digital or analog. And do so almost instantly.

So the Series 500 is ideal for hundreds of applications in product test, process control and energy management; in psychology, biology, analytical chemistry and neuroscience.

If ease of use is high on your list, consider this: Only the Series 500 comes equipped with the advanced, integrated Soft500 software package. With it, you can set up, collect, store, control, display and analyze, all with a few simple BASIC commands.

In fact, Soft500 makes programming so easy, you can be up and running with your Series 500 the same day you get it. Even if you're not a computer expert.

Now compare advanced features. Like exclusive foreground/background software architecture that lets you analyze data while you collect it. Like the real-time clock/calendar and precision interval timer.

Or the tremendous range of signal conditioning options, including software selected gain and offset, amplification from millivolt levels, and provision for direct connection of thermocouples, strain gauges and RTDs.

These are features you might not get elsewhere, no matter how much money you spend. But then, why spend all that money?

Because for less than \$6000 you get both the advanced capabilities of the DAS Series 500, plus an IBM PC[®] (which incidentally, you can still use to do all the other things a PC does so well).

For complete information on the DAS Series 500 data acquisition and control system, write to us at Data Acquisition Systems, Inc., 349 Congress Street, Boston, Massachusetts 02210. Or call us at 617 423 7691.

das

IBM PC[®] purchased separately. All other labels for the Apple II, IBM PC[®] & Apple II are registered trademarks.



Photo 9: A look at the Apple IIe Owner's Manual. The manuals provided with the Apple IIe set new standards of quality by being comprehensive, very friendly, and by containing numerous color photos to illustrate the text.

the various computer languages, how to add components to your system, and what to do when you have problems.

This is clearly the first manual a new owner should read, and is also the only manual that is included with the Apple IIe. The new owner picks up the only manual in the box and it tells exactly what to do to get the system up and running. To avoid confusion, all other manuals are optional, and many manuals included with products are available separately. (The *Apple IIe Owner's Manual* is shown in photo 9.)

The *Apple IIe Reference Manual* is an optional manual worth noting. It provides a complete technical description of the machine, and its operation, in detail sufficient to satisfy almost anyone. It provides descriptions of the hardware and special features, instructions for using the monitor, timing diagrams and pin-outs of the custom ICs and ROMs, and a complete set of schematics. No self-respecting programmer or experimenter should be without this manual. Apple also provides other manuals, including rewritten Apple-soft and DOS manuals and reference

manuals for the Apple IIe and the 80-column boards; see the "At a Glance" text box on page 70.

Conclusions

As you can probably tell, I was impressed with the Apple IIe. The people at Apple Computer had their act together when they designed this machine and it really shows.

I am disappointed that the 80-column cards are not as inexpensive as they were rumored to be; other vendors will probably design less expensive ones. However, with the new keyboard and 80-column display, the Apple IIe can handle just about any task.

The manuals with the system are superb. They are friendly, easy to read, and comprehensive, setting a new standard for the industry to meet.

Applewriter IIe and Quickfile IIe are well-written, useful programs that will find favor with people who wish to use their Apple IIe for word processing and information filing. With these two programs and a spreadsheet (like Visicalc), you could satisfy virtually all your computing needs.

I was most impressed with the balance struck between compatibility and new features, and the obvious care that went into the design. Congratulations, Apple Computer, you've produced another winner. ■

WE GAVE YOUR DRIVES THE FIRST BREAK THEY EVER HAD...



Our DCU is the original Drive Control Unit that turns floppy drives off during periods of inactivity by using a state of the art optoisolator with zero crossover control and built in activity monitor.

We've continued to improve the design (it's the size of a business card to fit within the drive), ease installation time (about 15 minutes) and models are now available for virtually all popular 8 inch drives (including a foreign version). So for those of you, who are still grinding down your drives, wearing out media and exposing yourself to unnecessary noise... isn't it time to give them a break?

Assembled and tested \$49.95
 Kit with Documentation \$29.95
 Type of drive MUST be stated with order.
 NY residents add local tax. Include \$1.50
 for postage and handling.

OPTRONICS TECHNOLOGY
 P.O. Box 81, Pittsford, N.Y. 14534, (716) 377-0369

15 new problem-solving Microboard products.

Now, RCA offers more than 85 "real world" solutions.

The broadest line of CMOS Microboard products in the industry continues to expand. This means more capability for you.

For example, our Microboard Floppy Disk Controller enables you to interface with up to four industry standard 8-inch, 5¼-inch mini, or 3½-inch micro floppy disks. You can program the track stepping rate, head load time and head unload time.

This controller is especially effective with our new Micro Floppy Disk Drive

Module, which contains two 3½-inch disks—each capable of holding 322K bytes of formatted data. And the module mounts directly into our industrial chassis.

We're also introducing four new Microboard power supplies to increase your design options in the U.S. and Europe.

And, if data communications is important to you, our Bell compatible MODEMs are joined by two new CCITT compatible Auto MODEM Microboards for Europe-to-Europe communications.

We've even improved internal system communications for software development with our powerful new MicroDOS Disk Operating System and Monitor Program on ROM.

And, we've added four new high-speed static CMOS memory boards and an interface board. Our 32K/64K-byte RAM/ROM, 8K-byte RAM, 16K-byte RAM and 32K-byte RAM boards are attractively priced. The Optically Isolated DC Interface board features 8 input and 8 output parallel I/O lines.

Now it makes more sense than ever to choose RCA CMOS Microboards: the proven, economical, real world problem solvers.

To find out the full story behind these new products and the more than 70 other members of our Microboard family, contact any RCA Solid State sales office, representative or appointed distributor.

Or call (800) 526-3862.

All prices shown are 100* optional distributor resale in U.S., except those marked * which are single unit prices. RCA Solid State headquarters: Somerville, NJ. Brussels, Paris, London, Sao Paulo, Hong Kong. Circle 367 on inquiry card.

1. 3½," 5¼," 8" Floppy Disk Controller
CDP18S651—\$280.
2. 3½" Dual MicroDisk Drive Module
MSIM50—\$790.
3. MicroDisk Operating Software (MicroDOS)
CDP18S845—\$300.*
4. ROM Monitor Program
CDP18SUT70—\$49.*
5. Optically Isolated DC Interface
CDP18S663—\$197.

6. CCITT Direct-Connect Auto MODEM-300 baud
CDP18S653V3—\$315.
7. CCITT Direct-Connect Auto MODEM-1200 baud
CDP18S653V4—\$354.

8. RAM/ROM/EPROM Memory Board Any mix to 64K
CDP18S628—\$189.
9. 8K CMOS RAM Memory Board with RAM/ROM expansion to 48K
CDP18S630—\$237.
10. 16K CMOS RAM Memory Board with RAM/ROM expansion to 48K
CDP18S631—\$284.

11. 32K CMOS RAM Memory Board
CDP18S632—\$339.
12. Power Supply-Switching 115V Module
MSIM40—\$394.
13. Power Supply-Switching 230V Module
MSIM40E—\$394.
14. Power Supply-Linear 115V Module
MSIM41—\$157.
15. Power Supply-Linear 230V Module
MSIM41E—\$157.



Call toll-free (800)526-3862

RCA

Now our \$29.95 complete Pascal for CP/M is an even better bargain:

announcing new JRT Pascal 3.0...

WHAT THEY SAID ABOUT JRT PASCAL 2.0:

CREATIVE COMPUTING, Nov. '82 "...While 'there is no such thing as a free lunch,' JRT Pascal at \$29.95 (which includes postage) certainly allows the user to experience champagne and caviar at cafeteria prices..."

INTERFACE AGE, Oct. '82 "...JRT Pascal is following the example set by Software Toolworks (Sherman Oaks, CA) of offering quality software at extremely low price..."

INFOWORLD, Aug. 16, '82 The magazine's 'Software Report Card' rated JRT's documentation 'good' and performance, ease of use and error handling 'excellent' + the highest rating.

AND NOW: JRT PASCAL 3.0—

with all the features that earned 2.0 so much praise—PLUS the many new features shown here. The price?—still just \$29.95! This astonishing price includes the complete JRT Pascal system on diskettes and the new expanded user manual. Not a subset, it's a complete Pascal for CP/M.*

Modern computer languages recognize the advantages of dividing programs into easy-to-use functional modules. JRT's *external procedure modules* give you flexibility to run programs of almost unlimited sizes. Because the procedures are separately compiled, if one part of a program changes only that part needs recompiling. And libraries of external procedures can be built-up containing code and data common to many main programs; the time and duplication savings are obvious.

Faster and more reliable than ever, for beginner or expert, engineer or businessman, JRT Pascal 3.0 provides a set of features unequaled by any other Pascal... or any other language.

OUR NO-RISK OFFER:

When you receive JRT Pascal 3.0, look it over, check it out, compare it with similar systems costing ten times as much. If you're not completely satisfied, return it—with the sealed diskettes unopened—within 30 days and your money will be refunded in full. That's right: *satisfaction guaranteed or your money back!*

A JRT bonus: if you want to copy the diskettes or manual—so long as it's not for resale—that's o.k. with us. Pass it on to your friends. But don't delay. Send the coupon or phone today and start enjoying the Pascal advantage; at \$29.95, there's no reason to wait!

- NEW** Full support for indexed files
- NEW** CRT screen formatting and full cursor control
- NEW** Facilities for formatting printed reports

NEW
175-page user manual with protective 3-ring binder and 5-1/4" or 8" diskettes

NEW Handy JRT Pascal reference card

NEW File variables and GET/PUT

NEW Dynamic arrays

NEW SEARCH procedure for fast table look-up

Extended CASE statement

Graphing procedures

Statistic procedures

14 digit BCD FLOATING POINT arithmetic

Fast one-step compiler; no link needed

More than 200 verbal error messages

True dynamic storage

Efficient compiler needs only 85K diskette space

Separate compilation of auto-loading external procedures

Advanced assembly interface

Maximum program size: more than 200,000 lines

No limits on procedure size, nesting or recursion

TO JRT CUSTOMERS: THANK YOU.

Your response to very low-priced/high-quality JRT Software has been overwhelming. Since last summer we've added almost 25,000 new JRT owners; because we allow them to make copies for friends, the total number of new users must be enormous! And just as rewarding for us are the many positive comments JRT gets from pleased customers and the media. Pascal 3.0 is an example of new improvements and products we have in work. It's also another example of our standing policy: best software quality and best price. So to customers past and future, enjoy and thank you.



JAMES R. TYSON
Owner JRT Systems



Random files to 8 megabytes with variable length records

64K dynamic strings

Activity analyzer prints program use histogram

...new, improved, but...

...still only \$29.95!

JRT PASCAL 3.0

Send to **JRT SYSTEMS** or phone **415/566-5100**
550 Irving Street/A1
San Francisco, CA 94122

Here's my \$29.95; please send me JRT Pascal. I understand that if I'm not completely satisfied, I can return it within 30 days—with the sealed diskettes unopened—for a full refund. (Allow 2-3 weeks for shipping.)

I need the 5-1/4" diskettes for Apple CP/M; Heath, Hard Sector; Heath, Soft Sector; Northstar; Osborne; Superbrain; Televideo; Xerox 820. I need 8" SSSD diskettes.

Name _____

Address _____

City _____ State _____ Zip _____

Check C.O.D. MasterCard VISA
(CA residents add sales tax. Add \$6 for shipping outside North America.)

Card # _____ Exp. _____

Signature _____

*CP/M is a Digital Research TM. A 56K CP/M system is required.

An Interview with Wayne Rosing, Bruce Daniels, and Larry Tesler

A behind-the-scenes look at the development of Apple's Lisa.

Chris Morgan
Gregg Williams, Senior Editor
Phil Lemmons, West Coast Editor

Of the more than 90 members of the Apple engineering staff who participated in the Lisa project, Wayne Rosing, Bruce Daniels, and Larry Tesler are three of those who were most responsible for its final form. Rosing, formerly of the Digital Equipment Company, oversaw hardware development until Lisa went into pilot manufacture and then assumed responsibility for technical management of the entire Lisa project. Daniels and Tesler were responsible for Lisa's systems software and applications software, respectively. Chris Morgan, senior editor Gregg Williams, and West Coast editor Phil Lemmons interviewed the three at Apple's headquarters in Cupertino, California, last October.

BYTE: Tell us how you staffed the Lisa project.

Tesler: In software, we drew mostly experienced people from other companies and very few people straight out of school. Even the ones we took

out of school generally had lots of job experience. In fact, one time I surveyed the applications group and found an average of nine years' work experience in software. When we looked at résumés, we tried to find people with several years of experience in development. We made exceptions if someone had specialized in something we were interested in or was a top student who also had good summer experience. We wanted an experienced team because what we've been doing is a very major software effort. It's very complex, and there's such a large body of software to crank out and make reliable that it takes experienced people.

BYTE: When did you do the hiring?

Tesler: The project went through phases. There was some design and some implementation when the project first started two and a half years ago, but we hired most of our software people about two years ago. In three months, we hired most of the software staff, and then they spent several months learning about the

machine and designing their particular parts of the software. The bulk of the programming started about a year and a half ago.

We had to spend quite a long time just building a team—people who had a common view and could work together. We drew people from different companies with completely different backgrounds and tried to do something that nobody in this group had ever done. Some of us had done parts of it before. We were developing everything in parallel: the hardware, the operating system, the applications, the manuals, the details of the user interface. We did have a sort of fundamental philosophy, but having to do everything at once means you're never sure when you're going to get what you need from the person who does whatever you need next.

Daniels: I think communication is the key there. If you have that many things going in parallel, you spend a lot of time communicating so each of you knows what the other's doing and can depend on each other.

Who says Payroll is simple?



We do.

There is simply no other Payroll Accounting system this complete available for microcomputers. The BPI Payroll System performs all the standard payroll functions. It contains tax tables for FICA, federal and all 50 states plus Puerto Rico and the District of Columbia, as well as cities and counties with uniform methods of taxation. And our Update Service keeps your Payroll System current with all tax law changes affecting you.

Companies with as few as four or as many as several hundred employees in different states or branch offices can simplify their payroll accounting dramatically with the BPI Payroll System. It provides for expense reimbursement, automatic calculation of net pay, and wage distribution. It also produces W-2's, payroll checks and other important payroll reports.

With the BPI Payroll System, employees may be paid weekly, biweekly, semimonthly

or monthly by three methods: salary, hourly with up to three different hourly rates, and commission. The system also provides for income from tips.

Deductions from FICA, federal and state taxes are built in, and you can easily set up as many as six other deductions for your employees.

All BPI Systems software is designed to match the growth of your company:

- General Ledger
- Accounts Receivable
- Accounts Payable
- Inventory Control
- Job Cost
- Time Accounting

The Payroll System interfaces with the General Ledger and Job Cost Systems as well.

Payroll Accounting is simple if your software is powerful enough. Ask for a demonstration by your computer dealer or write us for more information. You'll see how simple Payroll Accounting can be.



BPI

SYSTEMS™

SIMPLY, THE MOST POWERFUL SOFTWARE IN BUSINESS.

3423GUADALUPE / AUSTIN, TX 78705 / 512-454-2801
BPI and BPI Systems are trademarks of BPI Systems Inc.

STATISTICS SO EASY, IT'S LIKE MAGIC.

S P E E D *Stat*

professional statistical
analysis system for
Apple® computers

At last, there's a sophisticated statistics package that's easy to learn and simple to use: speedSTAT 1.

With extensive statistical analysis capabilities—including a capacity of over 10,000 data points and more than 30 different statistical measures—speedSTAT 1 is the next major tool in your software collection. It multiplies your capabilities... with some pretty magical results.

If you've relied on large computers for your statistical needs in the past, you'll appreci-

ate the convenience and affordability of speedSTAT 1. And even if you don't have much experience with computers or statistics, speedSTAT 1 will make your computer do the work, so you're free to think about the results.

Of course speedSTAT has a lot more up its sleeve. You can learn the details at your Apple dealer. Or call Toll Free 800/543-1350 (in Ohio call collect: 513/891-5044) and we'll send you more information.

SpeedSTAT is a trademark of SoftCorp International, Inc.
Apple is a registered trademark of Apple Computer, Inc.

SoftCorp
INTERNATIONAL

229 Huber Village Boulevard
Westerville, Ohio 43081

Circle 385 on Inquiry card.

BYTE Interview

Tesler: It took a while to work out those channels. It was rough at the beginning, but it's pretty easy now. Our progress was gradual. I think I'd call it team-building. Some of the things were hard to do in an organization that's thrown together like this. But once you've got a team built, it's a valuable asset. Of course, we were doing technical work all along, but in a sense we spent a year building the team and a year building the product. Now when we build something else, we can do it without the team-building step.

BYTE: What about project security?
Rosing: We tried to be as secure as we could without creating a discouraging atmosphere for people to work in. Within the group there has always been total information transfer, and we've kept lots of machines available.

People have been able to take machines home with them. There was always the risk of losing a Lisa in a burglary, but we had a rule that the floppy disk had to be kept separate from the machine. We felt it was worth risking a theft to gain the increased productivity of people working at home. We've been very fortunate; we haven't lost one machine.
BYTE: How did you schedule the project?

Tesler: People made estimates, but it was difficult. All the estimates were conditional—"If the hardware is here by a certain date and the operating system is frozen and I have the user-interface definition and I can get some assistance from people who have the right sort of experience, then I can do it in this many months." But none of the ifs were ever really possible. People were really hesitant to make a firm date because there were so many contingencies. We did come up with schedules all the time, but they were myths.

Daniels: Getting Lisa to market has been a dream, a goal that we all have. Although we're willing to make compromises to get Lisa out expeditiously, the dream of what we're trying to achieve is the major thing.

Rosing: We had this dream of what we wanted to do, and I think over



Excellence Acknowledged.



Some people demand the best.

Superior quality at superior value is the key to those few items that rise above the crowd to shine as unique symbols of perfection. We call these the "best" products, and the best in Apple II®-compatible drives is the Micro-Sci line of 5 1/4" floppy disk drives and subsystems.

Business, commercial and professional people needing more storage, greater reliability and faster access than previously available have been impressed with Micro-Sci's A40 system since we introduced it back in 1979. For a lower list price than the Apple Disk II®'s, the A40 offers 20Kb more capacity, faster access time and greater data reliability.

The ideal solution to the Pascal™ and CP/M† user's problem of space limitation is a Micro-Sci A70 drive, combining quick access and high reliability with a full 286Kb storage capability.

The newest member of Micro-Sci's Apple II-compatible family is the A2, the perfect alternative drive for entertainment and other

packaged software. A direct replacement for the Disk II, our A2 features total compatibility at a lower cost total. And you can mix, or match, our A2 drive and controller with their drive and controller and vice versa. You have complete freedom of interchangeability.

Micro-Sci even goes one step further with its controllers to include operating features the competition lacks, like jumper-selectable 3.2 and 3.3 DOS.

Give yourself the privilege.

You deserve more for your money, and Micro-Sci delivers the most in quality, reliability and performance.

So when you consider additional drives or a disk subsystem for your Apple II, indulge yourself in the Micro-Sci alternative.

See our complete product line today at a dealer near you.

*(SPECIAL NOTE TO APPLE III® USERS:
Micro-Sci also offers a full range of Apple III-compatible drives. Ask your local dealer for details.)*

μ-SCI

MICRO-SCI

Micro-Sci is a Division of Standun Controls, Inc.

2158 SOUTH HATHAWAY STREET • SANTA ANA, CALIFORNIA 92705 • 714/662-2801 • TELEX: 910-346-6739
International Dealer Inquiries... IMC International Markets Corp. Telephone: 714/730-0963 • Telex: 277782-ROBY UR

* Apple, Apple II, Apple III and Disk II are registered trademarks of Apple Computer, Inc.
† Pascal is a registered trademark of the Regents of the University of California.
‡ CP/M is a registered trademark of Digital Research, Inc.

time we recognized that we couldn't achieve some of the goals. We'll have to take care of them later. We've taken the attitude that Lisa is going to be good and we're not going to sacrifice the integrity of the product for scheduling. We wanted to make a very balanced set of decisions, and so everything, as I say, just started to come together. The floppy disk works well, the mouse works well, the hardware works well, the software is beginning to come, and now we're cranking to get this first release out. But we won't let it be compromised because of scheduling.

Daniels: Part of the difficulty was that both the user interface and the internals—the architecture—of the software are revolutionary. Getting that architecture designed and built was a big scheduling problem. Once we'd done that, we'd built the foundation. Now building the applications is much smoother and has been much easier for us to predict.

Tesler: We didn't know if some of the things we started would work at all, like the way the dot-matrix printer is used and even the way the letter-quality printer is used to print the graphics.

Daniels: No one had ever done that before.

Tesler: Theoretically, it ought to be possible, but it had never been done, and the manufacturer of the printer didn't believe it could be done. It had to be possible in order for this product to do what we wanted, but no one could predict how long it was going to take. When we hired the printer people we told them to do it in two months. It took them a year and a half, but they did it. And then the high-density disk drives are new technology to Apple. A lot of the concepts in there had never been tried before. That was one of the biggest risks. And Apple not only built disk drives for the first time but built *revolutionary* disk drives.

BYTE: What makes them revolutionary?

Rosing: One of the major things we did was to vary the speed of the disk as you change the track position, so the drives keep constant area density, and that gives them a greater capacity. Second, we used microstepping algorithms on the stepper motor so that if a head gets off track because of changes in humidity and temperature, the intelligent controller can hunt and find the track. So we have much better interchangeability, with much higher density, and we're getting approximately 50 to 60 percent more data on that disk by good systems engineering. Some of the competitive units have a greater capacity, but we think the error rate ultimately suffers. We wouldn't tolerate a serious error-rate problem.

BYTE: How does the error rate compare with double-sided double-density disks?

Rosing: As for hard-error rates, we're talking about 10^{-12} , and that occurs after so many bits that it's hard to measure. But we're quite delighted that the measurements are impossible to take. Basically that means the errors are low.

BYTE: Did you work more than 40-hour weeks?

Tesler: Each engineer set his or her own schedule. Some engineers work something like Monday through Friday from nine to five. Others work all day at the office, then go home and work all night there. And what an individual engineer does may vary from time to time.

Daniels: These people have pride. They set their own milestones and they want to meet them, so they'll put in extra work to do that.

Tesler: We decided a long time ago that since the project would obviously go on for more than a few months—a couple of years—we couldn't have this constant pressure on everybody, because people would just crack.

BYTE: As individual designers, do you feel that your signature is on that machine?

Tesler: I think that's true of everybody in the group. Even people



C COMPILERS—COMMON FEATURES:

- UNIX VER 7 compatibility • standard float, double, and long support • run time library with full I/O and source • fast compilation and execution • full language.

AZTEC C II CP/M (MP/M) \$199

- produces relocatable 8080 source code • assembler and linker supplied • optional M80 interface • SID/ZSID debugger interface • library utility • APPLE requires Z80 and 16K card

AZTEC C I [APPLE DOS] \$199

- relocating assembler supplied • APPLE SHELL • VED editor • library and other utilities • requires 16K card

C86 IBM PC MSDOS CP/M-86 \$249

- directly produces 8088/8086 object code • linker supplied

Manuals—\$30 ORDER BY PHONE OR BY MAIL—Specify products and disk format

MANX[®]
software systems

Box 55, Shrewsbury, N.J. 07701 (201) 780-4004



CP/M FORMATS: B* STD. HEALTH, APPLE, OSBORNE, NORTHSTAR, OUTSIDE USA—Add \$10 In N.J. add 5% sales tax

All hands on deck

for a swashbuckling adventure with the legendary warship - **Old Ironsides!**

A NEW experience in arcade-quality graphics in a two-player game for the whole family!

Your arch enemy is armed to the teeth with deadly firepower. A shoot-out could blow you to smithereens.

You're ready for the onslaught! Your warship is perfect—masts, compasses, cannons, broadsides and powder magazines. Your strategy is flawless!

But you've got more than your opponent to contend with! Hiding in the fog by drifting off the screen can snarl even the best tactics!

This is a test of skill and daring unmatched in any other micro-computer game! Your every move is critical. One false step and... KABOOM!

Use keyboard or paddles to play this spellbinding game. Plus... the special Freeze Frame feature stops and starts the action at any point. It's perfect for everyone—the controls are simple, but the strategy and tactics at your fingertips are truly awesome! By Richard Hefter and Jack Rice.



What you see is what you get!

Unlike other programs, where the pictures on the packaging and in the advertising bear no resemblance to the screen images, this program delivers precisely what's promised...

- Better than arcade-quality graphics and sound!
- Bright, interest-grabbing packaging!
- FREE full-color 14½" x 20" Old Ironsides poster
- FREE 32-page Log Book with space to record wins and losses, secret strategies and tactics

Look for **OLD IRONSIDES™** in finer computer stores everywhere. Dealers are invited to inquire by calling toll-free 1-800-852-5000.

If there is no store near you, Visa and MasterCard holders may order by calling toll-free 1-800-852-5000. Or, send a check or money order for \$39.95 for each program, plus \$2.00 for shipping and handling (where applicable, please add state sales tax) to Xerox Education Publications/Weekly Reader, Dept. 16A, 245 Long Hill Road, Middletown, CT 06457.

Apple II and Apple II Plus 48K3.3 DOS



NEW from Optimum Resource, Inc. for the Apple!

Old Ironsides™ is a registered trademark of Optimum Resource, Inc.
Apple and Apple II are registered trademarks of Apple Computer, Inc.
AF/MS2-B



Distributed by

Xerox Education Publications
Weekly Reader
Computer Software Division

Let's get

try out the in-stock selection of Heath/Zenith microcomputers, peripherals, accessories and software.

Now available at your nearby Heathkit Electronic Center, or through the Heathkit mail order catalog.

You get more with a Heath/Zenith personal microcomputer system! We offer:



- Microcomputer
- Quick-to-use, can depend on with a name you can trust
- A powerful system at an affordable price
- An abundance of business programs to assist your needs
- Backed by a nationwide on-site service network

- Free
- Personal secretary
- Self taught in only hours to use
- Innovative office with time and cost
- Provides your professional

personal...

- 1. Proven, high-performance hardware:** Thousands of our microcomputers are proving themselves daily, in the field.
- 2. Vast software library:** Three operating systems (including CP/M), languages, word processors, an electronic spreadsheet, versatile utilities and the 500-program Heath Users' Group software library.
- 3. Self-instruction courses:** Evaluation and programming courses from Heathkit/Zenith Educational Systems.
- 4. Service support:** Before and after the sale — consultation by phone, carry-in service.

Test run one of our microcomputers at any of the more than 60 convenient Heathkit Electronic Centers in the U.S.

Heathkit[®] ELECTRONIC CENTERS*

See the white pages of your telephone book for store locations and telephone numbers.



*Units of Veritechnology Electronics Corporation in the U.S.

Or if you prefer, send to the address below for a **FREE catalog:**

Heath Company
Dept. 334-984
Benton Harbor, MI 49022

In Canada: Heath Company
1480 Dundas St. E.
Mississauga, ONT L4X 2R7

Please send my free catalog, describing your complete line of microcomputer products!

Name _____

Address _____

City _____ State _____

CP-214 _____ Zip _____

Circle 195 on Inquiry card.

Make the Qume Connection.™

The Qume SPRINT 11 PLUS™ is the new standard of quality for professional, letter-perfect daisywheel printing. And for just \$1776, you can have it for your personal or desktop computer. It comes complete with a Qume Connection interface module to fit popular computers from IBM, Radio Shack, Commodore, Xerox, Hewlett Packard, North Star and many others. Its 96-character daisywheel delivers letter-quality text at a steady 40 cps. And

with an average of 5,500 trouble-free hours (3 years typical use) between maintenance, the SPRINT 11 PLUS is unmatched in reliability. Qume quality is the choice of sophisticated, professional users. At \$1776, there's no reason for you to settle for anything less. Make the Qume Connection by calling one of our authorized distributors. Or write Qume, 2350 Qume Drive, San Jose, California 95131.

Our new
SPRINT 11 PLUS™
fits every computer.
\$1776.

Qume
A Subsidiary of ITT



It's easy to make the Qume Connection.

Call the distributor nearest you to get the best quality printer for your microcomputer.

Abacus Data Services
(416) 677-9555 Ontario, Canada

Anacomp/ESCOMP Division

(213) 516-7480 CA
(206) 641-4990 WA
(509) 624-1308 WA

Anthem Systems Corporation
(415) 342-9182 CA

Audio Visual Services

(713) 659-1111 TX
(800) 392-7777 TX Only

Bohlig and Associates

(612) 922-7011 MN

Butler Associates

(617) 964-5270 MA

Byte Industries

(800) 972-5948 CA Only
(800) 227-2070 Outside CA

C&G Distributors, Inc.

(813) 435-4340 OH
(800) 245-1084 Outside OH
(412) 366-5056 PA
(800) 245-1084 Outside PA

David Jamison Carlyle Corp.

(213) 277-4562 CA
(415) 254-9550 CA
(714) 640-0355 CA
(808) 531-5136 HI
(312) 975-1500 IL
(201) 946-8669 NJ
(214) 458-0888 TX
(713) 530-4980 TX

The Computer Factory

(212) 687-5000 NY
(914) 793-1300 NY
(212) 696-0700 NY
(516) 248-6700 NY

Computing Resources, Inc.

(702) 825-8800 NV

Computer Mart of New Jersey

(201) 283-0600 NJ

Datamex Ltd.

(514) 481-1116 Montreal, Canada

(613) 224-1391 Ottawa
(416) 887-1208 Toronto
(604) 684-8625 Vancouver

Data Systems Marketing

(602) 833-0061 AZ
(714) 540-2312 CA
(213) 1641-2050 CA
(415) 941-0240 CA
(916) 891-8358 CA
(213) 796-2562 CA
(213) 796-2631 CA
(714) 560-9222 CA
(213) 344-7097 CA
(209) 237-8577 CA
(303) 573-5133 CO
(303) 694-1710 CO
(313) 254-2830 MI
(406) 587-1200 MT
(505) 294-1531 NM
(503) 297-8444 OR
(412) 486-2676 PA
(214) 950-1604 TX
(713) 789-0803 TX
(801) 292-6666 UT
(206) 575-8123 WA

Data Technology Industries

(415) 638-1206 CA

Data Terminal Mart

(403) 270-3737 Alberta
(403) 420-1755 Alberta
(514) 288-1555 Montreal
(902) 469-3782 Nova Scotia
(416) 677-0184 Ontario
(416) 495-2001 Ontario
(416) 245-4760 Ontario
(613) 729-5196 Ontario
(604) 872-8482 Vancouver

Equipment Resources

(404) 955-0313 GA

General Electric

(205) 479-6547 AL
(602) 278-8515 AZ
(415) 436-9265 CA
(714) 231-0309 CA
(203) 628-9638 CT
(904) 751-0615 FL
(305) 921-0169 FL
(404) 452-4819 GA
(319) 285-7501 IA
(219) 933-4500 IN
(317) 241-9330 IN
(812) 473-6161 IN
(502) 452-3311 KY
(617) 938-1920 MA
(301) 332-4710 MD
(612) 522-4396 MN

(816) 231-6362 MO
(314) 965-7115 MO
(704) 525-3011 NC
(201) 227-7900 NJ
(518) 385-4888 NY
(716) 876-1200 NY
(513) 874-8512 OH
(503) 221-5095 OR
(901) 527-3709 TN
(214) 243-1106 TX
(713) 672-3575 TX
(801) 973-2253 UT

Gentry and Associates

(305) 859-7450 FL

InterACT Computer Systems

(305) 331-7117 FL
(404) 953-8213 GA
(704) 552-7502 NC
(704) 254-1949 NC

MicroAmerica

(213) 327-6030 CA
(800) 262-4212 CA Only
(800) 421-1485 Outside CA
(617) 449-5807 MA
(800) 343-4431 Outside MA
(617) 431-7660 MA
(214) 235-3616 TX
(800) 442-5847 TX Only
(800) 527-3261 Outside TX

National Computer Syndicate

(312) 459-6400 IL

Office Systems, Inc.

(704) 374-0822 NC
(919) 274-8423 NC
(919) 549-0545 NC

PAR Associates

(303) 371-4140 CO
(801) 292-8145 UT

Pioneer Electronics

(205) 837-9300 AL
(305) 859-3600 FL
(305) 371-4311 FL
(404) 448-1711 GA
(301) 948-0710 MD
(919) 273-4441 NC
(215) 674-4000 PA

Pioneer Standard Electronics

(312) 437-9680 IL
(317) 649-7300 IN
(313) 625-1800 MI
(612) 935-5444 MN
(216) 587-3600 OH
(513) 236-9900 OH
(412) 782-2300 PA
(512) 835-4000 TX
(214) 386-7300 TX
(713) 988-5555 TX

Schweber

(205) 882-2200 AL
(408) 496-0200 CA
(213) 537-4321 CA
(916) 929-9732 CA
(213) 999-4702 CA
(203) 792-3500 CT
(305) 927-0511 FL
(305) 331-7555 FL
(404) 449-9170 GA
(319) 373-1417 IA
(312) 364-3750 IL
(617) 275-1500 MA
(301) 840-5900 MD
(313) 525-8100 MI
(612) 941-5280 MN
(201) 227-7880 NJ
(516) 334-7474 NY
(716) 424-2222 NY
(216) 464-2970 OH
(513) 439-1800 OH
(918) 622-8000 OK
(215) 441-0600 PA
(412) 782-1600 PA
(713) 784-3600 TX
(214) 661-5010 TX
(512) 458-8253 TX
(414) 784-9020 WI

Tek Aids Industries Inc.

(312) 870-7400 IL
(512) 835-9518 TX

Terminal Rentals

(602) 258-4466 AZ
(714) 832-2414 CA
(408) 292-9915 CA
(213) 637-3413 CA
(714) 235-9268 CA
(415) 956-4821 CA

Terminals Unlimited

(800) 336-0423

Unico

(512) 451-0251 TX

Victor Electronics

(617) 481-4010 MA

Western New York Computer

(716) 381-4120 NY

BYTE Interview

who have been with us for only a few months have something in the Lisa that they can look at and say, "That was my idea; that's my code." It's really a group effort. Even marketing got involved in the design effort in various ways, particularly in user-interface issues, product design, packaging, and the style of the manuals. The whole division really got involved.

BYTE: When did you decide to incorporate all the fundamental applications into the system software?

Daniels: At the very beginning. Some applications weren't decided until later, but the integration, the way it all fit together, was a goal from the very beginning.

Rosing: As a matter of fact, we cut out a few more things because we just didn't feel we could manage a project that large. Then we added a couple things back in as we became more comfortable with the development cycle. But we've basically been operating on the same goal for the past two years, with very little change of direction.

BYTE: What was the sequence in the early days? Did you decide what the project had to look like to the end user, and then what software was required, and then. . .

Daniels: Then hardware. In fact, we spent the first six months hammering out the user-interface docket. We had that completely specified before we really started the applications. I think the key to success here is to know where you're going before you start.

Tesler: The hardware, the operating system, and the applications were all developed somewhat in parallel, but there was a definite cause and effect.

The people who designed the hardware had to make decisions, for example, about whether the disk drive should have a door that you flip open or a button to push, that kind of thing. The designers focused on that aspect of the user interface even before the rest of the user interface. They didn't want the user to be able to accidentally pull out a disk when it was being written on or something. So some decisions were made even

before the hardware was designed. There have also been hardware revisions. The first Lisa hardware was here when I came, over two years ago. It's gone through several. . . how many revisions since then?

Rosing: About four. Each one's been an iteration. We discovered a few things in the early hardware that wouldn't work well. We just took them out because we couldn't do them properly. The rest has mostly been a matter of fine-tuning Lisa so that it's very manufacturable and very reliable.

Tesler: Each time they go through a cycle, the people working on user interface get another crack at it — "Since you're going to revise the hardware anyway, why don't you. . . ?" Or the people doing the operating system say, "The memory-management unit needs to be more general, and since you're redesigning the hardware anyway. . ." So we were able to get in some hardware revisions. Also, that keyboard you saw yesterday is not the final one. After user testing, and because of needing to support the European market, we determined that we really needed a couple more keys on the keyboard, so we made a major change in the keyboard layout.

Rosing: One of the things about this project that's different is that, more than any other I've been associated with, there's a continuous loop for dealing with user issues. We've gone to the software and that has implied a hardware change. We synthesized a lot of different disciplines. The power-off button used to be a traditional button on the back of the machine, but we didn't want to encourage users to turn off their machines that way because if they left a document open, they would lose it.

BYTE: Do you expect to find a little initial resistance to the fact that the machine doesn't actually turn off when you push a button? Do you think people are going to say, "Well, I know I can leave it alone now, but I want to make sure it turns off"?

Rosing: Right. It does feel a little funny at first, but after a few times you

Qume
A Subsidiary of ITT

begin to have confidence that the thing does turn itself off.

BYTE: When you finally got the user-interface specified, did you have a brief description of it that everybody knew by heart?

Daniels: It was about a 35-page document.

BYTE: Thirty-five pages of specifications?

Tesler: We have something called the

User-Interface Standard, and it consisted of those things which would be common to all applications. Also, the year after that document was published some revisions and some changes were made, and as we built applications we found that they had even more in common than we envisioned. Then we would adopt those things as part of the standard.

Daniels: Another thing we've done is

user tests—taking our ideas and bringing in naive users and sitting them down and seeing what their impressions are. That has caused some changes, and I think that's all shown in the quality.

BYTE: Where did you get your naive users?

Tesler: Various places—the bulk of them were new Apple employees. We had a screening process. New Apple employees go through an orientation the first Monday morning they're here. We handed out a questionnaire to the new employees about their previous experience with computers, word processors, video games, and that sort of thing, and then what kind of work they did. Someone in our training department screened all those vitae. I'd go in and say I needed three user test subjects this week who have no word-processing experience but who are secretaries or accounting people to test out our Lisa Calc. She'd go through and pick out some candidates and I'd pick the ones I wanted, based on their experience for whatever test I was trying to run. We had about 50 tests this year in engineering to test out the software.

BYTE: The fact that you responded to the tests speaks well for the end product. The changes in the keyboard, for instance. How recently did you decide to change the keyboard for the final time?

Tesler: There were several changes. Those from the user tests had to do with changing the numeric pad so it had the arrow keys on it so you could move around in the Lisa Calc table. Those tests were run around January [1982], I think.

Rosing: January, and in March we decided to make the change.

Tesler: That was just key-cap legends that had changed. The other change has to do with the number of keys on the keyboard and was primarily for the benefit of international sales, although it did improve the user interface in terms of the positioning of the Enter key and the Extended Character option key, which gives you extended character sets. Those were all done around the same time.

CP/M USERS LOOK OUT:

THE BEST OF BOTH WORLDS INTRODUCING S/S-PASCAL BOTH IN NATIVE CODE AND P-CODE

**S/S-PASCAL VERSION 3.0 (Native Code) AND 3.5 (P-Code)
FOR 8080 - 8085 - Z80 — REQUIRE ONLY 32K OF MEMORY!**

A bilingual compiler! S/S-PASCAL speaks English and French (or Spanish or German or Italian . . .)

COMPILE FAST IN P-CODE
then when your program is ready

EXECUTE FASTER IN NATIVE CODE

Available in the following formats: 8" SD, North Star Osborne, Micropoli's Mod II, Apple CP/M, Superbrain

Write to get the whole story, or better send \$40.00 for Demo Discette and tutorial manual (150 pages)

Demo 1: Compiler without READ statements
Demo 2: Source limited to 50 statements

COMPARE!	Execute (seconds)	Total Size (bytes)	<ul style="list-style-type: none"> • Standard PASCAL features plus • Generates optimized native code • Compiles directly into .com file • External assembler subroutines • Random access files • 14 digit BCD floating point reals • Chaining and overlays • Dynamic strings • Powerful string manipulation • Direct access to memory • Address and size functions • NEW, DISPOSE, MARK, RELEASE • ASSIGN, RENAME, ERASE • and more . . .
S/S-PASCAL (Native Code)	12.5	1300	
PASCAL MT + *	19.0	3043	
PASCAL/Z*	109	3328	
S/S-PASCAL (P-Code)	120	13000	
UCSD PASCAL*	239	8282	
PASCAL/M*	450	21933	

Re: BYTE, September 1981, page 180
A high level language Benchmark
*TRADEMARK

S/S-PASCAL NATIVE CODE & P-CODE	\$ 360.00
S/S-PASCAL NATIVE CODE ONLY	\$ 295.00
S/S-PASCAL DEMO DISCETTE (& MANUAL)	\$ 40.00

(Cdn. \$ in Canada, U.S. \$ outside Canada)

DEALER INQUIRIES WELCOME

**P. O. Box 197
Armdale, N.S.
Canada B3L 4J9**

SCOTIA

SOFTWARE INC.

**(902)
425-3879**

Apple Polishing.



New software for your Apple* III. Only from Quark.

Now you can add three **new** Quark software products to your Apple III.

Advanced programs which offer you the technical sophistication you need. With the simplicity of operation you want. All at intelligent prices.

Case-in-point: Catalyst[™]. With this hard disk program, you'll only have to boot your system once. Which means you may not have to touch another floppy disk all day. And the price, to coin a phrase, is user-friendly. Only \$149.

You'll also be delighted with Discourse[™]. A spooler that saves you a lot of time. Because it lets you use your computer while you're printing other reports. Plus, you can queue up to 14 documents. The price is \$125.

And if you need an automated appointment calendar, the answer is Quark's new Vigil[™]. No matter what your Apple III is doing, Vigil will alert you to the next event on your busy schedule. The price is attention-getting, too. Just \$95.

Your dealer wants to show you these exciting new programs today. And while you're there, be sure to ask for our free brochure: Apple Polishing.

Or write us directly.

You'll discover how to put Quark's unique line of software to work for you. And then your Apple III can really shine.

* Apple is a registered trademark of Apple Computer, Inc.

Quark[™]

1433 Williams, Suite 1102 Denver, CO 80218
(303) 399-1096

Rosing: The interesting thing is that we were at the stage in the program where the decision to make even what sounds like a simple change takes six months to percolate through because it's not a simple engineering change—it's manufacturing, tooling, documentation.

Daniels: We made one legend change in June or July—the Apple key. When was that?

Tesler: July, and it's just now showing up.

BYTE: A legend change?

Tesler: You saw two keys that said Command on them. The new version has only one, and instead of saying Command it has a picture of an apple on it. The reason is that the key's used as a shortcut to choose a menu command. If you look at a menu, on the right you'll see this little apple symbol

and a letter. If you hold down the Apple key and the letter, you get the command. We couldn't find any way to symbolize the Command key that would fit nicely in a menu and be recognizable to people. We tried and tried. Finally we decided that the apple looked nice and had a nice sound to it—"Apple X," "Apple R"—and it keeps Apple in the mind of the user instead of "control" or something else. It's a symbol that everybody using this machine will recognize instantly, so we decided to put it on the key as well as on the screen. To finish the artwork in time to get the machines to test users in time to get responses, and so on, the change had to be in by a certain date. The decision was made only hours before the deadline.

BYTE: Are there going to be two Command keys without legends on them?

Tesler: No, only one. We studied IBM and DEC and other keyboards and found that they all have just a single Command or Control key on the left-hand side. We also really wanted to put an Enter key on the main keyboard because we would like to be able to offer a configuration in which an alphabetic keyboard and a numeric keypad are independent—for, say, a company that does only word processing. Word processors don't need the Clear function, but they do need the Enter function, so we wanted to be able to have the Enter key on the main keyboard; that way, even people without a numeric keypad can hit Enter. Again, on IBM and DEC keyboards the Enter key is standard; on many of those keyboards, that's the standard position for the Enter key. So we decided to be more like other companies. The Enter key also gives us the option of removing the numeric keypad without losing an important function. And then the option keys were put on the side of those, and there we decided we did need two option keys, left and right, because they're used very much like shift keys for typing, and in Europe it would be very important to be able to touch-type for-

ALL

SOFTWARE

1/3 off

Software Catalog. FREE. Get the lowest price on every software program you need. 1/3 off list price *guaranteed*. And look what else you get from ITM:

Unlimited Consultation! ITM's consultants work with an amazing database indexed with over 300 software selection criteria—plus thousands of in-depth product reviews. You'll get the programs that are right for you. Quickly. Easily. It's the most sophisticated consultation service in the industry. Call toll free!

Over 2,000 programs to choose from. Hundreds added every month. All categories. All formats.

See any program demonstrated. Order any non-entertainment program for a *risk-free, thirty-day trial*. Full refund if not completely satisfied.

No minimum order. Buy just one program if you like. Quick shipments.

All this, and more, is yours for an annual fee of \$100. Call ITM now. Or, mail the coupon today and receive our FREE Software Catalog. Save hundreds—even thousands—of dollars on all of your software purchases with ITM.

American Express, Visa, or MasterCard honored.

Call toll-free today.

(800) 334-3404

In California (415) 284-7540

Software Catalog. FREE.

Byte 283

YES. Send complete information for my review. Please include a free copy of ITM's Software Catalog.

NAME _____

COMPANY NAME _____

ADDRESS _____

CITY/STATE/ZIP _____

PHONE _____

Individual Dealer Consultant Company

ITM

Software Division

We make software buying simple.

Attn: Stevan Cloudfree
936 Dewing Ave., Suite E.
Lafayette, CA 94549-4292
(800) 334-3404 or
(415) 284-7540

Check The Chart Before You Choose Your New 16-Bit Computer System.

**Columbia Data Products'
New Multi-Personal® Computer,
Featuring IBM-PC® Compatibility,
Excels In Professional, Business
And Industrial Applications.
Check it out.**



Columbia Data Products' MULTI-PERSONAL® COMPUTER can use software and hardware originally intended for the IBM® Personal Computer . . . while enjoying the flexibility and expandability of all Columbia Data's computer systems.

Available operating system software includes single-user MS-DOS® or CP/M 86® or multi-user, multi-tasking MP/M 86® or OASIS-16®, with XENIX® available soon, providing users with a host of compatible software packages for personal and professional business and industrial applications. A large selection of higher level languages are also available, including BASIC, FORTRAN, COBOL, PASCAL and MACRO Assembler.

Our standard 16-Bit 8088 hardware configuration provides 128K RAM with parity, two RS-232 serial ports, Centronics parallel printer port, interrupt and DMA controllers, dual floppy disks with 640K storage, Winchester disk and keyboard interfaces, and eight IBM-PC compatible expansion slots . . . and lists for only \$2995. Winchester hard disk configurations, featuring cache buffer controllers for enhanced disk access performance are also available, starting at \$4995.

So, when you need to grow, why gamble and hassle with independent third party hardware and operating system vendors which may or may not be compatible . . . not to mention the hidden expense and frustration of implementing peripheral drivers in the different operating systems and upgrades? Who needs the finger-pointing when things don't work out?

After you review our chart, you will agree . . . for overall 16-Bit microprocessor superiority, expandability, flexibility, compatibility and real economy, Columbia Data is your *total source*.

Our Multi-Personal Computer . . . the 16-Bit system born to grow!

Get yours now.

Circle 78 on Inquiry card.



MAIN FEATURES	CDP-MPC	IBM-PC*	OTHERS
Microprocessor	16-Bit 8088 8-Bit Z-80 (Opt)	16-Bit 8088	?
USER Memory	128K-1 Mbytes	16K-256 Kbytes	?
IBM-PC Compatible Expansions Slots Beyond Professional Configuration†	8 Slots	0	?
Resident Floppy Disk Storage	Dual 320K (std)	Dual 160K (Opt) Dual 320K (Opt)	?
Resident Cache Buffer Hard Disk Storage	5M/10M	—	?
OPTIONAL OPERATING SYSTEMS (Supported by Company)‡			
MS-DOS (PC-DOS)	Yes	Yes	?
CP/M 86	Yes	Yes	?
MP/M 86	Yes	—	?
OASIS-16	Yes	—	?
XENIX	Soon	—	?
OPTIONAL HARDWARE EXPANSION BOARD (Supported by Company)			
RS-232 Communications	Yes	Yes	?
B/W and Color Display Controller	Yes	Yes	?
Expansion Memory	Yes	Yes	?
Z-80 CP/M-80 Board	Yes	—	?
Cache Buffer Hard Disk	Yes	—	?
Time/Calendar Board	Yes	—	?
IEEE Bus Controller	Yes	—	?
8" Floppy Disk System	Yes	—	?
8" Hard Disk System	Up to 40 Mbytes	—	?
Tape Cartridge System	Yes	—	?

*For comparison purposes, typical professional configurations consist of 16-Bit 8088 Processor, 128K RAM with Parity, Dual 320K 5-inch Floppies, DMA and Interrupt Controller, Dual RS-232 Serial Ports, Centronics Parallel Port and Dumb Computer Terminal or Equivalent.

‡Columbia Data Products also supports CP/M 80* with an optionally available Z-80 CP/M Expansion Board.

*As advertised in BYTE Magazine, August 1982.

COLUMBIA
DATA PRODUCTS, INC.

Home Office:
8990 Route 108
Columbia, Md 21045
Telephone 301-992-3400
TWX 710-862-1891

West Coast:
3901 MacArthur Blvd.
Suite 211
Newport Beach, CA 92663
Telephone 714-752-5245
Telex 277778

Europe:
P.O. Box 1118
450 Moenchengladbach 1
West Germany
Telephone 02161-33159
Telex 852452

eign alphabets for international correspondence, mathematical symbols, and other special characters. So there were some trade-offs. We didn't want to just keep jamming two of every key on the keyboard, so we decided what the priorities were and ended up being fairly close to the industry standard. We have one Apple key, one Enter key, and two Option keys.

BYTE: The user-interface design seems to have been difficult.

Tesler: That was the hard thing that affected the most people. A lot of software and hardware engineering issues were very difficult, but they affected only a few people. Interface issues affected half the division because Training, Publications, Marketing, and the software person implementing the application all had an opinion. People like us who were overseeing all the applications had opinions, in-between managers had opinions, kibitzers on the side had opinions, too. Not everybody can

talk about what gate to use in some circuit or what routine to use in some program, but everybody can talk about the user interface. So we had to accommodate all of these things. And it turned out that good ideas and good criticisms came from everywhere. We had to come up with some objective way to decide. That's why we established the methodology which involved user testing. We had a procedure for proposing changes, reviewing the changes, narrowing it down to a few choices, with certain criteria like consistency and parsimony. And then we actually implemented two or three of the various ways and tested them on users, and that's how we made the decisions. Sometimes we found that everybody was wrong. We had a couple of real beauties where the users couldn't use any of the versions that were given to them and they would immediately say, "Why don't you just do it this way?" and that was obviously the

way to do it. So sometimes we got the ideas from our user tests, and as soon as we heard the idea we all thought, "Why didn't we think of that?" Then we did it that way.

BYTE: Bruce, could you say something about the software architecture?

Daniels: There's an operating system underneath that we built ourselves because we felt that the ones that were out there didn't quite meet our needs.

BYTE: What does yours do that others don't?

Daniels: It's not just what it does, but what it doesn't do. Some other operating systems are basically timesharing systems like Unix that have a lot of features that we don't need, and why take up extra space for that? We wanted a system that the user didn't have to be experienced to understand, and it had to be very reliable. It had to maintain the user's data and keep it there. It also had to



*Introducing Automatic Dialing,
300/1200 Baud for \$599**

- 300/1200 Baud—Bell 103/113/212 compatible
- Auto dial—Hayes Smartmodem compatible
- Full or Half Duplex
- Audio Monitor signals busy line, no-answer, etc.

Our newest modem does all this with 3 LSI chips—about one seventh of the usual integrated circuits. Its simplicity, an achievement of advanced micro-processor design, promises two major benefits. The first is outstanding reliability—that stands to reason. The second is a cost low enough to inspire skepticism. Be skeptical: shrewd comparisons may save you \$100 or more.

Intelligent design also makes this modem uncommonly easy to use. Lights and switches let you test and correct installations without technical experience—including some that require special interfaces or rewiring with most modems.

The shrewd modem. If it's not at your dealer's yet, write or call for complete specifications.

*Suggested list for model 212A Auto Dial, including RS232 interface, RJ11C phone jack, and two year limited warranty.

U.S. ROBOTICS, INC.

Circle 422 on inquiry card.

1123 WEST WASHINGTON, CHICAGO, ILLINOIS 60607
(312) 733-0487

Multi-Reasons to Choose CompuPro's Multi-User System 816/C™



- 1. Run any mix of 8 or 16 bit software at any terminal.**
- 2. Lots of storage.** 384K of RAM (expands to 1 MByte), 2.4 million (expands to 4.8 million) characters of floppy disk storage, provisions for hard disk storage.
- 3. Nine serial ports** for terminals, printers, modems, etc.
- 4. Unparalleled single-user operation**, as well as optional expansion from 3 users to 16 users.
- 5. Superior warranty.** 1 year limited warranty.
- 6. Bundled software.** System 816/C runs over 3,000 CP/M® programs, and comes with MP/M™-816™, CP/M 2.2, CP/M-86, M-Drive™, SuperCalc™ (Sorcim's powerful 16 bit spreadsheet), and dBase II™ data manager.
- 7. Ultra-high performance.** As *Interface Age* said, "The (8 bit) 8085 was more than a third faster than any 8 bit micro we have tested to date...the (16 bit) 8088 (was) almost twice as quick as the identically-engined IBM Personal Computer." You will appreciate this extraordinary level of performance when deadlines loom and time is of the essence.

System 816, MP/M 816, and M-Drive are trademarks of CompuPro; CP/M, CP/M-86, and MP/M are trademarks of Digital Research; SuperCalc is a trademark of Sorcim; dBase II is a trademark of Ashton-Tate. Terminals courtesy of Qume Corp.



CompuPro division, Godbout Electronics,
Box 2355, Oakland Airport, CA 94614

Authorized CompuPro Systems Centers specialize in business, industrial, and scientific microcomputing. They can show you why **System 816/C** represents the highest expression of 8 and/or 16 bit multi-user computing.

Circle 90 on inquiry card.

Innovators in Winchester Subsystems!



Tallgrass Technologies presents a family of Winchester HardFiles and removable cartridge media that has set the industry standard on performance and reliability. With integral tape backup and formatted capacities from 6.25 Mb to 20 Mb, Tallgrass has a HardFile to answer the most serious data management problems.

TALLGRASS SUPPORTS LOCAL AREA NETWORKING

PCnet is a low-cost solution to your IBM PC's Networking needs. PCnet enables IBM PC users to share HardFiles and floppy disks, printers and communication lines. For more information contact:



487 Sinclair Frontage Rd.
Milpitas, CA 95035 • (408) 942-8660

Let Tallgrass introduce you to our family of Winchester subsystems and watch your personal computer transform into a powerful data processing system.

From \$3095.00 suggested retail including integral backup.



9207 Cody
Overland Park, Kansas 66214
(913) 492-6002

Available from COMPUTERLAND and other participating dealers.

BYTE Interview

support things like graphics, the windows that we have on the screen, the mouse, and so forth. We didn't really find an operating system that met our needs, so we felt we had to go build our own. We built the other features on top of this—the support for the windows, the support for graphics, the support for multiple fonts, the support for printing. It's really quite a rich architecture. At least half of the software is in this foundation software.

BYTE: How large is that in bytes? How much code is in that foundation software?

Daniels: Well, source code is something like 10 megabytes.

Tesler: Object code is about half a megabyte.

BYTE: That's what's there before you put the application programs in—half a megabyte?

Daniels: Yes.

BYTE: After you specified the user interface, what list of hardware requirements did you come up with?

Rosing: Well, the main list that was specifically user interface would be the bit-mapped graphics display and the resolution of approximately 700 pixels across in the horizontal dimension, the mouse, and the doorless disk drives with the eject button rather than an eject handle. They determined a lot of the hardware design. We had other user-interface considerations, though. We wanted to make the system very easy for its users to service—I presume you've seen it break apart. Servicing really is simple. It took a moderate amount of extra product cost to get that feature in there. And that's a part of the even more global user interface, how people perceive the whole system.

BYTE: Why did you choose the 68000 microprocessor and what alternatives did you consider?

Daniels: We thought its architecture was very broad and strong and would take us through the '80s, and we wanted that. We wanted something to support the graphics, and we thought that processor gave us what we needed then. The 68000 was a bit of a gamble because it was very

young when we got on it. We were getting one sample at a time from the local Motorola engineer here.

BYTE: Do you think the 68000 will be the dominant processor in the next few years? Is it going to overcome the 8088, the 8086?

Rosing: I would speculate that for high-end applications with very computer-intensive, graphics-intensive needs, the 68000 will become dominant.

Daniels: But the 8086 has such an installed base going already, I think that alone would carry it. . .

Tesler: You mean numbers of actual units with the 68000 in it, or the number of different products?

BYTE: Both of those questions.

Tesler: Well, we're putting 68000s in the units we'll sell, so that will mean more units with 68000s. We expect to sell a lot of machines.

BYTE: You've got a 68000 machine with a lot of memory in there, and not too much special-purpose hardware. Why did you decide to do it that way instead of using some versatile hardware chips, like the NEC 7220, for video display?

Daniels: We're very much boosters of bit-mapped graphics, and in fact hardware support for bit-mapped graphics is pretty small. All you need is sort of a shift register. We thought the flexibility that would give us in graphics and the things we could do in user interface with bit-mapped graphics was well worth the price.

BYTE: But doesn't the 7220 have bit-mapped graphics itself?

Rosing: Well, there were a couple of practical considerations. The NEC 7220 didn't exist when we designed Lisa, although we knew it was planned. The second consideration was that the 7220 cost more than the TTL [transistor-transistor logic] hardware needed to implement the equivalent functions. And the third consideration was this: because we were able to interleave the memory and display cycles, we were able to essentially get data out of the memory at very little penalty. Using a 7220 would actually cost considerably more in terms of system



IF MetaCard DOESN'T IMPROVE YOUR WORKING CONDITIONS WE'LL GIVE YOU YOUR MONEY BACK.

It's almost three in the morning. You knew just one more line of code and your program would be finished. That was seven hours ago. It's hard work developing good software. Writing it on the Apple II is no exception. Although we can't promise to get you to bed by eleven o'clock, we can make your job a lot easier.

When we developed MetaCard, a co-processor system for the Apple II, we designed in 128K bytes of on-board memory with parity. Enough memory to run the most powerful development tools available. We included memory expansion capabilities beyond 128K.

And we made sure it could run all three operating systems for the IBM PC. MetaCard does more than make your job easier, it opens up new development areas. If you want to create or run more powerful applications software for the Apple, or for the IBM PC or other 8086/88-based systems, you should have a MetaCard in your Apple. MetaCard supports the most popular development languages available for MS-DOS, CP/M-86 and UCSD p-System Version IV. Languages like Pascal, C, COBOL,



FORTRAN, BASIC and almost all others operate at peak performance. MetaCard enables you to continue to use most of the popular peripherals for your Apple II, plus all of your existing software. And with many best selling applications for the IBM PC available soon, you can use your Apple in new and developing areas.

MetaCard uses the Intel 8088 processor and operates at a full 5 Mhz. And MetaCard's real-time clock, external power supply, parity checking RAM, and power-up ROM diagnostics give you the features and reliability you demand.

Satisfaction Guaranteed

We know you'll still work through the night. But if MetaCard doesn't improve your working conditions, return it within 30 days, and we'll send your money back. No questions asked.

MetaCard, complete with documentation, MS-DOS and UCSD p-System (CP/M-86 optional) and power supply, is available in both 64 and 128K configurations, priced at \$980 and \$1,150 respectively. The MetaCard System Operating Manual is available for only \$25.

For more information write us today, **Metamorphic Systems, Inc.**, 8950 Villa La Jolla Drive, Suite 1200, La Jolla, CA 92037.

Or call us today to order yours at

800/228-8088

In California call 619/457-3870.

MetaCard is a trademark of Metamorphic Systems, Inc., Apple — Apple Computer Inc., Intel 8088 — Intel Corporation, CP/M-86 — Digital Research Corporation, MS-DOS — Microsoft, UCSD p-System — University of California, IBM PC — IBM.

Circle 253 on Inquiry card.

MetaCard

performance. And there was one more consideration: with the 7220, you can't access the display memory bank when the chip is refreshing the CRT, and that limits the time you can access it to about 10 percent of what we have, which would drastically affect performance. We can access memory any time. For equivalent performance, we would have to use two 7220s, and that would push the cost and the "real estate" beyond what we have.

BYTE: On the other hand, software doesn't get written overnight. . . there's a certain cost to that. You know, this is very software-intensive.

Rosing: Most of the software that supports the graphics took three years to write, but no hardware in the world can duplicate what that software does.

BYTE: Really? The software is faster than the hardware?

Rosing: No, not always faster.

BYTE: Its functionality is greater?

Tesler: Yes. The graphics package lets us draw circles, rectangles, ovals, and rectangles with rounded corners. It also automatically handles clipping on nonrectangular boundaries. If you have one object over another, you can draw the one behind without splashing the pixels on top of the one that's in front. That's a . . .

BYTE: A software revolution?

Tesler: A very unusual capability, which no one else has in that general form. The other implementations are all either very, very expensive hardware—the \$100,000 class—or in software, which isn't really that general and performs much much worse. There's nothing in the same class as our software as far as capability and speed. Of course, there is graphics software that's faster and hardware that's faster, but it doesn't have

anywhere near this capability.

BYTE: Do you have a Xerox Star here that you work with?

Tesler: No, we didn't have one here. We went to the NCC when the Star was announced and looked at it. And in fact it did have an immediate impact. A few months after looking at it we made some changes to our user interface based on ideas that we got from it. For example, the desktop manager we had before was completely different; it didn't use icons at all, and we never liked it very much. We decided to change ours to the icon base. That was probably the only thing we got from the Star, I think. Most of our Xerox inspiration was Smalltalk rather than Star.

BYTE: What does Lisa have that the Star doesn't have?

Tesler: We're talking about graphics capability. You originally asked why we didn't use graphics hardware. Our graphics primitives in software are more general than the Star's, so they perform better. We have a faster and more general ability to draw on the screen a picture of multiple graphical objects in different shapes, to have one window that uncovers another, and to repaint just the parts that are uncovered.

Daniels: Look at the desktop managers of the Star and Lisa. With the Star, you can only put them at fixed places on the screen so you know they don't ever overlap. On ours, you can put them any place you want. It's that generality that allows us to have arbitrarily shaped things and covering each other up and . . .

BYTE: Documents or forms, shapes, or anything. . .

Daniels: Yes.

Tesler: Right. We have curves in it. Everything in the Star, you'll notice, is really rectangular, and our things can have curved edges and that sort of thing.

BYTE: Another hardware question: How many microprocessors are in the machine, what are they, and what do they do?

Rosing: Let's see. One to scan the keyboard, in the keyboard housing proper; a second one that receives the

A MUST FOR YOUR IBM PC

Programming Made Easy

Stop struggling with incomplete, disorganized IBM-PC Manuals. Learning to program can be a relaxed, enjoyable experience with Dr. David Lien's definitive 450-page handbook for the IBM-PC. Learning IBM BASIC's easy-to-follow format will soon have you writing custom software for your PC — even if you're completely new to computers.

30-Day Money Back Guarantee
 You just can't lose. If you're not totally satisfied with this book for any reason, return it to CompuSoft in salable condition within 30 days for a full refund. Fill out and mail the coupon today, or call our 24-hour orderline at 800-854-6505; in California call 619-588-0996 (8:00 a.m. - 5:00 p.m.)

Learning IBM BASIC For the Personal Computer



by David A. Lien

CompuSoft® Publishing
 P.O. Box 19669, Dept. #030283
 San Diego, CA 92119

Please send _____ copies of *Learning IBM BASIC* at \$19.95 each (Calif. residents add 6%), plus \$1.65 shipping and handling per book within the U.S. Foreign orders, include \$2.50 surface shipping and handling per book.

Total Enclosed _____ Name _____

Address _____

City/State/Zip _____

Check
 Visa
 MasterCard

Account #
 Expiration Date

Signature _____ Please allow 4 to 6 weeks for delivery.

Inventory Reduction Sale

Many items at cost. Order Now.

COMPUTERS

Apple II 48K	\$1065
Atari 800 48K	\$655
Chamelion (portable IBM type)	\$1995
Franklin ACE1000	\$955
Kaypro	\$1695
IBM PC	SCALL
Osborne	SCALL
NEC APC	\$3150
Stimline S-100	Under \$2000
Syscom 2 (like Apple)	\$725
VIC 64	Ask for Package!!

PRINTERS

Epson MX-80 F/T	\$435
Epson MX-100	\$645
Brother/Comrex 17cps daisy	\$745
F-10 Starwriter	\$1225
NEC 7710-1	\$2065
NEC 7730-1 (for IBM PC)	\$2095
Okidata	Entire line at dealer cost
u84AP	\$935
u92A (160cps)	\$525
Prowriter	\$435
Prowriter II	\$655
Smith-Corona TP-1	\$550
Star Gemini-15	\$495

VIDEO MONITORS

The best value in Monochrome is	DYNAX
The best value in RGB is	TAXAN
Amdek 300G 12" green	\$145
Amdek 300A amber	\$160
Amdek 310G for IBM	\$170
Amdek 310A amber	\$180
Amdek Color I	\$325
Amdek Color II	\$685
Dynax 12" green, 20MHz	\$129
Dynax 12" amber, 20MHz	\$145
Taxan/JCS 12" green	\$135
Taxan/JCS RGB-1	\$345
BMC, Sanyo, USI	We expect new low pricing by the time this ad appears. SCALL

FOR APPLE & FRANKLIN

Corvus	all items	BIG DISCOUNT
dBase II		\$395
Z-80 Card—Applied Engineering		
1-9 pcs		\$195
10+ pcs		\$175
Universities, clubs, and dealers welcome.		
Hayes Micromodem II		\$275
Rana Elite I		\$285
Rana Elite II—double		\$455
Rana Elite III—quad		\$585
8" drive, 2MByte Floppy System		\$1695
Ominivlon 80 column, with software		\$165
Parallel interface with cable		\$58
Prometheus 16K RAM		\$75
*Graphitti (Printer/Graphics Int.)		\$110
*Expand-a-Ram, up to 128K		\$195
Videx Videoterm 80 column		\$245
Visicalc 3.3		\$179
VR Data 5M8 Hard Disk with error correction		\$1575

MODEMS

Hayes Smartmodem 300	\$195
Hayes Smartmodem 1200	\$515
Novation CAT	\$149
" O-CAT	\$168
" 212 AutoCAT	\$585
" 103 AutoCAT	\$215
Universal 103 Line Powered	\$165
" , auto answer	\$205
" 202, 1200 baud, half duplex	\$185
" 212, 1200 baud, full duplex	\$445

FOR IBM PC

AST RESEARCH CARDS NOW INCLUDE SPOOLER AND DISK EMULATOR SOFTWARE	NO EXTRA CHARGE
AST ComboPlus 64K with Parallel, Serial, Clock	\$375
AST MegaPlus 64K, expandable to 512K, SPC	\$435
Corona 5M8 Hard Disk	\$1495
Parallel cable	\$35
Serial cable	\$32
RAM sets, 64K with parity	\$65
Tandon TMM 100-2 drive	\$265

ATARI

Atari 800 48K	\$655
810 Disk	\$450
830 Modem	\$159
850 Printer Interface	\$165
Printer cable	\$35
Serial cable	\$35

CHAMELEON "The Compatible Computer"

- Runs IBM PC & Z-80 software
- 128K RAM, expandable to 700K
- Dual 320K drives
- PC style keyboard
- 9" green display, 80 x25 with graphics
- Software: DGS, word processing, spread sheet
- PORTABLE!!!

You must register your order now to receive the introductory price of **\$1995**

S-1000 THINLINE MAINFRAME

- 9 x 9 x 18 1/2"
- Power and mounting for 2 thinline 8" drives
- 6 slot S-100 motherboard, cage, power
- Fan, EMI filter, connector cutouts

Compare in features and quality with units costing hundreds more.

\$450

QUME DRIVES

QT242, 8" thin, dsdd	\$485
QT842, 8" std, dsdd	\$495
DT542, 5 1/4", dsdd, 48 tpi	\$295
DT562, 5 1/4", dsdd, 96 tpi	\$365

We also carry Mitsubishi, NEC, Shugart, and Tandon

S-100 THINLINE COMPUTER SYSTEM

- Z-80 4MHz, 64K, CP/M
- 2 Thinline drives, 8", 2MByte
- Mainframe
- Add any standard video terminal and printer

NOT \$3500 NOT \$2500 JUST \$1895

ADD-ON DRIVES FOR ZENITH Z-100 COMPUTERS

- 2 Thinline 8" drives, double sided, 2MByte
- Thinline cabinet, vertical, power supply, fan, cable

Just plug it in \$1175

COMPUPRO (Godbout)

Co-Processor 8086/8087 8 MHz	\$615
Dual Processor 8085/8088 6MHz	\$385
Disk I. Floppy Controller	\$490
RAM 17, 64K CMOS, 12M Hz	\$515
RAM 21, 128K Static, 12M Hz	\$1155
M-Drive, 128K	\$1150
S-100 Mainframe, 20 slot, rack	\$795
S-100 Mainframe, 20 slot, desk	\$735
System Support 1, 1/0	\$335
Interlacer 3, 8 serial	\$615

WABASH DISKETTES

5 1/4", Single Sided, Double Density with Hub Ring	
5 boxes	\$17.50/box

EPSON RIBBONS

MX-80 black	\$25/3pcs.
MX-10 black	\$39/3pcs.

TELEVIDEO TERMINALS

Extra Memory Pages (kit) INCLUDED—No Charge	
TV1925	w/2nd page \$745
TV1950	w/2nd, 3rd, 4th page \$945

MEMORY IC's

4164 64K Dynamic 200ns	\$7.25
4164 64K Dyanimic 150ns	\$7.95
4116 16K Dynamic 200ns	\$2.00
2716 Eprom	\$4.00
2732 Eprom	\$6.50
6116 2Kx8 Static RAM, 200ns	\$5.00
6116 " , 150ns	\$5.50



IRONSIDES COMPUTER CORP.

(213) 344-3563 (800) 528-9537
18546 Sherman Way, Suite #110,
Reseda, CA 91335

Verify prices by phone. Shipping is extra except within the Continental U.S. on prepaid orders. California orders, add 6 1/2% sales tax.

Circle 470 on inquiry card

keyboard commands and keys up mouse events; the 6504 that controls two floppy disks; a Z8 microprocessor in the hard-disk controller—it's an intelligent controller; and then, of course, the 68000. That's five.

Tesler: Almost every major chip manufacturer except for one.

Rosing: And with only one exception all our I/O (input/output) cards have microprocessors.

BYTE: You say that the magnetic read/write head in the disk drive is microprocessor-controlled in order to let it be more sensitive to variations in the alignment. Is that the 6504?

Rosing: Yes.

BYTE: What is the microprocessor that handles the keyboard and the mouse?

Rosing: That's a National COPS. We tried to pick the processor that we felt was best for each particular job.

BYTE: The memory is 64K-byte chips?

Rosing: Yes, 64K chips.

Tesler: On the memory we have parity and. . .

BYTE: What part of the memory is video memory?

Daniels: Some area in the main memory can be the video.

Tesler: Any area at all. In fact, if you noticed yesterday in the demonstration, when we're developing software, we need debugging information to be displayed for the programmer, but we don't want it to come out on the same screen that the user is seeing, so we had this magic toggle we were hitting that flipped between two screens. There are really two different areas of memory with a bit map in each. The software can switch between the two to display each in turn.

BYTE: But they're within the main memory?

Tesler: Yes, absolutely. Anywhere in memory. Take any number of consecutive bytes and say that's the bit map.

BYTE: Is anything else in main

memory, or is the rest of it all available to the user? Is anything else mapped to the memory?

Tesler: Oh, I see what you're saying—the shared memory. Shared memory with I/O is not main memory. The I/O memory is in the I/O cards.

Rosing: It's not in the memory, but it's accessed like main memory, from the 68000 bus.

Tesler: It's in the address space, but it's not in those 64K chips.

BYTE: A certain address is really an I/O port, is that right?

Rosing: Yes; it's the top physical address of the 68000.

BYTE: Did you consider voice as part of the user interface?

Rosing: Yes. We looked at it pretty hard and at one time in the early system we actually had a CVSD-based voice subsystem in the computer, and we took it out because we didn't feel it achieved the quality we wanted to have associated with this system.

BYTE: What does CVSD mean?

Rosing: Continuously Variable Slope Delta modulation. It's much easier to say alphabet soup. We've thought about voice; it's part of our network architecture and will appear in the future, but only when we feel the technology's right so we can be proud of what we offer.

BYTE: That's both input and output?

Rosing: Right. We look at voice as being three problems. There's store and forward, which is just moving voice messages around, like a glorified answering machine. Second is text to voice; and third, of course, is voice recognition, or voice to text. The last one's the hardest of all, but we look at voice technology as something we have to approach in a unified way.

BYTE: What about the programmable serial ports? What chip is used there?

Rosing: They use the Zilog SIO. That was one of the last major changes we made in the hardware design. We did it because we had two high-speed ports with less board space, and the Zilog SIO chip supports asyn-

Data-Vu™

A COMPLETE DATA MANAGEMENT FACILITY

Everyone has heard that the cost of computing is going down, but by the time you're finished with a Database Management System you can rely on you've spent hundreds and maybe thousands of dollars. At Thinkers Soft Inc., the price of computing is more reasonable than you think. Data-Vu™ by Thinkers Soft Inc., has three features which makes it one of the most powerful data management facilities available.

- 1. Automatic Form Generator**
Allow you to generate forms on the screen and use them as a personalized tool to enter data on the data base.
- 2. Relational Database Manager**
Designed for the small firm or professional who would like a convenient but inexpensive data base management system.
- 3. The Report Generator Program**
Specifically designed to retrieve information from the data base with simple statements, perform arithmetic operations, and much more.
- 4. Automatic Menu Generator**
Allows you to generate menus and use them as a personalized tool to run your application programs.

ALL THIS FOR \$149 (Disk & Manual)
CP/M* Compatible

Specify Diskette Format.
\$2 additional shipping costs per diskette.
Prices subject to change without notice.
*Registered trademark of Digital Research, Inc.

Thinkers Soft, Inc.

P.O. Box 221, 221 Clinton Rd.,
Garden City, NY 11530

Call Today
Dealer Inquiries Invited
(516) 294-8104
We Accept Master Charge

64K STATIC RAM MEMORY



S-100 STATIC MEMORY BREAKTHROUGH

Finally, you can buy state-of-the-art S-100/IEEE 696 static memory for your computer at an unprecedented savings.

Memory Merchant's memory boards provide the advanced features, quality and reliability you need for the kind of operational performance demanded by new high-speed processors.

Completely Assembled.

These memory boards are not kits, nor skeletons — but top-quality, high-performance memories that are shipped to you completely assembled, burned-in, socketed, tested and insured with one of the industry's best warranties.

Superior Design & Quality.

Memory Merchant's boards are created by a designer, well known for his proven ability in advanced, cost-efficient memory design. Innovative circuitry provides you with highly desired features and incredible versatility.

Only first-quality components are used throughout, and each board is rigorously tested to assure perfect and dependable performance.

No Risk Trial.

We are so convinced that you will be absolutely delighted with our boards that we extend a no-risk trial offer. After purchasing one of our boards, you may return it (intact) for any reason within 15 days after shipment and we will refund the purchase price (less shipping).

NEW S-100 PRODUCTS COMING SOON:

- * DUAL 8/16 BIT CPU BOARD
- * 128K 8/16 BIT STATIC RAM
- * 256K 8/16 BIT DYNAMIC RAM

\$629.

48K PARTIALLY POPULATED \$519.
32K PARTIALLY POPULATED \$409.

64K RAM, MODEL MM65K16S

- 64K × 8-bit
- Speed in excess of 6 MHz
- Uses 150ns 16K (2K × 8) static RAMS
- Ultra-low power (435 Ma. max. - loaded with 64K)
- Bank Select **and** Extended Addressing
- A 2K window which can be placed anywhere in the 64K memory map
- Four independently addressable 16K blocks organized as:
 - Two independent 32K banks **or**
 - One 64K Extended Address Page **or**
 - One 48K and one 16K bank for use in MP/M¹ (option)
- Each 32K bank responds independently to phantom
- 2716 (5V) EPROMS may replace any or all of the RAM
- Field-proven operation in CROMEMCO CROMIX* and CDOS*.
- Compatible with latest IEEE 696 systems such as Northstar, CompuPro, Morrow, IMS, IMSAI front panel, Altair and many others.

OEM and DEALER inquiries invited.

14666 Doolittle Drive
San Leandro, CA 94577
(415) 483-1008

FULL TWO-YEAR WARRANTY.

The reliability of our boards, through quality-controlled production and proven performance, has enabled us to extend our warranty to a full two years. That's standard with us, not an option. This includes a 6-month exchange program for defective units.

Shipped direct from stock.

All Memory Merchant's boards are shipped direct from stock, normally within 48 hours of receipt of your order. Call us at (415) 483-1008 and we may be able to ship the same day.

16K RAM, Model MM16K14



16K STATIC RAM \$169.

16K × 8 Bit
Bank Select & Extended Addressing
Four independently addressable 4K blocks
One 4K segment equipped with 1K windows
Uses field-proven 2114 (1K × 4) RAMS
Low Power (less than 1.2 Amps)
Runs on any S-100 8080, 4 MHz Z-80 or 5 MHz 8085 system.

Prices, terms, specifications subject to change without notice.

*Cromix and CDOS are trademarks of CROMEMCO.
¹ MP/M is a trademark of Digital Research

Hank: Here's the report you've been waiting for. Hope you put your system on automatic and didn't stay up.

To all reps: Price changes on following items effective immediately:
No. 10-111A, 10-114A, 10-AL.

Take that, bud. (And retaliate fast. I know phone rates are low now, but game's cutting into sack time.)



Your computer's telephone. Hayes

Whether they're getting the jump on the latest stock reports or waging galactic wars in the middle of the night, more and more personal computer users are *communicating*. With each other. With offices. With networks, utilities and mail services all over the *country*.

your personal computer, at 300 bits per second, over ordinary phone lines. Goodbye isolation. Hello world.

Your modem is the one peripheral that makes your computer a computer system. So it's only natural that you'd want the best modem for your money. (One that comes with a limited 2-year warranty.) The Smartmodem 300 is a wise choice. Far superior to acoustic coupler modems, which connect to the telephone receiver. And it's so easy to use.

It dials, answers and disconnects calls automatically, operating with rotary dials, Touch-Tone* and key-set systems. Plus it works at full or half duplex, which simply means that connecting to a time-sharing system, while it is a big deal, is no big deal to do.

Indicator lights let you see what your Smartmodem is doing, while an audio speaker lets you hear it. (Is the remote system down, or was the line just busy? This way, you'll know.)

Now all these extras aren't absolutely necessary. We could have gotten by without them. But at Hayes, we're not satisfied with just "getting by." That's

why we made the Smartmodem 300 so well, smart. You can even program it. In fact, we've provided one for you.

Announcing Smartcom II.™ The communications program designed by Hayes specifically for the Smartmodem. If ever there was friendly software, the Smartcom II is it!

The first time out, you'll be creating messages, sending them, printing them and storing them to disk. Simultaneously.

Likewise, when you're on the receiving end. Only you really don't need to be. With Smartcom II and your Smartmodem 300, your computer does it all, **completely unattended!** That's especially helpful if you're sending work from home to the office, or vice versa.

But it's just part of the story. For instance, before you communicate with another system, you need to "set up" your computer to match the way the remote system transmits data. With Smartcom II, you do this only once, the first time. After that, the information (called parameters) is stored in a directory on the Smartcom II. Calling or answering a system listed in the directory requires just a few quick keystrokes.

You can store lengthy log-on sequences the same way. Press one key, and the Smartcom II automatically executes a whole string of numbers to connect you to a utility or information service.

And if you need it, there's always "help." Even while you're on-line, the screen will display explanations about a



And Hayes is providing the communications link: A first-rate telecomputing system that combines an intelligent RS-232 connect modem with a sophisticated, easy-to-use communications program.

The Smartmodem 300. Think of it as your computer's telephone. Just plug it into any phone jack, and the Smartmodem 300 sends messages to and from



Hayes®

Press one key, and the Smartcom II automatically exe-

cutes a whole string of numbers to connect you to a utility or information service.

And if you need it, there's always "help." Even while you're on-line, the screen will display explanations about a

Welcome to TELEMAIL! Your last access was Tuesday, Jan. 4, 1983 11:07 AM. CHECK these bulletin boards: TELEMAIL...TELESOFT...



BYTE Interview

chronous as well as byte-sync and bit-sync protocols. We felt that made a heck of a lot more sense for the customer as the world evolves toward X25-type packet transmission. We didn't want to make the customer buy an I/O card to upgrade from async to bit-sync. We have only three I/O slots, so we're careful not to waste them on things we can put in the main machine.

BYTE: Both serial ports can be bisynchronous?

Rosing: Yes; they can be programmed any way.

BYTE: And can this SIO function as a UART?

Rosing: Yes. A UART/USART combination.

BYTE: When did you know that you were going to have half a megabyte as standard memory? When did you know how much you were going to need?

Daniels: It's always been a backward sort of thing. We had the capability for a full megabyte in the machine, and it was more a case of how much memory we needed to achieve our goal.

Tesler: The sales force wanted it to be 128K; the programmers wanted a megabyte. We negotiated.

Rosing: Since we were writing the code we got the megabyte.

Tesler: So the hardware people made it as big as they could in the address space, and then after some testing of the system we determined that half a megabyte was a reasonable compromise of cost and performance.

BYTE: Do you expect the standard memory on other manufacturers' machines to jump dramatically after the appearance of Lisa?

Tesler: Well, apart from its impact on cost, I don't think the amount of memory is a critical factor in deciding what machine you want to buy. If you're an end user, you should be buying a machine based on what it does for you, how easy it is for you to learn, how easy it is to use. Whether it has 12 bytes or it has 12 megabytes doesn't really matter to the end user, which is our marketplace. We're not selling the machine primarily to pro-

grammers who might care about that. End users have no idea which systems have more memory or less memory or one megabyte or one hundred thousand bytes. If other manufacturers are trying to match Apple, they should try to match us on ease of use and functionality and things like that. If they can do it in a small amount of memory, more power to them.

BYTE: Doesn't it matter when you're doing something like dictionary software or when you want to read a dictionary into memory fast and proof-read a document very fast?

Tesler: Yes, there are certain functions where it definitely makes a difference. We have that in our Lisa Calc. In order to do rapid recalculation, the whole matrix really should be in resident memory, so we spent a lot of time coming up with a data structure that packed that data as tight as possible so that it would get as many cells as possible into memory, no matter what size memory there was.

BYTE: Your version of BASIC will use more than 64K?

Daniels: Oh, yes. We could have put less memory in it, but the performance would have been unacceptable. Unfortunately, some companies advertise machines that have less memory than anyone would ever reasonably buy. We haven't tried to do that here.

BYTE: You didn't use less memory and fewer disk drives than would really be effective, and so on?

Daniels: Yes, and I think when you look at the typical configurations that people buy of other machines, the cost is really not that different from the kind of costs we're talking about for Lisa. If the other machines get loaded up with disks and memory and the other kinds of things you want to run, then their prices will be comparable.

BYTE: When you decided you had to have hard-copy graphic output that accurately represented the quality of the screen graphics, what choices did you consider before you did this amazing adaptation of a \$600-\$700 printer?

prompt, message or parameter that will get you on your way in no time.

Smartcom II also provides a directory of the files stored on your disk. You can create, display, list, name, re-name or erase any file right from the Smartcom II screen.



And now Smartcom II is available for the IBM PC** and Xerox 820-II†.

Like all our products, Smartcom II and the Smartmodem 300 are backed by excellent documentation and full support from us to your dealer.

So see him today. Link up to the exciting world of telecomputing. Get a telephone for your computer.

Hayes Microcomputer Products, Inc.
5923 Peachtree Industrial Blvd., Norcross,
Georgia 30092. 404/449-8791.

Smartcom II is a trademark of Hayes Microcomputer Products, Inc.

*Trademark of American Telephone and Telegraph

**IBM is a registered trademark of International Business Machines, Corp.

†Xerox 820-II is a trademark of Xerox Corporation

©1983 Hayes Microcomputer Products, Inc.

Sold only in the U.S.A.



If you use a Word Processor, you need

GRAMMATIK™

Beyond Spelling Checking

Grammatik can find over 15 different kinds of common errors missed by simple spelling checkers alone, including punctuation and capitalization errors, overworked and wordy phrases, and many others. Use Grammatik with Aspen Software's spelling checker Proofreader, featuring the Random House Dictionary®, or with your current spelling checker for a complete document proofreading system.

Read what the experts say:

"The perfect complement to a spelling checker."

Alan Miller, *Interface Age*, 5/82

"A surprisingly fast and easy tool for analyzing writing style and punctuation."

Bob Loudon, *InfoWorld*, 12/81

"Anyone involved with word processing in any way is encouraged to get this excellent program."

A.A. Wicks, *Computronics*, 6/82

"A dynamic tool for comprehensive editing beyond spelling corrections."

Dona Z. Meilach, *Interface Age*, 5/82

"A worthy and useful addition to your word processing software."

Stephen Kimmel, *Creative Computing*, 6/82

Works with CP/M®, IBM-PC®, TRS-80®

Grammatik \$75.00
Proofreader \$50.00

Order directly from Aspen Software, or see your local dealer. Specify your computer system configuration when ordering! Visa, Mastercard accepted.

Random House is a registered trademark of Random House, Inc. Other registered trademarks: CP/M: Digital Research -- TRS-80: Tandy Corp. -- IBM: IBM -- Proofreader, Grammatik: Aspen Software Co.

Aspen Software Co.

P.O. Box 339-B Tijeras, NM 87059
(505) 281-1634



BYTE Interview

Rosing: A wide range of options were being discussed, all the way from thermal printers to laser printers. We tried to identify what's critical in the marketplace. We thought there were two printers of first priority: a personal printer and one with letter quality. At the same time our sister division, the Apple II-III division, was evaluating the same two sets of printers. So we teamed up and did a survey of virtually all the printers that were available from every manufacturer who would have the volume capability to serve our needs. We did an extensive test and put about eight dot-matrix printers through their paces with really tough software. Quite a few of them just fell right off the table—it was clear that the quality wasn't there. Certain vendors were also much more responsive to fixing problems. So it really boiled down to two printers. Then, as we developed our printer software, the one we're using now—the C. Itoh—just far and away stood out as having the best mechanical design. You could put the dots where you wanted them repeatedly, and that's what we needed more than anything else in the world—good mechanical design.

Rosing: And a good price. Same for the letter-quality printer.

BYTE: The printer you are using is from C. Itoh, but it's your own ROM and your own systems software that drives the printer through the ROM.

Rosing: Correct.

BYTE: What else can you tell us about the printer, especially the dot-matrix?

Daniels: Mechanically it's just a raster device.

Tesler: A character generator is built into it; it has some capabilities. It has a single type style that can be stretched horizontally and vertically as it's printed, and it has what they call a graphics mode. They thought that would be used lightly, but it's what we use almost exclusively. And even within the graphics mode, there are two resolutions, low and high. High resolution is a lot slower. We wanted to offer the user all these choices.

BYTE: So this is a custom design for you. . . custom changes?

Tesler: Custom changes I would say, yes.

BYTE: Did you say it sometimes prints out in character mode? I thought all of its printing when you were controlling it was using the highest resolution.

Daniels: I think all the stuff you saw was done at high resolution.

BYTE: For speed you can go to a different mode?

Tesler: Yes; we're planning to offer the customer a way to get a quick draft using the character generator. Characters won't look quite the way they will in the final version, but you can get output in a hurry.

Rosing: The printer will have three different speeds and three different quality levels.

BYTE: Do you have an idea where you're going next?

Rosing: We have what feels like ten years' worth of backlog. We have a pretty good idea what we're going to do for the next few years.

BYTE: What's that?

Rosing: The thrust is to expand the level of integration within the applications and to add facilities to make it easier for more applications to be written outside of Apple.

BYTE: Those facilities are the development toolkit?

Rosing: Yes. The development toolkit is a key thing. And for a large part of the marketplace, adding network applications and data communications is very important. Last but not least is adding really serious database functionality to the system. If you add all that up, it's as big a task or bigger than what we've just done.

Daniels: In fact, almost as important as the team building that we've gone through is building up this foundation that we've used to create the six applications we've now built. The foundation is an amazing application machine. We and others outside Apple can build applications that are just amazing now, because no one has to rebuild the foundation. It's already there, in place, and we really hope to leverage off that in the future. ■



TECMAR
\$1795⁰⁰

complete with
controller & cartridge

This is the breakthrough in storage that IBM PC people have been waiting for, as Tecmar engineering keeps you moving ahead.

- the new SyQuest 5 Megabyte removable cartridge Winchester disk drive
- complete, easily installed in IBM PC or available in IBM-compatible Tecmar expansion chassis
- new Tecmar superspeed controller
- Tecmar disk sharing for up to 4 IBM PCs
- your best solution for mass storage, and the most sensible back-up system available.

We believe this is the future in storage because we have proved its reliability and its advantages. The new removable cartridge gives you unlimited memory at a lower price tag than the basic Winchester at comparable speed.

\$1795 complete with
controller & cartridge
AVAILABLE NOW AT YOUR TECMAR DEALER

**FIRST
FROM
TECMAR**

**NEW
REMOVABLE
CARTRIDGE
WINCHESTER**

Write for new Tecmar Information Kit.

TECMAR

Personal Computer Products Division
23600 Mercantile Road
Cleveland, Ohio 44122
Phone 216-464-7410/Telex 241735



**TECMAR COMPATIBILITY, VERSATILITY,
RELIABILITY, AFFORDABILITY,
RESPONDABILITY**

The first and only complete line of fully compatible expansion options for IBM PCs, including every type of disk drive



NEW SHARED WINCHESTER PC-MATE™

Our new GT subsystem upgrades our original with 3 times faster speed, sharing for up to 4 IBM PCs . . . Controller Board available for upgrade on trade-in.



PC-MATE™ FLOPPY

Controller Board will handle 5¼" and 8" disks. Winchester can be installed in our floppy subsystem cabinet.

The new IBM Instruments Computer System:



Unique combination of features

Unusual flexibility

Attractive price

A new dimension in small computers.

In its price range, the new IBM Instruments Computer System offers higher levels of function and performance than other computers.

For scientific, engineering and general computing applications, including instrument control and data acquisition, data analysis and communications, no other computer is like it.

The IBM Instruments Computer System is based on the highest performance general purpose processor available. Modular design permits you to select a configuration to meet your present needs exactly. Provision for continuing enhancement and upgrading is built in.

The inside story

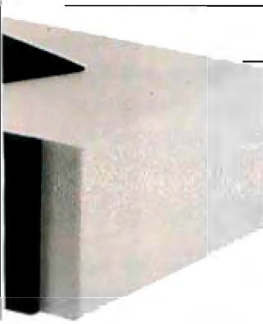

Basic working memory is exceptionally large. When expanded fully, the IBM Instruments Computer System has up to 5 megabytes of working memory.

You'll find more standard communications ports and more connection modes than on other computers at or near the price. The optional integrated Analog I/O card further enhances connectability.

You'll also find a priority interrupt driven system with 32 levels of interrupt and 4 direct memory access channels.

The outside story

This is a computer that people find simple to understand and easy to use. Up to three interface modes (two programmable keypads and a keyboard) provide a wide range of choices for interacting with the system. Operation is from

menu or by simple direct command.

The system provides integrated high resolution graphics on a CRT. Hard copy is supplied by an optional high resolution 4-color printer/plotter using plain paper. These high levels of resolution are standard from IBM Instruments, extra on others.

Optional diskette and disk drives provide up to 44 megabytes of on-line storage.

A real-time, multitasking operating system and a wide range of programming support enhance the usability of the system.

The value story

The IBM Instruments Computer System can grow easily; you can add options yourself. Your initial investment is protected.

Starting at \$5,695, this system gives you outstanding power, capacity and performance for the money.

SPECIFICATIONS, IBM INSTRUMENTS COMPUTER SYSTEM

- | | | |
|---|--|--|
| Processor <ul style="list-style-type: none">● 68000 8-MHz | Communications <ul style="list-style-type: none">● RS232C—3 ports● IEEE-488 bus● Parallel I/O● VERSAbus* compatible system bus● Analog I/O card | <ul style="list-style-type: none">● 768 x 480 dots● Memory mapped |
| Working Memory <ul style="list-style-type: none">● Up to 128K bytes of ROM● 128K bytes of RAM expandable in 256K increments up to 5 megabytes | Printer/Plotter <ul style="list-style-type: none">● 4-colors● Up to 200 cps● 200 x 336 dots/inch● Full dot pattern control for graphics plotting | Keyboard and Keypads <ul style="list-style-type: none">● Full alphanumeric keyboard plus 10 programmable keys● Up to 57 programmable soft keys on processor● 10 programmable soft keys on CRT |
| Disks and Diskettes <ul style="list-style-type: none">● Up to 4 Diskettes, 5¼"-322K bytes or 8"-1 megabyte each● Up to four 5¼" Winchester type disks, 5 or 10 megabytes each | Display Screen <ul style="list-style-type: none">● 12" adjustable● 80 characters x 30 lines | Programming <ul style="list-style-type: none">● BASIC/FORTRAN/PASCAL assemblers● Utilities/Diagnostics● Chromatography, FTIR and other application programs |

*Trademark of Motorola, Inc.

We'd like to tell you more about it. Simply call 800-243-7054. In Connecticut, call 800-952-1073. IBM Instruments, Inc., Orchard Park, Box 332, Danbury, CT 06810.

IBM Instruments Inc.

The Enhanced VIC-20

Part 1: Adding a Reset Switch

Joel Swank
12550 SW Colony #3
Beaverton, OR 97005

Most microprocessor chips have an input pin called Reset. When an electrical zero or ground is applied to this pin, the microprocessor clears all internal registers and starts a preselected sequence of initialization instructions. That's how a microcomputer begins operation when you turn it on. Most microcomputers also have a Reset switch that enables the operator to apply the zero signal to the Reset pin to restart the computer. Unfortunately, the Commodore VIC-20 does not.

The VIC has a restore function that is activated by pressing the Stop/Run and Restore keys at the same time, but it doesn't use the 6502 microprocessor's Reset line. Instead, the Restore key is connected to a 6522 VIA (versatile interface adapter) that is programmed to interrupt the 6502 microprocessor each time you press the Restore key. The 6522 is connected to the 6502's NMI (nonmaskable interrupt) line. When the VIA interrupts the microprocessor, the program being executed stops and the VIC NMI interrupt-handling routine takes control. This routine checks to see if the Stop/Run key is depressed and, if it is, executes the warm-start routine. If the Stop/Run key is not depressed, the original program continues. In normal operation, this method of resetting the VIC works fine. When a program runs astray, you just press Stop/Run and Restore to recover. Any BASIC program in memory is preserved, and all parameters (screen color, sound, input/output devices, etc.) are reset to default values.

Editor's Note

The VIC-20 is one of the new breed of low-cost computers that offer a surprising amount of computing power for the money. But its low cost means that it lacks some of the features we've come to take for granted. In this series of articles, Joel Swank will "enhance" the VIC-20 and hence increase the utility of this very interesting computer. . . .S.J.W.

For the restore function to work, the VIA must be programmed properly. If the errant program has inserted random data into the VIA registers, the restore function will not work. There's another problem: the 6502 can enter a state in which the NMI has no effect. In this "hung" state, the 6502 performs no operations. You rarely encounter it when you use BASIC programs, but if you try to develop any machine-language subroutines, it could happen often. In both of the above cases the restore function does nothing. The only way to recover is to turn the VIC off and back on again, thereby erasing any data or programs that are in memory. A Reset switch can reinitialize the VIC without turning it off while preserving anything in memory.

Installing the Switch

You can implement a Reset switch for the VIC by adding two wires and a switch. Figure 1 shows the schematic diagram for the VIC Reset circuit. Normally, the 555 integrated circuit (IC) timer on the VIC board is used to generate a 3-second low pulse on the Reset line at power-up. The switch serves to temporarily connect pin 2 of the 555 (the trigger input) to the ground line. That causes the 555 to repeat the pulse, which completely resets the VIC system without losing the data in memory. (Note: making this modification to the VIC will invalidate your warranty, so you might want to wait until it has expired.)

The Reset circuit requires one normally open SPST (single-pole, single-throw) push-button switch and two 6-inch lengths of stranded insulated hookup wire. To install the circuit, you'll need a 25-watt or smaller soldering iron. Do not use a 150-watt soldering gun; it will destroy your VIC's printed-circuit (PC) board. Be sure to use only rosin core solder. You'll need a pair of wire cutter/strippers and a pair of small needle-nose pliers. To mount the

THE GIANT KILLER



Vanquishes The High Cost Of Plotters

Small, smart and cost effective, the DMP-40 single-pen plotter puts big-plotter power at the command of the small-system user. With this amiable and competent aid at your side, you can create colorful 8½ x 11" and 11 x 17" graphics—images of professional quality for stand alone use, binding into reports or as overhead transparencies for group presentations.

Circles, arcs, ellipses and general curves are automatically generated by robust internal firmware, freeing you and your computer from wasteful low-level busywork.

By plotting in increments of only 0.005", you are assured of virtually step-free traces. The result is precisely defined graphics of high accuracy and solid repeatability.

Standard RS-232-C interfacing matches the DMP-40 to all current computers.

Multicolor plots on the DMP-40 are a simple matter since built in firmware and most commercial software provide 'pause' commands for pen changing.

These and more big-plotter capabilities are yours at small-plotter cost.*

For the name and location of your nearest distributor, call 512-835-0900 or 1-800-531-5205 outside Texas, or write Houston Instrument, 8500 Cameron Rd., Austin, Texas 78753. In Europe contact Bausch & Lomb NV, Rochesterlaan 6, 8240 Gistel, Belgium, Tel 059-27-74-45, Tlx 846-81399.

*US retail \$995.

BAUSCH & LOMB 
houston instrument division

Circle 45 for literature. Circle 46 to have representative call.

Create transportable software with...

MULTIUSER DATAFLEX™

Get unmatched relational data base power and applications transportability with DataFlex. Applications created with DataFlex run on single and multi-user, 8 and 16 bit systems! What other data base lets you take advantage of:

CP/M	Action DPC/OS™
MSDOS	Molecular N-Star™
PCDOS	Novell Share/Net™
PC-Net	Televideo Mmmost™
CP/M-86	Corvus "PC" Network
MP/M-86	TurboDOS
OSM Zeus™	??? Network

Multi-user operating system implementations of DataFlex provide data protection to the field level in the data base, allowing multiple users to run the same on-line multi-file application.

All DataFlex versions provide on-line multi-key ISAM, powerful data entry and report generation, and a friendly menu to run your applications.

For more information contact your dealer or:

DATAACCESS®
CORPORATION

4221 Ponce De Leon Blvd.
Coral Gables, FL 33146
(305) 446-0669

CP/M & MP/M™ Digital Research, MSDOS™ Microsoft,
PCDOS™ IBM, TurboDOS™ Software 2000.

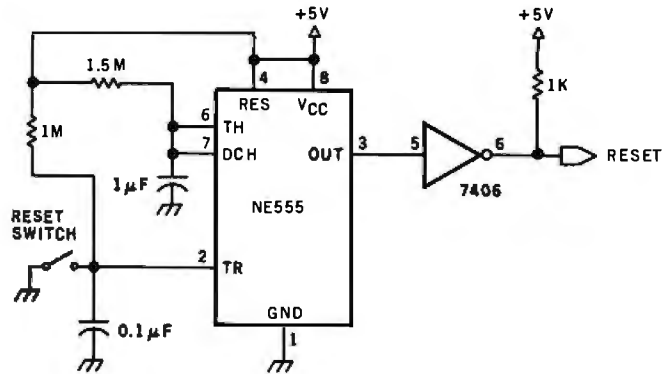

Figure 1: A circuit diagram for the Reset switch, which has been added between pins 1 and 2 of the 555 IC timer.

switch in the case, you'll need a ¼-inch electric drill and drill bits. A small vise to hold the switch while soldering would be handy. You will also need a small Phillips screwdriver to disassemble the VIC.

First disconnect the power cord and any peripherals that are connected to the VIC. Then turn the VIC upside down and remove the three Phillips screws in the bottom front of the case. Turn the VIC back over and lift the top front of the case. It should separate from the bottom and hinge on some hooks at the rear of the case. You will see two sets of wires that connect the top and bottom of the case; these connect the main PC board in the bottom of the case to the keyboard in the top. The group of 18 wires on the left is for the keyboard. The wires must be disconnected at the connector on the PC board. Gently work loose this connector to reveal a row of square posts. The two wires on the right are for the power LED (light-emitting diode). They must also be disconnected from a connector on the PC board. When both sets of wires are disconnected, remove the top of the case and put it aside.

Let's take a look at the VIC board. Two versions are currently in use. The original version, made in Japan, was produced under an FCC waiver that allows it to emit substantial RFI (radio-frequency interference). A small printed notice over the game input/output (I/O) port states this waiver. The newer VICs, which are produced in the United States, have sufficient shielding to meet FCC regulations. Their PC boards are also arranged differently. I have one of the older models, so I'll approach it first.

On the older versions of the VIC, the right side of the PC board is almost completely taken up by the power supply and heat sink. On the far right are the connectors for the power cord and the game I/O. At the right rear is the housing for the expansion slot. The left side is taken up by the ICs that make up the VIC computer. The two 40-pin ICs in the left rear corner are the two 6522 VIAs that the VIC uses to communicate with external devices. Just in front of them are the two 24-pin ROMs (read-only memories), which contain the machine-language routines that make up the VIC control program and BASIC. In front of them is the 6502 microprocessor that controls the

QDP-300

The peace of mind computer.

Introducing our third generation computer... the all-new QDP-300. Now, you can rest assured you've found the most advanced microcomputer on the market today. The QDP-300 is a user-friendly system - its on-line "Help" system gives even untrained operators access to its full power. It uses CP/M* and MP/M* operating systems that assure the user of an abundance of compatible software. The QDP-300 even has a dual voltage system that allows worldwide operation (115 or 220 volts) at the flick of a switch. For word processing, financial forecasting, engineering design and manufacturing, inventory, payroll, bookkeeping and more, the QDP-300 will work hard for you for years and years to come. It's also comforting to know that the QDP-300 is fully expandable and readily upgradeable as your computer needs grow. There's even more. It might make you sleep better to know that the QDP-300 is backed by one year, on-site warranty with service provided by General

Electric Apparatus and Engineering Services, with more than 50 service locations nationwide. If these features and all of the others we've built into the QDP-300 don't bring you peace of mind, then the low price tag will.

- **More Flexibility** - Easily upgradeable to 16 bit capability which gives the user 8 or 16 bit operation. IEEE 696/S-100 Bus.
- **More Speed** - Unique "cache memory" disk operation makes the QDP-300 one of the fastest operational 8 bit systems on the market.
- **More Power** - Advanced single board design utilizing Z80B** CPU operating at 6 MHz.
- **More Storage** - Dual 8" floppy disk drives provide a total of 2.4 MB of formatted storage (10 MB and 15 MB internal hard disk system optional; 30 MB external hard disk system also available.)

Call or write for complete specifications and literature.

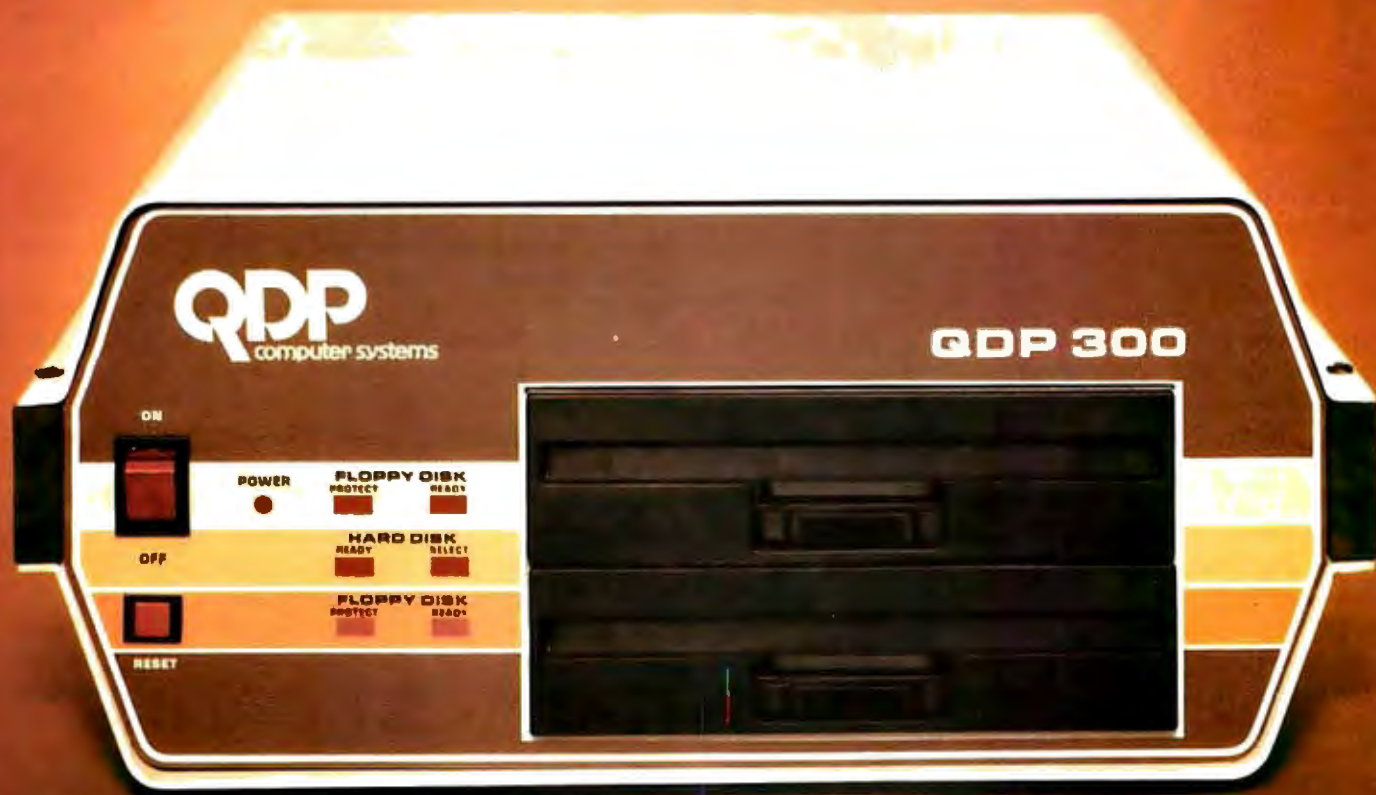

QUASAR DATA PRODUCTS
QDP
computer systems

10330 Brecksville Road, Cleveland, Ohio 44141
(216) 526-0838, Telex: 241596

Circle 356 on inquiry card.

Specifications subject to change

*CP/M and MP/M are trademarks of Digital Research Corp.
**Z80B is a trademark of Zilog Corp.

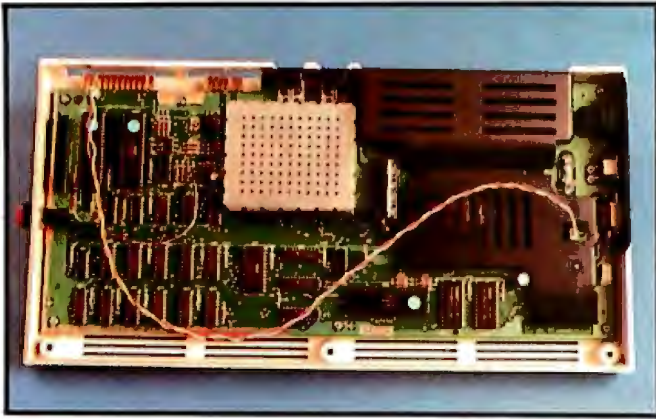

Photo 1: The VIC-20 circuit board. The Reset switch, shown at left, has already been installed in the American version. (Photos by John M. Hannan.)

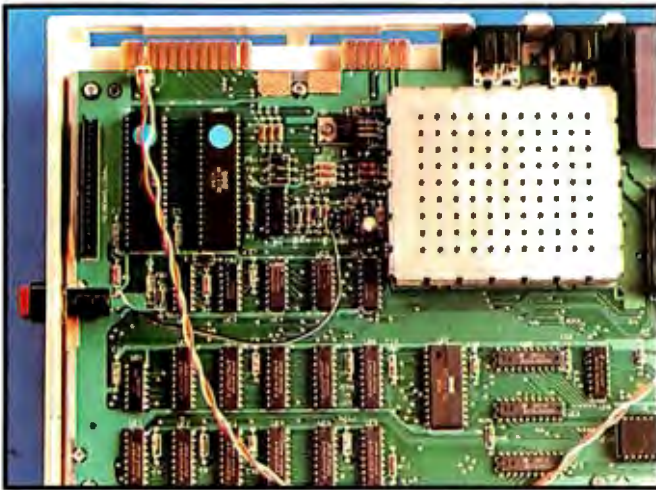

Photo 2: A close-up of the VIC-20 circuit board. The Reset switch is connected to pins 1 and 2 of the 555 IC timer next to the lower left-hand corner of the perforated metal box.

entire system. At the rear center is the 24-pin ROM that contains the VIC character-set patterns and the 40-pin 6560 video-interface chip (hence VIC) that controls the output to the TV. In front of the 6560 are the ten 2114 RAMs (random-access read/write memories) that make up the VIC's 5K-byte standard memory. The rest of the ICs on the board are the TTL (transistor-transistor logic) chips that perform the address decoding and interface between the larger ICs.

Photo 1 shows the newer version of the VIC, which has the power supply, expansion slot, and game I/O on the right side. It has additional metal shielding over the power supply as well. The ICs on the new version are rearranged. The 6502 microprocessor and the two program ROMs are located in the right front just below the power supply. The RAMs are located in the front left in two rows. The character-set ROM is just to the right of the RAMs. The 6522 VIAs are located in the left rear corner. The 6560 and the rest of the TV circuitry can be found in the center rear covered by a metal box. The 555 timer is

located at the left of this metal box.

You will install the Reset switch at the center of the far left end. To the left of the perforated metal box is the 555 timer (see photo 2). With only eight pins, it is the smallest IC on the board. Connecting the Reset switch involves soldering wires to pins 1 and 2 of this IC. The 555 has a dot beside pin 1. The pins are numbered counter-clockwise from pin 1.

Before you make any connections, you must take the PC board out of its case. Remove the screws in the corners of the board, the two screws along the rear edge, and the screw along the front edge. The old version also has a black screw in the front center of the black-metal heat sink. Do not remove the two screws along the right edge. Once you've removed these seven or eight screws, the PC board should lift easily out of its case. If the area you're working in has any static electricity, make sure you discharge yourself by touching a metal object—a filing cabinet or table, say—before touching the PC board. Static electricity can destroy the delicate ICs on the VIC PC board.

Place the PC board on a flat surface to install the switch. Strip about $\frac{1}{8}$ inch of insulation off each end of the two 6-inch lengths of wire. Twist together the strands of the four exposed ends and tin them by melting solder into the strands—that makes them easier to solder to the board and the switch. Next, solder one end of each wire to one of the connections on the switch. Solder the other end of one of the wires to pin 2 of the 555 IC. Solder the other wire to pin 1 of the 555. When you solder the wires to the pins, get the connections hot enough to melt the solder, but be careful not to get them too hot. Excess heat can damage parts and cause traces to lift from the board. The key is to work as fast as possible.

After you've made all the solder connections, you'll be ready to prepare the case for mounting the switch. You'll have to drill a hole through the left side of the case large enough to accommodate the neck of the switch. Because the VIC case is about $\frac{3}{4}$ inch thick, you may have to countersink the hole (i.e., make it funnel-shaped) so that enough of the neck of the switch will fit through to fasten it. Locate the hole high enough from the bottom of the case so that the switch will not touch the PC board and close enough to the 555 so the wires will reach. Drill the proper size hole. If you need to countersink, use the point of a larger drill bit to partially increase the size of the hole from the inside of the case. After drilling the hole, make sure that the switch fits properly. Return the PC board to the case and reinstall the seven or eight screws that hold the PC board. Then insert the switch into its hole and fasten it securely. Reattach the two cables from the top half of the case. The cable on the left, for the keyboard, is keyed and will install in only one direction. The polarity of the LED cable on the right does not matter. Place the hooks in their slots at the rear of the case and gently close it. If the case is slightly warped, you may have to press down on the rear to get the hooks to engage properly. After you've closed the case, examine it on all sides to be sure that it has no gaps. Turn it over and reinstall the

the Apple-IBM connection



Transfers any file back and forth!

Increase VisiCalc and Wordstar power by transferring files from the Apple II to the IBM Personal Computer—with no retyping and no errors!

CONNECT Apples to IBMs, Apples to Apples, or IBMs to IBMs. Transfer information from **any** file thousands of miles—in minutes.

UPGRADE your 64K Apple VisiCalc to 256K IBM VisiCalc power. Your worksheets can be larger.

INCREASE your Apple Wordstar 130K floppy capacity to IBM DOS Wordstar 320K floppy capacity. Over twice the space on disk.

CONTROL communication from either side in either direction with **Master/Slave** operation.

COMMUNICATE with people using the **Electronic Mail** mode. The Apple-IBM Connection can be used to send messages to Apples or IBMs.

Designed for the non-technical user, the Apple-IBM Connection comes with a disk for the Apple and a disk for the IBM. Connect the two computers with a cable or a telephone modem and insert the disks.

Turn on the computers and the software does all the work, asking you for the name of the file being transferred, the transfer speed, and the type of connection you are using.

Less than one minute after powering up, the transfer starts. The software checks to make sure that no errors occur during transmission.

Alpha Products for the IBM Personal Computer

All Alpha products come with **spoken instructions**. Alpha Software—professional, innovative, and easy to use.

**Data Base Manager Type Faces
Question Mailing List**

Call us for participating Computerlands and other dealers at (617) 229-2924.



REQUIREMENTS

Apple II—1 Disk, 64K Memory. D.C. Hayes Micro-modem II or Mountain Hardware CPS Card.

IBM P.C.—1 Disk, 96K (Compiled Version) or 64K (BASIC Version). Any RS-232 Card.

 **alpha**
SOFTWARE CORP

12 NEW ENGLAND EXECUTIVE PARK BURLINGTON, MASS. 01803

Circle 18 on Inquiry card.

**AVAILABLE
TODAY!**

\$195.00

Apple is a trademark of Apple Computer Company. IBM is a trademark of International Business Machines Corp.
VisiCalc is a trademark of VisiCorp. WordStar is a trademark of MicroPro Corp.

Listing 1: The Reset program, which will reset the first link field and end-of-program pointers. Starting at line 25, use the POKE command to enter the program.

```

0001 0000      ;
0002 0000      ;
0003 0000      ; PROGRAM TO RESTORE THE BASIC END
0004 0000      ; OF PROGRAM POINTER.
0005 0000      ;
0006 0000      ; CALL WITH SYS 828
0007 0000      ;
0008 0000      CHAIN  =#C533      ;VIC LINE LINK CALCULATOR
0009 0000      ;
0010 0000      ;      *=#33C      ;ASSEMBLE IN TAPE BUFFER

0011 033C 20 33 05      JSR CHAIN      ;FIND LAST LINK
0012 033F 18      CLC
0013 0340 A5 22      LDA #22      ;ADD TWO TO GET
0014 0342 69 02      ADC #2      ;END OF PROGRAM
0015 0344 85 2D      STA #2D      ;AND SAVE IN END POINTER
0016 0346 A5 23      LDA #23      ;ADD ZERO TO HI BYTE
0017 0348 69 00      ADC #0      ;IN CASE OF CARRY
0018 034A 85 2E      STA #2E      ;SAVE IT
0019 034C 60      RTS      ;RETURN TO VIC
0020 034D      ;
0021 034D      ;
0022 034D      ; POKE THE FOLLOWING DECIMAL VALUES INTO MEMORY
0023 034D      ; STARTING AT 828 TO USE THE PROGRAM
0024 034D      ;
0025 034D      ;POKE 828,32
0026 034D      ;POKE 829,51
0027 034D      ;POKE 830,197
0028 034D      ;POKE 831,24
0029 034D      ;POKE 832,165
0030 034D      ;POKE 833,34
0031 034D      ;POKE 834,105
0032 034D      ;POKE 835,2
0033 034D      ;POKE 836,133
0034 034D      ;POKE 837,45
0035 034D      ;POKE 838,165
0036 034D      ;POKE 839,35
0037 034D      ;POKE 840,105
0038 034D      ;POKE 841,0
0039 034D      ;POKE 842,133
0040 034D      ;POKE 843,46
0041 034D      ;POKE 844,96
0042 034D      ;
0043 034D      ; .END
0044 034D      ERRORS= 0000

```

three screws in the bottom. You now have a Reset switch for your VIC.

Memory Pointers

You can use the Reset switch to recover when Stop/Run and Restore have no effect. Reset does not erase a BASIC program, but it does change two pointers in memory that VIC needs to find the program. One of the pointers that is altered is the link field in the first line of the BASIC program. Each line of a VIC BASIC program has a pointer to the next line. Reset clears the link in the first line so that the VIC thinks there are no statements in memory. Reset also changes the pointer to the end of the program. Both of these pointers must be restored to their proper values for the VIC to recognize the program that is in memory.

The easiest way to restore these values is to use the PEEK command to examine them *before* you run the program and then write them down in case you need to use

Reset. Then after you reset you can use the POKE command to restore them and execute the BASIC CLR command to reset the other BASIC pointers. Of course, chances are that when you have to use Reset you will not have thought to do this. It's possible to find the correct values for these pointers after the VIC has been reset.

On a standard VIC the first link field is located at memory locations 4097 and 4098 (1001 and 1002 hexadecimal). It is a 2-byte pointer to the beginning of the second line of the program. The end-of-program pointer is at locations 45 and 46 (2D and 2E). Finding the end of the program involves following the chain of BASIC statement links to the end of the program. Fortunately, there's a machine-language subroutine in the VIC ROM that will reset the first link and find the end of the program. To help in executing this subroutine I wrote the Reset program shown in listing 1. The program calls the VIC ROM subroutine that recalculates the VIC statement links and leaves the last pointer in a temporary memory area. It

FRANKLIN'S BAKER'S DOZEN!



13 Good Reasons to Buy the **ACE1200**

1. **Apple® II-compatible**
2. **CP/M®-compatible**
3. **128K of RAM**
4. **Built-in floppy disk drive**
5. **Disk controller**
6. **80 column card**
7. **Serial interface**
8. **Parallel interface**
9. **Upper and lower case**
10. **VisiCalc® keys**
11. **Cursor control pad**
12. **Numeric pad**
13. **Auto repeat keys**

Extras can more than double the price of your personal computer. Not so with the Franklin ACE 1200. It's the professional computer system that includes the extras—and a long list of exclusive Franklin features that make it the most extraordinary value on the market today.

The ACE 1200 has everything you'll need to add a color or black and white monitor, modem, printer, back-up disk drive and other accessories. You can choose from the enormous selection of Apple programs and peripherals because the ACE 1200 is hardware- and software-compatible with

the Apple II. And, with the built-in CP/M card, you can run both Apple II and CP/M programs. Franklin's CP/M operates three times as fast as many competing systems, drastically reducing processing time for most business applications.

The Franklin ACE 1200—the most extraordinary value on the market today. Call or write today for the name of your local authorized Franklin dealer.

Franklin ACE is a trademark of Franklin Computer Corporation. Apple is a registered trademark of Apple Computer Inc. CP/M is a registered trademark of Digital Research Inc. VisiCalc is a registered trademark of Visi Corp.



7030 Colonial Highway, Pennsauken, NJ 08109 609-488-1700

BYTE's Bits

Public-Domain Apple Graphics Routines

One reason for the Apple II's popularity is the large amount of public-domain software available for it. Most public-domain software is rather modest stuff, but someone occasionally donates an impressive piece of software that is easily good enough to be sold commercially. Such a piece of software (obviously a labor of love that reflects much work and talent) is David Shapiro's Dr. Cat's Grafix Disk. This is an Apple II floppy disk running under the DOS 3.3 operating system that gives the user a 5K-byte package of high-resolution Apple graphics routines, the source code for the assembly-language routines (in Apple DOS Tool Kit format), some documentation, and a lot of enjoyable demonstration programs.

David sees Cat-Grafix, as he calls them, as an alternative to the high-resolution drawing routines provided by Applesoft. The package has 25 major routines, each of which can be called from BASIC or entered via an optional set of ampersand routines (e.g., &HIRES). The routines include both color and black-and-white versions of subroutines that plot points, draw lines, outline or fill boxes and circles, scroll the high-resolution screen, and draw characters from a user-defined character set onto the high-resolution screen.

The disk and associated software are in the public domain and can be used as part of another program (commercial or otherwise) if credit is given to Cat-Grafix. The disk is currently being distributed through Apple user groups and can be copied without limitation. If you cannot get this disk through these channels, it can be ordered from:

David Shapiro
Pepperland Software
POB 5158
Bloomington, IN 47401

Please send an Apple disk, a check for \$8, and a stamped, self-addressed return envelope with sufficient postage and cardboard protection for the disk.

I think that Cat-Grafix is one of the most impressive sets of graphics routines for the Apple that I have ever seen, and the price is certainly right. David is to be commended for his decision to give this software away. I hope that his efforts will persuade other hobbyists to share their work.

Gregg Williams
Senior Editor ■



With Pride

Professional involvement in the microcomputer industry. Our unique designer pieces are the perfect solution for gifts, awards, incentives, or premiums. As lapel pins, tie

brooch pins, they are available in 18K gold vermeil or sterling silver. Be identified as a micro professional! Order now by completing the coupon, or contact MC/N, Inc. Satisfaction is guaranteed, or your money back.

Actual size 1/2" square



MC/N, Inc.
COMPUTER JEWELRY
Simms Center/Box 9393
San Rafael, CA 94912
415/453-7033

- Dealer Inquiry
- Send info re: Corporate Volume Discounts
- Send info re: Custom 14K or 18K Gold—with or without Diamonds or Rubies

Please send the following pieces of computer jewelry:

Gold- Silver-
\$12. ea. \$10. ea. Amount

_____ \$ _____

_____ \$ _____

_____ \$ _____

_____ \$ _____

Handli _____

rs add _____

ax _____

MOUNT

ED _____ \$ _____

NAME/CO. _____

ADDRESS: _____

CITY: _____

STATE/ZIP: _____

TELEPHONE: _____

Visa _____ MasterCard _____ Expiration Date _____

Signature _____

Allow 2-3 Weeks for Delivery

PLATO WIDENS YOUR CHILD'S WORLD.

Announcing new educational courseware
for microcomputers to improve your child's
Basic Skills, High School Skills or Foreign Language vocabulary.



**NOW. PLATO Basic Skills.
NOW. PLATO High School Skills.
Both for use with TI 99/4A.***

Control Data and Texas Instruments are working together to make this nationally recognized PLATO courseware available via microcomputers.

Control Data's PLATO Basic Skills is a comprehensive curriculum designed to enhance the development of elementary and junior high Reading, Math and Grammar skills.

Control Data's PLATO High School Skills help high school level students master Reading, English, Math, Social Studies and Science. It has been used to assist students preparing for G.E.D. exams.

*For Basic and High School Skills pricing and order information, write: Texas Instruments, Education Department, Box 53, Lubbock, TX 79408.

NEW!* Nine lessons in Foreign Languages for use with Apple II Plus.

Three lessons each for French, Spanish and German. Each lesson uses a hangman or pyramid game to help children learn words most associated with defined activities. For junior or senior high students.

Travel Words: Children study French, Spanish or German words they need to know to buy train, plane or bus tickets; order in a restaurant; request medical assistance; read street signs; etc.

Shopping Words: Children study French, Spanish or German words they need to know to shop for food, clothing, etc.

Classroom Words: Children study the French, Spanish or

German words that are common to the school environment.

*Available March 30

Lessons Available For Apple II Plus, TI 99/4A and Atari 800.

Basic Number Facts: Practice in addition without carrying; subtraction without borrowing; and multiplication/division with single digits. For elementary students.

Whole Numbers: Practice in addition, subtraction, multiplication, division and mixed numbers. For elementary and junior high students.

Decimals: Practice locating decimal numbers on the number line. For elementary students.

Fractions: Same skill level and format as decimals.

Physics—Elementary Mechanics: Students are shown a physical problem, then must "purchase" the missing information to answer it correctly. For senior high physics students.

French, German, Spanish Vocabulary Builders: Gives children a basic vocabulary of 500 words. Supplements introductory and refresher courses.

Computer Literacy—Introduction: For jr. or sr. high and vocational school students.

INTRODUCTORY OFFERING:

- Single lesson, \$45.00
- Additional lessons, \$35.00 ea.
- Additional disk included with each lesson ordered at no extra charge
- 10 day money-back trial



SEND FOR PLATO COURSEWARE CATALOG

For a free copy of our PLATO catalog, or to order, mail reply card; call toll-free 800/233-3784; or write Control Data Publishing Co., P.O. Box 261127, San Diego, CA 92126. In California, call 800/233-3785.

Circle 121 on Inquiry card.

**CONTROL DATA
PUBLISHING**

PLATO[®]
COMPUTER-BASED EDUCATION

The World of Standards

*The process for producing standards
is full of checks and balances.*

As our civilization grows more complex, the need for standards increases at an amazing rate. Without thinking in terms of standards, we are accustomed to asking for a specific weight of oil for our car, film of varying speeds for our cameras, tires of a certain size, and certain kinds of electric light bulbs, electric sockets, extension cords, etc. Standards are vital to our daily lives. As consumers, we have become dependent upon standards and would not tolerate the inconvenience incurred by a lack of standards.

Standards are such an integral part of our daily lives that we are often oblivious to their existence and therefore do not always appreciate their value. As we understand the role played by standards in our daily lives, it becomes easier to understand why a need for standards arises. When this need in a particular area becomes acute, the next logical step is to convene a committee interested in the subject to develop a standard.

Standards organizations exist to provide a framework so that standards that represent a consensus can be developed and approved.

Much of this material has been adapted from The World of EDP Standards, 3rd edition, by R. D. Prigge, M. F. Hill, and J. L. Walkowicz. (Blue Bell, PA: Sperry Univac Corporation, 1978). Used by arrangement with Sperry Univac.

Chuck Card
2192 Buckboard Circle
Warrington, PA 18976

R. Donald Prigge
418 Sassanqua Dr.
Georgetown, SC 29440

Josephine L. Walkowicz
National Bureau of Standards
Building 225
Washington, DC 20234

Marjorie F. Hill
34 South Lanvale Ave.
Daytona Beach, FL 32014

History

In the early part of our century, the general need for standards was fairly widespread, and as a result, several organizations were founded to develop standards in a variety of areas. Therefore, when the first suggestions were made that standards should be established in the field of computers and information processing, there already existed mature and well-established organizations available to accept that responsibility. On the international scene, the International Organization for Standardization (ISO) authorized the formation of Technical Committee 97 (Computers and Information Processing) and Technical Committee 95 (Office Machines). These two committees have now merged into Technical Committee 97 (Information Pro-

cessing Systems). In the United States, the American National Standards Institute (ANSI) assigned to the Business Equipment Manufacturers Association (now the Computer and Business Equipment Manufacturers Association, or CBEMA) the responsibility for forming the corresponding American National Standards Committees X3 and X4, which have since merged into Committee X3 (Information Processing Systems). X3 now has responsibility for all of ANSI's computer-related standards (see figure 1 for a chart of the X3 organization).

Meanwhile in Europe, the European Computer Manufacturers Association (ECMA) was formed, and by mid-1961, the standardization effort for computers and information processing was well underway.

Objectives

While the names and relationships of these organizations can be confusing, the objectives of all the international and national standards bodies are so similar that they can be thought of as carbon copies of each other. Basically these objectives are development, promulgation, and establishment of standards; coordination of standards development; and exchange of information.

At the technical level the objective is the development of a standard for a specific product or process.

Here's what your IBM Personal Computer can do with Edix™ + Wordix™ (for only \$390.00!)

Emboldening

Right justification

Underlining

Labeled and automatically numbered lists

Automatic page and section numbers in headers and footers

Multi-line headers and footers

Automatic section numbering and table of contents

Automatic hyphenation

Subscripts, superscripts, and overstrikes

Automatic footnote placement

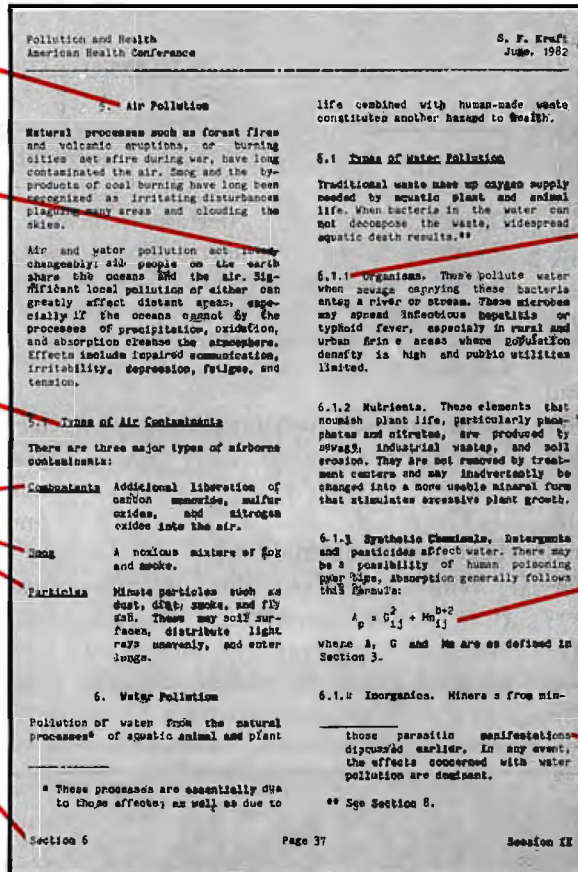

EDIX + WORDIX gives you maximum flexibility for creating your documents. Its unique multiple-window screen opens new horizons to your creativity. And EDIX is so easy to use most of our customers claim they never have to read the User's Manual!

Not only can EDIX + WORDIX do everything we've shown, but it can drive any printer, and access special symbols, too. These and other features make EDIX + WORDIX the World's Finest Microcomputer Word Processor!

EMERGING
TECHNOLOGY

2031 Broadway Boulder, Colorado 80302
303 447-9495

For more information or to place an order, call toll-free 800-782-4896





or see EDIX + WORDIX at
ComputerLand® and other fine computer stores

Dealer inquiries welcome

It takes just a toll-free phone call to join the growing group of satisfied EDIX + WORDIX users. Why not pick up your phone right now?

Requires 128K IBM PC with DOS. EDIX demo available for \$15.

TM Trademark of Emerging Technology Consultants, Inc.

Membership and Finance

The membership base of standards-making bodies varies somewhat, but in general, at the international level, the members represent nations. At the national level, individual members represent interests of consumers, producers, and general-interest groups.

Membership in standards organizations is restricted in the sense that each organization establishes categories and balance for membership but is open-ended in respect to the number of members. In the ISO, membership is restricted to the standards organization most representative of each nation. ANSI represents the United States in ISO, and therefore, no other standards organization based in the United States can hold membership. (Other standards organizations are subtly restrictive on the basis of technical interest, product produced, or similar categories.)

Although many international and national organizations derive their operating revenue from membership dues and the sale of standards, others are wholly or partially supported by their governments. Several national standards organizations have extended their activities to include a certification program, which contributes to their income. Most of the organizations important to computer stan-

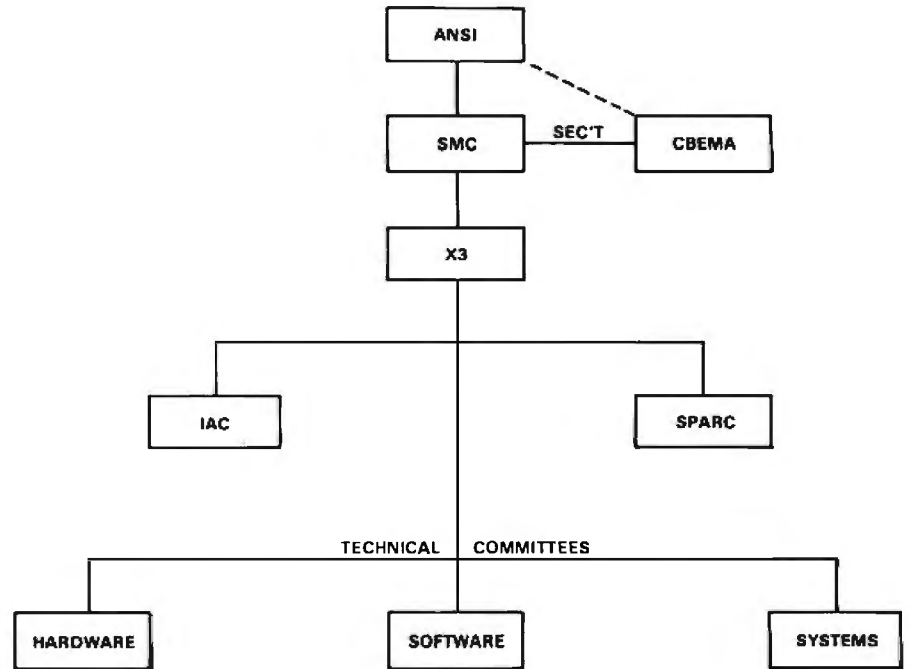

Figure 1: Structure of the American National Standards Committee X3 for Information Processing Systems. The abbreviations stand for the following: ANSI, American National Standards Institute; SMC, Standards Management Committee; CBEMA, Computer and Business Equipment Manufacturers Association (the secretariat to X3); IAC, International Advisory Council; and SPARC, Standards Planning and Requirements Committee.

dards are self-sustaining nonprofit organizations.

Technical Committees

Within a standardization organization, technical committees are chartered to develop standards in an assigned range of interest. Because this charter generally covers a broad

technical area, a technical committee may work simultaneously on several overlapping or independent technical areas within its assigned responsibility. A technical committee may also need to establish liaisons with technical committees of other standards organizations or within the same parent organization.

Most technical committees have an

Digital Dialing Units For Your Acoustic Coupler



Unit #1: the index finger of your right hand, used to manually dial a telephone number and place the telephone handset in the coupler's cradle.

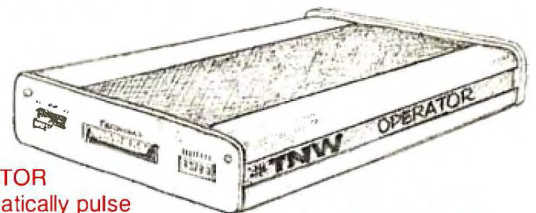

Unit #2: TNW's new OPERATOR Automatic Calling Unit, automatically pulse dials under computer or terminal control. Also provides unattended telephone answer capability. Use it with your acoustic coupler or most direct connect modems. 110 to 300 bits per second, powerful command interpreter, RS-232 interface to computer or terminal. Complete with power supply, cabinet, documentation, and full one year warranty for only \$129.



TNW
CORPORATION

Dept. 9876

3444 Hancock Street, San Diego, CA 92110
(619) 296-2115 • Telex 910-335-1194



computers wholesale

315-472-3055
Box 91 Brewerton, N.Y. 13029

Circle 112 on Inquiry card.

**We pay UPS shipping charges
on prepaid orders.**

-SYSTEMS-

ALDOS.....	20% OFF LIST
ACS-8000-2.....	\$2649
ACS-8000-10.....	6195
ACS-8000-12.....	7189
ACS-8000-14.....	8790
ACS-8000-15.....	3739
MTU-1.....	2000
MTU-2.....	2000
Series 5-15D.....	2285
Series 5-5D.....	4275

ATARI

800 (48K).....	\$659
400 (16K).....	259
810 Disk Drive.....	449
850 Interface.....	169

CROMEMCO

CS-0.....	\$1035
CS-1.....	3195
CS-1H.....	5595
CS-2.....	3755
CS-3.....	5595
ZPU.....	315
64KZ.....	585
TuArt.....	249
16FDC.....	475

The complete CROMEMCO line is available.

INTERTEC

Superbrain II Jr.....	\$1969
Superbrain II QD.....	2349
Superbrain II SD.....	2650

MORROW DESIGN

Decision I.....	\$1335
Micro Decision w/Terminal	
1 Drive.....	Call
2 Drives.....	Call
Discus 2D.....	830
Dual Discus 2D.....	1385

Call us for prices on the full MORROW line.

NORTHSTAR

Advantage.....	\$2895
Horizon 20-64K.....	2655
HD 18 Mg. Disk.....	3879
G CP/M® for Advantage.....	119

We carry the complete NorthStar line—Call!

TELEVIDEO

TS-801.....	\$2650
802.....	2755
802H.....	4755

ZENITH

Z-89-80 CP/M® or H/DOS.....	\$2075
Z-89-82 CP/M® or H/DOS.....	2115
Z-90-80 CP/M® or H/DOS.....	2115
Z-90-82 CP/M® or H/DOS.....	2299

Advertised prices reflect a cash discount on prepaid orders only. Most items are in stock for immediate delivery in factory sealed cartons with full factory warranties.

-TERMINALS-

ADDS

Viewpoint.....	\$529
----------------	-------

HAZELTINE

Esprit.....	429
Esprit II.....	515
Esprit III.....	1350
1420.....	589
1500.....	845
1520.....	1350
Executive 80-20.....	Save! 975

INTERTEC

Intertube III.....	725
--------------------	-----

SOROC

.....	Call!
-------	-------

TELEVIDEO

910.....	\$559
912.....	659
920.....	719
925.....	719
950.....	899
X-tra Page Memory.....	80

WYSE-100

.....	749
-------	-----

ZENITH

Z-19.....	639
ZT-1.....	549

-PRINTERS-

ANADEX

DP9500.....	\$1290
2K Buffer.....	80
9501.....	1290
9620.....	1475

CENTRONICS

704-9 Ser.....	\$1519
704-11 Par.....	1569
730-1 Ser.....	Save! 299
730-3 Ser.....	479
737-1 Par.....	689

C.I.TOH

Prowriter 8510A Par.....	\$425
Prowriter 8510A Ser.....	595
Starwriter F10 Par.....	1370
Starwriter F10 Ser.....	1370
Printmaster F10 Par.....	1785
Printmaster F10 Ser.....	1785
C.I.TOH Starwriter F10-Tractor.....	200
Prowriter II.....	Call

DIABLO

620 RO 25CPS.....	\$1275
630 RO 40CPS.....	1949
Tractor.....	275

EPSON

MX-80.....	\$440
MX-80FT.....	520
MX-100.....	715
Serial RS232 w/2K.....	120

INTEGRAL DATA SYSTEMS

Prism 80 Basic.....	\$750
Prism 132 Basic.....	1075
Prism 80 Package.....	1299
Prism 132 Package.....	1465
Prism 80 All but color.....	1065
Prism 132 All but color.....	1260
Paper Tiger 445G.....	599
Micro Prism.....	639

NEC

3510.....	\$1515
3515.....	1540
3530.....	1650
7710.....	2295
7715.....	2395
8023.....	465

OKIDATA

80.....	\$300
82A.....	395
83A.....	639
84S.....	989
84P.....	989
Tractor for 80/82A.....	50

SMITH-CORONA TP-1.....

.....	Call
-------	------

TEXAS INSTRUMENTS

TI-810 Basic.....	\$1289
TI-810 VCO/Full.....	1549
TI-820 RO Basic.....	1545
TI-820 KSR Package.....	1739

-MONITORS-

AMDEK

100G.....	141
Color I.....	310
Color II.....	649
Color III.....	419
300G.....	149

BMC

Green Phos.....	\$99
-----------------	------

SANYO

9" Green Phos.....	\$159
12" Green Phos.....	209
13" Color.....	439

ZENITH

Z-121.....	115
------------	-----

-HARD DISKS-

CORVUS

5MB.....	\$2555
10MB.....	3995
20MB.....	4795

*Please specify what type of computer used

Mirror Backup.....	629
--------------------	-----

MAEZON

5Mg.....	\$2235
10 Mg.....	2760
15 Mg.....	3020
CP/M®-s 100.....	75

-MODEMS-

HAYES

Micro Modem 100.....	279
Micro Modem II.....	279
Smartmodem 300.....	215
Smartmodem 1200.....	520
Chronograph.....	199

NOVATION

4102D 300/1200.....	\$269
D-Cat.....	145
Apple Cat II.....	310
Nov-212 1200 Baud.....	549

-SOFTWARE-

ASHTON-TATE

D Base II.....	\$593
----------------	-------

COMPU-View

V-Edit.....	125
-------------	-----

MICROAP

Select III.....	165
Select IV.....	245
Select V.....	465
Glector.....	245

MICAH

CP/M® 2.X.....	225
Expand.....	85

MICROPRO

Supersort I.....	165
Supersort II.....	155
WordStar.....	295
Mailmerge.....	115
DataStar.....	245
CalcStar.....	225

MICROSOFT

Z-80 Soft Card.....	295
Apple 16K RAM Card.....	165
Edit 80.....	85
Macro 80.....	165
Basic 80.....	275
Bascom.....	305
Fortran 80.....	335
Cobol 80.....	565
Softcard Premium Pack.....	625

MICRO TECH.....

.....	CALL
-------	------

OSBORNE

Business Pack.....	285
General Ledger.....	59
Payroll, Cost Accounting.....	59

Accs Payable/Accs. Receivable.....	59
------------------------------------	----

SORCIM

Supercalc.....	225
----------------	-----

BLANK DISKS—Call for prices

—MEMOREX, MAXELL,

SCOTCH, VERBATIM—

If you can't find what you need listed here, just call for the best prices on the items you require.

N.Y. residents, add appropriate sales tax. Shipping is not included (unless otherwise stated). C.O.D.s require a 25% deposit. All prices and offers may be changed or withdrawn without notice.

ISO/TC 97 MEMBER COUNTRIES

ISO	FUNCTION	Australia	Austria	Belgium	Brazil	Canada	Chile	Cuba	Czechoslovakia	Denmark	Ethiopia	Finland	France	Germany	Greece	Hungary	India	Iran	Ireland	Israel	Italy	Japan	Korea	Netherlands	New Zealand	Norway	Pakistan	Poland	Portugal	Romania	Russia	South Africa	Spain	Sweden	Switzerland	Tanzania	Turkey	United Kingdom	USA	USSR	Venezuela	Yugoslavia
TC97	PLENARY	O	O	P	O	P	O	P	O	P	P	P	O	P	O	P	P	P	O	P	P	O	P	P	P	O	P	O	P	O	P	O	P	P	P	O	O	P	P	P	O	O
SC1	VOCABULARY	O	O	P	O	P	P	O	O	P	P	P	O	O	O	O	P	O	P	O	P	O	P	O	O	O	P	O	O	P	O	P	P	O	O	O	P	P	P	O	O	
SC2	CHARACTER SETS	O	O	P	O	O	P	P	O	O	P	P	O	O	O	P	P	O	P	P	P	O	P	O	O	O	P	O	O	P	O	P	P	O	O	O	O	P	P	O	O	
SC5	PROG. LANGUAGES	P	P	P	O	P	P	O	O	P	P	P	P	O	O	P	O	P	P	P	P	P	P	P	P	O	P	O	P	O	P	P	P	O	O	O	P	P	O	O		
SC6	DATA COMMUNICATIONS	U	O	P	O	P	P	O	P	P	P	P	O	P	O	P	O	P	P	P	P	O	P	O	O	O	P	O	O	P	O	P	P	O	O	O	O	O	P	P	O	
SC7	DOCUMENTATION	O	O	P	O	P	O	O	P	O	P	P	O	U	O	O	O	O	P	P	P	O	O	O	O	P	O	O	P	O	P	P	O	O	O	P	O	O	O	O	O	
SC8	NUMERICAL CONTROL	O	O	P	O	O	O	O	O	O	P	P	O	O	O	O	O	O	P	P	O	O	P	O	O	P	O	O	P	O	P	P	P	P	O	O	O	P	P	O	O	
SC9	PL/NUMERICAL CONTROL	O	O	P	O	O	O	O	O	O	P	P	O	O	O	O	O	O	P	P	O	O	O	O	O	O	O	P	O	P	O	P	O	O	O	O	O	P	P	P	O	
SC10	MAGNETIC DISKS	O	O	O	P	O	P	P	O	P	P	P	O	O	O	O	O	O	P	P	P	O	O	O	O	O	O	O	O	O	O	O	O	O	O	O	P	O	O	O	O	
SC11	FLEXIBLE MAG. MEDIA	O	O	O	O	O	O	P	O	O	P	P	O	O	O	O	O	O	P	P	P	O	O	P	O	P	O	O	O	O	O	O	O	O	O	O	P	P	P	O	O	
SC12	INSTRUMENTATION TAPE	O	O	O	O	O	O	O	O	P	P	O	O	O	O	O	O	O	P	O	O	O	O	O	O	O	O	O	O	O	O	O	O	O	O	O	O	P	P	P	O	
SC13	INTERCONNECTION	O	O	O	O	O	O	P	O	O	P	P	O	U	O	O	O	P	P	P	O	O	O	O	O	O	O	O	O	O	O	O	O	O	O	O	O	O	P	P	P	O
SC14	DATA ELEMENTS	O	O	P	O	P	O	O	O	O	P	P	O	O	O	O	O	P	P	O	O	O	P	O	O	O	O	O	O	O	O	O	O	O	O	O	P	P	O	O	O	
SC15	LABELLING	O	O	O	O	O	O	O	O	O	O	P	O	O	O	O	O	O	P	P	P	P	O	O	O	O	O	O	O	O	O	O	O	O	O	O	O	O	P	P	O	O
SC16	OPEN SYSTEMS	P	P	P	O	P	O	P	P	P	P	P	P	O	O	O	P	P	P	P	P	P	P	P	P	P	O	P	O	P	O	O	O	O	O	O	O	P	P	P	O	
SC17	IO/CREDIT CARDS	P	P	P	O	P	O	O	O	P	P	P	O	O	O	O	O	O	P	P	O	O	O	O	O	O	O	O	O	O	O	O	O	O	O	O	O	O	P	P	O	O
SC18	TEXT PREP. & INTERCHANGE	O	O	O	O	O	O	O	O	P	P	P	P	O	O	O	O	O	O	P	P	P	P	O	O	O	O	O	O	O	O	O	O	O	O	O	O	O	O	P	P	O
SC19	OFFICE EO. & SUPPLIES	O	O	O	O	O	O	O	O	P	P	P	O	O	O	O	O	O	P	P	P	O	O	O	O	O	O	O	O	O	O	O	O	O	O	O	O	O	O	P	P	O

NOTE: All data as of 02/06/15

P-PRINCIPAL

O-OBSERVER

P*-SECRETARIAT

Figure 2: The ISO/TC 97 is the technical committee for information systems. The member countries belong to one or more of the various standards committees (SC) under the technical committee. Each member country has the option of participating in a principal or an observer role. Additionally, some members may serve as secretariat of a standards committee.

organizational structure similar to that of the parent organization and have a quota of administrative and advisory groups to supervise the progress of the technical work.

Most of the developed countries take an active part in the development of standards. Some elect to monitor the international development work, which is then evaluated in terms of their national requirements. Australia and Denmark are examples of this type of participation. It is also common practice for some national organizations to adopt the International Standards developed by the ISO Technical Committees (see figure 2 for a list of the member countries in ISO Technical Committee 97).

Development of a Standard

Standards development is based upon cooperation and consensus of the parties involved regarding technical content. This may require many changes in wording to effect a com-

promise, as well as many material additions or deletions. The ultimate objective is to produce a standard for which consensus can be achieved.

The philosophy of consensus imposes a responsibility upon the organizations within which standards can be initiated, developed, and approved: the organizations must develop a process, methods, and operating procedures that will guarantee that a consensus has been reached.

In the United States, ANSI recognizes only three methods for the development of evidence of consensus for approval of American National Standards: the Accredited-Organization Method, the Canvass Method, and the Standards-Committee Method. All methods have the same objective, i.e., to develop evidence of consensus of interested parties for approval of a proposed standard. Any individual or any organization may propose a standard

for approval and, in so doing, may specify any one of the three methods.

Accredited-Organization Method

Any organization involved in standards work may seek accreditation from ANSI. As an accredited organization, it may submit proposed American National Standards to ANSI for approval.

To be accredited, an organization must have a procedure for development of consensus comparable to that required under the Standards Committee Method.

When the proposed standard has been approved within the accredited organization, it is sent to ANSI for approval as an American National Standard.

Canvass Method

When a standards-making organization or any other responsible organization has existing or draft standards it wants to have considered

PGS**Princeton
Graphic Systems**

High Resolution RGB Color Monitor Designed for the IBM Personal Computer

FEATURES

- 80 characters x 25 lines
- 690 dots horizontal resolution
- 16 colors
- .31 mm dot pitch tube
- non-glare, black matrix
- plugs directly to IBM PC

\$795

Princeton Graphic Systems' new HX-12 high resolution color monitor is designed with an NEC .31 mm dot pitch CRT to give you up to 690 dots horizontal resolution. You need not compromise the display quality of your system with monitors rated at less than the 640 horizontal dots generated by your IBM PC. The PGS HX-12 delivers 16 supercolors, 80 characters x 25 lines. It is the best priced performance PC direct drive monitor in the market today. Get the PGS HX-12 and discover for yourself how well it complements your IBM Personal Computer.

PGS**Princeton
Graphic Systems**

The Choice of

Computer Exchange — The Supply Center for the IBM-PC

SOFTWARE for the IBM-PC

BUSINESS

	LIST PRICE	OUR PRICE
ASHTON-TATE, dBase II, requires CP/M-86 & 128K	\$ 700	\$ 449
dBase II, requires PC-DOS & 128K	\$ 700	\$ 449
APPLIED SOFTWARE TECHNOLOGY, Versafarm	NEW! \$ 389	\$ 265
DATAMOST, Real Estate Investment Program	NEW! \$ 150	\$ 89
Write-On	\$ 130	\$ 89
DENVER SOFTWARE, Easy (Executive Accounting System)	\$ 750	\$ 545
EAGLE SOFTWARE, Money Decisions	NEW! \$ 150	\$ 129
HOWARDSTOFT, Real Estate Analyzer	\$ 250	\$ 189
INFORMATION UNLIMITED, Easywriter II (a WPS)	\$ 350	\$ 259
EasySpell (88K Words)	\$ 175	\$ 129
EasyWriter (a DBMS)	\$ 400	\$ 299
Easy Planner	\$ 250	\$ 189
INNOVATIVE SOFTWARE, T I M III (a DBMS)	\$ 495	\$ 369
INSOFT, Data Design (a powerful easy to use DBMS)	NEW! \$ 225	\$ 169
ISA, Spell Guard	\$ 295	\$ 220
ISM, MatheMagic	\$ 90	\$ 69
Graphmagic	NEW! \$ 90	\$ 65
Math/Graphmagic Combo	NEW! \$ 160	\$ 109
LEXISOFT, Spellbinder (a versatile WPS in CP/M-86)	\$ 495	\$ 249
MICROCRRAFT, Requires CP/M-86 & CBASIC-86	\$ 750	\$ 395
Legal Billing & Time Billing	\$ 750	\$ 395
Professional Billing & Time Keeping — Billkeeper	\$ 250	\$ 189
MICRO LAB, The Tax Manager	\$ 495	\$ 349
MICROPRO, WordStar® plus free WordStar Training Manual	\$ 250	\$ 179
MailMerge™	\$ 250	\$ 179
SpellStar™	\$ 250	\$ 179
3 Pak, Word & Mail & Spell, above 3	\$ 845	\$ 445
MICROSOFT, Flight Simulator (by Sub-Logic)	NEW! \$ 50	\$ 35
NORELL, Visualize	\$ 250	\$ 179
Easy Data DBMS	\$ 250	\$ 169
NORTH AMERICAN BUS. SYSTEM, The Answer	\$ 145	\$ 99
PBL CORPORATION, Personal Investor	NEW! \$ 595	\$ 395
PEACHTREE, Peach Pak 4 (GL, AR & AP)	\$ 389	\$ 229
PERFECT SOFTWARE, Perfect Writer™	\$ 189	\$ 119
Perfect Speller™	\$ 289	\$ 179
Perfect Filer™	\$ 595	\$ 339
SELECT INFO, Select (a WPS)	\$ 295	\$ 199
SORCIM/ISA, SuperCalc	\$ 395	\$ 269
SuperWriter	\$ 250	\$ 169
SYNERGISTIC, Data Reporter	NEW! \$ 250	\$ 179
VISICORP, VisiCalc®/256K	\$ 250	\$ 199
VisiDex or VisiSchedule, each	\$ 300	\$ 219
VisiTrend/Plot	\$ 300	\$ 239
VisiFile or Desktop Plan I, each	\$ 100	\$ 75
Business Forecasting Model		

UTILITY

CENTRAL POINT, Copy II PC, bit copier & utilities	NEW! \$ 40	\$ 35
NAGY SYSTEM, Copy/PC, Backup Copier and Utilities	\$ 35	\$ 29
NORELL DATA, System Backup, Bit Copier	\$ 50	\$ 35
NORTON, Norton Utilities, 14 powerful programs, 3 disks	\$ 80	\$ 65

HOME & EDUCATIONAL

ACORN, Lost Colony	\$ 30	\$ 21
AUTOMATED SIMULATIONS, Temple of Apshai	\$ 40	\$ 29
Oil Barons	NEW! \$ 100	\$ 75
BRODERBUND, Apple Panic	\$ 30	\$ 22
CONTINENTAL, The Home Accountant Plus	\$ 150	\$ 112
DATAMOST, Pig Pen	\$ 30	\$ 22
Space Strike	\$ 30	\$ 22
DAVIDSON, The Speed Reader	\$ 75	\$ 55
INFOCOM, Deadline	\$ 50	\$ 39
Zork I or Zork II or Zork III, each	\$ 40	\$ 29
Golf Challenge	NEW! \$ 35	\$ 29
Ulysses & The Golden Fleece	\$ 35	\$ 25
PBL CORP., Personal Investor	\$ 145	\$ 99
SENTIENT, Cyborg	NEW! \$ 35	\$ 25
SIRIUS, Conquest or Call to Arms	\$ 30	\$ 23
SPINNAKER, Snapper Troops, #1 or #2, each	\$ 45	\$ 35
Story Machine or Face Maker	\$ 35	\$ 25
STRATEGIC, The War Factor	\$ 40	\$ 30
VERSA COMPUTING, Graphics Hardcopy System	\$ 25	\$ 19

DISKETTES

Control Data Corporation 12 for 10 Special. Limited Time!

CDC, 120 each, 5 1/4" with ring, SS, SD (Apple IBM, etc.)	\$ 450	\$ 195
12 each, 5 1/4" with ring, SS, DD (Apple, IBM, etc.)	\$ 40	\$ 22
12 each, 5 1/4" with ring, SS, SD (H/P, IBM 320K, etc.)	\$ 51	\$ 28
12 each 8", SS, SD	\$ 51	\$ 28
10 each, 5 1/4" with ring, OS, DD (IBM)	\$ 50	\$ 39
IBM, 10 each, 5 1/4" SS, SD (Apple, IBM, etc.)	\$ 60	\$ 45
10 each, 5 1/4" SS, DD (H/P, IBM 320K, etc.)	\$ 65	\$ 49
VERBATIM, 10 each 5 1/4" with ring, SS, SD or SS, DD	\$ 55	\$ 38
MAXELL, 10 each, 5 1/4", SS, SD	\$ 55	\$ 35
DYSAN, 10 each, 5 1/4", SS, SD	\$ 55	\$ 35
10 each, 5, OS, DD	\$ 65	\$ 49

★ Means a BEST buy.

AD #959

Hot Line For Information On Your Order (503) 772-3803



64K IBM-PC \$2850

IBM is a trademark of IBM Corporation.

System Includes
Two Disk Drives
12" Green Monitor
Monitor Not As Shown
90 Day Warranty



HARDWARE for the IBM-PC

	LIST PRICE	OUR PRICE
MEMORY CHIP KITS, 64K add-on to your memory cards. 9 chips, 200NS, tested and burned-in, 90 day warranty	\$ 150	\$ 69
Combo Plus, 64K with async. port.	\$ 495	\$ 359
Combo Plus, 64K with parallel port	\$ 495	\$ 359
Combo Plus, 64K w/async. & para.	\$ 555	\$ 395
Combo Plus, 64K w/async. para & clock/cal.	\$ 595	\$ 429
For above Combo Plus of 128K add \$85, for 192K add \$192, for 256K add \$256		

BUY VALUE OF THE YEAR:
COMEX 64K RAM Card, (192K when full) + 2 year warranty \$ 395 \$ 249
192K RAM Card + 2 year warranty \$ 675 \$ 449
CURTIS, PC Pedestal™ for display on PC \$ 80 \$ 65
9 Foot Cable for IBM Keyboard (extends 3' to 9') \$ 50 \$ 45

DAVONG OSI 501 Hard Disk, 5 Meg \$1995 \$1495
MAYNARD, Floppy Drive Control Board \$ 195 \$ 165
MICROSOFT 64K RAM Card w/Parity \$ 350 \$ 259
128K RAM Card w/Parity \$ 525 \$ 395
256K RAM Card w/Parity \$ 875 \$ 659
64K RAM Chips™ \$ 175 \$ 129

Tecmar Inc. AllInOne Board, 64K \$ 565 \$ 415
128K \$ 735 \$ 535
256K \$ 975 \$ 675

QUADRAM CORPORATION
Quadboard, 64K, expandable to 256K, 4 function board \$ 595 \$ 435
Quadboard, 128K, expandable to 256K, 4 function board \$ 775 \$ 585
Quadboard, 192K, expandable to 256K, 4 function board \$ 895 \$ 635
Quadboard, 256K, 4 function board \$ 995 \$ 670

Microfazer, Snap-on, BK, Par/Par, Epson, #MEB, w/PSI \$ 159 \$ 145
Microfazer, Snap-on, 64K, Par/Par, Epson, #ME64, w/PSI \$ 299 \$ 235
Power Supply for Microfazer, (9V, 25A), #PSI \$ 20 \$ 15
TG PRODUCTS, Joystick \$ 65 \$ 49

XEDEX gaby glue 64K plus CP/M-80 operation \$ 600 \$ 449

Control Data or Tandon
DISK DRIVES, Double Sided 320K. Same as now supplied with IBM-PC. Tested, burned-in and with installation instructions. 90 day warranty by us. 1 each \$ 595 \$ 249
2 or more \$ 595 \$ 239

PRINTERS AND ACCESSORIES

EPSON. See Epson section below		
NEC, Dot Matrix, 8023 Printer F/T	\$ 695	\$ 525
STAR MICRONICS, 9x9 Dot Matrix, 100cps, 2.3K, Gemini 10"	\$ 499	\$ 385
9x9 Dot Matrix, 100cps, 2.3K, Gemini 15"	\$ 649	\$ 495
APPLE COMPUTER, INC., Silentype Printer for Apple II	\$ 395	\$ 335
IDS, Micropism 480, near letter quality, 118cps, 80 col.	\$ 799	\$ 699
Pisim 80 Color, 200cps (all options-color, spnt, auto)	\$ 1795	\$ 1450
Paper Tiper, 440 w/Graphics and 2K Limited Special	\$ 1295	\$ 495
LETTER QUALITY — DAISY WHEEL PRINTERS:		
OLYMPIA, ES-100, Printer/Typewriter, complete with all interfacing to the Apple II	\$ 1735	\$ 1295
COMREX, Comiter CR-1, RS232 Serial I/F, 200 wpm	\$ 1199	\$ 845
Comiter Tractor Feed for CR1	\$ 118	\$ 99
SUPPLIES: Tractor Feed Paper, Ribbons, Heads, Qume Daisy Wheels & Ribbons.		

EPSON PRINTERS & ACCESSORIES

★ MX80 F/T III, with Galratrax	\$ 745	\$ 525
MX100 F/T III, with Galratrax	\$ 995	\$ 695
IBM PC to Epson Cable	\$ 60	\$ 45
Apple Interface and Cable for MX80 or MX100	\$ 95	\$ 59
Grappler™ by Orange Micro, specialty printer	\$ 165	\$ 119
Apple Graphics Dump	\$ 15	\$ 9
Atari to Epson Cable	\$ 40	\$ 30
Other cables, interfaces, ribbons, heads and paper in stock. Call		

ORDERING INFORMATION AND TERMS:

All mail to P.O. Box 1380, Jacksonville, OR 97530.
All items usually in stock. We immediately honor Cashiers Checks, Money Orders, Fortune 1000 Checks and Government Checks. Personal or Company Checks allow 20 days to clear. No C.O.D. Add 3% for VISA or MC. Include telephone number. Add 3% for shipping, insurance and handling (\$ 18) with \$ 5 minimum. UPS ground standard to add 3% more for UPS Blue with \$ 10 minimum. Add 12% total for S&H for US Postal, APD or PFD with \$ 15 minimum. For Hawaii, Alaska and Canada. UPS is in some areas only; all others are Postal so call, write, or specify P.O. Foreign orders except Canada for S&H add 18% or \$ 25 minimum except for monitors add 30% or \$ 50 minimum. Prices subject to change and typo errors so call to verify. All goods are new, include factory warranty and are guaranteed to work. Due to our low prices, all sales are final. Call before returning goods for repair or replacement. Orders received with insufficient S&H charges will be refunded. ORDER DISK HOURS 8 to 6 PST M-F and 10 to 4 Sat. 1 PM here is 4 PM in NY

OUR REFERENCES: We have been a computer dealer since 1978 and in mail order since 1980. Banks: First Interstate Bank, (503) 776-5620 and a Jefferson State Bank, (503) 772-5333. We belong to the Chamber of Commerce, (503) 772-6293, call Dun & Bradstreet if you are a subscriber. Computer Exchange is a division of U-Teck Group, Inc.

8" CP/M-80 BUSINESS & SYSTEM SOFTWARE

	LIST PRICE	OUR PRICE
★ ASHTON-TATE dBase II	\$ 700	\$ 419
COMSHARE TARGET, Target Planner Calc	\$ 99	\$ 39
Masterplan	\$ 325	\$ 225
PlannerCalc Applications Pkg.	\$ 50	\$ 40
PlannerCalc Combo Pkg.	\$ 125	\$ 65
INFOCOM, Deadline	\$ 60	\$ 45
Zork I or Zork II or Zork III or Starcross, each	\$ 50	\$ 39
ISM, MatheMagic	\$ 100	\$ 75
MICROCRRAFT, Legal Billing & Time Keeping	\$ 750	\$ 395
Prof. Billing & Time Keeping — Billkeeper	\$ 595	\$ 395
★ MICROPRO, WordStar® plus free WordStar Training Manual	\$ 495	\$ 249
MailMerge™	\$ 250	\$ 79
SpellStar™	\$ 250	\$ 129
3 Pak, Word & Mail & Spell, 3 above	\$ 845	\$ 395
SuperSort	\$ 250	\$ 169
DataStar	\$ 295	\$ 199
CalcStar	\$ 145	\$ 99
Multiplan	\$ 275	\$ 199
Fortran 80	\$ 500	\$ 325
BASIC Compiler	\$ 395	\$ 295
COBOL 80	\$ 750	\$ 545
BASIC-80	\$ 350	\$ 275
multi/muStar-80	\$ 200	\$ 145
M-Sort-80	\$ 195	\$ 145
Edit-80	\$ 120	\$ 80
Macro-80	\$ 200	\$ 145
OASIS, The Word Plus (45,000 word verification)	\$ 150	\$ 100
PEACHTREE, Magic Wand	\$ 500	\$ 385
Series 4 GL, AR, AP or Inventory, each	\$ 600	\$ 395
Series 8 GL, AR, AP, Inv. or Pay, each	\$ 750	\$ 495
Series 9 Search Text	\$ 500	\$ 330
Series 9 Spelling Proofreader	\$ 300	\$ 195
Series 9 Calc, Mail List or Telecom., each	\$ 375	\$ 245
PERFECT SOFTWARE, Perfect Writer™	\$ 389	\$ 239
Perfect Speller™	\$ 189	\$ 119
Perfect Filer	\$ 289	\$ 179

MONITORS

NEC, 12" Green	\$ 249	\$ 159
12" Color, Composite	\$ 450	\$ 349
SANYO, 9" B&W	\$ 190	\$ 149
9" Green	\$ 200	\$ 139
12" Green	\$ 260	\$ 199
13" Color, Composite	\$ 470	\$ 349
13" Color RGB	\$ 995	\$ 795
ZENITH, 12" Green	\$ 150	\$ 119
AMDEK, 12" Green #300	\$ 200	\$ 159
13" Color I, Composite	\$ 449	\$ 359
13" Color II, RGB, Hi Res. (Ap. II, III & IBM-PC)	\$ 899	\$ 799
13" Color III, RGB, Commercial, (Ap. II, III)	\$ 569	\$ 469
DVM, Color II or III to Apple II Interface	\$ 199	\$ 175
Note: Color II and III come with cable for IBM-PC.		

MODEMS AND TELE COMMUNICATIONS TERMINAL

HAYES, Micromodem II (for the Apple II)	\$ 379	\$ 279
Apple Terminal Program for Micromodem II	\$ 99	\$ 65
NOVATION, Applenet II Modem	\$ 389	\$ 269
212 Apple Cat	\$ 725	\$ 599
HAYES, Stock Chronograph (RS-232)	\$ 249	\$ 189
Stock Smartmodem (RS-232)	\$ 289	\$ 225
Smartmodem 1200 (RS-232)	\$ 699	\$ 535
Micromodem 1000 (S-100 bus)	\$ 399	\$ 275
Micromodem 1200 (RS-232)	\$ 99	\$ 79
IBM-PC to Modem Cable	\$ 39	\$ 25
AXLON, Datalink 1000 Hand Held Communications Terminal	\$ 399	\$ 325

★ ★ CORVUS SYSTEMS

★ 6 Meg Hard Disk, w/o interface	\$ 2995	\$ 2095
★ 11 Meg Hard Disk, w/o interface	\$ 4795	\$ 2695
20 Meg Hard Disk, w/o interface	\$ 5795	\$ 3495
IBM PC Interface (IBM DOS), Manual & Cable 5	\$ 300	\$ 239
Mirror built in for easy backup	\$ 790	\$ 595
Apple Interface, Manual & Cable 5	\$ 300	\$ 239
Omni Disk Server for Apple II	(Special) \$ 990	\$ 495
Omni Transporter Card Apple II	(Special) \$ 495	\$ 275
Omni Junction Box Set	(Special) \$ 39	\$ 25
Other Interfaces, Omni-Net, Constellation, Mirror, All in Stock.		

HP 7470A Graphics Plotter	\$ 1550	\$ 1195
HP 41C Calculator	\$ 195	\$ 149
HP 41CV Calculator with 2.2K Memory	\$ 275	\$ 219
Full 41 accessory software in stock. Call.		

Portland, OR. Cash & Carry Outlet, 11507-D SW Pacific Hwy., Tarrance Shopping Center, Tigard, OR. Over-the-counter sales only. Open 9:00 between Rts. 217 and Interstate 5, Open M-F 10-6, Sat. 10-8, Call 245-1020.

Professionals

LOW PRICES TO PROFESSIONALS WHO KNOW WHAT THEY WANT AND KNOW HOW TO USE IT.

Manufactured Exclusively for Bell & Howell by Apple computer

CALL US ON THE APPLE IIE

	LIST PRICE	OUR PRICE
B&H APPLE II+		
64K (48K + OUR 16K CARD)	\$1725	\$1150
Disk, MicroSci A2 w/3.3 Controller	\$579	\$378
Disk, Micro Sci A2 Only	\$479	\$299



The B&H Apple II+ differs from the Apple II+ only in that it is in black hammertone color and its warranty is longer. Warranty: Factory warranty is by Bell and Howell (not by Apple) and is one year parts plus 90 day labor. Warranty service available at Bell and Howell service centers or return to Computer Exchange.

B & H APPLE II+ 64K STARTER SYSTEM

- SPECIAL**
- \$1,595**
SAVE \$ 834
- 48K B&H APPLE II+
 - OUR 16K RAM Card, 2 Year Warranty
 - Micro Sci A2 Disk Drive with 3.3 Controller
 - Central Point Filer, Apple II+ 3.3 DOS plus many utility programs.
 - Sanyo 9" Green Monitor
 - RF Modulator (for color TV)
 - Game Paddles
 - Game with Color Graphics and Sound

MICRO-SCI FOR THE APPLE II/II+/IIE DIRECT SUBSTITUTES for APPLE DRIVES

Micro-Sci A2 drives and/or controllers are direct plug compatible substitutes for Apple drives and controllers.

	LIST PRICE	OUR PRICE
• For Apple II		
A2, 5 1/4", 143K Disk Drive	\$ 479	\$299
Controller Card for A2 Drive	\$ 100	\$ 79
A40, 5 1/4", 160K Disk Drive	\$ 449	\$359
A70, 5 1/4", 286K Disk Drive	\$ 599	\$479
Controller for A40 or A70	\$ 100	\$ 79
Filer, Disk Utility Software	\$ 20	\$ 15

WHILE THEY LAST

• OVERSTOCK SPECIALS •

	LIST PRICE	OUR PRICE
OUR 16K RAM Card, 2 Yr. Warranty	\$ 179	\$ 59
Microsoft 16K RAM Card	\$ 195	\$ 89
Saturn Systems, 32K RAM Card	\$ 249	\$169
ALS Synergizer Pack, 3 above plus Supercalc plus Condo Jr.	\$ 749	\$529
Videx Videoterm, 80 column card	\$ 345	\$239
CCS, Serial Interface 7710A	\$ 150	\$129
Centronics Interface 7728	\$ 110	\$ 85
Calender Clock 7424A	\$ 120	\$ 95
Centronics Interface 7720B	\$ 120	\$ 95

HOME & EDUCATION

	LIST PRICE	OUR PRICE
Broderbund,		
Apple Panic,	\$ 30	\$ 21
Arche Machine,	\$ 45	\$ 40
Choplifter	New!	\$ 35
Many others		Call
Budgetco, Raster Blaster	\$ 29	\$ 22
Continental, Home Accountant	\$ 75	\$ 49
Outastom, Snake Attack	\$ 30	\$ 24
Outastof, Canyon Climber	New!	\$ 30
Edu-Ware, Several in stock		Call
Auto. Simulations,		
Introductory 3-Pack	\$ 50	\$ 35
Hayden, Sargon II (Chess)	\$ 35	\$ 29
Infocom, Deadline	\$ 50	\$ 38
Insoft, Electric Duet by Lutus	\$ 30	\$ 25
Zargs	New!	\$ 35
Spider Raid	New!	\$ 30
Lightning, Mastertype	\$ 40	\$ 24
Microsoft, Typing Decathlon	\$ 30	\$ 24
Typing Tutor II	\$ 25	\$ 15
Muse, Robot War	\$ 40	\$ 29
Castle Wolfenstein	\$ 30	\$ 23
On-Line, Frogger	New!	\$ 35
Ultima II	\$ 55	\$ 40
Softpan (X Rated)	\$ 50	\$ 22
Piercadilly, Warp Destroyer	\$ 30	\$ 23
Sirius, Gorgon	\$ 40	\$ 29
Sir-Tec, Wizardry	\$ 50	\$ 39
Knight of Diamonds	New!	\$ 35
Sub Logic, Flight Simulator	\$ 34	\$ 25
Ponball	\$ 30	\$ 28
Strategic, Southern Command	\$ 60	\$ 45

LIMITED SPECIAL

800 Computer 48K	\$1099	\$599
810 Disk Drive	\$ 600	\$475
850 Interface	\$ 220	\$169
410 Recorder	\$ 100	\$ 79
* Anlon, Rampower 128K System (for 800)	\$ 475	\$350
Rampower 48K Module (for 400)	\$ 185	\$135
* Rampower 32K Module (400 or 800)	\$ 120	\$ 89

Free with above 3. Ramscan, Diagnostic Diskette. Call for other software and accessories, 25% to 50% off!

LIMITED SPECIAL

Commodore VIC 20 Home Computer	\$300	\$179
Datasette VIC 1530	\$ 75	\$ 59
Disk Drive VIC 1540	\$ 399	\$349

Call for other software and accessories, 25% to 50% off.

apple II/II+/IIE supply center

HARDWARE

for Apple II/II+/IIE

	LIST PRICE	OUR PRICE
RAM EXPANSION:		
* OUR RAM Card	16K \$ 179	\$ 59
* ALS, ADDRam	16K \$ 149	\$ 79
* Microsoft, RAMCard	16K \$ 195	\$ 89
* Saturn Systems,	32K \$ 249	\$169
	64K \$ 425	\$319
* Axlon	128K \$ 475	\$375
* Axlon, RAM Disk	320K \$1395	\$995
80 COLUMN VIDEO CARDS:		
* ALS, Smartem II	\$ 179	\$139
Dirt Cheap Video	\$ 89	\$ 69
Color II	\$ 179	\$139
Videx, Videoterm	\$ 345	\$239
* Vista, Vision 80	\$ 395	\$199
MISCELLANEOUS:		
ALS, The CP/M Card	\$ 399	\$299
Z-Card	\$ 169	\$129
16K ADDRam Special	\$ 149	\$ 79
Synergizer w/Serial + Condo	\$ 749	\$529
Axlon, 320K RAM Disk System	\$1395	\$995
ASTAR, RF Modulator	\$ 35	\$ 25
CCS, Serial Interface 771DA	\$ 150	\$129
Other CCS Cards in stock	Call	Call
Dan Paymar, Lower Case Chips	\$ 50	\$ 39
Don't Ask, DAO-003 S.A. Mouth	\$ 125	\$ 85
Eastside, Wild Card, copier	\$ 130	\$ 99
Kansington, System Saver	\$ 90	\$ 69
Kraft, Joystick	\$ 65	\$ 49
Paddle	\$ 50	\$ 39
M&R, Sup R fan	\$ 50	\$ 39
* Microsoft, Z80 Softcard Pack	\$ 345	\$245
* Softcard Premium Pack	\$ 695	\$495
* \$125-\$300 Rebate Coupon on above 2		
* 16K RAMCard	\$ 100	\$ 89
* Mountain, OPS Multifunction Card	\$ 239	\$199
Orange Micro, Grapler Plus	\$ 165	\$119
Practical Peripherals,		
MBS 8K Serial (Epson)	\$ 159	\$129
MBP 16K Para (Epson)	\$ 159	\$129
Microbuffer II 16K, (specify)	\$ 259	\$209
Microbuffer II 32K, (specify)	\$ 299	\$229
* PCPI, Appli-Card, 14 features,		
6 Mhz	\$ 595	\$435
RH Electronics, Super Fan II	\$ 75	\$ 59
SSM, A10-11, Serial/Para Interface	\$ 225	\$169
TG Products, Game Paddles	\$ 40	\$ 29
Joystick	\$ 60	\$ 45
Select-A-Port	\$ 60	\$ 45
Versa, VersaWriting		
Graphics Tablet	\$ 300	\$239
* Videx, Videoterm 80 col.	\$ 345	\$239
Soft Video Switch	\$ 35	\$ 25
Enhancer II	\$ 149	\$ 99
Function Strip	\$ 79	\$ 59
Full Videx Line. Call. Up to 35% off.		
PSIO, Para/Ser Interface	\$ 229	\$169
WICO, Trackball	\$ 80	\$ 55

NEC LIMITED SPECIAL

8001 32K Computer	\$ 995	\$699
286K Total, Dual Drive PC8031	\$ 995	\$699
32K add-on and 1/10 Unit PC8012	\$ 649	\$485

Call for other software and accessories.

SOFTWARE

on disk for Apple II/II+/IIE

	LIST PRICE	OUR PRICE
BUSINESS		
Apple Computer, Inc.		
The Controller, GL, AR, AP	\$ 625	\$399
Apple Writer II	\$ 150	\$119
Apple Pascal	\$ 250	\$199
Apple Fortran	\$ 200	\$159
DOS Tool Kit	\$ 75	\$ 59
DOS 3.3 Upgrade Kit	\$ 75	\$ 59
Apple Pilot	\$ 150	\$119
DJ Portfolio Evaluator	\$ 50	\$ 45
How to	\$ 50	\$ 25
Microcourier	\$ 250	\$125
Micro Telegram	\$ 250	\$125
Apple Logo	\$ 175	\$149
Applied Soft Tech., VersaForm	\$ 389	\$265
Artsci, MagicWindow II New!	\$ 150	\$ 99
Artsci, late, dBase II (CP/M)	\$ 700	\$419
Continental, GL, AR, AP or PR, ea.	\$ 250	\$169
1st Class Mail	\$ 75	\$ 49
Home Accountant	\$ 75	\$ 49
Hayden, Pie Writer (Specify brd.)	\$ 170	\$ 99
* High Tech., Job Control Sys.	\$ 750	\$350
Info Master	\$ 189	\$119
Howard Soft,		
Real Estate Analyzer II	\$ 195	\$129
Tax Preparer	\$ 150	\$ 99
Info, Unifm., Easywriter (PRO)	\$ 175	\$119
* ISA, Spellguard (CP/M)	\$ 295	\$ 99
LJK, Letter Perfect w/MailMerge	\$ 150	\$ 99
* Micro Craft, (CP/M)		
Professional Billkeeper	\$ 750	\$395
Legal Billing & Timekeeping	\$ 750	\$395
Micro Lab, Invoice Factory	\$ 200	\$ 99
Tax Manager	\$ 150	\$ 99
Micro Pro, (all CP/M)		
WordStar® + Training Manual	\$ 495	\$199
MailMerge™	\$ 250	\$ 69
SpellStar™	\$ 250	\$ 99
SPECIAL! All 3 above	\$ 895	\$349
Data Star™	\$ 295	\$149
* Microsoft, Multi-Plan (CP/M)	\$ 275	\$175
Multi-Plan (DOS 3.3) New!	\$ 275	\$175
Muse, Super Text 40/80	\$ 175	\$129
Super Text 40/56/70 New!	\$ 125	\$ 95
* On-Line, ScreenWriter II	\$ 130	\$ 89
The Dictionary New!	\$ 100	\$ 69
General Manager II New!	\$ 230	\$155
Osborne/C.P. Soft, (Disk and Book)		
* Some Common Basic Programs.		
75 Business, Statistics and Math	\$ 100	\$ 49
programs for the Apple II		
* Practical Basic Programs		
40 more very valuable programs		
beyond "Some Com BasicProg" \$ 100	\$ 49	\$ 49
* Peachtree, Requires CP/M and MBASIC. Specify		
Videoterm or 40 columns.		
Series 40 GL, AR or AP, each	\$ 400	\$275

	LIST PRICE	OUR PRICE
Series 40 GL & AR & AP, all 3	\$ 595	\$395
Series 40 Inv. or Pay., ea.	\$ 400	\$275
Series 9 Text & Spell&Mail, all 3	\$ 595	\$395
Series 80 GL & AR & AP, Videx	\$ 595	\$395
Perfect, Perfect Writer	\$ 389	\$239
Perfect Speller	\$ 189	\$119
Perfect Filer	\$ 289	\$179
Quality, GBS w/3 gen. (a OBMS)	\$ 650	\$475
Sensible, Sens. Speller, specify	\$ 125	\$ 85
* Silicon Valley, Word Handler	\$ 250	\$139
Soft./Sys., Executive Secretary	\$ 250	\$169
Executive Speller	\$ 75	\$ 55
Solidus/Softech		
* Stockfile	\$ 600	\$350
Stockseller	\$ 700	\$450
Systems Plus		
Acclg. Plus, General Ledger	\$ 425	\$295
Acclg. Plus, GL, AP and A/R	\$ 995	\$595
Acclg. Plus, above + Inventory	\$1395	\$775
Software Publishing,		
PFS II	\$ 125	\$ 85
Report	\$ 95	\$ 65
Graph	\$ 125	\$ 85
Southeastern Data Capture, call to specify.		
Stoneware, DB Master	\$ 229	\$155
DB Utility I or II	\$ 99	\$ 69
Videx,		
Applewriter II preboot disk	\$ 20	\$ 15
Visicalc to 64K preboot disk	\$ 50	\$ 39
Visicalc to 176K preboot disk	\$ 90	\$ 69
VisiCorp/Personal Software,		
Visicalc 3.3	\$ 250	\$179
VisiDex Special!	\$ 250	\$150
VisiFile	\$ 250	\$179
Desktop Plan II	\$ 250	\$179
Desktop Plan III	\$ 300	\$219
VisiPlot	\$ 200	\$149
VisiSchedule	New!	\$ 300
VisiTrend & VisiPlot	\$ 300	\$219
VisiTerm	\$ 100	\$ 79

UTILITY & DEVELOPMENT

Beagle, Utility City	\$ 30	\$ 22
DOS Boss	\$ 24	\$ 18
Apple Mechanic New!	\$ 30	\$ 22
Central Point Software		
* Filer, DOS Utility	\$ 20	\$ 15
Copy II Plus (bit copier)	\$ 40	\$ 35
Epson, Graphics Dump	\$ 15	\$ 9
Insoft,		
GraFORTH by Paul Lutus	\$ 75	\$ 59
TransFORTH II by Paul Lutus	\$ 125	\$ 99
Microsoft,		
A.L.O.S.	\$ 125	\$ 75
BASIC Computer	\$ 395	\$299
Cobol 80	\$ 750	\$559
Fortran 80	\$ 195	\$149
TASC Computer	\$ 175	\$159
* Omega, Locksmith (bit copier)	\$ 100	\$ 75
Penguin, Comp Graphics Sys. New!	\$ 70	\$ 53
Graphics Magician New!	\$ 60	\$ 41
Phoenix, Zoom Grafik	\$ 40	\$ 29
Quality, Bag of Tricks	New!	\$ 40
Sensible, Back It Up, (bit copier)	\$ 60	\$ 49

AD #959

THE WORLD'S LARGEST COMPUTER MAIL ORDER FIRM

Computer Exchange™

ALL MAIL: P.O. Box 1380, Jacksonville, OR 97530
WAREHOUSE AND OFFICES. BY APPOINTMENT AT 6791 UPPER APPLGATE ROAD.

NATIONAL ORDER DESK TOLL FREE
(800) 547-1289
All Other Orders Including Oregon: 772-3256

Standards Are Volatile

You might think that an official standard is as stable as a mountain. Most standards are in fact more stable than Mount St. Helens but not as stable as Gibraltar. ANSI brings up standards for review every five years, when they may be reaffirmed, revised, or withdrawn. If the responsible committee does not act, the standard automatically dies. Sunset laws appeared in standardization before they appeared in government.

Revisions to the editorial content of the standard specification are the most common; technical changes are more rare and must be treated as if a new standard were in development, with all the necessary meetings, documents, etc.

The constant review process protects both computer-product vendors and users from technological stagnation caused by fixed standards. But consequently, the standard's name must carry a date, which becomes very significant if changes are made. For instance, FORTRAN programmers must

be aware of the changes made between the 1966 FORTRAN standard and the 1977 revision of the language (American National Standard X3.9-1978).

Because major changes in a standard might prove to be detrimental to both industry and consumers by making items obsolete, some standards are stabilized through the process of registration. When a standard is registered, as for instance the ASCII (American National Standard Code for Information Interchange) character set, an entry is made in the broadly circulated standards registers. When changes are made to the character set standard (as happened in 1977 and may happen again in 1984), the new entries will be placed in the same standards registers while the original entry remains unchanged. In this way, several versions of a standard can exist at the same time. Using this method helps to avoid repeating the entire standardization process when there is a need to make changes.

as American National Standards, it can use the Canvass Method. In this event, the group takes a canvass or mail poll of all organizations that are known to have concern for and competence in the subject.

The organization proposing the standard becomes the sponsor and is responsible for preparing the canvass list. Generally, a six months' time limit is placed upon responses to the poll.

When the canvass ballot period closes, the sponsoring organization must submit all pertinent documentation to the standards-approving organization. This documentation includes the standard being proposed, the canvass list, the comments received, and the sponsor's responses to adverse comments. For example, these materials would be sent to ANSI, and further processing as an American National Standard proceeds. The programming language Ada has recently progressed through this method.

Standards Committee Method

The Standards Committee Method

is the one best known to the computing industry. It is used when one or more organizations have developed or are developing standards on the same or related subjects.

The method described here is the ANSI version. However, the fundamental principles are identical to those at the international and local levels. As an example, the factors applied to the decision to form a standards committee are the same in ANSI as in ISO. Additionally, the ANSI responsibilities in establishing a Standards Committee, watching its progress, and acting upon its output are identical to those of the comparable ISO councils.

The Standards Committee Method consists of a secretariat (administrative-support group) and a standards committee embodying a balanced representation of consumers, producers, and general interests. In many cases, a sponsor may also be involved.

The terms secretariat and sponsor are often used synonymously, but each has a distinct place in the standardization process. The *secretariat*

plays an important role in the efficient functioning of the standards committee. While a secretariat is always associated with a standards committee, a sponsor need not be. The secretariat organizes and appoints officers to the standards committee and generally handles all of the administrative work for the standards committee. The relationships of standards organizations and secretariats can be confusing at times, as each can fulfill several roles. As examples, CBEMA was authorized by ANSI to act as the secretariat for American National Standards Committee (ANSC) X3, and ANSI itself holds several ISO secretariats, among which is that for ISO/TC 97.

A sponsor, as defined by ANSI, is "an organization or group which assumes responsibility for development and publication of its standard and subsequently submits it to the institute for approval under any of the methods covered in these procedures." As an example, the American Society for Testing and Materials acts as a sponsor of ASTM standards when these are proposed as American National Standards. By this definition, CBEMA cannot be a sponsor because it does not develop its own standards.

Standardization Process

Regardless of the method used to submit a proposed standard, the objective of the approval process is to confirm that consensus has been reached. Within this process, four requirements must be met: all substantially concerned parties must have an opportunity to express their views, and these views must be considered; significant conflicts with other American National Standards must be resolved; consideration must be given to existing national and international standards; and evidence of compliance with ANSI procedure must be shown.

The process to accomplish all of this occurs in three phases.

1. Planning: A standard is proposed, and a judgment is made as to its value to the industry. A committee is authorized to accomplish the

PHASE I — PLANNING

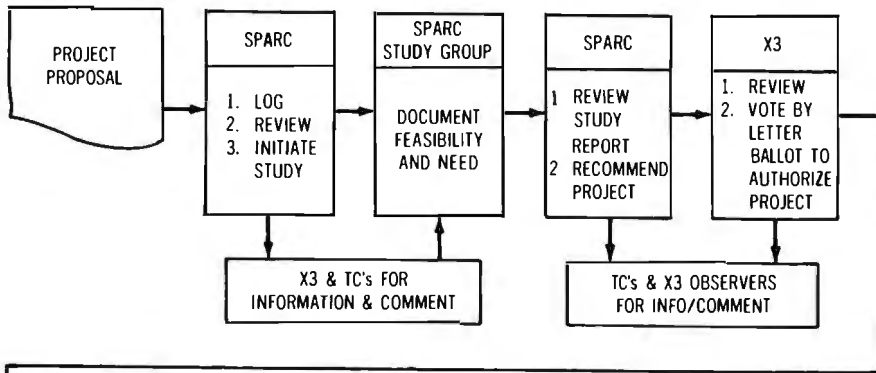

PHASE II — DEVELOPMENT

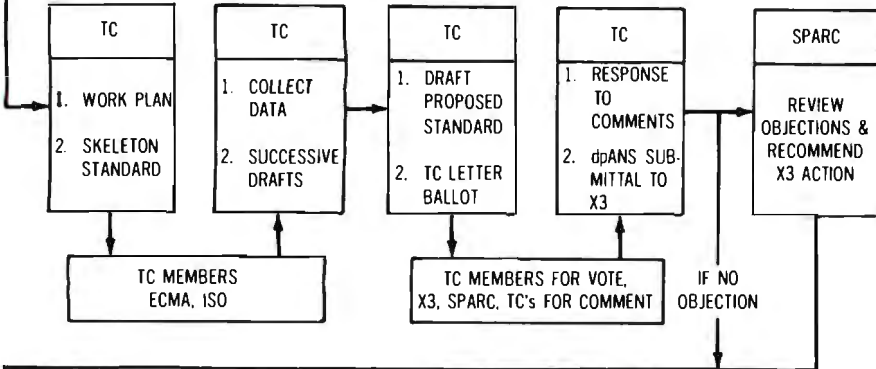

PHASE III — APPROVAL

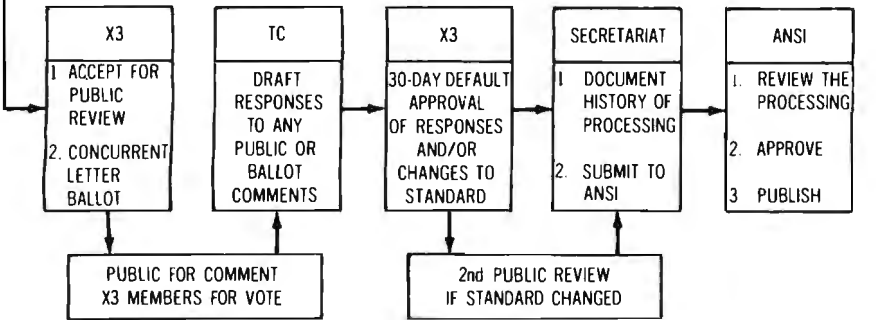

Figure 3: The standardization process is divided into three stages: planning, development, and approval. This flowchart depicts the milestones in each stage, beginning with the project proposal to SPARC (Standards Planning and Requirements Committee of ANSC X3), through the appropriate technical committees (TC) and ANSC X3 (American National Standards Committee for Information Processing Systems), culminating with submission to the secretariat and finally to ANSI.

work, and a public announcement is issued to that effect.

2. Development: A committee is formed (or assigned) to develop the standard or standards. When work is completed, the proposed standard is transmitted to the approving body.
3. Approval: Approval is obtained through the hierarchical structure of the approving body, and the standard is published.

See figure 3 for an example of these phases in the ANSC X3. To satisfy the commitment to consensus, each phase includes requirements for balanced representation, distribution of information, and approvals. If this is a national standard effort, the liaison and joint participation required for developing an international standard are also found in each phase.

Planning Phase

Any standardization organization may consider a request to establish a standards committee for a particular subject. The request is forwarded to a technically oriented advisory authority within the standardization organization. In ANSI, the Executive Standards Council assigns the subject to a Standards Management Board.

In evaluating the request for initiation of a standards committee, the foremost consideration is that those concerned with the subject have an opportunity to express their views. For this purpose a general conference may be convened, a poll may be

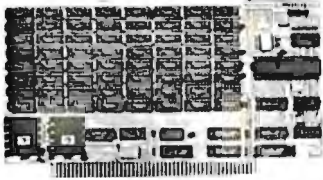
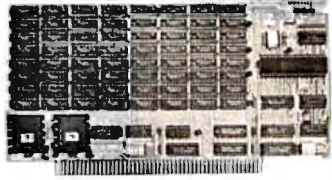
**Computer Solutions
We sell SemiDisk
for S-100 IBM Personal Computer
TRS-80 Model 2**

Computing has entered a new era: The SemiDisk era! No longer are you tied down by the speed of floppies or winchesters. Your computer can operate many times faster with a SemiDisk. And with our self installing software it couldn't be easier. Just plug in and hold on! No kidding! Special pricing: \$1595 for 512K Byte and \$2495 for 1 meg Byte.

Specifications:
 TYPE: Semiconductor Disk Emulator
 CAPACITY: 512k or 1Mb
 POWER REQUIREMENTS: 0.6A (512k) 0.9A (1Mb)
 BATTERY BACKUP: 10-12V Unreg. (optional)

For information contact:
 Computer Solutions
 Robert Pinkham
 P.O. Box 931
 Hillsboro, OR 97123
 (503) 640-5665

Dealers Wanted

taken to determine interest in the subject, or a research study may be undertaken by an ad hoc study group.

When the decision has been made to form a standards committee, appropriate notices are issued to the press and interested parties are encouraged to participate. The Standards Management Board then appoints a secretariat for the committee.

Development Phase

The work of the standards-development committee culminates in the transmittal of a proposed standard to the cognizant authority. This is preceded by a ballot to verify that consensus has been reached. If only one subject was assigned to the committee, the committee ceases to hold meetings but remains ready to process the comments generated during the approval phase of the proposed standard. It should be noted here that if any changes must be made in the technical content as a result of a ballot, the proposed standard is

returned to the standards-development committee.

Approval Phase

The approval phase begins when the secretariat receives the proposed standard with the request that it be processed as a national or international standard. The secretariat first determines that all the required documentation has been submitted and then distributes the document for review prior to taking a formal ballot. If comments are received during the balloting process, these are forwarded to the development committee for resolution, and the proposed standard may then be returned to the secretariat for review. The nature of the comments (substantive or editorial) determines whether the next step will be further changes or transmittal to the next higher level of authority.

The proposed standard now enters the stage where processing will be completed to make it a national or international standard. From this point

on, no decisions are made on the technical content; the total emphasis is on the evidence of consensus. When the existence of consensus has been validated, the standard-development cycle is complete. The proposed standard is then published in its entirety, or a notice is published indicating that the standard is available.

Operating Procedures

An understanding of the operating procedures of various standards organizations provides one of the best avenues to an understanding of the total process of standardization. It is here that you can best appreciate the checks and balances that constitute the development of a standard and come to understand the slow, laborious, and frequently frustrating delays, which to an outsider seem unwarranted but which are part of the process.

Basic to the process of standardization are the ballot procedures and member involvement. Both of these are indispensable to achieving consensus.

ANSI Voting Procedures

Let's examine the important voting process in detail. The voting period for the letter ballots of a standards committee is six weeks from the date of issue. The results of the ballot remain confidential to the secretariat and the committee officers until the ballot period closes.

When the ballot period closes, the secretary of the standards committee forwards the ballot tally to the chairman of the standards committee, who determines whether consideration of unresolved negative votes and comments shall be by correspondence or by a meeting of the standards committee or subcommittee involved.

(Often, committee members vote "no" on a given ballot because of minor objections to either the proposed standard or its specifying document. A simple clarifying statement in the standard can change a "no" to a "yes"; the vote is said to have been resolved.)

If technical changes must be made to resolve negative votes, these

The Ultimate For dBASE II Users



dNAMES™

DOCTORS
LAWYERS
REALTORS
MAIL ORDER
CONTRACTORS
SERVICE COMPANIES
DENTISTS
CONSULTANTS

If you deal with people, these are features that make dNAMES™ invaluable.

- A user friendly extensive reference and master mailing program designed to organize all your lists of customers, suppliers, sales leads, acquaintances, etc....
- Totally menu driven with error checking requiring a minimum of training and effort thus insuring accurate and efficient data entry taking advantage of the power of dBASE II (2.3B).
- Pick from up to 40 user supplied classification names, enabling you to designate each record in up to six different categories.
- Option of five report formats: single column or three across AVERY 33 labels, single line, 2-6 lines, or Mailmerge data file. These are based on your choice of specifications; name, classifications, date entered and date updated, a special six-digit code field, and zip code, sorted on your choice of fields in seconds.
- Automatically checks file first to see if that record is already on file; if so, it displays all current information (including date entered and last update) from up to three different files. You can then skip, edit, add a record, delete or recall, mark for future transfer, or even address an envelope.
- Immediate display of all information in a record by entering either all or part of record name or phone number.
- Keeps track of name, salutation, address, city, state, zip code, phone number, classifications, entry date, last update, six character code and up to four lines of comments, all dispersed into three files for speed and efficiency. A special capability affords you the option of using part of the first line of the comments for an additional line to be used when printing labels e.g., four line addresses or an attention line.
- Transfer old or unused records to an alternate backup disk. It also supports multiple data drives.
- Incorporates the most sophisticated edit program available for dBASE II. No more searching for individual records to edit. Display for instant reviewing or editing only records that fall within your choice of ranges.
- Although the uses for this program are endless, source code and documentation are included providing a base for limitless additional customizing.

only \$129.00

(Available on most popular computers and IBM/PC.)

Ashton-Tate	dBASE II	\$469.00
Fox & Geller	dGRAPH-new!	219.00
	QUICKCODE	219.00
	dUTIL	65.00
Anderson-Bell	Abatat	369.00
dBASE II applications	DBHELP (on line help)	20.00
	Payroll	350.00
	Job Costing	350.00

Inquire about other dBASE business applications. Simple Software PACMAX, CUTOFF, NYSE and SNAKES. 4 additing CPM GAMES for the price of 1. Only \$39.00

We also handle an extensive line of hardware, software, and peripherals. Call us last before ordering and see if we can't beat your best price. For example:

Osborne 1* users			
Take Advantage of our special on The Hard disk Osborne users recommend.			
5 meg	10 meg	16 meg	20 meg
\$2295	\$2495	\$2895	\$3295
Offer Expires 3-15-83			

Hayes SMARTMODEM	\$ 209.00	ALDOS 5-15	2,295.00
QUADBOARD	399.95	Televideo T3-802	2,695.00
EPSON MX80 F/T	475.00	C.I.TOH Prowriter	449.95

*Osborne is a registered trademark of Osborne Computer Corporation



DATA BASED SOLUTIONS
P.O. Box 9797, San Diego, CA 92109

TECHNICAL HOTLINE
619-272-5556
CONSULTATIONS AVAILABLE
ORDER DESK ONLY
619-272-5874

MASTERCARD/VISA ACCEPTED

PAYMENT — Cashiers Ck./M.O./Bank transfers
California res. add 6% tax
Allow 2-3 weeks for personal checks

CALL OR SEND FOR YOUR FREE COPY OF dTIPS

changes must be submitted to the standards-committee' membership within the four-week period given for responses. Those who voted in the affirmative must either reaffirm their vote in the light of any substantive changes or cast a negative vote. If negative votes cannot be resolved, these must be reported to the membership of the standards committee, with the reasons given for the negative votes. Each voting member, on receipt of unresolved negative votes and comments from those balloted, must indicate whether or not this affects his original vote. The final result is recorded and reported to the secretariat and to the membership of the standards committee.

At this point, the secretariat may use its discretion as to whether the proposed standard is ready to be submitted for ANSI approval. If at least two-thirds of the standards committee members voting have approved the standard, it is mandatory that the proposed standard together with the necessary exhibits be submitted to ANSI. If this is not done by the secretariat within one calendar month of the ballot closure, one or more of the members of the standards committee may offer the proposed standard for approval.

When the proposed standard reaches ANSI it is examined by the staff to determine that the documentation required has been forwarded and that evidence of consensus exists, just as was done when the proposed standard was submitted to the secretariat for a ballot by the standards committee.

The proposed standard is now submitted to the vote of the Board of Standards Review, which requires an affirmative vote of not less than two-thirds of the full board, taken by written ballot.

Documents

The names of the standards documents will give you a clue to the stages in the standardization process. As the documents containing a proposed standard specification move through the standardization process, the changes in document names indicate the level of acceptance the

Rugged, simple, dependable.

RCA Interactive Data Terminals as low as \$255*...



Reliable, portable RCA VP 3000 series Interactive Data Terminals feature: video and audio output; color-locking circuitry for sharp color graphics and rainbow-free characters; reverse video; tone and noise generator; 20 and 40 character formats; resident and programmable character set; LSI video and microprocessor control. All have a unitized 58-key, 128 character keyboard with flexible membrane switches, plus the features of the ASCII keyboards below.

VP 3501 Videotex Data Terminal. (Shown) Built-in RF modulator and 300 baud direct-connect modem. Ideal for time sharing data base applications. Works with standard TV or monitor. Also has expansion interface and 16-key calculator keypad. As low as \$275.*

VP 3303 Interactive Data Terminal. Similar to VP 3501, without modem or calculator keypad. Has selectable baud rates and RS232C/20Ma current loop interfaces. As low as \$262.*

VP 3301. Same as VP 3303, without RF modulator. As low as \$255.*

...and RCA ASCII Encoded Keyboards as low as \$56.*

RCA VP 600 series ASCII keyboards feature: flexible membrane keys with contact-life over 10 million operations; unitized keyboards are spillproof, dustproof with finger positioning overlay and positive keypress; 2-key rollover circuitry; tone feedback; high noise immunity CMOS circuitry; 5V DC operation and 58-key, 128-character keyboard, selectable "upper case only."



VP 616. EIA RS232C compatible, 20 mA current loop and TTL outputs; six selectable baud rates. Standard keyboard plus 16-key calculator. As low as \$88.*

VP 611. Similar to VP 616 with 8 bit parallel output. As low as \$70.*

VP 606. Same as VP 616, less calculator keypad. As low as \$73.*

VP 601. (Shown) Same as VP 611, less calculator keypad. As low as \$56.*

To order, or for more information, call toll-free 800-233-0094. In PA, 717-393-0446. Or write:
RCA MicroComputer Marketing,
New Holland Avenue,
Lancaster, PA 17604.

RCA

*OEM quantity prices.

standard has attained. The following names are used: Working Draft or Preliminary Draft, Proposed Draft or Proposal (proposals submitted for a technical committee ballot), Draft Standard (a Proposed Draft that has received the approval of the technical committee for publication), and Standard (a Draft Standard which has received all the necessary approvals for adoption as a national or international standard).

Member Responsibilities

All standards-committee work is accomplished by volunteers selected from the ranks of the member organizations. At the technical-committee level the individual must be technically competent in the subject and function as an independent "expert." In addition, the participant must become cognizant of all facets of the subject other than his own specific area of expertise in order to understand the viewpoints of other members. This is an essential requirement for obtaining consensus.

In addition to their professional positions within their organizations, participants must plan to spend a fixed portion of their own time on standards-committee work as well as allocate time to inform their own organizations on standards. A detailed knowledge of international protocol is essential so that a technical committee can function properly in the international environment.

International Standardization

International standards are becoming increasingly influential in world trade. Multinational companies find that differing national technical requirements have joined trade tariffs as significant factors in worldwide marketing because they may require a company to produce costly and unnecessary variants of a product. Development of international standards helps resolve these technical barriers to trade.

While it is neither desirable nor intended that international standards should be applied with the force of law, the policy of legislating by "reference to standards" is becoming

more and more frequent as technology develops and trade expands. The effective implementation of the "reference-to-standards" technique requires that legislation and regulations be drafted in the form of general requirements that contain references to a standard or a group of standards, which, in turn, provide more detailed explanations of the general requirements, as well as illustrations of the means of meeting the requirements.

If all standards originated at the national level and moved in an orderly fashion to the international level in one organizational structure, few complexities would exist. However, standards originate in many areas and from many organizations and thus involve liaisons with many other organizations. The international organizations best known to the computing community are the ISO, the IEC (International Electrotechnical Commission), and the Comité Consultatif International Téléphonique at Télégraphique (CCITT) of the International Telecommunication Union (ITU).

Conclusion

International standardization provides the solution to the problems of diverse national standards, the protection of consumer interests, and the elimination of trade barriers.

Throughout history, whenever a need for a standard was recognized, the interested parties either formed or designated an organization through which the process of developing standards could take place. Now the development of standards is a vast worldwide activity that could almost be classified as an industry in itself.

Simply put, a standard is a solution to a problem. It is not too surprising then that as our problems get more complex, the process of finding a solution also increases in complexity. Thousands of individuals are involved in standardization work for the computer industry alone, and the work they do affects all of us. Perhaps the information in this article will help you better appreciate the importance of standards and the standards process to our technological world. ■

Where to Obtain Standards Information

ACM Standards Committee
Association for Computing
Machinery
11 West 42nd St.
New York, NY 10036

American National Standards
Institute
1430 Broadway
New York, NY 10018

Computer and Business Equipment
Manufacturers Association
(CBEMA)
X3 Secretariat
Suite 500
311 First St. NW
Washington, DC 20001

Electronic Industries Association
Engineering Department
2001 Eye St. NW
Washington, DC 20006

IEEE Computer Society
POB 80452
Worldway Postal Center
Los Angeles, CA 90080

IEEE Service Center
445 Hoes Lane
Piscataway, NJ 08854

Information Handling Services
Product Management Department
15 Inverness Way E
POB 1154
Englewood, CO 80150
*(This is a commercial firm that
compiles and distributes copies of
electronics standards for a fee.)*

Institute for Computer Sciences
and Technology
A200 Administration
National Bureau of Standards
Washington, DC 20234

United States Department of
Commerce
National Technical Information
Service
5285 Port Royal Rd.
Springfield, VA 22161

**MDBS III™**

Mainframe-quality DBMS from
Micro Data Base Systems, Inc.
International Software Enterprises—USA
(312) 981-9200

**ACCOUNTING PLUS™**

A comprehensive microcomputer
business accounting system.
SOFTWARE DIMENSIONS, INC.
(916) 722-8000

**QUICK CHECK™**

Instant Answers for Money Matters,
Bookkeeping/Accounts/Inventory
CHUCK ATKINSON PROGRAMS
(817) 249-0166

**INMASS™**

Integrated Manufacturing and
Accounting Software System
MICROCOMPUTER CONSULTANTS
(916) 756-8104

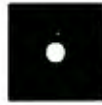
**DATA COMMUNICATIONS
SOFTWARE**

ASYNCR, BISYNCR & SNA-SDLC protocol
data communications software.
IE Systems, Inc. & Micro-Integration, Inc.
(603) 659-5891

**PC/FORTH™**

Program development systems for Z-80
and 8086/88 microcomputers
Laboratory Microsystems, Inc.
(213) 306-7412

WHEN YOU BUY THE RIGHT SOFTWARE, YOU CAN'T GO WRONG ON THE HARDWARE.

CP/M® compatible software — for maximum
work power on more than 600 computer models.

All the computers in the world won't help you without smart software. That's why we're showing some of the best software products you can buy, from solid, innovative companies. They're shown here together because they're all CP/M compatible. CP/M is the universally accepted operating system created by Digital Research that allows software products like these to run on more than 600 different computer models including the biggest names in hardware. So, to get smart software for your system, call one of the fine Independent Software Vendors listed above or to find out how CP/M can increase productivity in your world, contact Digital Research at (408) 649-5500.



**DIGITAL
RESEARCH™**
The creators of CP/M™



Circle 148 on Inquiry card.

The logo, tagline and CP/M are either trademarks or registered trademarks of Digital Research Inc.
©1982 Digital Research Inc.

The Panasonic portable computer We've improved the way



THE Link[™] by Panasonic. will improve the way you solve problems. And the solutions come from the portable computing power you have at your fingertips. You can take it with you on planes, cars, boats, anywhere, because it fits into a suitcase. You can be more cost effective in the world, because you'll have access to more information for making on-the-spot decisions. You have the incredible advantage of being able to communicate from anywhere you are. It gives you a whole new world of computing. Portable computing.

Software Solutions — Now there's an exciting new software program for the 6502 processor that gives you more power.

Extended Basic Compiler/Interpreter, Snap-On T.H. and Microsoft Basic.[®]

The Panasonic portable computer also has a wide range of specific software programs for your specific problems, such as:

The Scientific Calculator — An incredibly powerful tool that solves mathematical problems for the amateur, and professional wherever they go.

Portabudget — It's your portable personal financial manager. It gives you up-to-the-minute personal control. It allows you to be your own record keeper, savings advisor, accountant, bill manager, credit and charge account guide, investment counselor, portfolio keeper, and tax assistant. Overall, it helps plan your personal financial life, portably.

Portacalc — Gives you the portability and the flexibility to automatically analyze numerical problems wherever and whenever they arise. You can assess "what if" alternative business problems, comprehend key variables in business, and dynamically analyze problems on engineering projects.

Portawriter — It allows you to write, edit, and format information. And, you can telecommunicate the information from wherever you are. Whether you're in the boardroom, hotel room, or even on a golf course, Portawriter gives you full editing and formatting capability for notes, reports, letters, news copy, tables, lists, forms, orders, you name it.

Portalog — It is an easy, precise tool for time-billing professionals without a minute to lose. Whether you're on the road or in the office, you can log time, compile bills, generate billing reports, and track the work of your highly paid employees. Portalog gives you improved timekeeping productivity.

Telecomputing 2[™] — It lets you telecommunicate with your data base. You can establish communications between headquarters and field forces. Exchange files and programs between remote stations. Access timesharing services and store data in a large computer's mass storage. You can also upload and download program data.

with a wide range of new software. you solve problems.

Portaflex—A master program that allows you to create solutions for applications, such as:

- *Inventory Control* — Analysis and control of inventory while you're on the job.
- *Order Entry* — A customized system for any sales order entry. It offers you productivity, and the advantage of faster order entry.
- *Field Service* — Retrieve, diagnose, and analyze your field service data wherever you are in the field.
- *Auditing and Accounting* — Custom auditing and accounting, anywhere you are in the field.
- *Estimating* — Versatility for flexible bidding and estimating at your job site.

Development

create your own custom programs and burn them into your EPROM so your program is recorded in nonvolatile form.

Simply take a desk top microcomputer,* insert the software development discs, create your own program, de-bug that program, compile the program, then "burn-in" your problem-solving EPROM.

*Presently offered for Apple II Plus.

Hardware Specifications —

The Panasonic portable computer offers 6502 microprocessor (1 MHz) technology.

- It offers 4K or 8K internal nonvolatile RAM
- 48K internal ROM
- Built-in Ni-Cad rechargeable battery pack
- External AC adapter/recharger
- 26-character liquid crystal display
- 65-key completely redefinable keyboard

Introducing Peripherals for Additional Solutions —

Modular peripherals let you customize your system.

- Multiple RS-232C serial interfaces
- Asynchronous modem with cassette interface (110 or 300 baud)
- 40-character microprinter (thermal dot matrix printing)
- 8K or 16K RAM memory expansion packs
- X-Y, four-color plotter (up to 80 characters per line)
- TV adapter (32 characters X 16 lines with color and graphics)

The Panasonic portable computer. It's improved the way you solve problems. Because we believe its portable modules and multiple software applications can vastly improve your productivity. And that can be an important solution to your profit problems.

The portable computer from Panasonic. We've improved the way you solve problems.

THE Link by Panasonic. It's changing the way the world uses computers.



Dealer Inquiries Invited

Computers
New Jersey 07094

PRINT) _____

Type of Business _____

Address _____

City _____ State _____ Zip _____

or () _____

Panasonic
just slightly ahead of our time.

Circle 328 on Inquiry card.

Welcome to the Standards Jungle

An in-depth look at the confusing world of computer connections.

Ian H. Witten
Computer Science Department
University of Calgary
2500 University Drive NW
Calgary, Alberta
Canada T2N 1N4

RS-232C, RS-366, RS-423A, RS-449, V.10, V.11, V.24, V.28, X.21, X.21 bis, X.26, X.27, current loop. . . Welcome to the standards jungle. All these are standards or recommendations designed to help you connect computers to terminals, modems, and computer networks. Why are there so many? What are the differences between them? The similarities? I'll attempt to guide you through this horrendous complication of standards, but first let's take a look at where these standards originated.

The standards or recommendations I'll cover come from two organizations. The standards with the RS prefix are from a United States organization, the Electronic Industries Association (EIA). These are the most widely used standards for computer equipment in North America and hence the world at this time. The standards prefixed by a V or X are from the Comité Consultatif International Téléphonique et Télégraphique (CCITT), a committee of the International Telecommunications Union, which is an agency of the United Nations. The concerns of

the CCITT encompass all aspects of telecommunications worldwide. Because of sometimes conflicting factors influencing its decisions, such as special national requirements and geopolitical concerns, the CCITT

**The EIA standards
are the most widely
used standards for
computer equipment
in the world.**

makes recommendations rather than standards. Although the EIA standards and the CCITT recommendations are almost identical in many cases, they differ somewhat in wording and detail. Additionally, the CCITT has taken a separate direction from the EIA in the past few years, which I will discuss later. (A complete copy of the standards and recommendations can be purchased by writing to the respective organizations: EIA, 2001 Eye St. NW, Washington, DC 20006; and CCITT, United Nations

Bookstore, United Nations Assembly Building, New York, NY 10017.)

An RS-232C Beginning

My jungle tour starts with a whirlwind overview of the standards listed in table 1, after which I'll describe each one in greater detail. A good place to begin is with the most popular standard for connecting computers to modems and terminals, RS-232C. The official title for this complicated standard is *Interface Between Data Terminal Equipment and Data Circuit-Terminating Equipment Employing Serial Binary Interface*. The C in RS-232C indicates that it has been revised. This standard includes much more than just the transmit-and-receive-data wires you use to connect a terminal to a computer.

The RS-232C standard has four parts: electrical signal characteristics, interface mechanical characteristics, functional description of the signals, and a list of standard subsets of signals for specific interface types. The first part defines the voltages to be used and their interpretations as 0s and 1s. The second gives you the size

SUPER BARGAINS

ACE 1000 COLOR COMPUTER! List \$1545
SHARP COMPUTER 249

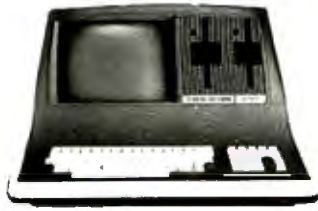

SUPERBRAIN II

Double Density 1894
Quad Density 2274
Super Density SD 2649
COMPUSTARS
TO DEALERS CALL & SAVE

Advanced Micro Digital S-100 Super-Quad Single Board Computer. Z80 64K RAM, Disk Controller, RS-232 Only 699

ALTOS — single and multi-user
ACS-8000-15D List 5990
Only 4699

ATARI 400 289
800 655

PRINTERS

OKIDATA 82A 489
CENTRONICS 739-1 499
IDS PRISM 80 743

EPSON MX-80 FT 547
MX-80 459
MX-100 749

ANADEX 9501A 1345
Silent Scribe 1623
NEC #3510 Letter Quality 1399
C. ITOH F10 Letter Quality 595
Smith Corona TP-1 595

TRAXX 5 1/4" Add-on Drives 249

Memory Merchant 16K static 159
Central Data RAM S-100 64K 299
Systems Group
RAM S-100 64K 449
Microangelo Video Graphics 715

AMERICAN SQUARE COMPUTERS is organizing a World Wide Association of Computer Dealers. Open a Store or Start Work Out of Your Home! We Charge NO FRANCHISE FEE! (Our Competitors charge a FRANCHISE FEE of from \$15,000.00 to \$45,000.00.) Be a Winner! Let US help YOU get started MAKING MONEY by HELPING PEOPLE to put COMPUTERS to WORK. Write or Phone today.

Which Computers are Best? ... Free
Insured Shipping at Low Rates.

We Repair Computers

One hour free troubleshooting on business systems.

Full Time Graduate Technician on Duty.



TELEVIDEO

Televideo 910+ 518
Televideo 925 718
Televideo 950 899
Televideo Computers Call

ADDS VIEWPOINT A-1B 469
ZENITH Z-19 Terminal 649
Z-89 48K Computer 2119
Z-90 64K DD 2399
ZVM-121 ZENITH
Green Screen monitor 125

INTERTUBE III
or EMULATOR \$710
AMDEK Color Monitor \$329

GODBOUT COMPUPRO
Super Sixteen 8085/8088. The fastest 8-16 bit computer! Runs 8 and 16 bit code! 128K Static RAM, 6MHz CPU's LIST 3440 SPECIAL 2569

New: Systems 816/A, B, and C with enclosure and drives.
816/A List 5495 Only 4395

SEATTLE pure 16 bit computer is the fastest microcomputer by actual test! S-100, 128K Static RAM, 8 MHz 8086, 22 slot Mainframe
Model #2 List 3785 Only \$3028
#1 as above
but 64K List 2990 Only \$2392

IBM PC memory made by SEATTLE.
Now with "Flash Disk." 192K = 697
64K = 427

CALIFORNIA COMPUTER 2210A
List \$1995 Only \$1595
Z80, 64K, I/O, Disk controller + CPM, California main frame 484

SYSTEMS GROUP computers run FRIENDLY OASIS Call SAVE

QUAY COMPUTER
Two drives + CPM \$1745
Four user MPM 208K +
Hard Disk \$5945

TARBELL'S
Empire I & II have two 8" disk drives. The I is single sided, the II is double sided.

FREE Business Software
Empire I List 4888 Only 3495

Corvus Hard Disk SAVE
SSM Video BRD VB3 kit 361
Spectrum Color ASM 223



NORTH STAR

ADVANTAGE 64K Green Phosphor. The Best Business Graphics, 2 Disks, Serial Port. Options CPM — Business programs \$2894

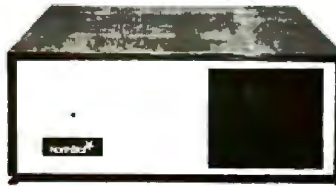

NORTH STAR Horizon Powerful North Star BASIC Free Superb for Business & Science Free Secretary Word Processor

Horizon Standard is now HRZ-2-64K Quad

Factory Assembled & Tested Only

Horizon-2-64K-Quad \$2894
Horizon-1-64K-QHD 5 3999
Horizon RAM 64K 594
Big Sale on Multi-User

Time-Sharing SAVE
North Star Hard Disk 18Mb 4295
English to Basic Translator 75
Zbasic 2 to 5 times faster! 325

Secretary Word Processor 69
Wordstar Word Processor 278
Floating Point Board 699
Oasis 699

CPM for N*—Extra features 147
Micro Mike Software CALL
MICROSTAT \$355
Pascal-80 539

Extra Precision BASIC 49
Northword 179
Infomanager 329
General Ledger 399

Accounts Receivable 399
Accounts Payable 399
Inventory 399
Order Entry 399
PROPAC 1299

DOS + BASIC 5.2 28

INTEGRAND main frames S-100. Many models to choose from
Only 200 & UP

MODEMS

DC HAYES — S-100 \$329
POTOMAC MICRO MAGIC 369
SIGNALMAN 97
CAT NOVATION 159
AUTOCAT 215



MICRO DECISION

"A DEAL YOU CAN'T REFUSE"

64K RAM, Z80, 4MHz, 2 Serial Ports, Disk Controller. FREE SOFTWARE: CPM — Microsoft BASIC — BaZic — Wordstar—LogiCalc—Correct-It.

	List	Only
with 1 5 1/4" Disk	.. \$949	.. \$1049
with 2 5 1/4" Disks	.. 1545	.. 1400



DECISION I

"The IBM-360 on the Z-80 & S-100 BUS!"

Sixteen Programs running simultaneously! Free CPM, Microsoft BASIC, and WORDSTAR with complete system!

DECISION 1 + 65K Static +
8" Disks DMA 3403
DECISION 1 + 65K Static +
2 5 1/4" Disks 2795

DECISION 1 + 65K Static +
5" Disk + 5 Mb Hard Disk 4235
DECISION 1-2user 256K Static +
5" Disk + 5 Mb Hard Disk +
MICRONIX 5830

DECISION 1 — Z-80 + I/O + 65K 1915
DECISION 1 — Rackmount + 20 Mb
HD - 8" DRV Reg. 6235
Inventory Sale 5415

MORROW Hard Disks up to 26 MEGABYTES

HDC-M26 \$3333
HDC-M20 3333
HDC-M10 2955
DMA-M5 Reg. 1775
Inventory Sale 1400
DMA-M10 2235
DMA-M16 2795

MORROW 8" Disk

Discus 2D + CPM 600K Only \$834
Discus 2 + 2 + CPM 1.2 Mb 1068
Add Drives 2D = 599 2 + 2 = 1795
Discus 2D dual + CPM Only 1384
Free Microsoft BASIC from MORROW with Discus system or hard disk.

FAST FIGURE — Most powerful spread sheet. 5 1/4" or 8" 99

Wordstar 278
All MicroPro Software for IBM, Apple, North Star, Morrow, etc. SAVE! CALL

Call for latest prices & availability

Factory Guarantees

We Beat Prices

AMERICAN



COMPUTERS

919-889-4577

4167 Kivett Dr.

Jamestown N.C. 27282

919-883-1105

Circle 22 on inquiry card.

!!!!FANTASTIC PRICES!!!! FROM DIGITAL DIMENSIONS

OKIDATA
 ML-80 \$339
 ML-82A \$415
 *ML-83A \$680
 *ML-84(parallel) \$985
 *ML-84(serial) \$1,095
 ML-92 \$509
 ML-93 \$869
 PACEMARK 2410 CALL
 PACEMARK 2350 CALL
 *Includes Tractor Feed

ANADEX DP8000 \$749
 ANADEX DP9500/9501 \$1279
 ANADEX 9500A/9501A \$1359
 ANADEX DP9000/9001 \$1209
 ANADEX DP9620A \$1459

SCM-TP I \$649
 120 word/min Daisy Wheel, 10 or 12 pitch, serial or parallel interface

DAISYWRITER 2000 \$1,015

BIDIRECTIONAL 40 CPS AVERAGE THROUGH-PUT, 48K BUFFER, CENTRONICS, 488, RS232 & C. LOOP INCLUDED.

DAISYWRITER 1500 S \$955
 4K Buffer Serial Only
 DAISYWRITER 1500 P \$925
 4K Buffer Parallel Only

IDS
 PRISM 80 \$1,219
 Includes sprint mode, dot plot and cut sheet guide
 PRISM 80 \$1,319
 Includes sprint mode, dot plot, cut sheet guide and 3.4K buffer.
 PRISM 132 \$1,649
 Includes all of above and 4-color graphics

C.ITOH
 Prowriter (Parallel) \$489
 Prowriter (Serial) \$629
 Prowriter 2 (Parallel) \$719
 Prowriter 2 (Serial) \$769
 Starwriter F10 \$1,449
 Printmaster F-10 \$1,699

DISK DRIVES
 RANA ELITE I \$305
 MICRO-SCI \$289

MODEMS
 HAYES 300 BAUD SMART MODEM \$219
 HAYES 1200 BAUD SMART MODEM \$515

E-Z COLOR board \$199
For the Apple II or Apple II Plus.
16-Color, 256 x 192 resolution. Requires
3.3 DOS. Includes demo software and
E-Z COLOR Editor.

E-Z COLOR board for S100 Systems \$279
E-Z COLOR board for TRS-80 \$239

INTEX TALKER text-to-speech synthesizer. Serial and parallel interface included \$280

AMDEK 13" COLOR-I \$335
 AMDEK 13" COLOR II \$719
 NEC JB1201 GREEN Monitor \$159

FOR THE IBM P.C.
Quadram Quadboard w/64k \$429
Quadram Quadboard w/128k \$519
Quadram Quadboard w/192k \$609
Quadram Quadboard w/256k \$699

DIGITAL DIMENSIONS

190 Chapel Rd., Manchester, CT 06040

Info & Orders Call 203-649-3811
 Orders Only 1-800-243-5222

C.O.D. Welcome. Allow 2-3 Weeks For Checks. MC/VISA OK. All Prices Include UPS Ground Freight In U.S. CT Residents Add 7 1/4 % Sales Tax. Prices Subject To Change Without Notice.

EIA	CCITT	Approx. Date	Speed/Distance	Purpose
RS-232C	V.24, V.28	1969	20,000 bps and 50 ft.	interface specification for modem control, including electrical and mechanical characteristics and functional definitions of signals
RS-366	V.25			automatic calling unit used in conjunction with a modem to allow a computer to dial calls
RS-422A	V.11, X.27	1975	10 million bps and 40 ft 100,000 bps and 4000 ft	electrical specification only; two-wire connection for each signal
RS-423A	V.10, X.26	1975	100,000 bps and 40 ft 1000 bps and 4000 ft	electrical specification only; one-wire connection for each signal with common return wire
RS-449		1977	2 million bps using RS-422A 20,000 bps using RS-423A	interface specification for modem control, using RS-422A as electrical specification, with option of RS-422A for some wires
	X.21	1976		interface specification for data equipment to public data network, using synchronous format and digital rather than analog transmission on telephone networks
	X.21 bis	1976		modification of X.21 to allow its use with existing synchronous data equipment and analog telephone networks—essentially the same as V.24 and RS-232C
			current-loop (not officially sanctioned)	10,000 bps and 1500 ft provides send and return data paths only (no modem control)—not a proper standard—used originally for Teletype terminals and now used on many microcomputers

Table 1: The standards jungle.

of the plug and the disposition of the pins. The third, which I'll discuss in most detail, gives a functional description of the 21 signals which make up the RS-232C standard. The fourth part lists about 14 subsets of these 21 signals that are used in different types

of modems. The CCITT recommendation, V.24, is almost identical with RS-232C; however, the electrical signal characteristics are specified separately in a companion recommendation, V.28.

When you access a computer over

BHART

Computers for: Business, Home Applications, Resource Management, Technology & Science
NEW: 15-Day Exchange Privilege (See "TERMS" for details)

Displayed and sold at our Showroom, 12210 Michigan Ave., Grand Terrace, CA:



**KAYPRO II
PORTABLE
COMPUTER**



**NEC
NEC APC**

Extremely sophisticated graphics and color display (320x4024 pixels) 16-bit (8088), 128K standard, expandable to 256K. 1-2.8" Floppies 1 MEG each (run any CP/M program available on 8"). Detachable keyboard. Integral monitor (monochrome/color). Extensive software.
 H01 Monochrome, 1 Floppy, List \$3298 \$ CALL
 H02 Monochrome, 2 Floppies, List \$3998 \$ CALL
 H03 Color monitor, 2 Floppies, List \$4998 \$ CALL
CALL for appointment

Beats the competition on every count:
 • 80 col., 24 lines on 9" screen, Z-80, 64K
 • 400K K on 2 Floppy drives (more storage!)
 • More free software included: PerfectWriter, Perfect Speller, Perfect Filer, Perfect Calc. spreadsheet, Profit Plan finance forecasting, CP/M, BASIC.
 List \$1795 **CALL for availability!**



MICRO-DECISION

Perfect desk-top computer.
 • Z-80, 1 Floppy standard, 2nd optional, Optional terminal, or use your own.
 • CP/M with user friendly "shell"
 • WordStar, SpellChecker, Spreadsheet, Microsoft Basic-80 & BASIC
 List \$1195 - \$1790, Limited Quantity **CALL**

3 GRAPHICS SYSTEMS:



ZENITH Z-100
 Advanced color graphics under Z-BASIC, 16 bit (8088) & 8-bit (8085) 128K RAM, expandable to 768K (Expand to 192K for only \$180).
 Runs most IBM-PC software and CP/M. 3 configurations, 1-2 Floppies. 90 day ON SITE warranty. List \$3249-4099 **\$ CALL**
 ZENITH Hard Disk **\$ CALL**



**TeleVideo
TELEVIDEO
1602G**

Superior graphics computer just released. 244,224 pixels, zoom, pan, rubberband! 16 bit (8088), 128/256K Hardware arithmetic option. Networking capability. 2 Floppies 700K CP/M 86 w/Dig. Res. Graphics Language. List \$4495 **\$ CALL**

TELEVIDEO 1602GH: Similar but 10M Hard Disk. List \$6995 **\$ CALL**



**NORTHSTAR
ADVANTAGE**

High resolution graphics under BASIC Z80A (4MHz), 16 bit (8088) upgrade only \$499, 64K, 2 Floppies, 720K/Hard Disk 5M.
 List \$3559-4999 **\$ CALL**
Graphics Peripherals: IDS PRISM COLOR PRINTER. 200 CPS, high resol. graphics. List \$1995 **\$ CALL**
AMDEK Digital Plotter. 4-color, flatbed. List \$949 **\$ CALL**

ALTOS

ALTOS SERIES 5
 Ideal for advanced business or advanced personal computer user: supports 3 users with independent tasks concurrently. Z-80, 192K, 2 Floppies 2 MEG, expandable to hard disk. Comes with MP/M II, OASIS also available.
 List \$2990 **CALL for availability!**

IBM/APPLE PRODUCTS:

HARD DISKS & MICRODISKS:
 Your backup worries are over.
 QCS Hard disk 6 MEG removable + 6 MEG fixed. List \$3,499 **ONLY \$2,795**
 CORONA Hard disk 5 MEG, mounts internally **ONLY \$1,536**
 10 MEG **ONLY \$1,919**
 AMDEK 3" Micro-Floppy System, w/controller, 1 MEG total. List \$699 **\$ CALL**
MEMORY & I/O BOARDS:
 QUADBOARD: clock, serial & parallel ports, 128K **\$589**
 QUADS12 + 64K + serial port **\$369**
 QUADS12 + 256K + serial port **\$689**
 QUADSCREEN Super-Monitor (166 col. x86 line) **\$ CALL**
 QUADCOLOR for better color graphics **\$ CALL**

MONITORS & PLOTTERS:
 AMDEK 12" Amber **\$159**
 AMDEK COLOR II RGB, hi-resolution, 13" **\$699**
 AMDEK COLOR III RGB **\$382**
 ZENITH RGB high-resolution RGB **\$524**
 PRINCETON high-resolution 12" RGB **\$ CALL**
 NEC 12" RGB high resolution **\$ CALL**
 TYMAC printer-adaptor //APPLE **\$89**
 GRAPPLER **\$129**



**IBM-COMPATIBLE
COMPUTER:**

COLUMBIA 1600 16-bit 8088, accepts all IBM bc-ords, reads & runs all IBM software, but has also additional Z-80 processor to run 8-bit CP/M. So compatible it can even use IBM keyboard! 128K, 1 parallel & serial ports standard, 8 expansion slots! COLUMBIA 1600 package: computer as above + keyboard + CRT controller. List \$3,635 **\$ CALL**

SYSCOM-2: Apple-Compat Computer
 Fully compatible with APPLE-II, runs APPLE programs. List \$869 **\$ CALL**

BUSINESS OWNERS...Can You afford NOT to computerize?

If conflicting claims for different systems leave you bewildered, if a salesman is "pushing" a system about which you have doubts, or your costly computer is not delivering its promise—**help is now available.** Our Business Program divides computer acquisition to 4 phases, and provides 4 distinct services. **Use ONLY the service needed, control your cost at EVERY phase, and pay ONLY for what you get**—each of our services is available independently:

- ASSESSMENT OF NEEDS:** On time-usage basis, you obtain access to our CONSULTANTS, who combine business background and extensive computer expertise, and can discuss your needs with them over the telephone. The initial interview is FREE; then YOU determine how much of the consultant's time you need, charged at \$30/15 min. You pay ONLY for professional, objective advice. No purchase is required now or later.
- HARDWARE:** We carry a large variety of business systems, single and multi-user. You are not locked into any particular concept or product line. Our pricing is highly competitive, and you pay ONLY for the hardware. But, at your option, all equipment sold by us is eligible to be covered in our System Support Program.
- SOFTWARE:** We offer a number of comprehensive lines of business software, all widely used and competitively priced: ACCOUNTING PLUS, CYMA Business and Professional packages, DBASE II, MULTIPLAN. Most important, **WE CARRY ONLY SOFTWARE WE ARE ABLE TO SUPPORT:** Contract for software support is available for each module you purchase from us.
- SYSTEM SUPPORT:** Subscription to our SUPPORT SERVICE (\$200/system/year) gives you access to our SOFTWARE SPECIALISTS who answer your questions on time-usage basis. Our Specialists are recruited from the Systems Instructor ranks, and specialize in a single line of software. They have immediate access to systems running your software, so that a 5-minute telephone session with them (at \$10) is much more cost-effective than a 2-hour trip to a computer store, or a 2-day wait for your computer salesman! **To Set Up Your Initial Evaluation Call Our Business Division (714) 781-6566**



**TeleVideo
COMPLETE TELEVIDEO
MULTI-USER SYSTEM:**

Multiple workstations with independent capabilities and tasks: 3 inventory control stations, 2 Accounting Office Stations, 1 Management station (16-bit) with graphics capability. TeleVideo TS-816 CPU with 40 MEG hard disk and tape backup. Complete accounting, inventory control, financial management and business graphics programs operating under Turbo-Dos w/file & record lockout for uninterrupted multi-user service. 1 high-speed dot-matrix printer and 1 letter-quality printer, receive/auto-dial modem. Complete integration included.
 List \$29,395 **CALL FOR INFORMATION**



**SMITH-CORONA
TP-1:**
**AT OUR PRICE,
NO COMPUTER
SHOULD BE WITH-
OUT ONE!**
 Daisy-wheel, letter-quality, interfaces all computers. Serial & parallel models at same low price. No less than 18 print-wheels—only \$6.95 each. List \$849 **ONLY \$545!!!**



**GEMINI-10
from
Star-Micronics**
 All the features of EPSON-F7, plus backspace, continuous underline,
 List \$499 **ONLY \$ CALL!!!**

INTERFACES & MODEMS, ETC.

Hayes Modems:
 SmartModem 300 **\$214**
 SmartModem 1200 **\$523**
 MicroModem II **\$269**
 MicroModem 100(S-100) **\$289**
 VENTEL RS-232 Modem **\$763**
 MICROFAZER printer buffer **\$139**
 INTERFAZER I/multi-users, up to 8 terminals & 2 printers! **\$239**
SCOTCH DISKETTES by 3M: the very best!
 5 1/4 ss dd. 5 boxes min **\$21/box**
 8" ss dd. 5 boxes min **\$27/box**

GEMINI-15 similar but 15" carriage. Even better buy: List \$649 ONLY \$ CALL!!!

Additional dot-matrix printers:

NEC-8023A (parallel) **\$459**
 AXIOM 80 col. 30cps, graph., p **\$289**
 Okidata 82A (ser/parallel) **\$ CALL**
 Okidata 83A 132 col. (s/p) **\$649**
 Okidata 84-P 200 cps. & 50 cps. correspondence mode **\$994**
 Okidata 84-S same, but serial **\$1099**
 Okidata 92, just released **\$ CALL**
 Microprism draft/corresp. **\$329**

Letter-quality printers:

NEC 3510 33cps serial **\$1449**
 NEC 3530 same, parallel **\$1599**
 NEC 77 10/30 55 cps, s/p **\$2194**
 DIABLO 620 25cps, ser. **\$1094**
 BROTHER HR-1 **\$794**
 DAISYWRITER, 16K Buffer **\$999**

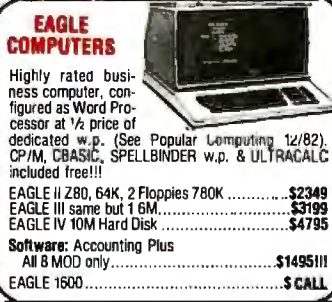

**EAGLE
COMPUTERS**
 Highly rated business computer, configured as Word Processor at 1/2 price of dedicated w.p. (See Popular Computing 12/82). CP/M, CBASIC, SPELLBINDER w.p. & ULTRACALC included free!!!
 EAGLE II Z80, 64K, 2 Floppies 780K **\$2349**
 EAGLE III same but 1 6M **\$3199**
 EAGLE IV 10M Hard Disk **\$4795**
 Software: Accounting Plus All 8 MOD only **\$1495!!!**
 EAGLE 1600 **\$ CALL**

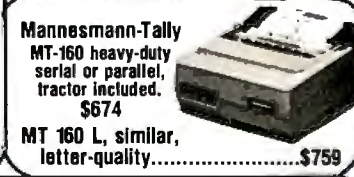

**Mannesmann-Tally
MT-160 heavy-duty
serial or parallel,
tractor included.
\$674**
**MT 160 L, similar,
letter-quality.....\$759**

NEW: COD 15-Day Exchange Privilege (subject to terms below)

ORDERS & INFORMATION:

Mo.-Fri. 9:00 AM-5:30 PM PST, Sat. 10:00 AM-4:00 PM PST
 1-800 845-5555 CA. AK. HI call (714) 783-1363
 BANK REFERENCE: BARCLAYS BANK OF CALIFORNIA (213) 892-7244



BHART APO, FPO, INTERNATIONAL ORDERS ACCEPTED
 INC. P.O. Box 3791, Riverside, CA 92519

TERMS: Prices in this ad apply to prepaid orders only, reflect 5% cash discount off our regular sale prices. Personal checks allow 2 weeks to clear. Fortune-1000 companies, Universities and Government only: 30-day net, based on our regular (non-cash) prices. COD based on non-cash prices and requires payment in full by Cashier's Check or Certified Check upon delivery. California residents add 6% tax. This ad supersedes all prior offers. Prices subject to change and offers may be withdrawn without prior notice. All merchandise new in original factory cartons, carry full manufacturer's warranty, and are covered by full insurance during shipping. Absolutely no return on used or damaged items. Software returnable ONLY in UNOPENED original wrapping. We now offer 15-DAY EXCHANGE PRIVILEGE, subject to 10% restocking charge on returned merchandise, and excluding special order items. Add 3% for Handling, Shipping & Insurance (\$3.95 minimum).

CP/M is a registered trademark of Digital Research. Microsoft MultiPlan are trademark of Microsoft Corp. CYMA is trademark of CYMA Corp. TurboDOS is trademark of Software 2000. Z80A is registered trademark of Zilog Inc. WordStar, SpellStar, CalcStar, DataStar, MailMerge are trademark of MicroPro Company. APPLE is trademark of Apple Computer Inc.

telephone lines, the computer must connect to a modem or data set (*data set* is the term used instead of *modem* in Bell System literature). The computer's modem communicates through the telephone network to another modem that connects to your terminal. This configuration involves two RS-232C interfaces: one between the computer and its modem and the other between your terminal and its modem. Official terminology labels both the computer and your terminal DTEs (data terminal equipment) and labels the modems DCEs (data cir-

cuit-terminating equipment, most often some sort of data-communication equipment).

Because you often want the choice of using your terminal with a modem or directly connecting it to a computer's output port, the RS-232C standard frequently provides both connections. Strictly speaking, the RS-232C standard was never intended for connecting a DTE device directly to another DTE, and most of its signals are unnecessary in that application. When manufacturers claim that a product is RS-232C-compatible

they usually mean that the equipment accepts and generates only a small fraction of the RS-232C signals and also doesn't violate any other parts of the standard.

Generally, the RS-232C standard covers such things as the protocol for answering calls and modem control for reversing the transmission direction in a half-duplex link. It does not, however, cover the requirements for autodial units. This information is provided by the companion specification, RS-366 (comparable to CCITT recommendation V.25), which defines how the computer presents the digits to be dialed to the autodialer, how the computer signals the end of the number, and what occurs when the autodialer cannot successfully complete the call.

The major drawback to RS-232C is its limited transmission distance of 50 feet. In practice, you can go considerably farther, but always at your own risk. A second disadvantage is its maximum transmission speed, although this is not usually a limitation in applications between computers and terminals. While RS-232C can operate at speeds up to 19,200 bits per second (bps), the data rate between computer and terminal is usually 9600 bps at best, and it is very difficult to transmit data even at this slower rate over the switched telephone network.

The distance restriction is not a serious disadvantage if you use modems to access a remote computer. The modems usually sit beside the computer and terminal, and the long-haul transmission takes place between them over telephone lines. In local applications, however, you often find RS-232C connecting terminals directly to computers, simply because it is obviously convenient to use the same terminal and computer interface whether or not a modem connection is used. This is where the 50-foot limit becomes restrictive. Furthermore, the RS-232C voltage levels are not particularly convenient because they aren't the same as those in standard TTL (transistor-transistor logic) and MOS (metal-oxide semiconductor) technologies now dominating computer implementations.

QUALITY COMPUTER FORMS AT PRICES YOU CAN AFFORD

WE SUPPORT MORE SYSTEMS WITH FORMS THAN ANYONE!

INVOICES • STATEMENTS • CHECKS • P.O.'S • SHIPPERS • MEDICAL FORMS
INCOME TAX FORMS • W2'S • LETTERHEAD

Accounting Plus • Altos Accountant • Apple Controller • Broderbund • Continental • Durango • Dynabyte • Gold • Great Plains • Libra Programming Inc. • Microcomputing Consultants • Open Systems • Peachtree • Radio Shack • Solomon • Star • State of the Art • Structured Systems • Systems Plus • TCS • TSE • Vector Graphics

We Support 215 Systems Not Listed Here. So If You Don't See Your Software Here Call Toll Free For A Free Sample Packet Of Forms For Your Software.

SHEERCUT WORD PROCESSING LETTERHEAD

SHEER CUT LETTERHEAD FROM CHECKS TO-GO USES A NEW PROCESS TO PRODUCE CONTINUOUS FORM PAPER THAT TRIMS CLEAN WHEN BURST. NORMAL COMPUTER PAPER USES FIVE PERFORATIONS PER INCH, BUT SHEER CUT USES A NEW TECHNOLOGY TO PRODUCE 80 PERFS OR "TIES" PER INCH. THIS PRODUCES A VERY CLEAN AND UNIFORM EDGE WHEN BURST, AND IS ECONOMICAL IN BOTH SMALL AND LARGE QUANTITIES. SHEER CUT IS AVAILABLE ON A STOCK FORM BASIS IN FOUR "CLASSIC LAID" PAPERS, OR IN ANY TYPE PAPER ON A CUSTOM ORDER. EVERY OTHER FORM CAN BE IMPRINTED TO PRODUCE CONTINUOUS FIRST AND SECOND SHEETS. BLANK PRICES ARE \$60 FOR 1,000, \$235 FOR 5,000 AND \$400 FOR 10,000, WITH IMPRINTING, DEALER, AND VOLUME PRICING AVAILABLE.

CONTINUOUS AND SNAP-OUT W2'S

AND OTHER CONTINUOUS
TAX FORMS



Checks To-Go

CALL TOLL FREE NOW: (800) 854-2750 IN CA (800) 552-8817
(619) 460-4975

SEIKOSHA
GP-100A

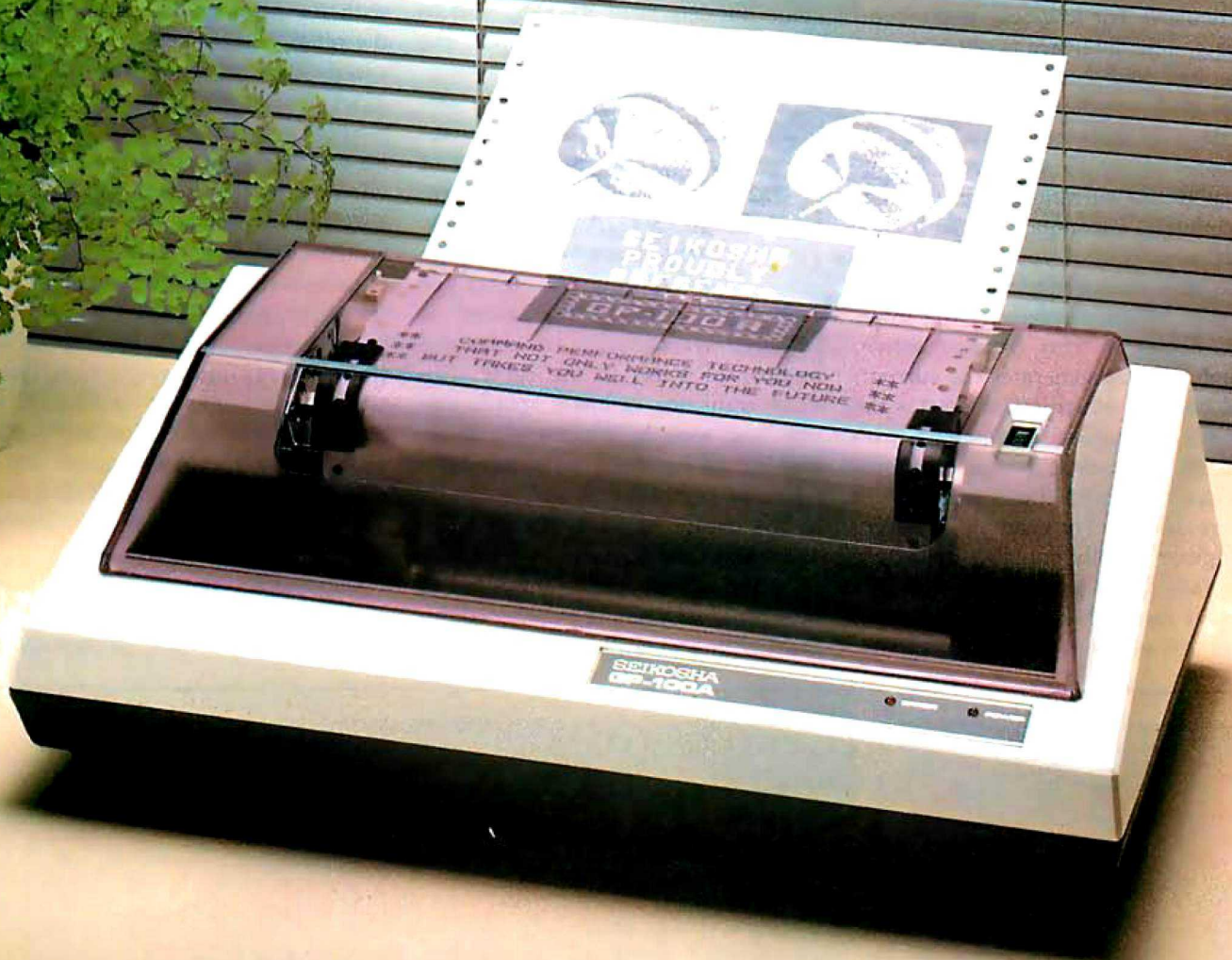

GP-100A: US\$389

COMMAND PERFORMANCE.

Seikosha gives you all the best features—including economy and super-clear graphics.

Unlike some graphic printers, Seikosha's new GP-100A Uni-Hammer Graphic Printer puts full dot addressable graphics at your command. The GP-100A lets you repeat a column of data as many times as needed with just one command. Software control enables double-width character output, and the positioning is both character and dot addressable. Designed for simple operation, it ranks among the most cost-efficient graphic printers on the market. Command performance technology that not only works for you now, but takes you well into the future.

Other valuable features:

- Graphics, regular and double width character modes can be intermixed on the same line.
- Automatic printing. When the text exceeds the maximum line length, there is no loss of data due to overflow.
- Self-test printing is a standard feature.
- Centronics type parallel interface.
- Paper width is adjustable up to 10 inches.
- Optional Interface: RS232C, IEEE488, apple II, etc.

Graphic Printer  Series

Available at COMPUTERLAND and other fine stores in your area

Circle 381 on inquiry card.

This means you need an additional power supply with this configuration.

Because of these problems with RS-232C, the current-loop interface, made famous by the original Teletype terminals, has come back in fashion, particularly for low-cost home computers. This interface is not a proper standard, with both 20- and 60-milliamp (mA) versions, but it usually works over distances of up to 1500 ft at rates of up to 9600 bps. Unfortunately, the current-loop interface is completely incompatible with RS-232C and requires you to use switchable, dual-standard hardware or conversion boxes. Moreover, the interface comes in two flavors: active, which actually generates the current, and passive, which either detects the current or signals by switching it on and off. The conversion boxes enable passive devices to communicate with active devices. For example, a microcomputer usually contains the active interface and a terminal has the passive one, which means you must have an active-to-active conversion

to directly connect two microcomputers.

Overcoming Defects

The EIA introduced standards RS-422A, RS-423A, and RS-449 to overcome the defects of RS-232C and to incorporate and improve upon the advantages of the current-loop interface. A major change was to unbundle the joint electrical, mechanical, and functional specifications of RS-232C. Just the electrical specifications are in RS-422A and RS-423A. To allow you to transmit data at high rates, RS-422A uses two wires for each signal. This setup, known as *balanced* transmission, doubles the number of wires in the cable. RS-423A transmits at lower speeds and uses one wire as a common return path for all signals. This is called *unbalanced* transmission and is similar to the design of RS-232C. The RS-423A standard operates in both RS-232C and RS-422A environments and thus provides users of existing equipment with a migration path to move

to the new RS-422A regime.

The EIA has introduced RS-449 as its intended successor to RS-232C. The standard provides a complete functional description of the signals needed for modem control, together with the mechanical specification of the plugs and sockets. The electrical specification for most signals is RS-423A, but RS-422A is also available for high-speed operation if necessary. RS-449 has a horrendous number of wires (46 as opposed to the 25 of RS-232C) in two plugs, one with 37 pins and one with 9. Fortunately, most applications don't require the signals in the 9-pin plug. Apart from its improved speed and distance specifications, RS-449 offers some minor functional enhancements over RS-232C in automatic modem testing and a provision for a standby channel, but it still does not incorporate dialing out. The success of RS-449 in the commercial market remains to be seen.

Meanwhile, the CCITT has been steering a different course. With its X.21 recommendation, introduced in

The Most Promising Duet For An Orchestra.

Our duet is perfect for a single user system.

The same duet performs even better in a multi-user orchestra.

MCM ★ 80:

S-100 Single Board Computer ■ Single or multi processor capability ■ Programmable master or slave selection ■ Redundant processor manipulation ■ 4MHz Z80A or 6MHz Z80B CPU ■ 64K RAM and 2K EPROM with monitor ■ 2 serial, 2 parallel, 4 timer ports ■ Bi-directional inter-processor channel ■ Dual mode serial ports interface ■ Multi-layer PCB construction.

\$495. Circle 216 on Inquiry card.



DCM ★ 80: S-100 Disk Controller Module ■ 8" and/or 5 1/4" floppy disk controller ■ SASI (ANSI, SCSI) hard disk host adapter ■ Single and double density, single and double side ■ Software implementation on CP/M¹ 2.2 and TurboDOS²

¹ TM of Digital Research, Inc.
² TM of Software 2000, Inc.

\$345.



JC SYSTEMS

1075 Hiawatha Ct.
Fremont, CA 94538
(415) 657-4215

NEC's crisp, clear, high-performance JC1203 RGB color monitor, an industry standard. Also available, the JC1212 composite video version.

NEC's classic JB1201 green monitor, one of microcomputing's performance legends. Easy on the eye, and the checkbook.

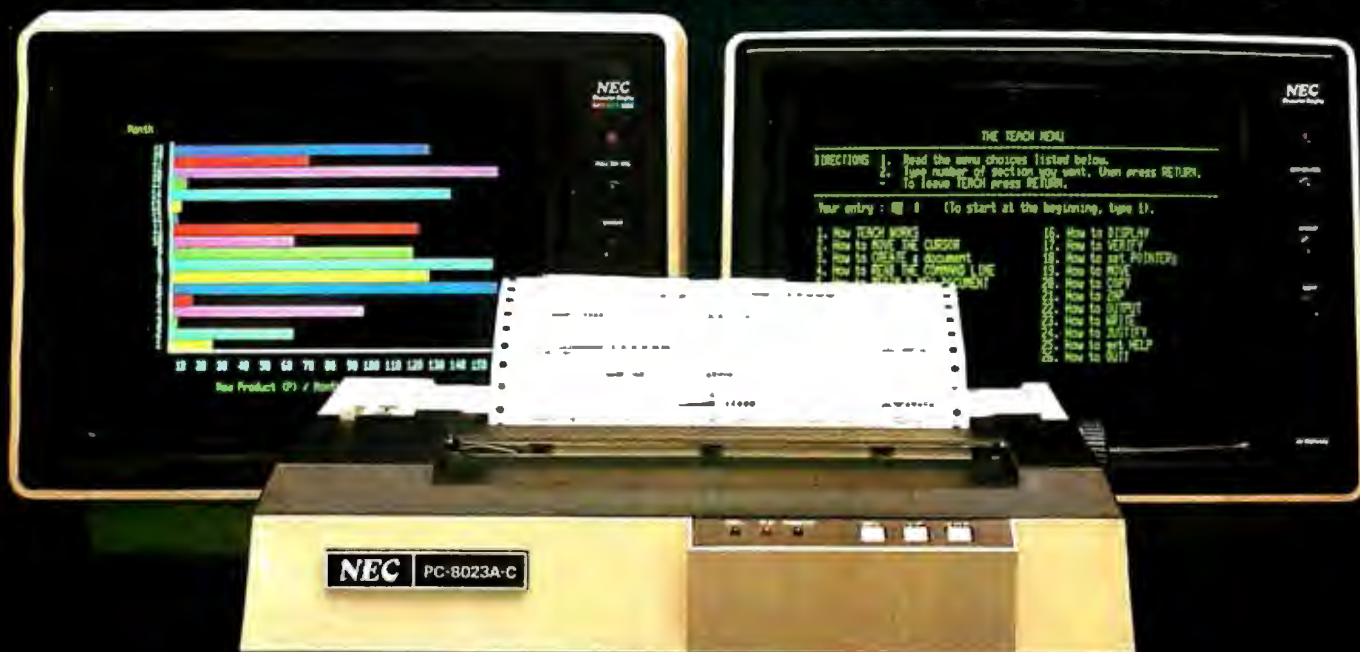

Our impressive new NEC dot matrix printer. Parallel interface, 100 cps, 2K buffer, pin or friction feed. Stunning performance and compatibility in the hottest new peripheral of the year.

Give your IBM system some NEC, and watch its performance soar.

Peripherals from NEC can make almost any computer system better.

Our sparkling new JC1203 color monitor is plug and pin compatible with the 16-color IBM® PC, and delivers the bright, sharp, clear, and stable screen image for which the entire NEC line has long been famous. Similar compatibility is available to owners of Apple II®, Radio

Shack®, and Atari® computers, not to mention our own outstanding NEC PC-8000 series. Also available is a brand new, extremely low cost, NEC green monochrome monitor, the JB1260, perfect companion for an Osborne®, for instance.

Ask your dealer for a demonstration. Or write us at 1401 Estes Avenue, Elk Grove Village, IL 60007.

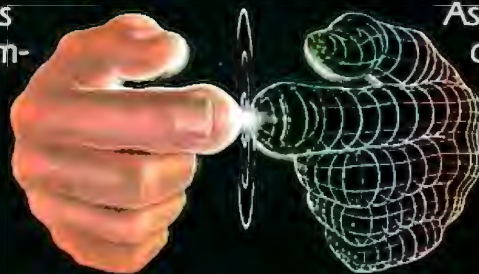

**Productivity
at your fingertips™**

NEC

**NEC Home Electronics (U.S.A.), Inc.
Personal Computer Division**

Nippon Electric Co., Ltd., Tokyo, Japan

Circle 294 on inquiry card.

ERG/68000 MINI-SYSTEMS

Full IEEE 696/S100

compatibility

HARDWARE OPTIONS

8MHz, 10MHz or 12MHz 68000
CPU

Memory Management

Multiple Port Intelligent I/O

64K or 128K STATIC RAM
(70 nsec)

256K Dynamic RAM, with full
parity (150 nsec)

8" D/D, D/S floppy disk drives

5MB-40MB hard disk drives

Full DMA host adaptor

20MB tape streamer

10 to 20 slot backplane

30 amp power supply

SOFTWARE OPTIONS

68KFORTH¹ systems language
with MACRO assembler and
META compiler

Fast Floating Point package

Motorola's MACSBUG

IDRIS² operating system with
C, PASCAL, FORTRAN 77,
68K-BASIC¹ compilers

CP/M—68K³ O/S with C,
Assembler, 68K¹-BASIC,
+ 68K¹-FORTH

Trademark 'ERG, Inc.

²Whitesmiths ³Digital Research

30 day delivery

with valid Purchase Order

OEM prices available

For CPU, Integrated Card Sets
or Systems.



Empirical Research Group, Inc.

P.O. Box 1176

Milton, WA 98354

206-631-4855

PIN	EIA	CCITT	Signal	Source
1	AA	101	Protective Ground	
7	AB	102	Signal Ground	
2	BA	103	Transmitted Data	DTE (computer interface)
4	CA	105	Request To Send	
20	CD	108.2	Data Terminal Ready	
23	CH	111	Data Signaling Rate Selector (DTE source)	
24	DA		Transmitter Signal Element Timing (DTE source)	
14			Secondary Transmitted Data	
19			Secondary Request To Send	
3	BB	104	Received Data	DCE (modem or terminal)
5	CB	106	Clear To Send	
6	CC	107	Data Set Ready	
22	CE	125	Ring Indicator	
	CF	109	Received Line Signal Detector	
	CG		Signal Quality Detector	
	CI		Data Signaling Rate Selector (DCE source)	
	DB		Transmitter Signal Element Timing (DCE source)	
	DD	115	Receiver Signal Element Timing (DCE source)	
	SBB	119	Secondary Received Data	
	SCB	121	Secondary Clear To Send	
	SCF	122	Secondary Received Line Signal Detector	

Table 2: RS-232C signals.

1976, it is obvious that the committee looks forward to the day when direct digital connection to a digital telephone network will be possible. Then all data transmission will be synchronous, and the communication equipment will provide bit and byte timing signals. X.21 includes the protocol for making and answering calls and for sending and receiving data using full-duplex synchronous transmission. Byte-timing signals are in fact an option, which the vast majority of digital telephone exchanges will almost certainly provide. In sharp contrast to RS-449, X.21 uses only six signals. The electrical specifications are in recommendations X.26 (corresponding to EIA RS-422A) and X.27 (EIA RS-423A).

Although X.21 is defined as the lowest (or "physical") level of the international X.25 packet-switching protocol, it is far ahead of its time, for direct digital connection to public telephone networks is hardly possible now. For this reason, CCITT offers

the X.21 bis recommendation as an interim measure to connect existing computer equipment to packet communication services. With this, the wheel turns full circle, for this recommendation is essentially the same as RS-232C (V.24), and sadly, its use is almost universal in packet-switching protocol today.

I have, in the tradition of all great guides, followed a circular path. To create a more detailed path through this standards jungle, let's look closer at each of the standards I have mentioned.

The RS-232C Standard

The 21 signals in RS-232C are numbered according to three systems: pin numbering used in the conventional 25-pin connector, the EIA RS-232C numbering, and the CCITT V.24 numbering (see table 2). I will explain each of the signals by providing a variety of different applications of the standard, each using progressively more signals.

board the bus

INDUSTRIAL QUALITY BOARDS FOR THE
IEEE-696/S-100 BUS

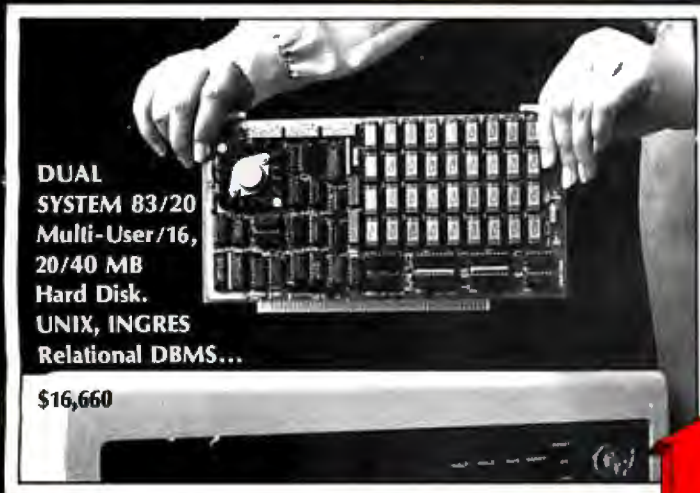

DUAL
SYSTEM 83/20
Multi-User/16,
20/40 MB
Hard Disk.
UNIX, INGRES
Relational DBMS...

\$16,660

CPU GROUP

CPU 68000

- MC68000 processor
- 10 MHz operation
- 16-Mbyte addressing
- Single-user

\$895

CPU 68000M

- MC68451 MMU
- Segmented memory management
- Multi-user

\$995

MEMORY GROUP

DMEM

- 256K dynamic RAM
- 24-bit addressing
- 230 ns access

\$1295

CMEM

- 8K/16K/32K CMOS
- 6 MHz for 8/16-bit
- Non-volatile with Li battery

\$695/\$595/\$495

EPROM

- 32/64K ROM
- 16-bit data paths
- 24-bit addressing

\$295

I/O GROUP

WDC-SMD

- DMA Winchester controller
- 25 ms access time
- No interleaving

\$1380

SIO4

- 4-port serial I/O
- 256 bytes of FIFO
- DMA transfers
- 24-bit memory addr.

\$695

CLK-24C

- Real time clock
- LSI CMOS chip
- Li battery backup

\$295

ANALOG GROUP

AIM-12 (A-to-D)

- 32 S.E. channels
- 25 μ -sec conversion
- 12-bit resolution

\$695

VIC 4-20

- 4 channels
- 20 mA outputs
- 12-bit performance

\$595

AOM-12 (D-to-A)

- 12-bit $\pm 1/2$ L.S.B.
- 0-10V, $\pm 5V$, $\pm 10V$ jumper select outputs

\$645

IEEE-
696/
S-100
BUS

DUAL

Sales representatives in most metropolitan areas.

OEM and Dealer pricing is available.

2530 San Pablo Avenue • Berkeley • CA 94702 • (415) 549-3854 • 172029 SPX

THE ULTIMATE IEEE/S-100 MEMORY WOULD...

- BE NONVOLATILE, retaining data for up to eight years after the power is off
- RUN AT 6MHz without slow down
- HAVE EXTENDED 24-BIT ADDRESSING and high output
- HAVE DYNAMICALLY MOVABLE WRITE PROTECT (IEEE S-100 standard is optional) for critical programs and critical data
- GENERATE POWER FAIR interrupts for reliable system operation & power failure recovery



CMEM

AVAILABLE NOW FROM DUAL SYSTEMS, the CMEM memory boards combine high-speed CMOS memories with a new 5-8 year lithium battery. The CMEM offers the nonvolatility of an EPROM board while retaining the instant writability of a high-speed read/write RAM. These industrial grade boards are subjected to a 168-hour burn-in and a 1000-cycle power interruption test to insure data retention and the highest degree of reliability possible.

CMEM-32K, 32K Bytes \$695
CMEM-16K, 16K Bytes \$595
CMEM- 8K, 8K Bytes \$495

DUAL

DUAL SYSTEMS CORPORATION

2530 San Pablo Avenue • Berkeley
CA 94702 • (415) 549-3854 • 172029 SPX

OUR PRICES, SELECTION AND SAME-DAY SHIPPING MAKE US COMPETITIVE.

Red Baron. Home of the Nation's

NEC 8023

Outstanding Graphics, Print
Quality & Performance



144 x 160 dots/inch • Proportional spacing
• Lower case descenders • N x 9 dot matrix
• 8 character sizes • 5 unique alphabets • Greek
character set • Graphic symbols • 100 CPS print
speed • Bi-directional, logic-seeking • Adjustable
tractors • Single-sheet friction feed • Vertical &
horizontal tabbing

NEC 8023
Dot MatrixList \$795 **\$Call**

IDS Prism 80/132

Affordable Color, Speed

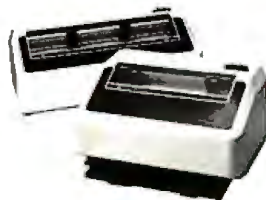

200 CPS • Bi-directional, logic-seeking • 24 x 9 dot
matrix • Lowercase descenders • 8 character sizes
• 80-132 columns • Proportional spacing
• Text justification • Optional color and dot resolution
graphics

Prism 80Base List \$1,299 **\$Call**
Prism 132Base List \$1,499

The Epson Series

High-Quality Printers
at a Low Price.



**WATCH
FOR NEW
FX
SERIES**

Epson MX-80FTList \$745 **\$Call**
Epson MX-100List \$995
Full Line of Epson Accessories

Smith-Corona TP-1

Daisy Wheel Printer For Under \$900



Letter quality • Standard serial or parallel data
interface • Drop-in ribbon • 144 WPM • Various
fonts available • Loads paper like typewriter
• Handles single sheets for forms

Smith-Corona TP-1List \$895 **\$Call**

Brothers HR-1 Daisy Wheel

Perfect for quality,
quiet word processing.



• 16 CPS • Prints up to 6 copies • Bi-directional
• Cloth or carbon quick-change cassette ribbon
• Quiet, efficient operation for word processing

Brothers HR-1
ParallelList \$1,100 **\$Call**
SerialList \$1,200

NEC Spinwriter

7700 & 3500

Daisy Wheel Quality Leader



High speed, letter quality • 55/33 CPS • Typewriter
quality • Bi-directional printing & proportional
spacing • Quiet • OCR quality print • Hi-res
plotting/graphing • Quick change ribbon • Optional
cut-sheet feeder, horizontal or bi-directional trac-
tors • Prints up to 8 copies

NEC Spinwriter RO
Serial Parallel 7700List \$3055 **\$2500**
Serial 3510List \$1895 **\$1700**

Anadex Silent Scribe

The Quiet Serial Matrix
Impact Printer



Up to 500 CPS • Dot addressable graphics
• Parallel and serial interfaces standard • Switch
selectable protocol • Cartridge ribbon • Foreign
character sets • Underlining • 1.5k to 12k buffer
• Correspondence quality print

	List	Discount
Anadex DP-9501A\$1,725	\$1300
Anadex DP-9620A\$1,845	\$1,475
Anadex WP-6000\$3,250	\$Call

Televideo CRT's

Price, Performance & Reliability



	List	Discount
910\$ 699	\$575
925\$ 995	\$730
950\$1195	\$945
970\$1495	\$Call

Monitors

Crisp, Clear, Compatible



Amdek
Video 300, greenList \$249 **\$Call**
Color IList \$499
for low prices

OUR PEOPLE MAKE US EXPERTS.

Largest Computer Printer Inventory.

The Grappler+™ Apple® Graphics Interface

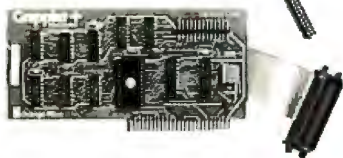

- Graphic and text screen dumps • Dual Hi-Res Graphics • Printer Selector Dip Switch • Apple III compatible • Inverse Graphics • Emphasized Graphics • Double Size Picture • 90° Rotation • Center Graphics • Works with Pascal and CPM® • Optional Bufferboard Available

Grappler + **\$175**
*Requires software driver
Apple is a registered Trademark of Apple, Inc.

The Bufferboard™ For Apples and Printers

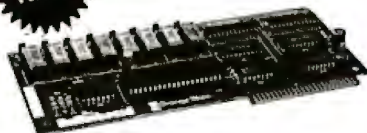

Take your existing printer interface—and buffer it!

- Versions for Grappler+, Apple interface, Epson interface, and others • Comes standard with 16K buffer • Expandable to 32K and 64K • Includes interface docking cable

The Bufferboard **\$175**

IDS Microprism 480 Prints like a daisy, priced like a matrix!



- Correspondence Quality in a Single Pass • Dual Speed 75, 110cps • Proportional Spacing • Bi-directional, logic-seeking • Platen Pin or pressure feed • 24 x 9 dot matrix • 10, 12, 16.8 Characters per inch • Doublewidth Characters

IDS Microprism 480List \$799 **\$Call**



Customer Benefit Package

1. Free Expert Consultation. 2. Technical Staff. Even your most involved questions get quick, helpful answers from our staff of printer technicians.
3. Free Catalog. Get your informative catalog with printer comparison chart and print samples today.
4. Warranty. The manufacturer's warranty where applicable.
5. Same-Day Shipping.
6. Free MasterCard and Visa.
7. We Stock What We Sell. We make every effort to keep a large stock of our advertised products.
8. APO/FPO Orders Welcome.

The Okidata Series Hi-Res or TRS 80 Block Graphics



120/200 CPS • 9 x 9 Matrix • Bi-directional, logic-seeking printing • Lower case descenders • Four print styles • Optional Hi-Res Graphics

Okidata 82AList \$649
Okidata 83A (w/Tractor) .List \$995
Okidata 84 (Parallel) . . .List \$1395 **\$Call**

Interface Equipment Complete Stock of Options, Cables and Accessories

CCS APPLE SERIAL Interface & Cable . . . \$150
SIGNALMAN MODEM \$Call
COMPLETE STOCK OF EPSON
ACCESSORIES \$Call
CUSTOM PRINTER CABLES FOR
Apple, Atari, IBM, TRS-80 (all models) . . \$Call
HAYES MICROMODEM II \$300
PRINTER STANDS: Large \$ 99
Small \$ 25
PRINTER RIBBONS—Most Types \$Call

Here's How To Order:

Phone orders are welcome; same-day shipment on orders placed before 11:00 a.m. Free use of MasterCard and Visa. COD's accepted. Personal checks require 2 weeks clearance. Manufacturer's warranty included on all equipment. Prices subject to revision.

Call For Free Catalog:

(800) 854-8275
CA, AK, HI (714) 779-2779



Circle 369 on Inquiry card.

ieim, CA 92807

Video Display Terminal—signals used: *Protective Ground, Signal Ground, Transmitted Data, and Received Data.* The Protective Ground is for safety and connects to the equipment chassis at both ends of the link. The Signal Ground establishes a common ground reference voltage for all data signals. Transmitted Data is the data path from the computer interface to the terminal, while Received Data is the path in the reverse direction. You don't need any other connections for a simple asynchronous RS-232C-compatible terminal interface.

Serial Printer—signals used: *Protective Ground, Signal Ground, Transmitted Data, and Data Set Ready.* Because the data connection to the printer is only in one direction, you don't need the Received Data line. However, most printers cannot accept characters continuously at an even rate. For example, a daisy-wheel letter-quality printer takes a significant time to move the print head from one position to another, and so the

printing rate depends on character spacing. A Return character generally takes longer than other characters because in most cases the print head has to move farther across the paper than for other characters. This presents the problem of flow control; the printer must provide feedback to the computer interface to control the data flow. The Data Set Ready line is one way to provide the feedback.

You can use the ASCII control codes DC1 and DC4 to regulate data flow to a serial printer.

Actually, Data Set Ready has other purposes. A modem uses it to indicate that its power is on and that the modem is ready to receive data for transmission. Many software device drivers examine this signal before transmitting each output character and simply delay transmission until it is in the on state. Therefore, you can

use the signal for flow control, even though it was not designed for that purpose. You can also use other lines, such as Clear To Send, for the same purpose.

Another technique for regulating data flow to a device like a serial printer is to use the ASCII (American National Standard Code for Information Interchange) control codes DC1 (device control 1, often called XON) and DC4 (often called XOFF). These codes correspond to the control characters Control-Q and Control-S respectively. Some software device drivers use them to suspend and resume output to a terminal. When you use these codes for flow control on a printer, you connect the Received Data line rather than the Data Set Ready line. The printer then transmits Control-S when its buffer is full and Control-Q when it is ready for more data.

Many printer manufacturers cater to both flow-control methods. However, in practice, significant problems can arise with each of them. When the printer is connected through a modem, there is no connection between the states of the Data Set Ready lines at the two ends of the link, and so you can't use the first method, which is meant for purely local use. The XON/XOFF protocol should work fine over a telephone connection, provided the operating system you use responds quickly to the XOFF control character. While a few extra characters don't usually matter on a video display terminal, they can mean a disastrous buffer overflow for a printer. The same result may occur due to characteristics of a terminal multiplexer, which in many cases has internal character buffers that store several characters awaiting transmission. When XOFF arrives, the data to the printer will not cease immediately, even if the operating system instantly stops sending characters. In another case, if you connect your printer to the printer port provided on some terminals, you may again see a delay in the execution of the XOFF command due to the buffering going on in that unit.

Remember that RS-232C was never

HIGH RESOLUTION GRAPHICS FOR SUPERBRAIN, COMPUSTAR, Z-89 & TRS-80 MODEL II.

XCEL™ HARDWARE: A retrofit package for graphics display with 512 x 240 resolution. TRS-80 Mod. II, \$595. All others, \$895.

XCEL™ SOFTWARE: Operates under CP/M™ and is compatible with Basic, Fortran, Cobol, PLI and Pascal.

SYMBOL GENERATOR- \$175

Alternate character sets with bold face, 90° rotation, circles, quadrants, vectors, rectangles and area fills.

GRAPH PLOTTER- \$175

Line, graph, histogram, bar graph and scatter plot with automatic annotation of axes scaling.

3-D GENERATOR- \$345

Creating, editing and viewing "wireframe" objects from any angle with scaling zoom and graphics editor.

SURFACE PLOTTER- \$395

True perspective view with hidden line removal.

GRAPHICS TERMINAL- \$395

Configures computer as a low cost graphics terminal.

"NEW" SCREEN PRINTER- \$65

Allows hard copy printout on most dot matrix printers.

SAVE UP TO \$950 ON PACKAGE PRICE OFFERS!

FOR MORE INFORMATION CALL (213) 320-6604



MAXTEK, INC. 2908 Oregon Court, Torrance, CA 90503

Available in Europe from Micronex Ltd., Chew Magna, England 3042 (STD 027-589 3042)

TRS-80 registered trademark. Tandy Corp. Superbrain trademark. Interdoc Data Systems. Tektronix registered trademark. Tektronix, Inc. CP/M registered trademark. Digital Research.

"What if ...

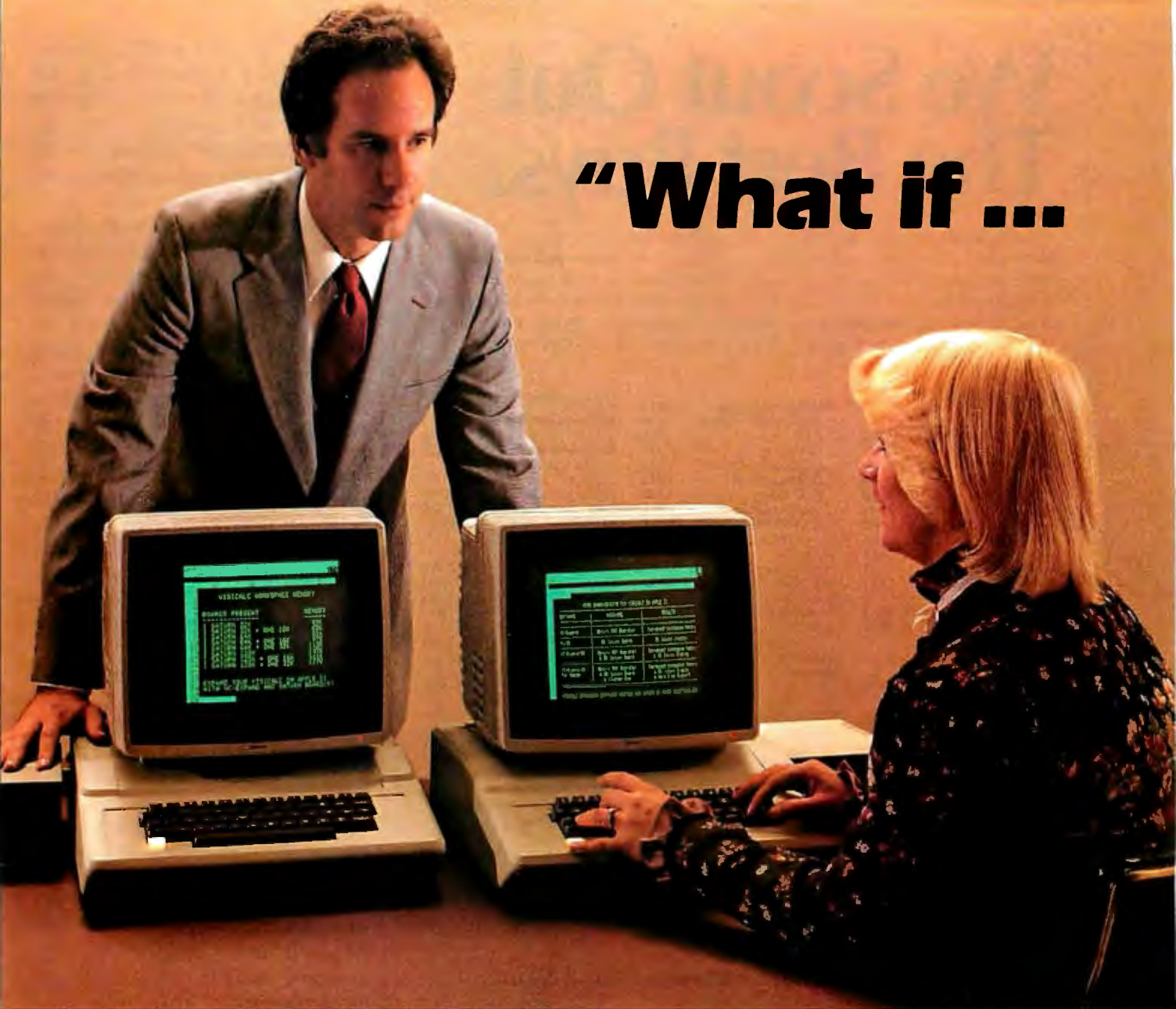

I run out of memory?"

Most people *do* run out of memory with only 18K VisiCalc* workspace. But you can expand your Apple II* to 177K VisiCalc memory! You can also get 80-column display, lower case letters, and hard disk

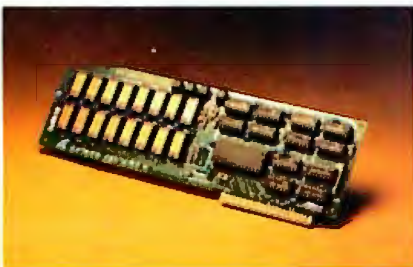

support—all without buying a bigger computer.

The Saturn expansion system for VisiCalc consists of a preboot diskette, one or more plug-in RAM boards, and an optional 80-column display board. You can put the Saturn boards in any slot. And with all that memory, our software lets you save files on more than one diskette.

Each Saturn RAM board includes additional software for other programming applications. So your BASIC, PASCAL, and CP/M programs get an extra bonus.

Ask your computer dealer for more details about the Saturn memory expansion systems. See how much bigger and better your models can become!

*VisiCalc is a registered trademark of VisiCorp. Apple II is a registered trademark of Apple Computers, Inc.

SATURN SYSTEMS INC.

P.O. Box 8050
3990 Varsity Drive
Ann Arbor, MI 48107

1 (313) 973-8422

We Scout Out The Best Buys.

THE PURCHASING AGENT is your computer buying company. We negotiate the purchase of millions of dollars of hardware **and software** at the best prices each year. Our buying power gives you more hardware and software for your money. Our fee is 25% of what we save you off list price. By participating in the savings, we share a common goal — to save you money.

Call us for your price on any product not listed. All prices shown include our fee.

COMPUTERS

Alpha Micro 1000 VW	\$5,960
Alpha Micro 1030	12,047
Alpha Micro 1051	17,634
Alspa ACT-2/55	2,320
Altos 8000-10	5,850
Altos 8600-10	7,586
Altos Series 5-15D	2,100
Altos Series 5-5D	4,195
Apple Computers	CALL
Associate	CALL
Burroughs	CALL
California Computer Systems 300-1A	4,414
Columbia Data	CALL
Compupro Godbout™	
Sys. 816/A*	4,200
Sys. 816/B*	5,360
Sys. 816/C*	6,880
*Assembled and tested	
Cromemco System 1	2,946
Cromemco System 2	3,400
Cromemco 68000 System 1	4,395
Dynabyte	26% OFF
Eagle II	2,350
Eagle 1600	5,420
Epson Computer	CALL

IBM Personal comp.	CALL
Amdek Color III term.	430
AST	CALL
Baby Blue	CALL
Dawong 5 meg. H.D	1,575
Diablo 630 API	1,825
NEC 3550	1,920
Seattle boards	CALL
& all IBM peripherals	CALL
Micromation	CALL
Molecular	CALL
Morrow Micro Decisions	CALL
NEC 16 bit APC system	CALL
NEC 8000 64K PC sys.	2,266
NorthStar Advantage	2,625
NorthStar Adv. H.D. 5	4,395
Onyx 5001 MU-6	7,350
Onyx 8000 MU-10	7,900
Osborne	CALL
Sanyo 1000	1,540
Seattle System 2	3,251
Televideo TS-802	2,600
Televideo TS-802H	4,450
Televideo TS-806	5,200
Vector 2600	3,895
Vector 3005	5,495
Vector 4	CALL
Victor	CALL
Zenith 100	CALL

PRINTERS

Brother, parallel, daisy	910
C ltoh. F-10, daisy	1,350
Daisywriter 2000	1,120
Diablo 620, daisy	
25 cps	1,195
Diablo 630, daisy	2,050
IDS Prism 132 options	1,430
NEC 3510	CALL
NEC 7710 R/O	2,325
NEC/Sellum 1, 16K, tractor	2,595
Qume 9/45 full panel	1,865
Qume 9 55 full panel	2,180
Smith Corona TP-1, daisy	681
Tally	CALL
Texas Instr. TI 810	1,240

OTHER PERIPHERALS

Amdek Color II term	694
Ventel 212+ modem	765
Corvus 10 meg. H.D.	2,995
Houston Instr. DMP-29	1,549
Houston Instr. DMP-40	775
Morrow 20 meg. H.D.	3,650

SOFTWARE

Call for prices on all your software needs.

Mastercard, VISA at 3% handling fee. Prices subject to change without notice. Minimum fee \$150.

EXPORT SERVICES AVAILABLE.

We are agents for overseas computer dealers and distributors. INTERNATIONAL TELEX 470851

On The Frontier of High Technology and Value.



**THE
PURCHASING
AGENT**

1635 School Street
Moraga, CA 94556

Call Toll Free
800-227-2288
In California
(415) 376-9020



intended for DTE-to-DTE connections. Thus it is not surprising that problems arise when the standard is used for such purposes. After all, these flow-control methods are ad hoc mechanisms tacked on to an unsuitable standard.

Full-Duplex Private-Line Modem—signals used: *Protective Ground, Signal Ground, Transmitted Data, Received Data, Received Line Signal Detector*, and (possibly) *Data Set Ready*. The Received Line Signal Detector, often called Carrier Detect, says in effect, "I hear something like a modem talking to me." You use this signal to tell the computer that someone is trying to make contact on that line. You could use it to trigger the computer to generate a log-on invitation. Data Set Ready may indicate that the modem is ready and not in voice or test mode, but this is not a common practice in North American asynchronous modems.

Half-Duplex Private-Line Modem—signals used: *Protective Ground, Signal Ground, Transmitted Data, Received Data, Request To Send, Clear To Send, Received Line Signal Detector*, and (possibly) *Data Set Ready*. Request To Send and Clear To Send control the transmission direction in the half-duplex operation. The computer generates Request To Send when it wants to transmit. The Clear To Send signal indicates that the modem is ready to receive characters for transmitting. There will be a delay—typically 200 milliseconds (ms)—between the Request To Send signal from the computer and the Clear To Send handshake, because the modem must generate the carrier waveform and allow it to stabilize. When the transmission finishes, the computer drops Request To Send, causing the modem to turn the transmitter off. To ensure that both ends of the link cooperate in choosing the direction of the transmission, you need a software protocol.

Switched Network Auto-Answer Modem—signals used: *Protective Ground, Signal Ground, Transmitted Data, Received Data, Request To Send, Clear To Send, Data Terminal Ready, Ring Indicator, Received Line Signal Detector*, and (possibly) *Data*

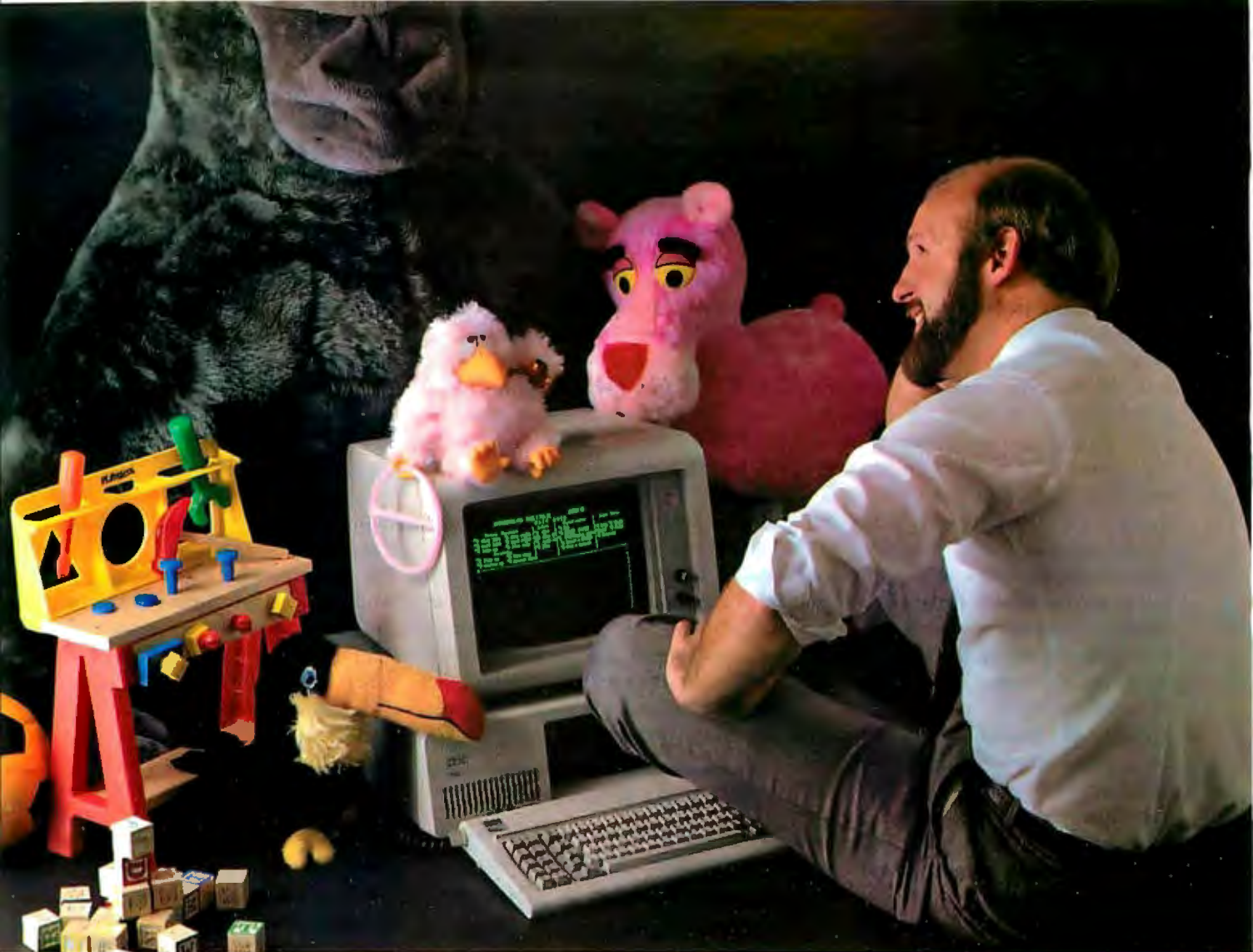

This Programming professional deserves a lot more from his personal computer.

He's earned it. As a seasoned professional, he's learned to master some of the world's most advanced programming tools. Tools specially designed to meet the everyday demands of programming experts.

But as the owner of a personal computer, he's come to expect less. Less performance. Less sophistication. And less flexibility.

Why should programming a personal computer be any different?

Prior to the announcement of micro/SPF™ development software, experienced programmers felt programming a personal computer was a lot like playing with a toy. You couldn't take it seriously.

But today, there's micro/SPF™ a solution to elementary program editing tools now offered with most micro-computers.

With micro/SPF™ you get the same procedures and commands experienced programmers are accustomed to using at work. By mimicking features found in

standard SPF software, micro/SPF™ provides all the sophisticated utilities programming professionals expect.

Programming experts can take advantage of skills they've spent years perfecting.

Now, for the first time, mainframe software is available for personal computers. SPF screens are fully reproduced in logical sequence and each screen is formatted identically to those found in the SPF system.

In addition, micro/SPF™ comes equipped with the same primary and line commands, tutorial messages and program editor (with program function keys) experienced programmers are used to.

Programming professionals who've spent years perfecting the art of writing sophisticated code deserve to work with state-of-the-art tools, not toys. Find out how micro/SPF™ can help you do work-compatible programming on your personal computer today!

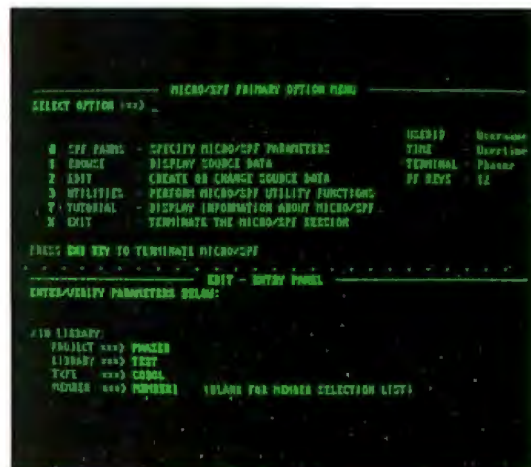

PHASER

PHASER SYSTEMS, INC. 50 WEST BROKAW ROAD
SAN JOSE, CA 95110

Set Ready. Here, the additional signals are Data Terminal Ready, which shows that the computer is ready to receive calls, and Ring Indicator, which signals that the modem has received a new call. The Ring Indicator signal goes up and down as the telephone bell rings so that the computer can answer after a specified number of rings. If the computer leaves Data Terminal Ready on, the modem answers incoming calls immediately. If it is off, the computer should turn on the signal, after the appropriate number of rings, to answer the call. At the completion of the call, the computer should turn off Data Terminal Ready to ensure that the line is disconnected. Normally this is not necessary, because the line should disconnect automatically when the calling party hangs up the phone, but it is good practice to force disconnection at both ends.

Dual-Rate Modems—extra signals used: *Data Signaling Rate Selector (DTE source)* and *Data Signaling Rate Selector (DCE source)*. Some modems allow switching between two transmission speeds. These two signals control whether the modem uses the high or low speed. Usually the modem at the calling end sets the speed for the connection. In this case, the calling computer uses the Data Signaling Rate Selector (DTE source) to determine the line speed. The calling modem signals the speed to the answering modem, which informs the called computer by setting Data Signaling Rate Selector (DCE source) appropriately.

Synchronous Modems—Extra signals used: *Signal Quality Detector*, *Transmitter Signal Element Timing (DTE source)*, *Transmitter Signal Element Timing (DCE source)*, and *Receiver Signal Element Timing (DCE source)*. Synchronous modems provide a clock signal along with the data. In the case of received data, the modem provides the Receiver Signal Element Timing (DCE source) or the clock. For transmitted data, the modem may still provide the clock signal on Transmitter Signal Element Timing (DCE source). Or the computer equipment (DTE) may generate a timing signal instead, called

Transmitter Signal Element Timing (DTE source). Synchronous modems also provide a signal which shows whether or not there is a high probability of an error in the received data (Signal Quality Detector).

Modems with Primary and Secondary Channels—extra signals used: *Secondary Transmitted Data*, *Secondary Received Data*, *Secondary Request To Send*, *Secondary Clear To Send*, and *Secondary Received Line Signal Detector*. Some modems provide a primary transmission channel with a high data rate (e.g., 1200 bps) and a secondary channel in the reverse direction with a much lower data rate (e.g., 75 bps). The reverse channel allows you to listen and confirm reception or to interrupt the transmitter. The channel directions can be reversed, and the above set of five signals allows you to control the secondary channel in much the same way as the primary one.

Do you know what happens when you make a call to a computer on a 300-bps full-duplex switched line?

A Scenario

The following sequence of events, illustrated in table 3, will show you what happens when you make a call to a computer on a 300-bps full-duplex switched line. To begin, the computer expects a call and so it leaves Data Terminal Ready on, which in turn sets the computer's modem ready to answer a call as soon as one is received. When this happens, the computer sees Ring Indicator (which it can ignore because Data Terminal Ready is already on) and Data Set Ready (the signal for the computer to generate Request To Send). In the preceding section, I explained Request To Send and Clear To Send in the context of half-duplex calls. In fact, full-duplex modems use them also. Request To Send commands the modem to turn on its transmitter. After a short delay, the computer sees Clear To Send and ig-

nores it. At the other end of the line, you hear the carrier signal and either push the data button (on a data set) or put the telephone handset onto the acoustic coupler. Now your modem's transmitter turns on, producing its own carrier whistle. When the modem at the computer end hears this, it turns on Received Line Signal Detector. Upon receiving this signal, the computer begins sending data. Many operating systems, however, ignore this signal and simply wait for you to send a character to begin the log-on process.

At the end of the transmission, assume that the computer decides to terminate because you logged off. The computer turns off Request To Send, which then turns off the computer's modem carrier signal. The computer then turns off Data Terminal Ready, forcing the line to be disconnected. Meanwhile, in your modem, Received Line Signal Detector goes off and generates a warning note to you. You replace the handset, ensuring that the line disconnects from your end also. When the computer sees its Received Line Signal Detector turn off, it knows that the disconnection is complete, and so raises Data Terminal Ready in preparation for the next call.

RS-232C and RS-449: What's the Difference?

RS-232C is being superseded by a new standard, RS-449. Technically, the major differences between them result from RS-449's using improved electrical-transmission standards. To explain these improvements, I will first describe the electrical specifications of RS-232C.

An RS-232C transmitter generates a voltage of above +5 volts (V) to signal one line condition, called Space, and a voltage of below -5 V to signal the other condition, called Mark. To produce these voltages, you generally use a power supply of ± 12 V. A receiver recognizes voltages of above +3 V as Spaces and voltages of below -3 V as Marks (see figure 1). When a signal changes from one condition to the other, it can spend, at most, 4 percent of a bit period (the duration of a bit: 2

ScratchPad

The Ultimate Spreadsheet for CP/M-86[®], IBM PC DOS[®], and CP/M[®]

The Ultimate Spreadsheet? YOU BET!

Packed with more important features and performance than any other spreadsheet, ScratchPad is perfect for "what if" analyses and financial modeling of all kinds.

The features tell the story:

Flexible Spreadsheet

A ScratchPad innovation. Now you can design the spreadsheet to fit your application, rather than redesigning your application to fit the spreadsheet. For example, if you need a worksheet that is extremely wide but not very deep, ScratchPad can do it. The matrix dimensions are up to you.

Virtual Memory

Another ScratchPad innovation. When your computer runs out of memory in RAM, your disk drives act as backup memory for additional spreadsheet data. (This is something the VisiCalc and SuperCalc people don't talk about in their ads. They can still run out of memory!)

ScratchPad with a hard disk on the IBM PC, for example, allows in excess of 20,000 entries! NEVER see those disastrous OUT OF MEMORY messages again.

Consolidation

This lets you combine several spreadsheets, adding or averaging the numeric data. It is especially useful to businesses that want to combine data from several departments, or add or average spreadsheets from different months or years. Just another reason why ScratchPad is the ultimate spreadsheet.

Circle 398 on Inquiry card.

These features and many others make ScratchPad the most powerful spreadsheet available! So, find out why we call ScratchPad the Ultimate Spreadsheet.

Write: ScratchPad Information, SuperSoft, Box 1628, Champaign, IL 61820.

This is what others are saying:

Small Business Computers, July/August '82
"In our opinion ScratchPad is an excellent business-oriented spreadsheet program, easy to learn, easy to use, and well documented."

InfoWorld, Sept. 6, '82
"ScratchPad... (is designed) for users who want entry simplicity and fast answers."

Business Computer Systems, Sept. '82
"... a new memory innovation from SuperSoft... ScratchPad(s) virtual memory can accommodate an essentially unlimited number of entries by tapping the disk drive for secondary memory."

Available for IBM PC DOS, CP/M-86 and CP/M.
ScratchPad: \$295.00
(Requires 96K with PC DOS, 64K with CP/M-86, and 56K with CP/M)*

Japanese Distributor: ASR Corporation International, 3-23-8, Nishi-Shimbashi, Minato-Ku, Tokyo 105, Japan. Tel. (03)-4375371 Telex: 0242-2723.

European Distributor: Micro Technology Ltd., 51 The Pantiles, Tunbridge Wells, Kent, England TN2 5TH. TEL. 0892-45433. Telex: 95441 Micro-G.

*Additional memory recommended for optimal performance of all features.

IBM Personal Computer is a trademark of International Business Machine Corp.
CP/M and CP/M-86 are registered trademarks of Digital Research.
VisiCalc is a registered trademark of VisiCorp.
SuperCalc is a registered trademark of Sorcim.

SuperSoft[®]

FIRST IN SOFTWARE TECHNOLOGY P.O. Box 1628 Champaign, IL 61820 (217) 359-2112 Telex 270365

Terminal	Line	Computer
		Data Terminal Ready is on in anticipation of a call
raise handset and dial		
	connect call	
		see Ring Indicator and Data Set Ready, generate Request To Send
	carrier whistle	
hear carrier (analogous to Received Line Signal Detector)		(after short delay, see Clear To Send)
push data button (see Data Set Ready light)	carrier signal	
		see Received Line Signal Detector
	—carry on communication—	
		set Request To Send off
	no tone from computer	
		set Data Terminal Ready off, Clear To Send and Data Set Ready go off
modem's Received Line Signal Detector goes off, modem generates warning note, replace handset		
	call disconnected	Received Line Signal Detector goes off, set Data Terminal Ready on in preparation for next call

Table 3: The sequence of events in a 300-bps dialed call, proceeding from top to bottom.

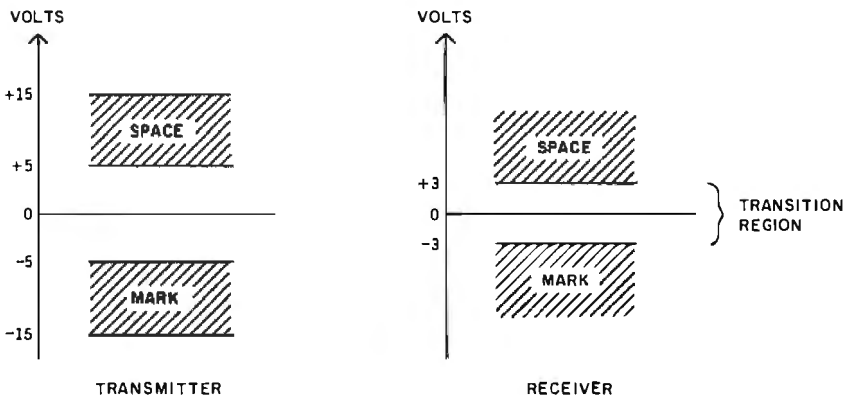

Figure 1: RS-232C signal levels.

microseconds at the maximum speed of 19,200 bps) in the transition region. This requirement limits the amount of stray capacitance allowable in the transmission link because capacitance smooths out sharp transitions. RS-232C specifies that the capacitance must not exceed 2500 picofarads (pF); and, because ordinary cables have a capacitance of 40 or 50 pF per foot, RS-232C limits cables to 50 feet.

A second difficulty of RS-232C is its grounding arrangements with two separate lines: Protective Ground and Signal Ground. Unfortunately the standard does not state clearly how these signals are to be used. In many implementations, the Protective Ground is simply not connected.

Grounding for distributed analog systems is a notoriously difficult subject. To give you a simple idea of the problems that could occur, imagine an RS-232C link between two pieces of equipment where Protective Ground is not connected but where Signal Ground is connected to the earth at both ends (this is quite a common arrangement). Different ground potentials at the ends of the link cause a ground current to flow through the Signal Ground wire. The inevitable resistance in this wire insures that a potential difference between the Signal Grounds exists that could, if large enough, cause the data to be received incorrectly.

The obvious way to overcome ground potential differences between the transmitter and the receiver is to send the signal differentially on two wires. The difference between the voltages on the wires determines whether a Mark or a Space is read. This is how RS-422A works, and you may recall that this technique is known as balanced transmission. Figure 2 shows an RS-422A signal, carried on a twisted pair of wires. A balanced transmission would use two of these signals.

Of course, you can regard even RS-232C as transmitting a signal differentially, with the difference being between the signal-wire voltage and the ground-wire voltage. What makes this approach inferior is that the ground wire actually connects to the

IMAGINE IT...

NEW
NOW WITH
DUAL HI-RES
GRAPHICS

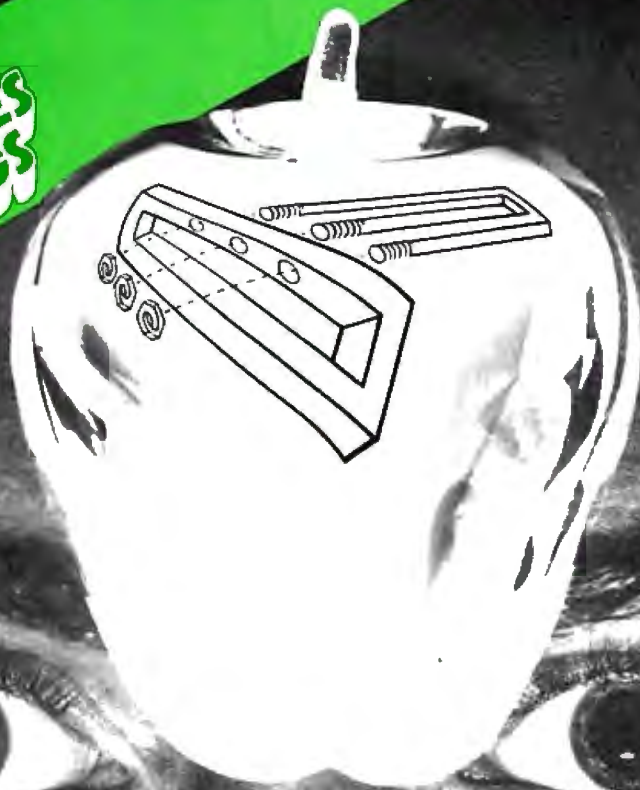

CAPTURE IT

Completely Redesigned.

Now, the Grappler + .

The original Grappler was the first graphics interface to give you hi-res screen dumps from your keyboard. The new Grappler + with *Dual Hi-Res Graphics* adds flexibility with a side-by-side graphics printout of page 1 and page 2.

The Grappler + can now be used with the Apple® Dot Matrix, the Okidata 84, and is Apple III compatible.* In addition, the IDS Grappler + is currently available with color capability, including color graphics screen dumps.

The imitations are many, so insist on the #1 Apple graphics interface on the market. Insist on the Grappler + . Available now at most Apple dealers.

*Requires additional software driver.
**Requires graphics upgrade.

Circle 309 on inquiry card.

© Orange Micro, Inc. 1982

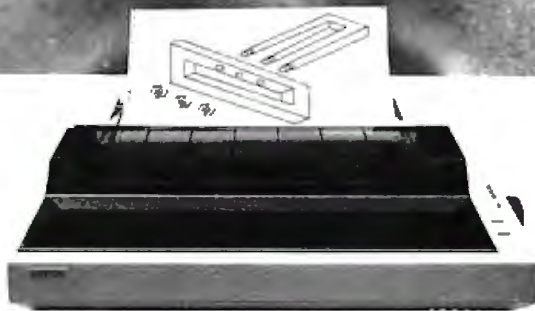

Grappler +

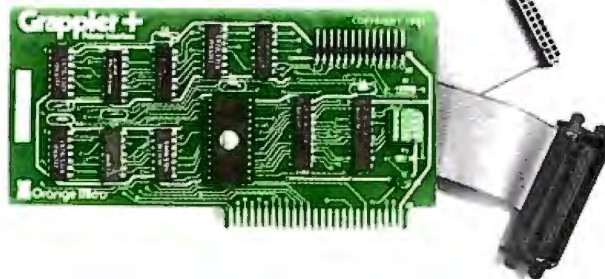

- The Grappler + Features:**
- Dual Hi-Res Graphics • Printer Selector Dip Switch • Apple III Compatible* • Graphics Screen Dump • Inverse Graphics • Emphasized Graphics • Double Size Picture • 90° Rotation • Center Graphics • Chart Recorder Mode • Block Graphics • Bell Control • Skip-over-perf • Left and Right Margins • Variable Line Length • Text Screen Dumps.

The Grappler + also works with Pascal and CPM.

The Grappler + interfaces with the following printers:

- Anadex • Apple Dot Matrix • Centronics 122 • C. Itoh ProWriter • Epson MX-70, MX-80** , MX-80F/T** , MX-100 • IDS 460, 560, Prism 80 and 132, Microprism • NEC 8023 • Okidata 82A** , 83A** , 84.

Orange Micro
Inc.

1400 N. Lakeview, Anaheim, CA 92807
U.S.A. (714) 779-2772 Telex: 183511 CSMA
Foreign Dealer Inquiries Welcome

CPM is a registered trademark of Digital Research, Inc.
Apple is a registered trademark of Apple Computer, Inc.

IBM
personal computer
UCSD
p-System™
Version IV.1

NCI now offers
 Version IV.1 which includes:

- RAMdisk
- Subsidiary Volume Support
- 8087 Numeric Coprocessor Support
- FASTER Long Integers (2x)
- FASTER Floating Point (3x)
- 25% greater floppy storage
- Floppy Write Verification
- Asynchronous Serial I/O
- Extended memory codepool
- 8086/87/88 Macro Assembler
- 8087 Native Code Generator
- program caller unit
- generalized sort unit
- 32 bit seek
- FASTER Seek
- FASTER Turtlegraphics
- Adaptable Support
- PC DOS Filer Utility
- Background Spooler

Also available

- PFAS Pascal File Access System
- Hard Disk Support
- Advanced Systems Editor
- Sprinter text formatter
- QuickISAM/PascalISAM/SuperDB
- QuickForm/PascalForm

Available for

- IBM pc
- Victor 9000

TM Regents University California
 TM IBM Corporation

For more information call

Network Consulting Inc.
 Discovery Park
 Suite 110-3700 Gilmore Way
 Burnaby, B.C. Canada V5G 4M1
 604-430-3466

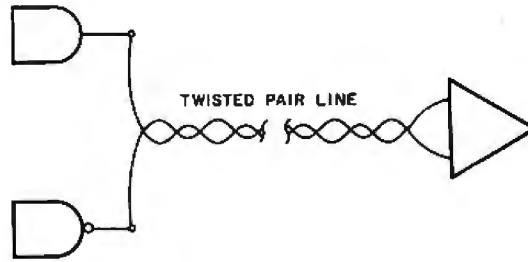

Figure 2: An RS-422A signal.

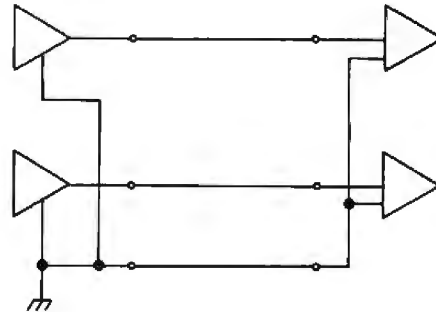

Figure 3: Two RS-423A signals.

ground at each end. Then if the ground potentials differ, the ground wire carries a substantial current. The amount of the current depends on the ground-potential difference and the electrical resistance of the ground wire. This current makes the potential of the ground wire different at each end. The RS-422A grounding requirements are much less critical than those of the RS-232C because the standard does not use ground as a voltage reference. Therefore, the use of the Signal Ground wire, which connects the grounds at each end of the link, is optional.

The third major difference between RS-422A and RS-232C is the transition region between Mark and Space states. This is only 400 millivolts (mV) in RS-422A, whereas it is 6 V in RS-232C. With the elimination of the ground-potential problem, the use of such a narrow region becomes possible. If the difference signal between the two wires is positive and more than 200 mV, the receiver reads a Mark, while if it is negative and more

than 200 mV, the receiver reads a Space. This approach allows suitable transmitters and receivers to be implemented with just the normal ± 5 -V power supply.

Because of the much smaller transition region, RS-422A transmitters will not drive RS-232C receivers correctly. This incompatibility poses such a serious disadvantage that the EIA introduced the RS-423A standard, which you can use with both RS-449 and RS-232C. This standard is not just an interim measure, however, for RS-423A does not use two wires for each signal as RS-422A does and thus is more economical. You can see two RS-423A signals in figure 3. Each direction uses a common return path that connects to ground at one end of the link only, the transmitter end. The receiver judges whether a Mark or Space is present by examining whether the signal wire is negative or positive with respect to the common return. Because this return path does not connect to ground in the receiver, the

VISUAL presents ergonomic elegance and high performance in a low-cost terminal.

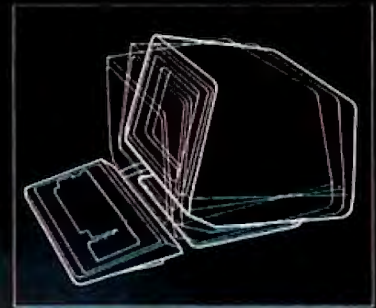

Tilt: 10° forward, 15° backward



Swivel: 270°

\$695 list

The VISUAL 50 represents a new approach in low cost terminals. Although it costs drastically less, it offers the features you expect from the high priced units.

For example, the VISUAL 50 enclosure is ergonomically designed in light weight plastic and can easily be swiveled and tilted for maximum operator comfort. A detached keyboard, smooth scroll, large 7 x 9 dot matrix characters and non-glare screen are a few of the many human engineering features normally offered only on much higher priced terminals.

Another distinctive feature of the VISUAL 50 is its emulation capability. VISUAL 50 is code-for-code compatible with the Hazeltine Esprit,[™] ADDS Viewpoint,[™] Lear Siegler ADM-3A[™] and DEC VT-52.[®] Menu driven set-up modes in non-volatile memory allow easy selection of terminal parameters.

And you're not limited to mere emulation. As the chart shows, the VISUAL 50 has features and versatility the older, less powerful low cost terminals simply cannot match.

FEATURE COMPARISON CHART

FEATURE	VISUAL 50	Hazeltine Esprit	ADDS Viewpoint	Lear Siegler ADM-5	TeleVideo [®] 910
Tilt and Swivel	YES	NO	NO	NO	NO
Detached Keyboard	YES	NO	YES	NO	NO
N-Key Rollover	YES	NO	YES	NO	NO
Audible Key Click	YES	YES	NO	NO	NO
Menu Set-Up Mode	YES	NO	NO	NO	NO
Status Line	YES	NO	NO	NO	NO
Full 5 Attribute Selection	YES	NO	NO	NO	YES
Smooth Scroll	YES	NO	NO	NO	NO
Line Drawing Character Set	YES	NO	NO	NO	NO
Block Mode	YES	YES	NO	NO	YES
Insert/Delete Line	YES	YES	NO	NO	YES
Bi-Directional Aux Port	YES	YES	NO	YES	NO
Columnar Tabbing	YES	YES	NO	NO	YES
Independent RCV/TX Rates	YES	NO	NO	NO	NO
Answerback User Programmable	YES	NO	NO	OPT.	NO

VISUAL

See for yourself

Visual Technology Incorporated
540 Main Street, Tewksbury, MA 01876
Telephone (617) 851-5000. Telex 951-539

Circle 428 on inquiry card.

The Ultimate for the IBM

NOW WITH
SuperDrive
and
SuperSpool

ComboPlus™

Maximum 6 Functions (with memory)

- 64K-256K Parity Memory
- Clock Calendar (std.)
- IBM Compatible Async Port (opt.)
- IBM Compatible Printer Port (opt.)
- SuperDrive™ included (disk emulator prog.)
- SuperSpool™ included (print spooler prog.)

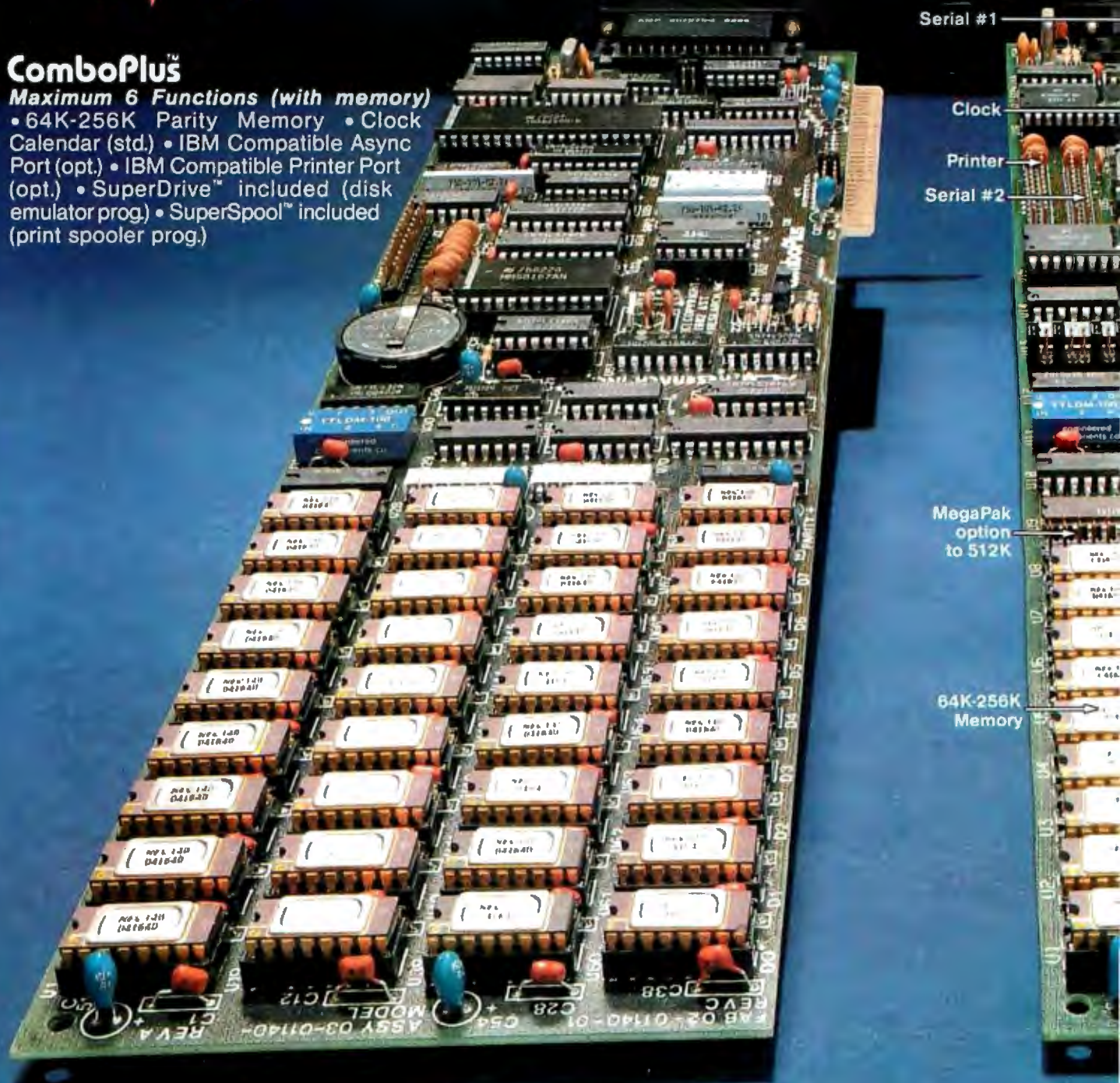

Other products available for IBM PC: 1) 2780/3780 Biscync Emulation Package; 2) Advance Communication Card (Async, Biscync, SDLC, HDLC); 3) Expansion Parity Memory (64K-256K); 4) Disk++ (memory, Async & disk host adaptor); 5) Original Memory Combo; 6) Async Communication Card (1 or 2 ports); 7) Wire Wrap Card 13.1" x 4"; 8) Extender Card; 9) 327X Emulation. AST products are now available from your local Computerland stores and selected dealers throughout the U.S. IBM is the registered trademark of International Business Machines.

Add-On Cards PC are Here!

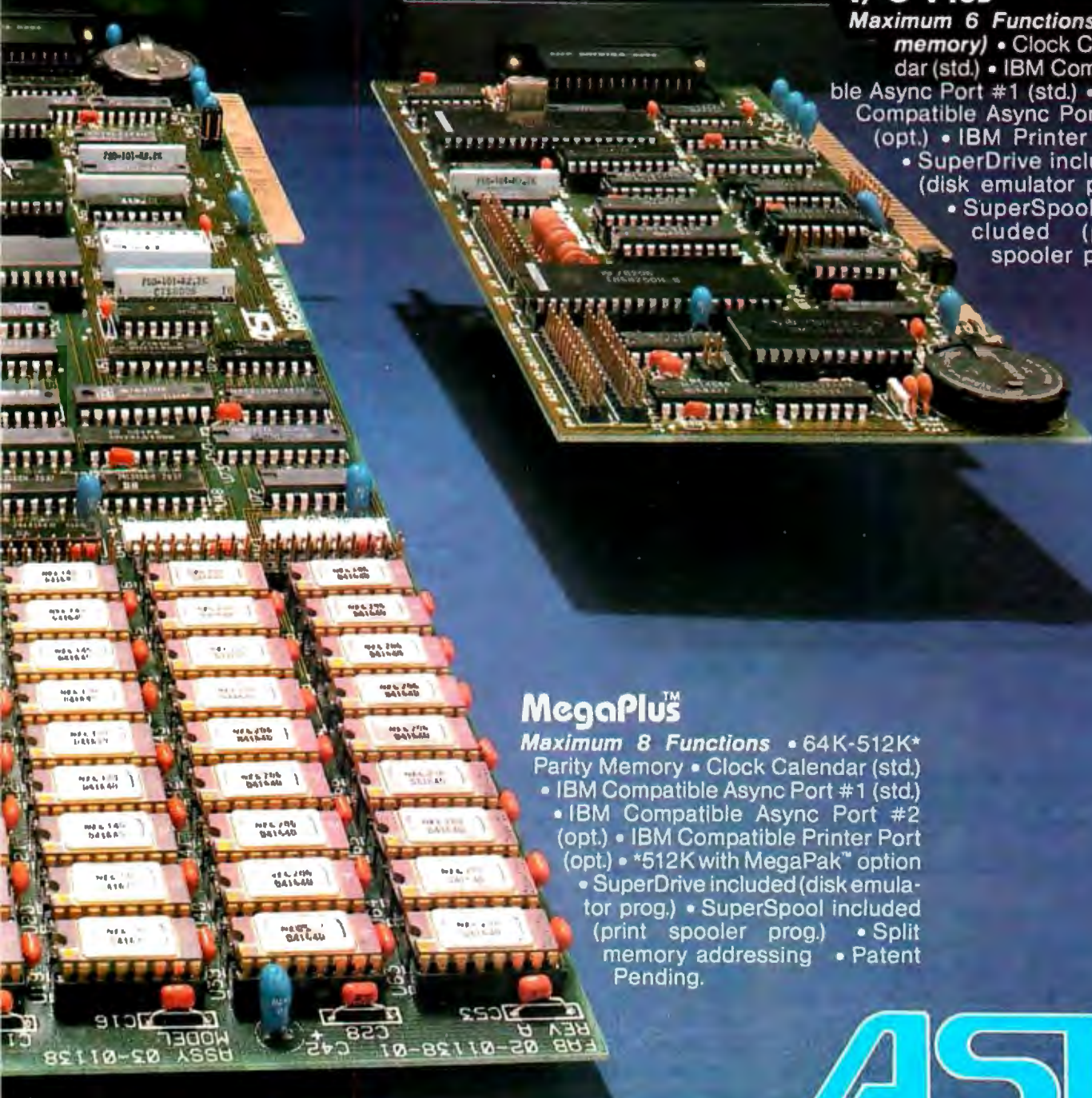

I/O Plus™

- Maximum 6 Functions (no memory)**
- Clock Calendar (std.)
 - IBM Compatible Async Port #1 (std.)
 - IBM Compatible Async Port #2 (opt.)
 - IBM Printer Port (opt.)
 - SuperDrive included (disk emulator prog.)
 - SuperSpool included (print spooler prog.)

MegaPlus™

- Maximum 8 Functions • 64K-512K* Parity Memory**
- Clock Calendar (std.)
 - IBM Compatible Async Port #1 (std.)
 - IBM Compatible Async Port #2 (opt.)
 - IBM Compatible Printer Port (opt.)
 - *512K with MegaPak™ option
 - SuperDrive included (disk emulator prog.)
 - SuperSpool included (print spooler prog.)
 - Split memory addressing
 - Patent Pending.

AST
RESEARCH INC.

2372 Morse Ave.
Irvine, California 92714
Telephone: (714) 540-1333
Dealer inquiries welcome.

Circle 3 on Inquiry card.

Pin	Signal			
	RS-449		RS-232C	
37/19 9/5	SG	Signal Ground	AB	Signal Ground
37/37 9/9	SC	Signal Common		
37/20 9/6	RC	Receive Common		
37/28	IS	Terminal In Service		
37/15	IC	Incoming Call	CE	Ring Indicator
* 37/12 37/30	TR	Terminal Ready	CD	Data Terminal Ready
* 37/11 37/29	DM	Data Mode	CC	Data Set Ready
* 37/14 37/22	SD	Send Data	BA	Transmitted Data
* 37/6 37/24	RD	Receive Data	BB	Received Data
* 37/17 37/35	TT	Terminal Timing	DA	Transmitter Signal Element Timing (DTE source)
* 37/5 37/23	ST	Send Timing	DB	Transmitter Signal Element Timing (DCE source)
* 37/8 37/26	RT	Receive Timing	DD	Receiver Signal Element Timing
* 37/7 37/25	RS	Request To Send	CA	Request To Send
* 37/9 37/27	CS	Clear To Send	CB	Clear To Send
* 37/13 37/31	RR	Receiver Ready	CF	Received Line Signal Detector
37/33	SQ	Signal Quality	CG	Signal Quality Detector
37/34	NS	New Signal		
37/16	SF	Select Frequency		
also 37/16	SR	Signaling Rate Selector	CH	Data Signal Rate Selector (DTE source)
37/2	SI	Signaling Rate Indicator	CI	Data Signal Rate Selector (DCE source)
9/3	SSD	Secondary Send Data	SBA	Secondary Transmitted Data
9/4	SRD	Secondary Receive Data	SBB	Secondary Received Data
9/7	SRS	Secondary Request To Send	SCA	Secondary Request To Send
9/8	SCS	Secondary Clear To Send	SCB	Secondary Clear To Send
9/2	SRR	Secondary Receiver Ready	SCF	Secondary Received Line Signal Detector
37/10	LL	Local Loopback		
37/14	RL	Remote Loopback		
37/18	TM	Test Mode		
37/32	SS	Select Standby		
37/36	SB	Standby Indicator		

number of signals in list	30
less number of signals which share a pin	- 1
number of extra pins for balanced-line signals	+ 10
duplicate grounds/commons (one for each cable)	+ 3
cable shields	+ 2
spare pins	+ 2
	▲
total pins:	46

Table 4: RS-449 signals and their RS-232Cd analogs. Signals marked with an asterisk (*) use RS-422A for higher-speed links; all other signals use RS-423A.

problem of ground currents does not arise.

For an RS-423A transmitter, the voltage difference between the signal line and the common return must be at least 4 V, positive for a Space and negative for a Mark. This gives an 8-V transition region—enough for RS-232C receivers—but also presents the same power-supply problem that occurs with the RS-232C. Because the RS-423A receiver must be as sensitive to the same 400-mV transition region as an RS-422A receiver is, you can use an RS-422A transmitter with an RS-423A receiver.

RS-449 Signals

It's obvious that RS-449 provides few functional advantages over RS-232C except those stemming from the new electrical transmission methods. Table 4 shows all RS-449 signals, together with the corresponding RS-232C signals. Notice the similarity between the new and old standards. The major differences are in the grounding arrangements (Signal Common and Receive Common) and testing facilities. Apart from these, only a few miscellaneous signals have been added. All signals shown in the table use the RS-423A transmission stan-

dard except the 10 asterisked ones, which may optionally use the RS-422A for higher-speed links. (Two wires are specified for each of these.) The signals are divided between a 37-pin and a 9-pin connector, and the ground and common signals are transmitted separately for each cable. Many applications will not need the smaller cable, for it only contains signals relevant to the secondary channel.

The Current-Loop Interface

Now that I have described the electrical specifications for RS-232C, it is

FREE
with software purchase—
One CP/M Handbook

DISCOUNT SOFTWARE

✓ = New items

ASHTON-TATE
dBASE II... call for price (\$4??)

CP/M®

ARTIFICIAL INTELLIGENCE*
Medical (PAS-3)... \$849
Dental (PAS-3)... \$849

ASYST DESIGN*/FRONTIER
Prof Time Accounting... \$549
General Subroutine... \$269
Application Utilities... \$439

DIGITAL RESEARCH*

CP/M 2.2*
NorthStar... \$149
TRS-80 Model II (P+T)... \$159
Micropolis... \$175
CP/M-Intel MDS... \$135
PL/1-80... \$449
BT-80... \$179
MAC... \$ 85
RMAC... \$179
Sid... \$ 65
Z-Sid... \$ 90
Tex... \$ 90
DeSpool... \$ 49
CB-80... \$459
CBasic-2... \$ 98
Link-80... \$ 90

FOX & GELLER

Quickscreen... \$135
Quickcode... \$265
dutil... \$ 65

MICRO-AP*

S-Basic... \$269
Selector IV... \$295
Selector V... \$495

MICRO DATA BASE SYSTEMS*

HDBS... \$269
MDBS... \$795
DRS or ORS or RTL... \$269
MDBS PKG... \$1999

MICROPRO*

WordStar... \$279
Customization Notes... \$449
Mail-Merge... \$ 99
WordStar/Mail-Merge... \$369
DataStar... \$249
WordMaster... \$119
SuperSort I... \$199
Spell Star... \$139
CalcStar... \$259

MICROSOFT*

Basic-80... \$199
Basic Compiler... \$329
Fortran-80... \$349
Cobol-80... \$589
M-Sort... \$175
Macro-80... \$144
Edit-80... \$ 84
MuSimp/MuMath... \$224
MuLisp-80... \$174
FPL: Bus. Planner... \$595

ORGANIC SOFTWARE*

TextWriter III... \$111
DateBook III... \$269
Milestone... \$269

OSBORNE* (McGraw/Hill)

General Ledger... \$ 59

SAVE \$255 ON PRODUCTIVITY PAC #3!

Everything you need: a wordprocessor, spreadsheet and database. And a phenomenally low, low price!

	Retail	Regular Discount
Final Word	\$300	\$270
Plannercalc	\$ 99	\$ 50
Condor I	\$295	\$275
	\$694	\$595

SPECIAL COMBINATION PRICE: \$439

Offer good to the end of the month of publication of this magazine. Call for our other PAC prices.

Acct Rec/Acct Pay... \$ 59
Payroll w/Cost... \$ 59
All 3... \$129
All 3 + CBASIC-2... \$199
Enhanced Osborne (vandatta) (Includes CBasic)... \$269

PEACHTREE*
General Ledger... \$399
Acct Receivable... \$399
Acct Payable... \$399
Payroll... \$399
Inventory... \$399
Surveyor... \$799
Property Mgt... \$799
CPA Client Write-up... \$799
P8 Version... Add \$234
MagiCalc... \$269
Other... less 10%

STAR COMPUTER SYSTEMS

G/L, A/R, A/P, Pay... \$ 349
All 4... \$1129
Condor I... \$275
Condor II... \$535
Legal Time Billing... \$ 849
Property Mngmt... \$ 849

STRUCTURED SYSTEMS*

Business Packages, Call for Price

SORCIM*

SuperCalc... \$249
Trans 86... \$115
Act... \$157

SUPERSOFT*

Ada... \$270
Diagnostic I... \$ 49
Diagnostic II... \$ 84
Disk Doctor... \$ 89
Forth (8080 or Z80)... \$149
Fortran... \$219
Fortran w/Ratfor... \$289
C Compiler... \$225
Star Edit... \$189
Scratch Pad... \$266
StatsGraph... \$174
Analiza II... \$ 45
Dateview... \$174
Disk Edit... \$ 89
Encode/Decode II... \$ 84
Optimizer... \$174
Super M List... \$ 68
Term II... \$179
Zap Z-8000... \$450
Utilities I... \$ 54
Utilities II... \$ 54

ACCOUNTING PLUS

1 Module... \$385

4 Modules... \$1255
All 8... \$4500

UNICORN*

Pascal/MT+ Pkg... \$149
Compiler... \$149
Sp Prog... \$249
Pascal/UCSD 4.0... \$270

WHITESMITHS*

"C" Compiler... \$600
Pascal (incl "C")... \$850

"PASCAL"

Pascal/MT+ Pkg... \$429
Compiler... \$315
Sp Prog... \$175
Pascal/Z... \$349
Pascal/UCSD 4.0... \$670
Pascal/M... \$355
Tiny Pascal... \$ 76

"DATA BASE"

FMS-80... \$894
dBASE II... \$595
Condor I... \$275
Condor II... \$535
FMS-81... \$445

"WORD PROCESSING"

WordSearch... \$179
SpellGuard... \$199
Peachtex... \$289
Magic Spell... \$269
Spell Binder... \$349
Select... \$495
The Word... \$ 65
The Word Plus... \$145
Palantier-I (WP)... \$385

"COMMUNICATIONS"

Ascom... \$149
BSTM... \$149
BSTM... \$149
Crosstalk... \$139
Move-it... \$ 89

"OTHER GOODIES"

Micro Plan... \$419
Nevada Cobol... \$179
MicroStat... \$224
Vedit... \$130
MiniModel... \$449
StatPak... \$449
Micro B+... \$229
Raid... \$224

String/80... \$ 84
String/80 (source)... \$279
ISIS CP/M Utility... \$199
Lynx... \$199
Superwyz... \$ 95
ATI Power... \$ 75
Mathe Magic... \$ 95
CIS COBOL... \$765
ZIP MBASIC, CBASIC... \$129
Real Estate Analysis... \$116

APPLE II®

BRODERBUND

G/L (with A/P)... \$444
Payroll... \$355

INFO UNLIMITED*

EasyWriter (Prof)... \$155
Datedex... \$129
EasyMailer (Prof)... \$134
Other... less 15%

MICROSOFT*

Softcard (Z-80 CP/M)... \$239
Fortran... \$179
Cobol... \$499
Tasc... \$139
Premium Package... \$549
RAM Card... \$129

MICROPRO*

Wordstar... \$199
MailMerge... \$ 99
Wordstar/MailMerge... \$349
SuperSort I... \$159
Spellstar... \$129
CalcStar... \$175
DataStar... \$265

VISICORP*

Visicalc 3.3... \$189
Desktop/Plan II... \$219
Visiterm... \$ 90
Visidex... \$219
Visiplot... \$180
Visitrend/Visiplot... \$259
Visifile... \$219
Visischedule... \$259

PEACHTREE*

G/L, A/R, A/P, Pay or Inventory (each)... \$224
Peach Pack P40... \$795

SOFTWARE DIMENSIONS, INC.

Accounting Plus II, G/L, AR, AP or Inventory (each)... \$385
(Needs G/L to run)
"OTHER GOODIES"
Super-Text II... \$127

Data Factory... \$134
DB Master... \$184
Versaform VS1... \$350
VH1... \$445

16-BIT SOFTWARE

WORD PROCESSING

IBM PC
Wordstar... \$279
Spellstar... \$175
MailMerge... \$109
Easywriter... \$314
Easyspeller... \$159
Select/Superspeller... \$535
Write On... \$116
Spellguard (also available for 8" 8085 systems)... \$229
SP Law (for Spellguard)... \$115
Textwriter III... \$189
Spellbinder... \$349
Final Word... \$270

LANGUAGE UTILITIES

IBM PC
Crosstalk... \$174
BSTAM... \$149
BSTMS... \$149

8" 16-BIT SYSTEMS

Pascal MT+ /86, SSP... \$679
CBasic 86... \$294
Pascal M/86... \$445
Act 86... \$157
Trans 86... \$115
XLT 86... \$135

16-BIT 8" AND DISPLAYWRITER

CP/M 86... \$294
MP/M 86... \$585

OTHERS

IBM PC

SuperCalc... \$269
VisiCalc... \$219
Easyfiler... \$359
Mathemagic... \$ 89
CP/M Power... \$ 65
Condor 21... \$265
Condor 22... \$535
Condor 23... \$895
Condor 20Q... \$175
Condor 20R... \$285
Statoak... \$449
Optimizer... \$174
Desktop Plan II... \$219
Desktop Plan III... \$259
Visidex... \$219
Visitrend... \$259
Many others available for use with the "Baby Blue Board"

8" 16-BIT SOFTWARE

SuperCalc... \$269
CP/M Power... \$ 65

FORMATS AVAILABLE:

8" single density
8" OS/1
Superbrain
Micropolis/Vector Graphic
NorthStar Horizon
NorthStar Advantage
Osborne
Health/Zenith
Cromemco
Televideo
Xerox 820
Dynabyte
Hewlett-Packard 125
NEC
Eagle
Apple II/III
Otrona
TRS-80 Model I/II/III
DEC VT-180
Altos
CP/M-86
IBM PC

LOWER PRICES, COME HELL OR HIGH WATER.

ORDERS ONLY • CALL TOLL FREE • VISA • MASTERCHARGE
U.S. 1-800-421-4003 • CALIF. 1-800-252-4092

Outside Continental U.S.—add \$10 plus Air Parcel Post • Add \$3.50 postage and handling per each item • California residents add 6 1/2% sales tax • Allow 2 weeks on checks. C.O.D. \$3.00 extra • Prices subject to change without notice. All items subject to availability • ®—Mfgs. Trademark. Blue Label \$3.00 additional per item.

CP/M is a registered trademark of DIGITAL RESEARCH, INC.

THE DISCOUNT SOFTWARE GROUP

6520 Selma Ave. Suite 309 • Los Angeles, Ca. 90028 • (213) 837-5141

Int'l TELEX 499-0446 DISCSOFT LSA • USA TELEX 194-634 (Attn: 499-0446)

TWX 910-321-3597 (Attn: 499-0446)

Circle 150 on inquiry card.



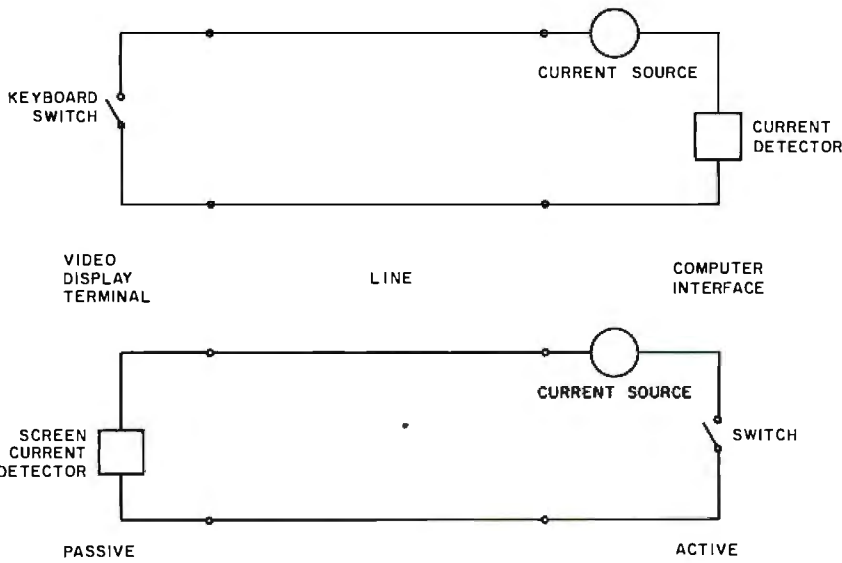

Figure 4: Computer-to-terminal interface using current loops.

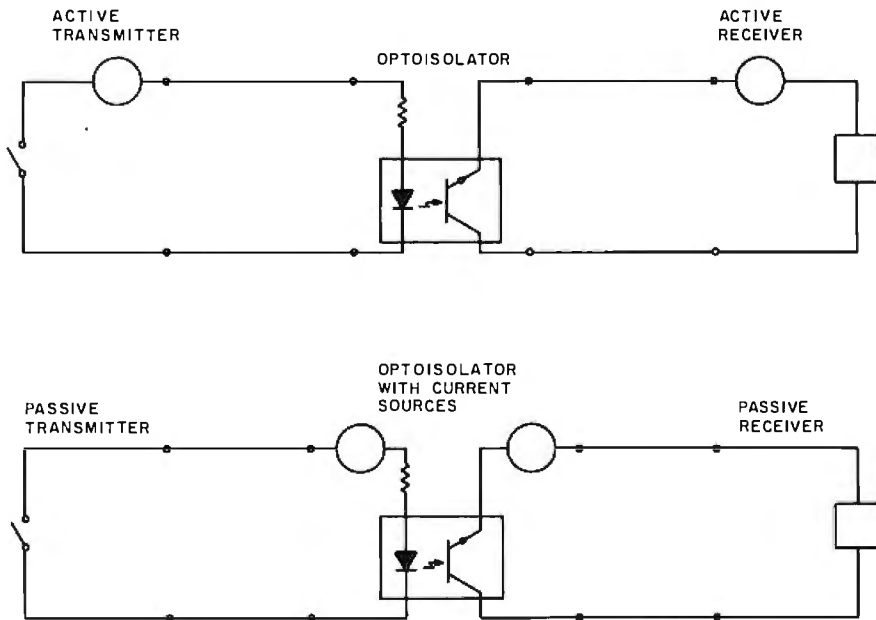

Figure 5: Active-to-active and passive-to-passive converters.

worth looking at the current-loop interface in more detail. Although this interface does not represent a proper standard, many low-cost microcomputer systems are using current loop because it eliminates the need for special power supplies. The current-loop interface is not a modem interface, as RS-232C and RS-449 are. It generally contains just the transmit and receive-data signals. However, it

can drive signals at reasonable speeds over respectable distances (9600 bps over 1500 feet), which makes it useful for directly connecting terminals to computers.

The idea of the current loop is to switch a current on and off. The active side of the line generates the current, while the passive side switches or detects it. Either the receiver or transmitter can be active. This gives

you four possibilities: Active Receiver, Active Transmitter, Passive Receiver, and Passive Transmitter. Because of the convenience of locating the power supply at just one end of the link (usually the computer), you will find all four of these signals in a single computer-to-terminal connection. You can see this arrangement in figure 4.

Unfortunately, this convention introduces the need for active-to-active and passive-to-passive converters. It is obvious that each link must have one active component (otherwise there is no current to switch), and it is also true that a link may have only one active component, at least in most implementations. Hence, if you want to connect a passive terminal directly to another passive terminal, you must put a passive-to-passive converter in between. Similarly, if you want to connect an active computer to an active computer, you will need an active-to-active converter. These converters are easy to implement and are shown in figure 5. The optoisolator provides complete electric isolation between the two sides, thus eliminating any problems with ground potential differences. The active-to-active converter does not even need a power supply, although the passive-to-passive must have one to generate the current.

Automatic Calling Units

None of the standards examined so far support the automatic placement of calls by a computer. RS-232C and RS-449 provide specifications for answering calls, but not for dialing. For this there is another standard, RS-366 (CCITT V.25) for automatic calling units. Making a telephone call can be quite complicated, although most of us are so used to it that we don't think about the complexity. The computer must be able to determine whether the line is free, figuratively take the phone off the hook, await the dial tone, present the telephone number, and detect and decipher the various audio signals that the telephone network uses to indicate the status of a call (the dial tone, the busy tone, the ringing tone, and the number-unavailable tone).



memory board?

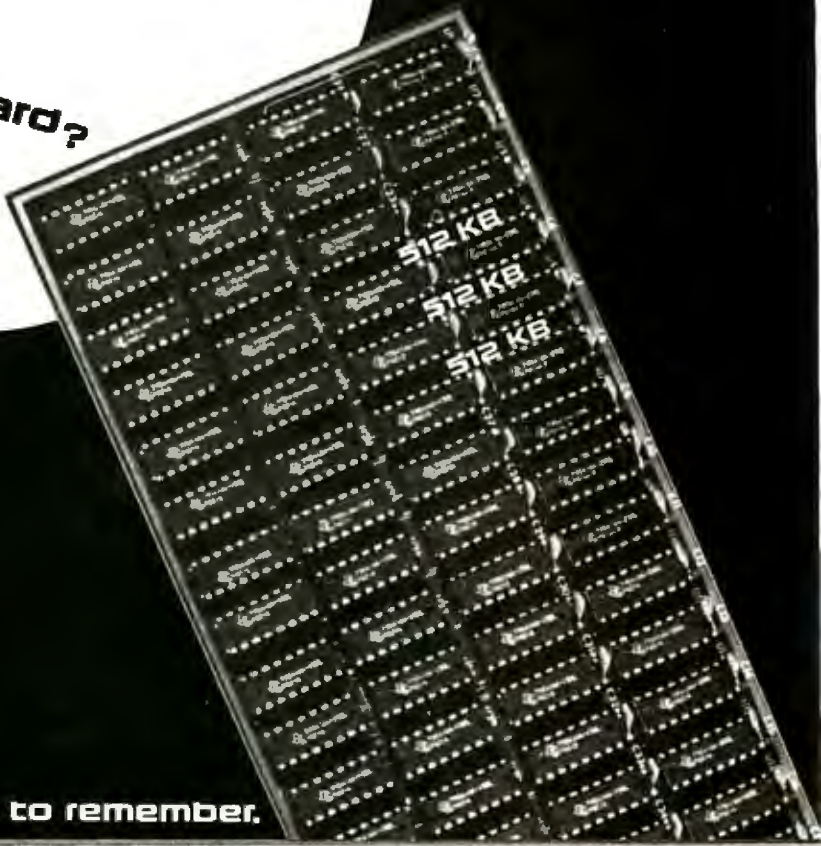

IBM PC compatible products to remember.

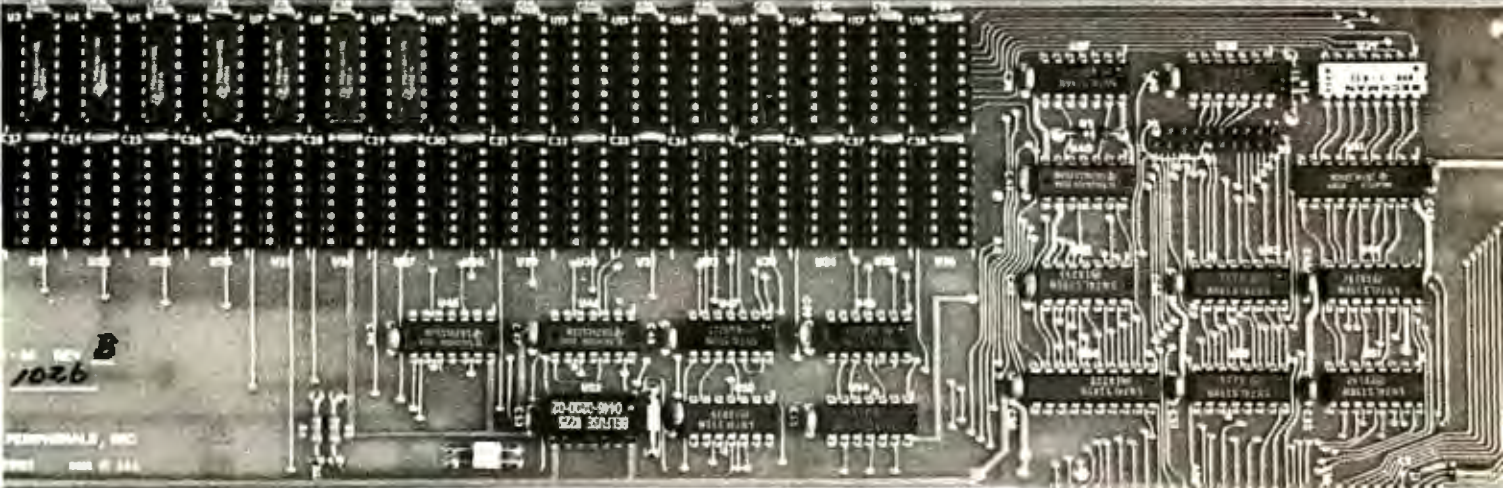

256 KB 256 KB

computer peripherals

1117 Venice Boulevard Los Angeles CA 90015 (213) 298-1297 Telex: 194561 LSA

Circle 107 on Inquiry card.

IBM is a trademark of International Business Machines
© 1982 Computer Peripherals Inc.

Dogged attempt to learn a second language.

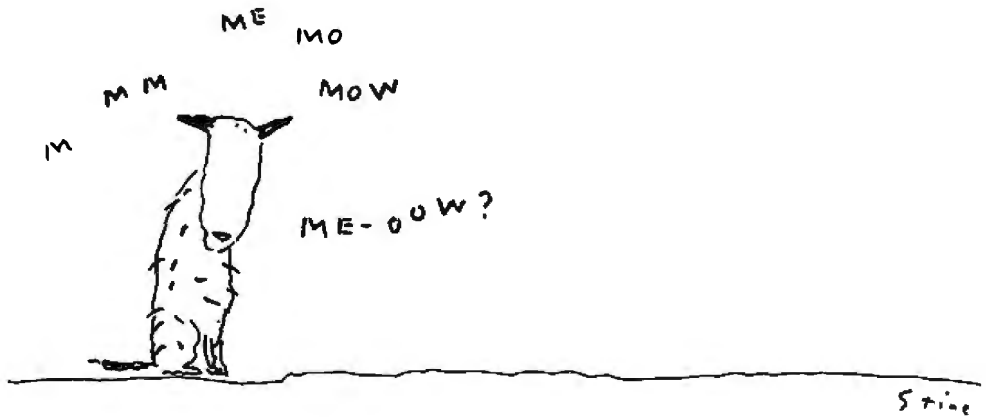

CTPM is a registered trademark of Digital Research Corp.

For the name of the dealer nearest you, phone (800) 227-2400, ext. 948; in California, (800) 772-2666, ext. 948. For more information

And now, InfoStar.™

The first DBMS you can use without speaking programmerese.

So put away your GO TOs and DO WHILEs.

InfoStar is one microcomputer data base system that doesn't ask you to write in code. Or learn a programming language. Instead you make selections from an on-screen menu written in one easy language. English.

Which means you don't have to be a programmer or computer jock to use it. But, in case you are, there's something in it for you, too.

With InfoStar, you can generate a custom application four times faster than with other DBMS software.

Reason being it has a lot of the features that made WordStar* the standard in the industry. For instance, select-as-you-go menus prompt you through all procedures. And to format a data entry form or report, you simply draw it on the screen. We've said it before: what you see is what you get.

But, of course, that's not all you get.

Fact is, InfoStar has more informative

(and self-documenting) capabilities than you've come to expect from any microcomputer DBMS.

Starting with report writing. A custom report feature — complete with transactional updating and exception processing abilities — lets you format, manipulate and merge countless different ways. And a quick report feature lets you finish faster than you can count them — usually in 60 seconds or less.

Not that you have to slow down to sort things out either. Because InfoStar can sort five to six times faster than any other DBMS in its class.

And for data entry, there are high-end minicomputer features. Like batch editing. And 200 editing mask combinations, to name a few.

All that's required of you is that you have a CP/M-based computer.

And that you take a trip over to your local computer store to ask about InfoStar.

They don't speak programmerese.

But they're happy to talk business.



MicroPro™
The Microcomputer Software Company

CCITT	Signal	Source
202	Call Request	DTE (computer interface)
206	NB1	
207	NB2	
208	NB4	
209	NB8	
211	Digit Present	
203	Data Line Occupied	DCE (automatic calling unit)
204	Distant Station Connected	
205	Abandon Call	
210	Present Next Digit	
213	Power Indicator	

Table 5: *The signals used by RS-366 and V.25 automatic calling units.*

Digit Code	NB8	NB4	NB2	NB1
1	0	0	0	1
2	0	0	1	0
3	0	0	1	1
4	0	1	0	0
5	0	1	0	1
6	0	1	1	0
7	0	1	1	1
8	1	0	0	0
9	1	0	0	1
0	1	0	1	0
EON	1	1	0	0
SEP	1	1	0	1

Table 6: *Number codes for automatic calling units. In the last four columns a 0 stands for on and a 1 stands for off.*

The signals for the automatic-calling-unit standard are listed in table 5. Data Line Occupied tells the computer if someone is already on the line. After checking that the line is free, the computer indicates that it wants to place a call by using Call Request. This effectively takes the phone off the hook. When the automatic calling unit hears the dial tone, it signals with Present Next Digit. Each digit is a binary-coded decimal as shown in table 6. The computer generates the next digit and signals its presence with Digit Present. Shortly afterwards, it again sees Present Next Digit, which indicates that the calling unit is ready for another digit. The sequence continues until the end of the number is reached, which the computer indicates with the EON (end of number) code. The computer can use another code, SEP (separator), in the

case when there might be a second dial tone, as when calling out through a private branch exchange (PBX). Often you have to wait for a dial tone, dial 9, and then wait for a second dial tone from the main exchange. SEP indicates to the calling unit that a second dial tone is expected. The calling unit then waits until that tone is received before asking the computer for another digit.

When the end of the number is reached, the calling unit waits for the called party to answer and then signals Distant Station Connected. Otherwise, if the number is unavailable or busy, it signals Abandon Call.

Moving into the Digital World

The overwhelming complexity of these standards is symptomatic of the fact that we are asking the analog telephone network to serve a purpose

for which it was never designed. No one foresaw automatic placement and answering of calls by computers when the first phone was installed.

Today, the telephone network is slowly moving into the digital era, an advancement complicated by the staggering investment that the telephone companies have in existing equipment. In anticipation of widespread direct digital connection to the telephone network, CCITT is offering a new, cleaned-up recommendation specifically designed for the digital telephone exchange. It is X.21, and the minimum line speed is likely to be 56,000 bps, the data rate needed to encode voice to telephone quality. Just imagine the impact this will have on your home use of remote computers or information networks like the Source.

The X.21 standard uses only eight lines (see table 7). The computer sends data to the modem on the Transport line and data moves in the reverse direction on the Receive line. Control and Indication provide control channels in the two directions. The X.21 modem generates a bit-rate clock and possibly a byte-synchronization signal. The last two wires give a voltage reference and ground connection.

Although Control and Indication are control wires, most of the controlling information actually uses the Transport and Receive lines. The computer changes the state of Control when it wants to place a call, just as you lift the handset off the telephone when you want to dial. To terminate the call, the computer changes Control back to the idle state. Similarly, the modem changes the state of Indication when the remote telephone is answered and changes it back if it shuts down. All the dialing information travels on the Transport line and all the information about tones comes back on the Receive wire.

The major advantage of X.21 over RS-232C and RS-449 is that the X.21 signals are encoded in serial digital form. For example, when a dial tone is received, a continuous sequence of ASCII "+" characters is sent to the computer on the Receive wire. In

Mr. Dow and Mr. Jones

introduce



Jones: "Mr. Dow, look what they're selling in that new store down the street: Dow Jones Software. You haven't gotten us into ladies' fashions, have you?"

Dow: "No, Mr. Jones. That's a computer store, and our software products allow investors and business professionals to use a personal computer like this one here to easily manage financial information."

Jones: "But what about our reputation? We've been leaders in serving the business and financial community for over 100 years. Are you sure this new software will be as reliable as *The Wall Street Journal* and *Barron's*?"

Dow: "Of course, Jones. Our software is so reliable we back it up with a full-year warranty. People trust Dow Jones Software the same way they trust the *Journal*. And we have a toll-free Hotline number in case they want expert help."

Jones: "Couldn't that be a lot of phone calls? After all, we've got the Dow Jones Averages to get out every day."

Dow: "Don't worry, Jones. Our software is very easy to use, and we have a fully staffed Customer Service Department to

respond to our dealers and customers."

Jones: "Just what can our software do?"

Dow: "In a nutshell, Jones, with a personal computer, a telephone, a modem and Dow Jones Software, you can easily perform complex analyses on the information available from our information service, Dow Jones News/Retrieval®."

Jones: "People really use our software to make decisions?"

Dow: "Absolutely. Once you've stored the information you want, our software does the rest. For instance, with one Dow Jones Software product you can follow indicators for stocks, sort, rank, screen and set critical points for buying and selling. With another, you can easily construct technical charts. Look at this beautiful graph."

Jones: "You mean all those calculations I've been doing by hand I could do in a fraction of the time with this software? That's great!"

Dow: "It is, Mr. Jones. Just like the *Journal*, Dow Jones Software is a resource you can bank on!"



Dow Jones Market Analyzer™

A technical analysis product that allows private and professional investors to automatically collect, store and update historical and daily market quotes, and to construct technical analysis charts at the touch of a key.

Dow Jones Market Microscope™

A fundamental analysis product that allows professional money managers to choose and follow indicators for extensive lists of stocks and industry groups, and to sort, rank, screen and set critical points for buying and selling.

Dow Jones Market Manager™

A portfolio management product for private or professional investors who desire immediate access to pricing and financial information, and who need an accounting and control system for their portfolios of securities.

Dow Jones Connector™

A communications product for the business or professional person who wants instant electronic access to news, facts and vital data at the home or office, via personal computer, simple terminal, communicating word processor or teletypewriter.

See your computer dealer or call

1-800-345-8500 Ext. 48

for a free brochure

(Alaska, Hawaii and foreign, call 1-215-789-7008 Ext. 48)

DOW JONES SOFTWARE™

...Bank on it.

CCITT	Signal	Source
T C Ga	Transport Control DTE Common Return	DTE (computer interface)
R I S B	Receive Indication Signal (bit timing) Byte Timing (optional)	DCE (X.21 modem)
G	Ground	

Table 7: Signals used in the X.21 data-communications standard.

Calling Computer	X.21 Modem	Telephone Network
turn Control on (pick up handset)	wait for dial tone	dial tone comes
	signal dial tone with ASCII " + + + ..." on Receive line	
send phone number on Transport line	dial the call	remote phone rings
	send call progress signal on Receive line	remote phone is picked up
	turn Indication on	
	—communication on Transport and Receive—	
turn Control off (put down handset)	turn Indication off to acknowledge	line becomes disconnected

Table 8: The sequence of events in an X.21 call, with time running from top to bottom.

effect, this is a digital dial tone. The computer dials the number by transmitting it as a series of ASCII characters on the Transport line, a bit at a time. This method is much more convenient for the computer than having a parallel connection for the digits because today software is much cheaper than parallel output ports.

After dialing the call, the computer receives call-progress signals from the modem on the Receive wire. These signals indicate such call states as number busy, access barred, and network congestion. Table 8 shows an example of the X.21 standard in operation. Notice that the Control and Indication lines change state only once

per call; the main control information is sent on Transport and Receive.

The Future

The telephone network is rapidly becoming more complicated. The computer technology in the telephone exchange increases your options for interaction with the telephone system. For example, on an advanced exchange, if you get a busy signal, you can place the call again by issuing a repeat-last-call command. Alternatively, you can store that last number you called for future reference and free the phone for other calls. Another option, short-code dialing, allows you to associate short codes with commonly dialed numbers. You can also bar both incoming and outgoing calls. A diversion service allows you to direct all incoming calls to another telephone either immediately or if the number is busy.

By using serial digital coding instead of dedicated wires for special functions, X.21 provides a sound basis for building such services into computer communication. A short-code-dialing or repeat-last-call facility would be extremely useful, for example, to reconnect a call every time you complete a line of typing at the terminal. If the line could be disconnected while you are typing, long distance calls would be much cheaper. Of course, this would also depend on the tariff policies of the telecommunication carriers. Using X.21 could allow many of the advantages of packet-switching without the associated complexity. Imagine the possibilities of setting up a three-party call between computers! You can't do this now because you still need operator intervention, but the new exchanges will allow you to do it yourself. Possibilities like these show us where the future is, and with the X.21 data-communication standard, we may have found the path out of the standards jungle. ■

References

1. McNamara, J. E. *Technical Aspects of Data Communication*. Bedford, MA: Digital Press/Digital Equipment Corporation, 1978.
2. Tanenbaum, A. S. *Computer Networks*. Englewood Cliffs, NJ: Prentice Hall, 1981.

Powerful CP/M Software.

For Apple, Osborne, TRS-80, North Star, SuperBrain, Micropolis, Altos and others.

Now only **\$29.95** each!

NEVADA COBOL

was \$199.95 now only **\$29.95.**

When we introduced Nevada COBOL three years ago, it was loaded with innovations. Today's Edition 2 is even better! For example:

- It's 4 to 20 times faster than any other micro COBOL according to an independent study*. What's more, it's easier to use.
- Extremely Compact. You can compile and execute up to 2500 statements in 32K RAM, 4000 statements in 48K, etc.
- It's based upon the ANSI-74 standards with level 2 features such as compound conditionals and full CALL CANCEL.
- You get a diskette, 153-page manual with lots of examples and 16 complete COBOL source code programs.

NEVADA PILOT

was \$149.95 now only **\$29.95.**

- Perfect for industrial training, office training, drill and testing, virtually all programmed instruction, word puzzle games, and data entry facilitated by prompts.
- What's more, John Starkweather, Ph.D., the inventor of the PILOT language, has added many new features to Nevada PILOT. There are commands to drive optional equipment such as Video Tape Recorders and Voice Response Units. There's a built-in full-screen text editor and much more.
- Meets all PILOT-73 standards for full compatibility with older versions.
- You get a diskette, 114-page manual and ten useful sample programs.

NEVADA FORTRAN

was \$199.95 now only **\$29.95.**

- IF . . THEN . . ELSE constructs.
- COPY statement.
- A very nice TRACE style debugging.
- 150 English language error messages.
- You get a diskette, 174 pages of Documentation and five sample programs.

NEVADA EDIT

was \$119.95 now only **\$29.95.**

- A character-oriented full-screen video display text editor designed specifically to create COBOL, BASIC and FORTRAN programs.
- Completely customizable tab stops, default file type, keyboard layout and CRT by menu selection.
- The diskette comes with an easy to read manual.

To make our software available to even more micro users, we've slashed our prices. What's more, we're offering a money back guarantee. If for any reason you're not completely satisfied, just return the package—in good condition with the sealed diskette unopened—within 30 days and we'll refund your money completely.

This is a limited time offer, so order yours today!

Shipping/handling fees. Add \$4.00 for first package and \$2.00 each additional package. OVERSEAS Add \$15.00 for first package and \$5.00 each additional package. Checks must be in U.S. funds and drawn on a U.S. bank!

*"A Compiler Benchmark: A Comparative Analysis of Four COBOL Compilers" by Stephen F. Wheeler. Trademarks: CP/M, Digital Research; TRS-80, Tandy Corp.; Apple II, Apple Computer Inc.; Osborne 1, Osborne Computer Corp. © 1982 Ellis Computing.

MAIL TODAY!

To: Ellis Computing (415) 753-0186
3917 Noriega St
San Francisco, CA 94122

The CP/M operating system and 32K RAM are required.

Indicate diskette format: 8" SSSD
5 1/4" Apple CP/M Osborne N*SD N*DD
 TRS-80 Mod I Micropolis Mod II
 TRS-80/mapper Superbrain DD DOS 3.X

Indicate software packages: COBOL PILOT
 FORTRAN EDIT

Send my order for ___ packages @ \$29.95 each Total _____
In CA add sales tax _____

Check enclosed COD Shipping/handling _____
If COD add \$4.00 _____

MasterCard VISA TOTAL _____

_____ Exp. Date _____

Signature _____ Phone # _____

Ship to:

Name _____

Company _____

Street _____

City/St/Zip _____

Country _____

Offer expires 2/28/83

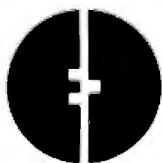

ELLIS COMPUTING

Introducing the portable computer for professionals on the move. Hewlett-Packard's new HP-75.

A decade ago, we introduced the world's first scientific pocket calculator and rendered the time-honored slide rule obsolete.

Now we're introducing the HP-75 portable computer. And if press reaction is any indication, history is about to repeat itself.

As small as a book. As powerful as a personal.

Desktop-computer power in a handsome 26-ounce package. That's the HP-75. It's just 10 inches by 5 inches by 1¼ inches.

But don't let the compactness fool you. Inside its rugged case lies a 48K-byte, ROM-based operating system. With a comprehensive, 147-command instruction set that helps you write hard-working, memory-efficient BASIC programs.



Plug-in ROM ports let you add up to three 32K-byte software modules—modules that solve tough problems *without* sacrificing user memory.

And that user memory gives you up to 24K bytes of program and data storage.

It all adds up. A fully loaded HP-75 is a 168K-byte computing powerhouse in calculator clothing.

Want more? A built-in magnetic card reader provides a convenient, inexpensive way to store and retrieve programs or data.

The HP-75's typewriter-like keyboard means rapid, accurate entry of text or data. And when we say you can touch type on it, we *mean* you can touch type on it.

Those keys, by the way, can be redefined with your favorite commands or programs. Up to 196 unique key combinations in all.

Immediate, convenient access to your most frequently used programs.

Thanks to the HP-75's multiple-file

structure, programs, data and text can be named, simultaneously stored in memory, and programmed to interact with each other.

Add continuous memory, and you've got a computer that's designed to solve problems on the go. Simply load your favorite files and enjoy immediate access to any or all of them. The files are retained in memory until you decide to delete them—even when the machine is turned off.

Time and appointments to keep you on schedule.

The TIME key brings to display the day of the week, date and time to the nearest second.

The APPOINTMENT feature reminds you—an hour from now or a year from now—of things you have to do. You can have a silent message on the display, any one of six alarms, or a combination of both.

Even if the machine is turned off, it will "wake up" and alert you of an appointment. Or it will execute programs or control peripherals according to predetermined schedules.

In an environmental test, for instance, where readings are taken every half hour, the HP-75 can make sure its owner gets the weekend off.

Software tailored to solve your specific problems.

HP-75 software is now available in areas such as math, engineering, finance, and statistics. With spreadsheet analysis*** on the way.

Our plug-in math module*** for instance, solves polynomial roots, evaluates integrals, and performs finite Fourier transforms.

With our text-formatter module,** you'll compose memos, letters, and short documents virtually anywhere; then print them out when you return to your home or office.

In addition, our third-party software program assures you of ever-expanding software variety.

If you're a volume purchaser or OEM, give us a call. We can help you create custom HP-75 systems with special plug-in modules, magnetic cards, digital cassettes, and keyboard overlays.

Peripherals for a total computing package.

The HP-75 is equipped with the Hewlett-Packard Interface Loop, giving you a choice of 15 peripherals. (And that choice is expanding. The HP-75 *can* work simultaneously with up to 30.)

In a battery-powered briefcase system weighing about seven pounds, you might have the 24-character printer, digital cassette drive and acoustic modem*.

A desktop system might include the 80-column impact printer, full-color graphics plotter, and 12-inch video monitor.

And the HP-75 can "talk to" other computers, peripherals, and instruments with our HP-IB (IEEE-488)** RS-232*** and

GPIU interfaces.

In summary, the HP-75 is the heart of an extremely versatile system, in addition to its stand-alone capabilities.



Manuals to make sure you get the most from your machine.

Chock-full of examples and helpful hints, our owner's manual will get you up and running in short order. And it's organized to help you access the information you need to get on with the job at hand.

A supplementary reference guide provides a concise summary of the computer's operating protocol and instruction set.

The value you're looking for.

What is the price of all this power in this compact package? \$995****. A lot less than you might pay for a personal computer you can't take with you.

See the HP-75 today. It's the smart choice for professionals on the move.

For the authorized HP dealer or HP sales office nearest you, call TOLL-FREE 800-547-3400 (Oregon, Alaska, Hawaii: 503-758-1010). TTY users with hearing or speech impairments, dial 503-758-5566.

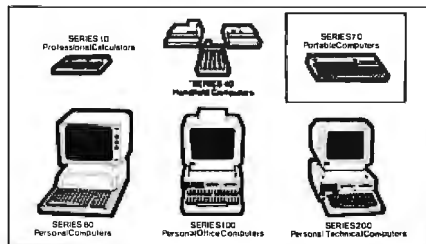

*Call our toll-free number for availability.

**Available March, 1983.

***Suggested retail price. May vary outside U.S.

****Suggested retail price. May vary outside U.S. Peripherals and software not included.



**HEWLETT
PACKARD**

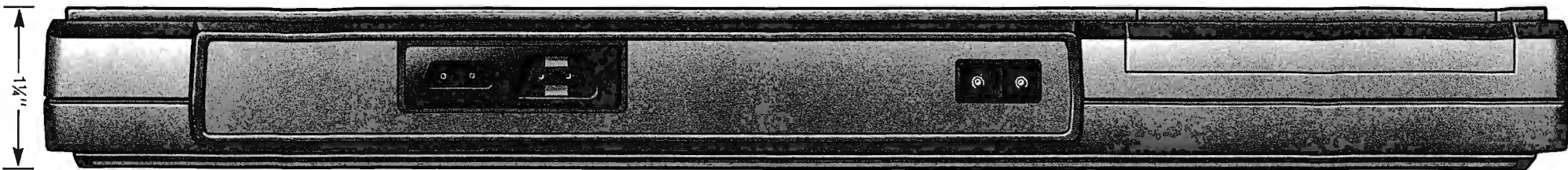

HP-75 SPECIFICATIONS

Size and weight: 10" X 5" X 1 1/4," 26 oz.

48K-byte, ROM-based operating system:
 • 8-bit CMOS CPU • Multiple file structure in continuous memory • Instruction set: 52 system commands, 43 BASIC commands, 41 numeric functions, 7 string functions, 6 time-mode commands, 16 arithmetic/logical/

relational operators

Numeric precision:

- Real—12 digits ($\pm 9.999999999999 \times 10^{\pm 499}$)
- Short—5 digits ($\pm 9.9999 \times 10^{\pm 99}$)
- Integer—5 digits (± 99999)

Time/appointments:

- Perpetual clock/calendar • 12- or 24-hour format • Appointment control of command/

program execution

Memory:

- User (RAM)—16K bytes, expandable to 24K bytes
- Operating system (ROM)—48K bytes
- Plug-in software (ROM)—up to 96K bytes (3 32K-byte modules)

Typewriter-like QWERTY keyboard:

- 65 keys • 194 redefinable key combinations

• "Hidden" numeric keypad

Integral mass storage: hand-pulled card reader (1.3K bytes per card)

Built-in interface: HP-IL; choice of 15 peripherals

Power supply: 3 AA NiCad batteries (AC adapter/charger included)

Liquid-crystal display: 32-character window on 96-character line

A Proposed Floppy-Disk Format Standard

ANSI considers a format that would make floppy disks interchangeable.

Chuck Card
2192 Buckboard Circle
Warrington, PA 18976

A few things in the microcomputer world are interchangeable. For example, certain printers, modems, and BASIC programs can be used on a fairly large number of systems. Floppy disks, unfortunately, are not in this group. (And if for some reason you find that hard to believe, look for any evidence of interchangeable disks in the ads of this issue of *BYTE*. But please don't do it now; just take my word for it.) When you choose a particular microcomputer, you also choose the disk format you'll have to live with for as long as you own the computer. Fortunately, most major software is available in several formats. But, when you want to send something on a disk to friends, will they be able to read it?

Think of all the software you've wanted but couldn't get in the format you needed for your computer. No, I

am not talking about the 6502 code you can't execute on your Z80 (or the other way around). I'm talking about those things that your processor may be able to handle, but your disk-drive controller cannot.

And if you think this disk incompatibility is a problem for users, think about what this means for independent software vendors. If you take a look at an old issue of *BYTE*, you will find, in double-page ads, a list of the disk formats one software distributor has been willing to generate for its customers. That distributor doesn't advertise like that anymore, but things have not improved.

Obviously, a standard disk format is needed. But, unfortunately, none was being offered. Thus, in an effort to at least get the ball rolling, I submitted a standard-disk-format proposal of my own to the American National Standards Committee for Information Processing Systems (Committee X3; part of the American National Standards Institute, or ANSI). In this article, I will give a brief description of that proposed format

and will suggest how you as a computer user can help determine what the final adopted standard will be.

First, let's establish what we mean by disk formats. Are we talking about text or command files? The answer is either. We are interested in the fact that the files in the various systems are not compatible. Or worse, the files themselves are quite compatible but the disks are not.

But how can that be? Aren't most disks recorded according to the same standards? Indeed, they are. The problem is that the recording standards deal only with such topics as tracks and the way bits are defined on the storage medium, plus the physical characteristics of the medium itself.

What has been proposed is a disk format standard for disk directories and general file organization flexible enough to accommodate further development and evolution. After lots of study of the various disk formats currently available, I found that there is a common feature to some of these formats, a pattern that many of you have undoubtedly noticed.

About the Author

Chuck Card is a member of the Standards Planning and Requirements Committee of the American National Standards Institute Committee X3 (Information Processing Systems).

Em-Pac® software lets you

Squeeze μ P development support out of your CP/M-80 system.



Get more performance from your personal microcomputer system.

Next time you plug in your CP/M-80 based computer, plug in Applied Microsystems' powerful microprocessor development support. Adding our new Em-Pac® software to one of our EM-Series Diagnostic Emulators will turn your personal computer into a powerful microprocessor development system. With many of the features you'd expect from a system costing three times as much.

Symbolic debugging saves time.

Em-Pac software lets you download and debug software using the same labels and symbols used in the program. Any values, like

the one defining breakpoints or memory addresses, can be referenced against the symbol names. This speeds up debugging and reduces the time you spend integrating hardware and software

Greater flexibility shortens the engineering schedule.

English language commands simplify the programming process. You can also define a long string of commands for the emulator to execute with only one command. And Applied Microsystems can provide support for the 8048, Z80, 8080 and 8085 families of microprocessors. So you don't have to learn a completely new system next time you want to change microprocessors.

Find out more . . .

Contact Applied Microsystems for more information on our new CP/M-80 or ISIS-II compatible software. Call us TOLL FREE at 800-426-3925, or write Applied Microsystems, 5020 148th Ave. N.E., P.O. Box 568, Redmond, WA 98052.

Applied Microsystems

*Em-Pac is a registered trademark of Applied Microsystems Corporation.

Circle 28 on Inquiry card.



Microprocessors Supported:

8035	Z80
8039	Z80A
8040	Z80B
8048	MK3880
8049	MK3880A
8050	8085A
8748	8085A-2
8749	8080A
	8080A-1
	8080A-2

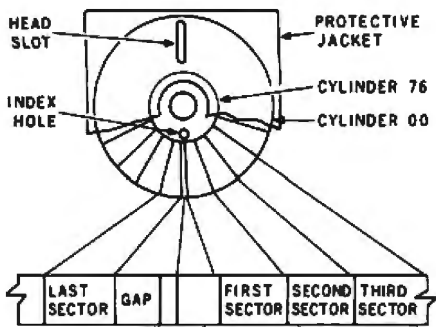

Figure 1: A diagram of a typical formatted 8-inch floppy disk.

The Media-Parameter Block

Although notable exceptions exist, most disks seem to have a mystical sector on cylinder 0 (or track 0). It falls under the first read/write head and is the first data recorded on the track (sector 1). If the terms cylinder, head, and sector are confusing, look at figure 1.

Almost all disk drives read this home sector the same way. My proposal is to place certain standard information in this sector, information that will explain how the rest of the disk is formatted. Fortunately, most disk controllers can be programmed to read and write disks in more than one way. Thus it would be possible for one of these disk controllers to read the home sector and then be programmed to read the rest of the disk. In the home sector will be information on such things as the recording technique, the number of bytes in each sector, how many cylinders, heads, sectors per track, and so on. This information would in effect tell the disk drive how to read the rest of the disk.

That covers the physical issues. What about considerations such as the load block, which some systems use? The proposal deals with that as well as the interlace formula, copyright notices, bad-track tables, system-reserved space, volume identifiers, and the directory description. While these are not all required, the place to find them can be identified without wasting storage space if they are not present.

If you refer to figure 2 you will see a proposed layout for the 256

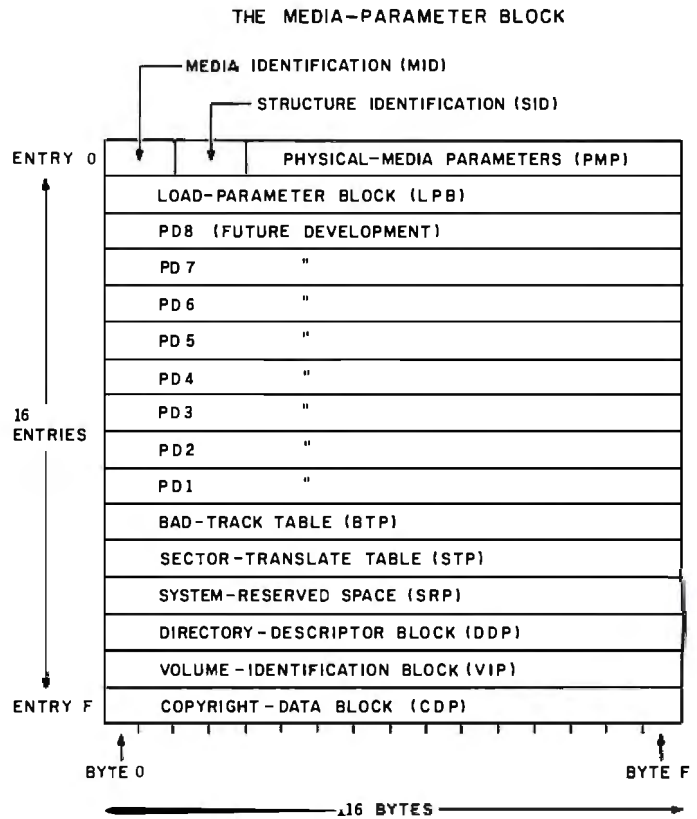

Figure 2: A diagram of the media-parameter block (MPB), the 256 bytes of the first sector of the proposed standard disk format. The information in this sector describes how the rest of the disk is formatted. Each block contains specific information or points to the area of the disk that has that information.

Byte	Bit	Field	Mnemonic
Byte 02	0	Physical-media-parameter table	PMP
	1	Load-parameter block	LPB
	2	Copyright-data block	CDP
	3	Volume-identification block	VIP
	4	Directory-descriptor block	DDP
	5	System-reserved space	SRP
	6	Sector-translate table	STP
	7	Bad-track table	BTP
Byte 03	0	Reserved for future standardization	
	1	"	
	2	"	
	3	"	
	4	"	
	5	"	
	6	"	
	7	"	

Table 1: Bytes 2 and 3 of the media-parameter block form the structure identification (SID). These bits signify which of the pointer fields in the MPB are active.

characters of the home sector, or as we call it, the media-parameter block (MPB). The first two bytes (bytes 0 and 1) are for identifying the media from a software-supplier point of

view. This is jargon for saying that these bytes are arbitrary but important.

The next two bytes (bytes 2 and 3) make up the structure identification

The IMS Family

IMS Computer products not only fulfill the requirements of stand alone applications, they are designed to be cost effective, intelligent nodes in a total network environment! Each product fulfills a particular requirement of the

network with a conservative functional overlap of the system above and below in the Family Tree. The IMS family is growing rapidly—keeping pace with technology and the ever increasing needs of industry.

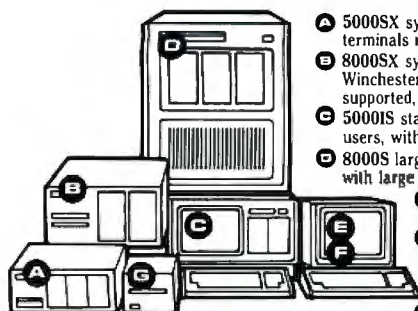

- A** 5000SX systems computer; S100 based archival node to which six user terminals may be connected, each with its own processor and memory.
- B** 8000SX systems computer; S100 based archival node with dual floppy, Winchester and tape back up capability. Six user terminals may be supported, each with its own processor and memory.
- C** 5000IS stand alone intelligent node. S100 based. May support up to four users, with up to 25 MByte Winchester with dual floppies.
- D** 8000S large system computer. S100 based. Can support up to 16 users with large disk and tape back up capability.
- E** Stand-alone intelligent CRT with high resolution monitor and removable typist keyboard.
- F** Expanded CRT to be used as Intelligent Note Processor. Includes Micro Processor, 64K of memory and four serial ports—two of which are to be used to connect into high speed network communication.
- G** Portable cartridge tape back up. Stores 17.5 MBytes of data. Operates in start/stop or streamer modes.

For complete information and specifications plus the location of your nearby IMS International dealer, call or write today! (714) 978-6966 or (702) 883-7611

IMS
INTERNATIONAL

2800 Lockheed Way
Carson City, NV 89701
Telex: 910-395-6051

We Build Computers As If Your Business Depended On Them.

Mnemonic	Description	Byte(s) Location
PSS	Physical sector size in bytes (16-bit value)	04, 05
PCC	Physical cylinder count (16-bit value)	06, 07
HCT	Number of heads per cylinder	08
PST	Number of sectors per track	09
RFT	Recording-format table	0A
	01 = FM	
	02 = MFM	
	03 = MMFM	
TAS	Track-access sequence	0B
	00 = Cylinder (Increment head count before advancing cylinder count.)	
	01 = Side A (Increment cylinder count before advancing head count to highest cylinder, then decrement cylinder count after incrementing head count; CP/M format.)	
	02 = Side B (Increment cylinder count before advancing head count to highest cylinder, then return to cylinder 0 and advance cylinder count after incrementing to new head.)	
RES	Reserved for future standardization	0C through 0F

Table 2: A description of the bytes in the physical-media-parameter table (PMP) in figure 2.

Mnemonic	Description	Byte(s) Location
CST	Starting cylinder for load area	10, 11
HST	Starting head for load area	12
SST	Starting sector for load area	13
CEN	Ending cylinder of load area	14, 15
HEN	Ending head of load area	16
SEN	Ending sector of load area	17
SID	System identification (two bytes requiring registration)	18, 19
	Byte 18 Byte 19	
	00 00 = 8080	
	01 00 = Z80	
	02 00 = 6800	
	03 00 = 68000	
	04 00 = 8086	
	05 00 = Z8000	
SIC	System configuration (two bytes requiring registration for variables on SID)	1A, 1B
LFI	Load-format indicator (one byte for indication of load format)	1C
	00 = Sequential: begin at start cylinder, head, and sector; load at start of system memory	
	01 = Sequential with load addressing at first locations of start cylinder, head, and sector (see load-element descriptor)	
LFQ	Load-format qualifier (one byte of system-dependent load qualifier used as a check for load condition)	1D
LFR	Load-format reserve (reserved for future standardization)	1E, 1F

Table 3: A description of the bytes that make up the load-parameter block (LPB) in figure 2.

(SID). Each bit indicates whether one of several blocks or tables are active. Each "1" bit means that the corresponding pointer field for that block is in use for its appointed purpose. The layouts of bytes 2 and 3 are given in table 1. The exact purpose of the bits in byte 3 has not yet been determined, but they are reserved in case the media-parameter block should ever grow to 512 bytes.

Table 2 describes the bytes in the physical-media-parameter table (PMP) in figure 2. If you examine these bytes closely, you can see that a huge disk can be accommodated. No, I haven't seen any new product announcements; this is just a little groundwork to handle all those rumors coming out of Silicon Valley.

The load-parameter block, while not always needed, has some features we haven't seen on disks previously (see table 3). These are typical of the new features that seem to come out of the woodwork when a new standard is designed. In particular, your attention is called to the SID byte in table 3. That byte contains information on the type of microprocessor that is expected to execute the code in the load block. This information will help prevent you from trying to execute 6502 code on your 8088.

Also noteworthy is an accommodation for new formats (that is, new for microcomputers) such as relocatable object code. Yes indeed, the proposed standard is trying to look as far ahead as is practical.

Those among you who have used Unix may be wondering about the chained directories of that system. They would be easy to add. The directory in this new proposal could serve as the root directory for a series of subdirectories. From then on, it is just a matter of designating a file for each subdirectory. The directory-descriptor block in figure 2 would describe the root directory and the individual fields in it.

I am purposely avoiding giving more details here. This format is just a proposal, and other people have written papers about features that have not yet been adequately discussed. I would hate to see any of you write code and then find that there

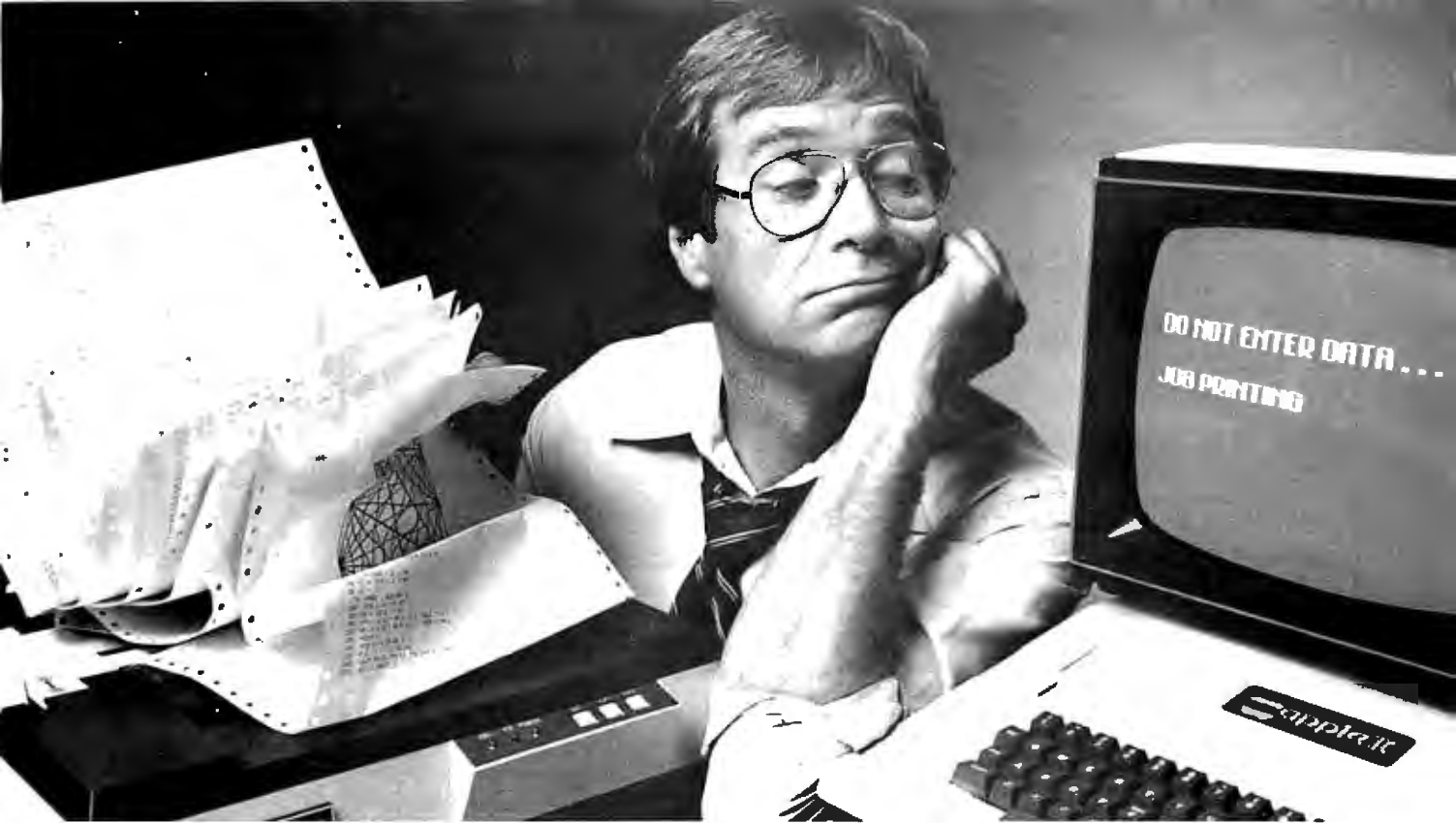

If your printer uses your Apple[®] more than you do, you need The Bufferboard[™].

If your Apple is locked into the "PRINT" mode so much that you've taken up solitaire to kill the boredom, you need a buffer. And if your computer is the Apple II or III, the only buffer for you is The Bufferboard. Expandable to 64K of storage, The Bufferboard stores an instantaneous **bucketful** of print data from your computer. Then it feeds the data to your printer at its own printing rate. Your Apple is set free from driving your printer and is ready for more data from you.

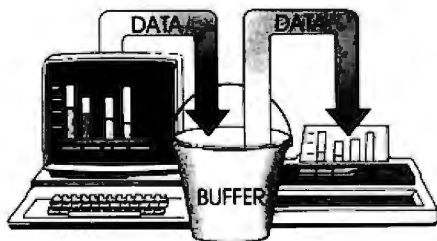

Take your existing interface— and buffer it!

Only The Bufferboard has a simple Interface-Docking System. No bulky boxes

or expensive power supplies are needed because The Bufferboard fits right into your Apple—and docks onto your existing printer interface. The result is convenient

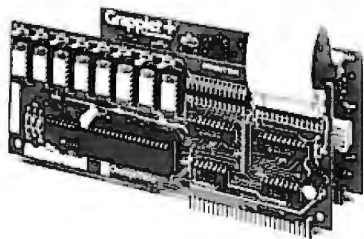

and economical buffering of most popular printer interfaces, including the Grappler +[™] interface, Epson interface, and Apple printer interface. Thirty seconds and a single hook-up are all you need to end the printer waiting game forever.

Up to 20 letter-size pages stored at a time.

The Bufferboard comes standard with 16K, and is expandable to 32K or 64K of buffering capacity with the addition of

memory chips. This "bucket" will hold up to 20 pages of a print job, allowing you freedom to use your Apple.

The Bufferboard—designed exclusively for the Apple Computer.

Specifications:

- Versions for Grappler + interface, Epson interface, Apple interface, and other popular printer interfaces
- 16K buffer standard
- Upgradeable to 32K or 64K
- Automatic memory configuration
- Automatic self test
- Includes interface docking cable.

The Bufferboard is made by Orange Micro, Inc.; the same people who brought you the popular Grappler + printer interface. Both the Grappler + and The Bufferboard are now available at your local Apple dealer.

Apple is a registered trademark of Apple, Inc. Epson is a registered trademark of Epson America, Inc.

Orange Micro Inc.

1400 N. Lakeview, Anaheim, CA 92807

U.S.A. (714) 779-2772

TELEX: TX 183511 CSMA

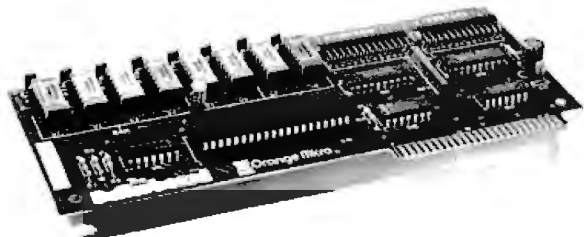

The Bufferboard[™]
For Apples and Printers

Circle 310 on Inquiry card.

©Orange Micro, Inc. 1982

OUR COMPETITORS COPY OUR ADVERTISEMENTS. . .

<p>COLUMBIA DATA PRODUCTS, INC.</p> <p>The Multi-Personal Computer</p> <p>NEW! IBM PC compatible</p>  <p>PLEASE CALL FOR MORE INFORMATION</p> <p>Completely compatible with all IBM PC software and peripheral cards.</p> <p>Features: 16-bit 8088 processor, 128K RAM, dual DOS/DD floppy disk drives, 8 expansion slots, electronics printer port, and two RS-232 serial ports.</p>	<p>ATARI</p> <p>ATARI 800 48K Memory</p> <p>LOWEST PRICE EVER! PLEASE CALL</p>  <p>Atari 400 (1MB) CALL 418 Program Recorder 79⁹⁹ 810 Disk Drive 439⁹⁹ 850 Interface Module 169⁹⁹ 16K Ram Module 64⁹⁹ Bit 12 80 column card for 800 289⁹⁹ Atari Symbic Lightpen 129⁹⁹</p>	<p>IBM PC COMPATIBLE HARDWARE</p> <p>SAVE \$1000</p>  <p>COMPLETE SYSTEMS AVAILABLE</p> <p>System includes: keyboard, monochrome display, dual 5D/DD (1 megabyte), disk drives, 64K RAM, parallel printer adapter and DOS 1.2 & manual.</p> <p>Call for Price and Availability</p> <p>IBM Peripherals</p> <p>Apparel Combo Card w/cable 255⁹⁹ Apparel Clock/Calendar card 99⁹⁹ Symbic Lightpen 135⁹⁹ Dancing Horse Disk Drives CALL</p>	<p>Commodore</p> <p>Commodore 64 and VIC 20 Peripherals</p> <p>VIC1541 Disk Drive 339⁹⁹ Datasette Program Recorder 659⁹⁹ Joystick Controller 10⁹⁹ VIC 1525 Graphic Printer 329⁹⁹ VIC Super Expander 54⁹⁹ 8K RAM Cartridge 49⁹⁹ 16K Ram Cartridge 39⁹⁹ VIC RS-232C Terminal Interface 139⁹⁹ VIC Modem 109⁹⁹</p>	<p>PRINTERS</p> <p>Reader 8501A 1349⁹⁹ Smith Corona 81 or P1 1299⁹⁹ Pacemaker 2350 350 CPS 1099⁹⁹</p> <p>C. ITOH ELECTRONICS, INC.</p> <p>F-15 85 CPS (parallel & serial) CALL F-10 40 CPS (parallel) 1399⁹⁹ F-10 40 CPS (serial) 1399⁹⁹ ProWriter 8510 10" (serial) 459⁹⁹ ProWriter 8510 10" (serial) 479⁹⁹ ProWriter II 1550 15" models CALL</p> <p>EPSON</p> <p>NEW! LOWER PRICE!</p> <p>MX-80 FT Type II w/graphics CALL MX-100 Type II w/graphics CALL</p>
<p>NEC</p>  <p>PC-6000 Computer Call for Details PC-8001A Microcomputer 32K 749⁹⁹ PC-8001A Dual mini-disk drives 749⁹⁹ PC-8012A HD Unit, 32K, 7 slots 459⁹⁹ 32K Memory Card (for 8012) 169⁹⁹ Rien Fac Wedge Expansion w/32K 409⁹⁹</p> <p>NEC PC-8001 Software</p> <p>NECCPM Operating System 125⁹⁹ WordStar by MicroPro 379⁹⁹ SuperSort by MicroPro 189⁹⁹</p> <p>Package that do not require CP/M:</p> <p>General Ledger 249⁹⁹ A/R, A/P, Inventory, Payroll ea. 249⁹⁹ Report Manager 149⁹⁹ Select Word Processor 349⁹⁹</p> <p>We carry more NEC compatible software.</p> <p>HUNDREDS OF ITEMS IN OUR WINTER CATALOG SEND \$1.00, CREDITED TO YOUR NEXT ORDER</p>	<p>ATARI SOFTWARE</p> <p>Word Processor (D) 119⁹⁹ MicroSoft BASIC(D) 89⁹⁹ Macro Assembler & Text Editor (d) 69⁹⁹ Pac-Man (cartridge) 34⁹⁹ Centipede (cartridge) 34⁹⁹ Missile Command (cartridge) 29⁹⁹ Star Raiders (cartridge) 34⁹⁹ Space Invaders (cartridge) 34⁹⁹ Caverns of Mars (disk) 29⁹⁹ Assembler/Editor (cartridge) 49⁹⁹</p> <p>We carry much more software for ATARI.</p> <p>MODEMS</p> <p>ANCHOR AUTOMATION, INC.</p> <p>Signalman I (RS-232) 89⁹⁹ Signalman II (Atari) 69⁹⁹</p> <p>Hayes</p> <p>Smartmodem II 300 baud 239⁹⁹ Smartmodem II 1200 baud 549⁹⁹ Chronograph 199⁹⁹</p> <p>Novation</p> <p>Novation D-Cat direct connect 179⁹⁹ Cat acoustic modem 149⁹⁹</p>	<p>AST</p> <p>Combo Plus 64K with on-board Serial, Parallel, and Clock/Calendar 449⁹⁹ 128K 599⁹⁹ 192K 679⁹⁹ 256K 629⁹⁹</p> <p>MICROSOFT</p> <p>64K Card 279⁹⁹ Add 95.00 for each additional 64K</p> <p>QUADRAM</p> <p>Quadboards with Serial and Parallel ports, clock/calendar, and memory in 64K, 128K, 192K, & 256K configurations. PLEASE CALL FOR OUR PRICES.</p> <p>ADD-ON DISK DRIVES</p> <p>Tandon TM-100-2 Add-on Drive 309⁹⁹ Percom Add-on Single Sided Drive 319⁹⁹ Percom Add-on Double Sided Drive 309⁹⁹</p> <p>VISICORP (NEW!) VISICALC WORD PROCESSING EXTENDED VERSION \$299 \$299</p>	<p>PLEASE CALL FOR DETAILS AND PRICES ON COMMODORE 64 EQUIPMENT & ACCESSORIES</p> <p>Software</p> <p>Software Available Now:</p> <p>Mailing List System 20⁹⁹ Word (text) Processor 35⁹⁹ Time Management 25⁹⁹</p> <p>APPLE ATARI 6 TRS-80 Program Loaders for the C-64 are Coming Soon!</p>  <p>VIC-20 \$179</p> <p>We have dozens of accessories and programs for the VIC 20, please call.</p> <p>DISKETTES</p> <p>Verbatim 5 1/4 5D/DD 1029⁹⁹ 100/280⁹⁹ Scotch 3M 5 1/4 5D/DD 1039⁹⁹ 100/250⁹⁹ Verbatim 5 1/4 05/DD 1044⁹⁹ 100/400⁹⁹ Scotch 3M 5 1/4 05/DD 1043⁹⁹ 100/395⁹⁹ National 3 1/2 5D/DD 1027⁹⁹ 100/236⁹⁹ National 3 1/2 05/DD 1037⁹⁹ 100/225⁹⁹</p>	<p>Integral Data Systems, Inc.</p> <p>IDS MicroPrism (80 column) 629⁹⁹ Prism 132 Color (all options) 1399⁹⁹</p> <p>NEC</p> <p>8023 Impact Dot Matrix 479⁹⁹ 3510 33 CPS Spinwriters PLEASE CALL</p> <p>OKIDATA</p>  <p>Okidata 82A 80 col. w/tractor 489⁹⁹ Okidata 85A 132 col. w/tractor CALL Okidata 84A 132 col. PLEASE CALL</p> <p>GEMINI PRINTERS</p> <p>NEW! FEATURES LIKE THE EPSON</p> <p>These printers have features identical to the EPSON line and print faster!</p> <p>Gemini 10 10" 100 CPS Fric/Trac 449⁹⁹ Gemini 15 15" 100 CPS Fric/Trac 549⁹⁹</p> <p>Call for more detail on the Gemini line of Epson compatible printers.</p>

had been changes. In this article, I am just nailing down the concepts; the actual bit-fiddling is yet to come.

Other Proposals

Other disk-format proposals have been suggested, but these proposals always seemed to be lurking off in the distance. After a long wait (some may say too long), I was asked to take the issue in hand and write my own proposal. Certain things undoubtedly were left out. Things like "my secret sauce key" that some suppliers use to copy-protect their disks are not directly referenced, but that does not preclude them. Standardizing them, however, might make the software pirate's job a little bit too easy.

One proposal that surfaced as this article was written comes from the National Bureau of Standards and has its origin in Europe in the International Organization for Standardization (ISO, Committee TC97/SC15). From what I have seen, that proposal is not completely incompatible with what has been described here. If the ISO proposal were slightly modified, it could be added to my proposal,

thus supplying my proposal with even more optional formats. I hope the two efforts can be merged into a single cohesive standard.

You might think this whole thing is a bit fantastic. For such a standard to be developed, all of the major software developers would have to agree on it. And why would the big suppliers all of a sudden get involved in working together on a standard? My guess is that some of the older established companies are more standards-oriented than some of the start-up ventures that have formed the foundation of the microcomputer field. These older companies, such as IBM, Sperry Univac, Xerox, and Digital Equipment Corporation, see that they have a need to interchange disks just as you and I do. Moreover, they have huge investments in systems that use structures rather different from those used on personal computers. With this new standard, it would be possible to link these different structures with each other and with microcomputers.

Also, some microcomputer companies, such as Digital Research,

Morrow, and Osborne, have shown interest in a standard disk format. My proposed format is not the same as the CP/M operating system or its cousins, but it is similar. And I can foresee products that will bridge the gap between these formats.

I hear that Version 3.0 of CP/M will be upon us by the time this appears in print, and it will take into account things that have been available to those who use other operating systems (for example, the Flex system on the 6800 and 6809 systems). What features might Version 3.0 include? How about date stamps to indicate when a directory entry was created? What about permission codes for shared access? This latter feature may not be very exciting for anybody not in a multiuser situation. But a lot of us have often dealt with that situation and see the shared-access problem. The supplier of CP/M, Digital Research, feels the need for multiuser and networking versions of its systems. Strangely, however, these issues did not seem to come up earlier when people had to share one disk on the single-user systems.

BUT THEY DON'T MATCH OUR PRICES AND SERVICES.

<p>APPLE and IBM SOFTWARE</p> <p>CHASE 8 DISKS APPLE II IBM PC EasyWriter II 199** 259** SQRHM SuperCalc 225** 239**</p> <p>MicroPro</p> <p>WordStar 379** 379** MailMerge 189** 189** SuperStar 189** 189** SuperSort 189** 189** NEW! Thesaurus for use with WordStar: 60,000 words indexed by the 4500 most commonly used words (Apple/IBM) 199**</p> <p>Peachtree Accounting Packages CALL VisiCalc 185** 159** VisiCalc (256K) N/A 199** Extended Version N/A 299** VisiText/Print 229** 239** VisiFile 185** 199** VisiTerm 89** N/A VisiDraw 185** 185**</p>	<p>APPLE II and FRANKLIN COMPATIBLE HARDWARE AND SOFTWARE</p> <p>MICROSOFT.</p> <p>MICROSOFT SOFTCARD PREMIUM SYSTEM (Includes: 2.80 SoftCard, 16K RamCard, Videx Videoterm, Softswitch, & CP/M User Guide by Osborne), List 755.00 Special Package Pricing — Only 569**</p> <p>2.80 SoftCard CP/M by Microsoft 259** 16K Ram Card by Microsoft & SOURCE 79**</p> <p>Videx</p> <p>Videx Video Term 80 Column Card 249** Videx Keyboard Enhancer II 119** Utility for 80 Column VisiCalc 39**</p> <p>Hayes</p> <p>Hayes Micromodem II 289** Hayes Micromodem II w/terminal pkg. 329**</p> <p>Mountain Computer INCORPORATED</p> <p>CPS Multi-Function Card 169** Music Synthesizer System 299** A/D + D/A 16 Ch. Interface 279** Romplus 129** Romwriter 149** Expand Chassis 569** Clock/Cal 229**</p>	<p>FRANKLIN VIDEO FUN!</p> <p>APPLE II COMPATIBLE DISK DRIVES</p> <p>Fourth Dimension Woodruffler 689** Fourth Dimension add-on 339**</p> <p>Rana Drive 289** Rana Drive Controller Card 119**</p> <p>μ-SCI</p> <p>A2 with controller 369** A2 add-on 289** A4 with controller 449** A4 add-on 399**</p> <p>APPLE and FRANKLIN COMPATIBLE SOFTWARE</p> <p>HowardSoft (1982) Tax Preparer 119** MultiPlan by Microsoft 239** Microfit TACS Applesoft Compiler 149** Screenwriter II word Processor 99** PFS (Personal Filing System) 89** PSF Report 85** DB Master by StoneWare 165** Landlord Property Mgt. Sys. 399**</p> <p>We stock the Top 100 Selection of software packages for the Apple II and Franklin.</p>	<p>COLECOVISION</p> <p>ONLY \$195</p> <p>State-of-the-Art Video Game</p> <p>Features unsurpassed graphic resolution, superior arcade-type games, and a remarkable expansion capability allowing the use of existing Atari and Activision cartridges.</p> <p>We carry all of the Coleco-Video app-on accessories and cartridges. PLEASE CALL</p> <p>INTELLIVISION</p> <p>ONLY \$249</p> <p>Includes everything necessary for immediate family enjoyment. List 309**</p> <p>We carry Intellivision accessories too.</p> <p>Timex Sinclair 1000</p> <p>\$89</p> <p>We carry Timex (Sinclair) accessories.</p>
<p>MONITORS</p> <p>Amdek Video 300 12" Hi-Res Green 529** Amdek Color 13" Color w/splitter 349** Amdek Color II Hi-Res RGB 729** Amdek Color III anatomical RGB 449**</p> <p>NEC</p> <p>NEC Hi-Res Green 12" Monitor 169** NEC Composite Color 12" 339** NEC JB 1202 RGB monitor 769** NEC (JB 1203) IBM compatible RGB 766**</p> <p>SANYO</p> <p>Sanyo 9" Green monitor 169** Sanyo 12" B&W Green monitor CALL Sanyo 13" Color or RGB monitor CALL</p> <p>TAXAN</p> <p>Affordable RGB monitors</p> <p>Vision 112" RGB 380 Lines 389** Vision 112" RGB 510 Lines 549** Vision 112" RGB 630 Lines 839**</p> <p>ZENITH</p> <p>Zenith 12" Green monitors 119** US1 12" Amber Monitor 189** US1 12" Green Monitor 179**</p> <p>We carry ELECTRONOME Monitors also. Please call for details and prices.</p>	<p>OTHER POPULAR ACCESSORIES</p> <p>ALF 9 VoiceMusic Card 149** CCS 7710A Asynch. Serial card 139** Grappier/F (specialty printer) 139** Laser Lower Case Plus III 39** M&R 80 Column Video cards 39** Novation Apple Cal II 1200 baud 319** Practical Peripheral Buffer cards CALL Thunderware Clock/Calendar 119** TG Joystick 49** TG Paddles 39** Vista Vision 80 Column Card 259** Versawriter Duplicator Pad 249** Wizard BPO & SOB cards 139**</p> <p>16K RamBoard</p> <p>ASSEMBLED & TESTED FOR APPLE II</p> <p>\$49</p> <p>While Supplies Last</p> <p>BUILD YOUR OWN! RAM BOARD ONLY \$13.99</p>	<p>Formerly consumer computers</p> <p>Order Toll Free 800-854-6654</p> <p>Info & Calif 619-698-8088</p> <p>We accept most major credit cards, bank wires, money orders, cashiers or certified checks and personal checks (10 days to clear). For shipping, handling and insurance add 3% if pre-paid with a check and 5% if paid by credit card (min. \$5.00). UPS Blue Label air-service is shipped F.O.B. CA. Residents add 6% sales tax. Foreign orders are shipped freight collect. All equipment is new and complete with manufacturer's warranty. Send \$1.00 for Catalog/Price List, credited to your next purchase. We have a customer satisfaction policy — contact us for details.</p> <p>8338 Center Drive La Mesa, California 92041</p>	<p>Circle 119 on Inquiry card</p>

Other Disks

You may have noticed that I have been talking about disks in general rather than just the flexible disk cartridges we know as floppies. Why? Software suppliers and users have been pushing hard for compatibility between all types of storage media. Many people want the new hard-disk cartridges to work with software as if they were just large versions of their black-enveloped cousins. It would be rather foolish to invent new structures for no compelling reason.

Similarly, many suppliers and users want to get the less-than-5¼-inch disks under control before we see them explode all over us. We should be able to use the format proposed here on these new 3- to 3½-inch disks. So far, the technologies that have been proposed for these disks have been compatible with our proposal.

By adding extensions in the future, we should be able to use this format for a long time. I intended that the format serve as a guide for all of the newly emerging exotic disks we are reading about. This would be similar

to the way the Shugart media interface has been adopted as a guide for all floppy-disk-drive manufacturers. Otherwise, more chaos will follow. We hope that the suppliers and developers of these new devices will let us know about any special needs they may have.

But what about the piracy problem? Wouldn't such a standard make it worse? Ours is an interesting industry. If you make things challenging, the software pirate will take the challenge. A former boss often reminded me that "you can't make a good contract with a crook." I have always taken that to mean that goodwill is as important as good locks. We can offset the piracy matter more by careful pricing strategies and by developing goodwill with consumers than with all the tricks in the barrel. Of course, the data itself can always be encrypted. But I don't want to trigger another discussion on that here.

Another phenomenon sneaking up on us is networking. Public networks and computer-based message systems (CBMS) are with us today, and many of us regularly use them. These

systems will require some type of storage medium if copies are to be made of messages. But should these messages be stored in the form the host computer uses or one that the addressee can read? This is a good question. Under the new proposal, these formats would be compatible.

Getting Involved

Now, what can you as an individual user do to push for quick development of a standard for disk formats? For one thing, you can write to me. I promise to reply to everyone who writes, and I also promise to deliver your opinion to the project team that is being formed to solve this problem. I have been dubbed the convener or initial chairperson of the committee assigned to develop the new floppy-disk standard. That gives me a good chance to see that your opinions are heard.

How else can you help? If you or your employer can stand the cost, your direct participation is possible. An annual fee of \$150 handles the cost of getting you registered on the committee. You can even designate

someone as an alternate for yourself on that same \$150 fee. Being on the committee will also involve about 15 percent of your time, and you will annually incur travel costs for about four meetings of three days' duration each, invariably held on the other side of the continent from wherever you live. That expensive? Yes. How can anybody afford it? They are expecting eventual commensurate benefits.

My point is that you are not excluded from participating. All that is necessary is patience, interest, dem-

onstrated ability, patience again, the ability to attend the various meetings, and yet more patience. And I am not teasing you about the amount of patience required. Standards are consensus documents, and that implies getting people with many differing opinions to agree. Can you imagine getting the adherents of some exotic threaded interpreter to agree with the BASIC crowd? Oh, you could imagine that. Then add a Pascal fan to the mix and stir in an assembly-code devotee. Can you imagine the



scenario? I see it quite often.

Now for the bad news. When can we expect to see a disk-format standard? Mid-1985 is the current estimate. (Are you still there?) But as consumers you should be able to detect some effects of this work by the end of this summer. How? Software suppliers, at least the ones most involved, will start anticipating the standard. You will probably even see some eager ads proclaiming adherence to the standard while the standard itself will not yet have been drafted, let alone approved.

Why did it take so long to get a proposal? My feeling is that it was the result of a mistaken notion that the ANSI activities were only for the large mainframe computers. Frankly, some people in the mainframe computer field do indeed feel that way. I feel they shouldn't, but this is a free country. Similarly, a few microcomputer specialists around are opposed to standards. Why? Standards will let others connect to their products. For good reasons they might not want to allow that. I mentioned goodwill before. Goodwill is subjective. When trust goes away, group efforts do not succeed. Microcomputer users and mainframe users are merely on two sides of one computer industry. We must work to develop trust and goodwill. Both sides have a great deal to learn from each other.

Standards do not come about just for the fun of it or to irritate the affected parties. A standard is merely one possible solution to a recurring problem, but it should be a solution developed by consensus of the concerned parties. Some problems, of course, are bigger than others. It took quite a while before this one was seen as a problem. When this disk-format standard is behind us, we will wonder why we ever needed to discuss the matter in the first place.

Let me hear your needs for the interchange of disks. Unfortunately, of course, I will not be able to accept your information *on a disk* (unless, of course, you happen to send it on a 5¼-inch Flex2 disk for my 6800 system). But I hope, with your help, this situation will not last too much longer. ■

  	
2723 W. Windrose Suite 3 Phoenix, Arizona 85029 1-800-528-8960	
All Prices Subject To Change	
COMPUTERS ATARI 400K-16K - \$289 800-48K - \$645 410 - \$77 810 - \$429 830 - \$155 850 - \$159 ALTOS 5-15D - \$2249 5-5D - \$4399 NORTHSTAR Advantage - \$2600 Horizon 64QD - \$2600 TELEVIDEO 802 - \$2599 802H - \$4450 806 - \$4950 800A - \$1290 FRANKLIN ACE 1000 SCALL	PRINTERS OKIDATA M80 - \$305 M83A - \$649 M82A - \$399 w/Tractor & Grap. \$479 M84P - \$988 M84S - \$1090 ANADEx 9500A - \$1290 9501A - \$1290 CITOH F-10P - \$1370 F-10S - \$1375 1550P - \$659 Prowriter 1550CD - \$709 8510AP - \$479 8510ACD - \$570 DATASOUTH DS120 - \$595 DS180 - \$1175 DIABLO 630RO - \$1945 620 - \$1099 NEC 8023 - \$460 7710 - \$2220 3510 - \$1520 3550 - \$1925 TI 810 - \$1240 820 - \$1795
APPLE CARDS 16K RAM - \$78 Z80 CARD - \$245 Videx Card - \$227 Smart Term - \$279 32K Atari Card - \$99 Clock CARD - \$120	TERMINALS ADDS Viewpoint - \$485 HAZELTINE 1500 - \$995 ESPRIT - \$498 TELEVIDEO 910 - \$569 925 - \$718 920 - \$735 950 - \$899 ZENITH Z19 - \$689 Z89 - \$2129
SOFTWARE All Major Brands - \$CALL Wordstar - \$235 Datastar - \$150 Calcstar - \$100 Spellstar - \$100	MONITORS Amdek 300 - \$140 Color I - \$300 Amdek Color II - \$649 Color III - \$385 BMC Green - \$88 USI Amber - \$159
DISK DRIVE Microsci Apple Dr. \$350 Percom Atari Dr. \$390 Percom IBM Dr. \$325 Fourth Dimension Dr. \$350	OTHER MAJOR BRANDS AVAILABLE SCALL
MODEMS HAYS - MICROMODEM - \$285 HAYS - SMARTMODEM - \$219 HAYS - 1200 Baud - \$530	DISKETTES/BOXES Elephant - \$20 Scotch - \$25 Dysan - \$35
GUARANTEED LOW PRICES	Customer Service 602-863-0759

SOFTech

MICROSYSTEMS



The Universal Operating System.* Finally, you don't have to repeat yourself.

There was a time when, if you wanted to develop applications for more than one micro, you had to sink significant time and money into reprogramming. Time after time.

With the UCSD p-System* from SofTech Microsystems, the industry's only Universal Operating System, those days are over. Whether it's an IBM PC or Displaywriter, an Apple, a DEC, an HP, an Osborne, a Philips, a Sage, a Tandy, or a TI, the p-System is portable across virtually any micro made anywhere today.

At last, increase your productivity.

Because the programming you do is portable and reusable. Every time. For every micro. So you can broaden your customer base quickly. Because the p-System runs the same object code programs on virtually all 8 and 16-bit micros.

We know how much work you put into programming, so the p-System allows you to reuse program com-

ponents. At last, you can use programs and utilities over and over again—instead of writing them over and over again. In fact, as much as 50% of the code used in one application can be reused on others.

Designed to be timeless.

With the p-System, you'll never have to worry about locking yourself into an OS that will some day lock you out of the market. Because the p-System's efficient, advanced design will let you grow with tomorrow's hardware, and let you continue to expand your product line.

You can develop higher quality applications faster, less expensively, more dependably and more efficiently. For the entire market.

All at the same time. All on one micro.

Finally, once really is enough.

**Finally,
Once is Enough.**

For product information or information on how to get a copy of the p-System Application Catalog, call or write to us at SofTech Microsystems.

SofTech Microsystems • 16885 West Bernardo Drive • San Diego, CA 92127 • (619) 451-1230

*Universal Operating System is a trademark of SofTech Microsystems Inc., UCSD p-System is a trademark of the Regents of the University of California

MASTER THE "NEW ELECTRONICS" WITH MCGRAW-HILL'S

Contemporary



Now you can meet the challenges of today's incredibly rapid changes in electronics quickly and easily. This professional level electronics learning series is as innovative as the circuitry it explains and as fascinating as the experiments you build and explore!

From digital logic to the latest 16-bit microprocessor, you master one subject at a time with McGraw-Hill Concept Modules sent to you one at a time, once a month, to make up the complete CONTEMPORARY ELECTRONICS SERIES. Each module of the fifteen in the Series is a unique blend of "hands-on" experience, interactive audio cassettes, and vividly illustrated printed support materials. Together they will prepare you for tomorrow's better jobs or advancement in your present position by staying current with today's electronics revolution. Professional in every respect, yet it's a

lively learning experience that has all the fun and fascination of a hobby.

Understand Digital Logic ... Microprocessors ... Optoelectronics

Here's an extraordinary opportunity to update your understanding of today's most important technological changes in electronics. You can start from scratch or use the Series to update yourself. You cover the latest integrated circuits, including TTL, CMOS, and ECL digital circuits; op-amps; phase-locked loops; microprocessors; and opto devices such as LEDs and LCDs.

Perform Electronic Experiments

With your first module you'll use the latest digital integrated circuits to build an oscillator circuit that demonstrates digital signals—verified visually by the flash of light emitting diodes (LEDs) and audibly by tones produced through the mini-speaker that is provided.

You'll know the differences (and similarities) between electronics and electricity, learn the concepts applicable to all electronic circuits. With the first module, you will be able to identify the major passive components, like resistors, capacitors, inductors, diodes and

Electronics Series

Each Concept goes right to the heart of the matter. You waste no time on extraneous material or outdated history. It's a fast, efficient, and lively learning experience, a nontraditional approach to the most modern of subject matter.

Construct and Use a Prototyping/Design Laboratory

What's more, when you reach the midpoint of your

YOU COVER EVERY SUBJECT IN CONTEMPORARY ELECTRONICS

- Digital logic
- Digital gates (TTL, CMOS, ECL, NMOS)
- Flip flops, counters and registers. Op-amps and applications
- Power supplies (plus IC and switching regulators)
- Combinational logic circuits (ROMs, PLAs, decoders, etc.)
- Circuit analysis. AC theory. LCR networks
- Transistors (bipolar and FETs), diodes, thyristors
- Integrated circuits (linear and digital)
- Oscillators and function generators
- Modulation and demodulation
- Optoelectronics
- Digital multimeters and scopes
- Microprocessors

Series, you will have constructed a professional Prototyping/Design Laboratory which will become a valuable learning tool throughout the remainder of your studies. This Prototyping/Design Lab contains a signal generator; logic switches, pushbuttons, and LED indicators. It rivals professional instruments that are widely used in industrial laboratories for electronic design and development as well as testing and measuring. Because of its versatility, it is an instrument that you will use again and again, even after you have completed your Contemporary Electronics Series.

With each new module you'll receive a McGraw-Hill Action-Audio Cassette, a proven successful method of programmed, interactive instruction. Each tape creates a dynamic dialogue that not only quickly communicates the facts, but makes you feel that you're participating, as you respond to questions and listen to problems being solved.

Your ability to rapidly make this knowledge your own is further aided by a strikingly original technique for using diagrams, illustrations, and schematics to drive home points made as you listen to the cassette. The same carefully indexed binder that contains this material also includes the instructions

to guide you through hands-on experiments. Finally, having completed the Series, you can be awarded a Certificate of Achievement from the McGraw-Hill Continuing Education Center upon passing an optional final examination.

Update Your Knowledge of the New Electronics

This program is for you whether you're a scientist who can use electronics to improve or speed up your investigations... a teacher who'd benefit from a refresher in contemporary components, circuits and applications... a manager or supervisor in an electronics related industry or business... an engineer in another field who finds electronics playing an ever more important role in your work... someone looking to find new direction in this wide open field... or the kind of person who wants to understand what's going on in the world around you.

McGraw-Hill's Contemporary Electronics Series offers you the quickest and probably least expensive learning method available today, and the only one with "hands-on" experience.

No Risk, No Obligation

And we invite you to prove all this to your own satisfaction—without risk and without committing yourself in any way.

Return the reply card and we'll send you the first module and other materials for a free 14-day examination. If you're not absolutely satisfied, and certain that this is an enjoyable as well as highly effective way to learn, simply return the module to us along with the unpaid bill and that will be the end of it.

If you wish to continue, we'll ship the remaining modules automatically, about once a month, for only \$19.95 each plus \$2.25 for shipping and handling. Remember, each module comes on the same 14-day free examination basis, with no obligation to pay for any module you don't want to keep.

Return the reply card now. It'll bring you the first module Contemporary Electronic Components and Circuits... your first step in becoming an expert in the "new electronics." There's no risk or obligation.

If the card is missing write to:



Contemporary Electronics Series
McGraw-Hill Continuing Education Center
3939 Wisconsin Avenue, NW
Washington, DC 20016



With your first module you'll receive this professional solderless breadboarding system. It enables you to connect components and build electronic circuits easily and quickly. It's used throughout the series and can be used later to design, build and test your own circuits.



The Proposed ANSI BASIC Standard

The committee asks for your opinion.

Ronald Anderson
2122 Riverside Ave.
Minneapolis, MN 55454

Last June, BYTE published an article by Thomas Kurtz outlining the new proposed standard for the BASIC language (see "On the Way to Standard BASIC," June 1982 BYTE, page 182). It was the first article to describe the new proposal of the ANSI (American National Standards Institute) BASIC Committee, also called the X3J2 subcommittee. The proposed BASIC standard now must go before two other ANSI committees, X3 and SPARC (Standards Planning and Requirements Committee), before entering a formal period of public review. Committee approval is expected in early 1983, at which time the 120-day public review will begin.

At the end of this review period, the various ANSI committees will study the public feedback and decide whether or not to make revisions to the proposed standard and whether or not to recommend final approval. The ANSI X3J2 committee is current-

ly scheduled to meet again in July 1983 for this purpose.

Anticipating the process whereby anyone can register complaints or cheers, the Association for Computing Machinery (ACM) is informally collecting comments from members and from the public. ACM

Acceptance of a proposed standard by ACM is by no means automatic.

is represented on the ANSI X3 committee by John A. N. Lee, and before he casts a final vote on the standard, he needs input from the membership, which currently numbers more than 60,000, and others.

Acceptance of a proposed standard by ACM is by no means automatic. For example, ACM voted against approval of the proposed Ada standard because most of the letters from members were very negative.

Because I am chairman of the ACM Special Interest Group on Computer Uses in Education (SIGCUE), I was appointed to coordinate the public-

review process of BASIC standards for ACM. I am collecting letters and pooling comments as they arrive.

A number of letters have come in, and in addition, a public forum on the subject was held at the annual meetings of the ACM in Dallas on October 27, 1982. This forum offered the public an opportunity for discussion following presentations by several members of the ANSI BASIC Committee, including Carlyle Phillips of Texas Instruments and Thomas Kurtz of Dartmouth College.

ANSI BASIC versus ANSI Minimal BASIC

The ANSI BASIC (X3J2) Committee has been working on a standard for eight years. During this prolonged effort, the members produced an earlier proposal, which was officially adopted in 1978. But that standard is a minimal subset and for that reason was called Minimal BASIC. Now that X3J2 is recommending another standard BASIC, some semantic confusion has developed. The current proposed version includes extensions far beyond most existing implementations of BASIC, yet X3J2 is simply calling it BASIC, not Extended

About the Author

Ronald Anderson is chairman of the ACM Special Interest Group on Computer Uses in Education and an associate professor at the University of Minnesota.

CP/M[®]
IBM[®]
APPLE[®]

PRICE WAR!

WordStar[®] \$299	dBASE II[™] \$489	SuperCalc[™] \$189	Multiplan[™] \$199	VisiCalc[®] \$189
WordStar[®] MailMerge[™] \$429	WordStar[®] dBASE II[™] \$749	Perfect Writer[™] \$229	SuperWriter[™] \$249	InfoStar[™] \$299

ASPEN SOFTWARE[™] Grammatik \$ 60 Random House Proofreader \$ 39 Random House Thesaurus \$119 Univ. of Chicago Manual of Style \$119 ASHTON-TATE[™] dBase II \$489 DIGITAL RESEARCH[™] CBASIC \$ 99 FOX AND GELLER[™] Quickcode \$229 dUtil \$ 69 IUS[™] Easywriter II \$239 Easyspeller \$139 Easyfiler \$269	MICROPRO[®] WordStar \$299 MailMerge \$149 WordStar MailMerge \$429 WordStar MailMerge SpellStar \$529 WordStar InfoStar \$549 InfoStar \$299 CalcStar \$ 89 DataStar \$179 SuperSort \$149 SpellStar \$149 ReportStar \$229 DataStar Update CALL MICROSOFT[™] Softcard \$259 Ram Card \$139 Videoterm (Videx [™]) \$269 All Three Above \$509 Multiplan \$199	Enhancer II \$119 Basic 80 \$275 Basic Compiler \$295 MICROSTUF[™] Crosstalk \$135 PERFECT SOFTWARE[™] Perfect Writer \$229 Perfect Speller \$139 Perfect Writer Speller \$329 Perfect Calc \$149 Perfect Filer \$279 All Four Perfect Products \$695 PICKLES AND TROUT[™] CP M for TRS Model II \$169 CP M for TRS Model 16 \$189 Hard Disk CALL OASIS[™] The Word Plus \$129 Punctuation and Style \$109	SILICON VALLEY SYSTEMS[™] Word Handler \$149 List Handler \$129 SORCIM[™] SuperCalc \$189 SuperWriter \$249 SpellGuard \$129 TCS ACCOUNTING[™] General Ledger \$ 99 Accounts Payable \$ 99 Accounts Receivable \$ 99 Payroll \$ 99 All Four Above \$289 Inventory Management \$ 99 VISICORP[®] VisiCalc \$189 All Other VisiCorp Products CALL
---	--	--	--

NOW, PAY LESS, AND GET GREAT SERVICE, TOO!

If you're looking for rock-bottom prices *and* fast, personal service, take a close look at 800-SOFTWARE.

Because we buy in volume, we're able to sell the products you want at prices that finally make some sense. But don't take our word for it. Compare prices and see for yourself!

OUR SERVICE CAN'T BE BEAT.

We take care of you like our business depends on it. Because it does.

When you call 800-SOFTWARE, you get the fastest delivery available anywhere. Which means that every order is filled the day we get it. And that our unique

Order Tracking System[™] is on the job, keeping tabs on your order, every step of the way.

Our giant inventory — one of the largest in the United States — also assures you of the fastest possible service. Everything's in stock so you don't have to wait.

Technical support? Business software expertise? We've got it — and it's the best you'll find *anywhere*.

But, put us to the test. Let us prove what we've proven to satisfied customers around the world.

That our prices *are* lower. That our service *is* better. That there really and truly *is* a difference.

We look forward to your call.

FREE GIFT!

GET 4 FLOPPY DISKETTES FREE WITH ANY PURCHASE, IF YOU ACT NOW!

- Your choice of 5 1/4" or 8"
- Brand new



TO ORDER, CALL TOLL-FREE:
800-227-4587

In California, 800-622-0678
or 415-644-3611
CA residents add sales tax.

OR WRITE: 800-SOFTWARE, INC.
185 Berry Street
San Francisco, CA 94107

 **800-SOFTWARE**



- Purchase orders accepted
- Prompt UPS 3 day Blue Label service
- Call for shipping charges and our other low software prices.
- Now open Monday through Saturday.
- Dealer and quantity discounts available.
- Prices may change.

© Copyright 800-Software, Inc. 1982

P&T CP/M[®] 2 is GROWING

TRS-80 MODEL II
\$185

Still the best CP/M for the Mod II with features like 596 Kb per diskette, type ahead, full serial port support, and more.

TRS-80 MODEL 16
\$220

Includes full support for thinline drives; gives 1.2 Mb per diskette for the Mod 16 (2-80 model) and Mod II's with double sided drives.

RADIO SHACK HARD DISK
\$250

Includes all the features of P&T CP/M 2 plus 8.7 Mb per hard disk drive.

CAMEO HARD DISK

Support for the standard Cameo hard disk system (\$250) or the multiplexer (for multiple computers) system \$400.

CORVUS HARD DISK
\$250

Support for a 5, 10, or 20 Mb Corvus hard disk system.

Start with a Model II floppy system and grow into a hard disk. Since all P&T CP/M 2 systems are fully compatible, you will have no conversion worries.

Special note: P&T hard disk systems allow you the user to configure logical drive assignments to your specifications. Write for more details.

Prepaid VISA, M/C, or COD orders accepted. All prices FOB Goleta and subject to change.

CP/M is a registered trademark of Digital Research. TRS-80 is a trademark of Tandy Corp.

PICKLES & TROUT

P.O. BOX 1206
GOLETA, CA 93116
(805) 685-4641



BASIC. Unfortunately, at the same time, some people refer to Minimal BASIC as ANSI BASIC, which strictly speaking it isn't.

To further confound communication, the ANSI BASIC proposal contains several major "optional" components, namely, graphics, editing, fixed decimals, and real-time commands. Therefore, it will not be possible to conform to the standard without having a computer equipped with graphics capabilities. Consequently, programs and implementations of ANSI BASIC that do or do not employ optional components may differ substantially, making program interchange difficult.

Positive Reactions

Before describing the negative comments and proposed revisions, I will summarize the comments favorable to the proposed standard. (I want to emphasize that these are preliminary comments, and a full summary will not be forthcoming until the spring or summer of 1983).

We have received several comments that are vague but supportive: for example, "it's about time," and "excellent." Other reactions were more specific. Philip Bouchard, Senior Programmer at the Minnesota Educational Computing Consortium, said, "I have long had a wish list (for BASIC). . . . At the top of my list are control structures, independent subroutines, and multiple-character variable names. For these features alone, the new standard is well worthwhile."

Most educators have been enthusiastic, largely because of the structured orientation of the new ANSI BASIC, which includes the following control structures:

```
IF . . . THEN . . . ELSE . . . END IF
DO UNTIL . . . LOOP
DO WHILE . . . LOOP
DO . . . EXIT DO . . . LOOP
SELECT . . . CASE . . . CASE . . . END SELECT
```

In addition, the user can enter external subroutines with a CALL statement. Line numbers can still be used, but under the new standard, programs can be written easily without the use of any internal line numbers.

In fact, the version of ANSI BASIC that Dartmouth College is now developing does not even allow line numbers.

The graphics features of the proposed standard BASIC have received a cautious welcome from the educational computing community. While consensus on the need for more graphics exists, some teachers prefer turtle graphics as used in Logo languages. Others are skeptical about the success of a useful graphics standard in BASIC when the graphics hardware for existing microcomputers varies so much.

The proposed BASIC standard is especially welcomed by high school teachers who do not want to switch from BASIC to Pascal in their programming classes. An example of the problems currently faced by educators is the fury created by the announcement of the College Board AP (Advanced Placement) test in computer science because it is based upon Pascal. The College Board committee for computer science has said, however, that if there were a common version of BASIC in a structured form, an AP test could be developed for BASIC as well. If ANSI BASIC or a structured variation were to be widely implemented on educationally popular microcomputers, the language would probably become extremely popular in programming classrooms.

Negative Reactions

Not all educators are happy with the new BASIC proposal. Alfred Bork of the University of California, Irvine, exclaimed, "Why would one want to revise an old creaky language when there are better languages around?" His greatest objection to the ANSI BASIC proposal is the omission of data-type declarations. Professor Kurtz's response was that, first of all, without data typing it is much easier to write programs and, second, if BASIC had data typing, it would be indistinguishable from other languages such as FORTRAN. In some instances, simplicity has been the criterion guiding the formulation of the latest attempt to standardize BASIC.



How to avoid becoming a casualty of the computer revolution.

The computer revolution is eliminating lots of work for everybody. Unfortunately, it's often work you wanted to keep.

Because of inconsistent or weak magnetic properties, some flexible disks can "forget" some or all of your information. But not if you're using Datalife® flexible disks. They're certified 100% error free and backed by a 5-year warranty. This means what you put on them stays, ready for instant retrieval.

So enjoy all the benefits of the computer revolution without suffering the painful loss of your information. Use Datalife by Verbatim, the world's leading producer of flexible disks.

For your nearest Verbatim dealer, call toll-free 800-538-1793; in California or outside the U.S., call collect (408) 737-7771.



COMPUTERSCOPE

DIGITAL STORAGE OSCILLOSCOPE

Features:

- High Resolution/High Speed A/D inputs
- 4 Channel Software Support
- Continuous or Single Sweep
- External Trigger Capability
- Waveform Storage on Disk
- Pretrigger Viewing
- Hardcopy Output

For:

- Automatic Test and Measurement
- Laboratory Data Acquisition
- Transient Signal Analysis
- Frequency Spectrum Analysis
- Digital Signal Conditioning and Enhancement



Purchase our complete **COMPUTERSCOPE** package for **\$3495** or combine your microcomputer with our **APPLESCOPE** hardware and **SCOPE DRIVER** software to create a total data acquisition and analysis system for only **\$695**.

APPLESCOPE INTERFACE

Choose either our original dual channel 8 bit APPLESCOPE-D2 or our new high resolution single channel APPLESCOPE-HR12 packages for \$695 or combine up to 4 APPLESCOPE-HR12 circuit cards in a high performance multichannel data acquisition system. All APPLESCOPE interfaces are fully programmable and include our SCOPE DRIVER software, external trigger adapter and BNC input connector.

The APPLESCOPE-D2 features

- Single or Dual channel trace
- 8 bit A/D converters
- 3.5 Mhz. Maximum Sample Rate (1.75 Mhz. for dual trace)
- 1024 Sample Memory

The APPLESCOPE-HR12 features

- 12 bit A/D converter
- 1 Mhz. maximum sample rate
- 2048 Sample Memory
- 4 Channel Software support

When combined with an APPLESCOPE interface our SCOPE DRIVER software creates a turnkey (NO user programming required) Digital Storage Oscilloscope including;

- Complete Trace Setup and Sweep Control
- Digital Voltage readout and real time DVM
- Waveform storage and retrieval from disk
- Hardcopy (Screen Dump)
- Digital Signal Conditioning
- 16,384 Sample Memory (DMA to Apple Ram under 28 Khz.)
- Waveform Manipulation (Scroll, Scale and Offset)
- MATH PACK - (Add, Subtract, Invert or Multiply input channels)
- AUTOMATE - User program interface for easy access to SCOPE DRIVER routines

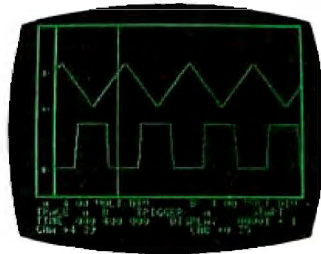

Optional data analysis software from our SCOPE DRIVER LIBRARY may be purchased to make your **COMPUTERSCOPE** a true data analysis instrument including;

- Frequency Spectrum Analysis (a FAST FFT)
- Harcopy (Continuous Strip Chart Record)
- Autocorrelation / Box Car Integration
- Pulse Rate / Frequency Measurement
- Post Stimulus Time Histogram
- Time Interval Histogram
- Signal Averager

COMPUTERSCOPE PACKAGES

For those persons looking for an alternative to expensive dedicated instruments we offer complete **COMPUTERSCOPE** packages beginning at \$3495 which includes;

- 48K Apple II+ or 64K Franklin Ace 1000
- Disk Drive with DOS 3.3 Controller
- High Resolution Green Screen Monitor
- High Resolution Graphics Printer
- APPLESCOPE D2 or HR12 Package
- Scope Driver Library
- Scope Probes

Call or write for our free data sheets or better yet purchase our comprehensive demonstration diskette for \$10 to find out why our **COMPUTERSCOPE** is the state of the art Digital Storage Oscilloscope for the 80's.

R.C. ELECTRONICS INC.

5386 Hollister Ave. #D
Santa Barbara, CA 93111
(805) 968-6614
Telex 295281

Visa

MC

Ironically, one of the most common complaints about the newly proposed ANSI BASIC is that it is so complex (because it incorporates all standard features and some optional ones) that its implementation on an actual microcomputer will be extremely difficult without a very large memory and faster microprocessor operating speeds. If this is true, it may be some time before ANSI BASIC interpreters will be available for small computers.

The only contemporary implementation of BASIC that comes close to the proposed ANSI BASIC standard is the new VAX BASIC from Digital Equipment Corporation. Until an extensive BASIC such as that proposed by X3J2 is up and running on a small-scale microcomputer, many persons will continue to doubt the viability of the proposed ANSI BASIC.

A few technical criticisms have been registered. For example, one programmer complained about the replacement of ON ERROR GOTO with WHEN EXCEPTION USE, which he perceives as semantically more cumbersome.

Another technical comment came from a BASIC product specialist at Data General (see "Letters" column, October 1982 BYTE, page 18). He pointed out how a DIM statement can be bypassed inadvertently in a program. When bypassed, arrays cannot be used to test conformity to the bounds defined by the array dimension. A minor addition to the standard could solve the problem.

Despite the apparent comprehensiveness of the ANSI BASIC proposal, several people asked that the standard go even further. One comment was, "Why can't a disk-exchange format be established for 5¼-inch disks? The committee will say this is out of their territory, but why have a language standard if I have to keyboard the program into each new microcomputer I have to run it on? . . . A software format standard is the answer."

Another expansionist request was for a more powerful editor and consistent operating-system protocols. The proposed standard has an optional editing subsystem; however, it

is limited and does not even specify normal text-editing functions such as character inserts and deletes. If every BASIC environment had identical syntax for editing commands as well as for operating-system commands, computing in a multimachine context would be considerably more user-friendly.

Philosophy of a Standard

The underlying philosophy of the proposed BASIC standard seems slightly different from that of other languages, such as FORTRAN, in that numerous extras are defined as *optional modules* rather than as *miscellaneous extensions*. Their inclusion in the official standard implies that they are desirable but not essential. Confusion may result because every implementation will almost certainly be a partial implementation, and conformity to the standard will be less meaningful because each implementer must also specify the optional features of his or her version of BASIC as well as the departures from the core standard. This is a major criticism of the proposed ANSI BASIC in that it may not solve software-incompatibility problems. With so many features defined as optional, it may be difficult to encourage programmers to clearly demarcate optional and nonstandard commands within a program.

Professor Kurtz replies that the major goal of the new ANSI BASIC is student interchange, not program interchange. "We want students," he argued, "to be able to use what they've learned elsewhere and, without total retraining, continue their learning experiences." To the extent that this philosophy is shared, it would be more appropriate to call the standard a model rather than a rule by which to measure conformity.

Several companies (e.g., Digital Equipment Corporation and Hewlett-Packard) have committed themselves to adding new BASIC features in the spirit of the proposed ANSI standard. The new VAX-11 BASIC Version 2.0 contains most of the proposed features. Dartmouth College is implementing the ANSI standard but adding extensions and deviations (e.g.,

line numbers are not allowed as statement identifiers). These projects show that having an ANSI BASIC standard is feasible, but they also forecast a continuation of diversity among BASIC implementations.

The new standard appears to be more loosely defined than most other language standards; however, the intended purpose seems not so much to produce uniformity among versions of BASIC as to steer BASIC implementers toward a common target and thus increase the chances that any given BASIC program will be usable with different versions of BASIC. ■

What's Your Opinion?

To date only a few reactions have been heard. Far more grass-roots opinions are needed. If you are reading this before the summer of 1983, you still have time to influence the verdict on ANSI BASIC. Send your comments to the author of this article so that they can be pooled and channeled into the decision process.

Copies of the "Draft Proposed Standard for BASIC" are available from X3 Secretariat, CBEMA, 311 First St., NW, Suite 500, Washington, DC 20001.

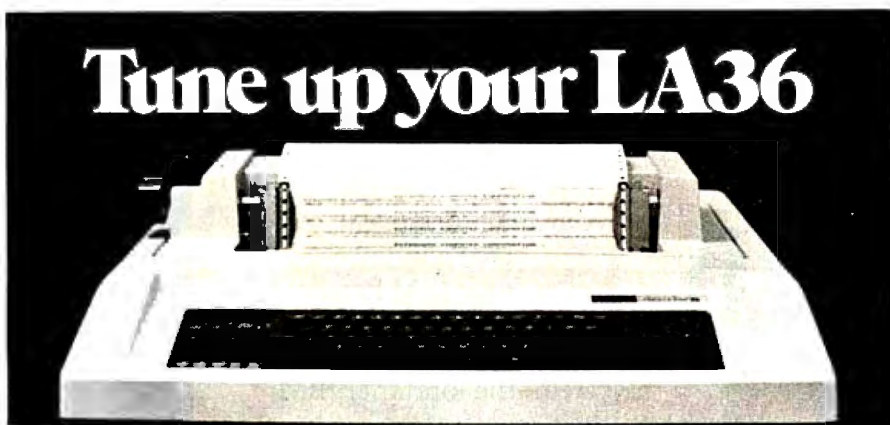

Tune up your LA36

The DS120 Terminal Controller makes your LA36 perform like a DECwriter® III.

The Datasouth DS120 gives your DECwriter® II the high speed printing and versatile performance features of the DECwriter® III at only a fraction of the cost. The DS120 is a plug compatible replacement for your LA36 logic board which can be installed in minutes. Standard features include:

- 165 cps bidirectional printing
- Horizontal & Vertical Tabs
- Page Length Selection
- 110-4800 baud operation
- 1000 character print buffer
- X-on, X-off protocol
- Self Test
- RS232 interface
- 20 mA Current Loop interface
- Top of Form
- Adjustable Margins
- Double wide characters
- Parity selection
- Optional APL character set

Over 5,000 DS120 units are now being used by customers ranging from the Fortune 500 to personal computing enthusiasts. In numerous installations, entire networks of terminals have been upgraded to take advantage of today's higher speed data communications services. LSI microprocessor electronics and strict quality control ensure dependable performance for years to come. When service is required, we will respond promptly and effectively. Best of all, we can deliver immediately through our nationwide network of distributors. Just give us a call for all the details.

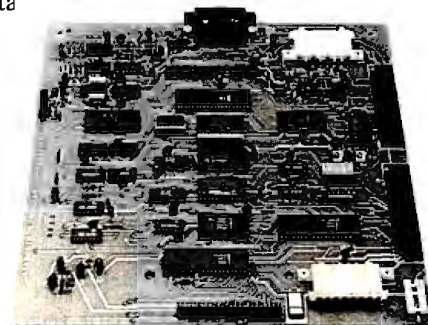

datasouth computer corporation

4216 Stuart Andrew Blvd. • Charlotte, North Carolina 28210 • 704/523-8500

How to make work like a

First, neatly cut out the "370" label.

Now, when nobody's looking, nonchalantly tape it to your terminal, just under the "IBM," as if it really belonged there.

Then wait for your chance and quickly slip a dBASE II™ disk into your main drive.

That's it.

Your IBM Personal Computer is now ready to run a relational database system, the kind that IBM put on their mainframes last year.

And you're ready with more data handling power than you would have dreamed possible before dBASE II.

You'll wonder how you managed without it.

You'll find that dBASE II, because it's a relational database management system (DBMS), starts where file handling programs leave off.

dBASE II handles multiple databases and simplifies everything from accounting to department staffing to monitoring rainfall on the Upper Volta.

With a word or two, you CREATE databases, APPEND new data instantly, UPDATE, MODIFY and REPLACE fields, records and entire databases. Organize months worth of data in minutes with the built-in REPORT. Do sub-field and multi-field searches, then DISPLAY some or all of the data for any condition you want to apply.

And you've just begun to tap the power of dBASE II.

Easy to look at, easy to use.

Input screens and output forms couldn't be easier—just "paint" your format on the CRT and what you see is what you'll get.



You can do automatic calculations on fields, records and databases, accurate to 10 digits.

And you can use dBASE II interactively for answers right now. Or save your instructions, then repeat **everything** with two words: DO Manhours, DO ProjectX, DO whatever has to be done.

Use dBASE II to help make your choice:

If you've got a 96k IBM PC, send us \$700 and we'll send you a copy of dBASE II to use free for 30 days.

e your micro mainframe.



Instead of just poring over a manual, run it and make sure that it does what you need done.

Then if you find it isn't right for you, send it back and we'll return your money, no questions asked.

But if you do that, you'll have to remove that label. Because nothing short of a mainframe works like dBASE II.

Call (213) 204-5570 today or drop by your local computer store for the rest of the story.

Ashton-Tate, 9929 Jefferson Blvd., Culver City, CA 90230.

Ashton-Tate

Circle 33 on Inquiry card.

©1982 Ashton-Tate

CP/M is a registered trademark of Digital Research

IBM, APPLE and ATARI USERS

CompuShack announces



SOFTWARE FOR YOUR IBM PC

Continental - The Home Accountant	\$99.95
Datamost - Write On / Word Processor	\$109.95
Denver Software -	
Easy Effective Accounting System	\$599.00
ISM	
Mathmagic	\$79.00
Graphmagic	\$79.00
Intocom	
Zork I	\$29.95
Zork II	\$29.95
Deadline	\$39.95

Information Unlimited	
Easy Filer	\$299.00
Easy Planner	\$159.00
Easy Speller	\$139.00
Easy Writer II	\$259.00
Micro Lab - Tax Manager	\$199.00
Micro Pro	
Wordstar	\$299.00
Mailmerge	\$99.00
Peachtree	
General Ledger	\$499.00
Accounts Receivable	\$499.00
Accounts Payable	\$499.00
Sir Tech - Galactic Attack	\$29.95
VisiCorp	
256K Visicalc	\$199.00
Visitrend/Visiplot	\$259.00
Visidex	\$199.00
Visifiles	\$259.00

SOFTWARE FOR YOUR ATARI 400/800 PERSONAL COMPUTER

Asteroids	\$27.95
Centipede	\$35.95
Pac-Man	\$35.95
Blackjack	\$15.95
Caverns of Mars	\$32.95
APEX CASSETTES	
Avalanche	\$19.95
Outlaw/Howitzer	\$19.95
747 Landing Simulator	\$19.95
Eastern Front	\$23.95
Dog Daze	\$19.95
Reversi II	\$19.95
Blockbuster	\$15.95
7-Card Stud	\$15.95
Downhill	\$19.95
Video Math Flash Cards	\$15.95
Letterman	\$19.95
Wordmaker	\$19.95
Cubbyholes	\$19.95
DISKETTES	
Data Management System	\$19.95
Family Cash Flow	\$19.95
Family Budget	\$19.95
Advanced Music System	\$25.95
Eastern Front	\$25.95
Supersort	\$19.95
Insomnia	\$19.95

SOFTWARE FOR YOUR APPLE II + ART-SCI INC.

Magic Window	\$79.00
Magic Mailer	\$49.00
Magic Words	\$49.00
Magic Pak — Includes All Three	\$157.00
Magic Window II	\$119.00
ASHTON-TATE	
Dbase II (Apple)	\$499.00
Dbase II (Apple 48K)	\$299.00

CONTINENTAL SOFTWARE

First Class Mail	\$59.95
CPA I General Ledger	\$199.00
CPA II Accounts Receivable	\$199.00
CPA III Accounts Payable	\$199.00
CPA IV Payroll	\$199.00
CPA V Property Management	\$399.00
The Home Accountant	\$59.95
The Home Accountant Plus	\$119.00

DAKIN 5 CORPORATION

Depreciation Planner	\$299.00
Budget Planner	\$119.00
Business Bookkeeping System	\$299.00

HAYDEN

Applesoft Compiler	\$159.00
--------------------------	----------

IMS

Graph Magic	\$69.95
Math Magic	\$69.95

LIGHTNING SOFTWARE

Master Type (Hi-Res)	\$29.95
----------------------------	---------

MICRO PRO

Word Star Customization Notes	\$299.00
Wordstar	\$199.00
Super Sort	\$129.00
Mall Merge	\$89.00
Data Star	\$199.00
Spell Star	\$129.00
Calc Star	\$129.00
Word Star Training Guide	\$19.95
Word Star Update	\$69.00

MICROSOFT

Time Manager	\$129.00
Fortran	\$159.00
A.L.D.S.	\$99.00
Basic Compiler	\$299.00
muMath/muSimp	\$185.00
COBOL	\$499.00
M/SORT	\$149.00
TASC	\$149.00
Multiplan (Native Apple)	\$199.00
Multiplan	\$199.00

SOFTWARE FOR YOUR APPLE II + ON-LINE SYSTEMS

Screen Writer II	\$99.00	SOFTWARE PUBLISHING COMPANY	
The General Manager	\$119.00	Personal Filing System	\$89.00
The Dictionary	\$79.00	Personal Report System	\$65.00
Speed-ASM	\$29.95	Graph	\$79.00
Expediter II	\$79.00	SORCIM CORPORATION	
Memory Management II	\$39.00	Supercalc	\$215.00
Lisa 2.5	\$59.00	STONEWARE	
Lisa Educational System	\$79.00	Stat Pac	\$69.00
PEACHTREE SOFTWARE		D B Master	\$145.00
General Ledger	\$299.00	D B Utility Pack	\$69.00
Accounts Receivable	\$299.00	D B Utility Pack II	\$69.00
Accounts Payable	\$299.00	Graphic Processing	
Inventory	\$299.00	System Standard	\$49.00
Payroll	\$299.00	Graphic Processing	
Peachcalc Electronic		System Professional	\$69.00
Spreadsheet	\$289.00	SYSTEMS PLUS	
Telecommunications	\$289.00	General Ledger	\$249.00
Spelling Proof Reader	\$250.00	GL/AR/AP	\$599.00
Mailing List Manager	\$289.00	GL/AP/AR/Inventory	\$699.00
Peachtext	\$350.00	VISI CORP	
SENSIBLE SOFTWARE		Visifiles	\$189.00
Back It Up	\$49.95	Desktop Plan	\$189.00
Disk Recovery	\$19.95	Visiplot	\$149.00
Disk Organizer II	\$19.95	Visidex	\$189.00
Multidiak Catalog	\$17.95	Visicalc 3.3	\$189.00
Super Disk Copy	\$25.95	Visischedulb	\$219.00
Sensible Speller	\$89.95	Business Forecasting	
Sensible Speller Supertext		Model	\$75.00
Format	\$89.95	Visilink	\$189.00

COMPU SHACK

Business Home Computers

2630-H Walnut Avenue, Tustin, CA 92680
(714) 730-7207 Telex 18-3511 Ans Bck ESMA

We Are The Systems Specialist

NAPLPS: A New Standard for Text and Graphics

Part 1: Introduction, History, and Structure

*A close look at an important and controversial
new communications standard.*

Personal computers have a great deal in common. Several of them use the same microprocessor. Most have the same language in read-only memory (BASIC). And all use more or less the same keyboard. But there is a tremendous variation in the ways various computers handle graphics.

In order to mass-produce graphics software or to mass-distribute graphics information (as in videotex and teletext), a standard for graphics information is needed.

The North American Presentation-Level-Protocol Syntax (NAPLPS, or "nap-lips") is a method for encoding visual information in a standard and compact manner, which can then be exchanged among people using a variety of different computer systems. Like the well-established American Standard Code for Information Interchange (ASCII), NAPLPS is a set of rules and conven-

About the Authors

Jim Fleming and William Frezza are members of the ANSI X3L2 Committee on Character Sets and Coding. Mr. Fleming is also working on Chemical Bank's Pronto home-banking project.

Jim Fleming
Unir Corporation
Suite 106
5987 East 71st St.
Indianapolis, IN 46220

William Frezza
Jerrold Division
General Instrument Corporation
2200 Byberry Rd.
Hatboro, PA 19040

tions describing how data bytes of information should be formatted, as well as a set of guidelines describing what should be displayed when properly formatted data bytes are received by a terminal.

Unlike ASCII, however, the major emphasis in NAPLPS is on the communication of information in a two-dimensional graphics format. Graphics and textual information can be represented in a variety of modes, colors, and styles. Facilities are also provided that allow a terminal user to interact with the two-dimensional visual display in an extremely free-form manner.

NAPLPS also includes a method for minimizing the amount of infor-

mation that must be sent over communications lines. Techniques are provided that allow extensions to be added to NAPLPS at some future time without affecting existing features.

The basic concept of NAPLPS can be illustrated by the cartoon in figure 1 on page 204. It shows a robot artist being fed a stream of commands that are used to paint a picture. At the robot's disposal are pens of various colors, spray paints, character templates, and all the other items found in an art studio.

With various commands, we can direct the robot's arm to any area of the canvas we desire. We can instruct the robot to use any of several standard colors, or we can tell it to create a new color from the existing ones. When text is needed, the robot selects the proper-size template for the desired letters, grabs a can of spray paint, places the template on the canvas, and paints a character.

The goal of this system is that the beauty and complexity of a picture should be limited only by the imagination and skillfulness of the person (or program) creating the commands being fed to the robot.

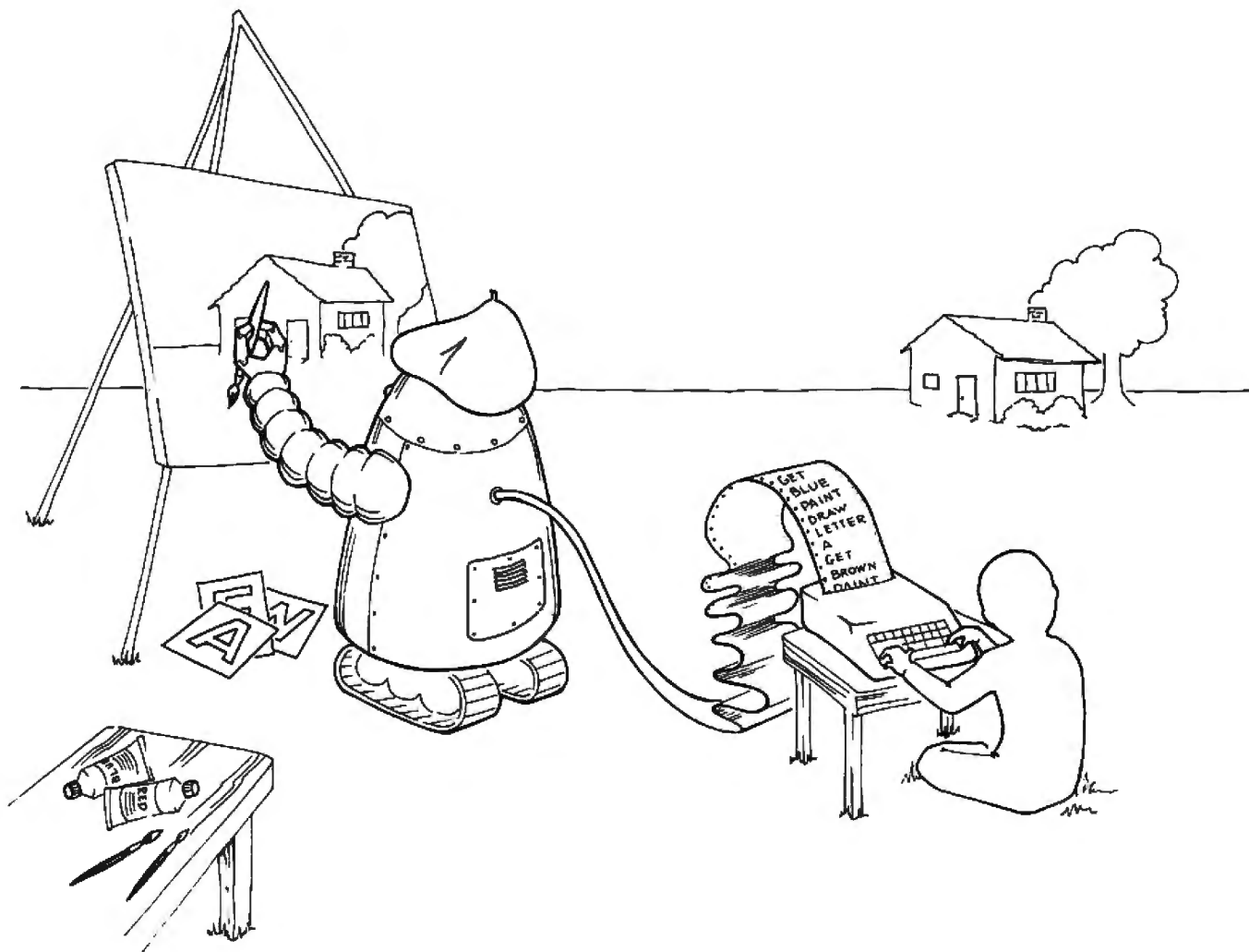

Figure 1: A stylized representation of how the NAPLPS system works. The programmer or artist creates a list of graphics commands, e.g., "get red pen," "draw a circle." The robot (or NAPLPS decoder) then interprets these commands and uses various drawing instruments such as pens, brushes, rulers, and compasses to draw on the canvas (display screen). If a text character is specified, the robot uses an appropriate template for that character.

This article is the first in a series of articles on NAPLPS. In this part, we give an overall perspective of NAPLPS, describing its history and background, as well as its structure and major features. In subsequent parts, we will cover the basic text and graphics features of NAPLPS from a bit and byte perspective, describe some of its more advanced features, and explore the future of NAPLPS with an emphasis on personal computers, local and regional area networks, and distributed processing.

History and Background

NAPLPS has its roots in videotex, a much-discussed system of large host computers and low-cost, user-friendly graphics terminals. Because of the large potential market for these

terminals, many groups around the world have been designing such systems for use in homes, offices, and public areas. As shown in figure 2 on page 206, a basic videotex system consists of a host computer with a database of information, a communication network, and a terminal. The terminal users request information from the database, and the desired information is sent back to the terminal, where it is interpreted and displayed.

Unfortunately, all the experimental systems designed around the world used different coding schemes. As is the case with most languages, the various coding schemes had different strengths and weaknesses. Some were more efficient than others; some were more easily decoded by terminals;

some preserved the "conceptual" content of the information; and some were tailored to particular hardware configurations.

At the time NAPLPS was developed, videotex coding schemes could be divided into two major groups. In one group were schemes that were similar to the approach used in the British Prestel system, which was the first videotex effort in the world. The other group of schemes is best represented by the Telidon system developed in Canada as an alternative to the Prestel system. As is the case with many developments in the computer field, being first does not imply being the best.

Table 1 on page 210 compares Prestel-like systems and Telidon-like systems. Without going into all the

Our Prices Will Get Your Attention. Our Service Will Keep It.

ORDER NO. DESCRIPTION LIST AEI PRICE ORDER NO. DESCRIPTION LIST AEI PRICE ORDER NO. DESCRIPTION LIST AEI PRICE

TELEVIDEO SYSTEMS

TS-802	Integrated Single User Computer	3295	2632
TS-802H	Integrated Hard Disk Computer	5995	Call
TS-1602G	16 Bit 802 Type Computer	4495	Call
TS-1602GH	16 Bit 802H Type Computer	6995	Call
TS-806-20	Multi-User Computer	7195	Call
TS-816	Multi User Computer	8995	Call
TV-910-P	Televideo 910 Plus	699	573
TV-910	Televideo 910	699	573
TV-912	Televideo 912C	925	685
TV-920	Televideo 920C	995	737
TV-925	Televideo 925	995	745
TV-950	Televideo 950	1195	921
TV-9010	Second Page Option 912/920	80	50
TV-9050	One Additional Page for 925/950	95	62
TV-9051	Three Additional Pages for 950	120	95
TV-MM	For Any Televideo Terminal	60	53
TS-24-001	TeleSolutions WordStar + CalcStar	790	Call
TS-100	WordStar	495	280
TS-150	SpellStar	250	154
TS-200	MailMerge	250	154
TS-300	DataStar	295	238
TS-400*	Supersort	250	164
TS-1000	CalcStar	145	128
TS-806H/20	20 MB Expansion for TS-806	3600	2948
TS-TW	Teletwriter - NEC 3500	2195	1629

SOFTWARE

NEC PRINTERS

NE-3510-1	NEC 3510 Spinwriter R/O Serial 35 CPS	1895	1500
NE-3515-1	NEC 3515 Spinwriter R/O Serial Diablo Compatible	1925	1594
NE-3530-1	NEC 3530 Spinwriter	2190	1764
NE-3550-1	NEC 3550 Spinwriter R/O Parallel IBM Compatible	2350	2065
NE-35-TRAC	Bi-directional Tractor	265	237
NE-7710-1	NEC 7710 Spinwriter R/O Serial 55 CPS	3085	2523
NE-7715-1	NEC 7715 Spinwriter R/O Serial Diablo Comp.	3165	2600
NE-7720-1	NEC 7720 Spinwriter KSR Serial 55 CPS	3610	2917
NE-7725-1	NEC 7725 Spinwriter KSR Serial Diablo Comp.	3710	3041
NE-7730-1	NEC 7730 Spinwriter	3085	2546
NE-PC-8023	Parallel	695	506

STAR MICRONICS

DP-8480-TP	80 Column Dot Matrix Printer - Parallel	449	Call
DP-8480-TS	80 Column Dot Matrix Printer - Serial	464	Call
Gemini-10	10" Carriage - Parallel	499	Call
Gemini-15	15" Carriage - Parallel	649	Call
DP-8240	Serial Interface Card	85	Call
	40 Column Dot Matrix - Parallel or Serial	250	Call

OKIDATA

OK-82A	Okidata Microline 82A with Tractor Feed	719	486
OK-83A	Okidata Microline 83A ..	1195	713
OK-84A-P	Okidata Microline 84A - Parallel	1395	Call
OK-84A-S	Okidata Microline 84A - Serial	1495	Call
OK-G-82	Okigraph I for 82A	99	36
OK-G-83	Okigraph I for 83A	99	36
OK-2K	2K Buffer/Serial BD all Models	140	119

MANNESMANN TALLY

MT1605	Serial 200 CPS	1695	1441
MT1602	Parallel 200 CPS	1695	1441
MT1805	Serial - 200 CPS or 50 CPS	1995	Call
MT1802	Parallel - 200 CPS or 50 CPS	1995	Call
MT1602	S or P - 160 CPS	990	809

PLUS: ANADEX · C-ITOH · DATA SOUTH · TI · DIABLO · COMREX

ALSO AVAILABLE:

MODEMS · DISKETTE STORAGE BOXES · DISKETTES · CLIPSTRIP · RIBBONS

SOFTWARE AVAILABLE

Altos CP/M 5 1/4"	
Apple CP/M 5 1/4"	
Apple DOS - Cassette	
Apple DOS - Diskette	
Atari 400/800 Diskette	
Atari Cartridge	
Atari Cassette	
Basic 4 CP/M 5 1/4"	
CP/M-86 Display Writer	
Cramemco CP/M 5 1/4"	
DEC VT-180 CP/M 5 1/4"	
Eagle CP/M 5 1/4"	
Heath Zenith CP/M 5 1/4"	
Heath Zenith CP/M 5 1/4"	
Hewlett Packard 125 CP/M 5 1/4"	
Hewlett Packard 87 CP/M 5 1/4"	
IBM P.C. CP/M 86	
IBM P.C. DOS	
NEC CP/M 5 1/4"	
Northstar Advantage CP/M 5 1/4"	
Northstar Horizon CP/M 5 1/4"	
Ohio Scientific C-3 CP/M 5 1/4"	
Osborne CP/M 5 1/4"	
Otrona CP/M 5 1/4"	
QD-Micropolis Mod II/Vector Graphic	
Sanyo 1000 CP/M 5 1/4"	
Sirius Victor 5 1/4"	
Software for 8086 Computers	
Standard CP/M 5 1/4"	
Superbrain 5 1/4"	
Timex/Sinclair ZX81	
TRS-80 Cassette Models I & III	
TRS-80 Diskette Models I & III	
TRS-80 Model II CP/M	
Televideo CP/M 5 1/4"	
Vic 20	
Wang CP/M 5 1/4", 8"	
Xerox 820 CP/M 5 1/4"	

CALL FOR CURRENT PRICING

NORTHSTAR

NS-94404	Adv-2Q-64K Computer ..	3599	Call
NS-97404	Adv-1Q-64K-HD-5 Computer	4999	Call
NS-94401	Hz-2Q-64K Horizon	3599	Call
NS-97401	Hz-1Q-64K-HD-5MB	4999	Call

PLUS OTHER NORTHSTAR PRODUCTS

ZENTH

ZVM-121	Green Screen Monitor ..	160	99
Z-19-CN	Z-19 Terminal	895	672
ZT-1-A	Auto-Dial Terminal	699	526
Z-25-AA	Z-25 Dot Matrix Printer ..	1499	1198
Z-89-81	Z-89 Computer System ..	2499	1952
Z-90-82	Z-90 Computer System ..	2799	2176
Z-89-X	Z-89 w/o Integral Drive ..	2495	1749
Z-90-80	Z-90 w/o Integral Drive ..	2895	1950
Z-37	Z-37 Dual 5" Disk Drives ..	1995	1593
Z-87-89	Z-87 Dual 5" Disk Drives ..	999	898
Z-87-90	Same Disk add 400K to Z-90	999	898
ZS-67	Z-67 Winchester - Floppy Drive	5995	4747
Z-47-DA	Z-47 Dual 8" Disk Drives ..	3695	Call

PLUS: MORROW · ALTOS · NEC PERSONAL · EAGLE

FEBRUARY SPECIALS



FEBRUARY LIST AEI PRICE

- Z-90-80 Plus Z-37
- CPU - Drives
- CP/M DOS
- MBasic
- SuperCalc

Z-90-82 Computer 64K RAM, 160K Drive · CP/M DOS

• MBasic · SuperCalc

Limited Quantity of MX80 Cassette Ribbons, Special Price, Limit 3 per customer. While supply lasts. \$14 \$7

GUARANTEE

- PROVEN PRODUCTS
- SYSTEM DESIGN HELP
- BENCH TESTING AND CONFIGURING
- TECHNICAL SUPPORT STAFF
- SERVICE AFTER SALE:

(800) 854-7635 TECHNICAL SERVICE SUPPORT
We will pay the freight — both ways — for repair on verified returns within 30 days of sale.

TERMS AND CONDITIONS

Prices change daily. Call for current pricing and availability. Prices based on prepaid cash orders. We accept: cashiers checks, money orders, bank wires, or personal checks (10 days to clear). C.O.D. — standard charges plus 2% handling for orders outside California. Mastercharge & Visa — 5% handling. California residents add 6% sales tax.



Prices change daily — call for current pricing.

CALL TOLL FREE:

800-854-7635

IN CALIFORNIA CALL:

(619) 562-7571

AUTOMATED EQUIPMENT, INC.

8775 Olive Lane, Suites I & J · Santee, CA 92071

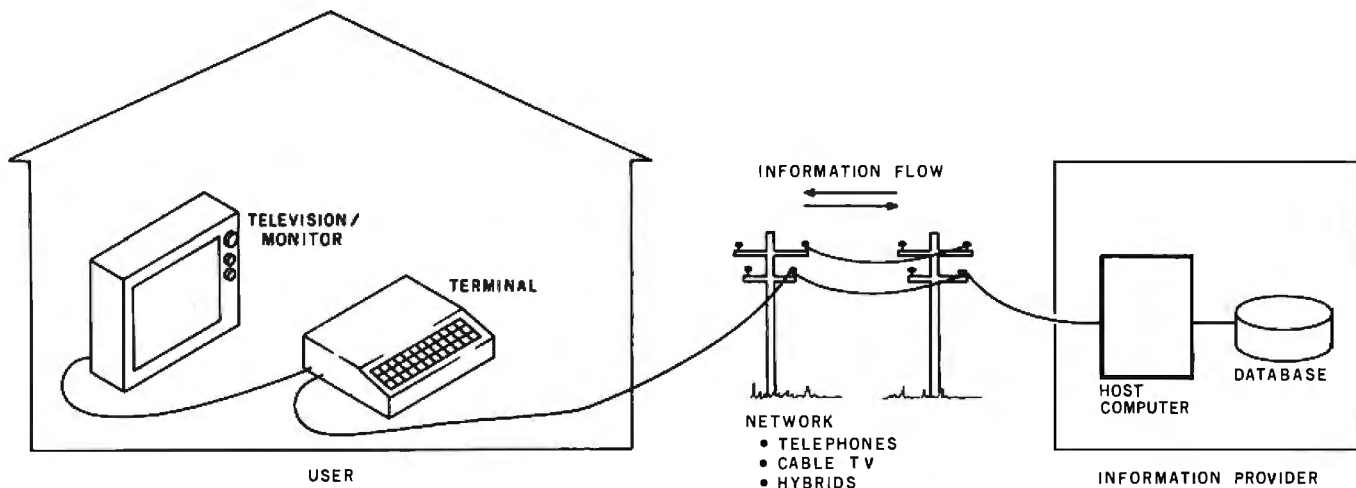

Figure 2: A diagram of a typical videotex system. Videotex is defined here as two-way communication of textual and graphical information between a low-cost, user-friendly terminal and a large, central host computer. Communication can be by telephone lines, television cables, or a hybrid system using a broadcast television channel for information sent from the host computer and using telephone lines for information sent from the terminal.

technical, emotional, and political history, suffice it to say that NAPLPS was designed using Telidon-like systems as a base.

In May 1981, AT&T created a bit of commotion by releasing documentation for a new Telidon-like scheme called PLP (Presentation-Level Protocol) at the Videotex '81 conference in Toronto. Since that time, continuous efforts have been underway in various standards groups to adopt PLP.

NAPLPS is a standard version of PLP that resulted from a joint effort

by the American National Standards Institute (ANSI) and the Canadian Standards Association (CSA). Copies of the draft proposed NAPLPS standard (document #BSRX3.110-198X) can be obtained from CBEMA (Computer and Business Equipment Manufacturers Association, X3 Secretariat, Suite 500, 311 First St., NW, Washington, DC 20001).

This series of articles will provide an overview of the features of NAPLPS. The specific details and examples presented in these articles are not meant to form a complete

NAPLPS specification. Anyone interested in doing development work using NAPLPS should obtain a copy of the ANSI document.

Layered Protocols

Modern communication systems are designed in a *layered* or *modular* manner to help prevent extensive system redesign when parts of a system are changed. Layering achieves many of the advantages found in good structured system design. By isolating functions in various layers, we can proceed to standardize and imple-

Text continued on page 210

MACRO-80c DISK BASED EDITOR/ASSEMBLER

This is a powerful macro assembler, screen oriented editor and machine language monitor. It features local labels, conditional assembly, printer formatting and cross reference listings. Assemble multiple files. Program comes on Radio Shack compatible disk with extensive documentation. Price: \$99.95

MICROTEXT COMMUNICATIONS

Make your computer an intelligent printing terminal with off-line storage! Use Microtext for timesharing interactions, printing what is received as it is received and saving text to cassette, and more! Price: \$59.95

PI80C PARALLEL PRINTER INTERFACE

Use a parallel printer with your Color Computer! Serial-Parallel converter plugs into the serial port and allows use of Centronics-compatible printers. You supply the printer cable. Price: \$69.95

THE MICRO WORKS COLOR FORTH

Color Forth is easier to learn than assembly language, executes in less time than Basic and is faster to program in than Basic. Rompack comes with 112-page manual containing glossary of system-specific words, full standard FIG glossary and complete source. A fascinating language designed for the Color Computer! Price: \$109.95

SDS-80C SOFTWARE DEVELOPMENT SYSTEM

SDS-80C is a Rompack containing a complete editor, assembler and monitor. It allows the user to write, assemble and debug assembly language programs with no reloading, object patching or other hassles. Supports full 6809 instruction set Price: \$89.95

80C DISASSEMBLER

Runs on the Color Computer and generates your own source listing of the Basic interpreter ROM. Documentation includes useful ROM entry points, complete memory map, I/O hardware details and more. Cassette requires 16K system Price: \$49.95

GAMES: Star Blaster ★ Pac Attack ★ Berserk ★ Cave Hunter ★ Starfire ★ Astro Blast ★ Starship Chameleon ★
Adventure: Black Sanctum ★ Adventure: Calixto Island ★

THE MICRO WORKS

Also Available: Machine Language Monitor Books Memory Upgrade Kits
Parts and Services Call or write for more information

California Residents add 6% Tax
**Master Charge/Visa and
COD Accepted**

P.O. BOX 1110 DEL MAR, CA 92014 619-942-2400

INTRODUCING WORK SPACE



The new TEAC half height disk drive gives you everything you expect from a top quality disk drive, and one more thing, space. Now you can have up to 3.2 megabytes of floppy storage for the IBM PC without adding an expansion cabinet. Choose four 40 track double sided drives and get 1.2 Mb. Or four 80's for 3.2 Mb. Mix two 40's and two 80's for 2.2 Mb. The TEAC drives operate under PC DOS 1.1 (80 track drives come with JFORMAT, providing electronic disk, print spooling and ten sector formats). Now you can have both increased storage and space. The TEAC double sided 40 track and 80 track drives are priced at just \$299 and \$365 respectively.

Save on our line of other IBM compatible products.

DRIVES

- Single and Double sided 40 track drives. Fully supported by PC DOS version 1.1. Drives are easily installed in minutes. Tandon single sided (160K) — \$225, Double sided (320K) — \$299.
- Double sided 80 track (650K) Tandon drive. Available with JFORMAT for PC DOS 1.1 — \$435.
- 5 megabyte Winchester internal or external disk drive — \$1695.

BOARDS

- RAM Card — uses 64K dynamic RAM chips, with parity. 64K card — \$149, additional 64K increments (expandable up to 256K) available for \$79.
- Combo Card. Adds parallel printer, RS 232 async comm and clock calendar

functions. Uses only one slot — \$199. RS 232 Cable — \$24.95. Parallel Printer Cable — \$29.95.

- Clock Calendar Card. Features seconds, minutes, hours, day of week, date, month and year. Battery backup maintains time and date even when system is turned off — \$99.
- Prom Blaster. Programs most 4K to 64K bit 24 PIN EPROMs. Complete with personality modules and read/write software — \$129.
- Prototype Card. 3.5 by 8 inch wire-wrap area holds over 85-14 pin dips — \$29.95.
- 48K Additional Ram. 27 chips plug easily into master PC board — \$75.

HARDWARE

- 64K Byte Hardware Print Spoolers. Internal spooler comes with parallel printer adapter. External version connects easily between computer and printer. Both buffer 32 pages of print output and are user programmable — \$319.

SOFTWARE

- Home Finance. Easy to use checkbook

& budget manager — \$34.95.

- Apparat Game Diskette. Includes blackjack, othello, matches and spiralgraph — \$24.95.

MONITORS

- Your choice of high quality and reliable Amdek 12" green or amber screens. Choose the V300 G/A for the color graphics card priced at just \$170, or the V310 G for the monochrome card at just \$199. Both monitors are 18 Mhz BW and are anti-glare.
- Princeton graphics HX-12 RGB color monitor \$695. Other Amdek and NEC monitors also available at big savings. Call for prices.

PRINTERS

- A variety of the newest Epson, C. Itoh, Okidata and NEC printers available. Call for prices.

To order any of the above products, write Apparat, Inc., 4401 S. Tamarac Parkway, Denver, Colorado 80257, 303/741-1778. Or to speed up your order, call us toll free at

800/525-7674. 





TM

DISC-LESS

S.D. Systems is proud to introduce DISC-LESS™ systems. Eliminate your system's dependence on disc-drives . . .

- REPLACES FLOPPY-DISC DRIVES
- TRANSPARENT TO OPERATING SYSTEM DISC COMMANDS
- NO MOVING PARTS, NO ALIGNMENT, NO MEDIA TO FAIL
- NETWORK READY
- * CP-M™, MP-M™, OASIS™ COMPATIBLE
- FAST!!!!!!!!!!!!!!!!!!!!!!!!!!!!!!

*Experience DISC-LESS™
The pleasure is all ours.*

A SYNTech COMPANY

S. D. SYSTEMS, INC
10111 MILLER ROAD
DALLAS, TEXAS 75238

(714) 340-0303
TELEX-6829016



*CP-M, MP-M are registered trade marks of Digital Research. Oasis is registered trade mark of Phase One.

Circle 392 on inquiry card.

S-100 Boards from S. C. Digital

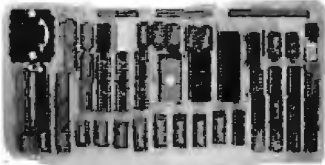

FLOPPY DISK CONTROLLER

features: **Model FDC1**
 ● Single or Double density, sides, in any combination of up to four 8" or 5.25" drives. ● Digital phase locked loop. ● DMA data transfer with cross 64K boundaries, 24B address, DMA arbitration. ● Monitor/boot EPROM accommodating two different processors. ● CPM Bios programs. ● Serial port to 19.2K baud.

Z80B CPU BOARD

features: **Model Z80 CPU**
 ● 2, 4 or 6 mhz clock. ● 22 bit Address by Memory Mapping in 16K blocks. ● 2 or 4Kbyte EPROM (not supplied) with Phantom generation. ● Jump on Reset. ● Provision to run two different CPU's on the same bus, such as forth coming 8086.

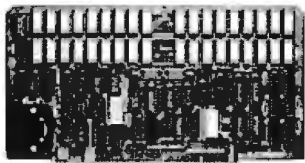

NEW 256K DYNAMIC RAM

features: **Model 256KZ**
 ● 8/16B Data, 24B Address. ● Parity bit per Byte ● Transparent refresh ● Unlimited DMA ● 180nsec. Access time ● Will run 8086, 8088, 68000 to 8mhz, Z80, Z8000 to 6mhz without wait states.



NEW 64K STATIC RAM

features: **Model 64KS**
 ● 8/16B Data 24B Address ● Disable in 2K increments ● 180nsec Access Time (with 64KB) from address on, runs 8086, 68000 to 10mhz, Z80, Z8000 to 8mhz without wait states ● Battery back up capable.

32K STATIC RAM 'Uniselect: 4'

features: **Model 32KUSM**
 ● 8/16 bit data, 16/24 bit address. ● Bank Select by SW selectable port, bit in 32K block. ● Battery backup (battery not supplied) with power-fail detect/automatic Ram disable. ● Complete EPROM (2716) capability with wait states (up to 3), phantom responding or generating.

All boards conform to IEEE696/S100 specifications, fully socketed, screened legends, masks, Gold contacts. Guaranteed One Full Year.

New Price Effective February 1, 1983

Model	Prices	with
FDC1	\$425	Monitor EPROM
Z80 CPU	\$349	Memory Mapping, 6mhz clock
256KZ	\$795	256KB, Parity
64KS	\$425	64KB, CMOS
32KUSM	\$325	32KB, CMOS
32KUSM-N	\$189	no ram, no power fail
3SPC	\$259	3 serial, 1 parallel, cassette
Z80 monitor	\$65	2K in EPROM, source code

All Boards come assembled and tested.
 Call for current and package deal prices.

Delivery is within 3 to 5 working days. MC, Visa or CDD orders accepted. (Add \$6 for CDD orders) Illinois residents add 5 1/4% sales tax.

O.E.M. & DEALER PRICING AVAILABLE

S. C. DIGITAL

P.O. Box 906

1240 N. Highland Ave., Suite #4

Aurora, Illinois 60507

Phone: (312) 897-7749

Characteristic	Prestel-like Systems	Telidon-like Systems	Comment
Video-display hardware dependence	Very much	Very little	This is the main advantage of NAPLPS. It is not based on special circuits or architectures.
Image complexity	Poor	Excellent	There is no comparison. It would be like trying to compare 8-mm home movies to 35-mm theater films.
Easily decoded by terminals	Yes	No	Prestel wins this one. Unfortunately, most things in life that are easy are not worth much.
Requires microprocessor terminal	No	Yes	Many thought this was an advantage and an objective worth achieving. Maybe they don't know how to program microprocessors.
Works with printers, plotters, etc.	No	Yes	While some were asking "Why?," others were saying "Why not?"
Memory intensive	No	Yes	Prestel wins again. Now that 16K bits are cheaper than 4K, this hardly seems a victory.
Preserves "conceptual" content information	No	Yes	Most are still trying to figure out what this means and why it is useful.
Can be extended for years	No	Yes	This certainly can be disputed. Time will be the judge.
Sensitive to errors in the communication channel	Less	More	A valid point but hardly an issue for a level-6 protocol.
Cost	Low	????	The true bottom line in some people's books. But how much did a personal computer cost 10 years ago?

Table 1: A comparison of two types of graphics encoding systems for use in videotex applications: Prestel-like systems and Telidon-like systems. NAPLPS is one of the latter.

ment a system for one layer without regard to details of other layers. Because layering is an abstract and sometimes confusing topic, we will use a simple example of communication between two people to illustrate the concept.

As shown in figure 3 on page 212, when two people converse, their basic goal is to communicate ideas to each other with as much understanding as possible. We shall regard these ideas themselves as the first level or layer of communication. This level, which may be considered the highest

or most abstract, will be called the *conceptual* level.

In order for people to communicate these ideas, they must choose a language—say, English—as a set of rules for *presenting* the ideas. And with English come all the rules concerning grammar, sentence structure, and so on. We shall include English as part of a second level of communication that we shall call the *logical* level. The ideas from the upper level would have to be expressed in this logical level before a transfer could take place between the two people.

Okidata **MICROLINE 92**

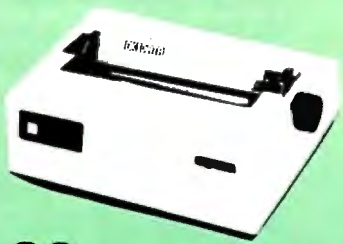

\$929.88 UPS DELIVERED

- 160 characters per second, bi-directional, logic-seeking printhead action with 80 & 40 cps hi-res correspondence print modes
- 9 x 9 matrix produces correspondence, 10, & 17 cpi with true descenders; double width & download option for character sets standard
- Subscripts, superscripts, underlining, backspace, & forms control
- Friction & pin feed paper handling takes up to 3-part forms (8.5")
- Centronics parallel or RS-232C interfacing (specify)

Microline 93 (136 columns).....\$929.88

The Franklin **ACE 1000**

An Apple-compatible Personal Computer



FRANKLIN
COMPUTER CORPORATION



The Franklin **ACE 1000** includes 64K RAM, upper/lower case character set (40 columns), hi-res graphics, numeric keypad, 8 peripheral slots, joystick/paddle connectors, and a built-in cooling fan. The Franklin **ACE 1000** has full hardware/software compatibility with all existing Apple II® products.

Our special package price includes The Franklin **ACE 1000**, one **ACE 10** disk drive with a drive controller card, the **PI-4-9"** Amber Monitor, and **ACEWRITER**, a \$100 word processing program.

All for only **\$1529.64**, UPS delivered.

PRINTERS

Anadex
Anadex DP-9501A **\$1499.88**
Anadex DP-9620A **\$1499.88**

C. Itoh
C. Itoh Prowriter **\$499.88**
w/RS-232C **\$609.88**
C. Itoh Prowriter 2 **\$734.88**
w/RS-232C **\$789.88**
C. Itoh F-10 Starwriter 40 cps
Parallel or RS-232C **\$1499.88**
C. Itoh F-10 Printmaster, 55 cps
Parallel or RS-232C **\$1799.88**
F-10 Tractor **\$289.88**

Daisywriter
Daisywriter 2000 **\$1089.88**
Daisywriter Tractor **\$149.88**
Daisywriter Cable **\$49.88**

Diablo
Diablo 620 **\$1289.88**
Diablo 630 **\$1989.88**
Diablo 630 KSR **\$2894.88**

TEC



DMP-85 Printer **\$489.88**

Star Micronics



Gemini 10 **\$419.88**

IDS
IDS Prism 80 **\$1104.88**
above w/graphics **\$1189.88**
above w/sheetfeed **\$1294.88**
above w/4-color **\$1839.88**
IDS Prism 132 **\$1289.88**
above w/graphics **\$1339.88**

PRINTERS

IDS Prism (cont)
132 w/sheetfeed **\$1459.88**
above w/4-color **\$1899.88**
IDS Microprism **\$879.88**

Okidata
Microline 82A **\$429.88**
82A Plug-n-Play (PC) **\$39.88**
80/82A Tractor **\$59.88**
82A Roll Paper Holder **\$49.88**
Microline 83A **\$889.88**
82A/83A Okigraph ROM **\$44.88**
Microline 84 w/graphics & tractor
Parallel, 200 cps **\$1039.88**
RS-232C, 200 cps **\$1149.88**

NEC
NEC 3510 **\$1929.88**
NEC 3530 **\$1809.88**
NEC 3550 **\$2199.88**
3500 Tractor **\$239.88**



NEC PC-8023A **\$509.88**

Qume
Qume Sprint 9/45 **\$2109.88**

Smith-Corona
Smith Corona TP-1 **\$599.88**
Specify either 10 or 12 cpi,
& parallel or RS-232C interface

CALL FOR PRICES on Cannon, Centronics, Datasouth, Epson, Mammesmann Tally, Panasonic, Ricoh, Silver Reed, & others

MONITORS



USI Pi-3 (12" amber) **\$189.88**
USI Pi-4 (9" amber) **\$159.88**

Amdek
Amdek 310G (12" green) **\$199.88**
Amdek 310A (12" amber) **\$199.88**
Amdek Color I (Hi-res RGB) **\$789.88**
Amdek Color III (RGB) **\$479.88**

Electrohome
Electrohome 1 (RGB) **\$329.88**
Electrohome 2 (Hi-res RGB) **\$579.88**
PC Cable **\$49.88**

NEC
JB 1203 (RGB) **\$759.88**
JB 1210 (Comp.) **\$364.88**

MODEMS

DC Hayes
Hayes 300 Baud **\$234.88**
Hayes 1200 Baud **\$589.88**
Hayes Micromodem II
above, w/software **\$319.88**

Novation
Novation 103 SmartCat **\$224.88**
Novation 103/212 SmartCat **\$509.88**
Novation Apple Cat 300 **\$334.88**
Novation 300-1200 Kit **\$324.88**
Novation Apple Cat 1200 **\$579.88**
Novation Cat **\$159.88**
Novation D-Cat **\$189.88**
Novation J-Cat **\$139.88**
Multi-Line Junction Box **\$39.88**

APPLE HARDWARE

PKASO Smart Interfaces
For Apple/Franklin centronics parallel output. Specify C.Itoh, Centronics, Epson, IDS, NEC or Okidata printers. PKASO card & cable **\$139.88**
"IDS Color card & cable **\$189.88**

Parallel Card w/cable **\$89.88**

Corona Data Systems
5mB Hard Disk **\$2049.88**
10mB Hard Disk **\$2459.88**

MicroSoft
Premium Package—A 16K RAMCard, Z80 SoftCard, VideX VideoTerm w/soft video switch, & CP/M Users Guide **\$499.88**
Z80 SoftCard **\$239.88**
16K RAMCard **\$189.88**

Mountain Computer
5mB Hard Disk **\$2364.88**
10mB Hard Disk **\$2829.88**
Card Reader **\$1359.88**
CPS MultiFunction **\$189.88**
A/D—D/A Converter **\$304.88**
RAMplus + 16K **\$159.88**
RAMplus + 32K **\$179.88**
ROMplus + **\$139.88**
ROMwriter Card **\$154.88**
SuperTaker **\$174.88**

Orange Micro
Grappier + **\$149.88**

Practical Peripherals
16K Microbuffer II **\$219.88**
32K Microbuffer II **\$249.88**

Rena Systems
Elite 1 Disk Drive **\$289.88**
Elite 2 Disk Drive **\$509.88**
Elite 3 Disk Drive **\$889.88**
Disk Controller **\$109.88**

Saturn Systems
32K RAM Board **\$199.88**
64K RAM Board **\$344.88**
128K RAM Board **\$484.88**

SSM
AIO Multi-Function Card **\$199.88**

Videx
VideoTerm **\$239.88**
VideoTerm Combo **\$289.88**
Enhancer II **\$114.88**

Vista
A-800 Disk Controller
for 8" disks **\$399.88**
Vision 80 Card **\$289.88**

Information & Orders
(603)-881-9855

Orders Only: (800)-343-0726

No Hidden Charges

FREE UPS shipping on all orders—No extra charge to use credit cards—All equipment shipped factory fresh with manufacturer's warranty—COD orders accepted (\$10 fee added)—No purchase orders accepted—No foreign or APO orders accepted—Minimum \$50 per order—This ad prepared in December; prices are subject to change.

HIGH TECHNOLOGY AT AFFORDABLE PRICES



THE BOTTOM LINE

MILFORD NH 03055-0423



LAYERED PROTOCOLS

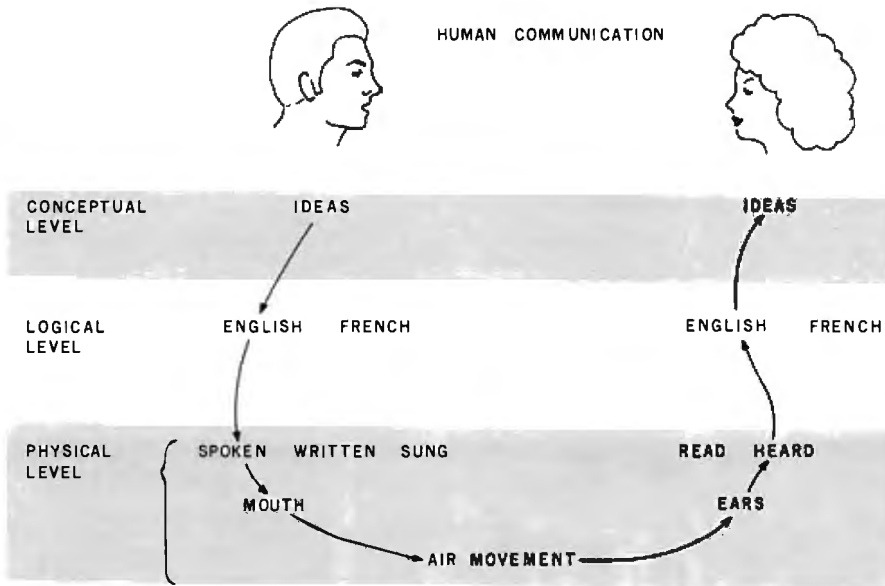

Figure 3: A diagram showing how communication can be divided into a series of layered protocols. Here, the example of communication is a simple conversation in English between two people. The conceptual level comprises the actual ideas to be communicated. The logical level comprises the language in which the ideas are to be expressed. The physical level comprises the physical phenomena that are used to convey the English words. In the case of speech, this involves movements of the mouth, air, and the listener's eardrums.

LAYERED PROTOCOLS

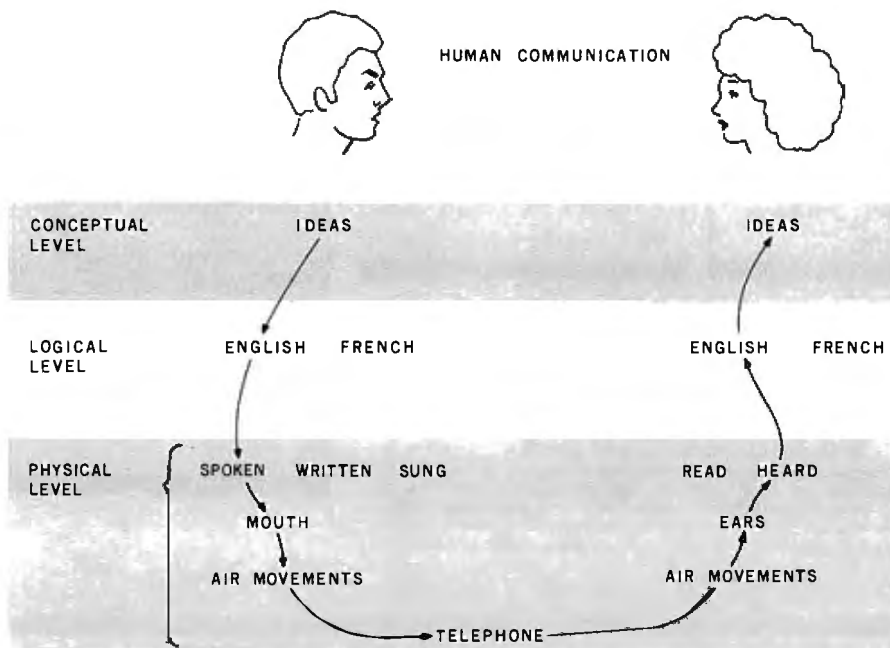

Figure 4: If the conversation in figure 3 were conducted over a telephone, we could interpret this as a change of the physical layer. The advantage of layered protocols is that one layer can be changed without affecting the other layers. Although the physical level here has been changed, the logical level—English—is unaffected.

Once English is chosen, a mechanism is needed to physically transfer the logical representations of the conceptual ideas from one person to another. This will be done on the *physical* level. In human communication, several choices exist. The most obvious is speech. When we speak, a set of physical tools is used. The English constructs from the logical level are converted to movements of the diaphragm, tongue, and mouth, which result in the movement of air. The vibrating air is detected by the other person's ears (if she is listening) and is transferred into bone and muscle movements. The second person must decode these movements, re-create the English, and conceptualize the idea.

This example can also be used to illustrate why layering is useful in preventing complete system redesign when changes are made. It can even be used to show how standard layers can be mixed and matched as the needs of a system change.

Suppose that the two people are separated by a large distance and that a telephone must be used so that they can talk to one another. The lowest level (the physical level) is the only area affected. As shown in figure 4, the telephone and the telephone network are used to transport the sounds from one location to another. The logical English constructs can remain the same and the ideas can be communicated.

If French or German is substituted at the logic level, no changes need to be made to the physical level. The conceptual level may or may not be affected, depending on how adept the languages are in representing certain ideas. For example, when learning a second language, one usually runs into the case where an instructor says, "That idea really can't be translated into this language."

As mentioned before, layering is done to prevent expensive system redesign when parts of a complex communication system are changed. Imagine how inconvenient it would have been if everyone had had to learn a new language when the telephone was invented. Or imagine how expensive it would be if a dif-



GREAT NEWS FOR EVERYONE WITH A PERSONAL COMPUTER! A NEW BREED OF PRINTER, PURRRFECTLY PRICED.

160 CPS Advanced, Multifunction Printing For Under \$700.

When advertising, TV and film people need a puma to pose or a lion on location, they call the Dawn Animal Agency. Daily, Dawn sends their exotic animals from coast to coast. And they generate a jungle of data in the process. Like so many growing businesses, they need to mate a personal computer to a printer that will keep pace with business demands. But won't take a huge bite from the budget.

Okidata's new multifunction Microline (ML) 92 printer is just the animal. It prints high resolution, correspondence quality text that's a match for any daisywheel's at 40 cps. Graphics and emphasized and enhanced printing at 80 cps. And bidirectional, data processing with short line seeking logic at 160 cps. Add an alternate, downline loadable character set, and you've got one heck of a printer. And there's an ML 93, too, that adds wide-column printing to the picture.

Both of our new high performers have no duty cycle limitations and feature the Okidata, 9-pin print head

that's guaranteed for one full year. But the really great news about each is price: \$699 suggested retail for the ML 92; \$1249 for its big brother. Absolutely purrrfect.

For more great news about the ML 92, 93 and all the Okidata printers, see your computer dealer or call 1-800-OKIDATA. In NJ, 609-235-2600. Okidata, Mt. Laurel, NJ 08054.

OKIDATA

A subsidiary of Oki Electric Industry Company Ltd.

All Okidata printers are compatible with Apple, IBM, Radio Shack, Osborne and just about every other personal computer.

Circle 306 on Inquiry card.

ferent telephone system were needed to speak different foreign languages.

Data-communication systems have likewise been divided into various layers. A seven-level model promoted by the International Organization for Standardization (ISO) is typically used. A complete description of the model is beyond the scope of this article. In general terms, however, this seven-layer model, like our simple example, runs from the more abstract layers at the top (level 7) to the physical layers at the bottom (level 1). Most of the work in standardizing data-communication protocols has heretofore been done at the lower, physical levels.

NAPLPS is a standard for the sixth level, commonly called the *presentation level*, of the seven-level model. In our example of human communication, NAPLPS is similar to the logical (English, French, and German) level. NAPLPS has been designed to allow a large variety of information to be encoded in a manner that preserves the conceptual content of the

information. NAPLPS codes can be physically transported between computer systems via modems and data links, floppy disks, magnetic tapes, and other common mechanisms.

Code-Extension Techniques

The coding of NAPLPS begins with bits and bytes. The 8-bit byte can be used to represent 256 unique patterns or code points. At first glance, the 256 codes might seem to be a large

In NAPLPS, 96-code sets can be swapped in and out of a large 256-code table.

enough set, especially if only letters, digits, and control information must be encoded. But in order to encode graphics coordinates, colors, graphics drawing commands, and advanced control information, more than 256 codes are needed. The obvious solution is to group bytes together se-

quentially to form an extremely large set of commands. This is similar to what occurs in English where the 26 letters of the alphabet are grouped to form words.

Grouping of bytes is commonly called *code extension*. Many code-extension techniques use the ASCII Escape character (ESC, hexadecimal 1B, decimal 27) as an indicator that the next character has a special meaning. Many times, the next character indicates that more characters follow. (An example of this type of code extension is the typical multicharacter Escape sequence for the cursor-positioning sequence supported by many terminals.)

This approach to code extension is fine for a small number of extensions, but tends to become a hodgepodge of inconsistent code sequences when a large number of extensions are defined.

NAPLPS has been designed with an extremely general code-extension structure that is independent of the specific "meanings" of the codes, and is based on an ISO recommendation (ISO 2022.2).

Keep in mind that up to this point we have been talking about codes as 8-bit binary numbers in the decimal range 0 to 255. No meaning has been placed on the codes. Because of the widespread use of ASCII, many people assume that a capital "C" must *always* be coded as a decimal 67, as it is in ASCII. The assumption is also made that the value 67 cannot be used to code anything but capital Cs. In order to fully understand NAPLPS, you must first realize that the relationship that exists between the capital C and 67 is by *convention* and not due to some physical limitation of computers or an act of God. Furthermore, you must realize that the decimal value 67 (or any code) can be given other meanings in other contexts as long as an indication is given as to which context is currently in effect.

The basic strategy underlying code extension in NAPLPS is to take a large table of codes (128 or 256) and divide it into smaller sets of codes that can be "swapped" in and out of the large table. The small code sets



\$999



Dist. by Bell & Howell

800 368-3417

APPLE PARTS	PRINTERS	SYSTEMS	
Disk II & Controller .. 450	NEC 3510 1399	Kay Pro II 1775	
Quentin Drives 299	NEC 7710 2338	Micro Decision 1149	
Premium Pack 499	Diablo 630 1799	Ace 1000 Call	
BMC Monitor 91	Okidata 82A 439		IN STORE ONLY
Amdek RGB Color II .. 749	Okidata 83A 689		The Fabulous EPSON QX-10 AND HX-20 COMPUTERS
Hays Apple Modem .. 289	Strobe Plotter 699		
Pascal 199			
Visicalc 189	MODEMS		
Logo 99	Hayes 1200 Baud .. 549		
Master Type 28	Ventel MD2124 849		
Wizardry 38	Ventel MD212-E 569		
	Cat 1200 212A 588		

THE Computer Learning Tree



Government Sales
Call 703-750-2632

7023 Little River TnPk.
Annandale, VA 22003

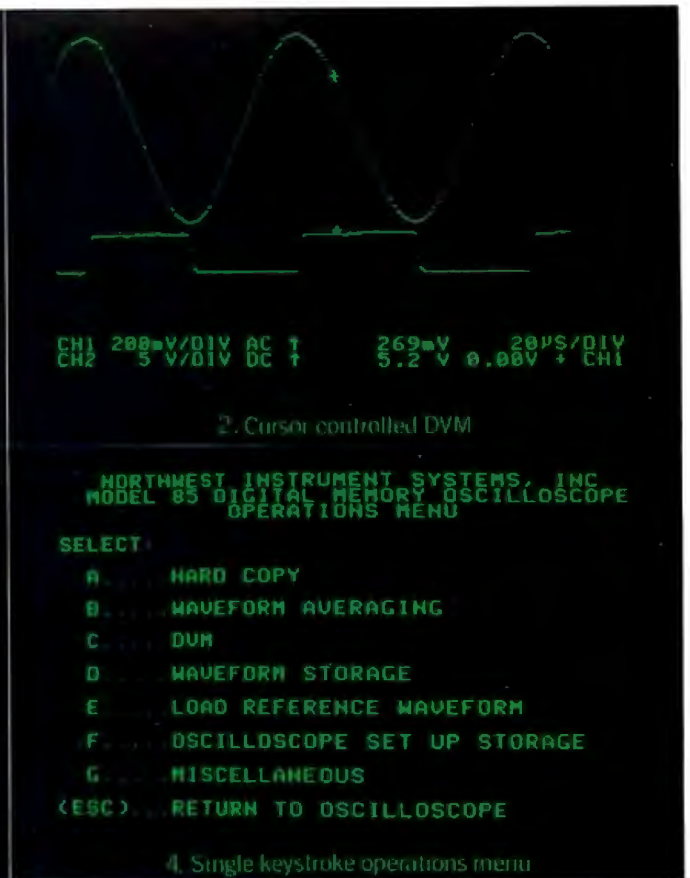
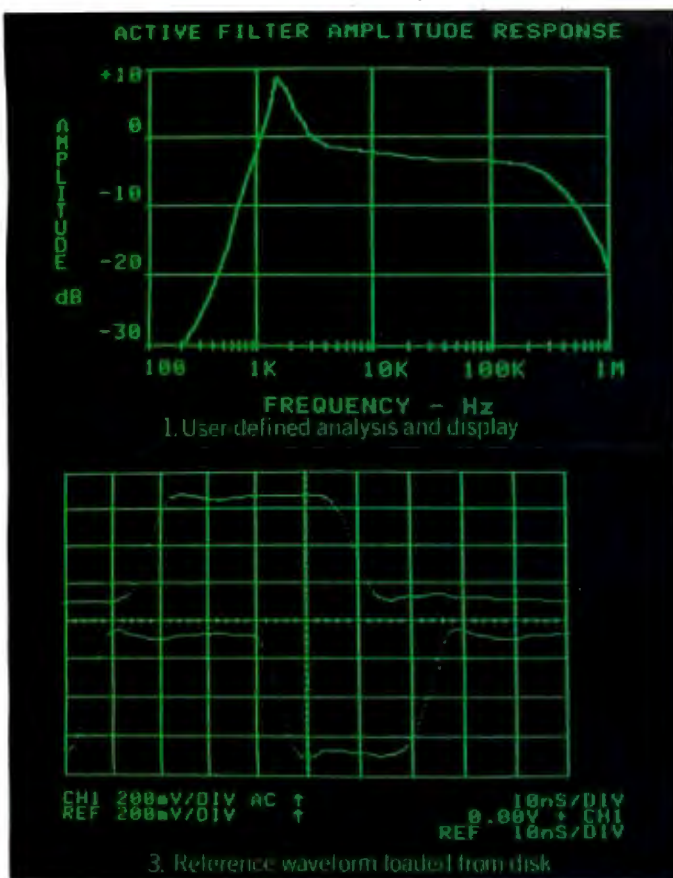

WHICH OF THESE DISPLAYS WERE GENERATED BY A PERSONAL COMPUTER?

Every single one of them. And not just generated, either. The instrument settings were configured, signals acquired, and analysis performed via a personal computer, also. An Apple II®, to be specific. Equipped with Disk II®, 48K memory, DOS 3.3 and a remarkable, make that revolutionary, engineering breakthrough known as the Model 85 aScope™. Remarkable because aScope transforms any computer in the Apple II series into a dual channel, DC to 50 MHz repetitive signal bandwidth (25 KHz real time sampling rate), fully programmable, digital memory oscilloscope. Revolutionary because it does all this for less than \$1,000.

The way we achieved this cost reduction was by not following the path of conventional instrument architecture, combining a stand-alone programmable oscilloscope with a general purpose computer controller. Instead, we integrated. Making aScope a peripheral. Supplying only what was needed to make the personal computer a high performance instrument.

Result? An oscilloscope system that allows you to configure a setup, define the analysis you desire and produce an end result display in the most useful format. Many frequently

performed routines are already part of aScope's software. But more importantly, the system's architecture is designed to accommodate considerable user modification via co-resident BASIC or assembly language programs. (One example: the user-defined program to plot the amplitude response of an active filter shown in display 1 above.)

aScope will average waveforms. Store waveforms on disk in binary or text files. Store instrument settings for automated setup. Or load and display a reference waveform from disk (display 3 above).

aScope also delivers waveform voltage readings utilizing a cursor-controlled digital voltmeter (display 2). And generates hard copy via an Epson MX-80™ or Silentype® printer.

Space permitting, we'd go on about aScope's menu driven single keystroke commands (display 4), its sub-menus with complete prompting and so forth. But frankly, we suspect you're probably as intrigued as you could be on the basis of one ad.

So here's how to find out more. Call 800-547-4445. This will provide you with the name of the aScope representative or authorized com-

puter dealer in your area, as well as an opportunity to invest \$10 in our comprehensive aScope demonstration disk.

The Model 85 aScope. We admit, the performance it delivers for the price is so remarkable, it may initially strike you as unbelievable. But then, when you think about all the breakthrough products this industry has seen over the last decade, sounding unbelievable at first is almost a tradition.



NORTHWEST INSTRUMENT SYSTEMS, INC.

P.O. Box 1309,
Beaverton, Oregon 97075
800-547-4445
(503) 297-1434



Apple II®, Disk II®, and Silentype® are registered trademarks of Apple Computers, Inc. Epson MX-80™ is a trademark of Epson America, Inc.

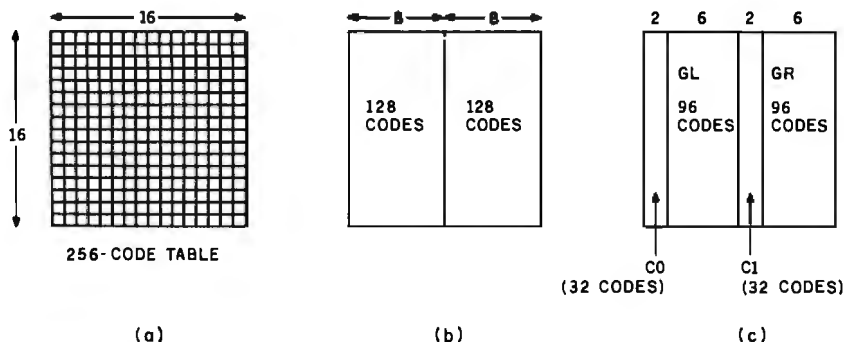

Figure 5: With an 8-bit code, 256 combinations are possible. These can be represented on a 16 by 16 table (a). For convenience, this large table can be divided into two 128-code tables (b). Each of these 128-code tables can then be further subdivided into a 32-code table and a 96-code table (c).

can include codes with similar characteristics. The sets can have standard names, and a standard mechanism can be established to control the swapping. New sets can be added as long as a unique name is chosen. Because a standard mechanism would already be in place to handle the swapping, the new code set could be added without affecting other sets.

Up to now, we have been talking

mainly about an 8-bit code. Actually, two code-extension techniques are supported in NAPLPS: 7-bit and 8-bit. The 7-bit extension technique is used in systems where only 7 data bits can be passed through the lower, physical levels of communication (levels 1 through 5). The eighth bit is often reserved for parity so that errors can be detected. In a seven-level system, error control is usually per-

formed at level 2. Because NAPLPS is a level-6 protocol, the error-control bits have already been handled prior to the data's reaching level 6.

The 8-bit code-extension technique is used when all 8 data bits are available for NAPLPS information. This is the method that is used in systems where the low-level protocols can support 8 bits. It will also be used when files containing NAPLPS are exchanged between users via disks and tapes. Because of the eventual widespread use of the 8-bit code-extension technique, it is the one that will be described in this article.

With 8 data bits, the 256 codes or patterns can be grouped in the form of a table with 16 rows and 16 columns ($16 \times 16 = 256$), as shown in figure 5a.

The 16 by 16 table can be divided into two sets of 128 codes, as shown in figure 5b. These two sets can each be partitioned into sets of 32 and 96 codes ($32 + 96 = 128$), as shown in figure 5c. The 32 codes will occupy two columns of the original 16 by 16

PION introduces the INTERSTELLAR DRIVE.

A solid state disk emulator for your APPLE*, TRS80, S100, or SS50 computer**

Introductory Price \$1095. plus tax and shipping



SEND FOR FREE BROCHURE

Identify your model.

- A FAST mass storage device. Speeds up any program requiring disk access.
- No head seek time, no motor startup time, no moving parts.
- Standard 256K bytes of storage expandable to 1 megabyte.
- Independent regulated power supply.
- Automatic power failure detect and battery backup.
- Hardware error detection and write protect.
- Only 4 bytes-ports of address I/O space used
- Hardware optimized for block transfers and access.
- Drivers, diagnostics, and utilities software provided.

PION, INC. Tel. (617)648-1717
74 Appleton St., Arlington, MA 02174

*Trade Mark Apple **Trade Mark Tandy Corp.

a message to our subscribers

From time to time we make the BYTE subscriber list available to other companies who wish to send our subscribers promotional material about their products. We take great care to screen these companies, choosing only those who are reputable, and whose products, services or information we feel would be of interest to you. Direct mail is an efficient medium for presenting the latest personal computer goods and services to our subscribers.

Many BYTE subscribers appreciate this controlled use of our mailing list, and look forward to finding information of interest to them in the mail. Used are our subscribers' names and addresses only (no other information we may have is ever given).

While we believe the distribution of this information is of benefit to our subscribers, we firmly respect the wishes of any subscriber who does not want to receive such promotional literature. Should you wish to restrict the use of your name, simply send your request to the following address.

BYTE Publications Inc
 Attn: Circulation Department
 70 Main St
 Peterborough NH
 03458

THE AIR FORCE HAD TO BUY 8,000 100MHz SCOPES TO GET A BETTER PRICE!

Ultra sensitive vertical sensitivity: Scale factors from 50V/div (10X probe) to 1mV/div (1X probe). Accurate to $\pm 3\%$ AC or DC coupling. CH3 & CH4 100 mV/div and 1V/div.

Four high-sensitivity channels: DC to 100 MHz bandwidth over the entire range of the scope (-3dB @ 100 MHz). 3.5 nS rise time. Bandwidth may be limited to 20 MHz by use of switchable filter.

Soft touch mode switching: Fully electronic switching with non-volatile RAM memory and LED status indication.

Two independent time bases:
A: 20 nS/div to 5S/div in 23 steps
B: 20nS/div to 50mS/div in 20 steps
To 2nS/div with X10 magnification.

Calibrated delayed sweep measurements: From 0.5 seconds to 200nS.

Time base mode selection: Selects the time base operation best suited to the application.

Selectable 1M /50 Ω input: Channels 1 and 2 offer switch selectable impedance control.

Dual Intensity Control: Separate intensity control of delayed and undelayed signals in ALT, DUAL, A-INT-B and B-DLYD modes.

Eight-trace display: The delay time base mode, in conjunction with the alternate horizontal display mode, operate on all four inputs, providing eight-trace capability.

Vertical mode operation: For display of four input signals, unrelated in frequency.

Truly complete trigger system: Auto, norm, single/reset, fix, 2 external, TV field, Variable holdoff.

Input channels 3 and 4: For display of two additional inputs, trigger view of both channels or external triggering.

You don't have to be Uncle Sam to get a great scope for a great price! The Air Force will pay \$1,359.00 each for their general purpose, 100 MHz oscilloscopes, at the contractual rate of 275 units per month over 18 months with options for 3,000 more. This B&K Precision 1500 is not just another general purpose scope, but a dual-time base, quad-channel, eight-trace, ultra-high performance 100 MHz scope at only \$1495.00 each — period!

What truly separates the 1500 from the rest of the pack is its unique ability to display four digital signals and not related in frequency simultaneously. If desired, a delayed portion of each waveform can be displayed providing eight traces.

Another key feature of the 1500 is dual time base operation. This feature allows for independent operation of the A Sweep and B Sweep circuits. In this mode of operation, the A Sweep is operated by A Trigger Section and the B Sweep is operated by the B Trigger Section. Dual time base operation allows the 1500 to act like two 100MHz oscilloscopes and to display signals unrelated in time with their own independent trigger sections.

The 1500 offers all the capabilities you might demand from a lab grade oscilloscope. Capabilities such as the increasingly popular feature of trigger view is not only provided on the A Channel but the B Channel as well. Other features include selectable 1 M Ω or 50 Ω inputs which prevent high frequency impedance mismatches that can cause serious measurement errors. When working with low frequencies, the 20 MHz bandwidth filter eliminates high frequency noise.

Function switching on the 1500 is performed by touch sensitive lighted pushbuttons with electronic switching logic with non volatile RAM. This unique design increases user convenience and reliability by eliminating a significant amount of mechanical switching and cabling.

The 1500 employs a high efficiency switching power supply to deliver cool regulated power for long trouble-free performance, at the lowest weight — only 16.5 lbs. for the entire scope.

Other refinements include a 6" diag. 8 x 10 cm illuminated graticule high-brightness domed mesh 16 KV rectangular CRT, beam finder button, LED UNCAL indicators, single sweep operation, variable holdoff as well as alternate or chop operation with two selectable chop frequencies. Probe calibrator for both current and voltage probes. CH1 and CH2 gating pulses are provided for interfacing with external equipment. Also provided is a CH1 50 Ω output for driving an external counter preventing the need for an external "T" adapter and the associated impedance mismatch problems it causes. The output may also be cascaded into CH2 providing 500 uV sensitivity at 100MHz.

B&K Precision backs the 1500 with a one year warranty and has nation wide service available.

The cost? Remarkably reasonable, especially when you compare it to the other leading 60MHz or 100MHz Dual Trace oscilloscopes. This price breakthrough is made possible by **PRIORITY ONE ELECTRONICS** unequalled buying power. As the largest distributor of high performance oscilloscopes, we were able to place the largest order for scopes in B&K's history. We were able to obtain special pricing that allows us to pass on to you a

\$755.00 savings, while the supply lasts.

\$1495.00

BNBKP1500

(Supplied with 2 X10 Probes)

ORDER TOLL FREE: (800) 423-5922
CA, AK, HI, CALL: (213) 709-5111

OR CLIP AND MAIL THE ATTACHED COUPON Circle 341 on Inquiry card.

YES! I WANT TO TAKE ADVANTAGE OF THIS SUPER OSC LOSCOPE VALUE!

Enclosed is my Personal check or Money order
 Charge my VISA or MasterCard # _____ Exp. _____ / _____

QUANTITY	MODEL	PRICE	TOTAL	NAME
1	BNBKP1500 100MHz Oscilloscope	\$1495.00	_____	_____ (On Credit Card)
	BNPLC100 Snap-on front panel cover	\$26.00	_____	COMPANY _____
	BNPLC150 Vinyl case for probes	\$32.00	_____	STREET _____
Shipping & Handling: \$15.00 (for each scope)				CITY _____ STATE _____ ZIP _____
Calif. residents add 6 1/2% Sales Tax				PHONE NO. _____
TOTAL: _____				

PRIORITY ONE ELECTRONICS 961 Deering Ave., Chatsworth, CA 91311 5887

Apple Disk Special 22.95 per box

All mini's have hubrings except
5 1/4" Single Side, Single/Double

MAXELL		MEMOREX	
MD1	3481	3483	26.95
MH1-10	29.95	3493	
MH1-16			
SCOTCH		VERBATIM	
744D-0		MD525-01	
744D-10	26.95	MD525-10	28.95
744D-16		MD525-16	

5 1/4" Double Side, Double Density

MAXELL		MEMOREX	
MD2	3491	3492	
MH2-10	42.95	3495	
MH2-16			
SCOTCH		VERBATIM	
745-0		MD-550-01	
745-10	37.95	MD550-10	42.95
745-16		MD550-16	

MAXELL		MEMOREX	
MD1-DD	38.95	3504	34.95
SCOTCH		VERBATIM	
746-0	36.95	MD577-01	39.95

5 1/4" Double Side, 96TPI

MAXELL		MEMOREX	
MD2-DD	48.95	3501	47.95
SCOTCH		VERBATIM	
747-0	50.95	MD557-01	50.95

8" Single Side, Single Density

MAXELL		MEMOREX	
FD1	41.95	3062	24.95
FH1		3015	
		3066	
SCOTCH		VERBATIM	
740-0	27.95	FD34 9000	35.95

8" Single Density, Reversible

SCOTCH		MEMOREX	
740/2	44.95	1729	45.95

8" Single Side, Double Density

MAXELL		MEMOREX	
FD1	41.95	3090	32.95
FH1		3091	
SCOTCH		VERBATIM	
741-0	34.95	FD34 8000	41.95

8" Double Side, Double Density

MAXELL		MEMOREX	
FD2	48.95	3102	38.95
FH2			
SCOTCH		VERBATIM	
743	44.95	DD34 4001	49.95

5 1/4" and 8" Head Cleaners
SCOTCH 20.95
VERBATIM Kit, 8.95 10 Disks, 15.95

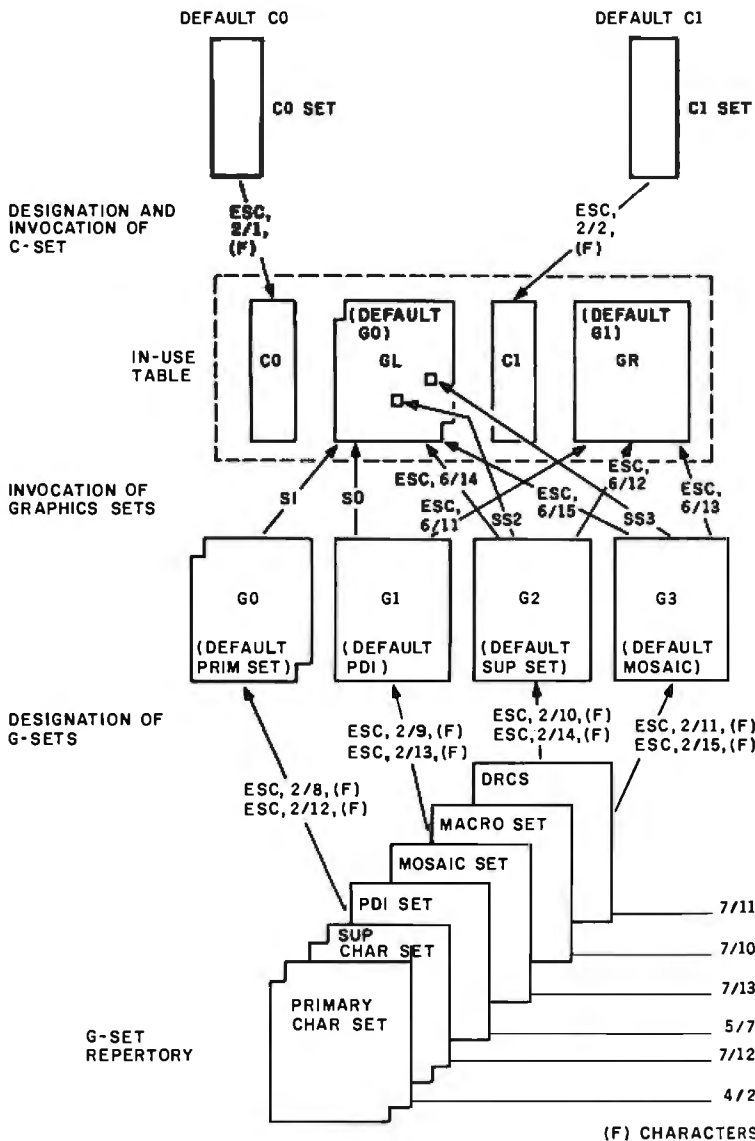

Figure 6: A diagram showing the NAPLPS code-extension technique in an 8-bit environment. By swapping various 96-character graphics sets into and out of the graphics areas of the "in use" table, we can access a large number of characters or commands. Four graphics sets (or G-sets) are selected from the G-set repertoire and placed in designated sets (G0 through G3). Then, two of these designated sets are placed in the graphics areas (GR and GL) of the 256-code "in use" table. Various code sequences (e.g., ESC 6/14) or control codes (e.g., SI) are used to swap the G-sets. The notation "6/14" represents the number 6E in hexadecimal. "(F)" refers to a single-code name of a particular G-set.

table; the 96-code set will require six columns.

As you can see, the large 256-character table has now been divided into four smaller regions. These regions (or sets) allow us to group codes of similar use into tables of manageable size. The two small tables are called *control sets* or C-sets; the two large tables, *graphics sets* or G-sets.

As we mentioned before, a mechanism has been designed to allow a

variety of code sets to be swapped into and out of these four areas of the large table. Currently, however, code-set swapping is done only with the large 96-character G-sets. Although a mechanism exists for swapping the small areas (C-sets), it is not being used at this time.

Before a G-set is swapped into one of the large areas, it must be selected from a repertoire and placed into one of four designated sets. Two of these

designated sets are then placed into GL and GR, the two large areas in figure 5c. Codes are then interpreted based on the current G-sets that are in use in the large table.

Figure 6 illustrates this mechanism for the 8-bit code-extension technique. The arrows and labels indicate special code sequences that are used to cause the swapping. Most of these code sequences begin with the Escape character. The notation "6/14" used in figure 6 is an alternate way of specifying a code with a specific bit pattern. On a 16 by 16 table, 6/14 represents the bit pattern that refers to column 6 and row 14 of the table. In hexadecimal, 6/14 would be 6E; in decimal, $(6 \times 16) + 14 = 110$.

To move a G-set from the repertory to one of the designated sets, a three-character sequence is used. The third character in the sequence (represented by "(F)" in figure 6) is the "name" of the G-set. Each G-set has a unique name that is specified in the NAPLPS standard. For example, the name of the ASCII G-set is 4/2 (42 in

hexadecimal). To move the ASCII G-set from the repertory to the G0 designated set, you would use the following sequence: ESC, 2/8, 4/2. New G-sets can be added at a later date by specifying a new name that has not been used.

If figure 6 looks confusing, the following analogy may help. Imagine that figure 6 illustrates a complex jukebox that has a number of albums

The Primary Character Set contains 96 "oldies but goodies"...

(G-sets) stored in a rack (repertory) and four turntables (designated sets G0, G1, G2, and G3). Buttons are available (e.g., the sequence ESC, 2/8, (F)) that allow you to specify which album should be placed on which turntable. Furthermore, this jukebox has two sound systems (GL and GR). And more buttons

(SO—Shift Out, SI—Shift In, ESC 6/14, etc.) are provided that allow turntables to be connected to one (or both) of the sound systems.

As we continue our analogy, imagine that each album has exactly 96 songs, and that the turntable can very quickly locate and play any of these songs. Furthermore, both sound systems have 96 buttons that can be used to select and play any of the songs instantly.

It should be noted that in order to lessen the amount of record changing involved, four turntables are provided. With two sound systems, we can have two albums or 192 (96×2) songs available instantly. Also, we can have another 192 songs available simply by switching the correct turntable to a sound system. We can play an almost unlimited number of songs if we are willing to go to the trouble of selecting an album, placing it on one of the turntables, switching the turntable to one of the sound systems, and finally selecting a song.

At this point, you are probably wondering what this has to do with text, graphics, NAPLPS, and the price of tea in China. You are also probably wondering what albums are available in the repertory.

NAPLPS currently has six selections available in the repertory (this record industry is still in its infancy). The *Primary Character Set*, also known as ASCII, is full of 96 oldies but goodies like 0, 1, 2, . . . A, B, C, and x, y, z, etc. The *Supplementary Character Set* is full of 96 new and old international favorites, most of which are rarely played in the U.S. These include α and β . The *Picture-Description Instructions* album (PDIs) contains selections like "Line," "Arc," and "Draw Me a Polygon." Some of the hottest hits going are on this album. The *Mosaics* album is full of some very old songs that all sound the same. It is seldom played except by people over 40. The *Macro* album contains songs that cause other songs to be played. (You get a lot for your quarter here.) The *Dynamically Redefinable Character Set* album (DRCS) is initially blank. It can be used to mix existing songs together to form new songs. (Yes, on this juke-

Need to Measure Your Corporate Communications?

Want to define your company's image? Measure competitive strengths? Determine the acceptance of your company publications? Gauge reactions to your annual report? Determine the effectiveness of your corporate advertising? Monitor the impact of important trends and developments on your company's business?

Call McGraw-Hill Research

Backed by 30 years of research experience covering scores of markets and fields, McGraw-Hill Research professionals design custom projects that can make a big difference in the success of your corporate communications efforts. The Corporate Communications Research Center will meet your research needs promptly, at a reasonable price.

Put McGraw-Hill Research to work for you.

For a quote or proposal, call Joan Bullen, Director-Corporate Communications Research Center at (212) 997-3517 or Eleanor Nicoletti, Project Director, at (212) 997-3095. Or, write Corporate Communications Research Center, 1221 Avenue of the Americas, New York, NY 10020



If it's a communications problem, we probably pioneered the solution.

**COMING
SOON
1MB DUAL WIDTH
MEMORY BOARD
DEC PERSONAL
COMPUTERS!**

LSI 11[®] COMPUTERS AS LOW AS \$1,795.00



C-103 DESKTOP COMPUTER. Available with LSI 11/23 or LSI 11/2. Complete computer system enclosed within a VT-103 video terminal, immediate delivery. Only **\$2,995.00** with LSI 11/2 and 64K Memory. **\$4,595.00** with LSI 11/23 and 256K Memory.



CI9448-96 — 96 mega byte cartridge disk system with controller. 80 mega bytes fixed and 16 mega bytes removable **\$10,500.00**

CI-1220 — Dual drive, double density, double sided, 2MB capacity floppy plus DMA LSI 11 controller **\$2,695.00**

RT11 V4 — Operating System **\$1,085.00**

RSX11M — Operating System ... **\$2,250.00**

CI-1103LK — LSI 11/2 CPU, 64KB Memory, power supply, KEV 11 in 16 slot rack mountable chassis **\$1,795.00**

CI-11/23 AC — LSI 11/23 CPU, MMU, 256KB Memory, power supply, in 16 slot rack mountable chassis **\$3,195.00**

CI-KDF11LK — LSI 11/23 CPU, MMU, with 256KB Memory **\$2,195.00**

DON'T ASK WHY WE CHARGE SO LITTLE, ASK WHY THEY CHARGE SO MUCH.



Chrislin Industries, Inc.

31352 Via Colinas • Westlake Village, CA 91362 • 213-991-2254
TWX 910-494-1253 (CHRISLIN WKVG)
DEC LSI, PDP are Trademarks of Digital Equipment Corp.

Monte Carlo Card

THE DISTINGUISHABLE CARD FOR THE DISCERNING USER.
FIVE FUNCTIONS ON A SINGLE BOARD

- ★ 64K to 1 Megabyte RAM Memory
- ★ ONE IBM Compatible Centronics Parallel Port
- ★ ONE IBM Compatible RS-232 Serial Port
- ★ Clock/Calendar (Perpetual Time Keeper)
- ★ Dual-Port Joystick Interface
- Future Upgrade Option: Plug-On Direct Connect Modem
- The Clock/Calendar has full alarm features and 1/100th second timing.

This card is the Ultimate
IBM Peripheral.
See Your Local Dealer.

Available
NOW

The Monte Carlo Card was ingeniously engineered to ensure that the maximum possible variety of the most sought-after features demanded by PC users was amassed upon a solitary board. Providing users with the best value for money, functionality, reliability, and flexibility, were our primary goals, which will enshrine the Monte Carlo Card as the premier expansion board for any PC user.

See Your Local Dealer or Call

I-C Magic +

GRAPHICS

- Full Color or B/W Tones
- HIRES and Medium Res.
- 4-Dot Sizes for Blow-ups
- Reproduce Graphics from Screen to Dot Matrix Printer, Full Screen or Sub-Section
- Rotation, Color Hue Selection
- Shift PrtSc Graphic Dumps
- Color on Prism 132/80
- Operates on EPSON/NEC/C-ITOH PRISM/OKIDATA

SPOOLING

- Selectable buffer 1K to 64K
- Serial or Parallel
- True Background spooling at your fingertips
- Save processor time
- **SAVE MONEY**
- Buffers all text and graphics

TERMINAL

- RS-232 Direct or Modem connection
- Full terminal capability on a chip! Printer Hardcopy/Echo
- Full input/output buffering
- Background terminal features
- Easy for user customization

FOR YOUR IBM PC

IBM is a registered trademark of International Business Machines, Corp. MBI and I-C-Magic are trademarks of Microcomputer Business Industries, Corp.

**MICROCOMPUTER
BUSINESS
INDUSTRIES
CORPORATION**

MBI

ADMINISTRATIVE OFFICES: 1019 8TH STREET, GOLDEN, COLORADO 80401 (U.S.A.)

TELEPHONE: (303) 279-8438 Circle 269 on Inquiry card.

TWX: 910-934-0191

Monte Carlo Card

The distinguishable card for the discerning user

The only true FIVE function card
for the IBM Personal Computer

- 64K to 1 Megabyte of Memory
- ONE IBM Compatible Centronics Parallel Port
- ONE IBM Compatible Asynchronous Communications Port
- Clock/Calendar (Battery Backed) with Alarm Features
- Dual-Port Joystick Interface
- **Future Upgrade Option:**
Direct Connect Plug-On Modem

Monte Carlo

MICROCOMPUTER
BUSINESS
INDUSTRIES
CORPORATION

ADMINISTRATIVE OFFICES: 1018 8TH STREET
TELEPHONE: (303) 279-8438

GOLDEN, COLORADO 80401 (U.S.A.)
TWX: 910-934-0191

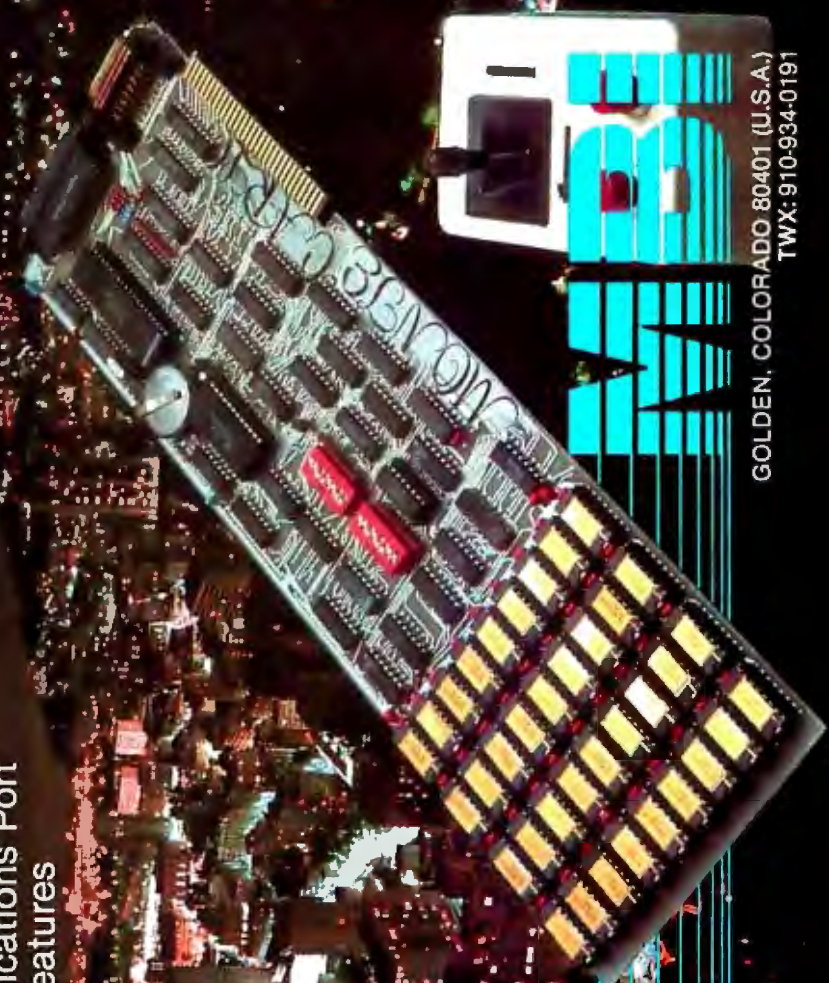

COMMANDS

```
MOVE TO (0.5, 0.25)
LINE (+0.45, +0.125)
LINE (-0.45, +0.375)
LINE (-0.25, -0.25)
ARC (+0.125, -0.125,
    +0.125, +0.125)
MOVE TO (0.413, 0.578)
CIRCLE (0.05, 0.0)
```

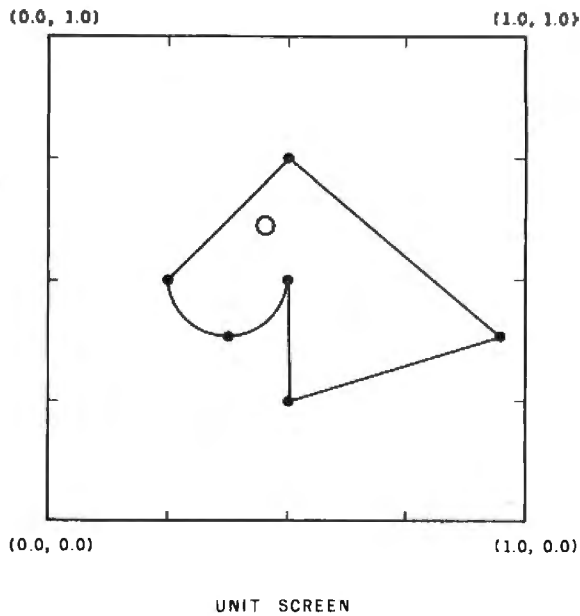

Figure 7: The unit screen of NAPLPS. All coordinates are represented as fractions between 0.0 and 1.0. The figure on the screen was drawn with the commands listed on the left. The advantage of this coordinate scheme is that it can be easily implemented on display screens of various resolutions and sizes.

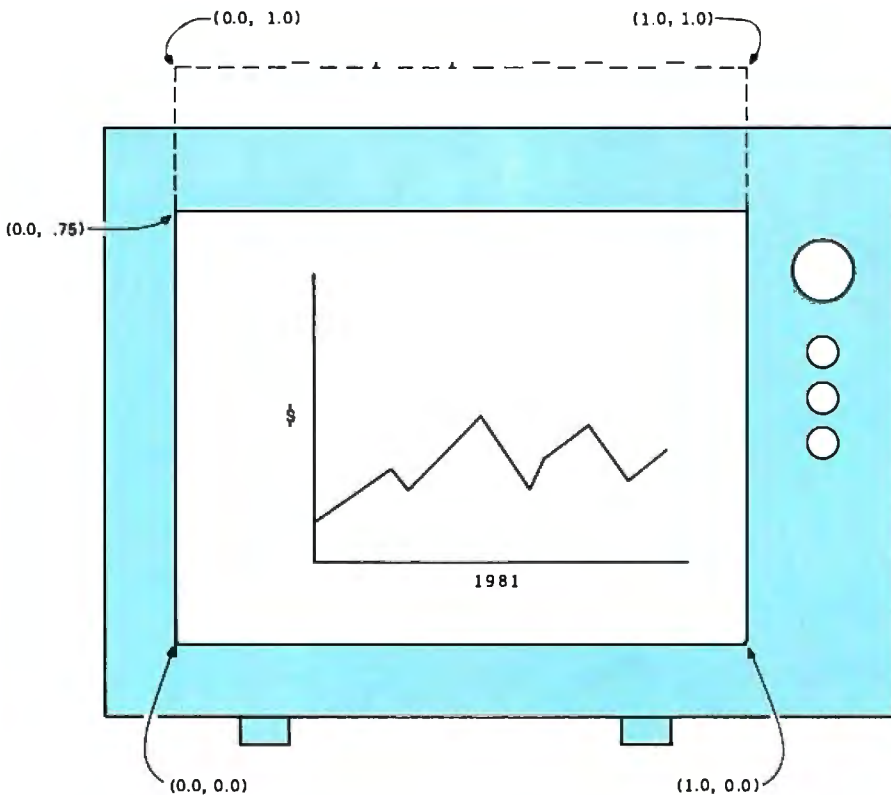

Figure 8: The unit screen is square, but most display screens are rectangular. The convention that has been adopted is to represent on the display screen only the lower 75 percent of the unit screen. That is, any point with a y coordinate greater than 0.75 will not be seen.

box you can record as well as play.)

As mentioned before, default selections have been set up so that no swapping commands are needed in many applications. As shown in figure 6, the ASCII character set is the default for the G0 designated set, and whatever is in G0 is the default for GL. Therefore, the codes in GL (decimal 32 to 127) will be mapped to the ASCII character set as the default condition. (Isn't it amazing how the simplicity of the present can be represented as a subset of the complexity of the future?)

The default for the G1 designated set is the PDI set, and G1 in turn is the default for GR. This arrangement allows text and graphics to be used without any swapping.

The default for G2 is the Supplementary Graphics Set, and the default for G3 is the Mosaic Set. We believe that the Macros and DRCS should have been the defaults. When you devise a standard, however, sometimes a little "default diplomacy" is necessary.

The entire NAPLPS code-extension structure is designed to support future growth in an organized manner. As can be seen, it provides a means of increasing the number of codes far beyond the 256 codes we would have had if there were no code-extension techniques. The overhead has been kept to a minimum while maintaining compatibility with existing ASCII systems.

The Unit Screen and Coordinate System

Now that we have plenty of room for character sets and commands, we can get down to the real purpose of NAPLPS—creating pictures.

In NAPLPS, pictures are drawn on a *unit screen*. As shown in figure 7, the unit screen is a square area of unknown resolution and size. The lower left corner of the screen has x-y coordinates equal to (0.0, 0.0); the upper right-hand corner of the screen has x-y coordinates of (1.0, 1.0).

The name "unit screen" is derived from the fact that all coordinates in the unit screen have an x and y component between 0.0 and 1.0. In NAPLPS, all coordinates and dis-

HERE'S THE PERSONAL COMPUTER AD OUR COMPETITION DOESN'T WANT YOU TO READ.

It's an ad for NEC's APC™ Advanced Personal Computer. A solutions-oriented system that solves business problems in the simplest, most cost-effective way. The APC supports both CP/M-86™ and MS-DOS™. It can store more information than any system in its price range. In short, it's got the best price/performance of any personal computer. That's why our competition would prefer that you never see our system.

We asked some business men who sell systems why they preferred us. The reasons were nearly unanimous. They said, "The APC is the only personal computer on the market that has the power of a 32-bit microprocessor. It has a disk drive, a high-resolution color display, a printer, and a mouse. For the price, it's the best system I've ever seen. It's a good system."

They couldn't say any that well as we. They said, "It's a good system."

"That APC of yours is the most powerful computer of any I saw. I don't know how you did it for that price."

"Now that I've used it for a while, I see why you named it *Advanced Personal Computer*."

And that from businessmen who have tested the competition! When you see the APC, you'll understand why, at the price, others, all of these bought, picked NEC.

Our business software was optimized to take advantage of the APC's unique hardware features. That makes system operation faster and easier.

Our software includes a full set of general accounting packages, word processing, mailing list management, business planning, database management, and communications. And we're readying many more.

We're the only company to back our software with a unique unconditional guarantee. It will work or you get your money back.

Our high-resolution color graphics run circles, arcs and lines around everybody else. The APC's screen images—lines, characters, pictures—are unprecedented in their clarity. Colors against resolution. Competitive systems often must.

compar... the APC
for pla... analysis,
data... manage... word
proc... As part... word
comm... work... al
the AP... final fo
ronic ma... ces,
comput... rieta
data...
AP...
32...
proc...

A uni...
on give...
The...
models...
The mo...
combines a...
black high-res...
128K bytes of U...
a 1-million-byte fr...
keyboard and ma...
dard features yo...
on competitiv...

See for yourself the personal computer our competition wishes had never been invented. The Advanced Personal Computer from NEC. Return the coupon to NEC Information Systems, Inc., 5 Militia Drive, Lexington, MA 02173.



Now available with NEC hard disk.

APC is a trademark of Nippon Electric Co., Ltd.
CP/M-86 is a trademark of Digital Research, Inc.
MS-DOS is a trademark of Microsoft, Inc.

Name _____
Title _____
Company _____

Send me more information on the BE0283
Advanced Personal Computer.

Address _____
City, State, Zip _____
Telephone _____

NEC
NEC Information Systems, Inc.
5 Militia Drive, Lexington, MA 02173

The Benchmark in World Class Computers

Circle 300 on inquiry card.

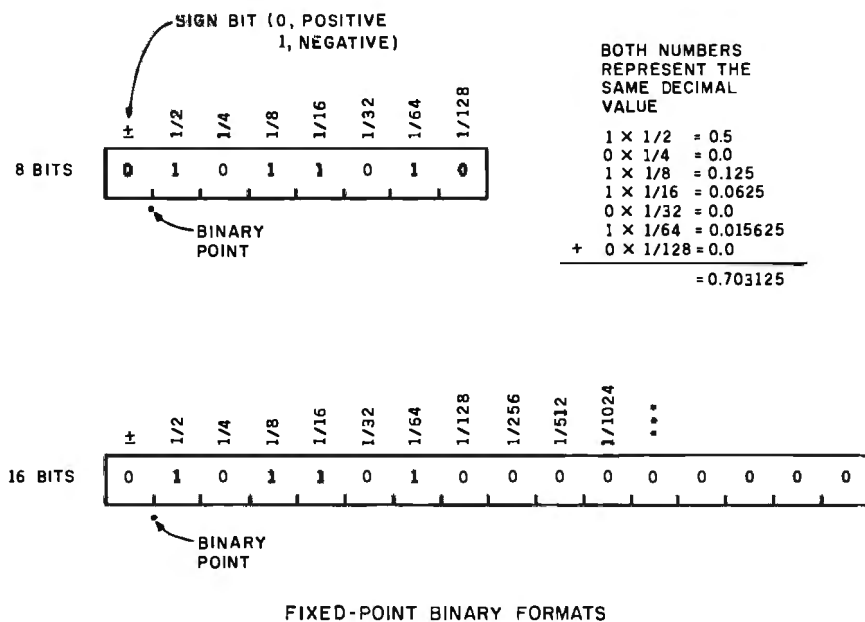

Figure 9: NAPLPS coordinates are formatted as "fixed-point binary numbers." The 8- and 16-bit numbers given here represent the same decimal number, 0.703125.

tances are specified thus in subunits relative to the unit screen. The advantage of specifying the coordinates in this manner is that the pictures will be independent of any particular hardware configuration. Another advantage is that objects in pictures will remain in the same relative position with respect to each other even though the resolution of the physical display may be increased.

In order that pictures may be seen, the unit coordinates must be *mapped* to a physical display. The only requirement imposed (under normal conditions) when making this mapping is that the *squareness* (commonly called *aspect ratio*) of the unit screen should be preserved. Unfortunately, when the unit screen is mapped to the rectangular screen of a television set, some of the unit screen cannot be seen. This is shown in figure 8. The convention that has been adopted is that only the lower 75 percent of the unit screen will be visible on the physical screen. Thus, any point with a y coordinate greater than 0.75 (it is usually closer to 0.78) will not be displayed on a television screen.

This technique of mapping points on the unit screen to the physical screen is called one-to-one mapping. In the future, additional mapping

techniques may be added to NAPLPS that will allow the unit screen to be scaled, rotated, and mapped to the physical screen in a variety of ways. These capabilities will be added at the same time that three-dimensional features are defined.

Now that we know that all coordinates must be between 0.0 and 1.0, a problem arises: How do we represent these coordinates? Floating-point representations could be used. But this would make it difficult for integer-oriented microprocessors to handle the coordinates. Instead of a floating-point format, a *fixed-point binary* (not binary-coded decimal or BCD) format was chosen. This format is the same as a typical integer format, except the *binary point* is assumed to be on the left between the sign bit and the data bits. Figure 9 illustrates the formats for 8- and 16-bit systems.

The important thing to note about this format is that, unlike integers, as more bits of precision are added, they are added on the *right* instead of the left. Also, the values of the binary places work from the left to the right. The value of the bit position immediately to the right of the binary point is 1/2. The next bit position to the right is worth 1/4. The next ones are worth 1/8, 1/16, 1/32, etc.

The decimal value of a number is determined in a manner similar to integers. A number such as 0.1011010000000 represents a positive number (the sign bit of 0) equal to 1/2 + 1/8 + 1/16 + 1/64 or 0.703125, which of course is less than 1.0. An infinite number of zeros is assumed on the right of the number, just as with decimal numbers that are less than 1. Of course, the number will never equal 1.0 no matter how many 1s are placed on the right. (If you do not believe it, try figuring out what the fixed-point binary number 0.11111111111111 is in decimal.)

When coordinates are encoded in NAPLPS, each byte can contain 6 bits of data. (The other 2 bits will be accounted for later.) The standard two-dimensional format is shown on the left of figure 10 (page 227). On the right side of figure 10 is a three-dimensional format. Some three-dimensional capability is supported by NAPLPS today, but many more three-dimensional options will be available in the future. In that case, coordinates are specified in a unit cube rather than a unit screen.

In the two-dimensional format, the 6 data bits are used for 3 bits of x and 3 bits of y. Obviously, multiple bytes are needed if high-precision coordinates are used. As shown in figure 11, as each new byte is added to a coordinate specification, the x and y components each obtain 3 more bits of precision. The least significant bits are obtained after the most significant bits. A terminal may choose to throw away some of the least significant bits if more bits are sent than are needed for the resolution of that particular terminal.

When most people are first exposed to this method of coordinate encoding, their first reaction is that it will be too complex for a simple microprocessor to handle. On the contrary, there is a very easy way to handle this encoding technique: just ignore the binary point and the fractional concepts and treat the bits as integers.

To do this, you must first choose an adequate integer size for internal representations. On 16-bit microprocessors, 16 bits are commonly used. If signed 16-bit numbers are used, a grid

can be set up that ranges from -32,768 to 32,767 in both the x and y directions (see figure 12). The display screen or unit screen would occupy the first quadrant. The unit screen would then be 32,768 by 32,768, which is far more resolution than almost all graphics devices have today.

In this 16-bit internal form, an integer such as 0100000000000000 would have a decimal value of 16,384. This is equal to 1/2 of 32,768, which should not be surprising because we originally said that the binary number 0.1000000000000000 was equal to 1/2 (it's all done with mirrors!). The integer 0101101000000000 that we used before would of course be equal to 23,040 (16,384 + 4096 + 2048 + 512). A quick check with a calculator shows that 23,040/32,768 is exactly 0.703125. (Does this number look familiar?)

It should be clear that treating the fixed-point binary numbers as normal integers is the same as moving the binary point 15 places to the right (for a 16-bit system), which is the same as multiplying the binary fractions by 32,768. We can recover the fractional form by dividing by 32,768, which was demonstrated above.

In order to map the unit screen to a physical display screen, more simple shifting can be used. The sign bits of the x and y components must be positive for the coordinate to be in the unit screen. If the rightmost 7 bits of the 16 bits above are dropped by shifting the integer right seven places, the numbers that result are in the range 0 to 255.

This operation maps the 32K- by 32K-bit grid to a 256 by 256 grid. Each point on the 256 by 256 grid then represents a 128 by 128 area on the original grid. This indicates that when 16-bit integers are used, 128 would have to be added to a coordinate component to move to a different point on the physical display.

If a 512- by 512-bit-resolution display screen is available, another bit on the right of the coordinate integer would be saved. (The 16-bit integer would be shifted right six places instead of seven.) In this case, each point on the 512 by 512 grid

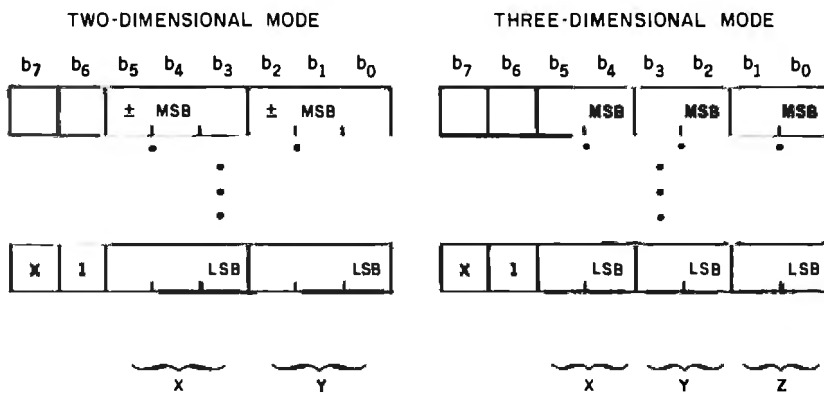

Figure 10: In NAPLPS, coordinates are specified with a varying number of bytes. In the two-dimensional mode, each byte contains 3 bits of the x coordinate and 3 of the y. In the three-dimensional mode, each byte contains 2 bits each for the x, y, and z coordinates. MSB indicates the most significant bit; LSB, the least significant bit.

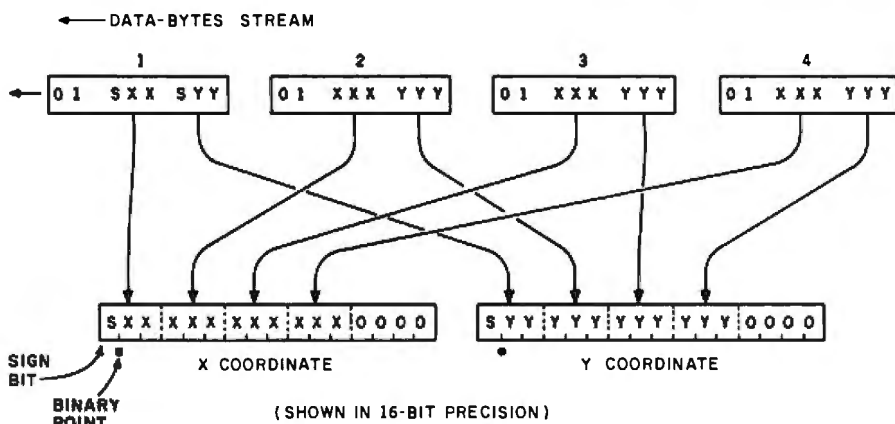

Figure 11: The data bytes shown in figure 10 can be combined to specify coordinates of almost unlimited resolution. Here, 4 data bytes in the two-dimensional mode are combined to form a pair of 12-bit coordinates. This would support a resolution of 2048 by 2048.

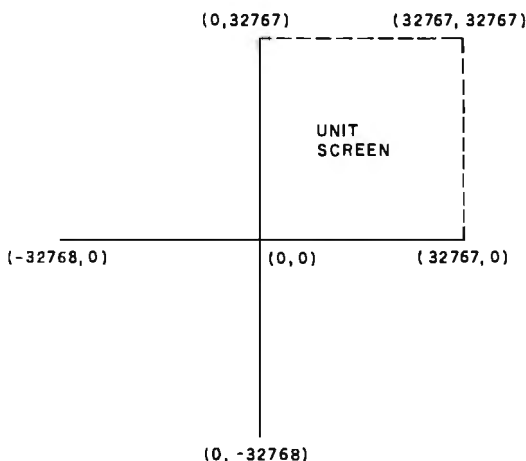

Figure 12: The maximum resolution of a 16-bit coordinate system. The unit screen occupies only the first quadrant of the grid.

FLOPPY DISK DRIVES - 8"**PRICE QTY. ONE****QUME**

242 - Half height DSDD 48TPI	450.00
842 - Full size DSDD 48TPI	465.00

TANDON

TM-848-2 - Half height DSDD 48TPI	465.00
-----------------------------------	--------

MITSUBISHI

M-2894-63 - Half height DSDD 48TPI	465.00
------------------------------------	--------

FLOPPY DISK DRIVES - 5 1/4"**QUME**

142 - Half height DSDD 48TPI	395.00
542 - Full size DSDD 48TPI	460.00
592 - Full size DSDD 96TPI	530.00

TANDON

TM-100-2 - Full size DSDD 48TPI	355.00
TM-100-4 - Full size DSDD 96TPI	365.00

(For the IBM PC)

MITSUBISHI

M-4853 - Half height DSDD 96TPI 1MB	335.00
M-4854 - Half height DSDD 96TPI 1.6MB	395.00

WINCHESTER HARD DISKS**AMPEX**

Pyxis 7-5 1/4" 7MB capacity	650.00
Pyxis 13-5 1/4" 13MB capacity	795.00
Pyxis 27-5 1/4" 27MB capacity	1225.00

*** 1 year warranty ***

WINCHESTER SUBSYSTEMS**MEDIA DISTRIBUTING**

MD-10 - 11MB Capacity	2695.00
MD-20 - 22MB Capacity	3595.00

For Z-80, CP/M Systems

TERMINALS**AMPEX**

VIEWPOINT - Green phosphor	479.00
-----------------------------------	---------------

AMPEX

D-80 - Green phosphor	595.00
D-81 - Green phosphor	625.00

Amber phosphor terminal \$21.00

QUME

QVT-102 - Green phosphor	595.00
QVT-103 - Green phosphor	750.00
QVT-104 - Green phosphor	750.00

PRINTERS**QUME**

Sprint 11 - 40 CPS Daisy wheel	1395.00
--------------------------------	---------

MPI

Printmate 150 A-1 - Serial, 4K buffer	999.00
---------------------------------------	--------

**(408) 438-5454****SUPPLIES AND ACCESSORIES ALSO AVAILABLE****DEALER INQUIRIES INVITED****TERMS: COD, CASH WITH ORDER, MASTERCARD, VISA****FREIGHT CHARGES WILL BE ADDED TO ALL ORDERS**

represents a 64 by 64 area on the original grid. Adding 128 to an integer in this case would move the coordinates by *two* display points, not one. If this did not occur, pictures developed for a 256 by 256 grid would end up in the lower corner of a 512 by 512 display. That lack of portability would discourage increasing the resolution of the terminal. Fortunately, with NAPLPS we can increase the resolution of a display and still be able to receive pictures developed for older displays. They will look as good or better on the new display.

So far, we have discussed only positive coordinates and integers. Negative values can occur in the normal two's complement form used by most microprocessors. Negative values can be used to code relative coordinates (*dx* and *dy* values) when relative movements are needed, rather than absolute coordinates. The values *dx* and *dy* can also be used to indicate sizes of areas on the screen.

Part 2 of this series will describe how the *dx* and *dy* values are used to specify character sizes. We will also see that many of the graphics commands have an absolute form and a relative form. The absolute forms are used when the drawing must appear at a particular spot on the unit screen. Relative forms are useful when one wants to draw relative to the current drawing point, which may be in different places depending on the previous figure.

Color Control

NAPLPS supports a wide range of color control. Three color modes (0, 1, and 2) are available to satisfy many different applications. The first of these (color mode 0) is fairly simple and is designed to be compatible with almost all color display screens. The other two (color modes 1 and 2) use what is known as *color mapping*. This allows you to create some fantastic visual effects, but this technique requires special hardware not found in most color displays.

Color mode 0 is the most primitive mode in NAPLPS. It can best be described by the following analogy using the robot mentioned at the

**TWO
WAYS
TO BUY
ONE
PLACE
TO BUY
WINCHESTER**

COMPLETE SUBSYSTEMS

- The MD-10, an 11 MB formatted system for \$2695.
- The MD-20, a 22 MB formatted system for \$3595.
- The MD-44, a 44 MB formatted system for \$4395.



- Interfaces with any Z-80, CP/M* system as well as 8085/8086 and IBM PC*.
- Software includes SOURCE CODE and enhanced utilities.
- Simple installation.
- Networking option; tape back-up option.

OR DRIVES, OFF THE PALLET

- Unformatted disk drives at 7MB (\$650, quantity one); 13MB (\$795, quantity one); 20MB (\$950, quantity one), and 27MB (\$1225, quantity one).



AMPEX

- 90 millisecond average access time.
- Maintenance-free operation.
- An AMPEX one-year warranty.



DEALER INQUIRIES INVITED

*Registered trademarks of Digital Research, Inc and IBM Corporation

MEDIA DISTRIBUTING 4444 Scotts Valley Drive Scotts Valley, CA 95066 408/438-5454

Circle 249 on Inquiry card.

← DATA-BYTE STREAM

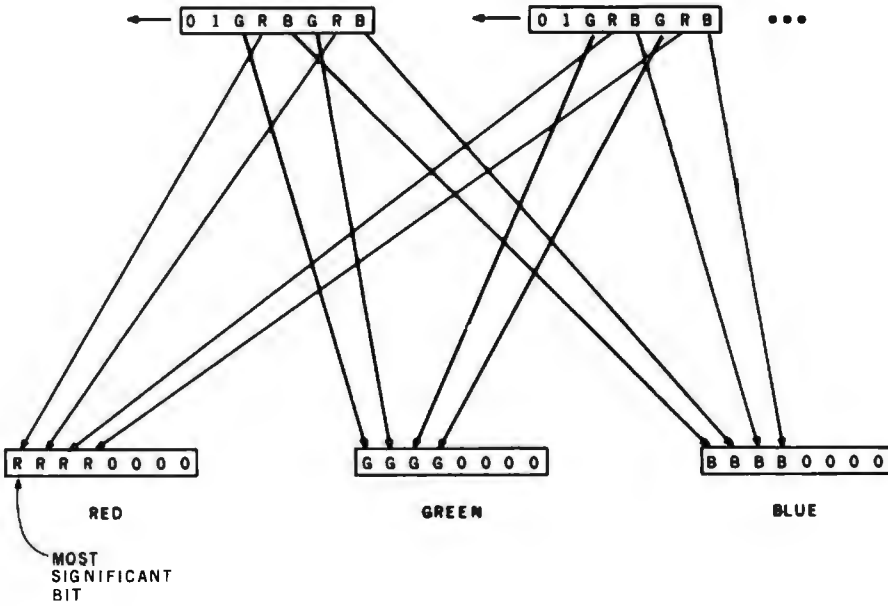

Figure 13: Color information is encoded in a manner similar to that used for coordinates. Each data byte contains 2 bits of information for each of the primary color components: red, green, and blue. A varying number of bytes can be combined to specify colors with almost unlimited precision. Here, 2 data bytes have been combined to yield 4 bits of information on each red, green, and blue component of a color.

beginning of the article. Imagine that the robot has one pen and three inkwells filled with the primary colors red, blue, and green. By mixing various amounts of each of these colors in the pen, the robot can draw in almost any color. For example, we could instruct the robot to mix three drops of red, one drop of blue, and seven drops of green, and then tell the robot to draw various shapes or text characters. When we tell the robot to mix a new color, the robot would automatically clean out the pen and mix the next color.

In NAPLPS, color is similarly specified in terms of its red, green, and blue intensities. Each byte of color data contains 6 bits of color information, 2 each for red, green, and blue. Several bytes, however, can be grouped together so that colors can be specified with as much precision as desired. In figure 13, 2 bytes have been used to yield a total of 12 bits of color information (i.e., 4096 possible colors). As with coordinate encoding,

PopCom™

© BRICKEE ASSOCIATES 1982

NEW! M-68000

SINGLE BOARD COMPUTER

FEATURES:
 16 bit Motorola 68000 CPU operating at 5 MHz or 10 MHz, 20K of on board fast static RAM, 16K bytes of on board EPROM space, 7 autovectorred interrupts, 3 memory/device expansion buses, 2 serial communication ports (RS-232 C), 16 bit bidirectional parallel port, 5-16 bit counter/timers with vectored interrupt and time of the day clock. On board monitor allows to download and debug programs generated on APPLE II, TRS-80 and CP/M using our M68000 Cross Assembler.

PRICE:

M68K Bare board with documentation.....	\$ 99.95
M68MON monitor & mapping PROM's.....	\$135.00
M68000-6 CPU.....	\$ 95.00
M68K Parts Kit.....	\$249.00
M68000 Cross Assembler.....	\$125.00
M68K Documentation only.....	\$ 15.00
Shipping & handling (Domestic)....	\$ 3.50
(foreign)....	\$ 15.00

CALIFORNIA RESIDENTS ADD 6% TAX

EMS Educational Microcomputer Systems

P.O. BOX 16115, IRVINE, CA 92713-6115
 (714) 553-0133

NEW LOW-COST ENGINEERING/BUSINESS PLOTTER

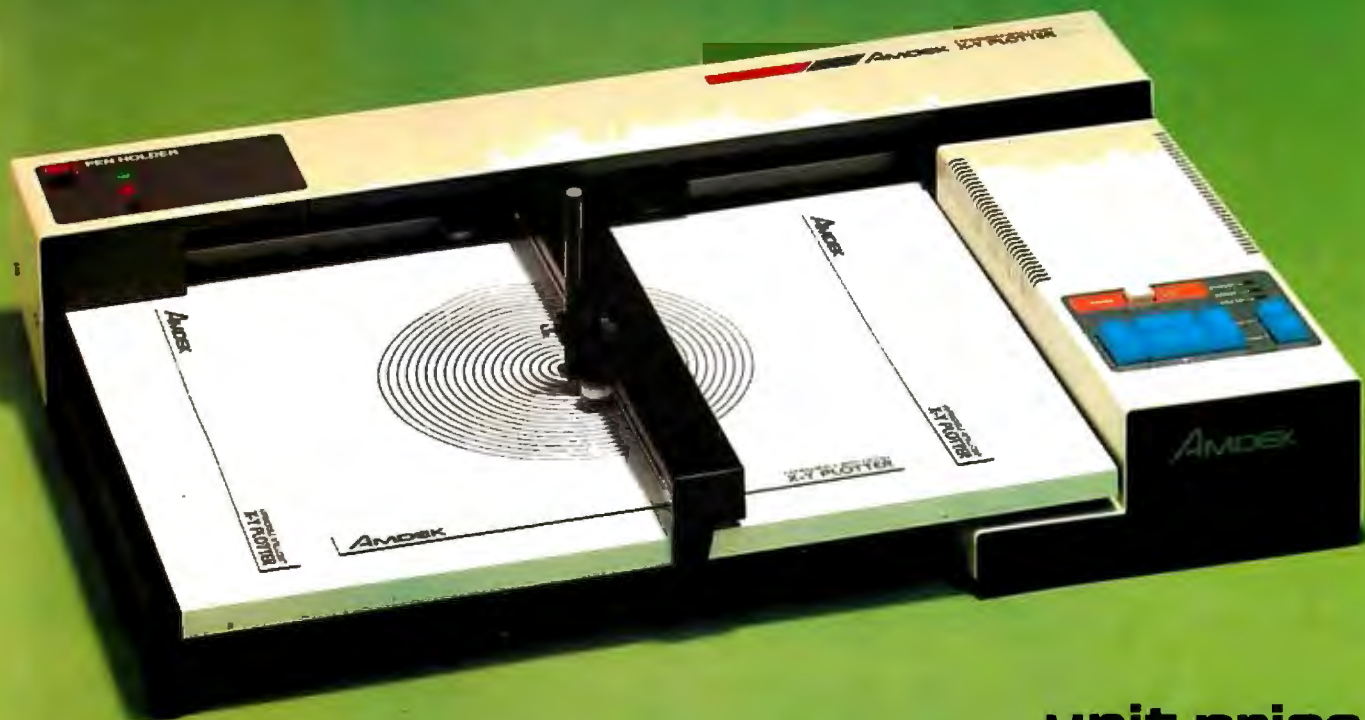

unit price
only
\$749⁰⁰

Cost-effective "originals"

The Model DXY is an economical multi-pen, X-Y coordinate plotter that produces hard copy graphics in minutes for all types of business applications and technical disciplines. Priced at under \$1000, it's compatible with the IBM, Apple and other personal computers. It has built-in software (expandable ROM) to interpret "Basic" commands. Just call, or write for complete specifications on the Model DXY Plotter. Ideal for end-user or OEM applications.

- 10" x 14" effective plotting range.
- Centronics interface for easy connection to your computer.
- Pens, penholders, chart hold-downs, and dust cover are included.
- Charts on popular graphics media including vellum and mylar.

2201 Lively Blvd. • Elk Grove Village, IL 60007
(312) 364-1180 TLX: 25-4786

AMDEK CORP.

Amdex . . . your guide to innovative computing!

Circle 20 on inquiry card.



If you just bought another computer,
boy are you gonna be sorry.

Epson.

The new Epson QX-10 is unlike any personal computer you've ever seen. It's a computer for people who don't have the time to learn computers; a computer you can be using within minutes.

And fortunately, you don't have to take our word for it. Here's how *Byte*, one of the computer industry's most prestigious magazines, describes the QX-10.

The first anybody-can-use-it computer.

"The Epson QX-10 (is) a computer for less than \$3000 that may well be the first of a new breed of anybody-can-use-it 'appliance' computers ... In addition to being a highly integrated word processing/computer system that offers as much usable processing power as almost any existing microcomputer, the QX-10 ... system is designed to be used by people with minimal technical knowledge. We've certainly heard that claim before, but Epson has delivered on this promise in a way and to an extent that no microcomputer manufacturer has done."

That's nice to hear from a magazine like *Byte*, of course, but it doesn't surprise us. It's just what we intended the QX-10 to be all along.

More computer. Less money.

But useability isn't the only thing the QX-10 has going for it. As *Byte* says, "the QX-10 gives you a great deal for your money.

"Help is available at any time through the HASCI (Human Application Standard Computer Interface) keyboard Help key ... Text can be entered at any time just as you would in a conventional word processor. The Calc key turns the system into a basic

4-function calculator. Graphics can be created via the Draw key. The Sched (schedule) key gives you access to a computer-kept appointment book, a built-in clock/timer/ alarm, and an event scheduler."

Advanced hardware for advanced software.

As for hardware, *Popular Computing*, another industry leader, says: "The QX-10 includes ... a number of advanced hardware features ... The basic components of the system are a detachable keyboard, a high resolution monochrome display, and a system unit containing two 5¼ inch disk drives. The drives use double-sided, double-density disks (340K bytes per disk) and are amazingly compact ... The QX-10 uses an 8-bit Z80A microprocessor. The system contains 256 bytes of RAM. Some of the RAM is ... battery powered ... which lets the computer retain information when the power is off."

You won't have to wait much longer.

The new Epson QX-10 may very well be the computer you've been waiting for. And fortunately, you won't have to wait much longer — it will be appearing soon in computer stores all across the country. In the meantime, write Epson at 3415 Kashiwa Street, Torrance, CA 90505, or call (213) 539-9140. We'll be happy to send you copies of our reviews.

After all, as *Popular Computing* puts it, the QX-10 will "do for computing what the Model T did for transportation."

And we couldn't have said it better ourselves.



EPSON
EPSON AMERICA, INC.
COMPUTER PRODUCTS DIVISION

3415 Kashiwa Street
Torrance, California 90505
(213) 539-9140

Circle 171 on inquiry card.

We Have It! Terminals, Printers & Monitors

TeleVideo



925C

Protected fields, optional 2nd page of memory, visual attributes, tilt-swivel screen (non-glare P31 green), 25th status/user line, time of day, can emulate 912/920, RS232C printer port, 50 Baud to 19.2KB., 8x10 character resolution, switchable character sets, function keys self test.

910C	\$595
910C +	595
912C	739
920C	789
925C	789
950C	989

HAZELTINE



Esprit I	\$499
Esprit II	Call
1420	595
1500	949
1510	1089
1520	1389
Exec. Basic 20	1065
Exec. Basic 30	1189

SOROC

SOROC IQ-130	\$595
--------------------	-------

TI CRT Terminals

940, Basic	\$1599
940, Package	2079

LEAR SIEGLER

ADM 22	\$595
ADM 3A	535
ADM 5A	579

ZENITH data systems

Z-19 Video Terminal



Green Phosphorous Screen.
Now Only

\$729

NEW ZT-1,
(Terminal WITH Auto-Dial Modem) **\$595**

OKIDATA

Microline 80, Parallel	\$359
Microline 82A Serial & Parallel	459
Tractor Option, 80 & 82A	50
Microline 83A, Serial & Parallel	729
Microline 84, Parallel	1149
Microline 84, Serial	1249
Okigraph 82A	85

DIABLO

630 RO	\$2299
630 R155, (All purpose interface)	1998
630 KSR	2825

QUME

Qume 9/45, Full Panel	\$1998
-----------------------------	--------

CENTRONICS

737-3, RS232C	<i>New Low!</i> \$389
730-1, Parallel	<i>New Low!</i> \$349
704-9, 150 CPS (RS 232C)	1595
704-11, 150 CPS Parallel	1695
122G 120 CPS Parallel	949

NEC Spinwriter

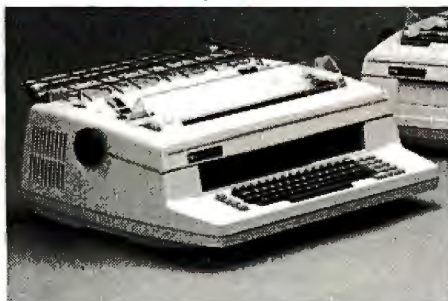

3510 RO, 35 CPS	\$1695
3530 RO, 35 CPS (Centronics Interface)	1859
7710 RO, (RS232C) 55 CPS	2375
7720 KSR (RS232C) 55CPS	2795
7730 RO, 55CPS (Centronics Interface)	2375

IDS

INTEGRAL DATA SYSTEMS



IDS 445G	<i>Special!</i> \$599
MICROPRISM	599
PRISM 80, Basic	Call
PRISM 80, w/o color	1149
PRISM 80, w/color	1499
PRISM 132, Basic	Call
PRISM 132, w/o color	1469
PRISM 132, w/color	1695

Texas Instruments



TI 810, Basic	\$1349
TI 810, VCO, ASC II Full	1599
TI 810, Enhanced	1950
TI 810, VCO/Full Enhanced	2099
TI 820, RO w/LC	1645
TI 820, RO w/comp. print, DFC	1795
TI 745, Portable Terminal	1399

EPSON

MX-80	\$489
MX-80FT	589
MX-100FT	789
RS232, w/4K Buffer	135

C.I.TOH

ProWriter 8510, Parallel	\$549
ProWriter 8510 ACD, Parallel & Serial	649
ProWriter 1550, Parallel	789
ProWriter 1550, Serial	845
F-10, Parallel or Serial	1599
Daisy Wheel Tractor, For F-10	275

ANADEX

DP-9000A/01A	\$1429
DP-9500A/01A	1429
DP-9620A	1569

MiniMicroMart, Inc.

943 W. Genesee St.
P.O. Box 2991 B
Syracuse, New York 13220

(315) 422-4467

TWX 710-542-0431



All prices F.O.B. shipping point, subject to change. All offers subject to withdrawal without notice. Advertised prices reflect a 2% cash discount (orders prepaid prior to shipment). C.O.D.'s & Credit Cards, 2% higher.

Circle 281 on inquiry card.

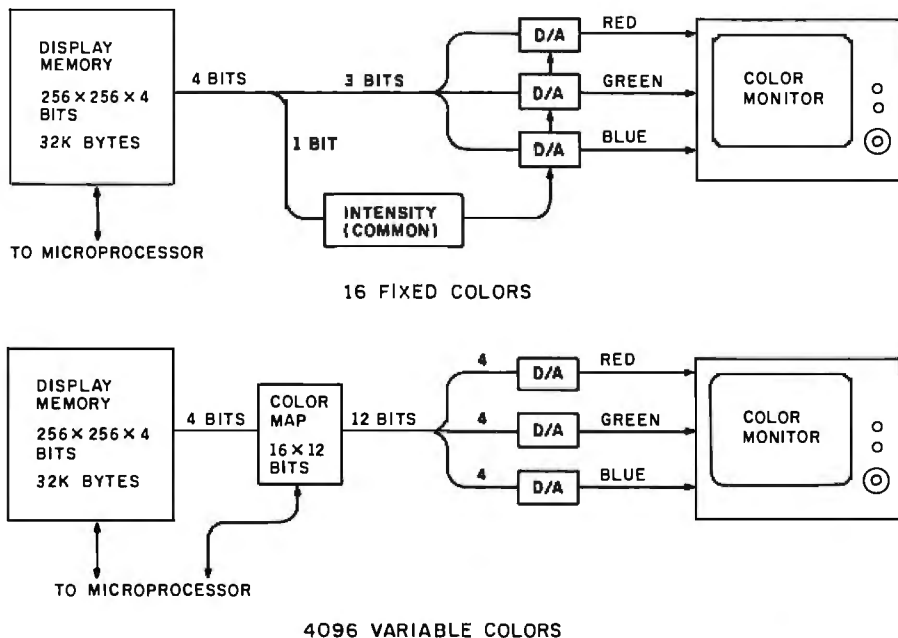

Figure 14: Two popular schemes for storing color information. Both use the same amount of display memory. In the top scheme, the 4 bits for each pixel specify 16 fixed colors. In the lower scheme, the 4 bits specify 16 color registers in the color map. Each color register in turn specifies one of 4096 colors. D/A designates a digital-to-analog converter.

the most significant bits are sent first, and a terminal is free to ignore the least significant bits.

With this kind of system, a tremendous spectrum of colors may be displayed, depending on the amount of memory available.

Most personal computers have only a small number of colors available. In the above analogy, the robot might have 8 or 16 pens with premixed colors. When we gave the robot instructions to mix a certain color, it would merely pick the pen with the color closest to the specified color.

The advantage of color mode 0 is that it can be received on almost all terminals. An inexpensive color terminal can display the same picture—although much less vividly—as an expensive, dedicated graphics terminal.

Color mapping, which is used in color modes 1 and 2, allows a terminal to display a wide spectrum of colors without requiring a large amount of memory. The Atari 400 and 800 are two of the few home computers that make use of this technology (see "Computer Anima-

tion with Color Registers" by David Fox and Mitchell Waite, *BYTE*, November 1982, page 194).

In color mapping, if we return to the above analogy, the robot has the three primary-color inkwells again and a set of, say, 16 pens numbered 0 through 15. Using NAPLPS, we can instruct the robot to mix various col-

With NAPLPS, an inexpensive color terminal can display the same picture—although much less vividly—as an expensive, dedicated graphics terminal.

ors in each of the pens. We can then instruct the robot to draw with a given pen, referring to it by its number rather than by its color. In a computer, we would store the color information not in a pen, but in a color register as part of a color map or color table.

In figure 14, we compare a system using fixed colors with one using color mapping. Both have the same amount of display memory (32K bytes). In the fixed-color system, the 4 bits in memory for each pixel specify one of 16 combinations of red, green, blue, and intensity. In the color-mapped system, the 4 bits refer to one of 16 color registers, each of which in turn refers to one of 4096 combinations of red, green, and blue.

Another important advantage of color mapping is that if we instruct the robot to change the color in a given pen, everything previously drawn with that pen will also change color. This amazing capability can be used to create some dramatic animation effects. These effects are typically referred to as color-table animation.

Color-table animation is a very complex area of NAPLPS. A mechanism has been provided that allows you to specify color interchanges in the color map based on timed relationships. (This command has been given the innocuous name BLINK.) Time intervals can be set in units of $\frac{1}{10}$ of a second, which allows compatibility with 60-Hz (U.S.) and 50-Hz (Europe) systems. Color-table animation will be discussed in greater detail in the third part of this series.

As we mentioned before, the major drawback of color modes 1 and 2 is the dependence on special hardware to achieve the full capabilities of the modes. This drawback was known at the time NAPLPS was designed, but it was determined that because of the incredible special effects that can be achieved using these modes they would be included. Anyone who does not have a need for these special effects should concentrate on using color mode 0 to insure portability of information.

Text Features

Text is handled as a subset of graphics. Text is a special form of graphics that involves predefined "templates" that are rectangular in shape. The rectangular templates can be scaled to any size and positioned *anywhere* on the unit screen. The

CP/M GRAPHICS SOFTWARE

PLOTWARE-Z

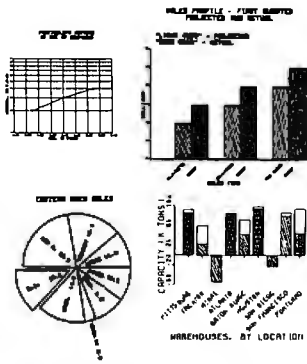

**On ALTOS, APPLE,
OSBORNE, ZENITH,
and most others.**

THE MOST COMPLETE:

Use THREE ways:

1. "MENU" GRAPHICS (easy, friendly)
2. "COMMAND FILES" (powerful, flexible)
3. "COMPILER LINKED" (Fortran, etc.)

Use on: most CRT's, dot matrix printers, plotters, word processing printers

THE MOST PROVEN:

2 years in the field

THE MOST IMPLEMENTED:

1. 8 bit and 16 bit machines
2. USER MODIFIABLE
3. many applications programs

\$399 complete

\$35 manual only

VISA, MC, C.O.D., CHECK, M.O.

THE ENERCOMP COMPANY

P.O. Box 28014
Lakewood, Colorado 80228
(303) 988-1648

Also Available Through

WESTICO

The Software Express Service

25 Van Zant Street • Norwalk, Connecticut 06855
(203)853-6880 • Telex 643788

and selected dealers.

					b6	0	0	1	1	1	1
					b5	1	1	0	0	1	1
					b4	0	1	0	1	0	1
						2	3	4	5	6	7
b3	b2	b1	b0								
0	0	0	0	0		0	@	P	`	p	
0	0	0	1	1	!	1	A	Q	a	q	
0	0	1	0	2	"	2	B	R	b	r	
0	0	1	1	3	#	3	C	S	c	s	
0	1	0	0	4	\$	4	D	T	d	t	
0	1	0	1	5	%	5	E	U	e	u	
0	1	1	0	6	&	6	F	V	f	v	
0	1	1	1	7	/	7	G	W	g	w	
1	0	0	0	8	(8	H	X	h	x	
1	0	0	1	9)	9	I	Y	i	y	
1	0	1	0	10	*	:	J	Z	j	z	
1	0	1	1	11	+	;	K	[k	{	
1	1	0	0	12	,	<	L	\	l		
1	1	0	1	13	-	=	M]	m	}	
1	1	1	0	14	.	>	N	^	n	~	
1	1	1	1	15	/	?	O	_	o		

Figure 15: The Primary Character Set, which is very similar to ASCII. Note that bit 7 is not shown. The value of bit 7 would depend on which graphics area (GL or GR) this G-set was placed in.

If you think good software has to be expensive, think again!

CP/M® DATABASE

TARBELL DATABASE SYSTEM consists of a series of programs that use a common file format. These programs perform often-used functions in an interactive atmosphere. They are provided in both BASIC source form and COM file form, and can be run immediately with no other software except CP/M.

FEATURES

- 3 times faster than previous version
- CB80 language source and COM files included
- extensive HELP system
- up to 19 files open at once
- automatic record lockout on MP/M®
- No limit on length or number of records
- variable length fields
- field names of any length
- sequential or random files
- optional BTREE index files
- REPORT generator prints from multiple files
- MENU
- 12-digit BCD numeric precision
- automatic Julian calendar conversion

DBQUERY FEATURES

- improved query language
- scope parameters, including NEXT n, REST, ALL
- WHILE and UNTIL to stop scanning on a condition
- AND and OR operators for condition phrase
- RUN a command file from disk
- DEFINE macro substitution capability
- arithmetic operators: + - * / ^ with the usual meanings
- functions include FRE, SQR, EXP, LOG, SIN, COS, TAN, RECNO (current record number), and RESULT (of last SUM or COUNT)



\$100

DISK CACHE MEMORY I/O SYSTEM SOFTWARE

System keeps the most recently used disk sectors in memory for quick access. Transfers are made to and from disk directly with memory, using Direct Memory Access (DMA) and extended address features on TARBELL Double Density Floppy Disk Interface. System increases overall speed of operation 2-to-4 times for CP/M and 2-to-3 times for MP/M. Speed of random access operations is increased even more than sequential operations. Output System (BIOS) automatically updates disk with latest changes. Disk Cache System requires no change in operating procedures. It does require the Tarbell CPU I/O Board.

CP/M BIOS CACHE-C — \$50
MP/M XIOS CACHE-M — \$100

TARBELL BASIC

TARBELL BASIC helps provide speed, debugging, file locating and tailoring to requirements. As interpreter it allows quick debugging online, rather than having to move back and forth through editing, compiling and running. By obtaining source as listing or on CP/M disk, programmer can remove all portions of interpreter not required.

TBASIC FEATURES

- alphanumeric line labels
- assignment of I/O
- PUT and GET string and numeric data
- unlimited length variable names and strings
- procedures with independent variables
- up to 64 files open at one time

DISK OR CASSETTE



\$100

Other TARBELL software available includes Inventory and Sales Order Entry packages — both in Ashton-Tate's DBASE-II. Ask for a demo at your nearest TARBELL dealer.

Tarbell
Electronics

MANUFACTURER OF COMPUTERS,
COMPONENTS AND SOFTWARE

CP/M, MP/M and CB80 are trademarks of Digital Research.

950 Dovlen Place, Suite B
Carson, CA 90746
(213) 538-4251

Circle 401 on inquiry card.

					b ₆	0	0	1	1	1	1
					b ₅	1	1	0	0	1	1
					b ₄	0	1	0	1	0	1
						2	3	4	5	6	7
b ₃	b ₂	b ₁	b ₀			0	→	-	Ω	κ	
0	0	0	0	0			±	·	1	Æ	æ
0	0	0	1	1		¢	²	·	®	Ð	ð
0	0	1	0	0		£	³	^	©	ª	¸
0	1	0	0	0		§	x	~	T.M.	℥	℥
0	1	0	1	0		¥	μ	—	♪	☐	
0	1	1	0	0		#	¶	∪	☐	∪	∪
0	1	1	1	0		§	·	·	☐	∪	∪
1	0	0	0	0		⊗	÷	..	☐	∪	∪
1	0	0	1	0		·	·	/	☐	∪	∪
1	0	1	0	0		“	”	°	☐	œ	œ
1	0	1	1	0		<<	>>	»	☐	œ	β
1	1	0	0	0		←	1/4	☐	1/8	þ	þ
1	1	0	1	0		↑	1/2	”	3/8	ƒ	ƒ
1	1	1	0	0		→	3/4		5/8	ŋ	ŋ
1	1	1	1	0		↓	¼	v	7/8	’n	

Figure 16: The Supplementary Character Set of NAPLPS.

“pattern” on the template is transferred to the screen, overwriting only those areas drawn with the template.

As mentioned earlier, NAPLPS currently specifies three fixed character sets and one redefinable

character set. The Primary Character Set (ASCII) is shown in figure 15 on page 236. Most text is taken from this set. The ASCII character set is the default for the G0 and GL sets in figure 6. Therefore, it is accessed via

the usual codes, 32 through 127 decimal.

A Supplementary Character Set has also been specified in NAPLPS (see figure 16). This character set contains a smorgasbord of symbols and international characters. Most applications will require only a few of these symbols. This character set is the default for the G2 designated set, and must be moved to GL or GR before these characters can be accessed.

The Mosaic Character Set is the third of the fixed sets (see figure 17 on page 242). Although the Mosaic characters do not look like text characters, they are treated exactly like text because of their rectangular shape. The Mosaics have very little use because of the extensive graphics capabilities contained in NAPLPS. The Mosaics are the default for the G3 designated set. Thus, they cannot be directly accessed without a G-set change. (We should have made it harder than that to use.)

The fourth text set in NAPLPS is the Dynamically Redefinable Character Set (DRCS). The templates in this character set are initially blank rectangles. We can define each template, however, by using NAPLPS to draw a pattern on the unit screen and mapping that pattern to the template. The pattern can be drawn with either graphics or text commands. Once the template is defined, it can be used just like any other character. (Yes, existing DRCS characters can even be used to define a new DRCS character.) Thus, the 96 characters in the DRCS set can be used to create custom fonts and special symbols.

NAPLPS provides a variety of text-oriented features, which can be applied to any of the four text sets. Figure 18 on page 244 illustrates many of the available capabilities. In parts 2 and 3 of this series, we will describe how these features are selected and applied.

Graphics Features

The graphics instructions (gr primitives) are specified using codes from the Picture-Description Instruction (PDI) G-set. As shown in figure 19 on page 246, the PDI G-set is a 96-character set that is divided into

With ASCOM™...



personal computer communication
has never been this easy.

That's why Big 8 accounting firms and Fortune 500 companies use ASCOM.

ASCOM is an interactive microcomputer telecommunications program for timesharing and data transfers. It is easy to use because it employs menus, simple commands and features an on-line help facility.

A typical use of ASCOM is to access a data base to retrieve data for storage and analysis on your microcomputer. It can also be used to transmit program files to another machine running ASCOM. This can be done locally through direct connection, or over telephone lines by using a modem.

ASCOM works on IBM PC, MS-DOS, CP/M-86, and CP/M-80 compatible micros.

WESTICO

25 Van Zant Street • Norwalk, CT 06855
(203) 853-6880 • Telex 643-788

Dial up our 24-Hour Computer Hotline for 300 baud modems: (203) 853-0816

- Please send me an ASCOM program & documentation: \$175.00 *
- The ASCOM documentation only: \$30.00 *
- FREE: Catalog of over 250 available programs.

C.O.D. _____ Visa _____ MasterCard _____

Card No. _____ Exp. _____

Model of Micro _____ 5 1/4" _____ 8" _____

Name _____

Company _____ Tel: _____

Address _____

City _____ St. _____ Zip _____

(*Plus \$3.00 shipping and handling in N. America. Ct. residents add 7 1/2% sales tax.)

ASCOM is a trademark of Dynamic Microprocessor Associates. CP/M is a trademark of Digital Research © Copyright 1983 Westico, Inc. A WA + 2

ASCOM features:

- Works with modems or by direct connection at speeds from 110 to 19,200 baud.
- Transfers both text and program files between computers.
- Protocols to synchronize large file transfers.
- Remote mode permits control of another micro running ASCOM.
- Automatic processing with command files.
- Commands for displaying directories and files.

To order ASCOM, call or write today:

WESTICO

The Software Express Service

25 Van Zant Street • Norwalk, CT 06855
(203) 853-6880 • Telex 643-788

It's the same old Apple II.

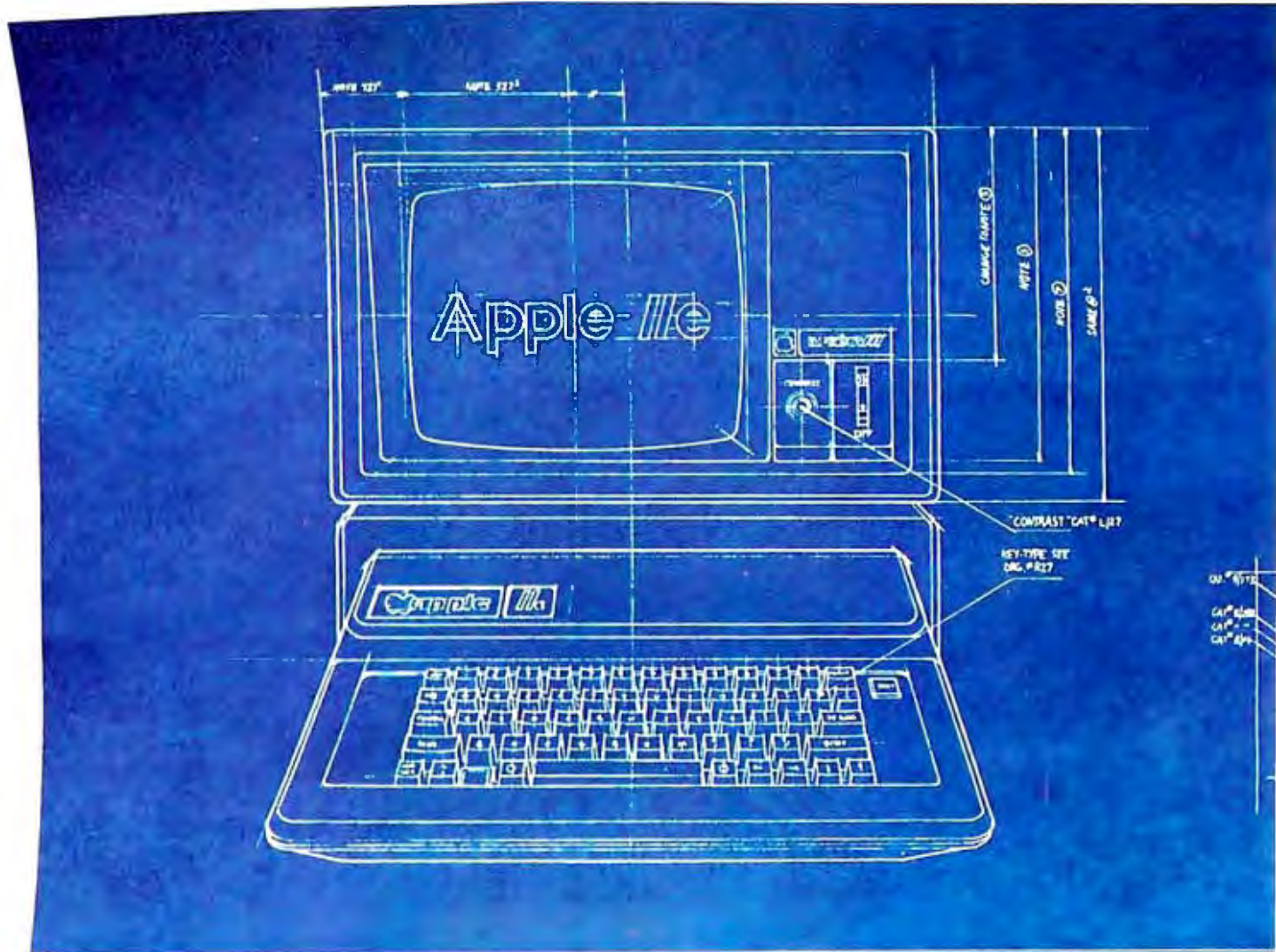

For years, people have been trying to build a better Apple® II. It finally happened.

Meet the Apple IIe, an impressive new version of a most impressive machine.

The "e" means enhanced. Which means a bundle of new features:

A standard memory of 64K (versus 48K) that's easily

expandable. So you can create fatter files and crunch larger numbers of numbers.

A new, improved keyboard, with a complete set of ASCII standard characters. Plus full cursor controls, programmable function keys, and a rapid auto-repeat feature built into every key on the board.

Both upper and lower case

characters. (And if you want to see more of them on the screen at one time, a low cost 80-column text card is available.)

Improved peripheral ports. Which make it a lot easier to connect and disconnect game controllers, printers and all those other wonderful things that go with an Apple Personal Computer.

Except for the front, back and inside.

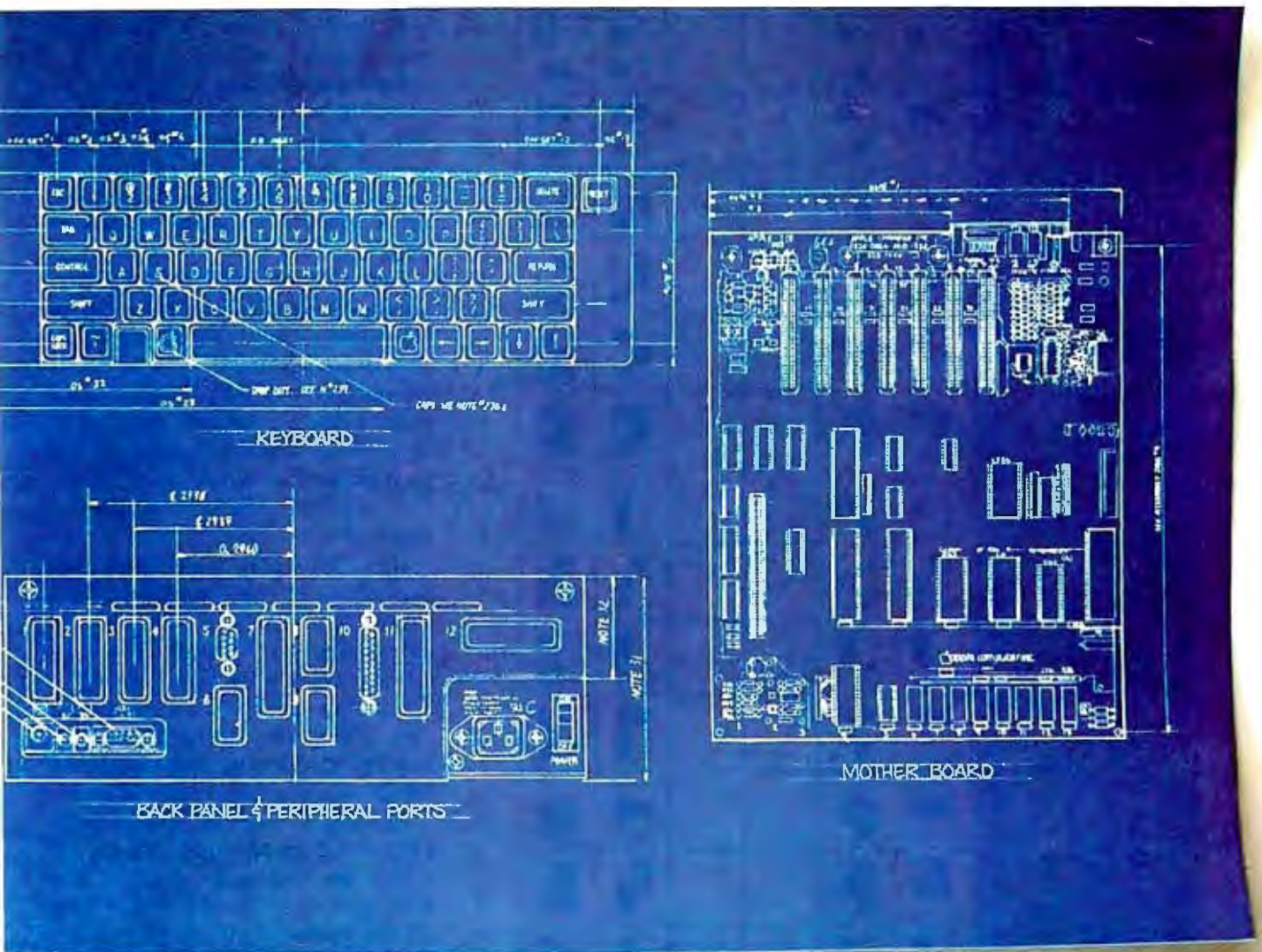

Self-diagnostics. That's a special feature that makes it easy to give your computer a thorough check-up.

Plus an even more reliable design. Achieved by reducing the number of components — which is to say, the number of things that could go wrong.

And bear in mind, the IIe still has all those other virtues that made the Apple II so very popular. Including access to more accessories, peripheral devices and software than any other personal computer you can buy.

So visit any of our over 1300

authorized dealers, and see the newest Apple for yourself.

Like the original, it's rather extraordinary. But then some things never change.



The most personal computer.

Circle 26 on Inquiry card.

					b ₆	0	0	1	1	1	1
					b ₅	1	1	0	0	1	1
					b ₄	0	1	0	1	0	1
						2	3	4	5	6	7
b ₃	b ₂	b ₁	b ₀								
0	0	0	0	0							
0	0	0	1	1							
0	0	1	0	2							
0	0	1	1	3							
0	1	0	0	4							
0	1	0	1	5							
0	1	1	0	6							
0	1	1	1	7							
1	0	0	0	8							
1	0	0	1	9							
1	0	1	0	10							
1	0	1	1	11							
1	1	0	0	12							
1	1	0	1	13							
1	1	1	0	14							
1	1	1	1	15							

Figure 17: The Mosaic Set.

two smaller sets. The first 32 characters are graphics operation codes. These op codes are used to specify text control, drawing primitives, and color control.

The 64 codes in the right four col-

umns of the PDI G-set are used to encode data for these op codes. These data bytes are encoded and interpreted according to the preceding op code. Six bits are available for information in each byte. Many of the op

codes require multiple data bytes to encode one data item. Coordinates, for example, are typically encoded in 3 consecutive data bytes.

As shown in figure 20 on page 250, this distinction of op codes and data within the PDI G-set leads to a convenient decoding structure. Once it has been determined that a code falls in the PDI set, bit 6 (the seventh from the right) can be used to determine if an op code is specified or data. If bit 6 is 0, the byte is interpreted as an op code; if it is 1, it is a data byte.

Such a distinction is necessary because the picture-description instructions have been set up so that a *variable* amount of data can follow an op code. The bytes following the op code are assumed to be data as long as bit 6 is a 1.

Figure 21 on page 250 illustrates how text, graphics, and color can be integrated to draw a simple picture. Approximately 180 bytes of NAPLPS were needed to specify this picture. In parts 2 and 3, we will describe in detail how graphics commands for such pictures are encoded.

Control

Up to this point, the emphasis has been on the 96-character G-sets. Two C-sets (control sets), C0 and C1, are also specified in NAPLPS. These control sets contain the codes needed to accomplish the G- and C-set swapping. They also contain codes for moving the cursor, controlling the DRCS, clearing the screen, and so on.

Figure 22 on page 252 illustrates the C0 and C1 control sets. The C0 set should be familiar to those of you who have worked with ASCII. The C1 set contains a variety of codes associated with the new features of NAPLPS.

A mechanism has been provided, but not used, that allows C-sets to be changed like G-sets. The C-sets were originally going to be used whenever a small (fewer than 32) number of similar codes were added to NAPLPS. As it turns out, the 96-character G-sets have proven to be more useful. The C-sets have ended up becoming a catchall for codes that do not seem to "fit" (either physically or logically) anywhere else. This

The UniFLEX™ Operating System extracts



every last drop

from the 8 bit 6809 microprocessor allowing it to outperform many 16 bit systems

With the UniFLEX™ Operating System, the 8 bit 6809 microprocessor can perform as well as larger CPUs in a multi-user, multi-tasking environment.

Independently developed from the ground up, UniFLEX™ closely models the features found in the UNIX™ Operating System. And in two years of use, UniFLEX™ has proven the abilities of the 6809 to perform large system functions when incorporated into a properly designed mainframe.

Some of the features supported include:

- full multi-user, multi-tasking capabilities
- hierarchical file systems
- device independent I/O
- four Gigabyte disk capacities
- full file protection
- inter-task communication via pipes
- I/O redirection
- task swapping for efficient memory usage
- full random-access files
- comprehensive shell command language
- foreground-background jobs
- electronic mail and printer spooling
- system accounting facilities

The support software currently available for use under UniFLEX™ is extensive. A sampling of the programs available includes:

- native C compiler (full implementation)
- native Pascal compiler
- FORTRAN 77 ANSI Subset compiler
- COBOL compiler with ISAM files, Report Writer & Sort/Merge
- Extended BASIC interpreter
- Extended BASIC precompiler
- text editing and processing software
- enhanced printer spooler
- variety of absolute and relocatable assemblers
- debug and diagnostic packages

Technical Systems Consultants, Inc. also offers a line of single user FLEX™ software products for 6800 and 6809 processors. For those having an absolute need for a 16 bit processor, UniFLEX™ will be available through OEM licensing arrangements for the 68000 microprocessor. Please call or write for additional information on individual products or OEM licensing arrangements.

UNIX™ is a trademark of Bell Laboratories.
FLEX™ and UniFLEX™ are trademarks of Technical Systems Consultants, Inc.

 technical systems
consultants, inc.

111 Providence Road
Chapel Hill, North Carolina 27514
(919) 493-1451

SCALING

THIS IS WORD
WRAP

THIS IS NOT WO
RD WRAP



Proportional Spacing

ROTATION

P
CHARACTER
T
H

CURSOR CONTROL

Figure 18: Some examples of the text and Mosaic features of NAPLPS.

compromise was not desired, but compromises such as this occur frequently when standards are being developed.

User Input

Because of the heavy emphasis on text and graphics in NAPLPS, the *user-input* features are often

overlooked. User input is needed to allow a terminal user to enter information that will eventually be sent to the central host computer. This input could be used to request information from a database, order products, schedule an airline reservation, or send electronic mail.

User input has been integrated with

the rest of NAPLPS in an elegant manner. Certain areas or fields of the unit screen can be designated as user-input areas. These areas are called *unprotected fields*.

The user can enter information into the unprotected fields using a variety of input devices such as keyboards, light pens, joysticks, graphics tablets, and even a "mouse." Information entered in the fields is stored as NAPLPS data. The user must eventually indicate (usually via a Send key) that all the information has been entered and should be sent to the host.

When the host computer receives the block of information, it may or may not decode it, depending on the application. For example, a graphics electronic-mail message would merely be sent to the appropriate addressee and would not have to be decoded.

The text of a message does not have to be entered on rigid lines as in most terminal systems. In applications such as electronic mail, a user who



A Complete Winchester/Floppy Disk System.

- Disk controller with 4 ports; supports wide range of drives; 5¼" and 8" drives can be on same cable.
- Z80 CPU includes 4MHz, 64KRAM, 2 serial I/O, 1 parallel, CTC.
- Supports 10MB streaming tape. CP/M® and BIOS included.
- Package price: \$1,195.00.
May be purchased separately. Disk and streaming drives available.

SIGEN Corporation

1800 Wyatt Dr., #6, Santa Clara, CA 95054
Contact: Allen Hauptman, 408/988-2527
CP/M is a trademark of Digital Research.

BDOS ERROR ON B:BAD SECTOR

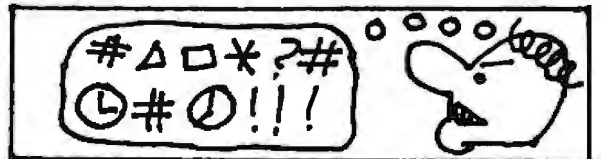

Before disk errors ruin your work again order BADLIM.

- BADLIM assures the reliability of your CP/M computer.
- You can use your disks 10 times longer without losing your data AND your time.
- BADLIM checks thoroughly your disk marking all the blocks which have defective sectors. The operating system will know that those sectors should be skipped.
- BADLIM is the only program that gives protection for soft and hard errors.
- The first time BADLIM will list which files in your disk are on bad sectors, so you can take action to correct it.
- But thereafter the bad areas in your disk will be automatically by-passed.
- For CP/M 1.4 single density and for CP/M 2.xx of any format and density. It is a must for Winchester as the media cannot be replaced.

BADLIM cost only \$73. Whatever the reason you have to use a computer you need BADLIM. Contact your dealer or call us today:

BLAT R&D Corp., 8016 188th. St SW, Edmonds
WA 98020. Phone: [206] 771-1408

DEALER INQUIRIES INVITED. **BADLIM**

TCS Heart of TEXAS COMPUTER SYSTEMS

LEADER in MAIL ORDER DISCOUNTS!

800 433-5184

Texas 817/274-5625

IBM Personal Computer

INTERNAL DISKS FOR IBM
Complete IBM Disk Systems \$CALL
Tandon Internal Disk .. single sided 180k
Tandon Internal Disk .. double sided 320k

HARD DISKS FOR IBM
Complete 5 meg. Systems ... from \$1588
Multi-computer Network Systems available

MONITORS FOR IBM
Green - hi resolution from \$89
Matching PGS Color - super hi res. \$CALL

QUADBOARD FOR IBM
Includes 64k to 256k additional Memory,
Serial & Parallel Port and Calendar Clock

ADDITIONAL MEMORY FOR IBM
16k Chips each \$2
64k Chips \$CALL

PRINTER FOR IBM
Epson, Star & other matrix printers . \$CALL
NEC 3550 Spinwriter IBM version .. \$CALL

ATARI

ATARI 800 COMPUTER
ATARI 810 DISK DRIVES
Percom Double Density EXT. DRIVES
ATARI 850 interface and Cable
Compatible PRINTERS and Cables

APPLE

First DISK DRIVE w/controller, DOS 3.3,
cables and manual \$419
Second DISK DRIVE with cable \$319
APPLE to EPSON card and cable

Z 80 Card \$CALL
RAM Card \$CALL
Printer Interface Cards \$CALL
Graphic Printer Interface Card \$139
Graphic Spooler Interface Card/16k to 64k

TRS-80

TCS MODEL III 48k 2 DISK

Systems come with 180 day TCS limited warranty.



\$1695

With standard 40 track double density drives. Over 340,000 bytes. Includes TDOS.

\$1995

With 2 dual headed 40 track dbl. density drives. Over 730,000 bytes. Includes DOSPLUS 3.4 (\$150 value)

Fully assembled and tested systems that are software compatible and functionally identical to Radio Shack units sold at computer stores for \$hundreds more.

- CONTROLLER BOARDS are high quality double sided epoxy boards with gold plated contacts.
- POWER SUPPLY is the finest switching type available.
- MOUNTING HARDWARE includes power and data cables.
- DISK DRIVES are Tandon, the same ones used by Radio Shack ... 40 track, double density, with a 5 millisecond stepping rate.

TANDON DRIVES

TCS DRIVE CABINET is Industrial grade heavy gauge metal, safety fused, and comes with gold plated external connector with extender cable.

2 DRIVES/Double Cabinet

40 track single sided \$489
80 track (dual sided 40 tracks) \$539
180 track (dual sided 80 tracks) \$849

Drives in cabinets come assembled/tested with power supply. Order cable separately.

1 DRIVE in Cabinet

40 track single sided \$249
80 track (dual sided 40 track) \$329
180 track (dual sided 80 track) \$449

1 DRIVE/Double Cabinet

40 track single sided \$269
80 track (dual sided 40 track) \$369
180 track (dual sided 80 track) \$499

BARE DRIVES ONLY

40 track single sided \$CALL
80 track (dual sided 40 track) \$CALL
180 track (dual sided 80 track) \$CALL
8 inch Slimline sgl/dbl sided \$CALL
Winchester hard drives 5-30 meg. \$CALL

TCS MODEL III DISK EXPANSION KITS

- | | |
|--|--------|
| 1 Controller, Power Supply, Mounting Hardware & Instructions | \$379 |
| 2 Controller, Power Supply, Hardware & one 40 track Tandon drive | \$577 |
| 3 Controller, Power Supply, Hardware, two 40 track Tandon drives, 32k memory (everything you need for 2 drive 48k upgrade) | \$799 |
| 3a Kit 3 but with two 80 track drives (dual sided 40s) | \$999 |
| 3b Kit 3 but with two 180 track drives (dual sided 80s) | \$1189 |

CORVUS HARD DISK

CORVUS HARD DISKS

Call for '83 prices - lowest anywhere

Add 5, 10 or 20 megabytes of storage to your TRS80, IBM, Apple, Atari, Heath, Zenith, Intertec, S-100 and many others. One or several computers can share a hard disk. Get simultaneous access to data for multiple users. AVAILABLE NOW at SUPER SAVINGS.

PRINTERS

TCS has the LOWEST PRICES on IN STOCK PRINTERS!

LETTER QUALITY PRINTERS

STAR GEMINI
Better than Epson and costs less!
100 cps .. 180 day warranty
Bit Image AND Block Graphics
Friction Feed and Pin Feed paper

STAR GEMINI 10 (10 Inch carriage) \$CALL
STAR GEMINI 15 (15 inch carriage) \$CALL
C.I.TOH 8510 / TEC / PMC \$CALL
DMP 100 \$349
DMP 200 \$689
DMP 400 \$1029
DMP 500 \$1584
ANADEx 9501-A \$1395
CENTRONICS 352 / 353 \$CALL
OKIDATA printers .. \$CALL for Low Prices

MATRIX PRINTERS

C.I.TOH F-10 (40 cps) \$1595
DAISY WHEEL II (RS) \$1695
NEC 3510 / 3530 / 3550 \$CALL
NEC 7710 / 7730 \$CALL
SMITH CORONA TP-1 \$649
BROTHER / COMREX \$829

EPSON PRINTERS

EPSON MX 80 \$CALL
EPSON MX 80 FT \$CALL
EPSON MX 100 FT \$CALL

GRAPHTRAX PLUS come free in EPSONS

Cables and interfaces available for most popular computers

MODEL III SYSTEMS

Original 90 day manufacturer's warranty.

MODEL III 4k \$598
MODEL III 16k \$CALL
MODEL III 32k \$CALL
MODEL III 48k \$CALL
MODEL III 48k 2 Drive RS232 \$CALL

COLOR COMPUTER

Original 90 day manufacturer's warranty.

COLOR COMPUTER 16k \$249
COLOR COMPUTER 16k ext \$335
COLOR COMPUTER 32k ext \$478
COLOR COMPUTER DISK 0 \$CALL
COLOR COMPUTER DISK 1 \$349

TCS MODEL III Systems use original RS hardware and quality TCS memory. 180 day limited warranty.

TCS MODEL III 16k \$CALL
TCS MODEL III 32k \$798
TCS MODEL III 48k \$628

Green or Amber Langley Sinclair CRT for your customized Model III \$CALL

TCS COLOR COMPUTERS use original RS hardware & TCS memory. 180 day warranty.

TCS COLOR COMPUTER 32k ext .. \$379
TCS COLOR COMPUTER DISK 0 .. \$449
TCS COLOR COMPUTER DISK 1 .. \$249
TCS 32k MEMORY \$79

Model II .. Model 16 .. Accessories .. \$CALL

TCS is an authorized TRS-80 dealer F701 in Brady, Texas

DEALER INQUIRIES invited on all TCS MODEL III Systems and Kits

CUSTOM SOFTWARE FROM TCS

BTREE Scratchpad \$39.95 BTREE Library \$39.95 BTREE Mail List \$49.95

TCS Exclusive THE PRODUCER \$149.95

The ultimate solution in creating your own custom software. If you're in a jam and can't find a program to fit your needs, use this fast and simple Program Development System to tailor make a solution to your problem. Custom design your own screen format with complete control over the number of characters assigned to each field. Fully view and edit all fields at all times. Create a B-Tree structured file allowing you to access data rapidly and without sorting. One key access to user-designed self-help or prompt information. Expand your program to support up to 8 calculations for each data field. AND MUCH MUCH MORE.

This system comes complete with its own Disk Operating System. It will make you a master of your software needs without hiring a programmer. Or if you are a programmer, this system will save you hundreds of hours in design work for your clients. Saving time is saving money!

WRITE FOR FREE BROCHURE ON TCS PROGRAM GENERATOR

For fast, efficient service **Heart of** we can air freight from Dallas

TEXAS COMPUTER SYSTEMS

P.O. Box 1327 Arlington, Texas 76004-1327

TEXAS ORDERS 817/274-5625

TECHNICAL ASSISTANCE 817/274-9221

ORDER STATUS 817/277-1913

TELEX/TWX/Easylink ELN 62100790



800 433-5184

No tax out of state. Texans add 5%. Prices subject to change at any time.

DISTINCTIVE for the IBM PC



A Serious Monthly Magazine for the IBM PC User

Each issue is packed with in-depth hardware & software reviews, detailed how-to articles, reader tips, Q & A, special interest columns and much more...clearly written for either novice or computer veteran.

In Recent Issues:

- A Primer on Modems.
- Legal Rights of Software Buyers.
- How to make your BASIC programs run faster.
- Word Processing from A-Z.
- BASIC v. Pascal: Which is for you?
- How to Program your Printer for maximum performance.
- Free Utility Programs

**DON'T MISS ANOTHER
EXCITING ISSUE—
SUBSCRIBE NOW!**
12 Colorful issues \$24.00

CALL TOLL FREE:

800-824-7888 operator 77
California only
800-852-7777 operator 77



WELCOME!
Or we'll bill you.

For more info & foreign rates, write:

Personal Computer Age

10057 Commerce Ave.
Tujunga, CA 91042

					b ₆	0	0	1	1	1	1
					b ₅	1	1	0	0	1	1
					b ₄	0	1	0	1	0	1
						2	3	4	5	6	7
b ₃	b ₂	b ₁	b ₀								
0	0	0	0	0	RESET	RECT (OUT-LINED)	NUMERIC DATA				
0	0	0	1	1	DOMAIN	RECT (FILLED)					
0	0	1	0	2	TEXT	SET & RECT (OUT-LINED)					
0	0	1	1	3	TEXTURE	SET & RECT (FILLED)					
0	1	0	0	4	POINT SET (ABS)	POLY (OUT-LINED)					
0	1	0	1	5	POINT SET (REL)	POLY (FILLED)					
0	1	1	0	6	POINT (ABS)	SET POLY (OUT-LINED)					
0	1	1	1	7	POINT (REL)	SET & POLY (FILLED)					
1	0	0	0	8	LINE (ABS)	FIELD					
1	0	0	1	9	LINE (REL)	INCR POINT					
1	0	1	0	10	SET & LINE (ABS)	INCR LINE					
1	0	1	1	11	SET & LINE (REL)	INCR POLY (FILLED)					
1	1	0	0	12	ARC (OUT-LINED)	SET COLOR					
1	1	0	1	13	ARC (FILLED)	WAIT					
1	1	1	0	14	SET & ARC (OUT-LINED)	SELECT COLOR					
1	1	1	1	15	SET & ARC (FILLED)	BLINK					

Figure 19: The operation codes (or op codes) of the Picture-Description Instruction (PDI) G-set. The four columns on the right (that is, bits 0 through 5) are used as data for various op codes.

RANDOM ACCESS IN A PRINTING BUFFER?

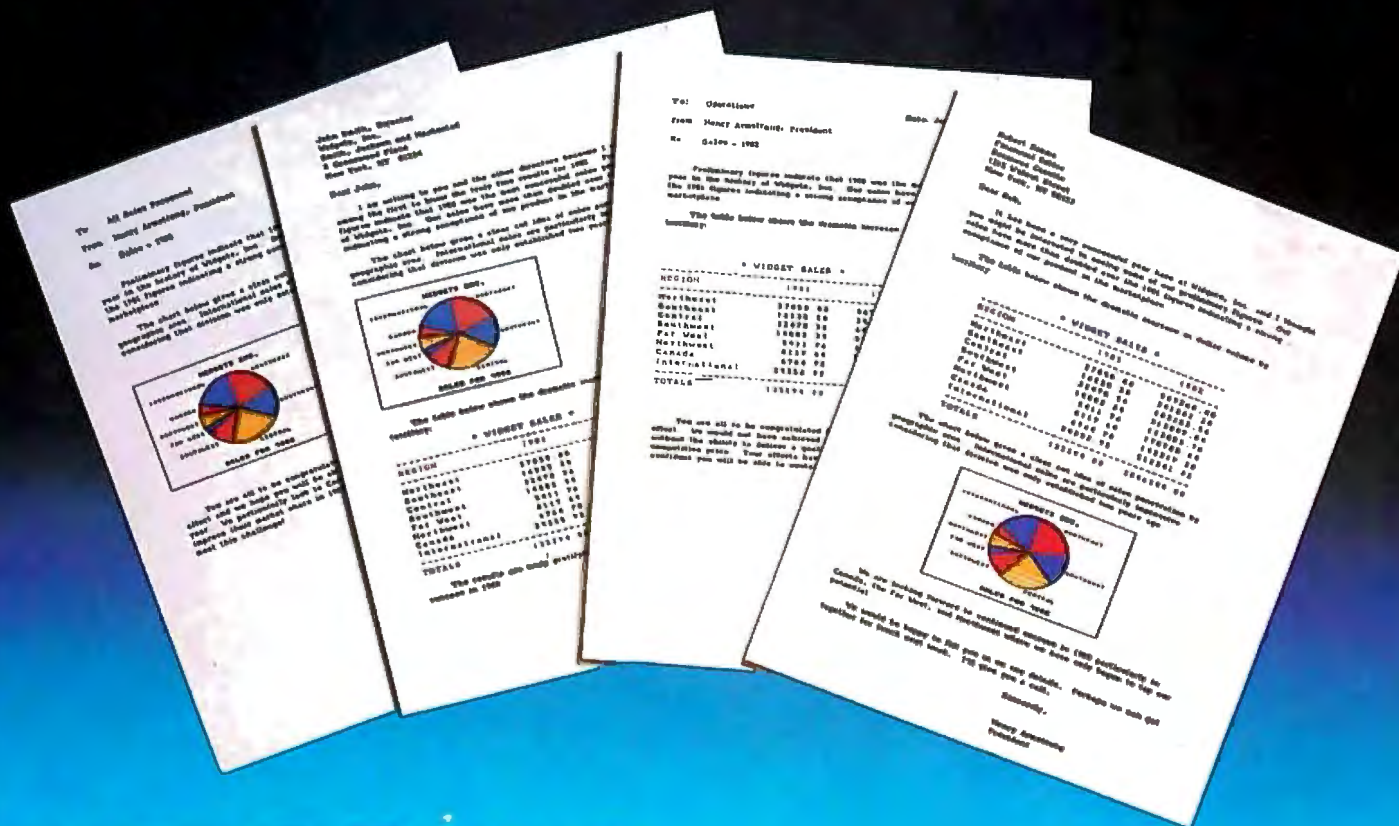

YES!

Introducing . . . The IS PipeLine™ Random Access Printing Buffer.

Insert pictures, graphics or spread-sheet data into reports. Duplicate form letters—automatically changing addresses on each. Now, all your programs can work together to produce printed output.

For the first time ever, here is a buffer that not only frees your fast computer from your slow printer but also allows you to rearrange, compose and copy your data on its way to the printer.

- Random Access Printing—stores paragraphs or pictures for printing in any order—any number of times.
- FIFO Printing—conventional first-in first-out operation.
- Compression of data for efficient utilization of memory space.
- Ability to interrupt long-term buffer operations for straight-thru short-term printing.
- Simple Erase feature to clear buffer.
- Automatic duplication capability.
- Easily expandable, by you, from 8K Bytes to 128K Bytes.

The IS PipeLine is Universal—it works with any parallel (Centronics®—style) computer/printer combination. A special version is available for PKASO™ Printer Interfaces.

The IS PipeLine is a self-contained unit with operating manual, cables and power supply included.

For more information on the truly revolutionary IS PipeLine Random Access Printing Buffer, call us today.



Interactive Structures Inc.
146 Montgomery Avenue
Bala Cynwyd, PA 19004
Telephone: (215) 667-1713

*Centronics is a trademark of Centronics Data Computer Corp.

Circle 213 on Inquiry card. The IS PipeLine™ Random Access Printing Buffer is patent pending.

A NEW CONCEPT IN STATIC CONTROL

YOU'LL NEVER A "NAKED"

A "naked" computer is any computer that sits on a bare table or desk top, without a **TouchMat™** static dissipative table mat directly under it.

"NAKED" COMPUTERS ARE VULNERABLE to some of the most frustrating static-related problems a computer user can encounter — erratic or erroneous data transmission, loss of programs or data, damage to discs or accessory cards, component failure, or "unexplained" down time.

During the dry winter heating season, you are probably more aware of static electricity because you can *feel* it. However, your computer is vulnerable to a much smaller ZAP than you can possibly feel, and that level of static may occur at *any time of the year*. Even air conditioning can aggravate the problem by drying the air.

IT ONLY TAKES ONE ZAP to make your perfectly logical computer act irrational and temperamental. Experienced computer users know that static electricity cannot be completely eliminated from the environment or the microcomputer, since *people* are prime generators of static. The best solution is to channel static charges harmlessly away before they have a chance to spark to sensitive components and accessories.

Discharging to a metal object, however, may provide a false sense of security, as static charges are easily built up again as a person moves around at the computer. Also, metal may create a potentially hazardous or annoying "hard spark." (You know... ZAP...OUCH!)

THE TOUCHMAT SITS ON THE TABLE, directly under the computer, within easy reach of your hands and fingers. To discharge static from your body, simply touch mat before turning on computer, and then periodically during operation.

Discharging takes less than a second, does not produce a spark, and is absolutely assured by the simple fact that your skin contacts the mat directly. (The sweat layer of the human skin is a primary conductor of electricity.) Anytime your hands or wrists rest on the mat, static discharge is automatic.



TouchMat™ INSTEAD.



The TouchMat is made of a highly-engineered, 3-layer vinyl material that "pulls" static off your body without hard sparking, and then dissipates it through the mat at the optimum rate, draining it safely to ground via a grounding cord. The static dissipation rates of the material have been extensively tested and field-proven during years of use in critical static control applications for military/electronics manufacturing. (Remember, the "chips" inside your computer were even **more** sensitive to static during manufacture.)

TOUCH COMPUTER AGAIN!

A DRAMATIC IMPROVEMENT OVER CONDUCTIVE FLOOR MATS, the TouchMat does not require users to wear leather-soled shoes for effective static discharge. A floor mat may be rendered virtually ineffective by today's popular synthetic and rubber-soled shoes, which insulate the user.

THE BEST THING NEXT TO YOUR COMPUTER, the cushioning material of the TouchMat also serves to dampen noise and vibration, and prevents your computer from sliding around on the desktop. Available in a computer-compatible beige, 24" x 26", it accommodates all popular micros.

IF YOU'RE UNCOMFORTABLE NOW, ABOUT YOUR "NAKED" COMPUTER — you should be. Static problems cost you time and money. Prudent computer users in offices, homes and schools everywhere are protecting their computer investment with a TouchMat.

PUT STATIC CONTROL AT YOUR FINGERTIPS!

Save \$10 off the suggested retail price of \$89. Take this coupon to your computer store or office supply dealer and ask for the TouchMat by name. For the name of your nearest TouchMat dealer, call toll-free:

1-800-328-0223 outside Minnesota only.
(Minnesota residents call collect (612) 430-2062.
Twin Cities area dial direct.)

If not yet available in your area, you may order direct for a limited time only. Allow 4-6 weeks for delivery. Visa and MasterCard accepted. Shipping and handling charges extra.



Dealer inquiries welcome.

SPECIAL INTRODUCTORY OFFER

Save \$10 on the TouchMat!

To the retailer: Computerware Inc. will reimburse you for the face value of this coupon plus 20¢ for handling if you receive it on the sale of the specified product and if upon request you submit evidence of purchase of sufficient stock to cover coupons presented. Coupon may not be assigned, transferred or reproduced. Customer must pay any sales tax. Void where prohibited, taxed, or restricted by law. Good only in U.S.A. Coupon will not be honored if presented through outside agencies, brokers or others who are not retail distributors of our merchandise or specifically authorized by us to present coupons for redemption. Mail to: Computerware Inc., 315 South Third Street, Stillwater, MN 55082, 800-328-0223. (612) 430-2060 Minnesota.
*outside Minnesota only

This coupon good only on purchase of product indicated. Any other use constitutes fraud and may void all other coupons submitted for redemption.

LIMIT — ONE COUPON PER MAT.

Offer expires March 31, 1983.

Store Coupon B654321



TouchMat is a trademark of, and is manufactured exclusively by: **Computerware Inc.**

315 South Third Street
Stillwater, Minnesota 55082
(612) 430-2060



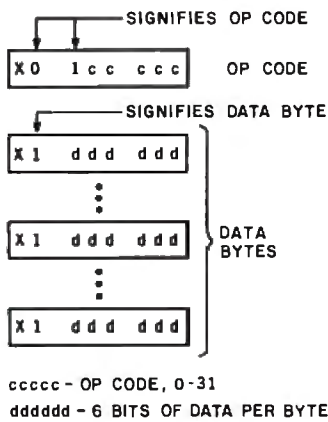

Figure 20: In the PDI G-set of NAPLPS, op codes are distinguished from data bytes by bit 6. If bit 6 is 0, the byte is an op code; otherwise, it is a data byte.

has the appropriate input device can even send *handwritten* messages using NAPLPS as the encoding mechanism.

The best analogy to describe user input in NAPLPS is to imagine that the user is handed one or more blank sheets of paper. (When the three-

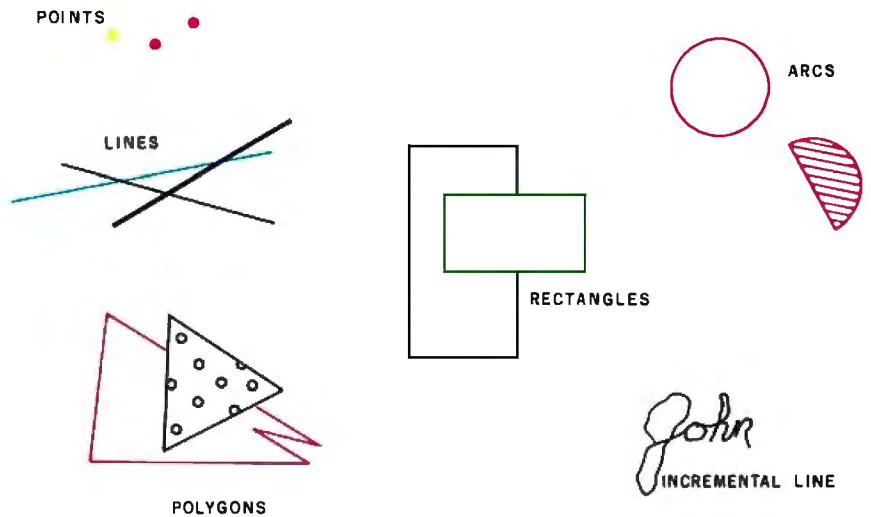

Figure 21: Some examples of pictures that can be created with NAPLPS instructions. Approximately 180 bytes would be used to encode the entire figure. The signature alone requires 51 bytes.

dimensional mode is supported, the user will be given an empty box.) The user is able to type on the paper, draw a sketch on the paper, or do anything that his or her terminal allows.

The "paper" is eventually passed to a host computer, where it can be for-

warded to another user (electronic mail), stored for later recall, or analyzed by the host. The analysis by the host can be minimal or extensive, again depending on the application.

At this point, remember that NAPLPS is only a sixth-level specification in a seven-level model.

Get the best of your first micro.

There's an easier way.

It's called dBASE II™, a relational database management system that uses powerful, English-like commands.

With a word or two, you *create* databases, *append* new data, *update*, *modify* and *replace* fields, records and entire databases. *Display* any information, *report* months worth of data in minutes and *zip* through input screens and output forms.

You can use it interactively and get your answers right now. Or save your instructions and repeat everything with two words: *do Manhours*, *do Project X*, *do* whatever has to be done.

It's being used for accounting, project management and hundreds of other applications.

To try dBASE II free for 30 days, drop by your local computer store. Or if they're sold out, call us at (213) 204-5570. If you don't like it, you get your money back.

But we think you'll keep it.

Because having dBASE II is like having a black belt in micros.



Ashton-Tate

© 1982 Ashton-Tate
CP/M is a trademark of Digital Research

Deciding Which Computer to Buy

Of the 1.9 million people who bought small computers last year, over 20,000 of them bought the wrong computer for their needs. And no wonder. New products are introduced into the market at a breathtaking pace. The language question. The terminology problem -RAMs, ROMs, bits, bytes, bauds, protocols and processors. What's important? What's standard and what's optional? Even the dealers are confused.

To help you tackle this problem, we pulled together many of our sources -including leading experts in the field, manufacturers, marketing analysts, computer dealers and customers. In addition, we utilized computer user groups, clubs and associations throughout the United States, contacts in Japan and numerous industry and business publications. **COMPUTER GUIDE 1983** is the natural result of learning from the knowledge and mistakes of more than one million people.

The following steps will help you with your computer shopping -whether you're buying your first computer, or updating the one you have. **COMPUTER GUIDE 1983** can help you make the right decision.

1. What is the computer to be used for?

You may want to use it for entertainment, financial planning, learning how to speak a foreign language, office work, drawing and many other tasks a computer does well. The possible uses of a computer are as varied as human activities.

2. Which program will do the best job?

There are thousands of application programs on the market to consider. It is the program that gives you the power to control the actions of the computer. You must choose the right application program.

The first section of **COMPUTER GUIDE 1983** surveys each of the application programs available with computers today. Similar programs are grouped together and compared -one against another. **COMPUTER GUIDE 1983** contains over 2,000 application programs, grouped in over 100 categories -including programs for accounting, management, professional uses, word processing, graphics, research, games, learning and special applications. Programs are described using comparison charts -listing for each application program: the program name, computer(s) and system configuration(s) required, the documentation available and the price.

COMPUTER GUIDE 1983 provides you with a quick and efficient way of deciding which application program and which computer and options for that computer can do the right job for you.

3. The language?

You cannot get a computer to do anything useful unless you know how to talk to it. This is no easy task. But, **COMPUTER GUIDE 1983** can help.

The second section of **COMPUTER GUIDE 1983** guides you in selecting the right language. Different dialects of languages are grouped in their generic category. The BASIC language, for example, is a generic name and has many dialects -including Microsoft Basic, Atari Basic, Basic Plus and Basic-80.

Each of these languages have their own machine requirements. **COMPUTER GUIDE 1983** provides the name, machine and machine requirements, documentation and price of over 500 dialects, for over 50 languages. **COMPUTER GUIDE 1983** helps you solve the language problem.

4. What about the machine?

Depending on your needs, there will probably be several computers still in the running. Now the decision is based on the guts of the machines (hardware). **COMPUTER GUIDE 1983** compares machine characteristics in an easy to follow format. You don't have to be an electrical engineer to make an intelligent decision.

The solution is to work top down and not to go any further down than is needed. Your uses for the computer determines which machine characteristics are important. **COMPUTER GUIDE 1983** divides the machine into five areas -the keyboard, video display, printer, other peripherals and I/O, processor and memory and direct access storage. These five areas correspond to your basic machine needs. For example, an accountant needs a keyboard with a numeric keypad; word processing requires a printer; games utilize a video display; a mathematician wants a very fast machine; lots of memory is best when using the LISP language; and so on, as the hardware combines with the application program to develop a complete computer system.

COMPUTER GUIDE 1983 contains machine descriptions for over 250 computer systems, produced by over 150 manufacturers. Information is displayed in spreadsheets -allowing you to get the information you need. You don't have to bother with extraneous details and cumbersome text. **COMPUTER GUIDE 1983** can accommodate millions of people in making the right decision, as varied as those decisions will be.

5. Where to buy the chosen computer system.

COMPUTER GUIDE 1983 lists hundreds of vendors, by geographical location, and by the products they sell. It also provides additional consumer information. The first ship date, the ship rate, the number installed to date, prices and what that includes, purchasing terms and warranties. **COMPUTER GUIDE 1983** contains the names, addresses and phone numbers of hundreds of manufacturers, dealers and stores throughout the United States.

No one wins when you buy the wrong computer or computer product. Make the right decision. Use **COMPUTER GUIDE 1983**.

Send me **COMPUTER GUIDE 1983**

The complete computer buyer's guide.

*I'm enclosing my check for \$32.75 plus \$1.50 for shipping.
(Mass. residents add 5% sales tax.)*

Mail to: **CESS**
P.O. Box 345, MIT Branch P.O.
Cambridge, MA 02139
(617) 491-8925

Name _____

Address _____

City, State and Zip _____

Please allow six to eight weeks for delivery.

COMPUTER GUIDE and CESS are trademarks of Computer & Electronic Supply Services. P.O. Box 345, MIT Branch P.O. Cambridge, MA 02139.

					b7	0	0
					b6	0	0
					b5	0	0
					b4	0	1
b3	b2	b1	b0		0	1	
0	0	0	0	0	NUL	DLE	
0	0	0	1	1	SOH	DC ₁	
0	0	1	0	2	STX	DC ₂	
0	0	1	1	3	ETX	DC ₃	
0	1	0	0	4	EOT	DC ₄	
0	1	0	1	5	ENQ	NAK	
0	1	1	0	6	ACK	SYN	
0	1	1	1	7	BEL	ETB	
1	0	0	0	8	APB (BS)	CAN	
1	0	0	1	9	APF (HT)	SS ₂	
1	0	1	0	10	APD (LF)	SUB	
1	0	1	1	11	APU (VT)	ESC	
1	1	0	0	12	CS (FF)	APS	
1	1	0	1	13	APR (CR)	SS ₃	
1	1	1	0	14	SO	APH	
1	1	1	1	15	SI	NSR	

					b7	1	1
					b6	0	0
					b5	0	0
					b4	0	1
b3	b2	b1	b0		8	9	
0	0	0	0	0	DEF MACRO	PROTECT	
0	0	0	1	1	DEFP MACRO	EDC ₁	
0	0	1	0	2	DEFT MACRO	EDC ₂	
0	0	1	1	3	DEF DRCS	EDC ₃	
0	1	0	0	4	DEF TEXTURE	EDC ₄	
0	1	0	1	5	END	WORD WRAP ON	
0	1	1	0	6	REPEAT	WORD WRAP OFF	
0	1	1	1	7	REPEAT TO EOL	SCROLL ON	
1	0	0	0	8	REVERSE VIDEO	SCROLL OFF	
1	0	0	1	9	NORMAL VIDEO	UNDER LINE START	
1	0	1	0	10	SMALL TEXT	UNDER LINE STOP	
1	0	1	1	11	MED TEXT	FLASH CURSOR	
1	1	0	0	12	NORMAL TEXT	STEADY CURSOR	
1	1	0	1	13	DOUBLE HEIGHT	CURSOR OFF	
1	1	1	0	14	BLINK START	BLINK STOP	
1	1	1	1	15	DOUBLE SIZE	UNPROTECT	

Figure 22: The two control sets used in NAPLPS.

NAPLPS merely provides a vehicle for the seventh level (commonly called the application level) that comprises the application programs and software (e.g., a banking program)

that will run on NAPLPS. Many special applications can be developed and standardized at level 7 using NAPLPS as a foundation. These applications may be very specialized

and might use only a subset of NAPLPS.

When we discuss user input, it should be noted that NAPLPS was *not* developed as a standard to be used for massive amounts of data entry in large data-processing centers. NAPLPS was developed to be used by people at home, at work, and at play. It was designed to be elegant and free-form.

NAPLPS was designed in this manner based on the assumption that most people do not want to interact with computers in robot-like ways. People will enter data by looking at menus and pointing to selections, rather than learning some complex command syntax. As we mentioned earlier, with a graphics tablet or other digitizer, people will even be able to input handwritten messages. Studies have shown that people want as much of their personality as possible to be reflected in their communication. And they expect that if they enter something reasonable, that it should be accepted and handled in a reasonable manner.

Macros

Macros (or macroinstructions) are specified in NAPLPS to reduce the amount of data that must be transmitted from the host to the terminal. Macros provide a mechanism whereby a frequently used multibyte string of text and/or graphics can be represented by a single-character macro. If the name of that macro appears later in the incoming data stream, the terminal retrieves the multibyte string and inserts it into the incoming stream in place of the macro name.

Once the string has been inserted into the incoming stream, the terminal processes it as if it had come from the host. Also, nesting of macros is allowed so that one macro can be used to retrieve several other macros. Of course, you must be careful to avoid looping and recursive macros that will endlessly refer to each other.

Ninety-six macro names are available. NAPLPS allows a unique, variable-length string to be stored for each name. Also, macros can be used in two directions: from the host to the

OMEGA



SALES COMPANY

SAVE ON ... COMPUTERS • MONITORS PRINTERS • PERIPHERALS • SUPPLIES*



Amdek Color I Monitor

Our Lowest Price Ever!

\$ 315
OMEGA PRICE
Manufacturers Suggested Retail Price - 449.00

IDS 480 Microprism

NEW "Maisey™" Print Quality

\$ 549
OMEGA PRICE
Manufacturers Suggested Retail Price 699.00

OMEGA SALE PRICED PRINTERS

DIABLO 620	1,259.00
IDS PRISM 132 (COLOR) w/ ACCESS	1,559.00
C-ITOH PROWRITER 8510 AP	459.00
NEC 3510 SPINWRITER	1,499.00
NEC 3550 (IBM)	1,995.00
OKIDATA MICROLINE 83A PRINTER	679.00

MONITOR BARGAINS FROM OMEGA

AMDEK VIDEO 300 MONITOR	139.00
AMDEK COLOR III-RGB MONITOR	399.00
ELECTROHOME 13" RGB HIGH RES.	649.00
NEC JB1201M(A) 12" GREEN MONITOR ...	169.00
USI P-2 12" GREEN MONITOR	159.00
USI P-3 12" AMBER MONITOR	175.00

MODEMS ON SALE THIS MONTH

HAYES MICROMODEM II (APPLE II)	289.00
HAYES SMARTMODEM 300 baud	230.00
SIGNALMAN MODEM (ATARI 850)	85.00
SIGNALMAN MODEM (IBM PC)	159.00

BIG SAVINGS ON ACCESSORIES

MICROSOFT SOFTCARD PREMIUM SYSTEM .	579.00
MICROSOFT 64K RAMCARD for IBM	269.00
ORANGE MICRO GRAPPLER +	120.00
RANA ELITE I w/ CONTROLLER	439.00

UNADVERTISED SPECIALS ON • COMREX • EPSON • ALTOS • SMITH CORONA

- All Equipment Factory Fresh w/ MFT Warranty
- Prices Do Not Include Shipping Charges
- Mass. Residents Add 5% Sales Tax

ACCESSORIES & SUPPLIES

OMEGA Has A Complete Line of Accessories & Supplies for the Apple II and many other Popular Computers by manufacturers like:

- D.C. Hyes • Microsoft • Tymac
- M & R Enterprises • Mountain Computers
- Kensington Microware • Practical Peripherals
- T.G. Products • Videx

SOFTWARE

Omega Carries Software by the following companies:

- American Business Systems • Ashton Tote
- Dakin 5 • Innovative Software • Microsoft
- Sorcim • Stoneware • Visicorp

MAGNETIC MEDIA

OMEGA Stocks Diskettes by:

- Dysan • Elephant • Maxell • Verbatim

CUSTOMER PICKUP NOW AVAILABLE

At Our NEW Location...
334 R Cambridge St., Burlington, Mass.
(617) 229-6464



* PRICES, SPECIFICATIONS AND AVAILABILITY OF ADVERTISED MERCHANDISE SUBJECT TO CHANGE WITHOUT NOTICE

OMEGA SALES COMPANY

334 R CAMBRIDGE STREET, BURLINGTON, MA. 01803

Everybody's Logic Analyzer

12 Channels
16 Words



A logic probe and oscilloscope are no longer adequate for analysis in today's digital world. For testing or debugging microcomputer or other digital logic circuits you need a real logic analyzer.

The LA-12 captures, stores and displays TTL and LSTTL digital data so that the instantaneous meaning of the data stream (e.g. data value, ASCII code, address) can be understood and analyzed long after the actual events have passed.

- Easy to Use ■ 10 MHz ■ Clock Qualifier ■ Trigger input ■ 3 Trigger Qualifiers ■ Built-in LED Display — No oscilloscope needed ■ Compact ■ Expandable ■ Low Cost

30 day trial

Purchase an LA-12, use it, and if you are not completely satisfied, return it within 30 days and receive a full refund.

Free Offer

If you order within 45 days, and mention this magazine, you will receive a \$49.95 input cable free with each LA-12 ordered.

Save \$28.95

In addition, if you enclose payment with your order you can deduct 5% and we will pay shipping charges.

All prices are in US dollars for 120VAC.

To order in the Continental US call

TOLL FREE

1-(800) 228-6505

Connecticut microComputer, Inc.
36 Del Mar Drive, Brookfield, CT 06804
(203) 775-4595 TWX: 710-456-0052

Q	Description	Price	Total
	Logic Analyzer	\$379.00	
	Input Cable	49.95	
	20 Color-coded microclips	44.95	
Connecticut residents add 7½% sales tax			
	Shipping & Handling	\$10.00	
Total			

Company purchase order enclosed (Rated Firms only)

Check VISA MasterCard

Acct. No. _____

Signature _____ Exp. Date _____

Name (Print) _____

Address _____

City _____

State _____ Zip _____

Dealer inquiries invited

NAPLPS CODE

```

DEFINE MACRO 26
  SELECT BLUE
  CLEAR SCREEN
  SELECT WHITE
  POSITION (.05, .25)
  TEXT "READY:"
END
.
.
.
MACRO 26
    
```

RESULT

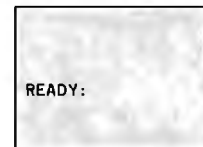

Figure 23: An example of the use of macros in NAPLPS. Each time the code for Macro 26 occurs in the data stream, the word "READY:" will appear on a blank screen.

terminal and vice versa. The direction can be specified when the macro is defined. The typical direction is to expand the macro *into* the terminal as described above. In the so-called transmit macros, the expansion of the macro occurs toward the host.

Transmit macros are usually associated with programmable function keys on the terminal. When a key is pressed, the string associated with the macro and the key is sent to the host.

Figure 23 illustrates a typical application of macros. Here, a macro has been defined. In this case, it was given the number 26. Later in the stream of NAPLPS instructions, the macro name 26 appears and the macro is expanded and processed by the terminal. The screen will be cleared to blue, the color white will be selected, and the word "READY:" will appear one-fourth of the way up the screen and a little in from the left edge. (Note that on the display screen the word "READY:" may appear to be *one-third* of the way up from the bottom; this results from the fact that the top quarter of the unit screen is not displayed.) Only 1 byte was sent to invoke this multibyte sequence. With this type of compression, a system can be made to appear very fast, even over 300-bit-per-second data links.

The Future of NAPLPS

NAPLPS has finally started to emerge as the most extensive text and graphics standard in existence. Many companies have hundreds of people working on NAPLPS-related projects. A survey in *Data Communica-*

tions magazine predicted that NAPLPS will be one of the most significant achievements in information exchange in the latter half of this century.

Part of the reason for this popularity is the fact that NAPLPS is not only a video-graphics protocol but an information-exchange language. NAPLPS has been used to encode pictures for plotters, printers, laser printers, and phototypesetters. NAPLPS can be used to encode precise descriptions of logos, trademarks, and physical objects, things which heretofore have been very difficult to describe precisely.

NAPLPS comes at a time when the information industry is bursting with new technology that exceeds existing standards for information interchange. NAPLPS is a standard that pushes this new technology to its limits and still provides the capability to accommodate unknown expansions.

NAPLPS is only the tip of the iceberg. In subsequent parts of this series, we will describe how NAPLPS fits into the larger scheme of local and regional area networks and distributed intelligent-terminal systems. Topics such as down-loading, file transfer, and operating-system evolution and compatibility will be covered.

Next month, we will begin to describe in detail how to write and decode NAPLPS information. In the meantime, anyone interested in obtaining more information about NAPLPS should obtain a copy of the ANSI standard specification. ■

Hard Disk is Easy to Control



With Advanced Digital's Error Correcting Controller!

Advanced Digital has solved the problem of hard disk control with the HDC-1001, a unique, error-correcting, microprocessor-based hard disk controller board for S-100 based computers. Now, control of up to four 5 1/4" or four 8" Winchester drives is a snap.

Occupying only one slot in the S-100 chassis, the HDC-1001's unique error-correcting capabilities will detect and correct errors before you're even aware of them. In addition, you get up to 8-Bit single burst correction, multiple burst detection, programmable correction/detection span, and much, much more.

Look at these outstanding features:

- Built-in data separator
- Up to 5 MBits/sec data rates
- 256 sector addressing range
- CRC generation/verification on ID fields
- ECC generation/correction on data fields
- Automatic retries on all errors
- Automatic restore and reseek on seek error
- 32 Bit computer generated polynomial
- Complete documentation
- One year warranty
- Retail price: \$500

And now Advanced Digital has really made it easy to add hard disk capabilities by offering you a perfectly matched, thoroughly-tested disk subsystem. The subsystem combines the HDC-1001 controller with an industry-standard 5 MByte hard disk and comes complete with cable and CP/M BIOS disk. With a suggested retail price of \$1800 (an optional 20 MByte drive is available for only \$200 more), Advanced Digital is by far your most cost effective way to gain control of a hard disk.



Ask about our full line of S-100 products, including our SUPER QUAD® single board computer, SUPER SLAVE® processor boards and SUPER SYSTEM® multi-user, multi-processor computer. Write or call: Sales Department



12700-B Knott Street • Garden Grove, California 92641 • (714) 891-4004 TELEX 678401 tab irin

® Registered Trademark of Digital Research Corp.

© Copyright 1981 Advanced Digital Corp.

Realizing Graphics Standards for Microcomputers

Use of the Virtual Device Interface graphics system will make portable graphics application software possible.

Fred E. Langhorst
Digital Research Inc.
POB 579
Pacific Grove, CA 93950

Thomas B. Clarkson III
Graphic Software Systems Inc.
POB 673
Wilsonville, OR 97070

Emerging standards for interactive computer graphics herald an era in which serious graphics applications will be as ubiquitous as spreadsheet and word-processing programs. By promoting program portability, making it possible to run the same programs on different computer systems, standards will create large markets for both software and hardware graphics products. As a result, the development of sophisticated graphics applications for microcomputers will be economically feasible. The benefit for the end user will be more software offerings of higher quality at reduced cost.

A History of Graphics Standards

The earliest graphics standards were de facto standards created by a small number of manufacturers who established dominance in the field by producing various successful graphics output devices, such as Calcomp plotters and Tektronix graphics terminals. When these companies added software support (for example, Tektronix's Plot-10 package), their implementation of graphics-device-control routines became the common graphics language for applications. This situation lasted until the early 1970s, when the need for broader and

more flexible standards was recognized.

In 1974, the Special Interest Group on Computer Graphics (SIGGRAPH) of the Association for Computing Machinery (ACM) held the Workshop on Machine Independent Graphics at the National Bureau of Standards near Washington. This conference marked the beginning of formal efforts in the United States to standardize graphics. The goal: to define a generic method for describing pictures that could be output to a variety of graphics devices such as hard-copy plotters and vector or raster video displays.

The International Workshop on Graphics Standards Methodology held in 1976 in Seillac, France, accelerated the work begun by SIGGRAPH. A significant development was the decision to break the standardization task into two components: first, to develop methods for making applications programs portable, and second, to develop a functional description of a "core" or basic graphics system.

In 1977, the Graphic Standards Planning Committee released its first draft of a graphics standard, the SIGGRAPH Core Standard. This draft incorporated input and output

capabilities for a range of graphics devices but did not address the emerging field of raster graphics. Then, after two more years of work, the committee released a major publication, the *Status Report of the Graphic Standards Planning Committee*, at the annual SIGGRAPH conference in 1979. Included was a methodology and specification for the Core Graphics System, raster-graphics extensions to the Core System, a description of Metafile (a device-independent picture file) and a model for distributed graphics systems. This document also provided the impetus for the formation of the ANSI (American National Standards Institute) Technical Committee X3H3 for Computer Graphics Programming Languages. Formed in 1979, this ANSI group is now the major graphics-standardization body in the United States. Meanwhile in Europe, the Deutsches Institut fur Normung (DIN), the German standardization institute, was working on a parallel effort to produce its Graphical Kernel System (GKS).

Current Standards Efforts

Present efforts in standardization focus on two main interface levels: the programmer interface and the

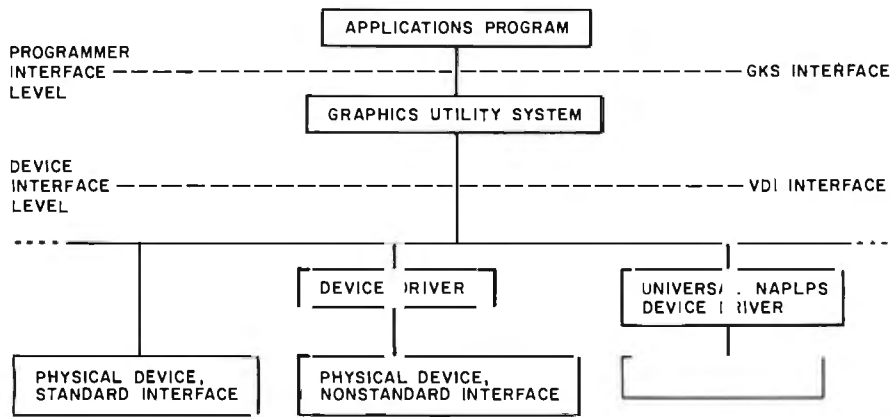

Figure 1: The two main levels of graphics standardization are the programmer and device-interface levels. The Graphical Kernel System (GKS) provides a standard interface between the application program and graphics utility programs. The Virtual Device Interface (VDI) standardizes the interface between graphics utilities and device drivers.

device interface. The *programmer interface* refers to the conceptual model as well as the syntax the programmer uses when incorporating graphics functions into an application program. The *device interface* refers to the protocol used for communication between the device-independent and the device-dependent functions (sometimes called the DI/DD interface). The programmer interface standardizes the calling sequence and functions of a graphics-procedure library, while the device interface defines a device-driver protocol that is consistent for all graphics devices (see figure 1).

The Graphical Kernel System

The Graphical Kernel System (GKS) is the principal emerging standard at the programmer level. GKS has felt the influence of many national organizations, including ANSI in the United States, and is justifiably described as an international standard. Now a Draft International Standard, the GKS specification is frozen awaiting final adoption as an ISO (International Organization for Standardization) standard.

GKS allows portability of graphics application programs between different computer installations by providing a consistent interface in high-level languages such as FORTRAN and Pascal. It also improves a programmer's ability to work on dif-

ferent systems by providing a graphics model and syntax that are common to several systems. This is accomplished by standardizing the way in which graphics functions are accessed and by providing graphics output on a virtual device surface defined in normalized device coordinates. The application program may then control the way individual workstations interpret the normalized coordinates, which are translated to real-device coordinates for display, although the other layers of the system are fooled into thinking they are communicating with the idealized virtual device.

Reflecting the rigors of its origin in the flexibility it provides, GKS supports a full set of drawing primitive commands (with variable attributes) for data input and drawing, support for multiple workstations, and device-independent picture segments. It also supports raster graphics through a comprehensive set of area-fill and pixel-array primitives. While GKS provides device independence for standard functions, nonstandard operations are also made available through the Generalized Drawing Primitive, a well-defined mechanism to escape from GKS that allows a programmer to access the unique capabilities of a particular device.

Let's take a look at some parts of the GKS specification.

GKS Workstations: A GKS work-

station is a single display surface and one or more input devices. The display surface is usually a cathode-ray-tube screen, although it could be a plotter bed or some other device. Multiple workstations that may operate in a single, interactive graphics session might include, for example, a raster display, a plotter, and a storage display tube. GKS provides the logical interface through which the application program controls physical devices, allowing the application to redirect the flow of graphics data to another I/O device at any time.

GKS Graphics Primitives: The basic drawing primitives in GKS are the *polyline*, *polymarker*, and *text* primitives. The *polyline* primitive draws a sequence of vectors (straight lines) between pairs of points that form a sequence specified as an array (sort of a "connect the dots" command). A single line is merely a special case of the *polyline*, defined by specifying both endpoints (rather than relying on a sometimes ambiguous and confusing current-position model). The *polymarker* primitive, chiefly used to identify points on plotted curves, is similar to the *polyline* except that a marker symbol, rather than a vector, is drawn at each specified point. The *text* primitive allows text strings to be displayed at any position with any orientation.

GKS also supports raster devices with fill and pixel-array primitives. The *fill* operation paints the interior of a closed *polyline* (polygon) with a specified color or pattern (such as a crosshatch). The *pixel-array* primitive allows a two-dimensional array of pixels of different colors, called a *cell*, to be defined. The cell may then be replicated over an arbitrary area simply by giving the desired boundaries. This operation finds many uses in imaging applications such as video-frame displays, cartography, and other scientific areas.

Some graphics-output devices have incorporated unusually powerful capabilities into their repertoire, such as the ability to draw arcs, circles, and bars. GKS allows an application program to access these capabilities through a special escape mechanism

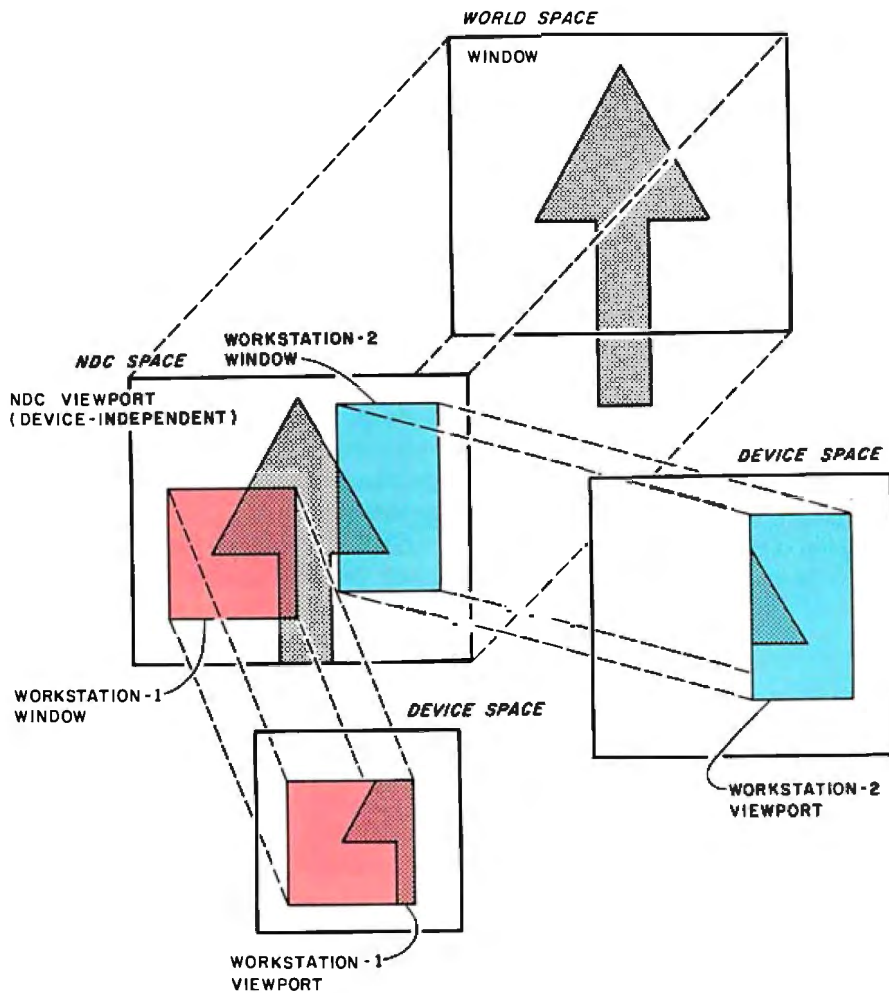

Figure 2: GKS provides a versatile set of viewing transformations. A window may be defined in the application's conceptual "world space," which selects a portion of that space to be viewed. The window is mapped to an area or viewport in an intermediate virtual space called the normalized-device-coordinate (NDC) space. This space appears identical to all devices in the system. Each workstation can then define its own window into the NDC space; each workstation window is mapped to its own viewport on the device display surface. This transformation allows each workstation to have a separate view of the NDC space.

called the Generalized Drawing Primitive. By passing an identification number and the required parameters to the driver, any unique feature of the device may be invoked. In effect, the Generalized Drawing Primitive is a standard way to be nonstandard.

Attributes: Associated with each output primitive are attributes that alter the object's appearance. For example, the polyline primitive has line-type (solid, dashed, etc.), width, and color attributes. Polymarkers have attributes of style, size, and color; the styles comprise a choice of common ASCII (American Standard Code for Information Interchange) characters. Text primitives have attributes of

size, color and orientation; and multiple character fonts can be accessed if they are available in the graphics device. Color indexes may be defined by associating a desired color specified in RGB (red-green-blue) intensities with a color-index number; the color values of primitives are then given as the appropriate index.

Viewing and Transformations: GKS allows the user or programmer to define a coordinate space, called the *world coordinate space*, that is appropriate for each application. This world coordinate space is mapped into device coordinates in a controlled manner through two distinct operations: normalization

transformations and workstation transformations. GKS first transforms world coordinates into a normalized-device-coordinate (NDC) space by defining a working region, or *window*, in world-coordinate space. NDC space acts as an abstract viewing surface or an intermediary space between applications and devices. The NDC space is then transformed into the device coordinates (DC) of the workstation. When multiple workstations are used, each may have a distinct view of the application by setting its own workstation window. The last transformation allows the workstation to set a viewport, the active region of the device's potential workspace, which can be used for scaling and translating the original picture (see figure 2).

Graphics Input: A full set of input operations allows an application program to receive input from a broad range of interactive input devices. The input operations are grouped into five classes: choice, locator, pick, string, and valuator. This vital flexibility allows GKS to support the optimum input device for a particular working environment. The result is improved interactivity through which the full potential of the graphics man/machine interface can be realized. The *request-locator* function returns the position of an image entity in world coordinates, while the *request-valuator* function returns an indication of the current value of a continuous valuator device such as a potentiometer. The *request-choice* function returns an integer that represents one of a set of choices. The *pick* function returns the graphics segment number that corresponds to the objects being selected with graphics input. Finally, the *request-string* function reads character input from a keyboard device. The way in which these logical functions are implemented (through a joystick, a mouse—like the one used with the Apple Lisa, function keys, etc.) is workstation dependent.

Inquiries: To aid the programmer, GKS provides an *inquire* capability that allows the application program to find out information about its system environment: the current operat-

"POWER IS A GREAT PROGRAM" - InfoWorld Software Review Nov 8/82

POWER!

The first super program that
puts you in control of CP/M.®

**POWER! works with CP/M or MP/M
on any computer.**

**POWER! gives you complete control
over CP/M!**

**Ever accidentally erased a file?
POWER! restores erased files!**

**Ever fiddled with PIP in copying
files? POWER! replaces PIP and is
faster and easier. You simply pick
files to be copied from a numbered
menu. POWER! feeds the names to
CP/M for you - no need to type file
names, no typing errors...ever!**

**Tired of CP/M's scrolling through
text files? POWER! goes through
files for you, page by page, file by
file, or line by line with instant halt
at your finger tips.**

**Ever lost data on a glitched disk?
POWER! tests disks and fixes
glitched disks.**

**Damaged Directory?
POWER! allows you to repair the
directory!**

**Afraid of HEX numbers?
POWER! automatically converts
HEX to DECIMAL, BINARY & ASCII.**

**Need to patch or change a program?
POWER! searches memory, dis-
plays memory, and lets you change
memory wherever you want.**

**Want to locate a file?
POWER! sorts the directory,
searches all disks or all user areas
automatically for files for you.**

**Annoyed at having to keep a
system disk in Drive A? POWER!
doesn't require a system disk in
any drive.**

**Renamed a file using = and all that
typing? POWER! lets you pick files
from a numbered menu and
prompts for every action.**

**Ever accidentally overwritten a file?
POWER! checks first and asks per-
mission.**

**Need to manipulate data on a disk?
POWER! reads and writes any track
or sector independently.**

**Ever make a mistake in the DDT?
POWER! loads disk data to ANY
memory address, not just 100, and
writes to the disk from any memory
address. POWER! Single-Steps
through memory, moves memory,
compares memory sectors, tests
memory, allows you to change
memory and saves to disk using
Decimal numbers.**

**NOW POWER! permits you to
securely lock any file with your
password to protect sensitive infor-
mation from prying eyes.
PASSWORD program included
FREE with every POWER! order.**

**Dislike BDOS errors?
POWER! ends BDOS errors, and
gives you a way out.**

**Trouble identifying files?
POWER! marks original files and
their copies for you. POWER! also
compares files and finds identical
copies regardless of name.**

**Can't remember odd file or program
name abbreviations? POWER! lets
you deal with disk files by number.
Never type or mistype file names
again.**

**POWER! does more..NEW version
of over 55 command utility pro-
grams is the only CP/M housekeep-
er you will ever need to really get
control of your computer. A great
buy, too, at less than \$2.75 each.**

MORE THAN



ONLY \$149 (\$2.75 EA. UTILITY)

**POWER! frees your disk
space since it uses less
than 15k.**

**POWER! versions for CP/M
or MP/M on any computer.**

**TRY IT ON US!
MONEY BACK GUARANTEE**

**Previous purchasers of POWER!
Exchange your original disk for
updated version with the new
commands and brand new
manual. \$35.00
credit card, check or C.O.D.**

JOIN OTHER POWER USERS

E. I. Dupont	Xerox Corp
Sperry Univac	Conn. Gen. Life
NY Stock Exchange	Princeton Univ
Livermore Labs	ITT
Union Carbide	Dow Chemical
UC Berkeley	Advanced Logic Sys.
UC San Francisco	Charlston Univ
Bendix Corp	Univ Helsinki
Fort Motor Co.	Honeywell

AMF
Syracuse Univ
Olivetti
New Mexico State
Monsanto Chemical
Univ Minnesota
US Dynamics
City Bank

COMPUTING! 2519 Greenwich, San Francisco, CA 94123

See Us at CPM 83 Show



COMPUTING! 2519 Greenwich, San Francisco, CA 94123

TOLLFREE (800) 227-3800 Ext 28 DEALERS and OEM's
IN CA: (800) 792-0990 Ext 28 (415) 567-1634

CP/M \$149 CP/M-86 \$149 MP/M \$198 *California add 6.75% sales tax.*

Card No. _____ Ex Date _____

Name _____

Company _____

Address _____

City _____ State _____ Zip _____

Computer _____



PDS UNIVERSAL
PRODUCTS

TRUMPCARD

A unique memory card with 256K Ram Game I/O and Serial I/O. . . **\$499.00**

TRUMP CARD II

Serial I/O and 512K fully populated memory card **\$699.00**



TRUMP CARD V

Features Parallel and Serial I/O, Game I/O and a Clock/Calendar with battery back-up. A fully populated 256K memory board **\$599.00**

QUADRAM

Quad Board - 256K, Parallel Port, Serial I/O, Clock Calendar with battery backup **\$599.00**
 512K Ram with Serial I/O. . . **\$799.00**
 Microfazer Parallel **\$199.00**
 Microfazer Cable **\$37.95**
 Quad Color I **\$299.00**
 Quad Color II 640 x 200. . . **\$499.00**
 Quad Color III 640 x 400 . . . **\$699.00**

IBM PC- COMPLETE LINE

IBM

PC Complete System: includes 64K IBM-PC with 2 Floppy Disk Drives, Floppy Drive Controller, 12" monitor, Color Graphics card. All for only **\$2899.00**

AST COMBO CARD

AST Combo Card 256K ram, Parallel Port, Serial Port, Clock Calendar and Battery back-up **\$599.00**

MAYNARD ELECTRONICS

Floppy Disk Controller **\$179.00**
 Floppy Disk Controller w/Parallel Port **\$229.00**
 Floppy Disk Controller w/Serial Port **\$239.00**

HERCULES GRAPHICS CARD

This card gives you 720 x 350 graphics capabilities and it is completely compatible with DOS software for only **\$489.00**

BIG BLUE

Dual I/O ports, dual processing, Serial port, Parallel port, 5 MHZ, Z80 B, 64K, Hard disk interface, Clock/Calendar, let's you run existing CP/M software. List **\$589** Ours **\$479**

TALL TREE SYSTEMS

JRAM 512K, allows PC to address ONE MEGABYTE Electronic Disk. . . **\$800 EA.**
JFORMAT lets you mix and match Drives: single/dual/quad/Electronic/8"/Hard Disk + Printspooler and 10 spector formatting. **\$60.00**

FLOPPY DISK DRIVES

TANDON

TM-100-1 SS/DD **\$189.00**
 TM-100-2 DS/DD **\$249.00**
 TM-100-4 DS/DD **\$359.00**
 TM-848-1 SS/DD **\$425.00**
 TM-848-2 DS/DD **\$499.00**

SHUGART

SA400 SS/SD **\$175.00**
 SA450 DS/DD **\$250.00**
 SA800/801 SS/SD. **\$365.00**
 SA850/851 DS/DD. **\$459.00**

QUME

DT-5 DS/DD. **\$269.00**
 DT-8 DS/DD. **\$469.00**

AMDEK-3 COMPACT 3" MICRO-FLOPPYDISK DRIVE SYSTEM

This 3" Amdek Micro-Floppy disk Drive offers up to 1 Megabyte storage. Two drives (with built-in power supply) are furnished to accommodate Micro-Floppy-disk Cartridges. **\$699.00**

HARD DISK SYSTEMS

For IBM and Apple from Devong and Corona
 5MB. **\$1595.00**
 10MB. **\$1995.00**
 Complete subsystem with software, cables and power supply.

PRINTERS

EPSON

MX-80 W/graftrax plus **\$439.00**
 MX-80 FT W/graftrax plus . . . **\$499.00**
 MX-100 W/graftrax plus **\$659.00**
 Atari to epson cable. **\$35.00**
 IEEE Pet. **\$25.00**
 Apple parallel **\$35.00**
 IBM to epson **\$46.00**
 MX-70, MX-80, MX-80 FT ribbons **\$14.00**
 MX-100 ribbons **\$24.00**

BROTHER

HR-1 A parallel **789.**
 HR-1 A serial. **\$899.**
 Tractor feed option. **\$135.**
 Print wheel **\$24.**
 Multi strike ribbon (dozen) **\$73.**
 One time film ribbon (dozen) . . . **\$32.**

SMITH CORONA

TP-1 parell. **\$579.**
 TP-1 serial. **\$579.**
 Nylon black fabric ribbon (dozen) **\$49.**
 Mylar multi strike (dozen) . . . **\$54.**
 Print wheel **\$9.**



NEC

SPINWRITER

7710-1 **\$22**
 7715-1 **\$23**
 7720-1 **\$25**
 7725-1 **\$26**
 7730-1 **\$22**

SPINWRITER

3510 **\$13**
 3515 **\$14**
 3520 **\$19**
 3525 **\$19**
 3530 **\$16**
 3550 **\$20**
 PC 8023A **\$4**

OKIDATA

82A **\$429.**
 83A **\$699.**
 84AP parallel. **\$999.**
 84AS serial **\$1099.**
 82A tractor feed **\$69.**
 Parallel cable [Okidata to Apple or Atari] **\$29.**

MONITORS

AMDEK

Video 100 **\$89.**
 Video 300 **\$179.**
 Video 300A (Amber). **\$159.**
 Video 310 (for IBM PC) **\$179.**
 Color I 13" composite monitor. **\$299.**
 Color-II (Hi-res) **\$669.**
 Color-III (Med-res) **\$399.**
 Color-IV. **\$999.**
 DMV Board for Apple II **\$139.**

Prices subject to change without notice

*APPLE is a Trade Mark of Apple Computers, Inc.
 *IBM, is a Trade Mark of IBM Corp.

MDEK

- Color II 16 color modulation kit, **\$9.99**
- Color II to Color I interface cable **\$19.95**
- Color II to Color I interface cable **19.95**

EC

- 1201M 12" green screen **\$169.00**
- 1212M 12" color (Lo-Res) . . . **\$35.00**
- 1203DH (A) 12" (Hi-Res) . . . **\$752.00**
- 691 video interface cable for IBM **\$26.95**
- 692 video interface cable for NEC **\$29.95**

ELECTROHOME

- 13" RGB monitor (Med-Res) . . . **\$299.00**
- 13" RGB monitor (Hi-Res) **\$549.00**
- ATSC module **\$25.00**
- Supercolor Board **\$199.00**
- 16 color IBM cable **\$39.00**
- 16 color IBM cable **\$39.00**
- 16 color PC-8000 cable **\$39.00**



OMREX

- R-5500 12" monochrome display **\$89.00**
- R-6500 13" composite color monitor **\$299.00**
- R-6600 13" color RGB monitor **\$499.00**

CABINETS/POWER SUPPLY

- Equal 8" disk drive cabinet/ps. **\$249.00**
- Equal 5 1/4" disk drive cabinet/ps. **\$99.00**
- Single 5 1/4" disk drive cabinet/ps. **\$69.00**
- Single side double density 8" disk drives, cabinet/power supply **\$895.00**

SPECIAL PRICES ARE ONLY PART OF OUR SERVICE



apple

APPLE II+ COLOR COMPUTER SYSTEM

Apple II+ computer system with 64K Ram, two "DataDrive" disk drives, controller card, Z80 card, 80 Column card and a high quality Comrex 6500 composite color monitor. **\$2499**

Apple II+ Computer System with 48K of memory, "DataDrive" disk drive, controller card, 12" green screen hi-contrast monitor. All cables and manuals are included for a CompuShack price of **\$1599**

For the same system listed above with a 16K card, Z80 card and an 80 Column card add **\$351**

OTHER PRODUCTS FOR APPLE II

PDS UNIVERSAL

- Z80 card CP/M included **\$159.00**
- 80 column card **\$199.00**
- Disk drive controller card W/ diagnostics software **\$99.00**
- Disk drive controller **\$79.00**

PDS DATA DRIVE®

100% Compatible disk drive for Apple II+. **\$279.00**



SUGGESTED RETAIL PRICE . . . **\$429.00**

Drive with controller card . . . **\$359.00**

SPACE SAVER

Slim line drive for Apple II+. . . **\$399.00**

R. H. ELECTRONICS

- Super fan II and one outlet **\$59.95**
- Super fan II W/Zener Ray and two outlets **\$79.00**

HAYES MICROCOMPUTER PRODUCTS

- Micromodem II. **\$299.95**
- Smartmodem 1200 baud full duplex. **\$529.95**
- Micromodem II manual/diskette **\$15.00**

T G PRODUCTS

- Game paddles **\$29.95**
- Joy stick. **\$45.95**
- Select a port **\$45.95**

STREET ELECTRONICS

- ECHO II speech synthesizer . . . **\$175.00**

THE OSBORNE 1 PERSONAL BUSINESS COMPUTER

The Osborne 1 comes standard with 64K Ram, 2 Floppy Disk Drives, Serial Interface, Modem Connection, IEEE 488 Interface C Basic, CP/M and Supercalc for the Best Price In The Country. . . **Call**

FRANKLIN ACE 1000 COMPUTER SYSTEM

64K Ram, Upper and Lower case letters, 12 Key numeric, Alpha Lock, Visicalc Keys, Two "Data Drives" and Controller, 12" (green) monitor **\$1699**

Color Card add **\$59**

KAYPRO II COMPUTER SYSTEM

64K Ram, Perfect Writer, Perfect Filer, Perfect Speller, Perfect Calc, S-Basic, CP/M version 2.2, two disk drives, 9" (green) monitor, RS232 interface, Parallel Printer interface, and Weatherproof carrying case **\$1699**

WE'RE OPENING RETAIL STORES THROUGHOUT THE U.S.A. SOON!

COMPU SHACK

FRANCHISE INQUIRES WELCOME

CALL YOUR LOCAL COMPUSHACK DEALERS:

California	Anaheim	*	Illinois	Chicago	(312) 964-4612			
	Concord	*		Montana	Great Falls	*		
	La Mirada	(213) 947-6284			Missoula	(406) 721-1811		
	Newport Beach	*			New York	Albany	*	
	San Diego	(714) 457-2149				Rochester	*	
	San Jose	(408) 973-1444				Rome	(315) 336-0266	
	Tustin	(714) 730-7207				Texas	Austin	(512) 258-1062
	Walnut Creek	*			Washington		Richland	*
	Westminster	*					Spokane	*
	Woodland Hills	(213) 888-0030				Wisconsin	Verona	(608) 845-7110
Colorado	Denver	(303) 422-3925	Canada		Toronto		*	
	Idaho	Twin Falls		*	U.K.		London	01-935-0480

Sales and Service: Headquarters Telex: 181667
(714) 730-7207 Answer Back COMPDSHAK TSTN

ALL FLOPPIES REPAIRED QUICKLY AT LOW COST

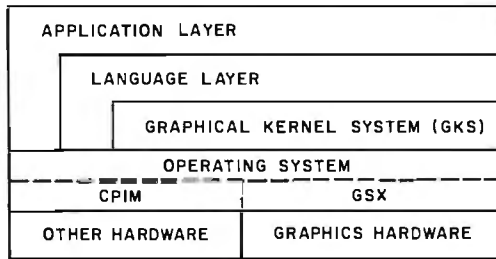

Figure 3: This layer model shows the relationship of GKS and VDI to other components in a graphics system. Each module may call the functions of the adjoining layer below. An example of this is the Graphics System Extension (GSX) to the popular CP/M family of operating systems.

ing state, primitive attributes, viewing operations and transformations, and device capabilities.

Device-Level Interfaces

Two emerging standards are addressing the hardware-driver interface level. One of these, the North American Presentation-Level-Protocol Syntax (NAPLPS), was developed by a team at Bell Laboratories as an extension of graphics developments in the Canadian Telidon videotex system. (See the article "NAPLPS, A New Standard for Text and Graphics: Part 1" by Jim Fleming and Bill Frezza on page 203.) NAPLPS (pronounced "nap-lips") has been adopted by AT&T as a standard for transmitting text and graphics over telecommunication lines. In some computer-graphics applications, NAPLPS probably will "sit below" another, more general, device interface called the Virtual Device Interface (VDI). This relationship is illustrated in figure 1, where the NAPLPS block is placed under the dashed line of the Virtual Device Interface.

The VDI standard is being developed by the ANSI X3H33 Technical Committee as a standard interface between device-independent software and graphics devices. VDI makes all devices appear as identical virtual graphics devices by defining a standard input/output protocol. The unique characteristics of the physical graphics device are isolated in the device-driver software module. This technique has been employed by individual vendors to make their own products compatible with a wide range of devices, similar to the way

operating systems such as Unix or CP/M are interfaced to a multitude of hardware configurations. VDI takes the concept a step further by providing potential industry-wide compatibility.

The VDI specification is expected to be frozen during the summer of 1983. For the graphics-equipment manufacturer, the adoption of this standard means that a VDI driver for a particular graphics device need be written only once. All graphics applications that conform to VDI would then be able to communicate with the device through the standard device driver. Long-range benefits will be more evident as equipment and semiconductor manufacturers begin implementing more of the software-driver functionality in hardware—in effect moving the VDI interface down into the graphics device itself. This development in graphics is a direct parallel to other standardization efforts, such as the Shugart Associates Standard Interface (SASI) for disk-drive subsystems. The SASI hardware and protocol specification allows OEMs (so-called original equipment manufacturers) to freely mix disk subsystems and host computers made by different firms. The popularity of this approach stems from the many benefits it offers to the industry: less design effort expended reinventing the wheel, numerous second sources of parts, higher reliability with a proven design, reduced costs, and larger markets. Similar benefits will accrue to computer graphics as a result of the standardization efforts that are at last bearing fruit.

Graphics Standards as Products

Although the cost of hardware, especially semiconductor memory, is usually cited as the major inhibitor to truly widespread use of interactive graphics, this is becoming less and less accurate. The lack of universal standards has dulled the impact of the dramatic reduction in component costs in the past decade. The impending advent of these important standards paves the way for implementations of computer graphics that will enjoy widespread availability and economies of scale. The success of this approach has been demonstrated in the microcomputer world by such de facto standards as the 8080-compatible microprocessors and the CP/M operating system.

Digital Research in collaboration with Graphics Software Systems Inc. (GSS) has recently responded to the potential offered by the new standards by expanding the capability of the CP/M family of operating systems with an upgrade called the *Graphics System Extension*, or GSX. This upgrade provides full graphics capabilities to the user through the normal CP/M function-call access mechanism. The architecture of GSX has been carefully designed to allow the extended CP/M to maintain compatibility with nongraphics applications and to use system resources in a way that is consistent with a small-system environment, according to the structure shown in figure 3.

Digital Research has also provided a package called GSS-Kernel that presents a GKS interface to the graphics-application programmer using the graphics functions provided by GSX. GSS-Kernel, a linkable runtime library, will increase programmer productivity while providing program portability through the standard GKS interface. In addition, applications using GSS-Kernel will be source-code compatible with large computer systems running GKS procedures libraries.

GSX Architecture

GSX is composed of three major components: the graphics-device operating system, the graphics input/output system, and the Gengraf

SPECIAL OFFER!
 Get \$75 to \$300 off
 additional Microsoft software
 when you buy the SoftCard System.

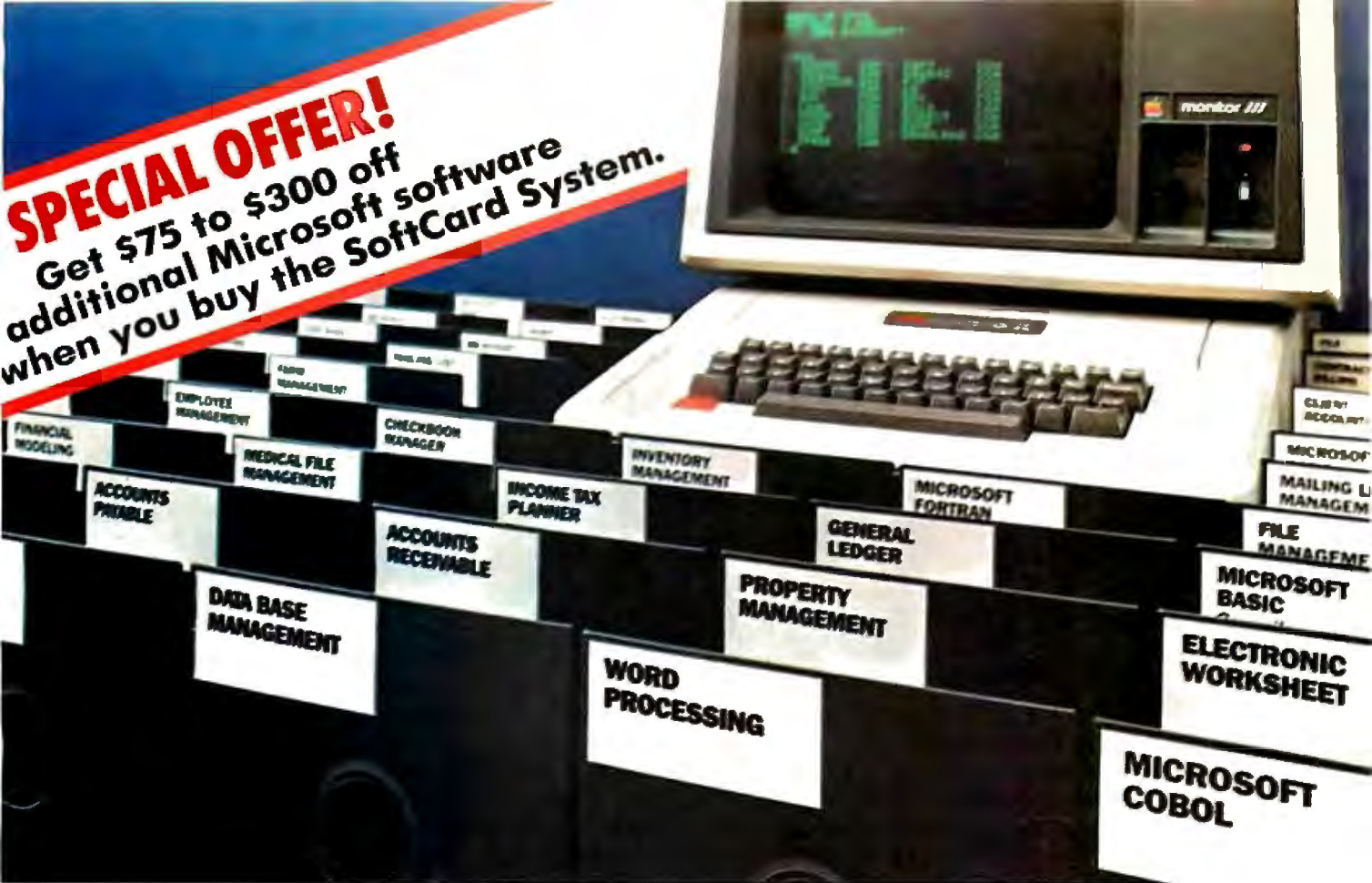

Introduce your Apple® to thousands of new programs with the new Microsoft® SoftCard.™

A more powerful Apple. When you add the new Microsoft SoftCard system to your Apple II or II Plus, you also add the ability to run thousands of CP/M-80® based programs. Languages. Utilities. Applications programs that range from word processing and data base management to analysis and forecasting tools. Thousands of software tools for business, professions and the home. Tools that can turn your Apple into a far more productive machine. And, the new SoftCard system is enhanced, allowing you to run 60K programs. If you already have a SoftCard system, ask your dealer about Microsoft's inexpensive upgrade kit.

Two computers in one. With the SoftCard system, your Apple becomes two computers. One that runs Apple software, another that runs CP/M-80. Which means you'll double the utility of your computer.

A complete solution. The SoftCard system includes everything. The easy install SoftCard circuit board. The CP operating system. Microsoft BASIC plus GBASIC for graphics applications. And, the utilities you need to manage CP/M-80 files.

Why Microsoft? Microsoft was the first personal computer software manufacturer. The very first. Today, Microsoft software is running on well over a million computers worldwide. There's a reason. Microsoft has earned a reputation for better

software. Products that work. Products that are constantly being enhanced. And when the enhanced versions are ready, we make the enhancements available to our customers. Like the 60K enhancement for the SoftCard system. That kind of product support is just one of the ways we earned our reputation.

Ask your dealer. Ask about the superior applications programs the SoftCard system makes available to your Apple. High ty programs for almost every area of home, business, and professional use. Then, ask for a demonstration of the complete Microsoft SoftCard package... and any of those thousands of new programs you can introduce to your Apple.

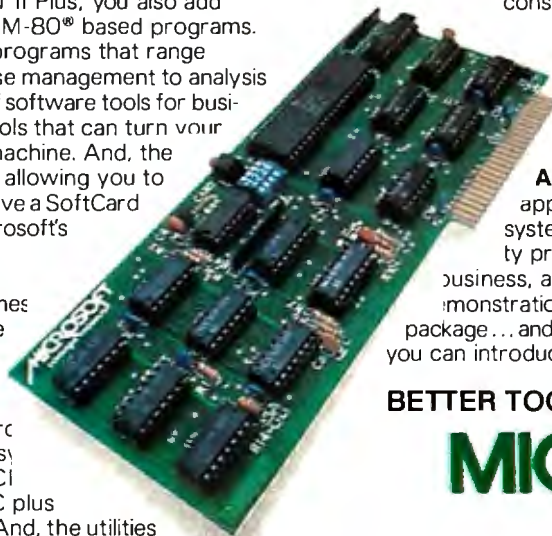

BETTER TOOLS FOR MICROCOMPUTERS

MICROSOFT.™

MICROSOFT CORPORATION
 10700 NORTHUP WAY
 BELLEVUE, WASHINGTON 98004

Microsoft is a registered trademark of Microsoft Corporation
 SoftCard is a trademark of Microsoft Corporation
 Apple is a registered trademark of Apple Computer, Inc.
 CP/M-80 is a registered trademark of Digital Research, Inc.

Circle 275 on Inquiry card.

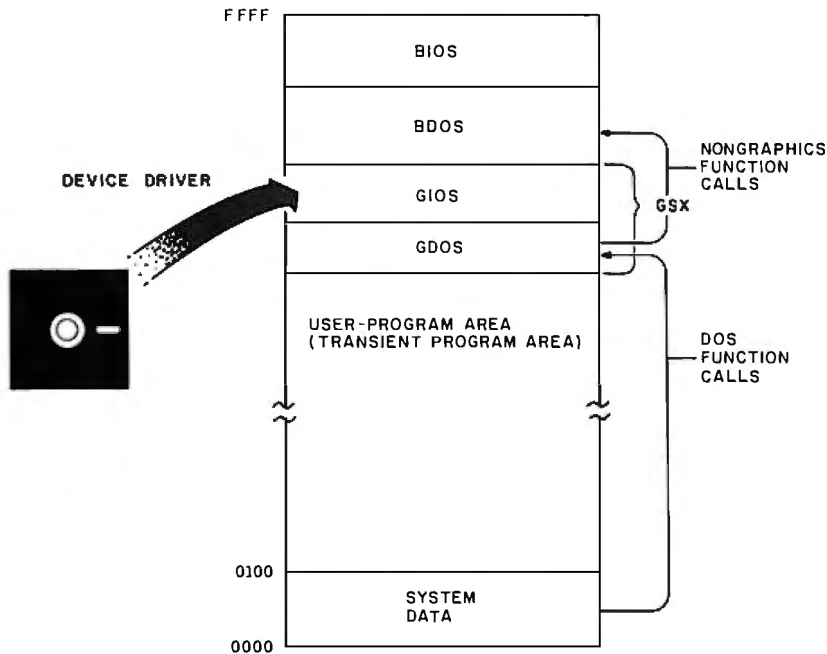

Figure 4: GSX consists of the device-independent (GDOS) and device-dependent (GIOS) components. These are loaded at run time below the BDOS (basic disk operating system) module in high memory. Initial loading of GIOS and GDOS from the system disk is performed by a loader routine attached to the application program by the GSX Gengraf utility when the program is created. During operation, graphics workstations may be changed by making a request to GDOS that causes a new device driver to be loaded from the disk.

utility routine. The *graphics-device operating system*, or GDOS, is analogous to the BDOS (basic disk operating system) module in the standard CP/M system and contains the device-independent portion of GSX. The *graphics input/output system*, or GIOS, contains the device-dependent drivers which, like the basic input/output system (BIOS) in standard CP/M, provide the necessary "glue" to connect GDOS with the particular characteristics and command sequences of a specific graphics device. Finally, the *Gengraf* utility configures a graphics-application program to run in the GSX environment.

Figure 4 shows the relationship of software components of a GSX-extended CP/M-80 system. GDOS and GIOS form a path to graphics devices that is essentially parallel to the BDOS and the BIOS. Normal operating-system calls, such as reading from or writing to the console or a disk drive, are initiated by the BDOS, and the BIOS provides the device-

dependent interface. Graphics calls are intercepted and serviced by GDOS and passed to the appropriate device-dependent driver within GIOS. In reality, only one device-driver routine is resident in memory at any time; the other device drivers are stored on disk. The application program may request use of a new workstation at any time, and GSX will insure that the proper device driver is loaded as needed. This choice of implementation maximizes the memory available for the application program.

Graphics-Device Operating System: Access to all graphics operations is through function calls to GDOS, made in the same manner as BDOS calls except that an additional parameter list is specified to transfer graphics information. This information includes a graphics operation code, a control array, a parameter array, and a point array. Point locations are passed to GSX in a normalized-device-coordinate space. Here all point locations are specified

with x,y coordinates between 0,0 and 32767,32767. GDOS then transforms the NDC coordinates into the device coordinate system through a scaling operation using device-specific information that was passed when the current workstation was opened for use. This scheme not only provides a VDI-compatible method of passing coordinate values, but also allows points to be specified as integer arrays, thus saving memory space and processing time.

GDOS is also responsible for dynamic workstation assignment. Each device on a system is associated with a workstation-identification (ID) number. When GDOS receives a request to assign a workstation (change the currently active graphics device), it determines which driver corresponds to the indicated workstation ID and loads that driver into memory. The new driver is loaded into memory in the same locations formerly occupied by the previous driver so that memory requirements are minimized. The logical association of workstation ID number to a particular device is made through an assignment table, a text file stored on the system disk. You can alter the correspondence of workstation ID to specific device drivers simply by editing the assignment-table file with any text editor.

Graphics Input/Output System: The GIOS component of GSX contains the device-dependent code that translates between the Virtual Device Interface and the unique characteristics of a real graphics device, making all graphics devices appear to the application program as identical virtual devices. The VDI specifies the pseudo-operation code for a graphics operation as well as a set of input and output arguments. The input arguments include an array of control parameters, an array of input parameters, and an array of input point coordinates. The output arguments include control parameters, output parameters, and output point coordinates. The control, input, and output parameters are unique to the particular operation being performed (see table 1).

Often, the capabilities specified by

EXTRA**EXTRA**

S-100 World News

MACROTECH International Corporation

22133 Cohasset Street, Canoga Park, California 91303 • 213-887-5737

Megabyte S-100 Memory Here Now

Major breakthrough made by Macrotech International Corporation

CANOGA PARK (MI)-January 20, 1983-Mike Pelkey, president of Macrotech International Corporation, today announced a major technological breakthrough in S-100 dynamic memory board density. A full megabyte of high speed dynamic ram is contained on a single standard size S-100 multilayer P.C. board. The product, dubbed 'Max' meets all IEEE/696 mechanical and electrical specifications and byte parity generation/checking is included as a standard feature. Max supports IEEE/696 24-bit addressing (selectable at any 128K boundary), 8/16 data transfer protocol, phantom line operation, and the same ultra low noise bus signal filtering provided on Macrotech's popular high performance 256K dynamic memory board.

Max is in production now and shipping at the all-time low cost per bit list price of \$1,983 in unit quantity.

Bruce Kimmel, Macrotech's sales manager reports that customers are being served on a "first-in, first-out" basis and warns that due to a high incidence of graphics and similar memory-intensive applications, along with an unwillingness in the trade to pay exorbitant prices for memory, backlogs may occur for Max which could delay shipments against some late orders. With the improbability of second sourcing for some time, interested parties are urged to get orders in as soon as possible. Bruce can be contacted at 22133 Cohasset Street, Canoga Park, California 91303, or reached by telephone at (213) 887-5737.

Virtual Disk Flexibility Cited

CANOGA PARK-January 20, 1983-Macrotech reports their Multiuser I and Multiuser II S-100 ram memory boards can be used as both system memory and "virtual disk" storage in eight or sixteen-bit applications. Addressing flexibility is the key. The Multiuser M³ memory mapped addressing is guaranteed to allow memory partitioning to fit the exact requirements of your system without ever wasting a single byte.

Today's trend in operating systems appears to include extended memory capabilities to allow for the recent technological advances in semiconductor memory. A close look at Digital Research's new CP/M 3™ for example, would lead you to believe that it was especially created to fit Macrotech's family of Multiuser memoryboards. (It wasn't, but try to find one that fits better.)

MACROTECH Announces Distribution Expansion

CANOGA PARK-January 20, 1983-Macrotech is now establishing domestic and international dealer/representative networks. The California based firm is expanding its customer support through these channels and invites inquiries. Volume users and retailers should contact the company for details.

Macrotech's marketing director Bob Ryle states, "IEEE/696 has made S-100 legitimate. It is rapidly gaining acceptance due to its inherently superior speed characteristics." Ryle attributes the growing demand for Macrotech memories to Macrotech's strict adherence to the IEEE standard. Circle 240 on inquiry card.



M³ Family Growing

Another product recently introduced by Macrotech is soaring to the top of the best-seller list. The Multiuser II is a 128 kbyte 70ns CMOS static ram memory board that is unquestionably without peer in the S-100 marketplace. It's a 6-layer board with blazing speed, 8/16 data transfer protocol, and ultra-low power external battery support. The same M³ memory mapped addressing architecture so in demand with system software professionals is now standard in the new Multiuser II. M³ was first developed by Macrotech for the popular Multiuser I 256K dynamic ram board to meet the demanding requirements of today's sophisticated systems.

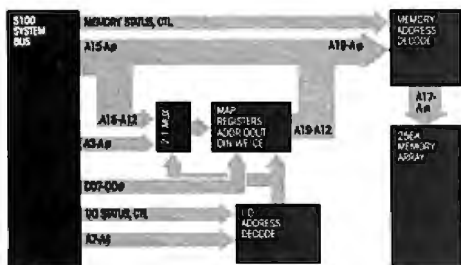

Macrotech's advanced memory mapping scheme allows each 4K block of the 16 bit (64K) logical addresses to be dynamically translated to any 4K block of the physical memory. Global memory can be configured to any size and located anywhere in the logical address space. All remaining memory can be addressed through the remaining logical address space by simply reloading the mapping registers to address the desired physical memory blocks. This scheme permits unlimited use of all on-board physical memory.



Where it all started: pictured is the popular Multiuser I, Macrotech's first product. This widely used board provides 256 Kbytes of dynamic ram with 4K page memory mapping (called M³), 8/16 bit operation, 24 bit addressing and byte parity checking.



AIMING TO PLEASE

If you know anything at all about Computer Furniture and Accessories, you know that we bend over backwards to make our customers happy. That's why we'll modify our standard line of computer desks and accessories to meet your special requirements. With custom tops and desk configurations, special data shelves, micro shelves, risers, keyboard recesses, cable cut-outs and paper slots, as well as custom paint and top laminate colors. At CF&A you get all this plus durable construction, reasonable cost, and personal service. More than ever, CF&A is aiming to please.

CF&A

**Computer Furniture and
Accessories**
515 West 132nd Street
Gardena, CA 90248
(213) 327-7710

**Houston Warehouse:
Hamilton and Associates**
8050 El Rio
Houston, TX 77054
(713) 741-1505

Op Code Description

Op Code	Description
1	Open Workstation: initialize a graphics device (load driver routine if necessary)
2	Close Workstation: stop graphics output to this workstation
3	Clear Workstation: clear display device
4	Update Workstation: display all pending graphics on workstation
5	Escape: enable special device-dependent operation
6	Polyline: output a polyline
7	Polymarker: output markers
8	Text: output text starting at a specified position
9	Filled Area: display and fill a polygon
10	Cell Array: display a cell array
11	Generalized Drawing Primitive: display a generalized drawing primitive function
12	Set Character Height: set text size
13	Set Character-Up Vector: set text direction
14	Set Color Representation: define the color associated with a color index
15	Set Polyline Line Type: set line style for polylines
16	Set Polyline-Line Width: set width of lines
17	Set Polyline-Color Index: set color for polylines
18	Set Polymarker Type: set marker type for polymarkers
19	Set Polymarker Scale: set size for polymarkers
20	Set Polymarker-Color Index: set color for polymarkers
21	Set Text Font: set device-dependent text style
22	Set Text-Color Index: set color of text
23	Set Fill-Interior Style: set interior style for polygon fill
24	Set Fill-Style Index: set fill style for polygons
25	Set Fill-Color Index: set color for polygon fill
26	Inquire Color Representation: return color representation values of index
27	Inquire Cell Array: return definition of cell array
28	Input Locator: return value of locator
29	Input Valuator: return value of valuator
30	Input Choice: return value of choice device
31	Input String: return character string
32	Set Writing Mode: set current writing mode (replace, overstrike, complement, erase)
33	Set Input Mode: set input mode (request or sample)

Table 1: Operation codes available under the Graphics System Extension (GSX).

the VDI standard are not provided by a particular graphics device. In some cases, the device-driver software emulates the required function. For example, four line styles are specified by VDI: solid, dashed, dotted, and dashed-dotted. If a graphics device does not have the ability to produce these directly, their automatic generation is emulated in software. For example, if a dotted line cannot be produced by a device, the required line style is produced by generating a series of short solid lines with intervening spaces.

Gengraf: The final component of GSX is the Gengraf program. Gengraf is a utility program used by the application programmer to configure a

graphics program for use with GSX. Gengraf appends a special loader routine onto the graphics program. This loader brings GDOS into memory and loads the default graphics-device driver before execution of the graphics program begins; therefore, GSX (GDOS and GIOS) is brought into memory only when a graphics-application program is executed. Otherwise, the programmer has use of the full user-program space available under CP/M.

The loading and linking of GSX is completely transparent to the user at run time. In CP/M-80, the linkage to GDOS is established by the Gengraf loader at run time by a substitution of the GDOS entry point in place of the

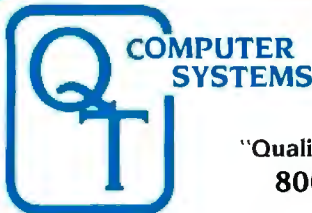

"Quality Throughout"
800-238-3100

Q.T. Products Division
COMPATIBLE COMPUTER CORP.
3330 South Third St. West
Salt Lake City, UT 84115
☎ (801) 974-0999

Q.T. Systems Division
GOLDEN WEST COMPUTERS
60 North 300 West
Provo, UT 84601
☎ (801) 373-1467

NOTICE: CP/M is a trademark of Digital Research, Turbodos of Software 2000 and INFOWARE of Compatible Computer Corporation. The Q.T. products and systems above are produced and sold under license by Compatible Computer Corporation and Golden West Computers, Inc. The Q.T. trademark and product designs remain the property of the licensor, Q.T. Computer Systems, Inc. of Hawthorne, Calif.

NEW IMPROVED 1983 MODELS

The entire Q.T. product line has been redesigned and improved using computer controlled manufacturing techniques to insure the highest quality. Many new features have been added to every item. The Q.T. 1983 models are among the best S-100 products available on the market today. They are fully compatible with the latest 16/32 bit cpu's.

Call (800) 238-3100 today for the location of your nearest dealer and/or to obtain the 1983 Q.T. catalog. Substantial dealer/OEM discount offered.

Stocking dealers with retail showrooms and mail order facilities include:

- Priority One, Chatsworth, CA** ☎ 800-423-5922
Bison Products, Los Angeles, CA ☎ 213-994-2533
Compatible Computer, New York City ☎ 212-221-7900

TERMS: Cash prepayment @ 2% discount, COD or net 30 days with prior credit approval. Initial dealer/OEM orders must be COD or prepaid (MC/Visa credit card OK). Purchase orders accepted from D&B rated firms. Shipping and handling charges estimated at \$0.50/lb UPS ground and \$1.00/lb UPS Blue Label or airfreight. Minimum \$3.00. Utah residents add sales tax. Export orders welcomed—telex 426382 ITR UI.

Q.T. DISCOUNT MICRO-SYSTEMS PACKAGES



Q.T. MAXI-SYSTEM PACKAGE—Model 800P

\$6,395.00

List \$7,995.00—Save \$1,600.00

- QT 8" Mainframe with 8 slot Motherboard —Televideo 925 Full Featured CRT
 —Choice of printer: C. Itoh F-10 daisy wheel or Oki data M84P high speed dot matrix (200 cps.)

The Q.T. Maxi-System is an industry standard S-100 expandable microcomputer which is ideal for general business computing, word processing and data base management applications. CP/M operating system is standard. MP/M or Turbodos optional. Unique Infoware[®] utilities simplify operation and user training.

- Electronics on Two Cards
 - 4Mz Z80A CPU
 - Filtered Fan
 - 64K RAM Standard
 - Parallel Printer Port
 - Two A.C. Outlets
 - Universal Disk Controller
 - 10-40 MB Hard Disk Option
 - Key Lock Switch
 - 2 Megabytes on line
 - Expandable to 256K RAM
 - Two Serial Ports
- Package Price Includes Cables, Documentation & Utility Programs. Model 800 alone \$4,995

Q.T. MINI-SYSTEM PACKAGE—Model 500P

\$3,995.00

List \$4,995.00—Save \$1,000.00

- Q.T. 5 1/4" MINI-FRAME w/6 slot MB
 —Televideo 910 Green CRT
 —Dot Matrix printer (M82A)

- CP/M standard. Turbodos optional.
 - Reliable Single Card Electronics
 - Z80 CPU/Universal DMA controller
 - Dual Double Sided/Density Drives
 - Memory: 64K RAM & 320K Disk Drive
 - Cables, manuals, Infoware[®] Utilities
- Model 500 alone \$3,495.00

Q.T. INDUSTRY STANDARD S-100 MAINFRAMES



Q.T. MICRO-FRAME[™]



Q.T. MINI-FRAME[™]



Q.T. MAXI-FRAME[™]

Q.T. MICRO-FRAME[™]—Series 600

Desk Top—Plain Front Panel

- 6 to 22 slot Motherboard
- Full I/O Cutout Array
- Fused EMI/RFI Filter
- Heavy Duty Power Supply (+8V@16A ±16V@3A)

QTC-MF + 1	No MB	\$499
QTC-MF + 6	6 slot MB	\$599
QTC-MF + 8	8 slot MB	\$649
QTC-MF + 12	12 slot MB	\$699
QTC-MF + 18	18 slot MB	\$799
QTC-MF + 22	22 slot MB	\$899

Q.T. PRO-FRAME[™]—Series 700

Rack Mount—Constant Voltage

QTC-RM + 12	12 slot MB	\$799
QTC-RM + 18	18 slot MB	\$899
QTC-RM + 22	22 slot MB	\$999

Q.T. MINI-FRAME[™]—Series 500

Desk Top—Dual Mini Drives

- Holds two 5 1/4" Drives
- Full Cutout Array
- 6, 8, or 12 slot MB.
- Fused EMI/RFI Filter
- Hard Disk Power Supply (+8V@16A, ±16V@3A, ±12V@5A, +5V@5A)

QTC-MF + MD	(No MB)	..	\$699
QTC-MF + MD6	6 slot MB	..	\$799
QTC-MF + MD8	8 slot MB	..	\$849
QTC-MF + MD12	12 slot MB	..	\$899

Q.T. MAXI-FRAME[™]—Series 800

Desk Top for Dual 8" Drives

- 6, 8, 12 slot Motherboard
- Universal Drive mounts
- Key lock Power Switch
- Heavy Duty Power supply (+8V@16A, ±16V@3A, +5V@5A, -5V@1A, +24V@5A)

QTC-MF + DD1	No MB	\$799
QTC-MF + DD6	w/6 s. MB	..	\$899
QTC-MF + DD8	w/8 s. MB	..	\$949
QTC-MF + DD12	w/12 s. MB	..	\$999

Standard features & Options: All QT mainframes are built on a strong steel chassis with sturdy heavy gauge aluminum covers. Heavy duty power supplies have individually fused outputs and are shielded by an EMI/RFI filter & line surge protector. Standard I/O cutouts include provision for 16 DB 25's, 1 DC 37, 2 DA 15's, centronics parallel, 134 pin and 250 pin IDC ribbon cable connectors. Filtered positive pressure cooling fan. Twin AC outlets provide convenient connection for and control over printer and terminal. Standard colors are charcoal/light grey to match Televideo terminals. Optional colors include brown/tan and federal spec. ivory at extra charge. Constant voltage power available on most models—add \$100.00. EIA rack mount rails available on some units—add \$95.00. Complete OEM customization available on orders of 10 or more units. Contact factory for details and pricing.

Q.T. DISK DRIVE CABINETS AND SUBSYSTEMS



Front—Tandon Panel



Front—no panel



Rear view

Q.T.'s All in One[™]

Universal Disk Drive Cabinet

- Expandable
- Accepts all 8" drives

QT's unique new disk drive cabinet has been designed to accept virtually any 8" drive on the market today from Tandon Thinlines to 40 megabyte Quantums. Features include interchangeable face plates (Qume, Shugart, Tandon, etc.) and "electronics in a drawer" construction to simplify installation and maintenance. Heavy duty power supply will carry any combination of up to four Thinline, two standard, or one hard disk drive with floppy backup. +5V@5A, -5V@1A, +24V@5A.

QTC-DDC8 8V-XX w/one faceplate	\$399.00
Replacement Faceplates (Specify type & number of drives)	\$25.00
Tandon 4-drive power cable	\$15.00
Data Cables available	\$20-50.00



SINGLE 8" VERTICAL CABINET

Size: 11"H 11"W 18"D
 Perfect add-on disk drive for any system. Accepts most brands.
 QTC-DDC8V \$299



DUAL 8" HORIZONTAL DRIVE CABINET

Dimensions: 5"H 17"W 20"D
 Designed to provide basic disk storage capacity for S-100 and other computers. Low profile permits table top stacking.
 QTC-DDC + 88H \$349

Q.T. "ALL IN ONE" EXPANDABLE DISK DRIVE SUBSYSTEM SPECIALS

QTC-DDS + 0 with two single sided Siemens Drive (0.5MB)	\$695
QTC-DDS + 1 with one double sided Mitsubishi Drive (1MB)	\$895
QTC-DDS + 2 with two DSDD Mitsubishi Drives (2MB)	\$1,495

normal BDOS vector at memory location 5. GDOS intercepts all operating-system function calls. If the call is a standard CP/M request, it passes control to BDOS; if the function call is for a graphics operation, GDOS services the request. Because GDOS is loaded below GIOS, memory is automatically allocated for GIOS and GDOS; the size of the transient program area (TPA), determined by the GDOS entry point, is

automatically adjusted. The memory map in figure 4 shows how GDOS and GIOS are loaded into memory at run time below the standard CP/M-80 components, BDOS and BIOS. The GSX extension to CP/M-86 works slightly differently by reserving a special interrupt vector for GSX communications. Also, the memory-management facilities of CP/M-86 take care of loading the GSX modules into the free memory available.

Conclusion

The adoption of the GKS and VDI standards at the programmer and device-interface levels offers potential object-code portability for microcomputer graphics-application programs. Not only will programmers see a consistent interface to graphics functions in their high-level languages, but compilers and graphics run-time libraries can be generic, with device dependencies residing in the operating system. Because of this, each hardware OEM will install the graphics portion of an operating system only once. Compilers and other utilities that conform to the VDI standard will then be able to access the virtual devices of a system without special adaptation. In time, the hardware manufacturer, confident of a stable device interface, will begin to place higher-level functions into the device hardware (or firmware). Eventually, graphics devices may incorporate a full VDI interface, eliminating the need for device drivers entirely.

New products, such as GSX and GSS-Kernel, that are based on the emerging standards, will contribute to the realization of widespread, low-cost computer graphics. In the past, the adoption of formal standards or the emergence of de facto standards has proved to be a powerful market stimulant. Because of its unique emphases on low cost and a competitive software environment, the microcomputer industry is especially sensitive to the benefits of graphics standardization. Graphics users owe a debt of gratitude to the many researchers who distilled an inherently complex technology into a consistent and flexible set of useful constructs. In the end we shall all benefit from the power of computer graphics. ■

FRANCHISE OPPORTUNITIES.



IT'S NEVER BEEN A BETTER TIME!

The computer industry is experiencing a spectacular growth, by 1990 it will become a 20 billion dollar industry. Computer retailing was one of the few industries not seriously effected by the recent economic crisis.

Now . . . is a good time to consider

a franchise opportunity with MicroAge, a leader in computer retailing. MicroAge has a proven "track record" with over thirty franchised stores throughout the United States and Canada. In an industry where experience is crucial, MicroAge has it, with six years computer retail experience and three years in franchising. It's just good sense to go with a leader.

If you're committed to success in computer retailing, it's essential you evaluate the MICROAGE COMPUTER STORES Franchise opportunity. Investment: \$130,000-\$200,000.

For detailed information about MicroAge "Franchise Opportunities," call (602) 968-3168 or write to:

MicroAge Computer Stores Inc.
1425 W. 12th Place
Tempe, AZ 85281

MicroAge[®]
COMPUTER STORE
"The Solution Store"™

Reference

"Graphical Kernel System (GKS)—Functional Description," *Draft International Standard ISO/DIS7942*, version 7.02, August 9, 1982. Copies of this approximately 200-page document can be obtained for \$28 from American National Standards Institute Inc., 1430 Broadway, New York, NY 10018, (212) 354-3300.

FREE MEMORY

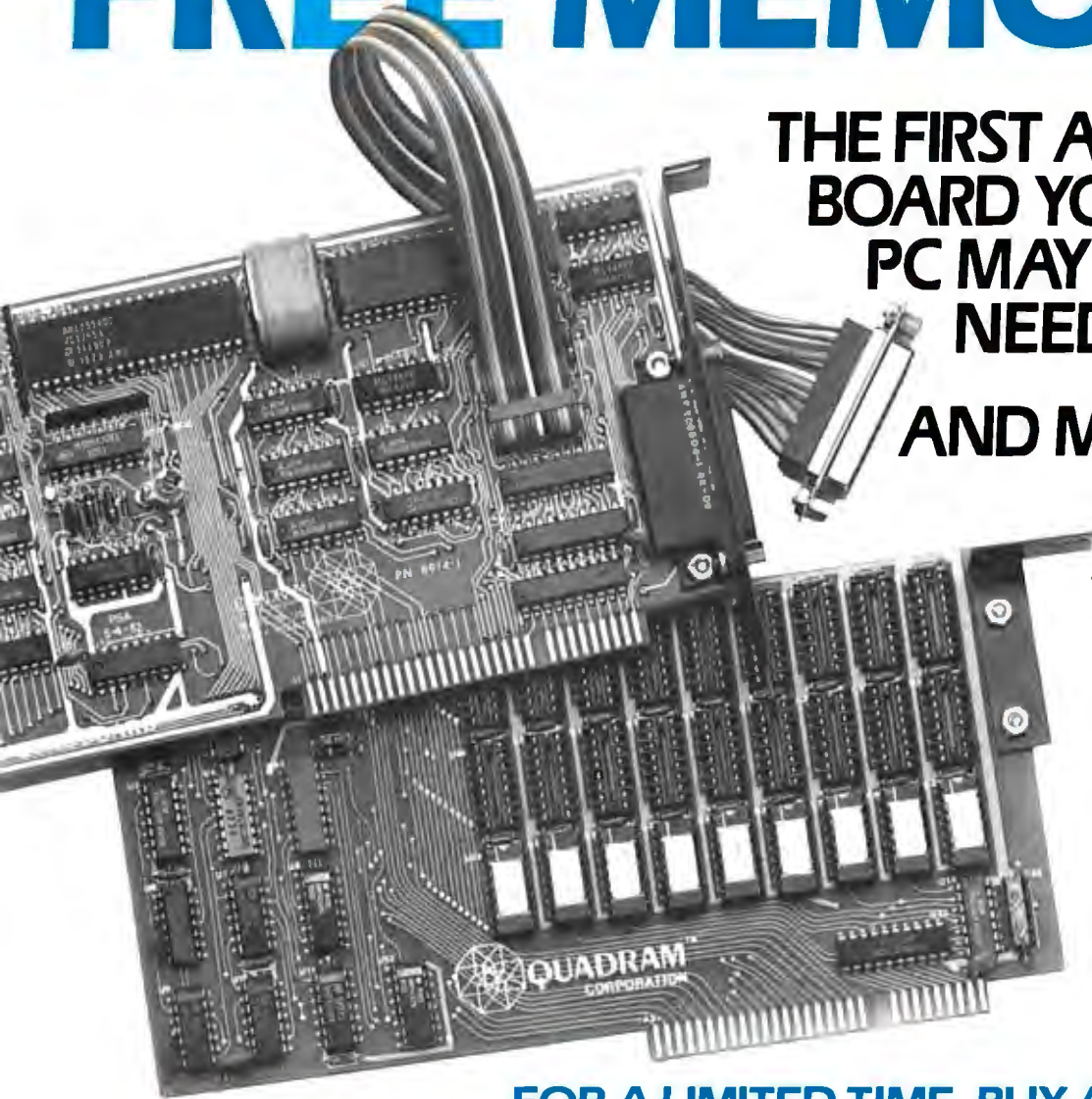

**THE FIRST AND ONLY
BOARD YOUR IBM
PC MAY EVER
NEED...
AND MORE**

**FOR A LIMITED TIME, BUY A 256K
QUADBOARD AND RECEIVE A 64K MEMORY BOARD FREE
OF CHARGE, OR A 192K MEMORY BOARD FOR ONLY \$44.***

In order to receive a free 64K memory board or a 192K memory board for \$44, you must purchase a Quadboard with 256K installed by Quadram from an authorized Quadram dealer between December 1, 1982 and February 15, 1983.

To receive your memory board, send:

- (1) The **original** sales invoice showing dealer name, address, date purchased, and purchase price.
- (2) Coupon from newspaper or magazine (or rebate form available from dealer) completely filled in.
- (3) Proof of purchase (256K label from Quadboard box).
- (4) Warranty card, showing warranty number and all information filled in.
- (5) All receipts, coupons, and proof of purchase forms must be mailed together in order to qualify for a memory board. Must be postmarked no later than March 1, 1983, and received by Quadram by March 15, 1983. Void where prohibited or taxed.

*Quadram suggested retail prices:
256K Quadboard—\$995
64K Memory Board socketed for up to 192K—\$350
192K Memory Board—\$595

Circle 352 on inquiry card.

Name _____	
Address _____	

City _____ State _____ Zip _____	
Please include shipping and handling charge	\$5.00
<input type="checkbox"/> 64K Memory Board	FREE
<input type="checkbox"/> 192K Memory Board	\$44.00
TOTAL _____	
<input type="checkbox"/> Check Enclosed <input type="checkbox"/> VISA <input type="checkbox"/> MasterCard	
Account # _____ Expiration Date _____	
Offer void where prohibited or taxed by law. Expires February 15, 1983. Allow 8-10 weeks for delivery.	

QUADRAM
CORPORATION

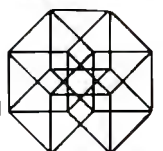

4357 Park Drive/Norcross, Ga. 30093/(404) 923-6666

INTRODUCING THE 103 and 103/212 SMART-CAT™ MODEMS.

**They Do
Everything.
With Less. For Less.**

Take your pick. With either one, you'll get two very important advantages.

First, each is the best modem in its class. They do more, do it easier and do it in less space. The reason: our LSI technology is state-of-the-art. Our Smart-Cats run better and cooler—and will for years.

Second, you can get your hands on either one of them right now. No waiting. Your local dealer has a shelf full.

The price is something else, too. Suggested retail:

The 103/212 Smart-Cat \$595.
The 103 Smart-Cat \$249.



See your dealer today and get yours. He does have a bunch, but it's not unlimited.

SMART-CAT MODEM FEATURES:

- Built-in Dialer (Touch-Tone or Rotary) • Auto Answer
- Direct Connect
- Analog & Digital Loopback Test
- Extensive Software Command Set
- Busy Detect (Allows Modem To Be Programmed To Redial)
- 103 Smart-Cat Modem:
300 Baud, Full Duplex
- 103/212 Smart-Cat Modem:
300 or 1200 Baud, Full Duplex



New Smart-Cat 103 and 103/212 modems.



18664 Oxnard Street, Tarzana, CA 91356

(800) 423-5419

In California: (213) 996-5060
Circle 476 on inquiry card.

Look at what the best modem has been reduced to.

Our engineers have come up with some state-of-the-art LSI technology and a whole new modem.

It's smaller. J-Cat is about 1/5th the size of an ordinary modem. Easy to stick-on, tuck-in, put anywhere you want.

It's better. J-Cat does the things you need for professional performance. No fussing to get it into the right answer or originate mode; it does it automatically. LED's show you status; and audio "beeps" tell you when you reach a busy signal, detect a carrier, get a dial tone, etc.

And you can hook it into any modular RJ11C phone jack.

It costs less. If you've shopped around, you know a modem with close to these features costs \$250 or more. Our LSI technology has let us do the right thing with the price, too. Suggested retail—\$149.

Smaller is definitely better. See your dealer. He has them right now.

Introducing the Novation **J-CAT**TM



J-CAT FEATURES:

- Direct Connect, FCC Part 68 Registered
- Auto Answer
- Auto Search (Originate or Answer Mode)
- Disconnect/Test Key
- Connect/Break Key
- Self-Test
- Audio Line Status Indicator
- Dialtone/Busy Status at Serial I/O Connector
- Off Hook Control at Serial I/O Connector
- Compatible With EIA-RS232C or TTL Interfaces
- Low Power
- And it's from Novation, the world's leader in personal communications.



(800) 423-5419

In California:

(213) 996-5060

Circle 477 on Inquiry card.

18664 Oxnard Street, Tarzana, CA 91356

The IEEE Standard for the S-100 Bus

With industrywide standardization, manufacturers can independently design components that are compatible.

Mark Garetz
Chairman, IEEE-696 Committee
Compupro Division, Godbout Electronics
Oakland Airport, CA 94614-0355

The microcomputer industry got started in late 1974 when a series of articles appeared in *Radio Electronics* magazine describing construction plans for a computer called the Mark 8. It was based on the first commercially available microprocessor, Intel's 8008. Today, the 8008 is obsolete. Nevertheless, the Mark 8 was the first microcomputer to be put within the reach of anyone but employees of a very large company, and response to the magazine articles was tremendous.

Just before the Mark 8 articles appeared, Intel had announced a greatly enhanced microprocessor, the 8080. Les Solomon, who was an editor at competing *Popular Electronics*, decided that his magazine should also publish a computer-construction article, but that it should use the newer 8080. He suggested to Ed Roberts, then the president of a small company called MITS, that Ed's company come up with a microcomputer kit. (MITS, or Micro Instrumentation and Telemetry Systems, usually specialized in electronics for model rocketry but had just published a successful scientific-calculator construction article.) Ed agreed and the Altair 8800 com-

puter was born. The first Altair article appeared in the January 1975 issue of *Popular Electronics* and was an instant success. MITS figured that it might sell a grand total of 200 units. It received more than 200 orders the first day the article appeared!

Pioneer microcomputer builders MITS and IMSAI both chose to use a 100-pin bus to connect motherboard and daughter boards.

The Altair was a modular computer system, meaning that each of the computer's functional blocks was contained on one circuit board, or module. The circuit boards plugged into slots on a motherboard, which connected the various modules (daughter boards) together, with electrical connections made over a group of common lines called the bus. This type of system is described as *bus-oriented*. MITS called its bus the Altair Bus. The designers chose a connector for the motherboard that had

100 pins—not because of any design considerations but rather because they got a good buy on a surplus quantity of them. The layout of the signals on the bus seems as if it were chosen by the printed-circuit-board layout artist rather than a design engineer. The signals themselves are little more than the buffered control, address, and data lines from the 8080 microprocessor. (We are all lucky that Intel did its homework when designing the 8080's architecture.)

Being one of the first commercially available microcomputers, the Altair had many shortcomings. After all, the electronics community was low on the design curve of microprocessor systems. Learning from MITS's mistakes, designers in a company called IMSAI (IMS Associates Inc.) decided they could build a better version of the Altair and proceeded to do so. Luckily the IMSAI designers decided to "second source" the Altair and used the same bus in their computer, which was called the IMSAI 8080.

Meanwhile, many other small companies appeared, advertising add-on boards designed to work in both Altairs and IMSAIs. The bus was soon being called the Altair/IMSAI



THE SOLUTION IS IN THE VISISERIES.

No matter what kind of problems you're trying to solve with an IBM Personal Computer, there's a program in the ever-expanding VisiSeries™ line that will give you the solution. Faster, better, smarter.

Take our VisiCalc® program for the IBM Personal Computer. It's #1 in the business. Because it takes the work out of working with business numbers. The VisiCalc program is the powerful "electronic worksheet" that speeds planning and budgeting. You can ask "what if?" and see the answers immediately. So you can analyze the impact of decisions before you make them.

Our VisiTrend/Plot™ program makes it easy to analyze data and see the results in easy-to-understand charts and graphs.

With our VisiFile™ program you can organize, maintain and more effectively use the information your business needs.

Is a lot of your workday taken up

with scheduling projects and estimating costs? Our VisiSchedule™ program will help you do it better, with a lot less work.

And for helping you manage your valuable time, organize your personal information, nothing could be of more value than our VisiDex® program.

Our VisiCalc Business Forecasting Model™ package will give you vital financial information about your business.

And our Desktop/Plan™ program will speed and automate all your financial and business planning.

Put the VisiSeries programs to work on your IBM Personal Computer.

Get all the details from your VisiCorp retail computer dealer. Or write Customer Services, VisiCorp, 2895 Zanker Road, San Jose, CA 95134.

THE VISISERIES
FOR THE IBM
PERSONAL COMPUTER
FROM
VISICORP™



EMPLOYMENT OPPORTUNITIES

Project Manager

HP 3000

Standard & Poor's Corporation, the leader in the financial information products and services field has an opportunity for a proven Computer Professional to join its Technical Planning Group in New York City. This position will have multi-project management responsibility in our financial products development area and requires an assertive communicator who can inspire the confidence of management as well as the trust of subordinates.

Ideal candidates will have a solid HP 3000 programming background in FORTRAN with IMAGE and successful full project life cycle management experience in developing financial systems. A bach-

elor's degree in a quantitative discipline is essential; an advanced degree is preferred.

Position is located in New York City and provides relocation assistance.

We offer a highly competitive salary, a state-of-the-art operating environment and comprehensive company benefits. For immediate consideration please forward a detailed resume, including salary history and requirement in confidence to: Employment Coordinator, Standard & Poor's Corporation, 25 Broadway, New York, N.Y. 10004

An Equal Opportunity Employer m/f



Standard & Poor's Corporation

For only . . .

\$1064

your recruitment ad in this 4" space will reach 300,000 qualified readers just like yourself.

To place your ad call 212-997-2556, or send your copy to the address below.

BYTE

P.O. BOX 900, NY 10020

**Let
McGraw-Hill's
Classified
Ads Work
For You**

bus. Many other companies also produced bus-compatible computers and products, and each wanted to tack its name on as well. Names such as the Altair/IMSAI/Cromemco/Polymorphic/Processor Technology bus were not uncommon. The situation was clearly getting out of hand.

Roger Mellen, one of the principals of Cromemco, decided that a generic name was needed for the bus. His idea was to call it the Standard 100 bus, or S-100 for short (100 because it had 100 pins). The name caught on.

All the various manufacturers of S-100-compatible products had adhered to the bus pin arrangement fairly well. Only a few minor variations existed, and most of these were compatible additions using previously unused lines. However, although the various manufacturers used the same names for the signals, the timing of the signals could vary widely from manufacturer to manufacturer. This created many problems for people trying to get Board X to work with Board Y, etc. Something had to be done.

Bob Stewart, then chairman of the IEEE (Institute of Electrical and Electronics Engineers) Computer Standards Committee, suggested to George Morrow and Howard Fullmer (two noted S-100 designers) that they attempt to quantify the bus-timing relationships and other aspects of the bus and submit the bus for approval as an IEEE standard. The IEEE thought it was a good idea, and so did George and Howard, so a task number was assigned to the effort and a working group was formed to draft the standard. The task number was 696, and the standard will be known as IEEE 696.

The working group prepared a preliminary draft and passed it around for comments to everyone working with the S-100 bus. John Walker of Marinchip Systems proposed a method for allowing 16-bit processors and memory to use the bus as well as 8-bit processors. David Gustavson proposed a scheme that would allow up to 16 DMA (direct memory access) devices to exist on the bus at any one time. A few new signals were proposed by Kels Elmquist of Ithaca In-

GIFFORD COMPUTER SYSTEMS

Multi-user computers that keep pace with business and technology.

Not all computers can lead your business into the future.

Buying a multi-user computer system is a big investment. In time, training, and money. So you'd better choose a system that won't become obsolete.

Circle 183 on Inquiry card.

HARDWARE

8 MHZ 16 bit (8088) CPU
6 MHZ 8 bit (8085) CPU
Up to 1 megabyte 10 MHZ static RAM
2.4 Megabytes of IBM compatible 8 inch floppy disk storage
Up to 80 Megabytes Winchester disk storage
20 slot IEEE 696/S-100 bus
9 RS-232C serial ports

16 bits — Financial planning



16 bits — Accounting

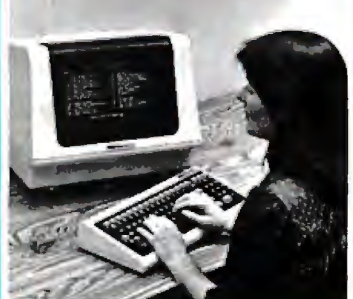

SOFTWARE

MP/M™ 8-16™ including
CP/M-80™
CP/M-86™
MP/M-86™
dBASE II™ Data Base Management
SuperCalc™ Financial Planning
WordStar™ Word Processing (optional)

8 bits — Word processing



8 bits — Graphics



You can begin your investment with a single user installation. Then, you can add up to 6 more terminals as your business grows. And you can add more memory as you need it.

It does the job of two generations of computers at the same time.

With a Gifford Computer System you can use any of the thousands of 8 bit CP/M® programs available. And any of the faster 16 bit CP/M programs, too. If you're using

CP/M already, your investment in training, software and data is protected.

Our systems are designed with your future in mind. With our bus-based system, as new technology becomes available it can be integrated into your computer at an affordable price—protecting your hardware investment.

You get all the support you'll ever need.

We have centers in San Francisco and Los Angeles, with

complete demonstration and support facilities. Call now for a demonstration.

Gifford Computer Systems. We're in business for your future.

MP/M 8-16 is a proprietary implementation of MP/M-86 and was configured for CompuPro by G&G Engineering. CP/M and MP/M are registered trademarks of Digital Research. SuperCalc is a trademark of Sorcim. WordStar is a trademark of MicroPro International Corp. dBASE II is a trademark of Ashton-Tate. CompuPro is a trademark of Godbout Electronics.

Gifford Computer Systems is an authorized CompuPro Systems Center.

GIFFORD

COMPUTER SYSTEMS

A division of

G&G ENGINEERING

1922 Republic Avenue,
San Leandro, CA 94577
(415) 895-0798

My business needs a computer it can grow with.
Please send more information by

Name _____ Company _____
Title _____
Address _____
City _____ State _____ Zip _____
 I am currently using CP/M.

A Quick Reference to the IEEE-696 Bus Layout

Here is a guide to the IEEE-696 bus layout for easy reference. The letters RFU stand for "reserved for future use"; the IEEE committee may assign signals to these pins at some future date. The letters NDEF mean "not defined"; these pins are available to be assigned signals by manufacturers, a procedure that requires notifying the committee and providing full documentation for the users. The asterisk (*) indicates a negative-true signal; note that some signals are not necessarily true or false, although the lack of an asterisk in their name might imply positive-true sense.

Pin	Signal Name	Origin				Pin	Signal Name	Origin			
		master	slave	master or slave	anywhere			master	slave	master or slave	anywhere
1	+ 8 V				X	51	+ 8 V				X
2	+ 16 V				X	52	- 16 V				X
3	XRDY		X			53	0 V				X
4	VI0*		X			54	SLAVE CLR*				X
5	VI1*		X			55	TMA0*	X			
6	VI2*		X			56	TMA1*	X			
7	VI3*		X			57	TMA2*	X			
8	VI4*		X			58	sXTRQ*	X			
9	VI5*		X			59	A19	X			
10	VI6*		X			60	SIXTN*		X		
11	VI7*		X			61	A20	X			
12	NMI*		X			62	A21	X			
13	PWRFAIL*				X	63	A22	X			
14	TMA3*	X				64	A23	X			
15	A18	X				65	NDEF				
16	A16	X				66	NDEF				
17	A17	X				67	PHANTOM*			X	
18	SDSB*	X				68	MWRT				X
19	CDSB*	X				69	RFU				
20	0 V				X	70	0 V				
21	NDEF					71	RFU				
22	ADSB*	X				72	RDY		X		
23	DODSB*	X				73	INT*		X		
24	φ	X				74	HOLD*	X			
25	pSTVAL*	X				75	RESET*				X
26	pHLDA	X				76	pSYNC	X			
27	RFU					77	pWR*	X			
28	RFU					78	pDBIN*	X			
29	A5	X				79	A0	X			
30	A4	X				80	A1	X			
31	A3	X				81	A2	X			
32	A15	X				82	A6	X			
33	A12	X				83	A7	X			
34	A9	X				84	A8	X			
35	DO1 (or ED1)	X		(X)		85	A13	X			
36	DO0 (or ED0)	X		(X)		86	A14	X			
37	A10	X				87	A11	X			
38	DO4 (or ED4)	X		(X)		88	DO2 (or ED2)	X		(X)	
39	DO5 (or ED5)	X		(X)		89	DO3 (or ED3)	X		(X)	
40	DO6 (or ED6)	X		(X)		90	DO7 (or ED7)	X		(X)	
41	DI2 (or OD2)		X	(X)		91	DI4 (or OD4)		X	(X)	
42	DI3 (or OD3)		X	(X)		92	DI5 (or OD5)		X	(X)	
43	DI7 (or OD7)		X	(X)		93	DI6 (or OD6)		X	(X)	
44	sM1	X				94	DI1 (or OD1)		X	(X)	
45	sOUT	X				95	DI0 (or OD0)		X	(X)	
46	sINP	X				96	sINTA	X			
47	sMEMR	X				97	sWO*	X			
48	sHLTA	X				98	ERROR*		X		
49	CLOCK				X	99	POC*			X	
50	0 V				X	100	0 V			X	



“A Database That Catches Mistakes? That's My Qbase.”

Presenting Qbase™ The Personal Database And Reporting System
That Prevents Mistakes Before They Become Expensive. Just \$189 Complete.

There's no question that databases are useful tools for storing and retrieving information. Thousands of professionals use databases to monitor inventory, manage mail lists, record fixed assets, and keep track of personnel records.

So what's the problem?

NOT ALL DATABASES ARE CREATED EQUAL

In hundreds of personal computer applications, users agree on one thing: there's nothing more aggravating than a database that lacks all the features to do the job that needs to get done.

And of all the database features used by experienced users, none is more often called for than data entry checking.

Why is that so important? Because experienced users know how many aggravating hours they can waste fixing mistakes that their database should have caught.

Fortunately there's Qbase, the only full-feature database in its price range that can substantially reduce common input errors.

PREVENT DATABASE CONTAMINATION

Qbase uses sophisticated data checking features normally found on large systems. Functions that catch invalid alphanumeric sequences. Check for minimum/maximum number lengths. Enforce data inputs where mandatory. Require date formats. Allow for yes/no replies. And verify that alphabetic and numeric values lie within pre-specified ranges.

And then we added an embedded calculator that automatically computes taxes and commissions. It even **accepts** credits and debits against balances **due**.

And reports? Qbase includes a powerful reporting facility—at no extra charge. With it, you can produce sorted reports with sub-totals AND totals. Moreover, all report definitions are fully documented and stored in a library. So there's no guessing which report does what. Just call for your favorite report and it's done.

Write or call for your free brochure, "How To Keep Errors Out Of A Database." See for yourself what data checking can do to save you time and aggravation. Write to:

Applied Software Technology
14125 Capri Drive
Los Gatos, CA 95030
or call 408/370-2662

NAME _____

COMPANY _____

ADDRESS _____

CITY _____

STATE _____ ZIP _____

PHONE (AREA CODE) _____

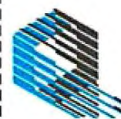

Qbase
Personal Database/
Reports

For Use With IBM PC and APPLE II

Main/Frames

Main/Frames

from
\$200

- 30 Models of Enclosures
- Assembled and tested
- Quasi-Coax Motherboards
- Power Supply
- Card cage and guides
- Fan, line, cord, fuse, power & reset switches



8" Floppy Main/Frame
\$482



8" Disc Enclosure
\$250



\$525
Phase/80 8" Floppy Mainframe



\$900
Phase/80 Desk + Mainframe

Write or call for our brochure which includes our application note:
"Building Computers — A Recipe"

INTEGRAND

8620 Roosevelt Ave. • Visalia, CA 93291
209/651-1203

We accept BankAmericard/Visa and MasterCard

tersystems (then known as Ithaca Audio). The second draft of the document that came out of the working group contained important additions and enhancements to the original Altair bus but still retained a significant level of compatibility with older designs. (The original Altair processor board still conforms to today's standard.)

This second draft was published in the July 1979 issue of the IEEE's *Computer* magazine for public comment. There were lots of comments, mostly favorable. The 1979 draft needed lots of work. Definitions were unclear in places, and many additional parameters needed to be specified. The committee grew; George resigned as chairman, and Howard took over. Meetings were sporadic, but heated debates occurred on some issues, preventing other work from being accomplished. Howard called for a final meeting to occur on June 30, 1981, at 10:30 a.m. All final comments on the draft were to be submitted in writing prior to that date.

More than 20 people were present at that meeting from all parts of the country. The meeting began at 10:30 a.m. and ended around 11:30 that evening. All the issues had been resolved to everyone's satisfaction. I volunteered the services of Comupro (the company I work for, in Oakland, California) to produce a third draft of the standard, incorporating all the changes approved at the meeting.

Now the activities of the committee entered a period of dormancy. Howard took a long time in organizing his notes of the various changes; he was losing interest in chairing the committee (having moved out of the S-100 business some time before) and so turned the chairmanship over to me. With the help of Bob Davis, I prepared the third draft of the standard and sent it out to the members of the working group for comment. Changes were still necessary. After spending many hours on the phone to various committee members, draft 5 was completed and sent out for a vote for final approval by the working group. It passed with only one dissenting vote.

The next step was to submit it to the Microprocessor Standards Committee of the IEEE for approval. It passed unanimously. Next the draft was submitted to the Computer Standards Committee and was accepted. The last hurdle was the IEEE Standards Board, which passed the draft on December 9, 1982. With that vote, IEEE 696 became a bona fide IEEE standard.

Technical Features of the Bus

The IEEE-696/S-100 bus is one of the highest-performance buses in existence today. It supports both 8- and 16-bit processors, up to 16 megabytes of memory, and 64K I/O (input/output) ports. Almost every type of processor imaginable, from the 8080 to the latest Intel iAPX 286, is available for the bus. There are more than 100 active manufacturers of products for the bus and many more than 500 different circuit cards available.

IEEE-696/S-100 systems consist of anywhere from 4 to 22 slots. Each system must contain a *permanent bus master*, which is usually the processor board. The system will have some memory and I/O boards called *slaves*. In addition to the permanent master, the system may contain up to 16 *temporary masters*, DMA-like devices, such as disk controllers or secondary processors. As many as 16 temporary masters may exist because each is assigned a priority number. If more than one temporary master requests the bus at the same time, the one with the highest priority number will take precedence, and the lower priority master will have to wait its turn. (This process is called *arbitration*.)

Because a temporary master can perform any type of cycle when it gets control of the bus (not just a memory cycle), the committee deemed the term DMA inappropriate and substituted the term TMA (for temporary master access). Four new lines were added to the bus to implement this arbitration scheme, TMA0* through TMA3* (the style of the standard defines any signal with an asterisk suffix as negative-true, a style I will use in this article). Each temporary master asserts its priority on

GOOD NEWS

Have you put aside buying a color monitor because it's too expensive? But, have you looked at the new TAXAN RGBvision color monitor? Would you be excited at a suggested retail price of \$399.00 for the RGBvision I, and \$599 for the RGBvision II?



DO WE HAVE GOOD NEWS FOR YOU!

For those low prices, you can have:

- Full compatibility with Apple III and IBM PC without interface modules
- Compatible with Apple II through the TAXAN "RGB-II" card
- RGBvision I medium resolution - 380(H) lines
- RGBvision II high resolution - 510(H) lines
- Unlimited colors through linear amplifier video circuit and 16 colors for Apple III and IBM PC
- 12-inch, 90° deflection CRT display

Can you really afford to turn all that down without looking at the TAXAN RGBvision monitors? See your local dealer for a demonstration.



TAXAN 12" green phosphor monitor, model KG12N, features an 800 line resolution at center, 2000 character display



TAXAN

TSK ELECTRONICS CORPORATION

1524 Highland Avenue
Duarte, California 91010
A subsidiary of Kaga Denshi

Apple II and III are trademarks of Apple Computer, Inc.
IBM PC is a trademark of International Business Machines, Inc.

QUADBOARD™

THE FIRST AND ONLY BOARD YOUR IBM PC MAY EVER NEED.

Your IBM personal computer is a very versatile piece of equipment. Perhaps more versatile than you realize. New applications and functions are being developed every day. Now with Quadboard

by Quadram you can keep your options open for tomorrow's technology. Following in the tradition of Quadram Quality, four of Quadram's best selling IBM boards have been combined into one board. Your remaining slots will be left free and available to accommodate future expansion needs and uses which you may not even be able to contemplate today.

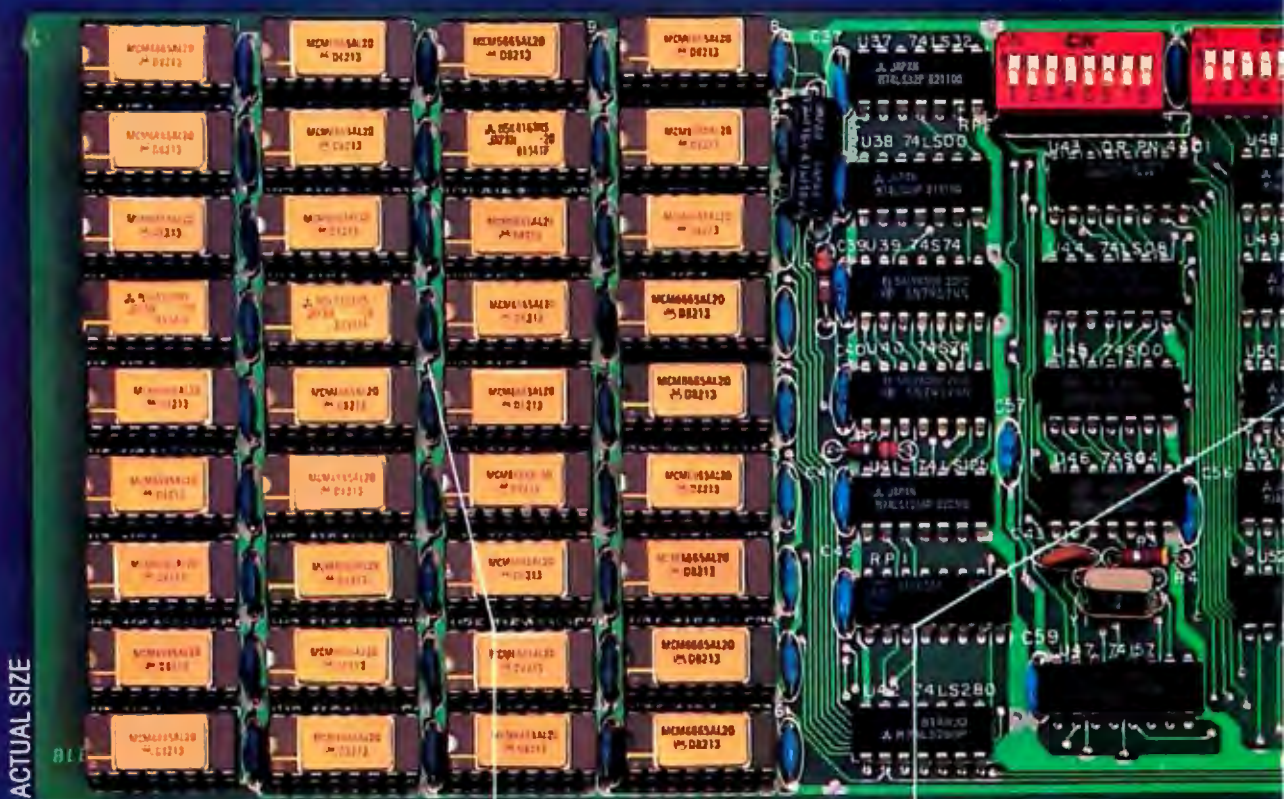

PROVEN DESIGN.

Quadram has been shipping IBM boards with each of the Quadboard functions on separate boards since December, 1981. They are still available as separates (including a Dual Port Async Board) for those who desire a quality board but do not need to keep slots open for future expansion. And they all come with a one year warranty from the leader in technology applications.

256K MEMORY EXPANSION.

Socketed and expandable in 64K increments to 256K, full parity generation and checking are standard. A Quadboard exclusive feature allows parity to be switch disabled to avoid lock-up upon error detection. The dip switches also allow it to be addressed starting on any 64K block so that it takes up only as much as it has memory installed. Memory access and cycle time naturally meet all IBM specifications.

CLOCK/CALENDAR.

Quadboard eliminates the hassle of manually inputting the date on system boot-up by providing for the clock and all software routines necessary for inserting the appropriate programs on your diskettes. The internal computer clock is automatically set for compatibility with most software routines which utilize clock functions. On-board battery keeps the clock running when the computer is off.

BY QUADRAM

ALL ON ONE BOARD

Now you can utilize all the PC's capacity with Quadram's extremely flexible configurations. And it's totally compatible with IBM hardware, operating systems, and high level languages. It's a full-size board that can be inserted into any free system slot and it even includes a card edge guide for securely mounting the card in place.

SOFTWARE TOO!

With Quadboard you receive not only hardware but extensive software at no extra cost. Diagnostics, utilities, and Quad-RAM drive software for simulating a floppy drive in memory (a super-fast SOLID STATE DISK!) are all part of the Quadboard package.

\$595

with 64K
Installed



PARALLEL PRINTER I/O.

A 16 pin header on Quadboard is used for inserting a short cable containing a standard DB25 connector. The connector is then mounted in the knock-out hole located in the center of the PC back-plane. The parallel port can be switch disabled or addressed as Printer 1 or 2. No conflict exists with the standard parallel port on the Monochrome board. The internal cable, connector and hardware are all included.

ASYNCHRONOUS (RS232) COMMUNICATION ADAPTER.

Using the same chip as that on the IBM ASYNC board, the device is software programmable for baud rate, character, stop, and parity bits. A male DB25 connector located on the back connector is identical to that on the IBM Async Adapter. The adapter is used for connecting modems, printers (many letter quality printers require RS232), and other serial devices. Switches allow the port to be configured as COM1 or COM2 and the board fully supports IBM Communications Software.

INCREDIBLE PRICE!

Priced at \$595 with 64K installed, \$775 with 128K, \$895 with 192K and \$995 with 256K.

ASK YOUR DEALER.

All products are sold through local personal computer dealers. If yours does not stock Quadram, please ask him to call us at (404) 923-6666.

QUADRAM
CORPORATION



4357 Park Drive/Norcross, Ga. 30093
Circle 353 on Inquiry card.

these lines, while simultaneously evaluating whether another master asserting a higher priority is on the line. If a temporary master sees that its priority is not the highest, it defers to the higher priority.

Formerly, memory slaves responded to only 16 address bits (giving the system a total memory capacity of 64K bytes). The new standard defines an additional 8 address lines, called the *extended address bus*. Now the memory capacity of the system is 16 megabytes.

In the past, I/O slaves responded to only 8 address bits, giving a total of 256 I/O port locations. Now 16 address lines may be used, upping the number to 64K I/O ports.

8- and 16-Bit Operation

One of the more significant changes to the original bus was the addition of a mechanism for performing 16-bit data transfers between masters and slaves. To explain this, first we need to explore how the bus does 8-bit transfers.

The IEEE 696 has two 8-bit data buses. For 8-bit transfers, the DO (data-out) bus carries data from the master to a slave, and the DI (data-in) bus carries data from a slave to a master. Because data always flows in one direction, these buses are called *unidirectional*. For 16-bit transfers, these two buses become *bidirectional*, meaning that data can flow in or out, depending on the type of cycle in progress, and are combined so that two 8-bit buses are now capable of transmitting or receiving 16 bits of data.

To accomplish this bidirectional flow, two new lines were added to the bus. They are sXTRQ* (sixteen request) and SIXTN* (sixteen acknowledge). Here's how the mechanism works: If a master is capable of conducting a 16-bit transfer and desires to do so (16-bit processors don't always want to transfer 16 bits at a time), it will send the signal sXTRQ*, telling the addressed slave that a 16-bit transfer is requested. If the slave is capable of 16-bit operation, it will respond by asserting the SIXTN*

line. The master will look at the SIXTN* signal and, if the signal is true, will conduct a 16-bit-wide transfer. If the master sends the signal sXTRQ* and the slave is not capable of 16-bit transfers, SIXTN* will not be asserted. The master can then do one of two things. The desired response would be to perform the 16-bit transfer as two sequential 8-bit transfers, called *byte-serial* transfers. The other option is to assert the ERROR* line and transfer control to some error-recovery routine.

This protocol is completely compatible with older 8-bit slaves. Eight-bit slaves will not have any circuitry for driving the SIXTN* line, and because SIXTN* is active low, a 16-bit master will properly assume that 16-bit transfers are not possible. This also allows for both 8- and 16-bit slaves to be mixed in a system, assuming the master has "byte-serializer" circuitry.

This basic 16-bit transfer protocol was agreed to by everyone in the working group very early on, but

SB-80/4 The affordable singleboard microcomputer with multi-user, multi-tasking muscle and brains.

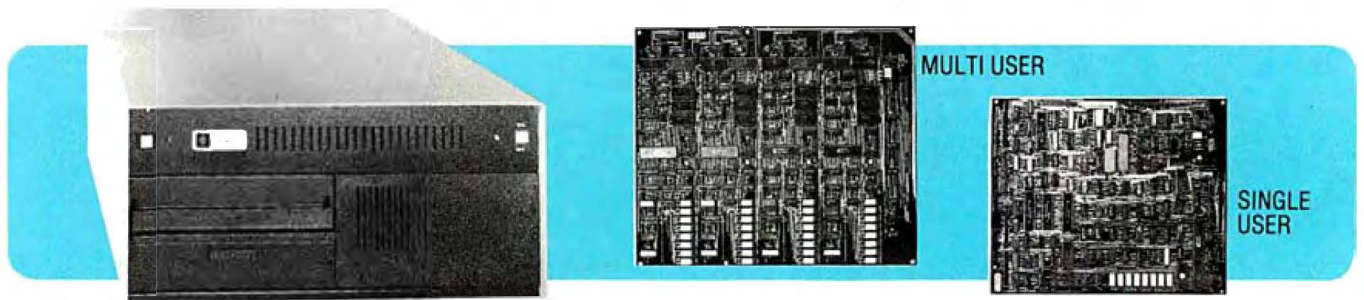

SB-80/4 A complete microsystem for the user who demands speed and storage capacity in single or multi-user applications. Choose our true CP/M® compatible MuLti/NET™ or TurboDOS™ operating system.

Single Board Technology This multiprocessor board allows each user (up to four) a dedicated Z80A microprocessor and 64K of RAM. The master-slave architecture, residing in the same enclosure, supervises all user requests for storage and peripherals through four channel DMA.

Memory and Disk Storage 320K of 200ns dynamic RAM combined with five (5) Z80A microprocessors provides the hardware to independently multi-task the operation. On board interface for Winchester type disk controller

allows from 5 to 104 megabytes of storage for applications that require large database files and records. The four parallel and six serial ports provide the muscle to support numerous peripherals.

Software InfoSoft's MuLti/NET provides the most efficient multi-processor operating system. Software 2000 Inc.'s TurboDOS offers speed and performance.

*Dealer and OEM inquiries are welcome.
Nationwide field service through INDESERV.*



Colonial Data Services Corp., 105 Sanford Street, Hamden, Conn. 06514 • (203) 288-2524 • Telex: 956014
™ MuLti/NET is a Trademark of InfoSoft Systems, Inc. ©CP/M is a registered trademark of Digital Research, Inc. **TurboDOS is a trademark of Software 2000 Inc.

THE ULTIMATE COMBINATION

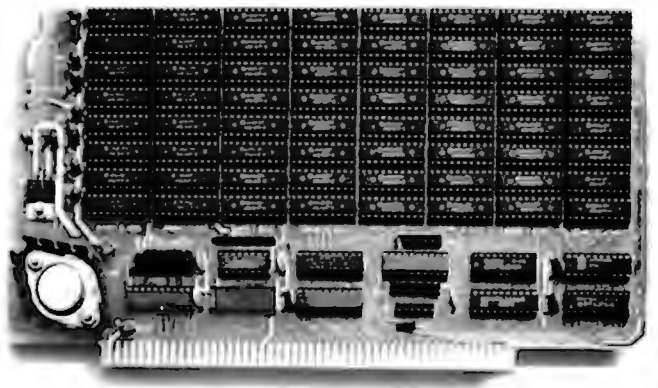
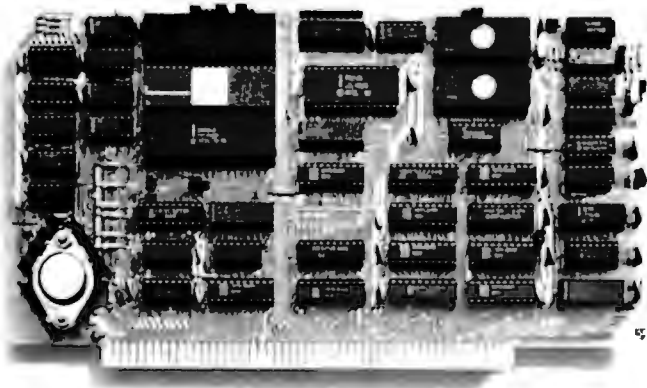

Lightning One* and RAM67

If you have an application problem you can't solve with an eight bit system, try our 16 bit combination. There is no faster combination currently available on the S100 bus and we have benchmarks to prove it.

The *Lightning One** is a state-of-the-art, 8086 S100 bus CPU board. The high speed 8087 floating point processor adds the numeric processing capability of large mini computers and the 8089 I/O processor adds I/O channel capability only found on large mainframes.

RAM67 is our high speed low power CMOS STATIC RAM board. 128K bytes of battery backupable memory are packed on one board. Speedy? Our RAM67 has over 100 ns margin when used with our 10 MHz *Lightning One* CPU Board.

Call or write for more information on The Ultimate Combination: *Lightning One* and RAM67. Lomas Data Products offers a full line of quality S100 bus products . . . systems, software and other "no-nonsense" boards.

LDP

LOMAS DATA PRODUCTS,
INC. □ 66 Hopkinton Rd.
Westboro, Massachusetts 01581 (617) 366-6434

Dealer and OEM inquiries are invited.

*Trademark of Lomas Data Products, Inc.

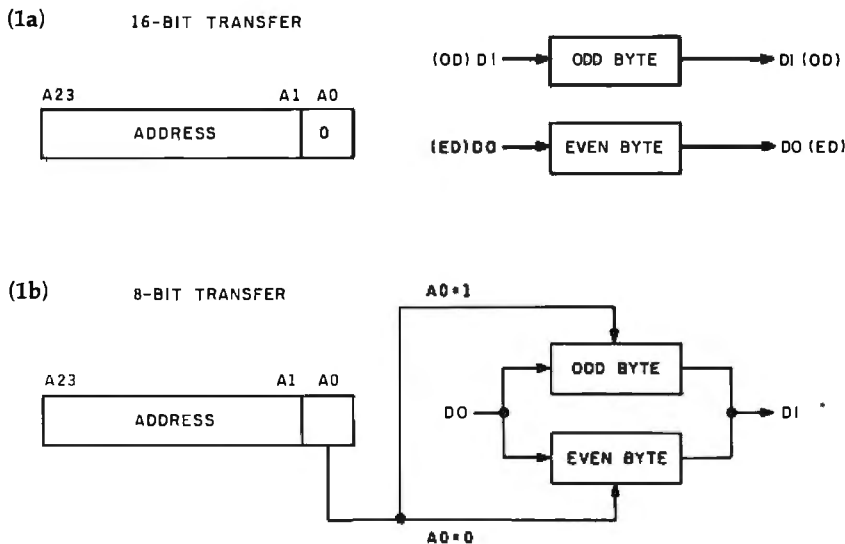

Figure 1: Data transfers as performed according to the IEEE-696 standard. In figure 1a, a 16-bit transfer is shown using all of the available data lines. Data whose least-significant address bit is 0 is considered even, while data whose least-significant address bit is 1 is considered odd. Figure 1b shows how the odd and even bytes are employed during an 8-bit-wide transfer of 16-bit data (called a byte-serial transfer).

heated debate took place about what byte should be where (i.e., should the low-order byte be transferred on the DI or the DO bus?).

The problem arises because different microprocessors do things completely differently. For example, the 8080-type 8-bit processors always store 16-bit values with the low-order byte first. So does Intel's 8086/88 family of processors. But along came Motorola's 68000, which stores the high-order byte first. The working group was faced with the problem of deciding which to favor. Naturally, there were proponents of both in the working group.

The group's final solution was both clever and unique in that it made everybody happy. The first published draft had renamed the lines of the DI and DO buses DATA0 through DATA15 during 16-bit transfers. DATA0 through DATA7 were called the low byte (and were transferred on the DO bus), and DATA8 through DATA15 were called the high byte (and were transferred on the DI bus). These signal names and byte designations carried an implied significance: DATA0 through DATA7 were lower than DATA8 through DATA15, and "low" is clearly lower than "high."

The committee decided to rename the signals to be free of this implication and be concerned only with making sure that bytes and words always got read or written in a consistent manner.

The low byte became the *even byte*, and the high byte became the *odd byte*. The even-byte lines are now called ED7 through ED0 (ED for even data), and the odd-byte lines are now called OD7 through OD0 (OD for odd data). Even data is transferred on the DO bus, and odd data is transferred on the DI bus.

Where did even and odd come from? Well, it has to do with how the bytes would be read or written as a *byte* (i.e., in 8-bit mode). During 16-bit transfers, address line A0 is always low. During 8-bit transfers, if A0 is low, that byte is an even byte (because any address where A0 is low would be even). Conversely, if A0 is high, that byte is an odd byte. It is up to the processor-card designer to ensure that data read or written 16 bits at a time has the "even" data on the ED lines (DO bus) and "odd" data on the OD lines (DI bus).

Figure 1 is a block diagram of where the bytes go for 8- and 16-bit cycles. Figure 2 shows a block

diagram of how a typical slave would be set up to handle 8- and 16-bit transfers. In figure 2, the signal SEL selects either the A input (for 16-bit transfers) or the B input (for 8-bit transfers). The control signals employed must obey the following logic equations:

$$\begin{aligned}
 A &= 16_{RD} + (8_{RD} \cdot A0) \\
 B &= 8_{RD} \cdot \overline{A0} \\
 C &= 16_{RD} \\
 E_{WR} &= 16_{WR} + (8_{WR} \cdot \overline{A0}) \\
 O_{WR} &= 16_{WR} + (8_{WR} \cdot A0)
 \end{aligned}$$

where:

$$\begin{aligned}
 16_{RD} &= \text{device select} \cdot sXTRQ^* \cdot pDBIN \\
 8_{RD} &= \frac{\text{device select}}{sXTRQ^*} \cdot pDBIN \\
 16_{WR} &= \text{device select} \cdot sXTRQ^* \cdot pWR^* \\
 8_{WR} &= \frac{\text{device select}}{sXTRQ^*} \cdot pWR^*
 \end{aligned}$$

Designers should take note that the state of A0 as shown in these new diagrams is the opposite of what is shown in the 1979 draft. It has been changed since the 1979 draft and is correctly shown in figures 1 and 2.

It is important to realize that this new terminology does not change how 16-bit transfers occur on the bus but just changes the way we think about them.

Other Technical Changes

The committee debated whether or not the PHANTOM* line (pin 67, see table 1, pages 288 and 292) should disable memory slaves for both read and write operations, or just read operations. We decided to require memory slaves to be disabled for both read and write cycles during PHANTOM*. The timing of PHANTOM* was also specified as not occurring later than 30 ns (nanoseconds) before a read or write strobe and not going away until at least 30 ns after the read or write strobe goes away. The committee specified this timing to ensure that false reads or writes do not occur on memory slaves. In addition, the committee required that all normal memory slaves (as opposed to PHANTOM* slaves) have the capa-



THE TRUMP CARD FOR IBM PC



PDS UNIVERSAL introduces TRUMP CARD IBM* compatible,
256K RAM, + serial I/O + game I/O board.

\$499.00

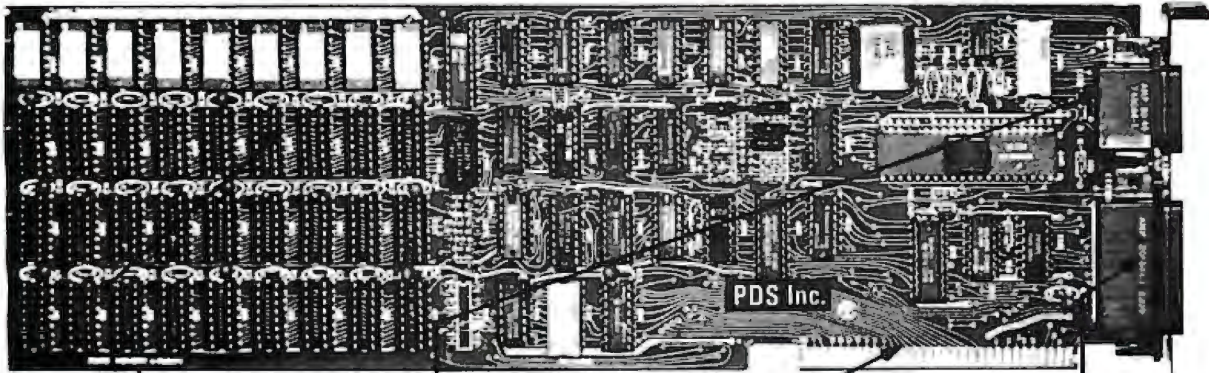

256K RAM

A 64K to 256K parity checking RAM is fully socketed for easy memory expansion. The memory address is switch selectable, using up only the required memory space.

GAME I/O

Interface consisting of two joy-sticks and four switch inputs are IBM BASIC compatible. A standard GAME I/O DB15 connector provides connection to the rear plate of the IBM computer.

GOLD IBM INTERFACE

Gold connectors as well as glass epoxy PCB will provide years of reliable service, with all hardware interface meeting the IBM specification.

ASYNCHRONOUS COMMUNICATION

A RS232 and 20Ma (TTY) interface supports software programmable baud rates, parity, stop bits, and character. Modem and serial printer are fully supported by the IBM communication software. A standard DB25 connector allows for the easy connection to serial devices.

Q TRUMP CARD - 1 is the most cost effective memory card available for your IBM-PC. The Trump Card 1 comes complete with 256K Ram, a Synchronous (RS-232C) Serial port and a Game I/O port. **\$499.**

K TRUMP CARD - 5 comes complete with 256K Ram, Asynchronous (RS-232C) Serial I/O, Parallel I/O, Clock/Calendar with battery back-up and a Game I/O port. The fully populated TC-5 is yours for only **\$599.**

A TRUMP CARD - 7 features 512K Ram and an Asynchronous (RS-232C) Serial port on one fully populated interface card for your IBM-PC. **\$699.**

THE QUALITY IS EXCELLENT AND PRICES MATCH THE ECONOMY.

The Trump Cards Are Available At CompuShack Stores Around The World, Or Any Fine Computer Store In Your Area

*IBM is a trademark of IBM Corp.

For Further Information Contact:
PDS Universal, Inc.

2630 Walnut Ave., Suite G
Tustin, CA 92680
(714) 730-6772

Telex 18-3511 answer back CSMA

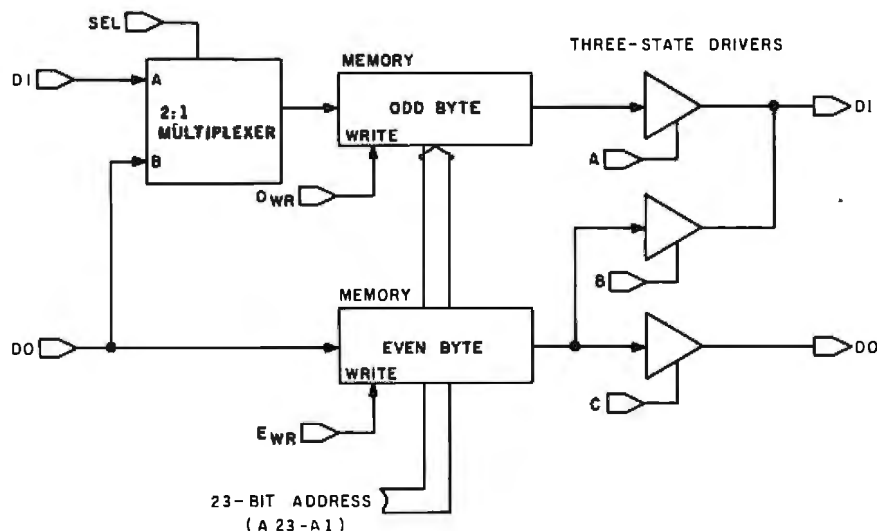

Figure 2: Block diagram of the circuitry needed by S-100 bus slaves for byte and word transfers under the IEEE-696 standard.

bility of being disabled in response to a PHANTOM* signal.

A new signal was defined in the 1979 draft called PWRFAIL*, which should go low 16 ms (milliseconds) before the power goes away. (Note that this time is shorter than the time originally published.) A problem was discovered in actual implementations of this signal: when power momentarily dips just low enough to cause the PWRFAIL* signal to be activated but doesn't actually go away, PWRFAIL* returns high again. But the system is now waiting for a POC*

(power-on-clear) signal that won't ever happen because power never went low enough.

The solution to this was to specify that the rising edge of PWRFAIL* (which will occur at the end of the power dip) shall cause POC* to be asserted. We chose the rising edge rather than just the low level of PWRFAIL* because otherwise no time would be available to execute a power-fail routine.

The TMA cycles now have more specific timing associated with them. In general, the tHDHA terms were

added to ensure adequate time for TMA arbitration to take place and to ensure that the transfer occurs in a "glitch-free" manner. Figure 3 and table 2 show the new timing relationships. Figure 4 and table 3 show basic bus timing as it appears in the new standard.

We made one major mechanical change to the standard in order to make room for an optional 10-inch-high board. This "double-height" board allows much more circuitry per board, which will reduce costs and increase system performance. Of course, these boards will not fit into most existing system cabinets, but it is just a matter of time before double-height boxes appear. In the meantime, all manufacturers of double-height boards must clearly state that a board is double-height in all product literature and advertisements.

That's about it for technical changes to the standard draft. The other minor changes are not really significant. As was mentioned earlier in this article, they are mostly to clear up ambiguities for the sake of designers.

Why Use the IEEE-696/S-100 Bus?

The IEEE-696/S-100 bus offers many advantages over single-board computers, the biggest of which is that the IEEE-696/S-100 systems are

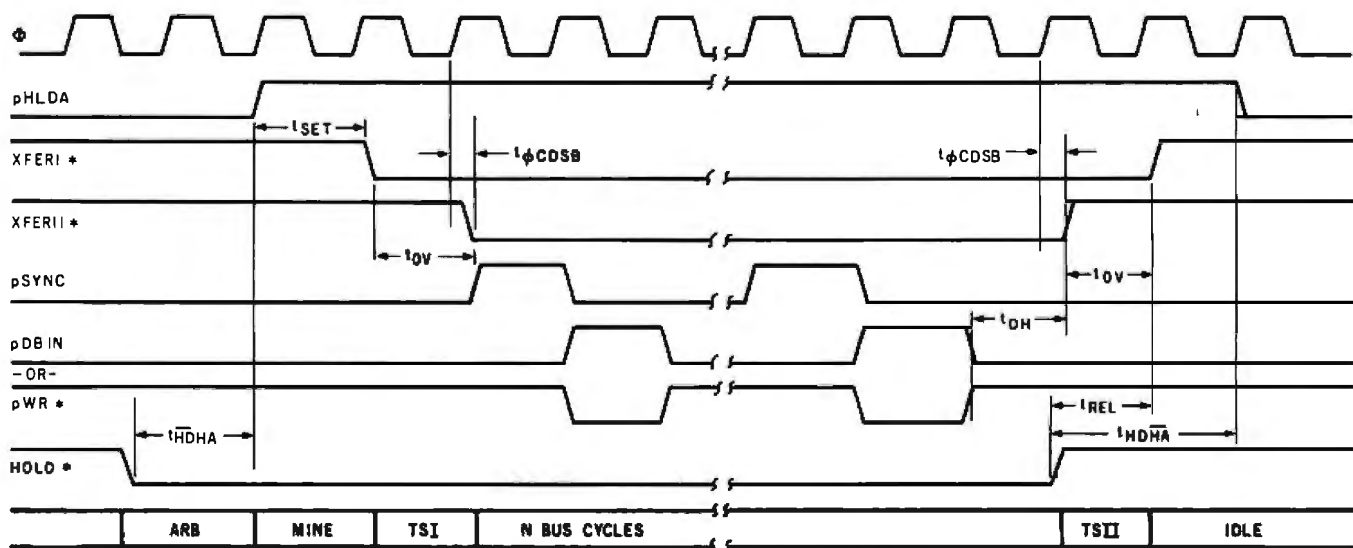

Where:
 XFERI symbolizes ADSB*, SDSB*, and DODSB*
 XFERII symbolizes CDSB*

Figure 3: Diagram of the timing relationships for temporary-master access to the bus.

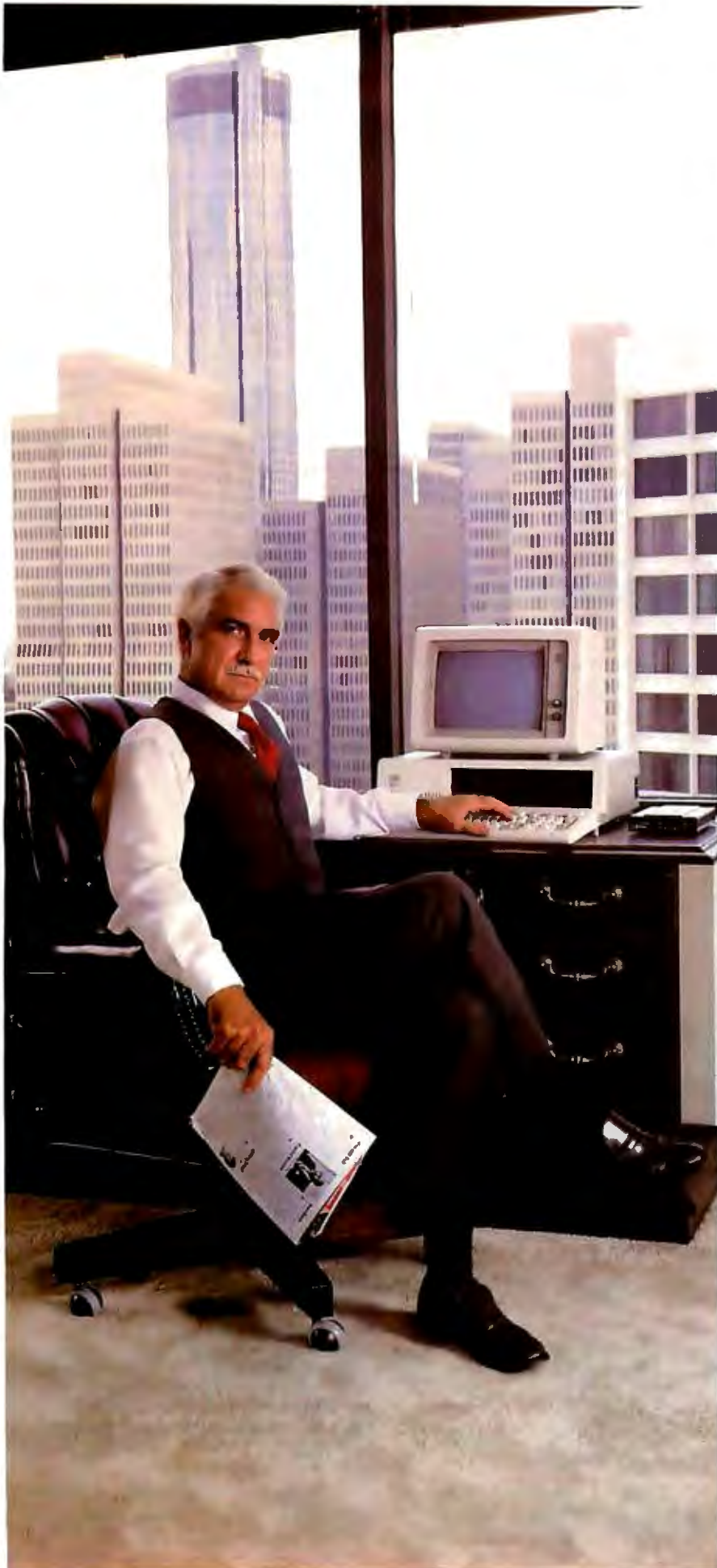

Now I can get the information I need. From anywhere. Immediately.

To do business, I need information from a lot of places.

Sales figures from Cincinnati.

Production costs from Philadelphia.

Personnel levels from our administrative offices three blocks away.

And — sometimes — I need up to the minute market prices from The Source. Whatever I need, I get it. Immediately. That means that I don't waste time waiting. And I don't have to make decisions based on old information. Even if it's just a day old.

Information from anywhere. Immediately. With

CROSSTALK™

Crosstalk allows your CP/M or MS-DOS based computer system to access almost any dial-up computer, capture and store the data, and transfer files between any two Crosstalk systems with complete error checking. Even when disk formats are incompatible.

To get your information, Crosstalk can automatically dial any dial-up system, capture on-line data for analysis off-line.

Crosstalk saves you and your computers time. It saves you money. And, best of all, it gets you the information that you need, when you need it. Ask your local dealer about it.

Now available for IBM PC



Microstuf, Inc.
1845 The Exchange
Suite 205
Atlanta, GA 30339
(404) 952-0267

DEALER INQUIRES WELCOME

CROSSTALK is a trademark of Microstuf, Inc.
CP/M is a registered trademark of Digital Research Inc.
The Source is a servicemark of Source Telecomputing, Corp.
a subsidiary of The Readers Digest Association, Inc.
MS-DOS is a trademark of Microsoft, Inc.

Circle 276 on Inquiry card.

FOR TRS-80 MODEL I OR III IBM PERSONAL COMPUTER

- * **MORE SPEED**
10-20 times faster than interpreted BASIC.
- * **MORE ROOM**
Very compact compiled code plus VIRTUAL MEMORY makes your RAM act larger. Variable number of block buffers. 31-char.-unique wordnames use only 4 bytes in header!
- * **MORE INSTRUCTIONS**
Add YOUR commands to its 79-STANDARD-plus instruction set!
Far more complete than most Forths: single & double precision, arrays, string-handling, clock, graphics (IBM low-res. gives BW and 16 color or 200 tint color display).
- * **MORE EASE**
Excellent full-screen Editor, structured & modular programming
Word search utility
THE NOTEPAD letter writer
Optimized for your TRS-80 or IBM with keyboard repeats, upper/lower case display driver, full ASCII.
- * **MORE POWER**
Forth operating system
Concurrent Interpreter AND Compiler
VIRTUAL I/O for video and printer, disk and tape (10-Megabyte hard disk available)
Full 8080 or 8088 Assembler aboard
(Z80 Assembler also available for TRS-80)
Intermix 35- to 80-track disk drives
IBM can read, write and run M.3 disks
M.3 can read, write and run M.1 disks



THE PROFESSIONAL FORTH SYSTEM FOR TRS-80 & IBM PC

(Thousands of systems in use)

MMSFORTH Disk System (requires 1 disk drive, 32K RAM)
V2.0 for Radio Shack TRS-80 Model I or III \$129.95*
V2.1 for IBM Personal Computer (80-col. screen) \$249.95*

AND MMS GIVES IT PROFESSIONAL SUPPORT

Source code provided
MMSFORTH Newsletter
Many demo programs aboard
MMSFORTH User Groups
Inexpensive upgrades to latest version
Programming staff can provide advice, modifications and custom programs, to fit YOUR needs.

MMSFORTH UTILITIES DISKETTE: Includes FLOATING POINT MATH (BASIC ROM routines plus Complex numbers, Rectangular-Polar coordinate conversions, Degrees mode, more); a powerful CROSS-REFERENCER to list Forth words by block and line; plus (TRS-80) a full Forth-style Z80 assembler or (IBM PC/color) Turtle Graphics (requires MMSFORTH V2.0, 1 drive & 32K RAM) \$39.95*

FORTHCOM: communications package provides RS-232 driver, dumb terminal mode, transfer of files or FORTH blocks, and host mode to operate a remote FORTHCOM system (requires MMSFORTH V2.0, 1 drive & 32K RAM) \$39.95*

THE DATAHANDLER: a very fast database management system operable by non-programmers (requires MMSFORTH V2.0, 1 drive & 32K RAM) \$59.95*

FORTHWRITE: fast, powerful word processor w/easy key-strokes, Help screens, manual & demo files. Full proportional w/tabs, outdenting. Includes other blocks, documents, keyboard inputs, & DATAHANDLER fields—ideal for form letters (requires MMSFORTH V2.0, 2 drives & 48K RAM) \$175.00*

MMSFORTH GAMES DISKETTE: real-time graphics & board games w/source code, includes BREAKFORTH, CRASH-FORTH, CRYPTOQUOTE, FREEWAY (TRS-80), OHELLO & TIGTACFORTH (requires MMSFORTH V2.0, 1 drive & 32K RAM) \$39.95*

Other MMSFORTH products under development

FORTH BOOKS AVAILABLE

MMSFORTH USERS MANUAL - w/o Appendices \$17.50*
STARTING FORTH - best! \$15.95*
THREADED INTERPRETIVE LANGUAGES - advanced, analysis of FORTH Internals \$18.95*
PROGRAM DESIGN & CONSTRUCTION - Intro. to structured programming, good for Forth \$19.00*
FORTH-79 STANDARD MANUAL - official reference to 79-STANDARD word set, etc \$13.95*

FORTH SPECIAL ISSUE, BYTE Magazine (Aug. 1980) - A collector's item for Forth users and beginners \$4.00*

* - ORDERING INFORMATION: Software prices include manuals and require signing of a single computer license for one-person support. Describe your hardware. Add \$2.00 S/H plus \$3.00 per MMSFORTH and \$1.00 per additional book; Mass. orders add 5% tax. Foreign orders add 20%. UPS COD, VISA and MC accepted; no unpaid purchase orders or refunds.

Send SASE for free MMSFORTH information.
Good dealers sought.

Get MMSFORTH products from your computer dealer or

MILLER MICROCOMPUTER SERVICES
61 Lake Shore Road, Natick, MA 01760
(617) 653-6136

Pin Number	Signal (and Origin)	Active Level	Description
1	+ 8 V (B)		Instantaneous minimum greater than 7 V, instantaneous maximum less than 25 V, average maximum less than 11 V.
2	+ 16 V (B)		Instantaneous minimum greater than 14.5 V, instantaneous maximum less than 35 V, average maximum less than 21.5 V.
3	XRDY (S)	H	One of two ready inputs to the current bus master. The bus is ready when both these ready inputs are true. See pin 72.
4	VIO*(S)	L OC	Vectored-interrupt line 0.
5	V11*(S)	L OC	Vectored-interrupt line 1.
6	V12*(S)	L OC	Vectored-interrupt line 2.
7	V13*(S)	L OC	Vectored-interrupt line 3.
8	V14*(S)	L OC	Vectored-interrupt line 4.
9	V15*(S)	L OC	Vectored-interrupt line 5.
10	V16*(S)	L OC	Vectored-interrupt line 6.
11	V17*(S)	L OC	Vectored-interrupt line 7.
12	NMI*(S)	L OC	Nonmaskable interrupt.
13	PWRFAIL*(B)	L	Power-fail bus signal.
14	TMA3* (M)	L OC	Temporary-master priority bit 3.
15	A18 (M)	H	Extended-address bit 18.
16	A16 (M)	H	Extended-address bit 16.
17	A17 (M)	H	Extended-address bit 17.
18	SDSB* (M)	L OC	The signal to disable the 8 status signals.
19	CDSB* (M)	L OC	The signal to disable the 5 control output signals. Common with pin 100.
20	0 V (B)		Not to be defined. Manufacturer must specify any use in detail.
21	NDEF		
22	ADSB* (M)	L OC	The signal to disable the address signals.
23	DODSB* (M)	L OC	The control signal to disable the data-output signals. (DO7-0 for 8-bit transfers, ED7-0 and OD7-0 for 16-bit transfers).
24	φ (B)	A	The master timing signal for the bus.
25	pSTVAL*(M)	L	Status-valid strobe.
26	pHLDA (M)	H	A control signal used in conjunction with HOLD* to coordinate bus-master transfers.
27	RFU		Reserved for future use.
28	RFU		Reserved for future use.
29	A5 (M)	H	Address bit 5.
30	A4 (M)	H	Address bit 4.
31	A3 (M)	H	Address bit 3.
32	A15 (M)	H	Address bit 15 (most significant for nonextended addressing).
33	A12 (M)	H	Address bit 12.
34	A9 (M)	H	Address bit 9.
35	DO1 (M)/ED1 (M/S)	H	Data-out bit 1, bidirectional even-data bit 1.
36	DO0 (M)/ED0 (M/S)	H	Data-out bit 0, bidirectional even-data bit 0.
37	A10 (M)	H	Address bit 10.
38	DO4 (M)/ED4 (M/S)	H	Data-out bit 4, bidirectional even-data bit 4.
39	DO5 (M)/ED5 (M/S)	H	Data-out bit 5, bidirectional even-data bit 5.
40	DO6 (M)/ED6 (M/S)	H	Data-out bit 6, bidirectional even-data bit 6.
41	DI2 (S)/OD2 (M/S)	H	Data-in bit 2, bidirectional odd-data bit 2.
42	DI3 (S)/OD3 (M/S)	H	Data-in bit 3, bidirectional odd-data bit 3.
43	DI7 (S)/OD7 (M/S)	H	Data-in bit 7, bidirectional odd-data bit 7.
44	sM1 (M)	H	The status signal that indicates that the current cycle is an op-code fetch.
45	sOUT (M)	H	The status signal identifying the data-transfer bus cycle to an output device.
46	sINP (M)	H	The status signal identifying the data-transfer bus cycle from an input device.
47	sMEMR (M)	H	The status signal identifying bus cycles that transfer data from memory to a bus master and that are not interrupt-acknowledge/instruction-fetch cycle(s).
48	sHLTA (M)	H	The status signal that acknowledges that an HLT instruction has been executed.
49	CLOCK (B)	A	2-MHz (± 0.5%) 40-60% duty cycle. Not required to be synchronous with any other bus signal.
50	0 V (B)		Common with pin 100.

Table 1: Signals and their definitions according to the IEEE-696 standard. The letter in parentheses tells the signal's origin: master, slave, or bus. OC specifies open-collector drivers and A means alternating. (Table 1 continues on page 292.)

SUPERIOR GRAPHICS HAVE COME DOWN TO EARTH.

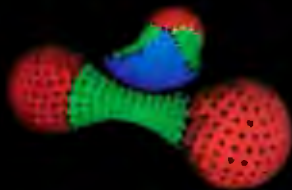

"Three Atoms" Courtesy of Greg Abram, University of North Carolina at Chapel Hill

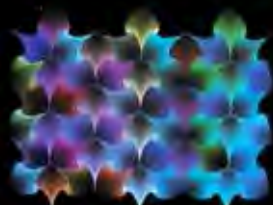

"Aurora" By Richard Katz, Vectrix Corporation

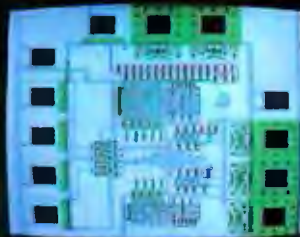

"Integrated Circuit Design" Courtesy of Floyd J. James, University of North Carolina at Chapel Hill



"In The Beginning" By Richard Katz, Vectrix Corporation

\$1995 AND THE FIRST AFFORDABLE HIGH RESOLUTION COLOR GRAPHICS MACHINE IS YOURS

VX128

- **VERY HIGH RESOLUTION** 672 by 480 pixels individually addressable
- **EIGHT COLORS PER PIXEL** 3 bit planes of memory totalling 128K graphics RAM

- **ON-BOARD 16 BIT MICRO-COMPUTER** Intel 8088 microprocessor with additional PROM and RAM and built-in expansion capability

- **3D GRAPHICS SOFTWARE PACKAGE** built-in command set includes: rotation, scaling, translation, perspective, clipping, viewport, polygon, and filled polygon

- **HARDWARE LINE AND ARC GENERATION** on-board VLSI graphics display controller, 1600 nano-seconds pixel drawing time

- **USER DEFINABLE CHARACTER GENERATION** built-in character set includes zoom, slant, and variable spacing, or upload your own character definitions



VECTRIX

- **SERIAL AND PARALLEL INTERFACE** 300-19.2K baud and 8 bit parallel port
- **USER FRIENDLY COMMAND FORMAT** supports high level language and hexadecimal transmissions

VX384

- **512 COLORS PER PIXEL** 9bit planes of memory with 384K graphics RAM

- **COLOR LOOKUP TABLE** 8 bit digital-to-analog converters provide a 16 million color palate

- **INCLUDES ALL FEATURES** of VX128 for total of \$3995

- **VXM HIGH RESOLUTION COLOR MONITOR** RGB analog input with 24 kilohertz scan rate, long persistence phosphor \$1295

- **COLOR GRAPHIC PRINTER** with interface cable \$1295



For additional information on VX128, VX384, VXM Monitor or VXP Printer call Toll Free 1-800-334-8181, or 919-272-3479, or write Vectrix Corporation, 700 Battleground Avenue, Greensboro, NC 27401



**THREE
NEW PERSONAL
COMPUTERS THAT
MAKE ALL THE
OTHERS MERELY
INTERESTING
HISTORY.**

There was a time in recent history when people could tolerate the inadequacies of personal computers. We believe that era has ended.



Now you can own personal computers that are more powerful, easier to use and more fully supported than any to have come before them. They are the new personal computers from Digital Equipment Corporation, the world's second largest computer manufacturer.



Digital's personal computers give you more information on the screen. More storage. And communications options that let you talk to other, larger computers anywhere in the world.

When it comes to graphics, you no longer have to settle for the "paint-by-numbers" look of yesterday's systems. Digital's optional bit-map graphics give you four times the resolution of even the very best picture tube. And you no longer have to settle for the pale, bland colors of the past. Digital's personal computers give you a wider palette to pick from.

Even more, you no longer have to be content with a narrow choice of personal computers. For Digital gives you three choices: Rainbow, DECmate, and Professional personal computers. Different kinds of personal computers, because there are different kinds of problems to manage.



So if you've been unhappy with the history of personal computing thus far, be glad. A new generation has begun. To find out more, call 800-DIGITAL and we'll send you our free

personal computer brochure. Or write: Digital Equipment Corporation, 129 Parker St., Maynard, MA 01754.

digital
MORE PERSONAL.
MORE COMPUTER.

AVAILABLE NOW!

UCSD p-SYSTEM* (VERSION IV.1) FOR THE VICTOR 9000*

THE MOST PORTABLE,
POWERFUL AND POPULAR
OPERATING ENVIRONMENT
IS NOW AVAILABLE FOR
IMMEDIATE SHIPMENT FOR
THE VICTOR 9000 / SIRIUS
COMPUTER

- Full screen editor
- Comprehensive filer and utilities
- PASCAL, FORTRAN and BASIC compilers
- Object code compatibility with IBM, Osborne, TI, DEC
- Extended memory
- TURTLEGRAPHICS
Full use of Victor screen
- Native code generator
Complete trade off between size and speed
- Xenofile
p-SYSTEM to/from CP/M 86
TM-Digital Research Corp.
- Complete documentation
700 pages
- Runtime only systems also available

*Trademarks
Regents of the University of California
Victor Business Products

Combine a great machine
with a great operating system

ONLY FROM TDI:

620 HUNGERFORD DRIVE,
SUITE 33,
ROCKVILLE, MD. 20850
(301) 340-8700

29 ALMA VALE ROAD
BRISTOL, U.K. BS8 2HL
0272-742796

Table 1 continued:

Pin Number	Signal (and Origin)	Active Level	Description
51	+8 V (B)		Common with pin 1.
52	-16 V (B)		Instantaneous maximum less than -14.5 V, instantaneous minimum greater than -35 V, average minimum greater than -21.5 V.
53	0 V (B)		Common with pin 100.
54	SLAVE CLR* (B)	L OC	A reset signal to reset bus slaves. Must be active with POC* and may also be generated by external means.
55	TMA0* (M)	L OC	Temporary-master priority bit 0.
56	TMA1* (M)	L OC	Temporary-master priority bit 1.
57	TMA2* (M)	L OC	Temporary-master priority bit 2.
58	sXTRQ* (M)	L	The status signal that requests 16-bit slaves to assert SIXTN*.
59	A19 (M)	H	Extended-address bit 19.
60	SIXTN* (S)	L OC	The signal generated by 16-bit slaves in response to the 16-bit request signal sXTRQ*.
61	A20 (M)	H	Extended-address bit 20.
62	A21 (M)	H	Extended-address bit 21.
63	A22 (M)	H	Extended-address bit 22.
64	A23 (M)	H	Extended-address bit 23.
65	NDEF		Signal not to be defined.
66	NDEF		Signal not to be defined.
67	PHANTOM*(M/S)	L OC	A bus signal that disables normal slave devices and enables phantom slaves—primarily used for bootstrapping systems without hardware front panels.
68	MWRT (B)	H	pWR • -sOUT (logic equation). This signal must follow pWR* by not more than 30 ns.
69	RFU		Reserved for future use.
70	0 V (B)		Common with pin 100.
71	RFU		Reserved for future use.
72	RDY (S)	H OC	See comments for pin 3.
73	INT* (S)	L OC	The primary interrupt-request bus signal.
74	HOLD* (M)	L OC	The control signal used in conjunction with pHLDA to coordinate bus-master transfers.
75	RESET* (B)	L OC	The reset signal to reset bus-master devices. This signal must be active with POC* and may also be generated by external means.
76	pSYNC (M)	H	The control signal identifying BS _i .
77	pWR* (M)	L	The control signal signifying the presence of valid data on DO bus or data bus.
78	pDBIN (M)	H	The control signal that requests data on the DI bus or data bus from the currently addressed slave.
79	A0 (M)	H	Address bit 0 (least significant).
80	A1 (M)	H	Address bit 1.
81	A2 (M)	H	Address bit 2.
82	A6 (M)	H	Address bit 6.
83	A7 (M)	H	Address bit 7.
84	A8 (M)	H	Address bit 8.
85	A13 (M)	H	Address bit 13.
86	A14 (M)	H	Address bit 14.
87	A11 (M)	H	Address bit 11.
88	DO2 (M)/ED2 (M/S)	H	Data-out bit 2, bidirectional even-data bit 2.
89	DO3 (M)/ED3 (M/S)	H	Data-out bit 3, bidirectional even-data bit 3.
90	DO7 (M)/ED7 (M/S)	H	Data-out bit 7, bidirectional even-data bit 7.
91	DI4 (S)/OD4 (M/S)	H	Data-in bit 4, bidirectional odd-data bit 4.
92	DI5 (S)/OD5 (M/S)	H	Data-in bit 5, bidirectional odd-data bit 5.
93	DI6 (S)/OD6 (M/S)	H	Data-in bit 6, bidirectional odd-data bit 6.
94	DI1 (S)/OD1 (M/S)	H	Data-in bit 1, bidirectional odd-data bit 1.
95	DI0 (S)/OD0 (M/S)	H	Data-in bit 0 (least significant for 8-bit data), bidirectional odd-data bit 0.
96	sINTA (M)	H	The status signal identifying the bus input cycle(s) that may follow an accepted interrupt request presented on INT*.
97	sWO* (M)	L	The status signal identifying a bus cycle that transfers data from bus master to slave.
98	ERROR* (S)	L OC	The bus status signal signifying an error condition during present bus cycle.
99	POC* (B)	L	The power-on clear signal for all bus devices; when this signal goes low, it must stay low for at least 10 ms.
100	0 V (B)		System ground.

We're selling Tandon with abandon!

We are overstocked!
Our warehouse
with Tandon Drive
He

help yours
ings on the
We've a
Tandon. (Even wh
to our knees in 'em.)
an unsurpassed stor
ity, a v
design, increased th
and proven reliabilit

So at these prices
definitely bu
Maybe som
havin' a birtl
for th m.

Call imm
these
prices, they won't last very long.
Hopefully.

Tandon's TM100 series of 5-inch
mini-floppy disk drives
Tandon's patented read/write
head design.

Available in four models:

TM100-1 A single
5.25-inch floppy
storage capac
unformatted an
access tim
..... 195.00

TM100-2 double
per side, 5.25-inch floppy-disk
drive with a storage capacity of
500K bytes unformatted and a

track-to-track
unformatted
access time of 3-milliseconds
.....250.00

TM100-3 single-sided, 80 track
per side floppy-disk
drive with a storage capacity of
1000K bytes unformatted and a
track-to-track access time of 3-
milliseconds.....369.00

TM848 "Thin
line" floppy-disk

q Thinline
dr to be ir
space as a single conventional
rive.

Available in two models:

TM848-1 single-sided,
5.25-inch floppy-disk drive
with a storage capacity of
1000K bytes unformatted and a
track-to-track access time of 3-
milliseconds.....490.00

TM848-2 double-sided,
5.25-inch floppy-disk drive
with a storage capacity of
1000K bytes unformatted and a
track-to-track access time of 3-
milliseconds.....490.00

TM848-3 double-sided,
80 track per side floppy-disk
drive with a storage capacity of
1000K bytes unformatted and a
track-to-track access time of 3-
milliseconds.....490.00

MODEL III DISK DRIVE (FS
Controller Kit incl
assembled and t
controller, moun
switching power supply, and in-
stallation instructions. Handles 4
drives.....259.00

Kit #1: Controller Kit and two
TM100-3 single-sided, 80 track
drives.....638.00

Kit #2: Controller Kit and two
TM100-2 double-sided, 40 track
drives.....779.00

Kit #3: Controller Kit and two
TM100-3 single-sided, 80 track
drives.....1000.00

Kit #4: Controller Kit and two
TM100-4 double-sided, 40 track
drives.....979.00

**CALL OUR MODEM LINE
FOR WEEKLY SPECIALS.**
We built a reputation on our
prices and your satisfaction.

We guarantee everything
If anything is wrong, return the item and
we'll make it right. And we'll pay the ship-
ping charges.

We accept Visa and MasterCard
orders. COD orders, too.

Prices quoted are for stock on hand and
notice

To order or for
information call

In New York:

(212) 509-1923

Angeles:

(213) 706-0333

In Dallas:

(214) 744-4251

By

(213) 976

**Alpha
Byte
COMPUTER
PRODUCTS**

31245 LA BAYA DRIVE

Parameter	Description	Minimum	Maximum
t_{SET}	Delay pHLDA to ADSB*, SDCSB*, DODCSB* low	0	
t_{OV}	Time for both temporary and permanent master to drive the control output lines	$0.4t_{CY}$	
t_{DH}	Hold time for address, status, and data out from end of strobe to CDSB* rising	$0.2t_{CY}$	
t_{REL}	Delay from HOLD* rising to ADSB*, SDCSB* and DODCSB* high		$1.0t_{CY}$
$t_{HD\bar{H}\bar{A}}$	Delay from HOLD* false to pHLDA false	$1.0t_{CY}$	
$t_{\phi CDSB}$	Delay from ϕ rising to CDSB* low Delay from ϕ rising to CDSB* high	0	$0.3t_{CY}$
$t_{\bar{W}\bar{B}HA}$	Delay from HOLD* falling to pHLDA rising	$1.0t_{CY}$	

Table 2: Bus-transfer timing parameters (see also figure 3).

completely modular in nature. Users can purchase just the system they need because any system can be tailored to individual requirements. You are not stuck buying what a manufacturer feels is the optimum computing system.

By the same token, a modular system can be upgraded at any time to take advantage of newer technology, expand the system's capabilities as your computing needs grow, or even

turn a single-user computer into one capable of handling multiple users. You have a choice of a wide variety of processor types, including many 16-bit offerings. Some systems even allow a mixture of processor types, including both 8- and 16-bit processors.

Another big advantage of IEEE-696/S-100 systems is the large number of manufacturers with products for that bus. A wide range of

products exists for almost any application.

Hardware and software developers prefer the IEEE-696/S-100 bus because the latest technology seems to appear on that bus first. Every major new processor has been available on an S-100 board long before it has been ready for other systems. Computer systems based on the S-100 bus tend to run a lot faster than other systems. Although the standard specifies that the maximum clock rate is 6 MHz, the S-100 bus is capable of running much faster, with some manufacturers routinely shipping 10-MHz products.

Some people perceive cost as a disadvantage to IEEE-696/S-100 systems. It is true that an S-100-based system may cost more to start with than a single-board-type system, but S-100 systems quickly become much more cost-effective when it comes time to upgrade the system. A single-board system may have to be discarded altogether; but, change a card or two in an S-100 system, and you

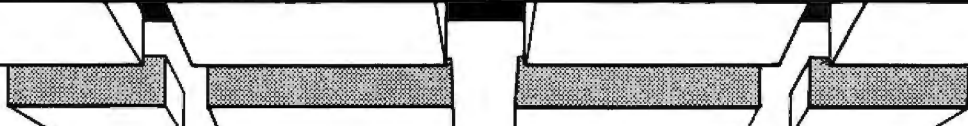

Now, you can balance your checking account...
even if you never could before, with

THE SMART CHECKBOOK™

Your personal financial manager

Its unique checkbook reconciliation mode finds the mistakes in your checkbook for you and makes corrections easily.

For example it:

- Shows items returned by your bank which you forgot to enter.
- Locates duplicate entries.
- Finds differences in amounts entered in your checkbook, and those charged by your bank.
- Even catches mistakes the bank made.

In short, it enables you to BALANCE YOUR CHECKBOOK with ease and confidence. Or, an unlimited number of checking and credit card accounts, for that matter.

AND THERE'S MUCH MORE...

A powerful data base manager, checkwriter, budget information, automatic and customized reports and tables.

SMALL BUSINESSES...

Keeps track of Schedule C revenues and expenses and displays them in monthly income statement form for a whole year.

AT TAX TIME...

List and total your tax deductions with pushbutton ease for any of 16 Form 1040 tax categories.

ORDER THE SMART CHECKBOOK NOW...

ONLY \$149. Available for most CP/M and CP/M-86 formats (requires 56K) and the IBM PC-DOS (requires 64K). Dealer inquiries welcome.

Phone: (703) 281-1621 OR WRITE: Box 3456
McLean, VA
22103



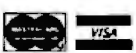

SOFTQUEST

CP/M is a registered trademark of Digital Research; The Smart Checkbook is a trademark of Softquest

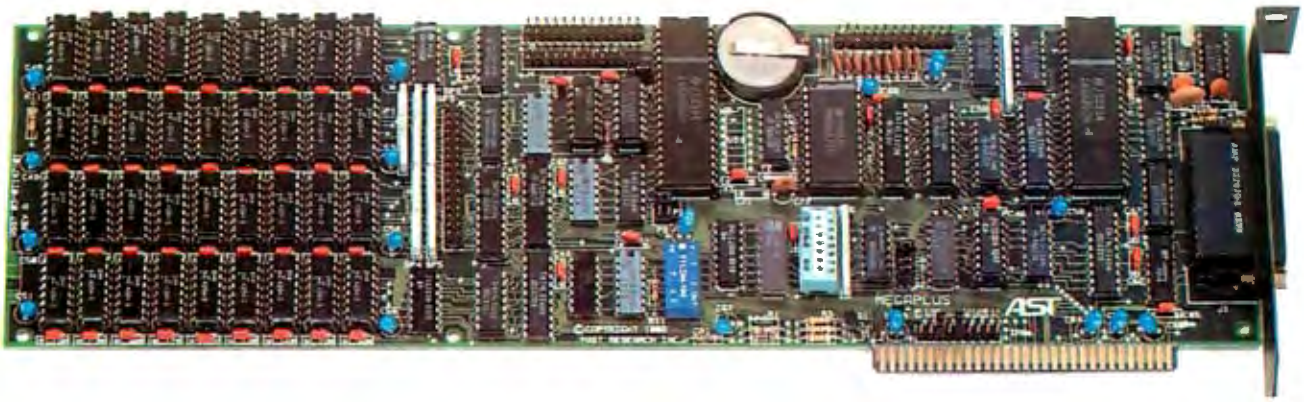

Still short of features on your QUAD function IBM PC board?

This may really be the only board you need to expand your IBM personal computer. We've now added the most wanted feature on a quadfunctionboard: two asynchronous ports along with memory, clock/calendar, and parallel printer port. And unlike most big memory boards, you don't have to sacrifice multiple functions to get 512k of add-on memory in a single slot.

THE BASICS

The main board has three functions standard: Parity checked and fully socketed memory up to 256k in 64k increments, clock/calendar with battery back-up, asynchronous communication port (RS232C serial) which can be used as COM1 or COM2, (DCE for a printer, or DTE for a modem). Optional is a 100% IBM compatible parallel printer port, and a second async port for another \$50 each. Also included are: SuperDrive™ disk emulation and SuperSpooler™ printer buffer software.

NO CORNERS CUT

We didn't lower the quality to give you all this. The board is a four layer design with solder masking, silk screened locations, and gold plated edge connectors. Components are premium grade and meet or exceed IBM specifications. Each board is burned in and tested prior to shipment.

CLOCK/CALENDAR & CLIP-ON BATTERY

Our clock is powered by a simple \$4 lithium watch battery available at your corner drug store. It is clipped on, not soldered like some other clock boards. How useful is a battery warranty that requires you to send your board to the manufacturer to replace it? We send you a diskette with a program that sets the time and date when you turn on your computer. Now your programs will always have the correct time and date on them without you ever having to think about it. (Just which version of that program you were writing is the latest one?)

MEGAPAK OF MEMORY

The picture in the inset shows the optional 256k MegaPak™ board mounted "piggy-back" on the main board. This expandability feature gives those who need it 512k of add-on memory in a single slot. Now you can create disk drives in memory up to

320k, set aside plenty of space for print spooling, and still have plenty of memory for your biggest programs. An exclusive design allows the memory to be split at two memory addresses to take full advantage of the memory disk feature of concurrent CP/M.

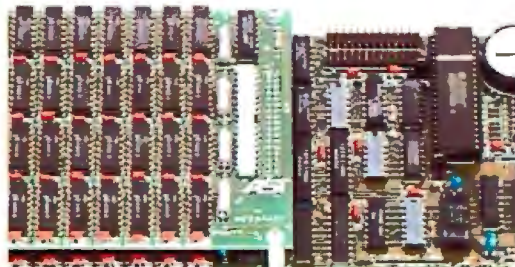

FREE SOFTWARE

The disk emulation software creates "disk drives" in memory which access your programs at the speed of RAM memory. The print spooler allows the memory to accept data as fast as the computer can send it and frees your computer for more productive work. Some manufacturers sell hardware printer buffers that do only this for hundreds of dollars. SuperSpooler™ eliminates the need for these slot robbing products.

CHEAP SOFTWARE TOO

What good is great hardware without some great software to use it with? We offer some terrific prices on some of the popular programs you will want to use your board with. How about the cream of the spreadsheet programs, SUPERCALC, for just \$176. Or maybe dBASE II by Ashton-Tate for just \$469.

WHY BUY IT FROM US?

Because we provide the service and support most companies just talk about. We realize how integral this board is to the use of your computer. What good is a warranty if it takes weeks for repairs to be made? We offer 48 hour turnaround or a replacement board on all warranty repairs. Do you hear anyone else making this promise? If you still are not convinced, and want to compare prices, remember we don't charge extra for credit cards, shipping, or COD fees. If you still want to buy elsewhere, ask them if they will face the acid test.

THE ACID TEST

Qubie (say que-bee-A) gives you a 30 day satisfaction guarantee on all board purchases. If you are not completely satisfied we will refund the entire cost of your purchase as well as pay the postage to return it. If you can get one of our competitors to give you the same guarantee, buy any other board you think compares and return the one you don't like. We're not worried because we know which one you will keep. We also offer a one year parts and labor warranty. An additional one year extended warranty is available for \$50.

TO ORDER BY MAIL SEND

- Your name and shipping address
- Memory size, and options requested
- Software and cables needed
- Daytime phone number
- California residents add 6% sales tax
- Company check or credit card number with expiration date (personal checks take 18 days to clear)



TO ORDER BY PHONE

In California (805) 482-9829
Outside California (800) 821-4479

PRICES:	64k	\$375	192k	\$499
	128k	\$439	256k	\$599
		512k	\$998	

(Includes async port, memory, clock/calendar, SuperDrive™, and SuperSpooler™ software)

OPTIONS:

Parallel Printer Port	\$50
Second Async Port	\$50
MegaPak™ with 256k of memory	\$399
Cable to parallel printer	\$35
Cable to modem or serial printer	\$25
Memory Diagnostics Program	\$10
SUPERCALC by SORCIM	\$176
dBASE II by Ashton-Tate	\$469

SHIPMENT

We pay UPS surface charges. UPS 2 day air serve \$5 extra. Credit card or bank check orders shipped same day.

QUBIE'
DISTRIBUTING
4809 Calle Alto
Camarillo, CA 93010

MODEM \$129⁹⁵

No other acoustic modem gives you all these features at this low price.

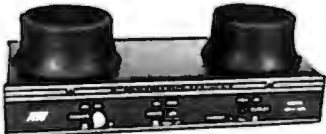

The MFJ-1232 Acoustic Modem gives you a combination of features, quality and performance that others can't match at this price. Originate/Answer. Half/full duplex. RS-232, TTL, CMOS level compatible. Use any computer. Cassette tape recorder ports save data for reloading or retransmission. 6 pole active filter handles weak signals. Carrier detect LED indicates adequate signal strength for data recognition. Quality "muffs" gives good acoustic coupling, isolates external noise for reliable data transfer. Crystal controlled. "ON" LED. Aluminum cabinet. 110 VAC or 9 volt batteries. 9x1½x4 in.

Apple II, II Plus: software and cable for modem, MFJ-1231, \$39.95. Plugs into game port. No serial board needed.

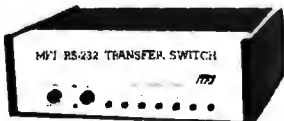

It's like having an extra port

\$79⁹⁵

MFJ-1240 RS-232 TRANSFER SWITCH. Switches computer between 2 peripherals (printer, terminal, modem, etc.). Like having extra port. Push button switches 10 lines (pins 2,3,4,5,6,8, 11,15,17,20). Change plug or cable to substitute other lines. Push button reverses transmit-receive lines. LEDs monitor pins 2,3,4,5,6,8,20. PC board eliminates wiring, crosstalk, line interference. 3 RS-232 25 pin connectors. 7x2x6 in.

\$99⁹⁵ MFJ-1108 AC POWER CENTER. Adds convenience, prevents data loss, head bounce, equipment damage. Relay latches power off during power transients. Multi-filters isolate equipment, eliminate interaction, noise, hash. Varistors suppress spikes. 3 isolated, switched socket pairs. One unswitched for clock, etc. Lighted power, reset switch. Pop-out fuse. 3 wire, 6 ft. cord. 15A, 125V, 1875 watts. Aluminum case. Black. 18x2¼x2 in. **MFJ-1107, \$79.95.** Like 1108 less relay. 8 sockets, 2 unswitched. Other models available, write for free specification sheet.

Order from MFJ and try it. If not delighted, return within 30 days for refund (less shipping). One year unconditional guarantee.

Order yours today. Call toll free 800-647-1800. Charge VISA, MC. Or mail check, money order. Add \$4.00 each for shipping and handling.

CALL TOLL FREE ... 800-647-1800

Call 601-323-5869 in MS, outside continental USA

MFJ ENTERPRISES, INCORPORATED

921 Louisville Road, Starkville, MS 39759

(4a)

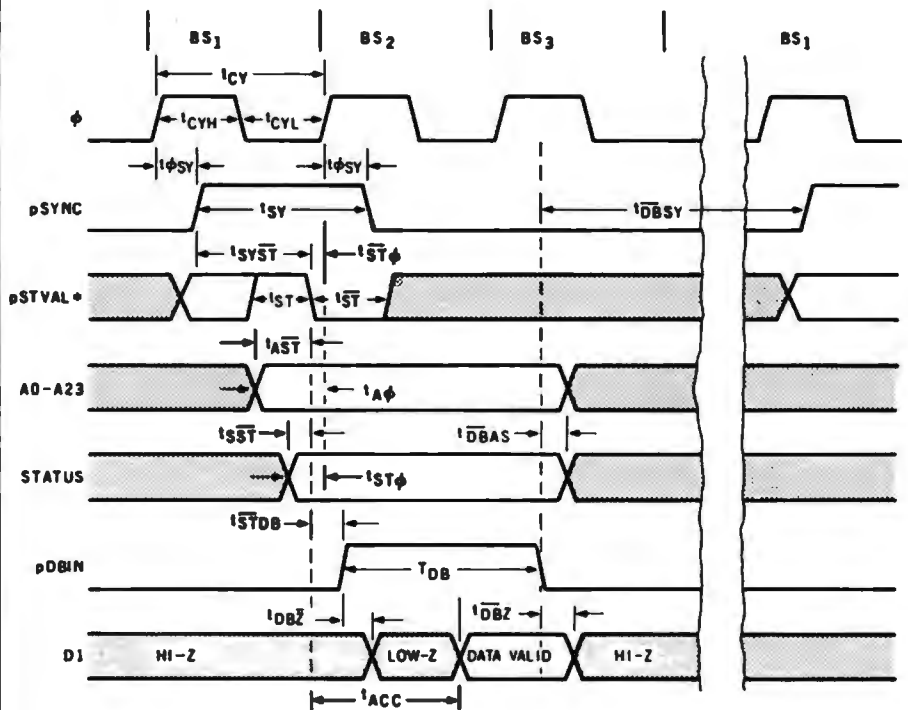

(4b)

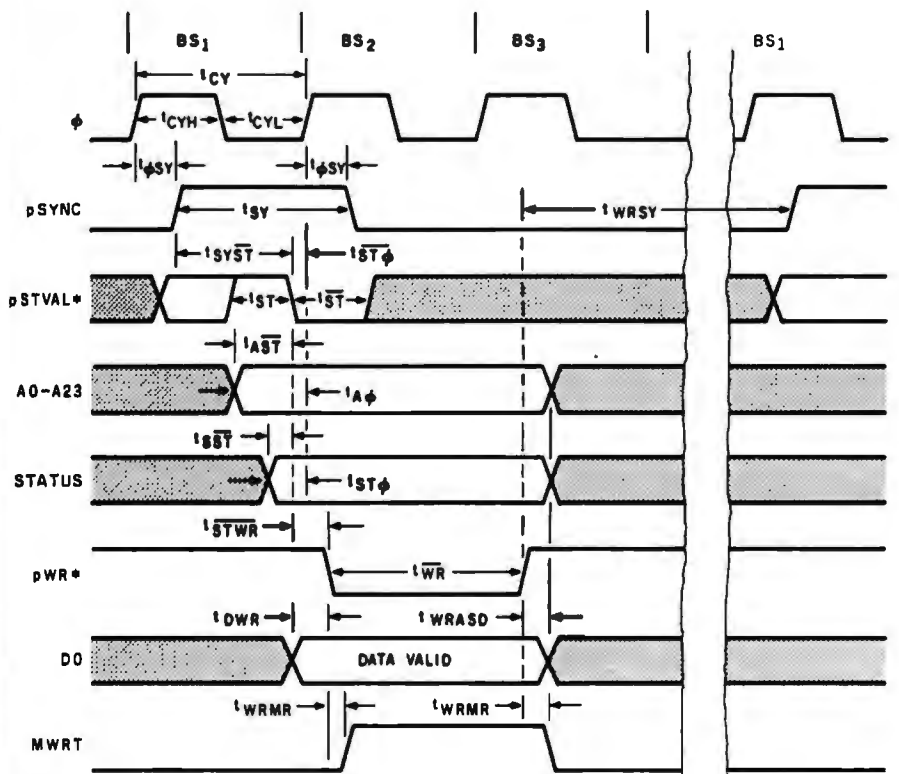

Figure 4: Timing diagrams for basic bus cycles. Figure 4a shows a read cycle; figure 4b shows a write cycle; and figure 4c shows the timing required for the RDY, XRDY, and SIXTN* signals (when pSYNC is false, RDY and XRDY are tested only when the master is in a wait state).

Parameter	Description	Minimum (ns)	Maximum (ns)
t_{CY}	ϕ Period	166	2000
t_{CYH}	ϕ Pulse width high	$0.4t_{CY}$	
t_{CYL}	ϕ Pulse width low	$0.4t_{CY}$	
$t_{\phi SY}$	Delay ϕ high to pSYNC high; Delay ϕ high to pSYNC low	10	$0.4t_{CY}$
t_{SY}	pSYNC pulse width high	$0.7t_{CY}$	
$t_{ST\phi}$	pSTVAL* low prior to ϕ high during pSYNC	0	
t_{ST}	pSTVAL* pulse width high	50	
t_{SF}	pSTVAL* pulse width low	50	
t_{AST}	Addresses stable prior to pSTVAL* low during pSYNC high	70	
t_{SST}	Status stable prior to pSTVAL* low during pSYNC high	40	
t_{DB}	pDBIN pulse width high	$0.9t_{CY}$	
t_{STDB}	Delay pSTVAL* low to pDBIN high	20	
t_{DBSY}	Delay pDBIN low to pSYNC high	0	
t_{DBAS}	Hold time for addresses and status after pDBIN low	50	
t_{DBZ}	Delay pDBIN low to slave DI drivers high impedance		70
t_{DBZ}	Delay pDBIN high to slave DI drivers active	10	70
t_{ACC}	Delay pSTVAL* low to data valid	Specified by manufacturer worst-case maximum for all slaves and worst-case minimum for all masters.	
t_{WR}	pWR* Pulse width low	$0.9t_{CY}$	
t_{SYWR}	Delay pSTVAL* low to pWR* low	30	
t_{WRSY}	Delay pWR* high to pSYNC high	0	
t_{DWR}	Setup time DO valid to pWR* low	$0.1t_{CY}$	
t_{WRASD}	Hold time addresses, status, and DO from pWR* high	$0.2t_{CY}$	
t_{WRMR}	Delay pWR* low to MWRT high; delay pWR* high to MWRT low		30
$t_{RDY\phi}$	Setup time RDY, XRDY, SIXTN* to ϕ rising	70	
$t_{\phi RDY}$	Hold time RDY, XRDY, SIXTN* after ϕ rising	20	
t_{POV}	Overlap of PHANTOM* and pDBIN or pWR*	30	
t_{SYST}	Delay from pSYNC high to pSTVAL* low	30	
$t_{A\phi}$	Addresses stable prior to ϕ high during pSYNC high	80	
$t_{ST\phi}$	Status stable prior to ϕ high during pSYNC high	50	

Table 3: Memory-access cycle timing parameters.

ReformatTer conversion software lets you *read* and *write* IBM 3740 diskettes* on your CP/M or MP/M system.

ReformatTer is ideal for CP/M users who want

- Access to large system data bases
- Distributed data processing
- Offline program development
- Database conversion

With ReformatTer, you have the ability to

- Bidirectionally transfer complete files between CP/M and IBM
- Automatically handle ASCII/EBCDIC code conversion
- Display and alter IBM 3740 directory and data

Enjoy the same advantages of mainframe access that other ReformatTer users have. Customers like Upjohn, M&M/Mars, The United Nations, Arthur Young & Co., Sandia Labs, FMC Corp., and Stanford University all use ReformatTer. So can you.

Other versions of ReformatTer conversion software include

- CP/M ↔ DEC (RT 11)
 - TRSDOS Mod. II ↔ CP/M
 - TRSDOS Mod. II ↔ DEC (RT 11)
- Order ReformatTer today for only \$249.

*IBM 3740 basic data exchange format. ReformatTer requires one 8" floppy drive.

467 Hamilton Av., Suite 2, Palo Alto, CA 94301
CP/M is a reg. trademark of Digital Research

Please send complete information on the following versions of ReformatTer

- Please send ReformatTer CP/M ↔ IBM. My check for \$249 (plus \$5 shipping. Cal. Res. add 6 1/2% sales tax). Charge to my VISA MasterCard.

_____ exp. date _____

Signature _____
Name _____
Company _____
Street _____
City _____
State _____ Zip _____

Mail to MicroTech Exports, Inc.
467 Hamilton Ave., Palo Alto, CA 94301



Totally Apple compatible, the new Franklin ACE 1000 Computer includes 64K Visicalc control keys, numeric keypad, and built-in cooling fan. It will interface with all Apple programs. The only thing they don't have in common is their price! The ACE 1000 is priced hundreds of dollars less.

Computer Discount sells the complete Franklin, TRS-80, ATARI, and Apple Computer lines, Epson, Okidata, and C. Itoh printers, and a complete inventory of hardware, accessories and software, and we have cables to interface our printers with Commodore, IBM and Osborne computers — all at the best prices in the U.S.A. Send for our FREE 32 page catalog.

CALL TOLL FREE: 800-526-5313
COMPUTER DISCOUNT OF AMERICA, INC.
 15 Marshall Hill Road, West Milford Mall
 West Milford, New Jersey 07480-219
 In New Jersey Call 201-728-8080



Now anyone can write a powerful program with dBase II and Autocode.

Finally, the first practical application of artificial intelligence in personal computer software. Autocode 1 is a powerful program generator for dBASE II. No prior knowledge of programming required.

AUTOCODE 1

- Automatic menus & sub menus
- Automatic data entry screens
- Automatic data entry routines
- String, numeric, date & calculated fields
- Automatic multiple reports
- Automatic programs in dBASE II code with interactive screens
- No prior knowledge of dBASE II required
- CP/M & MS DOS operating systems
- Handy pocket size manual
- Average learning time only 4 hours

ONLY \$200

STEMMOS LTD.

666 Howard Street, San Francisco, CA 94105

Just send the following to address above today.

- Your diskette format & hardware
- Your name & complete address
- How many Autocodes you want at \$200 each.
- A check or money order.

ORDER TOLL FREE 800-227-1617 (Ext. 417) IN CA CALL 800-772-3545 (Ext. 417)

Credit card buyers may substitute their card number and expiration date for the check. Or call us toll free and save the trip to the mail box.



U.S. Address: 666 Howard St. San Francisco CA 94105 / U.K. Address: 344 Kensington High Street, London W14
 Tel: (415) 777-3800 Dealer Inquiries invited Tel: 01 602 6242

dBASE II™ Ashton Tale

*In California add 6% sales tax

Autocode 1™ Stemmoss Ltd.

may have what appears to be a whole new machine.

Of course, no discussion of IEEE-696/S-100 bus advantages would be complete without mentioning that the existence of a standard helps everybody. It makes the modular concept truly workable.

The Future of IEEE 696

Those of us in the industry perceive the IEEE-696/S-100 bus to be long-lived. The most powerful systems in the industry are currently available on the bus, and the trend seems to be continuing. With the new standard's provision for 16-bit capability, 16 megabytes of memory, and expanded TMA capabilities, it will be a long time before computing needs outgrow it.

One point I can't stress enough is that, when buying S-100 systems and products, insist upon products that meet or exceed the IEEE-696 specifications. Be wary of the phrase "compatible with IEEE 696." If you are in doubt about a product, ask for verification, or at least get a guarantee.

Where to Get More Information

If you would like a copy of the standard, send me a legal-size, self-addressed, stamped envelope along with a note indicating your request. By the time this article is published, I should know how the standard is to be distributed. I will return your envelope with a note describing how to get your copy.

Send your self-addressed, stamped envelope to:

Mark Garetz
 Chairman, IEEE-696 Committee
 c/o Compupro
 POB 2355
 Oakland Airport, CA 94614-0355

If you want to read a text that describes the IEEE-696/S-100 bus in clear, precise terms, plus gives a wealth of useful circuits and information, pick up a copy of *Interfacing to S-100/IEEE 696 Microcomputers* at a computer bookstore. It is written by Sol Libes and me and is published by Osborne/McGraw-Hill (1981). ■

Compare Prices Before You Buy!!

COMPUTER SYSTEMS

NEC PC-8001A \$725

Products For Apple Computers

Here are some of the products BISON carries for Apple Computers. If you don't see what you want here, give us a call.

16K RAM Card for Apple II \$ 68
 Microsoft Premium Pack \$ 525
 BISON Add-on Disk Drive
 100% Apple Compatible \$ 279
 Parallel Printer Card with Cable \$ 72
 Apple Compatible Parallel Interface \$ 65
 D. C. Hayes Micromodem II \$ 279
 Graphics Interface for NEC, Epson \$ 129
 Microsoft Z80 Softcard with CP/M® \$ 279
 Videx 80 Column Videoterm \$ 249
 Videx Enhancer \$ 119
 Videx Function Strip \$ 59
 For more Apple information, circle reader service card #51

PRINTERS

BISON carries all of the major brands of printers. If you need help choosing the proper printer for your needs, call and talk to one of our support technicians.

EPSON MX-80 F/T Type III w/Graftrax \$ 460
 EPSON MX-100 with Graftrax \$ 625
 NEC PC-8023A Fric. & Trac. w/Graph. \$ 485
 NEC 7710-1 \$2095
 NEC 7715-1 \$2095
 NEC 7720-1 \$2445
 NEC 7725-1 \$2445
 Okidata Microline 82A 80 Col. \$ 439
 Okidata Microline 83A w/Trac. - 132 Col. .. \$ 639
 Okidata Microline 84P - Parallel \$ 925
 Okidata Microline 84PS - 200 cps P/S \$ 999
 C. Itoh Prowriter I - Parallel \$ 485
 C. Itoh Prowriter I - Parallel/Serial \$ 525
 C. Itoh Prowriter II - Parallel \$ 625
 C. Itoh Prowriter II - Parallel/Serial \$ 675
 C. Itoh F-10 Starwriter - Parallel - 40 cps .. \$1225
 C. Itoh F-10 Starwriter - Serial - 40 cps ... \$1225
 Comrex Daisy Wheel Printer - Parallel \$ 735
 Comrex Daisy Wheel Printer - Serial \$ 785
 Comrex Tractor Feed \$ 195
 For more printer information circle reader service card #52

MONITORS

BMC International
 * 12" Green monitor with P-31 phosphor
 * 15 Mhz* Excellent for 80 column display
 BMC 12" Green Monitor \$ 89
 * 13" Color Monitor* Audio and Video
 * 270 Line resolution
 BMC 13" Color Monitor \$,229
AMDEK Monitors
 * 12" Green Phosphor
 * Non-Glare
 AMDEK Video 300 Call for Price
 * 13" Color Monitor* RGB Input
 * For IBM/NEC/Apple
 AMDEK Color II Call for Price
 AMDEK Color I Call for Price

NEC

NEC 12" Green Monitor \$ 169
 NEC 13" Color Monitor \$ 325
 NEC 13" RGB Color Monitor \$ 815

For more information, circle reader service card #53

TELEVIDEO PRODUCTS

TeleVideo computer terminals and desktop computer systems-high price features at low prices.

TeleVideo TS-802 Computer system

* 64K, 4 Mhz Z-80A, CP/M®
 * Dual Floppies, 720K Total
 * Same CRT and Keyboard as Televideo 950 Terminal
 * Network Expansion Capabilities
 TeleVideo TS-802 \$2645
 TeleVideo TVI-925 Terminal \$ 695
 TeleVideo TVI-950 Term. - Top-of-Line ... \$ 875

For more information, circle reader service card #54

SOFTWARE

BISON carries software for all business and personal computer systems. Just select the software you want and call us for our current price. Here are some examples of BISON'S Low Prices:

MicroPro Software

Call for tremendous savings on MicroPro Software.

Apple Software

All APPLE Game and Business software. Select the program you want and call for price. Save up to 60% off list.

Accounting Plus by Systems Plus

For 8" CP/M®
 General Ledger * Accounts Payable * Accounts Receivable * Payroll * Inventory * Sales Order Entry * Purchase Order Entry and Point of Sale
 G/L \$ 385
 G/L, A/R \$ 745
 G/L, A/R, A/P \$1100
 G/L, A/R, A/P, P/R \$1459
 G/L, A/R, A/P, INV \$1459
 G/L, A/R, A/P, P/R, INV \$1875
 G/L, A/R, A/P, P/R, POS, INV \$2140
 G/L, A/R, A/P, P/R, S/O, INV \$2140
 G/L, A/R, A/P, P/R, P/O, INV \$2140
 G/L, A/R, A/P, P/R, P/O, S/O, INV \$2435
 All 8 Modules \$2695

SOFTWARE

For Apple II
 Pick the Apple Combination you need.
 G/L \$ 276
 G/L, A/R \$ 553
 G/L, INV \$ 553
 G/L, A/R, A/P \$ 649
 G/L, A/R, INV \$ 649
 G/L, A/P, INV \$ 649
 VisiCalc \$ 199
 VisiFile \$ 199
 dBASE II for 8" or Apple ... Call for Lowest Price

S-100 PRODUCTS

Sierra Data Sciences

S-100 Master/Slave Single Board Computers
 Master - 4 Mhz, Z 80A \$ 690
 Slave - 4 Mhz, Z 80A \$ 625
 Sierra Data CP/M \$ 160
 Sierra Data BIOS \$ 100
 Sierra Manual \$ 25
 Sierra Data - Winchester Adaptor \$ 145
 Sierra Data Turbo DOS \$ 750

QT-Systems Mainframes

S-100 Mainframe and 8" Drive Enclosures
 * S-100 Power +8V/16A +16V/3A -16V/3A
 * Drive Power +5V/1A -5V/6A +24V/6A
 * Keypad Power Switch
 * EMI Filter * Filtered Fan
 * Switched Power Outlets
 * 15 - DB25 Cutouts
 * DB37 Cutout * IDS 50 Cutout
 * Hard Disk Power Supply
 * Shielded Motherboard * Rugged Card Cage
 * 9 1/2" x 17" x 21" (H x W x D)
 QT 6-Slot, Dual 8" Drives \$ 530
 QT 8-Slot, Dual 8" Drives \$ 560
 QT 12-Slot, Dual 8" Drives \$ 620
 S-100 Mainframe and 5 1/2" Drive Enclosures
 * Similar to 8" Mainframe
 * 7" x 17" x 20" (H x W x D)
 QT All-in-one 8" Disk Drive Cabinet
 Changeable faceplate allows use of all standard 8" floppy and hard disk drives including:
 * Shugart * NEC
 * Qume * Mitsubishi
 * Tandon (Up to 4 Thin-Line)
 Features:
 * Holds 1-4 8" Drives * Modular Power Supply
 * Power +5V/6A -5V/1A +24V/6A
 List Price \$395 **BISON PRICE \$295**

DISK DRIVES

Qume #842 (Replaces Data-Trak 8) \$ 480
 Tandon Thin 8" Sngl-Side Dbl-Density .. \$ 382
 Tandon Double-Density \$ 465

WABASH FLOPPY DISKS

Single-Sided Single Density
 Box of 10 8" or 5 1/4" \$ 19

SPECIAL OFFER

Buy a Case of Wabash
 5-1/4" Diskettes (100
 diskettes to a case) and
 You Only Pay

SAVE \$2.00 A Box **\$170.00** SAVE \$2.00 A Box



BISON PRODUCTS INC.
 A CALIFORNIA CORPORATION

"We accept Cash, Certified Checks, VISA and MasterCard"

All merchandise new in factory cartons with manufacturer's warranty
 Corporate and School District P.O.'s accepted subject to credit approval.

Enclose financial statement with order.

California residents add Sales Tax. Shipping charges added to all orders.

"No refunds without prior approval" - Bison credit only on returned merchandise.

QUANTITIES LIMITED ON SOME ITEMS — PRICES SUBJECT TO CHANGE WITHOUT NOTICE

For Further Information Please Circle Reader Service #55

Add 3% for credit card purchases.

Send Mail Orders To: P.O. Box 9078-184 • Van Nuys, California 91409

Orders May Be Picked Up At: 16709 Roscoe Blvd., Sepulveda, California 91406

For Questions or Phone Orders Call:

(213) 994-2533

CALL "THE COMPUTER-LINE" IN COLORADO

The Computerline believes that it is important to be competitive by offering low prices; however, we regard service as the most important aspect of a mail-order organization. All our lines are available so that you, the customer, are able to talk to fully qualified computer specialists trained to answer all your questions pertaining to our line of microcomputers. We are renowned for our excellent after-sales support and our promptness for delivery. Peace of mind and excellence in service is our pledge to all our customers.

IBM Personal Computer Products

QUADRAM CORPORATION

QUADBOARD
The ultimate memory board for the IBM, featuring:
• fully expandable from 64 to 256K
• parallel port
• asynchronous (RS232) serial port
• clock/calendar
• RAM disk drive
\$CALL

INTERFAZER
Used as:
• Peripheral buffer
• Multi-User Printer Controller
• Computer I/O Expander
• Incompatible Device Interface
• Peripheral Multiplexer
• Data Transfer Rate Converter
\$CALL

MICROFAZER
• buffering from 8 to 64K (4 to 32 pages of text)
• printer and computer independent
• parallel/parallel; serial/serial and parallel/serial available
• compute while you print!
\$CALL

DAVONG Systems, Inc.

Description:
The Davong Systems Memory Card is a convenient RAM memory expansion card for use in the IBM Personal Computer.
The Memory Card may be placed in any free system slot. It is completely compatible with all IBM Personal Computer software and hardware, and runs at the same speed as IBM memory products.
64K RAM \$225 192K RAM \$499
256K RAM \$599

Hard Disk System for the IBM® Personal Computer. ONLY \$1595.00

Description: 5 MEGABYTES STORAGE
The Davong System's Hard Disk Drive fits conveniently inside the second floppy disk location of the IBM Personal Computer chassis, providing more than 30 times the capacity of a floppy diskette, plus greater speed and reliability.
The DS1-501 System is compatible with IBM software, and supports IBM DOS. The system includes all necessary components and software for installation.
5, 10 and 15 Megabytes available

TANDON DRIVE SPECIAL Double Sided/Double Density 320K BYTES STORAGE TM-100-2 NOW ONLY

\$269

Call for TM-100-4

RGB Color Monitor
SPECIAL!
Princeton Graphic Systems

- 690 Dots Horizontal
- 16 colors
- Non-glare screen
- Sharp looking—matches IBM

\$CALL

IBM SOFTWARE

BUSINESS	ENTERTAINMENT
TAX MANAGER \$199	GALACTIC ATTACK \$26
256K VISICALC \$189	ZORK I \$29
VISITREND/HSPILOT \$239	ZORK II \$29
VISIDEX \$189	DEADLINE \$39
EASY-EFFECTIVE	CALL FOR NEW GAMES
ACCOUNTING SYSTEM \$389	AT UNBEATABLE PRICES
SUPERCALC \$219	T and G JOYSTICKS \$44.95
SUPERWRITER \$289	ADAM AND EVE PADDLES \$29.95

CALL FOR SOFTWARE NOT LISTED

MAYNARD ELECTRONICS	
Floppy Disk Controller with parallel	\$229
Floppy Disk Controller with serial	\$259

THE ULTIMATE IBM® PERIPHERALS Five Function Memory/Serial/Parallel/Clock/Joystick

Monte Carlo™ Card

- Up to 1 Megabyte expandable memory
- Full IBM Compatible RS-232 Serial Port
- Full IBM Compatible Centronics Parallel Port
- Real-time clock with built-in alarm features
- Full dual Joystick Port
- Future Option—Plug-on Direct Connect Modern

And the Sensational \$CALL on a chip

I-C-MAGIC™

GRAPHIC MED/HI RES. SCREEN DUMP
PRINT SPOOLING UP TO 64K
TERMINAL EMULATION
\$CALL

PGS—Princeton Graphics Systems
Hi-resolution, RGB Color Monitor \$CALL

5 1/4" Half Height 'Slimline' drives put two floppies in a single slot! \$CALL

DAVONG 5 - 10 - 15M byte Hard Disk Systems from \$159

* Trademarks of Microcomputer Business Industries Corp. (MB)

Peripherals For All Computers

PRINTERS

NEC Spinwriter 770/7730	\$2339
8024A	\$ 489
STAR	\$CALL
Gemin 10 and Gemin 15	\$CALL
EPSON (Graftrax Plus)	\$CALL
MX 80	\$CALL
OKIDATA	\$CALL
80 no tractor	\$ 339
80 with tractor	\$ 399
82A no tractor	\$ 439
82A with tractor	\$ 479
83A	\$ 699
84A parallel	\$1029
84A serial	\$1139
2K Buffer with serial current loop board	\$ 139
Graphics 82A, 83A	\$ 79

C-I/OH

F10 Word Quality Printer
• 40 CPS Printing
• Letter quality excellence
Now Only \$1395

Printer I 120cps (Parallel)	\$ 469
Printer I 120cps (Parallel/Serial)	\$ 619
Printer II (136 column) Parallel	\$ 899
Printer II (136 column) Parallel/Serial	\$ 749

C-I/OH F10 55 CPS \$1795

INTEGRAL DATA SYSTEMS

PRISM 132 Color printer with all options
• 200 cps Sprint Mode
• 4-color printing
• Friction Tractor feed
\$1595

SMITH CORONA TPI Daisywheel Letter Quality NOW ONLY \$589

MONITORS

Zenith ZVM-121 Phosphor, 15 MHZ	\$ 119
NEC 1201 Phosphor, 20 MHZ	\$ 179
NEC 1201 Composite, Color	\$ 335
NEC 1201 RGB Color	\$ 899
Amdek 300 Phosphor	\$ 179
Amdek Composite, Color	\$ 349
Amdek IBM Compatible Color	\$ 749
BMC Green	\$ 89

Princeton Graphic RGB Color \$CALL
For IBM
Electrohome RGB \$ 749
Electrohome IBM Cable \$ 49

MODEMS

Hayes Smartmodem, 300 baud	\$219
Hayes Smartmodem, 1200 baud	\$539
Hayes Chronograph	\$189
Novation Cat	\$145
Novation D-Cat	\$165
Novation Auto Cat	\$209
CERMETEK 1200 baud modem	\$CALL

DISKETTES (5 1/4 inch)

SCOTCH WITH PLASTIC LIBRARY CASES (Boxes of 10) (48 Track single-sided, double density)	\$26.50
VERBATIM DATALIFE SS/DD (Boxes of 10)	\$24.95
VERBATIM DATALIFE DS-DD (Boxes of 10)	\$44.9
ELEPHANT DISKETTES SS/DD (Boxes of 10)	\$23.9
ELEPHANT DISKETTES DS/DD (Boxes of 10)	\$39.9

NEC PERSONAL COMPUTER PRODUCTS

PC-8001A	Keyboard and processor unit including 32K Ram, 24KB N-Basic Rom, cassette tape recorder interface, parallel printer interface, display interface
PC 8012A	Modular expansion unit including I/O bus extension, diskette adaptor, 32KB Ram, real-time clock, 8 priority interrupt level, 6 slots for additional boards
PC-8023A	Dot matrix printer, 100 cps bidirectional printing, proportional printer
PC-8031A	Dual diskette unit, including two 163K byte diskette drives, interface cable, enclosure and operating system
NEC General Accounting System	
NEC Accounts Receivable System	
NEC Inventory Control System	
NEC Payroll System	
NEC Job Cost System	
NEC Benchmark Word Processing	
NEC CP/M Operating System	
NEC Report Manager	
Data Base	

We carry the entire line of NEC BPI software for the personal computer. Please call or write for information.

with NEW NEC-APC-SCALL

THE BEST PRICES IN THE NATION ON APPLE PERIPHERALS!

MBI APPLETIME CARD

WORKS WITH DB MASTER AND VISIDEX
MOUNTAIN HARDWARE COMPATIBLE

\$89

MBI VIP CARD

THE BEST GRAPHICS CARD
AVAILABLE WITH AN ADDITIONAL SERIAL PORT
(For Modem or 2nd printer)

\$129

WE'RE SMASHING THE PRICES ON APPLE COMPATIBLE DISK DRIVES

FORTH DIMENSION

APPLE COMPATIBLE DRIVES
PLUS ONE BOX OF ELEPHANT DISKETTES

\$289

FORTH DIMENSION

DRIVE WITH CONTROLLER
(including the Apple DOS Master and manual)

PLUS ONE BOX OF ELEPHANT DISKETTES

\$379

Call for prices on RANA and MICROSCI drives

80 COLUMN CARDS FOR APPLE

Wesper 80 Card	\$259
Vision 80 Card (Vista)	\$269
Videx 80 Card	\$249

RAM CARDS

Davong 16K Card, Microtek, and Microsoft 16K Card ALL at	\$ 79
---	-------

T AND G PRODUCTS

Game Paddles	\$ 29
Joy Stick	\$ 44
Selecta-port Expander	\$ 49

APPLE WORD PROCESSING

Screenwriter II <i>On line's Sensational!</i>	\$ 89
Silicon Valley Systems Word Handler II	\$ 159
List Handler	\$ 79
Call for Continental, Dakin 5, Broderbund, Automated Simu- lations, Avant-Garde, Edu-Ware, Denver, Howard, Sirius Sen- sible, Synergistic Software, etc.	

CALIFORNIA COMPUTER SYSTEMS

7710 Async. Serial Int	\$135
7490 GPIB (IEEE-488) Int	\$239
7470 Ana. to Dig. Converter	\$ 99
7711 Async. Serial (Term)	\$135
7712 Async. Serial Int	\$149
7721 Apple Parallel Int	\$109
Calendar/Clock Module	\$ 99
Programmable Timer	\$ 99

MODEMS FOR APPLE

Hayes Micromodem II	\$269
Novation Apple Cat II	\$299
212 Apple Full Duplex (for Apple Cat II)	\$329
212 Apple Cat	\$629
212 Stand Alone Auto Cat	\$599

MODEM SOFTWARE

Visiterm	\$ 79
Transend II	\$119
ASCII Express	\$ 95

CPM FOR APPLE

Microsoft Z80 Softcard	\$269
------------------------------	-------

MISCELLANEOUS APPLE PRODUCTS

Enhancer II	\$119.00
Sup R Mod	\$ 27.95
System Saver	\$ 79.00
Videx Function Strip	\$ 69.00

BUSINESS SOFTWARE

VISICORP, INC.			
Desktop Plan III	\$229	Visidex	\$189
Desktop Plan II	\$189	Visiterm	\$ 79
Visifiles	\$189	Visicalc 3-3	\$189
Visiplot	\$159	Visipak	\$539
Visitrend/Visiplot	\$229		

STONEWARE

DB Master	\$169
DB Utility Pack	\$ 69

MOUNTAIN HARDWARE

CPS Multi-Function Card	\$129
The Clock	\$229
Supertalker	\$159
Music System	\$319
Expansion Chassis	\$599
Romwriter	\$139
Ram Plus	\$149



TERMS

CALL "THE COMPUTER-LINE"

(303) 279-2727
(303) 279-2848
1-(800)-525-7877

THE COMPUTERLINE, INC.

1019 8TH STREET, GOLDEN, COLORADO, U.S.A. 80401

SHOWROOM:

1136 S COLORADO BLVD.
DENVER, CO 80222

Circle 114 on Inquiry card.

All prices reflect a 2 1/2% cash discount. All goods acknowledged faulty or damaged by the customer will be repaired or replaced at our discretion. Customers must call to an RMA number before returning any goods. This facilitates our quick assistance to faulty goods. We reserve the right to repair or return to the manufacturer for repair all goods receiving faulty within the specified warranty period. Any goods (hardware or software) returned for resending are subject to a 10% restocking fee at our discretion. No returns on game software. We accept no responsibility for any late items made by manufacturers. Prices quoted for stock on hand and subject to change without notice. Specialists in APO and international deliveries. Please add 2% (minimum \$3.00) for shipping APO add to all prices 5% for shipping (minimum \$5.00). Please allow 10 working days plus mail time if an order is mailed in the receipt of all UPS delivered goods. All goods (other than APO or international) delivered UPS ground.

All brands are registered trademarks.

The Scribble Text Processor

Christopher O. Kern
201 I St. SW, Apt. 839
Washington, DC 20024

Most text-processing programs permit you to describe the appearance of a finished document by establishing the size of the margins, the number of spaces between lines, the indentation at the start of paragraphs, and the like. Processing instructions, which are inserted into the document as it is written, dictate how the text is to appear on the finished page. Each instruction sets one specific typographical attribute of the final document. The average text processor can be compared to a computer assembly language, in which each statement corresponds to a single primitive operation to be executed by the machine.

Scribble, by contrast, might be described as a high-level language for text. A single formatting instruction in a Scribble document could correspond to several of the more primitive instructions that are available in other text-processing programs.

About the Author

Chris Kern is a Washington, DC, journalist and a frequent contributor to BYTE.

Scribble isn't perfect, and as with any other high-level language, whether or not you are comfortable with it will be to some extent a matter of taste. But there is no question that Scribble can greatly simplify the production of complex documents. It represents a real step forward in the evolution of text-processing tools for small computers.

Scribble might be described as a high-level language for text.

This ability to perform complex operations in response to a single formatting instruction changes the way users think about the documents they are creating. With the average text-processing program, the sequence of commands to display a long quotation within a text would be "skip a couple of extra lines, enlarge the left margin slightly, enlarge the right margin slightly, and single space."

The analogous Scribble command would be "format the next piece of text as a quotation." Scribble encourages users to ignore the final appearance of the document—the program will take care of that for them—and to concentrate instead on the logical relationships among the various sections of their texts. Scribble instructions tend to be functional rather than typographical.

Scribble Environments

For example, business letters are commonly formatted with the sender's address, date, and closing signature on the right side of the page. With one popular type of text processor, the sequence of commands would be something like those shown in figure 1a.

This sequence tells the text-processing program to indent the address 40 characters from the current left margin (.in +40) and to stop filling each line with as many words as possible (.nf). After the address is typed, the text processor is told to restore the previous left margin and to resume filling text. The same sequence of commands must be repeated for the

Apple* en **CASTELLANO**

 Tercer Medio presenta su **sistema administrativo (T.M.A.) para Apple**

Diseñado de acuerdo con los principios contables aceptados en todos los países de habla hispana.

APLICACIONES COMERCIALES Y CIENTIFICAS

- **CONTABILIDAD GENERAL**

Diario General
Resumen del Diario
Consulta parcial al Diario
Mayor General
Balance de Comprobación
Balance General
Ganancias y Pérdidas
Catálogos de Cuentas
Consultas por pantalla

- **CUENTAS POR COBRAR**

Catálogo de Cuentas
Listado de Transacciones
Antigüedad de Saldos
Saldos por Vencer
Relación de Cobranzas
Relación de Pagos
Estado de Cuentas
Consultas varias por pantalla

- **INVENTARIO Y FACTURACION**
- **CONTROL DE BANCOS**
- **PERT/CPM**
- **CUENTAS A PAGAR**
- **CONTROL DE COSTO DE OBRAS**

VENTAJAS DEL SISTEMA T.M.A.

- Son completamente conversacionales.
- El chequeo de la información es instantáneo.
- Los reportes impresos o por pantalla guardan los formatos generalmente aceptados.
- Están pensados para adaptarse a cualquier empresa.
- Toda la información está instantáneamente disponible
- Precisión Expandida.
- Números de hasta ± 999.999.999,99

Circle 410 on Inquiry card.



 **Tercer Medio**
Sistema de Información C.A.

APARTADO DE CORREOS 62533
CARACAS 1060 - A - VENEZUELA
TELEX: 27.876 - CPB TH - VE.
TELEFONOS: 283.60.88 - 284.74.68

* Apple es marca registrada por APPLE COMPUTER INC.

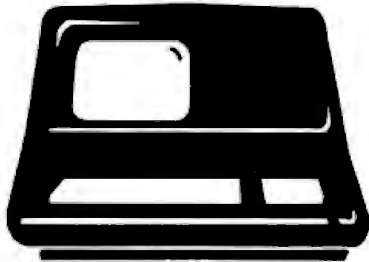

SUPERBRAIN™

The super performing, super reliable microcomputer from Intertec Data Systems features twin double-density 5¼" drives with 350K or 700K of disk storage – expandable to 10 megabytes. A CP/M* Disk Operating System, 64K of dynamic RAM and more.

\$ SUPER PRICE

Because we're a nationwide distributor of SuperBrain, CompuStar, and the CompuStar 10-Megabyte Disk Storage System, we can offer the absolute lowest prices in the business.

⚡ SUPER SERVICE

Better yet, we offer you a great deal of service and support because we want your business tomorrow as well as today.

- We'll burn-in your SuperBrain for 72 hours before we deliver it
- We'll help with installation and configuration
- We'll repair equipment at our service center and replace modules when necessary
- We'll fill your software needs or help you develop your own
- We'll match your SuperBrain with a super printer

For more information call 609-424-4700 or 215-629-1289. To order call toll-free 800-257-5217. In NJ call 609-424-4700.



2 Keystone Avenue
Cherry Hill, NJ 08003

* Registered trademark of Digital Research Inc. SuperBrain and CompuStar are trademarks of Intertec Data Systems.



At a Glance

Name
Scribble, version 1.3

Type
Text-processing software

Author
Mark of the Unicorn
POB 423
Arlington, MA 02174
(617) 489-1387

Distributors
Westico, Lifeboat Associates, Cornerstore
or direct from manufacturer

Price
\$175

Format
Various CP/M disk formats

Computer
CP/M 8-bit machines; CP/M-86 version
to be introduced

Documentation
100-page user manual; 99-page program
logic manual

Audience
Anyone needing a sophisticated
text-processing program

(1a)

```
.in +40
.nf
1600 Pennsylvania Ave.
Washington, D.C.
Jan. 20, 1985
.in -40
.fi
```

(1b)

```
@address<1600 Pennsylvania Ave.
Washington, D.C.
Jan. 20, 1985>
```

Figures 1a and 1b: Comparison of Scribble formatting commands with those of another word processor. Figure 1a shows how the address portion of a letter might be done using a popular word-processing program; figure 1b shows the same address with analogous Scribble commands.

closing of the letter. To do the same thing with Scribble, the source text would look like figure 1b.

The command @address and its synonym, @closing, are examples of what Scribble's authors call *environments*. (The @ character is reserved to signal commands to the Scribble text processor.) An environment is a section of text that is to be formatted in some particular way. For example, in the @address environment:

—Each line is kept the same length as it appears in the input file (i.e., short lines are not filled and long lines are not wrapped).

—The lines of the address are left-justified.

—The left edge of the address is placed at the center of the page.

Scribble provides 23 predefined environments. One is the @itemize environment, which arranges a list of items in the format shown in the preceding paragraph. Another environment prints long quotations as single-spaced, indented paragraphs so that they will stand out from the surrounding text. Several other Scribble environments perform operations that are available in all sophisticated text-processing programs. Text can be centered or printed flush left or flush right. You can also create paragraphs with hanging indentations, in which the first line of the paragraph is

KEY TRONIC PERFECTS THE IBM* PC KEYBOARD



Familiar Key
Legends Rather
Than Symbols

SHIFT Key
In Familiar
Typewriter Location

LED Indicators
On All Lock Keys
To Show Status

RETURN Key
In Familiar
Typewriter Location

Convenient
ENTER Key

Enhance your IBM* Personal Computer System with a Key Tronic keyboard peripheral.

This low-profile keyboard is plug-compatible and has familiar key placement. It also features reliable microprocessor electronics, solid-state capacitance switches, and positive tactile feedback.

Price: \$235.00, includes shipping & handling. To Order Model KB-5150 Call Toll Free 1-800-262-6006 (8 a.m. - 4 p.m. Pacific Standard Time)



THE RESPONSIVE KEYBOARD COMPANY

DEPT. E • P.O. BOX 14687 • SPOKANE, WASHINGTON 99214 USA

*IBM is a registered trademark of IBM Corporation

HOT PRICES! FAST SERVICE! COMPUTERS

Model	List	Our Price
SB II 350K byte, 64K	\$2495	\$1875
SB II QD 750K, 64K	\$2995	\$2250
SB II SD 1.6mb, 64K	\$3495	\$2750
Syscom 48K, Apple Compatible	\$725	
BASIS 108, Apple Compatible		Call
ALTOS		Call
FRANKLIN, Apple Compatible		Call
EAGLE		Call
COMMODORE 64		Call

DISK DRIVES

IBM SS/DD	\$199
IBM DS/DD	\$259
APPLE Compatible S/S	\$219
APPLE Drive Controller	\$100

PRINTERS

NEC 8023A parallel only	\$487
Epson MX80FT, 80 cps	\$519
Smith Corona Daisywheel	\$649
Brothers Daisywheel	\$815
Okidata 82A, 120 cps	\$439
Okidata 83A, 120 cps	\$719
C. Itoh F-10, 40cps	\$1449
NEC 3510 or 3530	\$1575
NEC 7710/7730	Call
Other Brands	Call

MODEMS

Hayes Smartmodem	\$219
Hayes 1200 Baud	\$549
Other Brands	Call

MONITORS & TERMINALS

NEC 12" Green Screen	\$162
Amdek Amber Screen	\$165
Taxan I 380 resolution	\$310
BMC Green Screen	\$85
Adds Viewpoint, green	\$545

APPLE & IBM ITEMS

Seattle Computer Products	Call
Quadram Products	Call
Mountain Computer Products	Call
Practical Peripheral Products	Call
Viewmax 80 col. card	\$219
Videoterm 80 col. card	\$252
Software	Call for Great Prices!

Information: Call (206) 362-3398

ORDERS ONLY 1-800-531-3133

Mail & Phone Orders Only. Prices reflect 3% cash discount. Sorry, no COD.

PACIFIC COMPUTERS

11056 Palatine N.
Seattle, WA 98133

(2a)

@description<FORTRAN @\ The great progenitor. A real step forward in its day, but it has had a tendency to hold back progress ever since.

COBOL @\ Is prolix. Reminds me of what Abraham Lincoln once said about a fellow lawyer: "He can compress the most words into the smallest ideas of any man I ever met."

BASIC @\ You can love it or you can hate it, but you can't ignore it. BASIC is characterized by the best acronym of the lot: "Beginner's All-purpose Symbolic Instruction Code."

PL/I @\ Is to computer languages what Texas is to states: smaller than Alaska but bigger than everything else.

LISP @\ Can be most clearly described in LISP. ((Parenthetically, LISP is considerably easier to use than many people think.) LISP can be thought of as a "high-level machine language" in which other languages can be written, an attribute that has proved important in research.

C @\ Simple, clean, terse.

Pascal @\ Pascal is for classroom use. It is precise and mathematical. A Swiss professor thought it up. He should have taken a sabbatical.

Ada @\ The future, formally certified by the Department of Defense. Ada is the government's attempt to negotiate a computer language nonproliferation treaty with itself. But, sources say, the parties are still far apart.>

(2b)

FORTRAN The great progenitor. A real step forward in its day, but it has had a tendency to hold back progress ever since.

COBOL Is prolix. Reminds me of what Abraham Lincoln once said about a fellow lawyer: "He can compress the most words into the smallest ideas of any man I ever met."

BASIC You can love it or you can hate it, but you can't ignore it. BASIC is characterized by the best acronym of the lot: "Beginner's All-purpose Symbolic Instruction Code."

PL/I Is to computer languages what Texas is to states: smaller than Alaska but bigger than everything else.

LISP Can be most clearly described in LISP. ((Parenthetically, LISP is considerably easier to use than many people think.) LISP can be thought of as a "high-level machine language" in which other languages can be written, an attribute that has proved important in research.

C Simple, clean, terse.

Pascal Pascal is for classroom use. It is precise and mathematical. A Swiss professor thought it up. He should have taken a sabbatical.

Ada The future, formally certified by the Department of Defense. Ada is the government's attempt to negotiate a computer language nonproliferation treaty with itself. But, sources say, the parties are still far apart.

Figures 2a and 2b: An example of Scribble's @description environment, which formats a series of items in a way that permits them to be listed and then elaborated individually. Figure 2a is the input file. The @ \ characters are typewriter-style tabs that instruct Scribble to place the next printing character at the @description environment's preset tab position. Figure 2b shows the result.

FOX & GELLER

gives dBASE II™ users

10 good reasons why they need

QUICKCODE™

The dBASE II™ Program Generator

Reason
#1 **Save Time.**
Quickcode saves you time, because it can write complete dBase II applications programs in minutes.

Reason
#2 **Ease of Use.**
Quickcode requires *no programming* or computer knowledge. If you can type, then you can create a customer or inventory database in 5 minutes.

Reason
#3 **dSCAN.™**
The unique dSCAN feature lets you *select records based on your own requirements* (e.g. STATE = 'NJ' or AGE > 30). Then you can print them in a variety of formats (or transfer them to Wordstar™ for form letters).

Reason
#4 **Wordstar.™**
If you want to create form letters using your data, Quickcode can transfer any part of your database to Wordstar.™

Reason
#5 **Mailing Labels.**
Want to print mailing labels? With Quickcode, you can get them in *one up* or *four up* format. You can print labels of almost any size or shape you can imagine. For any part of your database (e.g. ZIP CODE = 90023)

Reason
#6 **Reports.**
Quickcode can create an amazing variety of reports and forms. You can even produce reports up to 132 columns by 96 lines per page.

Reason
#7 **Power.**
Quickcode can set up retrieval keys using as many as 10 data fields. You can use these keys to get any record from your database in about 2 seconds. Data entry is also a snap. You can have any data field automatically set to a default value or checked in one of three ways: range checking, match list checking, or file lookup.

Reason
#8 **Capability.**
Now, you can use *four new data types* not found in dBASE II itself: date, money, telephone, and social security. Just what you need to simplify your work.

Reason
#9 **Menus.**
Want to setup a more powerful application? Use the Quickcode menu generator to create a menu system.

Reason
#10 **Fox & Geller.**
Perhaps the most important reason to buy Quickcode. We've built a reputation for quality products that *keep improving*. Like dGRAPH (the dBase II graphics system) and our dUTIL utility.

Fox & Geller's Quickcode: \$295.00

We intend to earn your loyalty by offering software that's the best.

For further information or to see Quickcode in action, see your local dealer or call (201) 837-0442.



FOX & GELLER

Fox & Geller, Inc.
P.O. Box 1053
Teaneck, NJ 07666
201 837-0142

Quickcode and dSCAN are trademarks of Fox & Geller, Inc.
dBASE II is a trademark of Ashton-Tate.
Wordstar is a trademark of MicroPro International

(3a)

```
@begin<level>
Scribble provides facilities for automatic numbering of
sections and paragraphs of documents.

A number of different formats are available.
@begin<level>
For example, you could number the sections of a document
but not the individual paragraphs.

Different levels of numbering are automatically provided.
This paragraph, for example, has two levels of numbering.

Indentation can also be controlled to a considerable extent.
@end<level>

This feature greatly simplifies the creation of documents
that have a complex and explicit structure, such as technical
manuals.
@end<level>
```

(3b)

1. Scribble provides facilities for automatic numbering of sections and paragraphs of documents.
2. A number of different formats are available.
 - 2.1. For example, you could number the sections of a document but not the individual paragraphs.
 - 2.2. Different levels of numbering are automatically provided. This paragraph, for example, has two levels of numbering.
 - 2.3. Indentation can also be controlled to a considerable extent.
3. This feature greatly simplifies the creation of documents that have a complex and explicit structure, such as technical manuals.

Figures 3a and 3b: An example of Scribble's `@level` environment, which is one of several ways provided by the program to automatically structure and number sections of text. Note that one instance of the environment is nested within another to improve readability. The `@begin<level>` and `@end<level>` instructions in the source text of figure 3a are synonyms for the `@level< and >` syntax that would normally enclose the text of the environment if you weren't nesting instructions. Figure 3b shows the result.

flush left but all subsequent lines are indented. Somewhat more unusual is the `@description` environment, which formats text into two columns (see figure 2 on page 306.)

Structured Text

Scribble includes a variety of environments that make it easy to structure text into a series of indented and sequentially numbered paragraphs of the kind commonly found in textbooks and technical manuals. Sections and subsections of a document are automatically set apart and numbered. This makes it easy to create or change a complex document composed of numbered sections and para-

graphs. You can insert new material knowing that the indentation and numbering of the document will be preserved and, where necessary, updated automatically (see figure 3).

Environments are what distinguish Scribble from other text-processing programs. The only real problem is that the average user will have to accept each environment as it was defined by Scribble's authors. Fortunately, the stylistic choices that the authors have made are reasonable. Source code for most of the program, written in the C computer language, is supplied as part of the package. The authors explain the program logic in some detail in the Scribble

manual, and an experienced C programmer should have no great difficulty modifying the program. There is even a Scribble users group to distribute extensions to the program. Still, it would be nice to be able to re-define the existing environments without programming. Ideally, it should be possible to create entirely new environments, each composed of primitive text-formatting commands or even other environments.

Other Commands

In addition to environments that format an entire block of text, Scribble provides 10 *inline* environments to determine how individual characters are printed. These provide familiar features such as underlining, bold-face, subscripts, and superscripts. Even though these operations are common to most text-processing programs, Scribble's attention to detail is impressive. For example, Scribble includes three different underscore commands: underscore all printing characters, underscore only alphanumeric characters, and underscore continuously. Two separate italics commands—regular and boldface—provide insurance, the authors say, against the day when printers with italics capability are more commonly available.

In many cases, you can nest Scribble environments and inline environments. That is, you can give one command inside another. For example, one element in an itemized list can be underscored, or the `@level` environment depicted in figure 3a can be invoked within itself to produce multi-level structures (the second level in figure 3b was produced this way).

The remaining category of Scribble commands, which the program's authors refer to as *directives*, is composed of instructions that, for the most part, cannot contain other Scribble instructions. Some directives are similar to inline environments in that they provide commonly available text-processing functions. You will find directives to define page headings and footings, to skip lines or start new pages, and to read and insert other files into the running text. Footnotes are automatically num-

bered, and one directive specifies whether the notes are to be printed within the text, at the bottom of each page, or at the end of the document.

The @style Directive

The @style directive takes a variety of arguments. It is used to specify margins, paper size, the extra space (if any) between paragraphs, the amount of indentation for new paragraphs, whether the text is to be justified, and other fundamental stylistic characteristics. One nice feature of the @style directive is that, where it requires numeric arguments (such as in specifying paragraph indentation), the argument can be entered in just about any unit of measure that is handy. The @style directive will accept arguments expressed in characters, lines, centimeters, millimeters, points, picas, ems (these last three are printer's measures), and micas. A mica is the internal unit of measurement used by Scribble. It corresponds to 10 microns, or about 1/2540 of an inch. Unfortunately, relative values are not permitted. So, for example, it is impossible to issue a command to increase the line spacing by one.

A number of other Scribble directives concern various types of automatic numbering. You can have the *sectioning* directives number portions of the text. There are six of them, corresponding to chapters, sections, subsections, and paragraphs for the main body of the text, and chapters and sections for appendixes. Each sectioning directive creates a subtitle or heading in the document. Every time you invoke a sectioning directive, an entry is automatically made in the document table of contents. Similarly, an @index directive automatically creates an index for the document. The instruction @index <message> within a Scribble text creates an index entry composed of the message and a reference to the current page.

The remainder of the directives deal mostly with string and numeric variables. Section numbers and headings are automatically maintained by Scribble, as is the current page number. Other variables can be defined by the user. For example, a common-

ly used string, such as an address, can be defined once in a document and introduced repeatedly into the text simply by referring to a single-word variable name. You can change variables or set them to the value of other string variables. You can add or subtract numeric variables.

Printing Scribble Files

Scribble itself can display formatted documents on the system console or on a simple Teletype-style printer

(i.e., one that does not need any special control codes). Scribble can also write a formatted document to a disk file. If a more sophisticated printer is available—for example, one that has a proportionally spaced type font or one that can move up a fraction of a line to provide properly superscripted footnotes—a second program must be used to put the finished document on paper. Splitting up the formatting and printing jobs introduces an extra step, but it keeps

DATA PROCESSING

MARTIN MARIETTA AEROSPACE

DATA PROCESSING OPPORTUNITIES

Martin Marietta Aerospace, NASA's prime Contractor for the Space Shuttle External Tank has immediate openings for Data Processing professionals. Because we actually manufacture the external tank, you'll get to see the actual results of your efforts.

COMPUTER PROGRAMMER/ANALYSTS

Immediate opportunities exist for individuals experienced in:

- UNIVAC 1100

- ASCII COBOL
- DMS 1100
- DDL, SDDL, DMU
- DML, QLP
- DPS 1100, TIP
- D/B Editor

- APPLICATION EXPERIENCE

- Shop floor control, Scheduling, Manufacturing, Inventory, Purchasing, Configuration Management, Quality, Engineering.

- DATA BASE OPENINGS

- Analyst, Design, Administrators with above hardware, software and applications experience.

These opportunities exist at our Michoud Assembly Facility located in suburban East New Orleans.

Qualified candidates interested in learning more about these opportunities at Martin Marietta should forward resumes, including salary history to Martin Marietta Aerospace, Denver Glazier, BYTE-283, P.O. Box 29304, New Orleans, Louisiana 70189. We are an equal opportunity employer, m/f/h.

MARTIN MARIETTA

the size of the Scribble program manageable without sacrificing flexibility.

For all but the simplest printers, Scribble produces an intermediate, formatted file. This file contains a minimum of information about the actual device on which the document will be printed. A second program, called Crayon, reads the intermediate file and prints the finished document. Crayon knows the details of different printers and produces the required control sequences to make the most out of each printer's specific hardware capabilities. You can make a rough draft quickly on a high-speed, dot-matrix printer. Then a finished copy can be made on a letter-quality printer, using proportional spacing, special type fonts, or whatever sophisticated features are available.

Different printers, by the way, don't really have to be literally different machines. The user can create several *logical* device specifications for the same *physical* machine. For example, a formfeed could move the forms one distance for printing out mailing labels and a different distance for printing correspondence. The same physical printer might be used in both cases, but the meaning of *formfeed* would depend on the particular application.

Configuration

The Scribble/Crayon system is delivered with the ability to drive the most common small-system printers. It comes with a configuration utility that makes customizing the programs for many other printers and creating

"logical" printers fairly simple. It may be necessary to write new driver code for a printer with unusual control sequences.

The configuration program has several other functions. It can reset the default style parameters for such features as margins, line spacing, paragraph indentation, and the like. (Of course, these can be set by @style directives inside the text of each document as well.) The configuration program also enables the user to define certain input and output characteristics of the host computer system. In most cases, installing Scribble should pose no obstacle even to a nontechnical user.

The Scribble manual is complete and well organized. Mark of the Unicorn provides a tutorial introduction along with an extensive user's manual. I found the user's manual difficult to follow in a few places, but for the most part, the writing is clear if undistinguished. Scribble takes a bit of getting used to precisely because it is different from most other text-processing programs. But that, of course, is why it is worth the effort. Separate documentation is provided in the manual to explain the source code modules. As might be expected, these sections are written for the programmer, not the casual user. Incredibly—because it could have been produced so easily using Scribble—the manual has no index.

Scribble is fun to use, even on a relatively simple document such as this article, but it is at its best when used to produce complex or long

documents, especially highly structured, technical ones. Scribble would be an excellent program to use to write computer reference manuals, by the way. Too many manuals lack clarity, regardless of the quality of the writing, because of poor organization and format. Scribble's automated sectioning, footnoting, indexing, and table-of-contents features should greatly simplify the creation of complex, multilevel texts.

Conclusions

- Scribble can be described as a high-level language for text processing that encourages users to concentrate on the structure of the document.
- Scribble environments deal with relatively large sections of text. The program also provides conventional commands for instances where a predefined environment is not appropriate.
- Scribble comes with source code for most program modules, making it possible to alter or extend its capabilities.
- Scribble is capable of using the sophisticated hardware features of the most common small-system printers.
- Scribble is at its best when it is used to produce long or complex documents.

[Mark of the Unicorn is now selling version 1.4 of Scribble, which is advertised as being substantially the same as version 1.3 with a few bugs worked out. . . . Ed.] ■

C

compilers

- FULL C
- UNIX* Ver. 7 COMPATABILITY
- NO ROYALTIES ON GENERATED CODE
- GENERATED CODE IS REENTRANT
- C AND ASSEMBLY SOURCE MAY BE INTERMIXED
- UPGRADES & SUPPORT FOR 1 YEAR

HOST	6809 TARGET	PDP-11*/LSI-11* TARGET	8080/(Z80) TARGET	8088/8086 TARGET
FLEX*/UNIFLEX* OS-9*	\$200.00 <small>WITHOUT TARGET</small> \$350.00 <small>WITH TARGET</small>	500.00	500.00	500.00
RT-11*/RSX-11* PDP-11*	500.00	200.00 <small>WITHOUT TARGET</small> 350.00 <small>WITH TARGET</small>	500.00 <small>l</small>	500.00
CP/M* 8080/(Z80)	500.00	500.00	200.00 <small>WITHOUT TARGET</small> 350.00 <small>WITH TARGET</small>	500.00
PCDOS*/MSDOS* 8088/8086	500.00	500.00	500.00	200.00 <small>WITHOUT TARGET</small> 350.00 <small>WITH TARGET</small>

PCDOS is a trademark of IBM CORP. MSDOS is a trademark of MICROSOFT. UNIX is a trademark of BELL LABS. RT-11/RSX-11*/PDP-11 is a trademark of Digital Equipment Corporation. FLEX*/UNIFLEX is a trademark of Technical Systems consultants. CP/M is a trademark of Digital Research. OS-9 is a trademark of Microware & Motorola

408-275-1659

TELECON SYSTEMS
1155 Meridian Avenue, Suite 218
San Jose, California 95125



Plug 3,000 new applications into your Apple.®

THE CP/M Card™ plugs CP/M Plus™ into your Apple. The CP/M Card gives you the option of running your Apple II with the speed and capability of a professional Z-80 system with CP/M®-compatible software. You plug in the CP/M Card. Then choose CP/M or your standard Apple software at your option.

Plug into a big, new world of software. The CP/M Card gives you instant access to the world's largest selection of microcomputer software—more than 3,000 CP/M-compatible applications, languages, and programming utilities. So, you, too can use professional business programs such as WordStar,® SuperCalc,™ Condor,™ and other high-performance software from Day One. Yet, you still have access to your present library of Apple software.

Plug into incredible performance. Together, the ultra-fast CP/M Card and CP/M Plus run applications up to

300% faster than your Apple system! The CP/M Card is the only Apple II performance package that offers the speed and efficiency of CP/M Plus.

A plug about quality.

The CP/M Card was designed and built by Digital Research, the creators of CP/M, and Advanced Logic Systems, the most respected manufacturer of Apple performance products. So you know the CP/M Card is the most perfectly integrated Apple performance package you can buy.

Why just keep plugging along? The CP/M Card provides everything you need—including 64K of on-board memory, CP/M Plus, CBASIC,® GSX™-80 and full documentation—for just \$399.

Now available through the CP/M library. See your local microcomputer dealer today. Or contact Advanced Logic Systems, 1195 East Arques Ave., Sunnyvale, CA 94086 (800) 538-8177. (In California (408) 730-0306.)



Advanced Logic Systems
The CP/M Card for your Apple II.

CP/M, CP/M Plus, the CP/M Card and CBASIC are either trademarks or registered trademarks of Digital Research Inc. Z-80 is a registered trademark of Zilog, Inc. WordStar is a registered trademark of MicroPro International Corporation. SuperCalc is a trademark of Sorcim Corporation. Condor is a trademark of Condor Computer Corporation. GSX-80 is a trademark of Graphics Software System. Apple is a registered trademark of Apple Computer, Inc. ©1982 Digital Research Inc.



Draw attention to yourself.

(Write a program for the IBM Personal Computer.)

Let your imagination take wing.

Think charts. Graphs. Shapes. Images.

Use originality, creativity and color in programs that entertain. Educate. Organize. Analyze. And programs that get down to business.

Maybe you've written software like that. Or perhaps you're thinking about it.

If so, consider this.

You could draw attention to yourself by writing programs for the IBM Personal Computer on the IBM Personal Computer. Because all our advanced features (see the box at right) make it faster and easier to do so.

Enhanced BASIC already in ROM, for example, has graphics commands already built in.

And if you write a program using our Advanced BASIC, you'll find the DRAW command particularly appealing. It's virtually a separate graphics language *within* a larger language.

Put your visual together with any of the 128 characters and symbols in ROM for a simultaneous, text-and-graphics mix.

Have musical accompaniment as well.

It's easy, because BASIC controls the built-in speaker with a single command.

Utilize the ten, programmable function keys. Try F3 to paint. F4 for lines. F5 for circles. Or F6 for boxes.



IBM PERSONAL COMPUTER SPECIFICATIONS

User Memory 16K-512K bytes*	Display Screen High-resolution* 80 characters x 25 lines Upper and lower case Green phosphor screen*	Permanent Memory (ROM) 40 bytes*
Microprocessor 16-bit, 8088*	Auxiliary Memory 2 optional internal diskette drives, 5¼", 160K bytes or 320K bytes per diskette	Color/Graphics <i>Text mode:</i> 16 colors* 256 characters and symbols in ROM*
Keyboard 83 keys, 6 ft. cord attaches to system unit*	Operating Systems DOS, UCSD p-System, CP/M-86†	<i>Graphics mode:</i> 4-color resolution: 320h x 200v* Black & white resolution: 640h x 200v* Simultaneous graphics & text capability*
10 function keys* 10-key numeric pad Tactile feedback*	Languages BASIC, Pascal, FORTRAN, MACRO Assembler, COBOL	Communications RS-232-C interface Asynchronous or SDLC protocols Up to 9600 bits per second
Diagnostics Power-on self testing* Parity checking*	Printer All-points-addressable graphics capability Bidirectional* 80 characters/second 18 character styles 9 x 9 character matrix*	

*ADVANCED FEATURES FOR PERSONAL COMPUTERS

Remember that these function keys make your program more "friendly" to the user and, therefore, more appealing to us.

In fact, if you're interested in licensing your software, we could be interested in publishing it.

We could also be interested even if it runs on *another* computer. If we select your software, we'll ask you to adapt it to our system.

So if you think your software is close to picture perfect, consider sending it in.

For information on how to submit your completed program, write:

IBM Personal Computer,
External Submissions, Dept. 765 PC,
Armonk, New York 10504.



The IBM Personal Computer A tool for modern times

For more information on where to buy the IBM Personal Computer, call 800-447-4700. In Alaska or Hawaii, 800-447-0890.

†UCSD p-System is a trademark of the Regents of the University of California. CP/M-86 is a trademark of Digital Research, Inc.

Circle 201 on Inquiry card.

Problem Oriented Language

Part 3: Assembling the Modules

The modules are assembled into a complete programming system.

Mark Finger
2439 Overlook Circle
Lawrence, KS 66044

In parts 1 and 2 of this series (see the December 1982 and January 1983 BYTEs), the concept of Problem Oriented Language (POL) was introduced. POL uses input that incorporates terms normally used in describing a particular problem. These terms are organized into phrases and sentences that resemble English sentences. The input is relatively free of the format restrictions normally associated with question-and-answer or menu input. Much more information can be input with a single entry. A typical entry such as "Draw an XY graph, X from 0 to 4, Y from -2 to 3, Title 'Contour Plot,' Execute" would replace dozens of responses required for other types of input. POL-type input is normally used in technical or graphics applications, where many possible parameters can be changed, but only a few need to be set at any given time.

The Problem Oriented Language Programming System (POL/PS) was introduced to provide microcomputers with the capability of handling POL, especially in terms of solving technical problems. The series of routines (POL-80) for handling POL input was presented and the capabilities were examined.

The actual use of the routines within POL/PS was discussed, showing the steps involved in writing a module to find the root of an equation.

Modularity

I have heretofore covered in some detail the concept of POL and how to program using POL-80 routines. The real key to success in using the POL/PS, however, lies in modular programming.

What Is a Module?

We often hear that good computer programs are modular. Every programming course and textbook stresses that point. But what makes a program modular? Would you recognize a module if you saw one?

The dictionary definition of a module is "any of a set of units designed to be arranged or joined in a variety of ways." This shows that the key concepts of modularity are *flexibility* and *similarity at the boundaries*. A functional definition of a module is simply this: "A module should do one thing and do it well."

The idea in modularity is that units can be chosen and linked together *in order to reach a goal*. One example of

this is the way most kitchens are built using modular cabinets. Each type of cabinet handles a specific task well, and we choose a certain combination of types to best achieve our overall objectives.

When a programmer writes a modular program, a number of units, segments, or sections will be in the program, each having a specific task to perform in achieving the program's goal. These units are linked together by a mainline program (the highest level of control). This concept of modular programming is a tremendous aid in debugging but is very difficult to learn. To get some idea of how modules can be used in programming, let us examine some of the different types.

Programming modules differ mainly in the *level* at which they do their "one thing." The first, and lowest, level is best shown by the one-line functions (or modules) of FORTRAN and BASIC. These modules use a single equation to return a single value. Obviously, they do just one thing.

The best example of second-level modularity is the FUNCTION subprogram in FORTRAN. It does more complex work on its input, but it



"It would be hard to find a more powerful or sophisticated desktop computer within the price range of the Sanyo."
InfoWorld - 11/29/82

SANYO PLUS



The best deal in a dual drive 64K Z-80 system, now only \$1995. We thoroughly integrate and test each system and warranty each Sanyo Plus for 90 days.

We are so confident of Sanyo's inherent reliability and our pretesting that we will warranty the entire system for a full year for only \$99.

The Sanyo Plus consists of a Sanyo MDC-1000 computer with a built-in 12" high-res. green phosphor 25x80 display. The detached keyboard features 5 special function keys and a 10-key pad. The Sanyo Plus comes complete with a parallel printer port, a serial communications port and room for three additional cards.

Plus we've added a second drive to give you a total formatted disk capacity of 624K.

Plus you get over \$1100 worth of software including CP/M® 2.2, Wordstar 3.0 with training guide, Sanyo Basic-a superser of Microsoft Basic with diagnostics and utilities, CalcStar® - the spreadsheet that works with Wordstar, and a disk with 20 games.

Plus we generate work copies of all your software.

Special Offer: 5 module business software pack: \$99.

No Dealers please. F.O.B. Scottsdale

Sanyo Minus: Same as the Sanyo Plus with 1 drive \$1649

Just added: 300 Baud Modem, cable, software and 1 month subscription to The Source TM

\$1995

TELEVIDEO



Now backed locally by T.R.W. Built-in CRT, detachable keyboard, dual floppies w/750K formatted capacity, 64K, CP/M and more. Special: Telesolutions - Wandstar TM and CalcStar TM w/system \$279.

- 802 w/CP/M® \$2669
- 806 (20 Mb) \$5149
- T5 1602G \$3495
- T5 1602GH \$5495
- 816 (23 Mb) \$6298
- 800A's \$1299

ALTOS



Our tech's favorite systems. From the lowest priced 3-user systems with either 2 or 6 MG. storage, to 40MG, 8-user 16 bit systems.

Add terminals, printers, and software and we can fully test and configure your system at low prices. Back nationwide by Moore Systems Service.

- Series 5-15D \$2195
 - Series 5-5D \$3995
 - Series 5-86-2 \$3395
 - 8000-10 \$5575
 - 8600-12 \$9465
- Series 5, 8000, systems include MP/M

ZENITH



IDM-PC Compatible

Introducing the Zenith Z-100, its the new 8/16 bit system that's CP/M, PC-DOS, and 5-100 compatible. Plus it's backed by 300 Zenith service centers nationwide.

Two built-in 320K 5 1/4" drives, 128K RAM, optional color graphics with control of eight colors and 144,000 dots, five 5-100 expansion slots, and a full feature keyboard.

- Z120 call
- Z110 call
- Z-90-82 w/64K \$2275

NORTHSTAR



Prices now include free burn and test. We warranty each unit for 90 days from the day you receive it (not 90 days from the day we receive it). Call for prices on compatible software and hardware.

- Advantage 64K Quad \$2769
- Horizon 64K Quad \$2695
- Advantage w/5 Mb. \$3795

TERMINALS



Viewpoint 3A Plus: New Viewpoint emulates Lear Siegler, Televideo, or Soroc. We're selling them at a lower price than others charge for older models.

- \$489
 - Zenith ZT-1' \$559
 - Televideo 910 \$579
 - Televideo 925 \$735
 - Televideo 950 \$927
 - Zenith Z-19 \$689
 - Adds Viewpoint \$489
 - Wyse WY-100 \$765
 - Soroc IQ 130 \$599
 - Adds Viewpoint 60 \$724
 - Hazeltine Espirit \$499
 - Hazeltine Espirit II \$549
 - Hazeltine Espirit III call
- ¹ with built-in modem



Scottsdale Systems Ltd.

617 N. Scottsdale Road, Suite B, Scottsdale, Arizona 85257

(602) 941-5856

Call 8-5 Mon.-Fri.

SERVICE/ORDERING

INTEGRATION: Prices listed are for new equipment in factory sealed boxes with manufacturer's warranty. We will pretest your equipment, integrate your system, configure your software, provide special cables, etc., for an additional charge. Call for prices.

ORDERING: MAIL ORDER ONLY. Prices listed are for cash. No C.O.D.'s. We sell on a net 20 basis to Fortune 500 companies and Universities Charge cards add 2%. Prices subject to change, product subject to availability. AZ. residents add 5%. Personal checks take 3 weeks to clear. 0-20% restocking fee for returned merchandise. Shipping extra - products are F.O.B. point of shipment. CP/M and MP/M are registered trademarks of Digital Research.

SOFTWARE: We sell all popular CP/M® programs at discount. Software sold only with systems not warranted for suitability.

PRINTERS



- NEC8023A \$469
- Okidata 82A \$409
- Okidata 83A \$649
- Okidata 84AP \$995
- Epson MX 80, 100 call
- Gemini 10, 15 call
- Tally 160L \$739
- w/TRAC \$649
- Microprism 80 \$649

HIGH SPEED

- Prism 80 "Loaded" \$1329
- Prism 132 "Loaded" \$1469
- Anadex 9501A \$1369
- DataSouth DS-180 \$1249
- TIB 10's Call

LETTER QUALITY

- NEC 3510, 30 \$1495
- NEC 7710, 30 \$2149
- Qume 9/45 \$1895

I/O DEVICES

Houston Instruments:

- Hi-Pads call
- DMP-29 \$1569
- DMP-40 \$745

Hayes:

- 300 Smartmodem \$219
- 300/1200 Smartmodem call

DAISYWRITER 2000

The best price/throughput in letter quality printers. 4k buffer, 8 protocols, graphics mode, 4 interfaces std., Sub and Superscript, Proportional Spacing, and much more. Uses std. ribbons.



\$1014

should, essentially, do just one thing because it returns just one value. A good example of this type of module in POL-80 is subroutines 750, 800, 850, and 950 (see part 1). Their one thing is to test for a certain situation and return one primary value, the value of FLAG, which indicates a successful or an unsuccessful test. Certainly, they perform a number of actions (especially subroutines 850 and 950, which must carry out a variety of tasks to extract and examine numbers), but they do only as much as is needed to accomplish their one thing.

The third level of modularity involves the return of multiple values, as is often done in subroutines in FORTRAN or BASIC. Examples include subroutines to do the inversion of a matrix or to solve a series of simultaneous equations. These modules still do just one thing.

At higher levels of modularity, the module may be a section of a major program. In my field—chemical engineering—we speak of thermodynamic modules, meaning a group of subroutines that compute temperature, pressure, and other values according to some set of equations. There will be a module for each different model (set of equations) that we use. Some large engineering systems may have five or more thermodynamic modules. The one selected will depend on the chemicals being used or on some similar criteria.

These four levels of modules should cover most ordinary programming. It should be possible to write any given program by simply linking together various levels of modules to accomplish a desired task.

Why Use Modules?

What good are modules? Why is there all this stress on them? Why should you bother to spend all this extra time writing modular programs if all you get is a little less time spent on debugging? Modular programming has several advantages:

- It can reduce a program's size. Calls to a single module from different places in a program are preferable to writing the same lines of code again and again.

- A good module will be portable. This can reduce the amount of writing that a programmer will need to do because major portions of code are available from previous programs. This is especially true when using graphics and numerical methods.

- A library of standard functions may be available, again reducing the load on the programmer.

- A good module will provide ease of insertion into a program, reducing the programming load.

- Good modular programming eases debugging because the modules have definite boundaries and only certain pieces of information cross the boundaries. A programmer can be reasonably sure that if one value is being changed, another value 500 lines away is not accidentally being changed.

- Modular programming's main advantage is to *reduce the total programming time to solve a problem*—often making the difference between solving a problem on time or not solving it at all.

The main advantage of modularity is to reduce the total programming time to solve a problem.

The trouble with using a module is discovering how to make it fit in your own program. The major cause of this trouble is controlling the number of parameters that must be passed back and forth between the mainline program and its modules. I have often written my own code rather than use a module I have in my library simply because I must keep track of 12 or more parameters, half of which are not needed in my application. The heart of the trouble lies in the amount of information interchanged. The more information that passes across the module's boundary, the more the rest of the program has to handle. One, two, or three pieces of information are desirable. Twelve to twenty are not, because you have to ensure that each of these values is set properly *every* time you call the module. In addition, nearly all the in-

formation is numerical, and it's difficult to remember whether FLAG=1 means invert the matrix or solve simultaneous equations. Or is it NINV=1? Many lines of code are required to set parameters or check them each time a module is used. This can be a burden to any programmer.

In addition, the mainline program is forced to do nearly all the input, output, and decision making. Setting all the parameters for each subroutine call can mean lots of program lines. Handling input and output adds more lines. Because most mainline programs are written to solve only one problem at one time, very little of the mainline program is reused after all the effort put into it.

Introducing Extended Control Structure

A solution to this problem is *extended control structure*. This involves putting some of the input, output, and decision making in the modules or subroutines rather than in the mainline program. The input for a graphics module should be in the graphics module, the input for a root-finding module should be in that module, etc. This is seldom done in question-and-answer input, and infrequently done in menu input. However, POL input can excel at this. In part 2, I showed that nearly all the input for the root-finding module ROOTs could be placed within the module. This means that only a call to ROOTs is needed in the mainline program—just a couple of simple, standard statements. Other modules for numerical analysis and graphics are constructed in a similar manner. Now, writing code to handle the input is no longer a major concern of the programmer. Output is handled in a similar manner, thus reducing even more of the load. The programmer's only concern with output will be if text output to the printer is to be formatted in a specific manner.

All that remains for a mainline program to do is link modules together and handle decision making. Therefore, let us see how a program for doing numerical analysis can be arranged. The program in listing 1 appears short compared to ROOTs and

star[✶]war



THE LOWEST PRICES ON

star[✶]s

DOT MATRIX PRINTER

IN THE ENTIRE GALAXY*

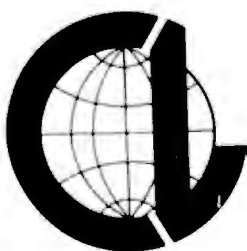

CALL: (303) 279-2848
(800) 525-7877

THE COMPUTER LINE, INC.

Golden, Colorado

*Offer void outside the Milky Way

Circle 115 on inquiry card.

Listing 1: Functioning as the mainline program, NUMRANAL will perform a numerical analysis by calling other modules to handle input, output, and decision making. Lines beginning with an asterisk (used for illustrative purposes only) can be eliminated unless those modules are used.

```

*****
3000 REM MAINLINE NUMERICAL ANALYSIS(NUMRANAL)
3010 GOSUB 1450
3020 PRINT "Type VOCABulary if you want a list of command words."
3100 FART=1
      :AART(0)="A "
      :AART(1)="AN "
      :AART(2)="THE "
      :AART(3)="IS "
      :AART(4)="ARE "
      :AART(5)="EQUALS "
      :AART(6)="EQUAL "
      :AART(7)="AND "
      :AART(8)="FOR "
      :AART(9)="OF "
      :NART=9
      :FCOM=1
      :ACOM(0)=","
      :ACOM(1)="="
      :NCOM=1
      :GOSUB 1050
3110 AM=AP
      :NLET=1
      :GOSUB 750
      :IF FLAG=1
          THEN IRET=9100
           :GOTO 100
*****
Graphics Routines Calls (standard calls)
*****
*3200 AM="DRAW"
      :NLET=4
      :GOSUB 750
      :IF FLAG=0
          GOTO 3300
*3210 GOSUB 3000
      :IF FLAG=0
          GOTO 3100
*3220 AM="CONTINUE"
      :NLET=4
      :GOSUB 750
      :IF FLAG=1
          THEN ISTART=3004
           ELSE ISTART=3002
*3230 GOSUB 9000
      :CHAIN MERGE APLT+ACDOR, ISTART, DELETE 3000-9999
*3300 AM="REDRAW"
      :NLET=4
      :GOSUB 750
      :IF FLAG=0
          GOTO 4000
*3310 GOSUB 3000
      :IF FLAG=0
          GOTO 3100
*3320 AM="CONT"
      :NLET=4
      :GOSUB 750
      :IF FLAG=1
          THEN ISTART=3004
           ELSE ISTART=3002
*3330 GOTO 3230
*3800 AM="XY "
      :NLET=3
      :GOSUB 750
      :IF FLAG=1
          THEN ACDOR="XY"
           :RETURN
*3810 AM="POLAR"
      :NLET=4
      :GOSUB 750
      :IF FLAG=1
          THEN ACDOR="POL"
           :RETURN
*3820 AM="CARTESIAN"
      :NLET=4
      :GOSUB 750
      :IF FLAG=1
          THEN ACDOR="CAR"
           :RETURN
*3990 NERR=1501
      :GOSUB 1200
      :RETURN
*****
Numerical Methods Module Calls
*****
4000 AM="ROOT"
      :NLET=4

```

the multiple-page graphics modules. Much of the program is just a series of calls to modules that can then handle the input, output, and decision making. Each of these calls is a standard sequence of statements. The call to ROOTs is in line 4000 and is in the standard format. Additional numerical methods are easily added to this mainline program. Line 4010, for example, is the entry for the CONTOur plotter module. Other planned modules for this general-purpose numerical-analysis package include numerical integration, differential equation solving, simplex optimization, and regression (curve fitting). Inserting these modules into this mainline program (or any other) can be as simple as the lines calling for ROOTs and CONTOurs.

The graphics section (lines 3200-3990) may look long and messy, but this is because it handles three different types of axes (XY, Cartesian, and polar) and three entry points for each type of axis (DRAW, REDRAW, and CONTINUE). These statements would be the same for any package that this graphics module would be added to.

The mainline program I have presented treats numerical methods in a general manner. It simply makes the different methods available in one package that includes two-dimensional graphics. It links the modules but does not provide any decision-making or information-passing capabilities; these will be added later. Such capacity is sufficient to solve the majority of problems encountered.

These modules can be easily inserted into a new POL/PS mainline program by lifting the program sections to the new mainline program (lines 3200-3990 for graphics, line 4000 for ROOTs, and line 4010 for CONTOurs). This simple method of adding capability to a program can tremendously decrease programming time and is the main part of what initially attracted me to POL input. It makes my overall job much easier.

ROOTs as a Module

I have been calling ROOTs a module, but is it really a module? ROOTs has definite boundaries; all

Listing 1 continued on page 320



WHEN AMERICAN BUSINESS HITS THE ROAD,
AMERICAN BUSINESS DECIDES ON HILTON.



Listing 1 continued:

```

:GOSUB 750
:IF FLAG=1
  THEN GOSUB 9000
  :CHAIN MERGE ADISK+"NUMRROOT",3000,DELETE 3000-9999
*4010 AM="CONTOURS"

:NLET=5
:GOSUB 750
:IF FLAG=1
  THEN GOSUB 9000
  :CHAIN MERGE ADISK+"NUMRCONT",3000,DELETE 3000-9999
8970 AM="STOP"
:NLET=4
:GOSUB 750
:IF FLAG=1
  THEN STOP
8980 GOSUB 1250          **Standard call for HELP
:IF FLAG=1             and VOCABulary (include
  GOTO 3100            in every mainline)
8990 NERR=1502
:GOSUB 1200
:GOTO 3100
*****
Standard Subroutines for Calls and Returns
*****
9000 IRET=9010
:ALET=ADISK+"NUMRANAL"
:GOSUB 1400
:RETURN
9010 GOSUB 1450
:GOTO 3100
9100 GOSUB 1480
:GOTO 3100
*****
Remember--all modules (including the mainline) must end with line number 9999
*****
9999 REM END APPLICATION PROGRAM

```

contact with the calling program has an entry point at line 3000 and a return at line 3300. All interaction with a *calling* program flows through these two points. ROOTs does just one thing—it finds the root of an equation. The level of this program is approximately that of a FORTRAN subroutine. This program (listing 2) is much bigger than the FORTRAN subroutine doing the same thing, but the entry in the calling program (see listing 1, line 4000) is much simpler than would normally be the case in FORTRAN or BASIC. The module itself is long simply because all the input and most of the output are handled inside it, and there is considerable checking of values before execution. It is important to remember that this module has to be written only once; then it can be placed in a library until the next time it is needed. Thus, the length of this module is not a burden to the person who uses it. Rather, it helps by not requiring as much effort to insert the module into a program.

Listing 2: The ROOTs program module is used to find the root of a polynomial equation.

Improving ROOTs

ROOTs has one major limitation as presented here: the equation to be solved cannot be more than 230 characters long. This limitation affects less than 10 percent of the possible applications, but solving this problem will present a second major aspect of the extended control structure.

Let us begin by examining the normal methods used to enter the equation under various types of programming. The most typical situation (used in many scientific subroutines packages) requires the programmer to write a subroutine (in BASIC) or a function (in FORTRAN) and insert it into the overall program. ROOTs can then reference this subroutine whenever a value is required. (Note all the GOSUB 9000 references in listing 4 in part 2.) This method has one major problem. In order to change the equation, the programmer must stop the execution of the program, go to an editor, modify the program, and then restart it. This process is undesirable due to the load it places on a programmer, but, unfortunately, it is the most frequently used method.

```

*****
Module ROOTs
*****
3000 REM MODULE ROOTS(NUMRROOT)
3001 REM COPYRIGHT MARK FINGER 1981
*3010 GOSUB 7100          **Stores return addresses and
                        initializes parameters
*3020 FCD=0
:FART=1
:AART(0)="A "
:AART(1)="AN "
:AART(2)="THE "
:AART(3)="IS "
:AART(4)="ARE "
:AART(5)="EQUALS "
:AART(6)="EQUAL "
:AART(7)="AND "
:AART(8)="FOR "
:AART(9)="OF "
:NART=9
3030 FCOM=1
:ACOM(0)=","
:ACOM(1)="="
:NCOM=1
*****
Matching on the highest level of the tree structure below ROOTs
*****
3200 AM="USING"
:NLET=4
:GOSUB 750
:IF FLAG=1
  GOTO 4000
3210 AM="START"
:NLET=4
:GOSUB 750
:IF FLAG=1
  GOTO 4100
3220 AM="MAXIMUM"
:NLET=4
:GOSUB 750
:IF FLAG=1
  GOTO 4200
3230 AM="EPSILON"
:NLET=4
:GOSUB 750

```

Listing 2 continued on page 323

In ROOTs, I have gone one step

Text continued on page 322

NO MATTER WHAT YOU SHIP, EMERY IS THE ONE FOR ALL.

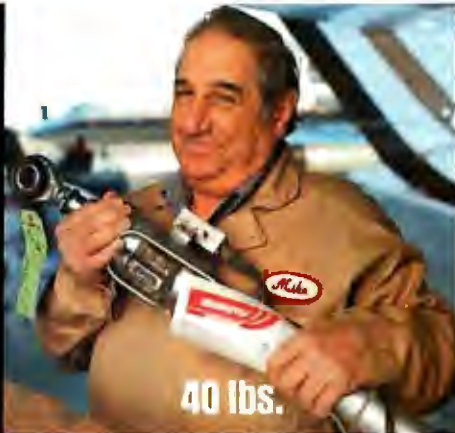

No matter what size, no matter where it's going or when it has to be there, there is one shipping company big enough to meet all your needs. Emery Worldwide offers a full range of delivery times—all without weight restrictions. One call to Emery handles it all, all over America.

EMERY FIRST FLIGHT. THE ONE YOU NEED FOR IMMEDIATE DELIVERY.

If it has to be there right away, Emery First Flight Service gets it there on the first and fastest plane available. For your most urgent shipments, there's no faster Emery service.

EMERY A.M. THE ONE YOU NEED FOR THE NEXT MORNING.

If time is of the essence, only Emery A.M. Service schedules delivery door-to-door of virtually any size, any weight shipment to most of America the next morning.

EMERY P.M. THE ONE YOU NEED FOR THE NEXT AFTERNOON.

If time is less critical, Emery P.M. Service delivers door-to-door virtually any size, any weight shipment to most of America the next business afternoon—at a savings.

EMERY DAY 2. THE ONE YOU NEED WHEN YOU HAVE MORE TIME.

If you have even more time, use Emery Day 2 Service. Your shipment arrives dependably before 5 P.M. on the second business day—at a considerable savings!

EMERY'S CONTROLLED SHIPPING SYSTEM: BUILT FOR RELIABILITY.

From the time your shipment is picked up until it's delivered on time, it's handled by well-trained Emery personnel using Emery equipment—Emery trucks, Emery planes, and our own Superhub in Dayton, Ohio. It's a system designed for total reliability.

EMERY'S DISCOUNT SYSTEM. THE ONE YOU NEED FOR IMMEDIATE SAVINGS.

The more you ship, the more you save with Emery's Multiple Shipment Discounts. And best of all, you can receive these discounts immediately, without a qualifying time period.

Ship multiple pieces to one consignee, and save even more, because Emery consolidates them on one airbill and bills you for total shipment weight, not for each piece weighed separately.

EMERY WORLDWIDE. THE ONE YOU NEED... HERE AND OVER THERE.

In addition to handling all your U.S. shipments, Emery also offers a full selection of services to meet all your international and Canadian shipping needs.

For details on all Emery services, call your local Emery Worldwide office.

EMERY WORLDWIDE

Any size. On time. For sure.



All Logical Paths Lead to
PDS DATADRIVE™ FOR YOUR APPLE II*

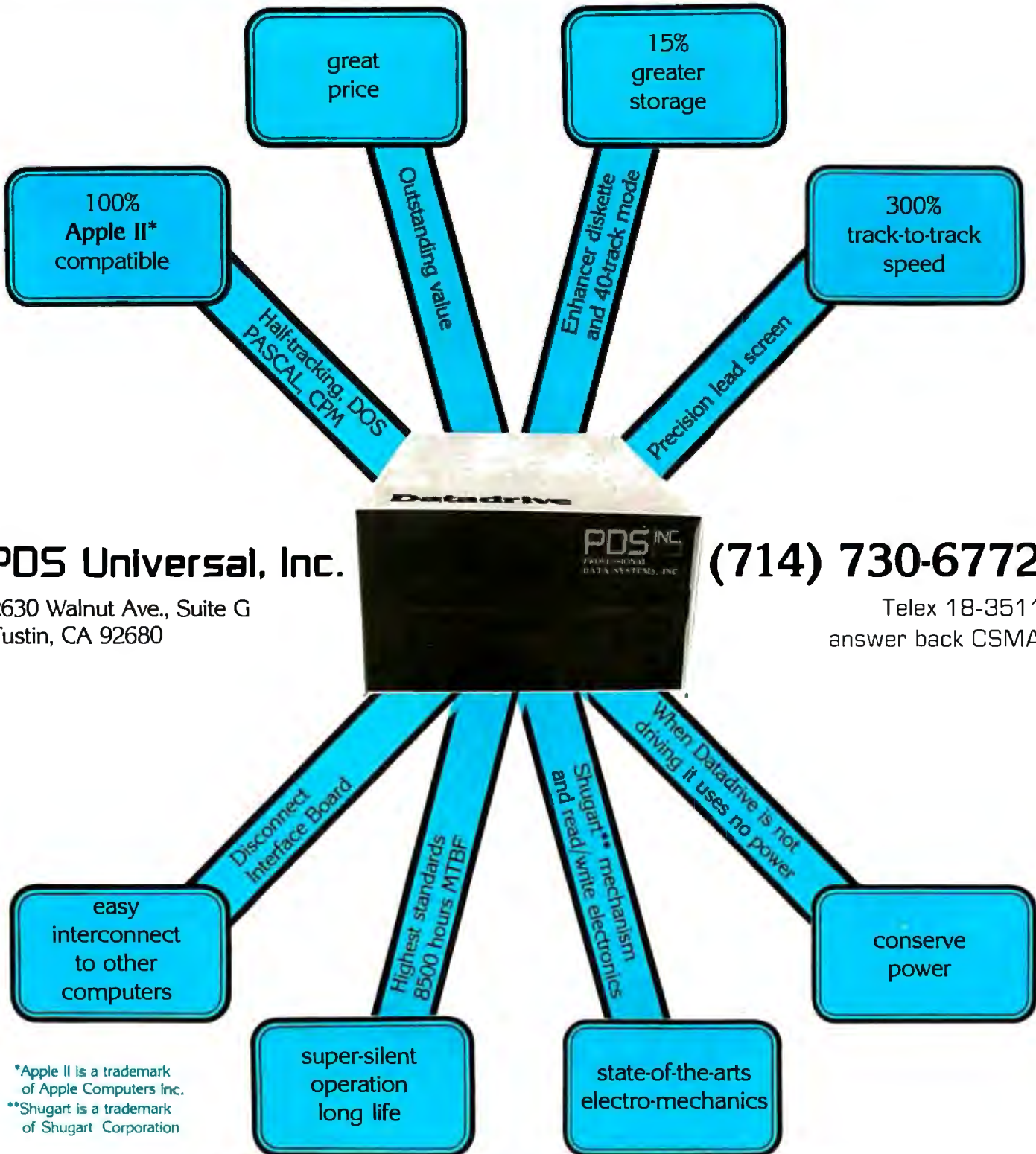

PDS Universal, Inc.

2630 Walnut Ave., Suite G
 Tustin, CA 92680

(714) 730-6772

Telex 18-3511
 answer back CSMA

*Apple II is a trademark of Apple Computers Inc.
 **Shugart is a trademark of Shugart Corporation

Available At CompuShack Stores

Listing 2 continued:

```

:IF FLAG=1
  GOTO 4300
3240 AM="VALUE"
:NLET=4
:GOSUB 750
:IF FLAG=1
  THEN FVA=0
  :GOTO 4400
3250 AM="EQUATION"
:NLET=4
:GOSUB 750
:IF FLAG=1
  GOTO 4600
3260 AM="DYDX"
:NLET=4
:GOSUB 750
:IF FLAG=1
  GOTO 4700
3270 AM="EXECUTE"
:NLET=4
:GOSUB 750
:IF FLAG=1
  GOTO 5000
3280 AM="CLEAR"
:NLET=4
:GOSUB 750
:IF FLAG=1
  GOTO 4800
3290 IF FCD=0
  THEN NERR=1521
  :GOSUB 1200
3291 IF FCD=1 AND IECC=0
  THEN NERR=1541
  :GOSUB 1200
3295 FERR=1
3300 GOSUB 7000
:CHAIN MERGE ARET, IRET, DELETE 3000-9999
*****

```

Matching for the method under USING

```

*****
4000 FCD=1
:AM="NEWTON"
:NLET=4
:GOSUB 750
:IF FLAG=1
  THEN METHOD%=1
  :GOTO 3200
4010 AM="APPROXIMATE"
:NLET=4
:GOSUB 750
:IF FLAG=1
  THEN AM="NEWTON"
  :NLET=4
  :GOSUB 750
  :METHOD%=2
  :GOTO 3200
4020 AM="SECANT"
:NLET=4
:GOSUB 750
:IF FLAG=1
  THEN METHOD%=3
  :GOTO 3200
4030 AM="INTERVAL"
:NLET=4
:GOSUB 750
:IF FLAG=1
  THEN AM="HALVING"
  :NLET=3
  :GOSUB 750
  :METHOD%=4
  :GOTO 3200
4040 AM="REGULA"
:NLET=4
:GOSUB 750
:IF FLAG=1
  THEN AM="FALSI"
  :NLET=4
  :GOSUB 750
  :METHOD%=5
  :GOTO 3200
4050 NERR=1522
:GOSUB 1200
:GOTO 3295
*****

```

Setting the number of STARTING POINTs and their values

```

*****
4100 FCD=1
:FT=1
:GOSUB 950
:IF FLAG=1
  THEN X1=DV
  :FSP=1
  :GOTO 4150

```

Listing 2 continued on page 324

Now Attractive Industrial Quality Main Frames as low as \$200

- Dual LED Display
- Shock Mounted 6 Slot Mother Boards/Card Cage
- PS-101 Power Supply
- Power & Reset Switches, A/C Filter, Fan, Etc.



SDS-S100-SL
8" Floppy Drive Enclosure/System
Special Lift Out Drive Rack
Fits all Regular and Slim-Line 8" Drives
Also Will Support 5 1/4" Hard Disk



SDS-S100-MFL
5 1/4" Floppy and/or Hard Drive
Enclosure/System



SDS-MF2 SDS-MIC
12 Slot S100 Computer Chassis or
8" Micropolis Hard Disk Cabinet



PS-101 Power Supply
This solid supply gives you the capability of running any variety of 8" floppy or 5 1/4" floppy or hard disk drives as well as power a full S100-Buss

Regulated:	Unregulated:
8V @ 8 amp	+16V @ 1 amp
+5V @ 5 amp	-16V @ 1 amp
+12V @ 5 amp	
+24V @ 5 amp	
-5 or -12V @ 1 amp	

SIERRA DATA SCIENCES
Fresno, California/
Marketing Division

21162 Lorain Road, Fairview Park, Ohio 44126
(216) 331-8500 TELEX: 980131 WDMR

See our other ad on page 29.

February 1983 © BYTE Publications Inc 323

Listing 2 continued:

```

4110 AM="POINT"
      :NLET=4
      :GOSUB 750
      :IF FLAG=1
          GOTO 4100
4120 AM="AT "
      :NLET=3
      :GOSUB 750
      :IF FLAG=1
          GOTO 4100
4140 NERR=1523
      :GOSUB 1200
      :GOTO 3300
4150 FT=1
      :GOSUB 950
      :IF FLAG=0
          GOTO 3200
4160 X2=DV
      :FSP=2
      :IF X2()X1
          GOTO 3200
4170 FSP=1
      :NERR=1524
      :GOSUB 1200
      :GOTO 3295
*****
Setting the number of MAXIMUM EVALUATIONS
*****
4200 FCD=1
      :FT=3
      :BB1=2
      :BB2=10000
      :GOSUB 850
      :IF FLAG=1
          THEN NUMEVAL=IV
              :GOTO 3200
4210 NERR=1525
      :GOSUB 1200
      :GOTO 3295
*****
Setting the value of EPSILON
*****
4300 FCD=1
      :FT=3
      :BB1=1E-20
      :BB2=10
      :GOSUB 950
      :IF FLAG=1
          THEN EPSILON=DV
              :GOTO 3200
4310 NERR=1526
      :GOSUB 1200
      :GOTO 3295
*****
Returning the value(s) of Y at the requested X('s)
*****
*4400 FCD=1
*4430 AM="AT "
      :NLET=3
      :GOSUB 750
      :FT=1
      :GOSUB 950
      :IF FLAG=1
          THEN FRUN=2
              :FLAGROOT=1
              :X=DV
              :IF FEXT=1
                  THEN GOTO 3300
                  :ELSE GOSUB 9000
*4435 PRINT "The value at ";X;" is ";Y
      :FVA=1
      :GOTO 4430
*4440 FRUN=0
      :FLAGROOT=0
      :IF FVA=1
          GOTO 3200
4450 NERR=1527
      :GOSUB 1200
      :GOTO 3295
*****
Entering the EQUATION
*****
*4600 FCD=1
      :GOSUB 800
      :IF FLAG=0
          THEN GOTO 4640
4610 AEQ="9000 " +AB+" ;RETURN"
      :FEXT=0

```

Listing 2 continued on page 326

Call today.

United States:

Arizona		
Phoenix		602/279-1010
California		
(Northern)	Mountain View	415/969-4910
	San Francisco	415/434-2410
	Walnut Creek	415/945-1910
(Southern)	Century City	213/203-8111
	Fullerton	714/871-6500
	Los Angeles	213/688-0041
	Newport Beach	714/833-1733
	San Diego	619/231-1900
	Torrance	213/540-7500
	Van Nuys	213/781-4800
Colorado		
Denver		303/571-4450
Englewood		303/773-3700
Connecticut		
Hartford		203/522-6590
Stratford		203/375-7240
District of Columbia		
Washington D.C.		202/466-5890
Florida		
Miami		305/624-3536
Georgia		
Atlanta (Downtown)		404/588-9350
Atlanta (North)		404/953-0200
Atlanta (Northeast)		404/325-8370
Illinois		
Chicago (East Loop)		312/938-4400
Chicago (West Loop)		312/782-0857
Oak Brook		312/986-0422
Rolling Meadows		312/392-0244
Indiana		
Indianapolis		317/631-2900
Kansas		
Overland Park		913/888-8885
Kentucky		
Louisville		502/581-9900
Louisiana		
New Orleans		504/561-6000
Maryland		
Baltimore		301/727-4050
Towson		301/321-7044
Massachusetts		
Boston		617/482-7613
Burlington		617/273-5160
Wellesley		617/237-3120
Michigan		
Detroit		313/259-7607
Southfield		313/352-6520
Troy		313/362-0070
Minnesota		
Minneapolis (Downtown)		612/332-6460
Minneapolis (West)		612/544-3600
Missouri		
Clayton		314/862-3800
Kansas City		816/474-3393
New Hampshire		
Nashua		603/880-4047
New Jersey		
Cherry Hill		609/482-2600
Edison		201/494-2800
Morristown		201/267-3222
Paramus		201/845-3900
Princeton		609/452-7277
New York		
New York City		
(Grand Central)		212/557-8611
(Penn Station)		212/736-7445
(Wall Street)		212/962-8000
Rochester		716/263-2670
Syosset, L.I.		516/364-0900
White Plains		914/683-9300
Ohio		
Akron		216/535-1150
Cincinnati		513/769-5080
Cleveland		216/771-2070
Columbus		614/224-0660
Dayton		513/461-4660
Oklahoma		
Tulsa		918/599-7700
Oregon		
Portland		503/223-6160
Pennsylvania		
King of Prussia		215/265-7250
Philadelphia		215/665-1717
Pittsburgh		412/261-6540
Wilkins Township		412/247-4400
Texas		
Dallas (Central)		214/954-1100
Dallas (North)		214/387-1600
Fort Worth		817/338-9300
Houston (Downtown)		713/751-0100
Houston (N. Loop West)		713/957-8555
Houston (S.W. Freeway)		713/626-8705
San Antonio		512/342-9898
Virginia		
McLean		703/790-5610
Washington		
Bellevue		206/454-6400
Wisconsin		
Milwaukee		414/277-0345
Canada:		
Ontario		
Don Mills		416/425-5730
Mississauga		416/272-3333
Toronto		416/865-1125
Québec		
Montréal		514/849-7043

Somehow, Did Your Last Raise Seem Insignificant?

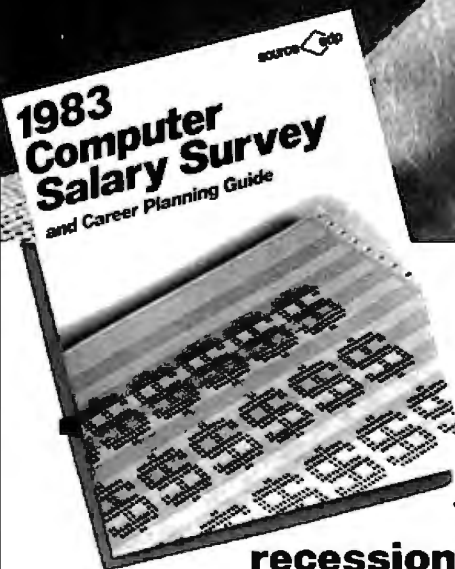

New, Free Computer Salary Survey!

Learn about compensation in the computer field, including the effects of inflation and recession, and which career paths offer the greatest compensation from a 28-page report prepared by Source Edp.

Despite past inflation and recession, demand for computer systems and the people needed to support them continues to grow.

But which professionals, with what specialized experience and skills, are really in the best positions for long term career and salary growth? And is your salary really keeping pace?

In our new Survey, you'll get answers to these questions and much more.

Compare your salary with many others.

The new Survey not only provides salary medians for 48 position categories, but it also shows "highs" and "lows" for each one as well. Figures are organized by types of professionals, including those ranging from commercial pro-

grammers to management and marketing positions; by experience level and by size of computer installation site. So you'll be able to compare your salary with those computer professionals who have similar responsibilities and skills and to learn who in computing, in what kinds of specialized disciplines, are earning the most.

No other Survey we know of is more comprehensive. It's based on contacts with more than 50,000 professionals and 25,000 organizations.

Learn about new growth areas.

Most significantly, you'll also read about which specific areas of specialization are forecasted for unusual growth in this decade and beyond. The past year saw many

changes in the economy and has altered career prospects for some professionals who were not properly prepared, so the need to stay abreast of current trends and career planning has never been so critical.

Whatever computer specialty you're in, or plan to explore—programming, software, systems design, data communications, mini/micro systems, data base, computer marketing, sales, management or others—our Survey can help you make the most of your career. You'll be able to keep up with changes in the profession, establish career goals, develop action plans, evaluate your progress, spot potential dangers, take corrective action when needed, and in general, keep your career on the best possible course for growth.

Call for your free copy.

The new *1983 Computer Salary Survey and Career Planning Guide* is available without charge. You owe it to yourself to get a copy of the report—especially if most of your career lies ahead of you.

Call today and our free 28-page Survey will be mailed to you in strict confidence, without obligation.

source edp
Personnel Services

The world's largest recruitment firm that specializes exclusively in the computer profession.

Client companies assume our charges.

Call today.

Call the office nearest you that is listed to the left. If you're unable to call, write:

Source Edp
Department B1
P.O. Box 7100
Mountain View, CA 94039

(When writing, be sure to include your title.)

Verbatim®

Floppy Discs

SAVE 40% Write for our complete list.

5 1/4" Specify soft, Price/10
10 or 16 sector

MD525 1 side/dbl dens. \$27.30
MD550 2 sides/dbl dens. 40.30
MD577 1 side/77 track. 37.10
MD557 2 sides/77 track. 47.50

8" Critically Certified
Soft sector

FD34-9000 1 side/sgl dens. 33.80
FD34-8000 1 side/dbl dens. 39.00
FD34-4001 2 side/dbl dens. 46.20

CHECKS - VISA - MC - C.O.D.
(1313) 777-7780 ADD \$2 SHIPPING

LYBEN COMPUTER SYSTEMS
27204 Harper Ave.
St. Clair Shores, MI 48081

Circle 237 on Inquiry card.

ONE BOARD CP/M® SYSTEM FOR NETWORKS

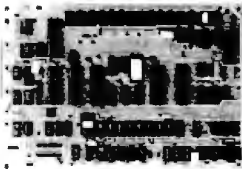

Features:

- 8 1/4 x 12 1/4 inches
- 10 MHz 8085 CPU
- 64K RAM
- 880 KBIT/SEC Network Port
- CRT Controller
- 8272 FD Controller
- Winchester Interface
- 2 RS-232 Channels

Documentation \$20
CP/M Floppy Disk Op. System \$180
Check or Money Order

autocontrol
INCORPORATED

11400 Darsett Rd.
Maryland Heights, MO 63043
(314) 789-0055

Circle 40 on Inquiry card.

SHIELDED DATA CABLES

RS 232 Cables up to 9 conductors, specify male/female ends, length & pin interconnects \$11.00 + .40/ft. IBM-PC extra heavy duty printer cables (10 ft) \$38

TERMINALS

Hazeltine	List Price	Feb. Sale Price
ESPRIT I full featured terminal w/green screen	\$595	\$499
ESPRIT II terminal w/detachable keyboard	\$645	\$565
ESPRIT III televideo 950 emulator	\$895	\$775
Televideo 910 + full featured terminal	\$699	\$569
925 terminal w/detachable keyboard	\$995	\$740
950 graphics terminal w/det. keyboard	\$1195	\$939
970 advanced graphics terminal	\$1495	\$1325

MODEMS

Novation J-CAT 0-300 baud Direct connect modem	\$149	\$129
103 SMARTCAT 0-300 baud auto ans. modem.	\$249	\$199
103/212 SMARTCAT 0-300/1200 baud	\$595	\$525
212AUTOCAT 0-300 baud/1200 baud modem.	\$695	\$565
212APPLECAT II 300/1200 baud modem and software	\$725	\$599
UDS 212LP telco powered 1200 baud modem	\$495	\$395

PRINTERS

OKI-DATA uLB2A 9 1/2" carriage 120 cps printer	\$549	\$399
uLB3A 15" carriage 120 cps printer	\$899	\$650
uLB4P 15" carriage 200 cps parallel printer	\$1395	\$999
uLB4S 15" carriage 200 cps serial printer	\$1495	\$1099

Certified check, money order or C.O.D., VISA and Mastercard add 2%. Personal checks may require 2 to 3 weeks to clear. All prices in U.S. dollars. Michigan residents add 4% sales tax. P.O. Box 1141, Mt. Clemens, Michigan 48044

ELECTROSONICS

P.O. Box 1141 • Mt. Clemens, MI 48044 • (313) 286-6969
Monday-Friday 9 a.m. - 5 p.m. est • Saturday 9 a.m. - 12 p.m.

Circle 163 on Inquiry card.

Listing 2 continued:

```

:FDX=0
4620 OPEN "0", #7, "EQUATION. BAS"
:PRINT#7, AEQ
:CLOSE#7
:CHAIN MERGE "EQUATION", 4630, ALL, DELETE 9000
4630 GOSUB 1480
:GOTO 3200
*4640 AM="EXTERNAL"
:NLET=4
:GOSUB 750
:IF FLAG=1
    THEN FEFT=1
        :FDX=0
        :GOTO 3200
*4650 NERR=1533
:GOSUB 1200
:GOTO 3295
*****
Entering the derivative of the equation
(required by Newton's method)
*****
*4700 IF FEFT=1
    THEN NERR=1539
        :GOSUB 1200
        :GOTO 3295
    :ELSE FCD=1
        :GOSUB 800
        :IF FLAG=0
            THEN NERR=1534
                :GOSUB 1200
                :GOTO 3295
4710 AEQD="9001 "+AB+":RETURN"
:FDX=1
4720 OPEN "0", #7, "EQUATION. BAS"
:PRINT#7, AEQD
:CLOSE#7
:CHAIN MERGE "EQUATION", 4630, ALL, DELETE 9001
4730 GOSUB 1480
:GOTO 3200
*****
CLEARing the parameters to default values
*****
4800 FCD=1
:METHOD%=3
:X1=0
:X2=1
:FSP=2
:NUMVAL=20
:EPSILON=.1
:AEQ="9000 Y=X:RETURN"
:AEQD="9001 YPRIME=1:RETURN"
:FDX=1
:GOTO 3200
*****
EXECUTION of root-finding
*****
*5003 FCD=1
:FRUN=1
:NEXTSTEP=0
5010 IF METHOD%(0) AND FSP(0)
    THEN NERR=1535
        :GOSUB 1200
        :GOTO 3295
5020 IF METHOD%=1 AND FDX=0
    THEN NERR=1536
        :GOSUB 1200
        :GOTO 3295
*5030 (deleted)
5050 NUM=0
*5100 ON METHOD% GOSUB 6000, 6200, 6400, 6600, 6800
*5110 Y=0
    :IF FLAGROOT=-1
        GOTO 3295
5200 IF NUM) NUMVAL
    GOTO 5400
*5210 IF FLAGROOT(0)
    THEN IF FEFT=0
        THEN IF FLAG=1
            THEN GOSUB 9000
                :GOTO 5100
            :ELSE GOSUB 9001
                :GOTO 5100
            :ELSE GOTO 3300
5220 PRINT "The root is ", XLAST
:PRINT NUM; " Evaluations were required."
*5260 FRUN=0
:GOTO 3200
*5400 PRINT "The root was not found in "; NUMVAL; " attempts."
:FLAGROOT=-1
:NERR=1540

```

Listing 2 continued on page 328

IBM memory at realistic prices:

256K WITH AN RS-232C
INTERFACE **\$349**
\$529 WITH SUPERCALC

512K WITH AN RS-232C
INTERFACE **\$579**
\$749 WITH SUPERCALC

Both of these fully-populated memory boards include parity checking and a standard RS-232C interface. They are compatible with all IBM software.

You can expect these boards to meet the highest standards of design and manufacturing quality available — at any price. We are proud to guarantee them fully for a period of two years.

**Alpha
Byte**
**COMPUTER
PRODUCTS**

31245 LA BAYA DRIVE
WESTLAKE VILLAGE, CA 91362

**To order or for
information call**

In New York:
(212) 509-1923

In Los Angeles:
(213) 706-0333

In Dallas:
(214) 744-4251

By Modem:
(213) 883-8976

We guarantee everything we sell for 30 days — no returns after 30 days. Defective software will be replaced free, but all other software returns are subject to 15% restocking fee and must be accompanied by RMA slip. No returns on game software, unless defective.

We accept VISA and MasterCard on all orders; COD orders, up to \$300.
Shipping charges: \$3 for all prepaid orders, actual shipping charges for non-prepays; \$3 for COO orders under 25lbs. (\$6 for over) plus a \$4 surcharge; add 15% for foreign, FPD and APO orders. Calif. add 6% sales tax. L.A. County add 6½%.

Prices quoted are for stock on hand and are subject to change without notice.

Listing 2 continued:

```

5410 PRINT "The last values were X =";XLAST;" and Y =";YLAST
5420 GOTO 3200
*****
Methods Subroutines
*****
*6000 IF NEXTSTEP=0                               **Newton's Method
      THEN X=X1                                   **Get first point and ask for Y
          :NEXTSTEP=1
          :FLAGROOT=1
          :RETURN
*6010 IF NEXTSTEP=1
      THEN YOTHER=Y                               **Save Y and ask for YPRIME
          :YLAST=Y
          :NEXTSTEP=2
          :FLAGROOT=2
          :RETURN
*6020 XLAST=X                                     **Compute new X value, check
      :XOTHER=X                                   if done
          :X=XLAST-YLAST/Y
          :NEXTSTEP=1
          :NUM=NUM+1
          :IF ABS(YLAST)(<=EPSILON
              THEN FLAGROOT=3                     **Done
                  :RETURN
              :ELSE FLAGROOT=1                     **Ask for new Y
                  :RETURN
*6200 IF NEXTSTEP=0                               **Approximate Newton's Method
      THEN X=X1                                   **Ask for first Y
          :FLAGROOT=1
          :NEXTSTEP=1
          :RETURN
*6210 IF NEXTSTEP=1                               **Store Y and ask for second Y
      THEN XOTHER=X
          :YOTHER=Y
          :X=X+(X2-X1)
          :NEXTSTEP=2
          :FLAGROOT=1
          :RETURN
*6220 NUM=NUM+1                                   **Compute new X
      :XLAST=X
      :YLAST=Y
      :X=X-Y/((YLAST-YOTHER)/(XLAST-XOTHER))
          :IF ABS(Y)(<=EPSILON                     **Check if done
              THEN FLAGROOT=3                     **Done
                  :RETURN
              :ELSE FLAGROOT=1                     **Ask for first new Y
                  :RETURN
*6400 IF NEXTSTEP=0                               **Secant Method
      THEN X=X1                                   **Ask for first Y
          :FLAGROOT=1
          :NEXTSTEP=1
          :RETURN
*6410 IF NEXTSTEP=1                               **Store Y and ask for second Y
      THEN YLAST=Y
          :XLAST=X
          :X=X2
          :NEXTSTEP=2
          :FLAGROOT=1
          :RETURN
*6420 NUM=NUM+1                                   **Calculate new X
      :XOTHER=XLAST
      :YOTHER=YLAST
      :XLAST=X
      :YLAST=Y
      :X=X-Y/((YOTHER-YLAST)/(XOTHER-XLAST))
          :NEXTSTEP=2
          :IF ABS(Y)(<=EPSILON                     **Check if done
              THEN FLAGROOT=3                     **Done
                  :RETURN
              :ELSE FLAGROOT=1                     **Ask for new Y
                  :RETURN
*6600 IF NEXTSTEP=0                               **Interval-Halving Method
      THEN X=X1                                   **Ask for first Y
          :FLAGROOT=1
          :NEXTSTEP=1
          :RETURN
*6610 IF NEXTSTEP=1                               **Store Y and ask for second Y
      THEN YOTHER=Y
          :XOTHER=X
          :X=X2
          :FLAGROOT=1
          :NEXTSTEP=2
          :RETURN
*6620 IF NEXTSTEP=2                               **Determine if two X values
      THEN YLAST=Y                               bracket the root
          :XLAST=X
          :IF YLAST*YOTHER)0
          THEN NERR=1538                           No, error
              :GOSUB 1200
              :FLAGROOT=-1
              :RETURN
          :ELSE X=(XLAST+XOTHER)/2                 Yes, so ask for next Y
              :FLAGROOT=1
              :NEXTSTEP=3
              :RETURN

```

CALL YOUR LOCAL DYSAN OFFICE

CA: Los Angeles
(213) 907-1803
Orange County
(714) 851-9462
Sacramento
(916) 966-8037
San Francisco/Sunnyvale
(408) 727-9552

DC: Washington
(703) 356-6441

GA: Atlanta
*(404) 952-0919

IL: Chicago
(312) 882-8176
(800) 323-5609

MA: Boston
(617) 273-5955
*(617) 229-2800

MI: Detroit
(313) 525-8240

MN: Minneapolis
*(612) 814-7199

MO: St. Louis
(314) 434-4011

NY: New York
(212) 687-7122

OH: Cleveland
(216) 333-3725

PA: Pittsburgh
(412) 261-0406
Philadelphia
(609) 939-4762

TX: Dallas/Ft. Worth
*(817) 261-5312

WA: Seattle
(206) 455-4725

*Includes OEM Sales

Dysan Diskettes are also available from all ComputerLand Stores, Sears Business Systems Centers, and many independent computer outlets nationwide.

For the location of the Dysan sales outlet nearest you, contact Dysan at: (408) 988-3472

Toll Free: (800) 538-8133
Telex: 171551 DYSAN SNTA
TWX: 910-338-2144

 **Dysan**
CORPORATION

Listing 2 continued on page 331

WHAT IS THE TRUE COST OF A DISKETTE?

If you said at least \$186.50*, you're probably close.

Confused? It's simple. The minimum cost of a one-sided, single density 8" diskette equals the purchase price plus the cost of the time to fully load the data onto the disc*. The adjacent diagram tells the story. As you can see, the purchase price of a diskette is a small fraction of the total cost of ownership. So why not pay a few cents more for the best diskette available?

That's where Dysan's quality comes in. Dysan diskettes and mini-diskettes are manufactured to the toughest quality standards in the industry. Every diskette is tested between the tracks as well as on the tracks to insure you 100% error-free recording over the entire disc surface. Dysan quality protects your investment of \$186.50.

You know how costly time and data losses can be should your "bargain" diskette be faulty. Every penny you think you save on the purchase of magnetic media could cost you dearly. Why take the risk when you can have Dysan?



dysan
Dysan
CORPORATION

Our Media Is Our Message

5201 Patrick Henry Drive
Santa Clara, CA 95050

*\$4.00 represents Dysan's suggested retail price for a one-sided, single density 8" diskette, packaged ten to a box. Minimum total cost of ownership = \$186.50

*\$182.50 represents the cost of data loading (approximately 22 hours at 11,106 keystrokes/hour at a labor cost of \$8.23/hour), based on 1981 Data Entry Management Association (DEMA) National Averages.

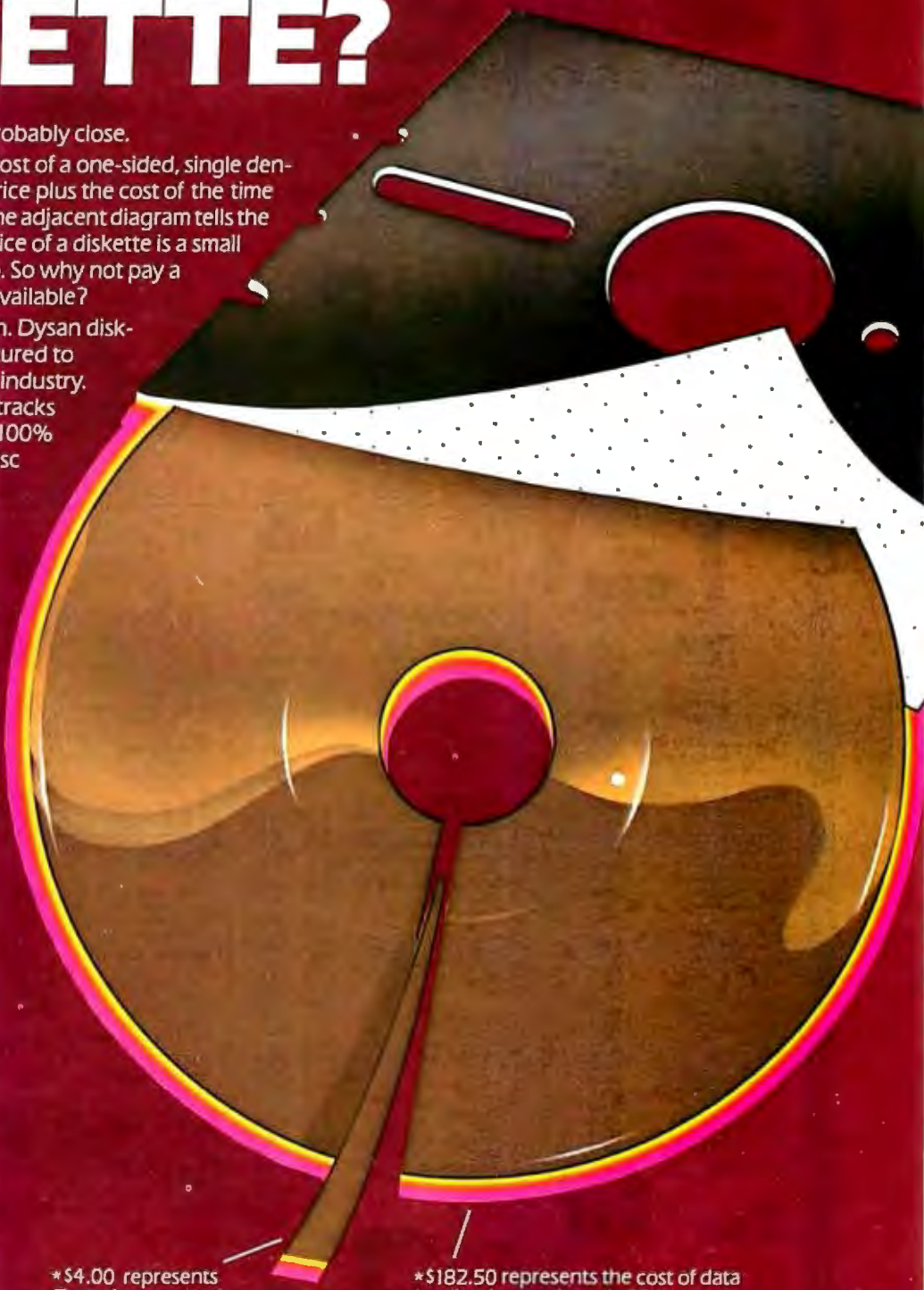

MICRO



BUSINESS WORLD INC.
Information Line (213) 996-2252
TOLL FREE MAIL ORDER LINES
(800) 423-5886 Outside Calif

LE MONITOR

9" GRN PHS MSL 189.00
12" GRN PHS MSL 189.00
OUR PRICE
88.00
Save \$101.00



METAL CABINET

118.00
Save \$70.00

SPECIAL OF THE MONTH GRAPHICS

Add a Genie in Your Computer Intelligent Printer
Interface Card
Works With
■ Integer Basic
■ Applesoft*
■ Pascal 1.0 & 1.1
■ CP/M**
OUR PRICE
\$99.00
MSL 159.00
Save 60.00



MICRO-SCI APPLE II+ COMPATIBLE DRIVE

W/ CONTROLLER MSL 549.00
OUR PRICE 429.00
W/O CONTROLLER MSL 449.00
OUR PRICE 379.00
Save COMPARE TO 216.00 APPLE DRIVE
APPLE IS A REG. TRADE MARK OF APPLE COMPUTER

IBM PERSONAL COMPUTER

INCLUDES:
2 Drives DS/DD
Color Graphic Board
64K Memory
12" BMC GRN PHS
MSL 3305.00
OUR PRICE \$2995.00
Save 410.00
*Subject to availability

APPLE II PLUS 48K
Monitor w/o Disk Drive. Not Incl.
*Subject to availability
MSL 1330.00
OUR PRICE \$995.00
Save 335.00
APPLE IS A REG. TRADEMARK OF APPLE COMPUTER

THE APPLE COMPATIBLE ALTERNATIVE FRANKLIN BUSINESS SYSTEM
Franklin Ace 1000 system • 64K • Disk Drive with controller card • 12" green phs. video monitor. Color optional \$49.00
\$1395.00
SAVE \$1000 COMPARED TO APPLE SYSTEM

OSBORNE PERSONAL COMPUTER

INCLUDES SOFTWARE
• CPM • MAIL MERGE
• WORDSTAR • CB BASIC
• SUPERCALC • M BASIC
MSL 1795.00
OUR PRICE \$1595.00
Save \$200.00

NEC STUDENT SYSTEM 64K

*NEC PC 80001
*NEC PC 8012
*NEC PC 8031
12" Grn. PHS. Video Monitor
MSL 2839.00
OUR PRICE \$2095.00
Save 744.00

RADIO SHACK TRS 80 MOD III

48K 2 DRIVE RS232
MSL 2495.00
OUR PRICE \$1733.00
Save 762.00

TPI SMITH CORONA DAISY WHEEL PRINTER

Letter Quality
OUR PRICE \$599.00
MSL 895.00
Save 296.00

APPLE ACCESSORIES

	MSL	Our Price
Vindex Combo Package	375.00	258.00
Vindex Videoterm Card	345.00	238.00
Vindex Keyboard Enhancer II	149.00	115.00
Microsoft Softcard with CP/M	345.00	235.00
Microsoft Premium Pak	685.00	468.00
Microsoft 16K Card	99.95	72.50
PCP Appl I - Card (4 MHz version)	445.00	339.00
PCP Appl I - Card (6 MHz version)	595.00	449.00
Corvus Winchester 5MB	2,495.00	1,949.00
Corvus Winchester 10MB	3,495.00	2,949.00
Corvus Winchester 20MB	4,495.00	3,899.00
Saturn Systems 32K	249.00	165.00
Saturn Systems 64K	425.00	312.00
Saturn Systems 128K	599.00	452.00
Hays Micromodem II	379.00	285.00
Hays Smartmodem	279.00	225.00
Kensington System Saver	90.00	68.00
M & R RF Modulator	30.00	22.00
M & R Super Fan	50.00	37.00
Grappler +	175.00	135.00
Practical Peripherals		
Microbuffer II 16K	259.00	225.00
Practical Peripherals		
Microbuffer II 32K	299.00	239.00
Prometheus Versa Card	199.00	149.00
SVA Disk 2 + 2 Controller DSSD	395.00	335.00
SVA Disk 2 + 2 Controller DSSD	595.00	489.00
SVA App L-Cache 256 K Memory	1,200.00	1,049.00
TG Joystick	59.95	24.00
TG Select-A-Port	59.95	24.00
Wesper Micro Wizard 80	249.00	179.00
Wesper Micro BPO 16K	179.00	139.00
Wesper Micro BPO 32K	219.00	159.00
Wesper Micro SOB 16K	249.00	189.00
Wesper Micro SOB 32K	279.00	229.00
BMC 1401 w/RGB Interface	595.00	319.00
ALS 2-Card w/CPM for Apple II	349.00	209.00

IBM PERSONAL COMPUTER PERIPHERALS & SOFTWARE

	MSL	Our Price
HARDWARE		
CORVUS Hard Disk 5MB	\$3195.00	\$2795.00
Microsoft		
64K Ram Card	399.00	369.00
128K Ram Card	599.00	475.00
256K Ram Card	995.00	777.00
64K Ram chips	195.00	155.00
Quadram		
Quad Ram 256K, 4 function brd	995.00	675.00
TG Products		
Joystick	65.00	47.00
SOFTWARE		
Automated Sim. Temple of Apshai	35.00	28.00
Cavalier Championship Blackjacks	35.00	28.00
Continental Home Accountant Plus	149.00	109.00
Denver Easy (Exec. Accounting Sys)	695.00	535.00
Infocom Deadline	35.00	27.00
Innovative T.M. III (a DBMS)	450.00	355.00
ISM Mathmagic	75.00	65.00
Info Unlimited		
Easy writer II	350.00	269.00
Phone Support of Easywriter II	350.00	260.00
Easyspeller (88K words)	150.00	119.00
Easyfiler (aDBMS)	400.00	289.00
Micro Pro Wordstar	495.00	229.00
Sorcim Superwriter	395.00	289.00
Super Calc	295.00	189.00
Visicorp Visicalc	200.00	155.00
Visicalc 2/56K	250.00	189.00
Desktop Plan I	300.00	240.00
Visi Trend/Plot	300.00	240.00
VisiDex	250.00	199.00
VersaWriter Graphics Tablet	299.00	255.00
Frogger	29.95	24.00
The Tax Manager	34.95	29.00
Galaxy	25.00	21.00
Midway Campaign	21.00	17.95
Computer Stocks and Bonds	25.00	21.00
Voyager	25.00	21.00
Draw Poker	21.00	17.95
Lost Colony	21.95	23.95

HEWLETT PACKARD

HP-11C Slim-Line Advance	135.00	119.00
HP-12C Slim-Line Financial	150.00	129.00
HP-41 CV New 2.2		
Bytes Mem	275.00	209.00
HP 15C Adv Prog Calculator	135.00	109.00
HP 16C Adv Financial Calc	150.00	119.00
Card Reader For 41C/VC	215.00	162.00
Printer For 41C/VC	385.00	289.00
Optical Wand For 41 CV/C	125.00	97.00
Quad Ram Equals		
4 Mem. Mods	95.00	81.00
HP-97 Programmable Printer	750.00	595.00
HP-67 Programmable Calculator	375.00	295.00
HP-34C Programmable Scientific	150.00	117.00
HP-38C Programmable Bus. R/E	150.00	117.00
HP-32E Adv. Scientific	55.00	48.00
HP-37E Business Mgmt.	75.00	57.00

PRINTERS

	MSL	Our Price
EPSON		
Epson MX-80 T Type III w/graphics	645.00	Call
Epson MX-80FT Type III w/graphics	745.00	Call
Epson MX-100 Type III w/graphics	995.00	Call
OKIDATA		
Okidata 82A w/wractor 80 col	649.00	457.00
Okidata 83A w/wractor 132 col	995.00	718.00
Okidata 84A 132 col. serial	1495.00	1177.00
Okidata 84A 132 col. parallel	1395.00	1019.00
C. ITOH		
C. Itoh F 10 40 cps (parallel)	1795.00	1377.00
C. Itoh F 10 40 cps (serial)	995.00	1439.00
C. Itoh Printer (parallel)	695.00	519.00
C. Itoh Printer (serial)	749.00	585.00

MONITORS

NEC		
Nec 12" Hi Res Green Monitor	210.00	165.00
Nec 12" Composite Color Monitor	449.00	345.00
SANYO		
Sanyo 9" B & W	225.00	165.00
Sanyo 9" Green Monitor	225.00	169.00
Sanyo 12" B & W	275.00	185.00
Sanyo 12" Green (New Case Style)	320.00	249.00
Sanyo 13" Color Monitor	489.00	359.00
ZENITH		
Zenith 12" Green Monitor	159.00	119.00

DRIVES

	MSL	Our Price
5 1/4" FLOPPY DISK DRIVES		
For the IBM Personal Tandem TM 100-1 48TP1	\$295.00	\$199.00
For IBM/Northstar/Cromemco Tandem TM100-2	395.00	279.00
5 1/4" WINCHESTER DRIVES		
Seagate ST 506 6.38Mb	1500.00	1179.00
Seagate ST 412 12.75Mb	1750.00	1275.00
Tandon TM 602 6.4Mb	1395.00	1079.00
Tandon TM 503 9.6Mb	1500.00	1179.00

WE RESERVE THE RIGHT TO CORRECT TYPOGRAPHICAL ERRORS. THIS AD SUPERCEDES ALL PREVIOUS ADS. PRICES SUBJECT TO CHANGE WITHOUT NOTICE.

APPLE SOFTWARE

	MSL	Our Price
Visicalc Apple Dos 3.3	\$250.00	\$180.00
Visidex	250.00	180.00
Visiplot	200.00	150.00
Visiterm	125.00	75.00
Visitrend	260.00	197.00
Visifile	250.00	180.00
Desktop Plan II	250.00	180.00
Desktop Plan III	200.00	149.00
Visipack	750.00	588.00

MONITORS

	List	Our Price
BMC		
12" Grn. PHS KQ (15 MHz)	219.00	139.00
12" Grn. PHS EQ (18 MHz)	249.00	149.00
12" Grn. PHS (20 MHz)	279.00	169.00
12" Color Composite Hi Res	439.00	289.00
NEC Grn. PHS 12"	225.00	175.00
Zenith 12"	159.00	119.00

MICRO BUSINESS WORLD MAIL ORDER WAREHOUSE
18720 Oxnard, #108
Tarzanna, CA 91356
OUTSIDE CA CALL TOLL FREE 1 (800) 423-5886 IN CA (213) 996-2252

Telex: 182852
Answer: MICKO TZNA

*California residents add 6 1/4% sales tax.
**Add 3% Shipping & Handling - Add 3% surcharge for credit cards. Order cannot be shipped unless accompanied by payment, including shipping, handling and tax where applicable.

Name (Please print) _____
Address _____
City _____ State _____ Zip _____

Qty	Make	Model	Description	Price	Total

TOTAL ORDER \$ _____
TAX IF APPLICABLE* _____
SHIPPING & HANDLING** _____
TOTAL ENCLOSED \$ _____

Certified Check or M.O. Allow 2 weeks clearance for personal check
 Bank Wire Transfer
CREDIT CARD # _____
Exp. Date _____ Signature _____

VISA **MasterCard**

Listing 2 continued:

```

*6630 IF ABS(Y)(<=EPSILON) **Check if done
      THEN FLAGROOT=3
          :YLAST=Y
          :XLAST=X
          :RETURN
*6640 NUM=NUM+1 **Check which interval the root
      :IF Y*YLAST(<=0) lies in, update X and ask for
          THEN YOTHER=Y a new Y
          :XOTHER=X
          :X=(X+XLAST)/2
          :FLAGROOT=1
          :NEXTSTEP=3
          :RETURN
*6650 YLAST=Y
      :XLAST=X
      :X=(X+XOTHER)/2
      :FLAGROOT=1
      :NEXTSTEP=3
      :RETURN
*6800 IF NEXTSTEP=0 **Regula Falsi Method
      THEN X=X1 **Ask for first Y
          :FLAGROOT=1
          :NEXTSTEP=1
          :RETURN
*6810 IF NEXTSTEP=1 **Store Y and ask for second Y
      THEN YOTHER=Y
          :XOTHER=X
          :X=X2
          :FLAGROOT=1
          :NEXTSTEP=2
          :RETURN
*6820 IF NEXTSTEP=2 **Determine if the X values
      THEN YLAST=Y bracket the root
          :XLAST=X
          :IF YLAST*YOTHER<0
              THEN NERR=1538 No, error
                  :GOSUB 1200
                  :FLAGROOT=-1
                  :RETURN
              :ELSE X=(XLAST+XOTHER)/2 Yes, ask for next Y
                  :FLAGROOT=1
                  :NEXTSTEP=3
                  :RETURN
*6830 IF ABS(Y)(<=EPSILON) **Check if done
      THEN FLAGROOT=3
          :YLAST=Y
          :XLAST=X
          :RETURN
*6840 IF NUM=NUM+1 **Check which interval the
      :IF Y*YLAST(<=0) root lies in, update X and
          THEN YOTHER=Y ask for a new Y
          :XOTHER=X
          :X=XLAST+((0-YLAST)/(YOTHER-YLAST))*(XOTHER-XLAST)
          :FLAGROOT=1
          :NEXTSTEP=3
          :RETURN
*6850 YLAST=Y
      :XLAST=X
      :X=XLAST+((0-YLAST)/(YOTHER-YLAST))*(XOTHER-XLAST)
      :FLAGROOT=1
      :NEXTSTEP=3
      :RETURN
*****
Subroutine for saving variables when leaving
*****
*7000 OPEN "D",#6,ADISK+"SAVEROOT"
      :WRITE#6,AEQ
      :WRITE#6,AEQD
      :WRITE#6,EPSILON,FCD,FDX,FSP,FVA,METHODX,NUMEVAL,X1,X2
          ,NEXTSTEP,XLAST,YLAST,XOTHER,YOTHER,FPATH,FEXT,FRUN
      :CLOSE#6
*7010 OPEN "D",#6,ADISK+"ANSWER"
      :WRITE#6,FLAGROOT,X,Y
      :CLOSE#6
*7020 GOSUB 1400
      :RETURN
*****
Subroutine for restoring variables when returning
*****
*7100 OPEN "I",#6,ADISK+"SAVEROOT"
      :INPUT#6,AEQ
      :INPUT#6,AEQD
      :INPUT#6,EPSILON,FCD,FDX,FSP,FVA,METHODX,NUMEVAL,X1,X2
          ,NEXTSTEP,XLAST,YLAST,XOTHER,YOTHER,FPATH,FEXT,FRUN
      :CLOSE#6
7110 OPEN "Q",#7,"EQUATION.BAS"
      :PRINT#7,AEQ
      :PRINT#7,AEQD
      :CLOSE#7
      :CHAIN MERGE "EQUATION",7120,ALL,DELETE 9000-9001
*7120 GOSUB 1450
      :IF FRUN<>0

```

Listing 2 continued on page 332

What makes a streetwise kid from New York want to help rice farmers in the tropics?

Meet Mike Harvey. He's not out to change the world, just to understand it a little better. And because he thinks that underneath all the differences people are basically alike, he feels he can help.

It's what today's Peace Corps is all about. Americans from every kind of background, of all ages, making a commitment to live and work with people around the world to meet basic human needs.



You won't be asked to move mountains but you'll understand what volunteers like Mike Harvey mean when they talk of small miracles. Why they want to work hard at a challenge unique to the Peace Corps.

Above all, you'll be learning something about the world, making friends with people you can help. And that's what life should be all about.

For further information, call toll free 800-424-8580. Or write Peace Corps, Washington, D.C. 20525.

Peace Corps

The toughest job you'll ever love.



A Public Service of This Magazine & The Advertising Council

Listing 2 continued:

```

      THEN OPEN "I",#6,ADISK+"ANSWER"
      :INPUT#6,FLAGROOT,X,Y
      :CLOSE#6
*7130 RETURN
*****
Equation subroutines will be inserted here
*****
9000 REM
9001 REM
*****
Remember--
  Line 9999 must be present in the module, even if only as a remark.
*****
9999 END

```

Text continued from page 320:

further and used the capabilities of Microsoft BASIC, allowing a program to modify a portion of itself (see lines 4600-4630 in listing 4 in part 2).

Both methods just presented have a hierarchical structure, as presented in figure 1. The calling program (usually the mainline program) calls ROOTs, and does not want to hear from it until the subroutine has done its job. ROOTs calls EQUATION whenever it needs a new value. This structure is straightforward and is almost the only structure taught in most programming courses.

We have seen the need, however, for a better structure to eliminate the problems cited above. This structure is presented in figure 2. In this procedure, EQUATION is a module at the same level as ROOTs, and information is passed between the two modules through the mainline program. This can be seen as a subroutine driving (or controlling) the mainline program, instead of vice versa. Such a structure gives us the capability of using ROOTs in such large programming situations as determining the rate of return on a proposed chemical plant. But a price must be paid for this flexibility through increased programming in the ROOTs module. The price is acceptable, however, if the module will be reused often in other programs.

Listings 2, 3, 4, and 5 show the revisions in the ROOTs module, reflecting the changes required to implement this increased flexibility. First, let us consider what information crosses the boundary of ROOTs. In the first version of ROOTs, given in part 2, no information was exchanged between the mainline program and ROOTs. We now need to pass three pieces of information—a value for X, a value for Y or YPRIME, and a flag (FLAGROOT) indicating what action is required by the mainline program. Remember, as ROOTs operates, it will need new values of Y and YPRIME for the new Xs. Instead of calling subroutines 9000 and 9001, we can now ask the mainline program to furnish these values. (We still have the same capability of entering an equation as before—the current presentation con-

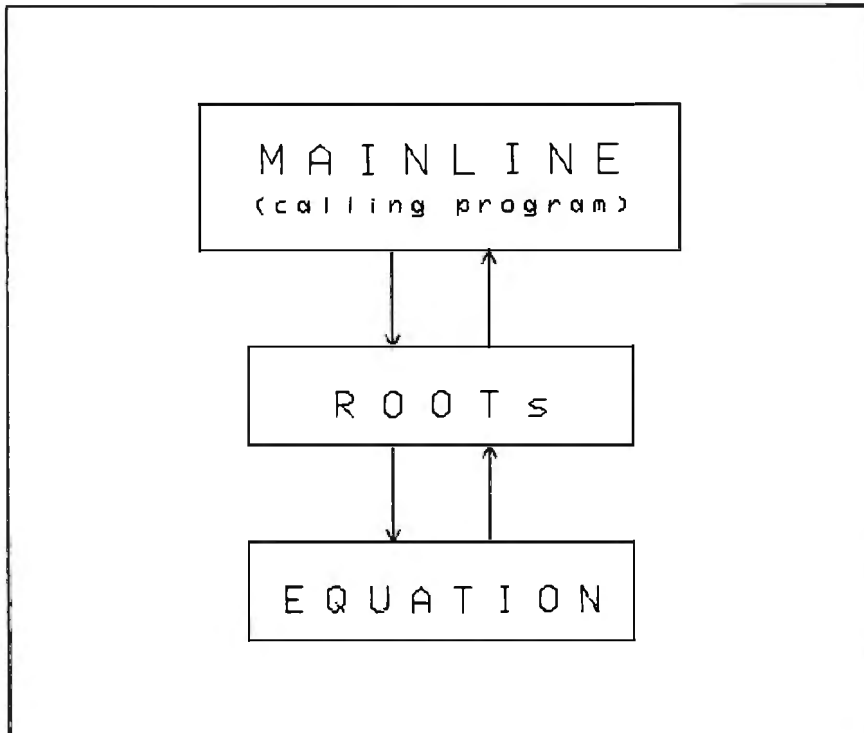

Figure 1: A typical hierarchical program structure.

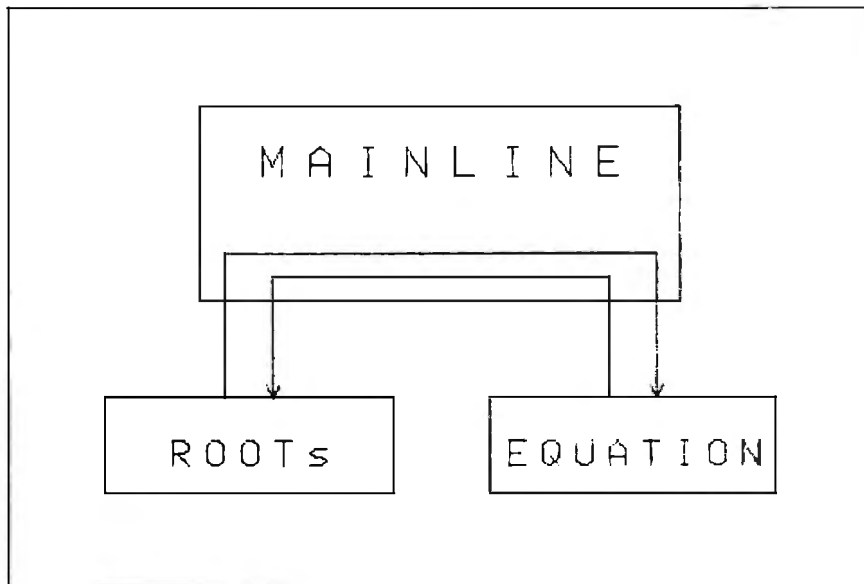

Figure 2: Interchange between modules in a program with extended control structure.

THE PRICE SLASHER!

IF YOU WANT IT - WE'VE GOT IT IF WE HAVEN'T GOT IT - WE'LL FIND IT ...

FRANKLIN ACE

- Color or Black & White
- Apple II compatible
- 512K of RAM
- Upper and lower case
- Typewriter style keyboard
- 12 key numeric pad
- Alpha lock key
- Visiatic keys
- 50 watt power supply
- Built in fan

TEXAS INSTRUMENTS ALL PRODUCTS CALL

ALTOS

8000-2 CALL

8000-12 CALL

ATARI

800 w/48K \$675.

COMMODORE

VIC-20 219

DISK DRIVES

HARD DISKS AVAILABLE CALL

RANA SYSTEMS

Elite I w/Controller \$416.

Elite II CALL

Elite III CALL

Control Card 99.

MICRO SCI

A35 w/Controller \$429.

A40 w/Controller \$466.

A70 w/Controller \$593.

PRINTERS

OKIDATA

Microline 80 \$369.

Microline 82A 469.

Microline 83A 755.

Microline 84 1144.

Microline 2410P 2599.

BROTHER

HR-1 Daisy Wheel - Parallel 889

HR-1 Daisy Wheel - Serial 969

Forms Tractor 149

STAR MICRONICS

GEMINI 10 429.

GEMINI 15 CALL

C. ITOH

Prowriter 8510 AP 499.

Starwriter F10-40PU 1549.

EPSON CALL

NEC

8023 w/Tractors \$489.

3510 1722.

3515 1765.

7710/7730 2465.

7715 2499.

7720 2699.

7725 2750.

QUME

9/45 LTD 2099.

9/45 FULL 2199.

IDS

Micro Prism CALL

Prism 132 CALL

DIABLO

630, RS-232, Daisy Wheel 1995.

630 API-Apple, IBM TRS 80 1795.

620 1299.

MANNESMANN TALLY PRINTERS

MT 160 L 879.

MONITORS & TERMINALS

USI

9" Hi Res Green \$139

12" Amber 159.

SANYO

12" Black & White 249.

12" Green Screen 265

13" Color 465

13" Color RGB 885.

ADDS

Viewpoint Green Screen 589.

Viewpoint 60 695.

HAZELTINE

Esprit 585.

Esprit II 649.

BMC USA

12" Green 95.

12" Hi Res Green 145.

14" Color Composite 329.

14" RGB Color 339.

AMDEK

12" Green 169.

13" Color I 379

Color II Hi-Res 843.

Color III RGB Color 475.

TELEVIDE

910 639.

912 745

925 825.

960 989.

NEC

JB 1260 12" Econo Green Hi Res 120.

JB 1201 12" Green Screen Hi Res 169.

JC 1201 12" Color 362.

JC 1203 12" Hi Res Color 799.

Cable for IBM PC 19.

ACCESSORIES

SORRENTO VALLEY ASSOCIATES

App-L-cache 256K Memory \$995

SSM

AS10 Apple Serial I/O Card 129

API0 Apple Parallel I/O Card 75

A10-II 164

TG PRODUCTS

Game Paddles 28

Joy Stick 44.

ORANGE MICRO

GRAPPLER PLUS 139.

MICROTEK

Apple Dumping 129.

KRAFT SYSTEMS

JOYSTICK 49.

MPC PERIPHERALS

Bubble Memory NEW 679

16K Memory Board for Apple II \$SPECIAL 63

32K Memory Board for Apple II 149.

Parallel Printer Card for Apple II 72

Upper and Lower Case ROM 19.

PROM-IT. Eprom for the Apple II 99.

Serial Input/Output Card for Apple II 119.

16/32K Expansion Memory Board 125.

M & R ENTERPRISES

SUP R TERMINAL 80 Column Video Board 316.

PRACTICAL PERIPHERALS

Microbuffer II 16K for Apple II 239.

Microbuffer II 32K for Apple II 279

8K Serial Buffer for Epson Printer 129.

16K Parallel Interface for Epson Printer 129.

MICROSOFT

Z-80 Softcard for Apple 249.

MOUNTAIN COMPUTER

CPS Multifunction for Apple 165.

The Clock for Apple 235.

Romplus 119.

Ramplus 16K for Apple 135.

Ramplus 32K for Apple 152.

Music System for Apple 319.

Rom Writer for Apple 139.

ADVANCE LOGIC

Z CARD for Apple II 225.

R.H. ELECTRONICS

ZENER RAY 72.

SUPER FAN 49.

VERSA COMPUTING

Versawriter Graphics Tablet 299.

SEATTLE COMPUTER

64K RAM + for the IBM PC 385.

128K RAM + for the IBM PC 529.

256K RAM + for the IBM PC 789.

CALIFORNIA COMPUTER SYSTEMS

Asynchronous Serial Interface 145.

VIOEX, INC.

Videoterm 279.

Softvideo Switch 29.

Inverse Chip 24.

Enhancer II 119.

SOFTWARE FOR CP/M

ASHTON-TATE

dBase II \$499.

MICROPRO

Wordstar CALL

Mailmerge CALL

Calcstar CALL

Dbasestar CALL

Supersort CALL

Spellstar CALL

MICROSTAR

FORTRAN 80 369.

Basic 80 189.

Basic Compiler 319.

mu/MATH/mu/SIMP 80 219.

Cobol 80 595.

Basic 80 299.

Edit 80 96.

X Macro 80 162.

mu/LISP/mu/STAR 80 162.

Multi Plan Also Available For Apple 205.

SELECT INFORMATION SYSTEMS

TIM III Data Base Management System 408.

SOFTWARE DIMENSIONS, INC.

Accounting Plus CALL

FOX & GELLER

Quickscreen 129.

Quickcode 225.

Crosstalk MICROSTUF 169.

Supercalc SORCIM 205.

The Word OASIS 75.

Spellbinder LEXISOFT 279.

T/Maker II LIFEBOAT 219.

Superyvz EPIC SOFTWARE 115.

Condor III CONDOR 799.

CALL FOR THIS MONTH'S SPECIALS!!

Note: Apple is a registered trademark of Apple Computer, Inc.
C/PM is a registered trademark of Digital Research.

SOFTWARE FOR IBM

SORCIM

Supercalc \$205.

SuperWriter 295.

Spellguard 229.

SELECT INFORMATION SYSTEMS

Select Word Processor W/Superspell 369.

VISICORP

Visicalc 256K Version 189.

Visitend 239.

Visidex 189.

Visifile 239.

Desktop Plan II 239.

MICROPRO

Wordstar CALL

Mailmerge **LOWEST PRICES** CALL

Spellstar CALL

INNOVATIVE SOFTWARE

TIM III Data Base Management System 408.

I.U.S.

Easyspeller 139.

Easyflair 289.

Easywriter II 269.

SOFTWARE DIMENSIONS, INC.

Accounting Plus CALL

CONTINENTAL SOFTWARE

The Home Accountant Plus 119.

DENVER SOFTWARE

EASy (Executive Accounting System) 535.

Write On DATAMOST 97.

Condor II CONDOR 449.

Crosstalk MICROSTUF 169.

MathMagic ISM 75.

The Tax Manager MICROLAB 175.

d Base II ASHTON-TATE 499.

SOFTWARE FOR APPLE

BRODERBUND

Serpentine 29.

Chopflifer 29.

MICROSOFT

Typing Tutor II \$19.

Adventure 25.

FORTRAN 80 165.

A.L.D.S. 100.

Basic Compiler 315.

mu/MATH/mu/SIMP 80 200.

Olympic Decathlon 25.

Cobol 80 595.

M/Sort 156.

TASC Compiler 145.

Softcard Premium System 599.

Time Manager 125.

SELECT INFORMATION SYSTEMS

Select Word Processor 359.

VISICORP

CCAD Data Management System 79.

Visicalc 189.

Visiterm 79.

Visiplot 159.

Visidex 189.

Visitend/Visiplot 229.

Visifile 189.

Visischedule 239.

Visipack 549.

Desktop Plan II 189.

MICROPRO

Calcstar **INPOSTAR** CALL

Datagar **REPORT STAR** CALL

Supersort CALL

Wordstar **LOWEST PRICES** CALL

Mailmerge CALL

Spellstar CALL

SORCIM

Spellguard 229.

SOUTHEASTERN SOFTWARE

Data Capture 4.0 58.

EDU-WARE CALL

Step by Step (tape) PROGRAM DESIGN 59.

Datafax LINK SYSTEMS 139.

dBase II ASHTON-TATE 175.

Supercalc SORCIM 205.

CALL FOR MORE APPLE SOFTWARE!!

MODEMS

HAYES MICROCOMPUTER PRODUCTS

Smartmodem \$229.

Smartmodem 1200 NEW 599.

Micromodem II 289.

Micromodem 100 325.

Chronograph 225.

NOVATION

CP 145.

D-Cat 175.

Auto Cat 225.

Apple Cat II 324.

Apple Cat II-212 *NEW CALL

- WE ACCEPT ● MONEY ORDER ● C O D ● CASHIERS or CERTIFIED CHECK
- PERSONAL CHECK (allow 10 days to clear) ● BANK WIRE TRANSFERS
- VISA ● MASTERCARD (add 2%)

Add 3% for shipping handling & insurance (\$5 min) Calif residents add 6% tax All equipment is new, comes with manufacturers guarantees. PLUS we guarantee it for 30 days and pay shipping charges on any returns All equipment subject to price change & availability without notice Check quantity discounts

8380 Miramar Road, Suite 200
San Diego, CA 92126

ORDERS ONLY: 800-752-1341
CALIFORNIA ORDERS: 619-578-1033
INFORMATION: 619-578-1033



Listing 3: HELP messages for ROOTs.

The ROOTs module is used to find the real roots of any equation.

The following words are always skipped over at any place in the line:

```

A
AN
THE
FOR
AND
EQUALS
EQUAL
IS
ARE
OF

```

Commas(,) and equivalence signs(=) are also skipped.

The options of ROOTs are:

```

USING method

```

where the methods are:

```

NEWTon           (Newton's method)
APPRoximate NEWTon (Approximate Newton's method)
SECAnt           (Secant Method)
INTERval HALVing (Interval Halving Method)
REGUla FALSi     (Regula Falsi Method)

```

```

STARTing (points) ##.# (##.#)

```

sets the starting points for the methods.

```

Newton's method requires 1 point.
Approximate Newton's method requires 2 points close together(4.99 & 5)
Secant Method requires 2 points.
Interval Halving and Regula Falsi require 2 points that bracket the
root between them.

```

```

MAXImum (EVALuations) ##

```

is the maximum number of evaluations before reporting failure to meet convergence requirements.

```

EPSIon ##.#

```

When ABS(Y)##.#, the root is considered to be found.

```

VALUe (at) ##.#,##.#,....

```

will give the value of the current equation at the values of X entered

```

EQUAtion:
'Y=function of X'
EXTErnal

```

If an equation is furnished, it must be in correct BASIC syntax. EXTErnal means that ROOTs will get the values it requires from the calling program.

```

DYDX 'YPRIME=function of X'

```

used to enter the derivative of X needed by Newton's Method. enter using correct BASIC syntax. If EXTErnal is the option under EQUAtion, entering a derivative will cause an error.

```

CLEAR

```

used to set values of variables to their default values equivalent to the following commands

```

USING SECAnt
STARTing 0 1
MAXImum EVALuations 20
EPSIon 0.1
EQUAtion 'Y=X'
DYDX 'YPRIME=1'

```

```

EXECute

```

causes the root to be found.

Listing 4: Variables used in the ROOTs module.

ACOPY	Temporary variable for copying files
AEQ	Internal equation containing the root to be found Default is "Y=X"

Listing 4 continued on page 339

cerns the situation where the calculations are too long for one line.) At this point, the subroutine is making all the decisions, and the mainline program's job is only as a "slave," doing *exactly* what ROOTs tells it to do.

The commands (values of FLAGROOT) returned to the mainline program are:

- 0 Program not activated. ROOTs is not actually executing in order to find the root of an equation "external" to itself. Continue with normal mainline program processing.
- 1 Furnish a value of Y to the subroutine for the given X.
- 2 Furnish a value of YPRIME to the subroutine for the given X.
- 3 Execution completed normally. The value of X is within specified limits. Continue with normal mainline processing.
- 1 Execution terminated abnormally, the result of an error. Handle the error (given in NERR) as desired.

As with most other parameter passing in the POL/PS, these parameters will be in a file (ANSWER). Note that only 3 values cross this boundary instead of a more normal 10 to 15. This is the advantage of extended control structure; because all the other values are needed only *within* ROOTs, they stay there.

Several changes are made in ROOTs to implement extended control structure. (The changed lines have an asterisk in front of them; see listing 2.) The basic changes are as follows:

- An option has been added, allowing specification of an external "equation" (see listing 2, lines 4600-4650).
- All requests for Y or YPRIME values (when executing to find a root) are now directed to a *single* point in ROOTs (line 5120). This required some significant rewriting, especially of lines 6000-7000.
- Additional internal flags (NEXT-STEP and FEXT) have been added to control the internal flow of the program.

Text continued on page 340

Lowest Prices on Personal Computers!

Apple II + 48K, Call
Apple III 126K, Call

Apple II Compatible Hardware & Software

MICROSOFT

Microsoft Softcard Premium System (Includes: Softcard, RAM Card, VideoVideoTerm 80 Col., Softswitch, Osborne CP/M® user guide)..... Only \$519
 16K RAM Card by Microsoft 145
 Z-80 Soft Card by Microsoft 275

Videx

Videx VideoTerm 80 Col. Card. \$245
 Videx Keyboard Enhancer I (Orig.) ... 75
 Videx Keyboard Enhancer II. 129

Vista COMPUTER COMPANY INC.

Vision 80 Video Display Card. \$255
 Apple III Clock/Calendar Card 159
 Obi. Dens. 8" Disc Controller. 299
 Dual 8" Disc Drives Call

Mountain Computer

CPS Multi-Function Card 169
 Music System (16 Voices)..... 299
 Expansion Chasis (8 Slots)..... 569
 Clock/Calendar Card 229
 A/D + D/A Interface 279
 Romplus + card 129
 Super Talker SO-200 149
 Keyboard Filter ROM for Romplus. 40
 Copy ROM for Romplus. 40
 Rom Writer card 149
 Rom Plus 32K RAM add-on (w/16K) ... 149

VISICORP PERSONAL MODELS

VisiCalc \$185
 VisiCalc Templates (New!) Call
 VisiFile (Data Base Management) ... 185
 VisiTrend/VisiPlot..... 199
 VisiSchedule (New) 239
 VisiTerm 89
 VisiDex 185
 Desktop Plan II 185

Computers for people™

ATARI

ATARI 400, \$249
Call for newest low price!

ATARI 800, Now w/48K! .. \$319

ATARI 410 Program Recorder..... \$79
 ATARI 810 Disk Drive 419
 ATARI 850 Interface 159
 ATARI 830 Modem 145
 ATARI 825 80 Column Printer..... 559
 ATARI Joysticks, (Pair)..... 16

ATARI Pac Man \$29.95
 ATARI Star Raiders 29.95
 ATARI Missile Command 29.95
 ATARI Asteroids 29.95
 ATARI Centipede 29.95
 ATARI Caverns of Mars 29.95

NEW LOW PRICE!

—WICO—
 Arcade Quality JOYSTICK CONTROLLERS by WICO \$24.95 ea.

—PERCOM—
 ATARI SS DD Single Disk Drive... \$639
 ATARI SS DD Dual Disk Drive.... 989

ALIEN VOICE BOX Voice Synthesizer (for ATARI & Apple), \$99

IBM

QUADBOARD by QUADRAM, Inc. Memory Expansion, Clock, Parallel Interface, R232 Int., ON ONE BOARD!
 Quadboard w/64K Installed \$495
 Quadboard w/192K Installed 719
 Quadboard w/256K Installed 728

—IBM SOFTWARE—
 WordStar by MicroPro \$299
 VisiCalc by Personal Software 185

FRANKLIN COMPUTER CORPORATION

Franklin Ace 1000 Color Pkg.

- Ace 1000 w/color
- Disk Drive w/color
- RF Modulator (for color TV), \$1499

Franklin Add-on Drive Call

—MICROSCI—
 Apple II + Compatible Drive
 Disk Drive w/Controller \$479
 Disk Drive w.o./Controller 379

—RANA/Apple—
 Elite I Disc Drive \$349
 Elite I Disc Drive w/Controller 449
 Elite II Disc Drive 549
 Elite Controller Card 99

CORVUS SYSTEMS

Corvus Winchester 5 Meg. Disk, \$2295
 Corvus Winchester 10 Meg. Disk, 2895
 Corvus Winchester 20 Meg. Disk, 3795
 Mirror Back-Up Call

HP-41C \$149
HP-41CV \$219

HP-41 Quad Memory Mod \$59
 HP-41 Ext. Func. Mem. Mod.
 HP-41 Ext. Memory Mod.
 HP-41 Time Module]

HP-41 Card Reader \$159
 HP-41 Optical Wand 99
 HP-41 Printer (82143A) 289
 HP-IL Interface Module 99
 HP-IL Printer (82162A) 379
 HP-IL Digital Cassette Drive 419
 HP-IL Video Interface Mod. 229

HP-12C
 HP-15C
 HP-16C
115

Your Choice
HP-11C, \$79 HP-10C, \$59

Advertised prices do not include shipping. Prices are subject to change and offers may be withdrawn without notice.

TEXAS INSTRUMENTS COMPUTERS

TI-99/4, \$198*
 *Net cost after \$100 Factory Rebate.

Peripheral Expansion System \$195
 RS-232 Interface Card 139
 Disk Controller Card 195
 Disk Drive 299

TEXAS INSTRUMENTS SOFTWARE

PHM-3026 Extended Basic \$74.95
 PHM-3035 Terminal Emulator II 39.00
 PHM-3055 Editor/Assembler 74.95
 PHM-3058 Mini Memory 74.95
 PHM-3013 Prntl. Rec. Keeping 39.00
 PHM-3053 TI Invaders 32.00
 PHM-3057 Munch Man 32.00
 PHM-3054 Car Wars 32.00
 PHM-3112 Pacarc 32.00

TEXAS INSTRUMENTS CALCULATORS

TI-88 Calculator \$260
 TI PC-800 Printer/Plotter 150
 TI CA-800 Cassette Interface 50
 TI-59 Calculator 169
 TI-56C Calculator 79
 TI PC-100C Printer/Plotter 149
 TI-55II Calculator 40
 TI LCD Programmer 55

AMDEK

Color I \$339
 Color II 699
 Color III 429

—MONITORS—
 BMC 12" Gr. \$99
 Sanyo 9" Gr. 159
 Sanyo 12" Gr. 209

ZENITH
 ZYM-121 Green Phos. only \$119

EPSON

MX-80 \$429
 MX-80FT 519
 MX-100 715

—PRINTERS—
SCM Smith-Corona Daisy Wheel
TP-1.. Now \$629

NEC

802Impact Dot Matrix \$489
 3510 33 CPS Serial 1749
 3530 33 CPS Centronics Par. 1749
 BI-Directional Tractor (3500) 229
 7710 55CPS Serial 2349
 7730 55 CPS Centronics Par. 2349
 Tractor for 7700 Series 229

—MODEMS—
Novation Novation Cat. ... \$139
 Novation D-Cat 149
 Novation 212 595
 Novation Apple Cat II 310

Hayes
 Micromodem II \$279
 Smartmodem 300 219
 Smartmodem 1200 549
 Chronograph 199

—CENTRONICS—
 Centronics 730-1 Parallel \$299
 Centronics 737-3 Serial 299

Commodore

Commodore VIC-20 \$189.95
 Commodore Datasetta 67.00
 Commodore Super Expander 59.00
 Commodore 8K Memory 52.00
 Commodore VIC Avenger 24.95
 Commodore VIC Super Allen. 24.95
 Commodore VIC Jupiter Lander . 24.95

—CABLES—
 Parallel Printer Cables

ATARI \$35
 Apple II 37
 IBM 40
 Osborne 37

If you are in need of something you cannot find in our ad, PLEASE CALL.

SHARP

PC-1500 Hand Held Computer \$219
 CE-150 Printer/Cass. Interface 195
 CE-152 Cassette Tape Recorder 75
 CE-155 8K RAM Memory Module 99
 CE-151 4K RAM Memory Module 50

Circle 333 on Inquiry card.

Personal Computer Systems

PCS

P.O. Box 1873
 Syracuse, N.Y. 13201

315-478-6800



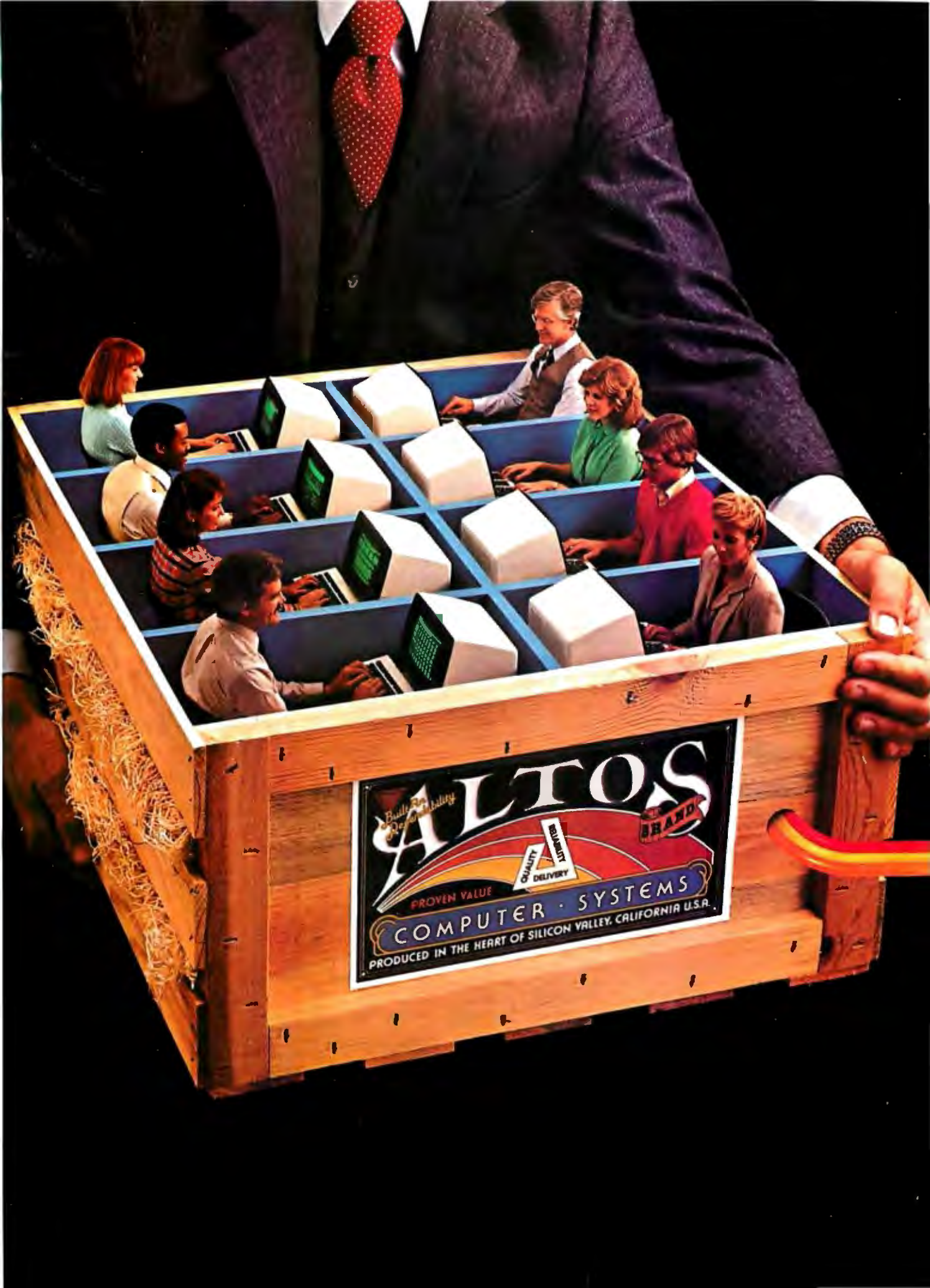

Bullseye Quality
ALTO
PROVEN VALUE
QUALITY DELIVERED
COMPUTER SYSTEMS
BRAND
PRODUCED IN THE HEART OF SILICON VALLEY, CALIFORNIA U.S.A.

1 TO 16 USERS TO GO

Altos multi-user 8086 or 68000-based networking computers are chosen by more OEMs and Fortune 1000 companies. Here's why...

ALTOS® 16-bit computer systems do more for more users. They give you more power. More features. And more reliability. For less money.

You get a choice of 8086 or 68000-based family processors, memory management to one MB of RAM, an intelligent Z80™ I/O and disk controller, plus up to 160 megabytes of fast Winchester storage.

A single Altos computer can serve up to 16 users. And every Altos 16-bit computer gives you



Altos also has high-level languages (BASIC, FORTRAN, COBOL and PASCAL), and applications software (ABS/86 and ABS/68 for general accounting, word processing and financial planning).

Since 1977, Altos has delivered more than 30,000 highly reliable, fully socketed, proven single board microcomputers and peripherals built for business.

If you've been looking to go with a more powerful computer that can serve from 1 to 16 users for less money, call or write us today.

INTER-ALTOS LOCAL NETWORK



Series 586, ACS8600 and ACS68000
20-160 MByte Winchester
1-16 USERS with
ALTOS-NET

ETHERNET



Series 586, ACS8600 and ACS68000
20-160 MByte Winchester
1-16 USERS with
ALTOS-NET/UNET™

REMOTE COMMUNICATIONS



Series 586, ACS8600 and ACS68000
20-160 MByte Winchester
1-16 USERS with
ALTOS-NET/UNET
2780/3780
3270
X.25
SNA/SDLC

added features like Multibus™ interfacing, real time clock, power fail detection and comprehensive diagnostics.

But that's just the beginning. Link multiple Altos' together and communicate in the office of the future today. Serve hundreds of users with full Ethernet™ and ALTOS-NET™ hardware and software support. And save money with fewer interconnects.

In addition, Altos supports remote communications protocols such as 2780/3780, 3270, X.25, and SNA/SDLC.

Altos has all the 16-bit software you need, too. With popular operating systems like XENIX™ / UNIX™ (with a user-friendly "business command menu interface"), CP/M-86,™ MP/M-86,™ OASIS-16, MS™ -DOS and PICK for 8086-based systems; plus UNIX System III™ and RM/COS™ for 68000-based systems.

Altos Computer Systems
2360 Bering Drive
San Jose, CA 95131
(408) 946-6700
Telex 171562 ALTOS SNJ
or 470642 ALTO UI

**Packed with
fresh ideas
for business**

ALTOS
COMPUTER SYSTEMS

800-538-7872
(In Calif. 800-662-6265)

Circle 19 on Inquiry card.

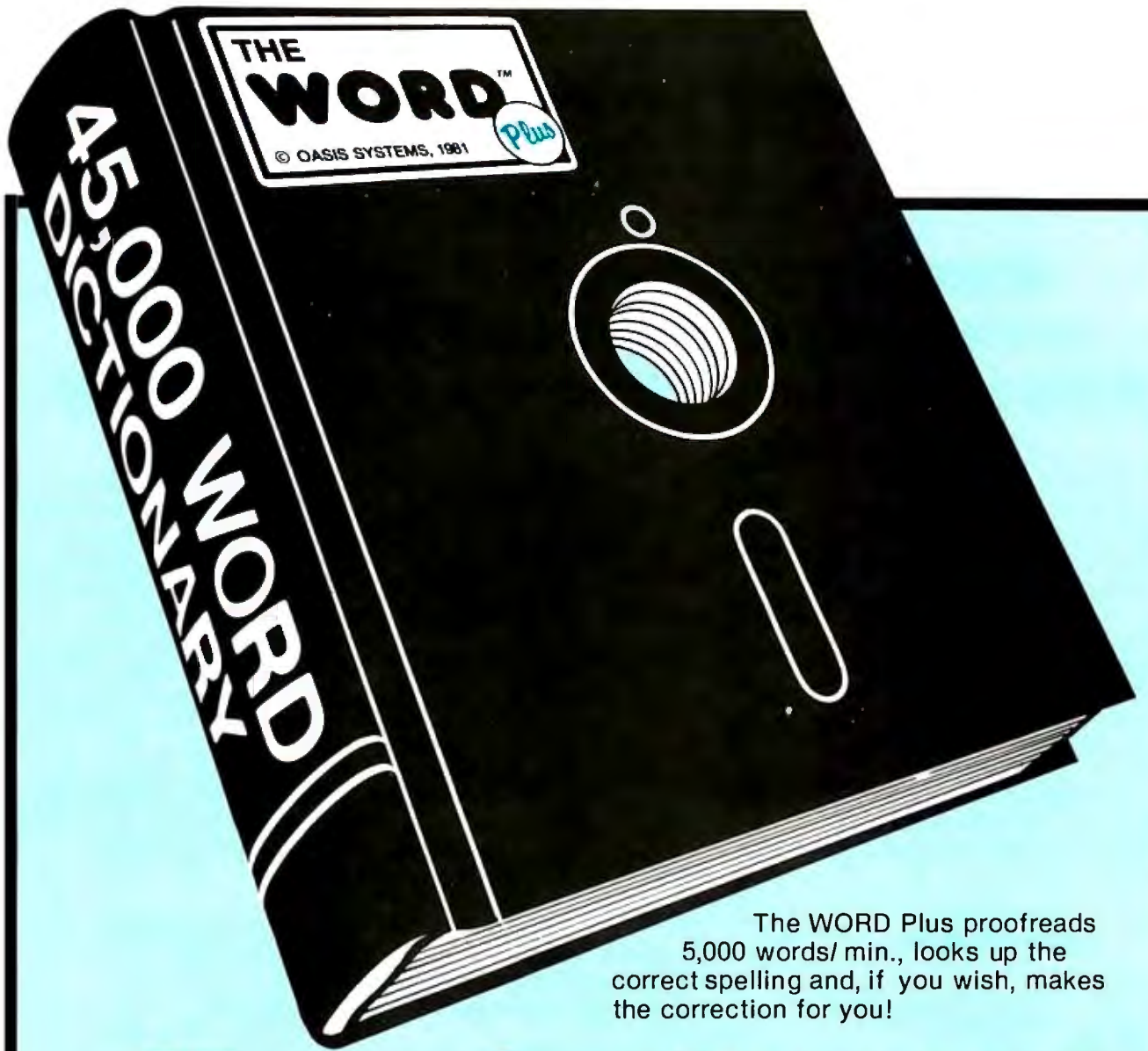

Teach Your Computer to Spell

The WORD Plus proofreads 5,000 words/min., looks up the correct spelling and, if you wish, makes the correction for you!

The WORD Plus can hyphenate files by inserting *soft hyphens* so words break precisely.

The WORD Plus counts words, solves anagrams, crosswords and rhymes!

The WORD Plus works! . . . with WordStar™, Magic Wand™, Mince™, and others.

Available for CP/M™, CP/M-86™, MSDOS (IBM P.C.) and CDOS.

The WORD Plus. \$150.
For more information call: Wayne Holder

Oasis Systems
2765 Reynard Way, San Diego, CA 92103
(714) 291-9489

Distributed by:

SOFTWARE DISTRIBUTORS

1-800-252-4024 (in California)
1-800-421-0814 (outside California)

WordStar is a trademark of Micro Pro, Int'l.
Magic Wand is a trademark of Peachtree Software, Inc.
Mince is a trademark of Mark of the Unicorn.

Listing 4 continued:

AEQD	Contains the derivative of AEQ	Default is "YPRIME=1"
EPSILON	The value for determining success of finding root--success if ABS(Y)(<=EPSILON	Default = .01
FCD	Flag for checking command syntax	
FDX	Flag for making sure a new AEQD is entered if AEQ is changed (required for Newton's Method)	
FEXT	Flag showing whether to use external (furnished by calling program) or internal values (from AED and AEQD)	0=internal 1=external
FLAGROOT	Flag to the calling program 0=program not executing 1=furnish Y for current X 2=furnish YPRIME for current X 3=normal completion of rootfinding; root is in X -1=abnormal completion; error	
FRUN	Internal flag indicating status of the module	0=normal execution 1=finding root 2=plotting equation 3=getting numerical values
FSP	Number of starting points entered	Default = 2
FVA	Flag for syntax after VALUe (AT)	
IRET1	Temporary storage of calling program return point	
METHODX	Flag for method to be used	Default=3 (Secant)
NEXTSTEP	Internal flag set by computational subroutines to indicate the next step	
NUMEVAL	Maximum number of attempts (to find root) before failure is declared	Default=20
X	Independent variable in AEQ and AEQD	
X1	Starting point 1	Default = 0
X2	Starting point 2	Default = 1
Y	Dependent variable in AEQ	
YPRIME	Dependent variable in AEQD	
XOTHER	A previous X value attempted	
YOTHER	Y value at XOTHER	
XLAST	Another previous X value attempted	
YLAST	Y value at XLAST	
XNEW	X value for next attempt	

Listing 5: Error messages for the ROOTS module.

```

1501,"Missing axes type after DRAW or REDraw"
1502,"Unexpected first entity in command"
1521,"Unexpected entity after ROOTS"
1522,"Unexpected name of method after USING"
1523,"Missing first number after START"
1524,"Both starting numbers are equal"
1525,"Expecting integer (between 2 and 10000) after MAXIMUM EVALuations"
1526,"Expecting real number ((10) after epsilon)"
1527,"Expecting a number after VALUe"
1533,"Missing string after EQUATION"
1534,"Missing string after DYDX"
1535,"Missing 2 starting values when method requires 2"
1536,"Did not redefine DYDX after changing EQUATION"
1538,"Starting points do not bracket the root"
1539,"Attempted to enter DYDX when EQUATION EXTERNAL is declared"
1540,"Root not found in maximum number of attempts"
1541,"Failed to decide remainder of line"
9999,"*****Last entry in an error list must always be Line 9999*****"

```

What
business does
a handsome dog
like me have
with a
top cat
like
you?



My name's McGruff,TM and it's my business to help prevent crime. I think it should be your business, too—to teach your employees how to protect themselves. Just send for my business kit—it'll help you develop a program that teaches your employees how to make their homes burglar-proof, make their neighborhoods safer, even how not to get mugged.

And, while you're at it, get in touch with the cops—they can help you out. So now you're probably wondering (like a top cat businessman should), what's in it for you. That's easy. When your company works harder for your people, your people work harder for your company.

So take the time, and...

**TAKE A BITE OUT OF
CRIME**

Write to McGruff, Crime Prevention Coalition,
20 Banta Place, Hackensack, NJ 07601 for
lots of information on Crime Prevention.

A message from the Crime Prevention Coalition,
this publication and The Ad Council.
©1980 The Advertising Council, Inc. **Ad Council**

Listing 6: Sample changes in a section of the NUMRANAL mainline program. This illustrates the changes required for using the extended control structure.

```

4000 AM="ROOT"
      :NLET=4
      :GOSUB 750
      :IF FLAG=0
          GOTO 4010
4001 IRET=4002
      :ARET=ADISK+"NUMRANAL"
      :GOSUB 1400
      :CHAIN MERGE ADISK+"NUMRROOT",3000,DELETE 3000-9999
4002 GOSUB 1450
      :OPEN "I",#6,ADISK+"ANSWER"
      :INPUT#6,FLAGROOT,X,Y
      :CLOSE#6
      :IF FLAGROOT=0 OR FLAGROOT=3
          GOTO 3100
4003 IF FLAGROOT () 1
      THEN GOTO 4005
      ELSE OPEN "O",#6,ADISK+"ANSWER"
          :WRITE#6,1,X,Y
          :CLOSE#6
          :IRET=4004
          :ARET=ADISK+"NUMRANAL"
          :GOSUB 1400
          :CHAIN MERGE ADISK+"NUMRECON",3000,DELETE 3000-9999
4004 GOSUB 1450
      :OPEN "I",#6,ADISK+"ANSWER"
      :INPUT#6,FLAGROOT,X,Y
      :CLOSE#6
      :OPEN "O",#6,ADISK+"ANSWER"
      :WRITE#6,FLAGROOT,X,Y
      :CLOSE#6
      :GOTO 4001
4005 IF FLAGROOT () 2
      THEN GOTO 4007
      ELSE OPEN "O",#6,ADISK+"ANSWER"
          :WRITE#6,2,X,Y
          :CLOSE#6
          :IRET=4006
          :ARET=ADISK+"NUMRANAL"
          :GOSUB 1400
          :CHAIN MERGE ADISK+"NUMRECON",3000,DELETE 3000-9999
4006 GOSUB 1450
      :OPEN "I",#6,ADISK+"ANSWER"
      :INPUT#6,FLAGROOT,X,YPRIME
      :CLOSE#6
      :OPEN "O",#6,ADISK+"ANSWER"
      :WRITE#6,FLAGROOT,X,YPRIME
      :CLOSE#6
      :GOTO 4001
4007 FERR=1
      :GOTO 3100

```

Text continued from page 334:

The relationship between the computational subroutines (lines 6000-7000) and the computational loop (lines 5100-5210) is similar to the one between ROOTs and the mainline program, with the computational subroutines actually setting the values of FLAGROOT.

The hardest part in using extended control structure is visualizing how the control is handled. The easiest way to explain this is by analogy. Imagine a typical company—the president makes all the major policy decisions. The vice-presidents make decisions on how to implement the policies of the president and so on down the chain of command. Each person further down the line has less control over decision making. This is analogous to the typical computer program—the control is concentrated at the top.

Compare this to extended control

the modules together. This is the reason the sample mainline program given in listing 1 is so much shorter than ROOTs, which is itself a small module.

The mainline program can be easily modified to pass the information between modules. Listing 6 gives an example of how this can be done using a module called ECONomics (for calculating the rate of return). These lines can quickly be rewritten to link ROOTs with any other acceptable module.

Where Do We Go From Here?

There is a problem with the present concept of extended control structure as implemented in POL/PS. All the links between modules must currently be written before the program is run and cannot be changed during the program's execution. It is desirable to be able to modify the module links interactively. To be able to define the links interactively would allow the use of modules in response to results different from the ones foreseen. One example is the fitting of a complex curve relating the energy of an object to temperature and pressure. Simple equations may be done by using a standard linear-regression package (curve fitting using the least-squares method) that will handle computations internally. More complex equations may require an optimizer and a contour plotter in order to find the desired values. Because there are several types of optimizer programs, each requiring a different module, we must be able to switch between different optimizers if the first does not do the job well enough. Being able to do that interactively means we do not have to exit the program, modify the linkages in the mainline program, and restart the program. Rather, we can simply change a few specifications from within the program.

This capability is currently being developed and tested in the GRIP program by Rick Hilst. His papers (see the references) show the growth of these concepts. The idea of extended control structure was conceived to aid in interactive linkage of modules. Because a mainline program

structure in POL/PS-type programs. It is like an engineer or administrator in a department temporarily taking control over all decisions concerning the production of product X. All the top brass are temporarily taking orders from her because she knows more about making product X than anyone else. The concept is similar to delegation of authority, and the benefits are equally great, especially in reducing the work load at the top.

I talked about the functions of a mainline program earlier. It typically handles input and output, links major modules or subroutines together, and handles decision making. In ROOTs, we have seen that most of the input and output can be handled in modules. I have just shown how much of the decision-making logic can also be placed in these modules. This leaves the mainline program with one principal function—linking

Putting It All Together

Now you can put the files on the disks in order to use them. Be sure to store all BASIC programs in unprotected ASCII format, or the CHAINs will not work. The following files are needed:

1. POL-80.BAS—remove the comments from listing 3, part 1, and put the program on disk.
2. POLERR—the error-message file for POL-80. Put listing 6, part 1 on disk, and then run the program from listing 7, part 3, placing the results in POLERR on the disk.
3. NUMRANAL.BAS—remove the comments from the program in listing 1, part 3, modify as desired (add other modules), and save it in ASCII format on the disk.
4. NUMRROOT.BAS—remove the comments from listing 2, part 3, and save it in ASCII format on the disk.
5. VOCANUMR—(VOCAbulary list) save listing 8, part 3 on the disk.
6. NUMRVOCA, NUMRHELP, NUMRROOT, NUMRSTOP—these are the help messages. Set them up as sequential files on the disk. See listings 3, 9, 10, and 11 in part 3.

Listing 7: The MAKEERR program converts sequential files containing error lists into random files required by POL-80 programs.

```

100 INPUT "SOURCE FILE FOR ERRORS";A$
200 INPUT "DESTINATION FILE FOR ERRORS";B$
300 OPEN "I",#1,A$
400 OPEN "R",#2,B$,B0
   :FIELD#2,80 AS C$
500 INPUT #1,E%,E$
600 IF E%=9999
   THEN CLOSE #1
       :CLOSE #2
       :PRINT "DONE"
       :STOP
700 LSET C$=E$
800 PUT #2,E$
900 GOTO 500

```

Listing 8: The VOCANUMR file contains the main command words for NUMRANAL.

```

"HELP"
"VOCABulary"
"ROOTs"
"CONTours"
"STOP"

```

Listing 9: NUMRVOCA file.

VOCABulary gives the list of command words for this particular module. This mainline module ignores the following words

```

A
AN
THE
FOR
IS
ARE
EQUAL
EQUALS
OF

```

It also ignores (considers as a .space) commas and the equivalence (=) sign.

7. NUMRERR—enter listing 6, part 1, and listing 5, part 3 on the disk, and then run listing 7, part 3 as many times as needed, placing the results in NUMRERR on the disk.
8. SAVEROOT—enter listing 12, part 3 on the disk as a sequential file.

The disk is now set up and ready to go. To run the program, get into BASIC and set up eight file buffers (MBASIC5 /F:8 for the Vector Graphic computer). Then load POL-80 and run the program (LOAD "POL-80",R). Bring up NUMRANAL as the current mainline program (@PRG 'B:NUMRANAL'). Now you can begin using POL commands. Try this sample: "ROOTS, USING SECANT, EQUATION = 'Y=SIN(X)', START AT .5 AND 1, EXECUTE".

Several steps are required to add a module to NUMRANAL. First, enter the module onto the disk as NUMR____.BAS (replace the underlined portion with the module name). Be sure to use the ASCII format. Next, modify NUMRANAL.BAS to access the new module and add the keyword to VOCANUMR. Then enter the HELP message as NUMR____ on the disk as a sequential file. Run MAKEERR with the error list (see listing 5, part 3 for the format of the error list). Save the output of NUMERR on the disk. Put any special module file (such as SAVEROOT for ROOTs) on disk b. Once the programs are already on a disk, the actual process takes only 5 to 10 minutes.

Listing 10: NUMRHELP file.

HELP gives formats and assistance on the command words.

The acceptable format is:

```
HELP WORD
```

WORD is one of the words listed by VOCA.
ALL may be used after help to get assistance on all of the command words.

The format to get a printout on the list device (typewriter, etc.) is:

```
HELP WORD
```

Do not use this command (HELPL) if you have a plotter hooked to the list devices or if you have begun drawing using a Diablo-type printer

Listing 11: SAVROOT file.

```

"1508 Y=X*X*X:RETURN"
"1507 YPRIME=3*X^2:RETURN"
.0001,1,0,0,0,3,100,0,1,0,0,0,0,0,0,0

```

Listing 12: NUMRSTOP file.

STOP is used to terminate NLP-80.

is effectively modified (although not actually in FORTRAN), most decision making must be done in the modules. If there is sufficient interest, some of the results of this research can be included in a module for POL-80 to do the interactive linking.

Summary

Consider the advantages of the POL/PS system that have been presented:

- The mainline program can often be much shorter and easier to write and debug than other typical programs that are not POL/PS-compatible.
- A library of technical and graphics modules can easily be built up. Extended control structure gives these modules more flexibility, yet allows easier insertion into other programs.
- Packages of programs (such as numerical analysis or statistics with graphics) can be used by a person with little programming experience, yet the packages may be more powerful than similar non-POL/PS packages.
- Plotter compatibility is planned. Adapting the graphics modules to a new plotter requires only revising about four input/output routines and changing four parameters. Most plotters are supported.
- Input using POL is faster and more powerful than question-and-answer or menu input.

Conclusion

In presenting the POL/PS series, I have tried to develop a framework for technical programs that will offer advantages not only for the programmer, but the end user as well. The concepts of a problem oriented language, modularity, and the use of mainline programs are applicable to almost any technical field. The use of POL can encourage the use of microcomputers in scientific and technical areas, much as microcomputers are used in business and word-processing applications.

I intend to support and upgrade the system and encourage others to write their own applications using the POL/PS framework presented here. The Problem Oriented Language can become the problem-solving solution for you. ■

References

1. Hilst, R. W. *Development and Use of GRIP, the Generalized Routine for Interactive Processing, in the Computer Solution of Chemical Engineering Problems*. Master's thesis, University of Kansas, August 1982.
2. Hilst, R. W. and K. A. Bishop. "Recent Advances in the Development and Use of GRIP—A Problem Oriented Language." *Summer Computer Simulation Conference*, pp. 29-35, Seattle, August 1980.
3. Hilst, R. W. and K. A. Bishop. "The Use of GRIP, a Problem Oriented Language, in Chemical Engineering Education." Presented at the 87th National AIChE Meeting, Boston, August 1979.

The following items are available from the author:

1. The POL/PS User's Manual and the ROOTs User's Manual for \$20. These manuals generally supplement but do not duplicate the material presented here. Topics include detailed rules of input, theory and examples of operation, and programming rules and hints.
2. The two manuals above and a disk containing all the appropriate files for \$30.
3. The items listed above and the graphics package (which includes the contour plotter module) for \$200. The ROOTs module in this package will have additional graphics capabilities, such as plotting the equation and graphically following the root-finder as it seeks the root.

These items will be offered on several disk formats (CP/M 8-inch, Osborne, and others as I can make arrangements). A user's group will be set up, and I will sell software written by others for the POL/PS on a royalty basis. For more information, or to order items, contact:

His Programs
c/o Mark Finger
2439 Overlook Circle
Lawrence, KS 66044

BYTE back issues for sale

	1976	1977	1978	1979	1980	1981	1982	1983
Jan.		\$2.00		\$2.75	\$3.25	\$3.25		\$3.70
Feb.			\$2.75	\$2.75	\$3.25	\$3.25	\$3.70	\$3.70
March			\$2.75	\$2.75	\$3.25	\$3.25	\$3.70	
April			\$2.75	\$2.75	\$3.25	\$3.25	\$3.70	
May		\$2.00	\$2.75	\$2.75	\$3.25	\$3.25	\$3.70	
June		\$2.00	\$2.75	\$2.75	\$3.25	\$3.25	\$3.70	

	1976	1977	1978	1979	1980	1981	1982	1983
July	\$2.00	\$2.00	\$2.75	\$2.75	\$3.25	\$3.25	\$3.70	
Aug.	\$2.00	\$2.00	\$2.75	\$2.75	\$3.25	\$3.25	\$3.70	
Sept.		\$2.75	\$2.75	\$2.75	\$3.25	\$3.25	\$3.70	
Oct.			\$2.75	\$2.75	\$3.25	\$3.25		
Nov.	\$2.00	\$2.75		\$3.25	\$3.25	\$3.25	\$3.70	
Dec.	\$2.00	\$2.75	\$2.75	\$3.25	\$3.25	\$3.25	\$3.70	

Circle and send requests with payment to:

BYTE Back Issues
P.O. Box 328
Hancock, NH 03449

Check enclosed

VISA

Master Card

Card # _____

Exp. _____

Signature _____

The above prices include postage in the US. Please add \$.50 per copy for Canada and Mexico; and \$2.00 per copy to foreign countries.

*Payments from foreign countries must be made in US funds payable at a US bank.

*Please allow 4 weeks for domestic delivery and 8 weeks for foreign delivery.

name _____

address _____

city _____ state _____ zip _____

COMPUTER WAREHOUSE

CALL TOLL FREE **1-800-528-1054**

ATARI

Special 800 System	
800 w/48K, recorder, Pac Man or Star Raiders, joysticks.....	Call
Pac-Man Special	
400 w/16K, 2 joysticks, Pac-Man	Call
800 (48K).....	\$525
400.....	Call
810 Disk Drive.....	\$440
850 Interface.....	\$170
410 Recorder.....	\$75
830 Modem.....	\$155
16K Memory.....	\$60
32K Memory.....	\$75

PRINTERS

Anadex	
9620.....	\$1445
C-Itoh	
F-10—Parallel.....	\$1350
F-10—Serial.....	\$1350
55CPS—Series.....	Call
8510 Parallel.....	\$425
Computer International	
Daisywriter 2000 w/16K.....	\$1000
Daisywriter 2000 w/48K.....	\$1025
Comrex	
CR-1-S.....	\$800
CR-1-P.....	\$775
Datasouth	
DS 180.....	\$1175
Diablo	
620 RO wo/Tractors.....	\$1100
630 RO wo/Tractors.....	\$2050
630KSR wo/Tractors.....	\$2435
IDS	
Microprism 480.....	\$525
Epson	
All models.....	Call
NEC	
PC-8023A.....	\$465
3510.....	Call
3550.....	\$1855
7710.....	\$2075
7720.....	\$2425
Okidata	
Microline 80.....	Call
Microline 82-A.....	Call
Microline 83-A.....	Call
Microline 84.....	Call
PMC	
DMP-85.....	\$410
Smith-Corona	
TP-1.....	\$650
Star Micronics	
DP-8480S.....	\$300
DP-8480P.....	\$295
Gemini-10.....	Call
Tally	
1805/1802.....	\$1490
1605/1602.....	\$1325
MT 160I.....	\$585
MT 160L.....	\$690
MT 180.....	Call
Texas Instruments	
810 Basic.....	Call

SPECIAL OF THE MONTH

Maxell Diskettes 5 1/4" 0 Sector (100) \$235

SOFTWARE

	CP/M	IBM		CP/M	IBM
Ashton-Tate	Call	Call	Sorcim Supercalc	\$225	\$225
WordStar	Call	Call	Innovative		
MailMerge	Call	Call	Software T.I.M.	\$425	\$350
SpellStar	Call	Call	CBasic	\$100	NA
Visi-Calc	NA	\$195	Microsoft Basic 80	\$265	NA
Easywriter II	NA	\$275	WordStar, MailMerge,		
Spellguard	\$225	\$225	SpellStar	Call	Call

PLEASE ADD \$5 PER SOFTWARE ORDER FOR SHIPPING

DISK DRIVES

Percom	
Atari S/D 1st Drive.....	\$400
Atari S/D 2nd Drive.....	\$300
Atari D/D 1st Drive.....	\$525
Atari D/D 2nd Drive.....	\$330
Rana (Drives for Apple)	
Elite 1.....	\$345
Elite 2.....	\$475
Elite 3.....	\$550
Controller (w/Drive only).....	\$75

MONITORS

Zenith	
12" Green Screen.....	\$115
Amdek	
Video 300.....	\$145
Color I.....	\$310
Color II.....	\$650
Color III.....	\$390
BMC	
12" Green.....	\$85
13" Color.....	\$265
Comrex	
13" Color Composite.....	\$290
13" RGB.....	\$455
NEC	
JB 1201.....	\$155
JB 1260.....	\$115
USI	
9" Amber.....	\$130
12" Amber.....	\$150

MODEMS

Hayes Smartmodem.....	\$215
Novation	
CAT.....	\$140
D-CAT.....	\$155
Signalman	
Mark I.....	\$85

VIDEO TERMINALS

Televideo	
910.....	\$570
910 Plus.....	\$570
920.....	\$735
925.....	\$730
950.....	\$915
Zenith	
Z-19.....	\$680
ZT-1.....	\$550

COMPUTERS

Altos	
ACS 8000-15.....	\$3742
Series 15D.....	\$2125
Series 5-5D.....	\$4240
Eagle.....	\$2350
NEC	
8001.....	\$730
8012.....	\$470
8031.....	\$730
Northstar	
Advantage.....	\$2800
Advantage w/5MB.....	\$3900
Horizon II 64K QD.....	\$2625
Sanyo	
MBC-1000 w/WordStar, CalcStar,	
S-Basic, CPM®.....	Call
Above w/2 Drives.....	Call
MBC-2000.....	\$2460
Televideo Systems	
TS-802.....	\$2600
TS-802H.....	\$4450
Zenith	
Z-120.....	\$3190
Z-110.....	\$3110
COMMODORE	
VIC-20.....	\$180
Datacassette.....	\$60
Single disk drive.....	\$320
16K Memory.....	\$95



2222 E. Indian School Rd.
Phoenix, Arizona 85016

Order Line: 1-800-528-1054 Other Information: 602-954-6109

Order Line Hours: Mon.-Fri. 10-5 MST Saturday 9-1 MST

Prices reflect 3% to 5% cash discount. Product shipped in factory cartons with manufacturer's warranty. Please add \$8.00 per order for shipping. Prices & availability subject to change without notice. Send cashier's check or money order...all other checks will delay shipping two weeks.

Hewlett-Packard introduces decision support for engineers. And a way to take yo

For a computer to be really personal, it's got to work the way you work. And solve your kinds of problems. Obviously, no one computer can do it all.

So we created six different series of personal computers — ranging from pocket-sized to super-powered — with an equally diverse list of features.

Today, we're introducing three new computers to the line.

So now, you can choose a computer that's not only "personal" by our definition... but by yours.

Fast answers for decision-makers.

Now, managers can get the information they need, whenever they want it. Just the way they'd like it: words, numbers or graphics. From a computer that sits on a desk... without taking it over.

It's HP's new Series 100, Model 120.

Take a good look at the Model 120. It has a special tilt-swivel base that lets you adjust the computer to your eye level. And a super-clear, easy-to-read display. It has special function keys to help guide you through the program. And something else you shouldn't overlook: HP-IB. The interface bus that allows you to hook up printers and plotters to the computer as easily as you plug the computer into your wall.

Now, take a look inside the Model 120. You'll find the software every

decision-maker needs. A powerful database management system... WordStar® word processing... and VisiCalc®, the electronic spreadsheet. But unlike some other personal computers, it takes just one keystroke to give commands — instead of two or three. That saves you a lot of time... and frustration.

The best of both worlds for scientists and engineers.

As a scientist, designer or engineer,

you've always had two choices. Big power... or personal size. Not both.

Now, you can have a computer that's powerful enough to handle design, computation and testing. And small enough to fit on your lab bench or desk — along with everything else you've got on it.

It's HP's new Series 200, Model 16.

The Model 16 has the power, memory and graphics capabilities you've asked for. (8 MHz, MC6800 microprocessor. 16/32 bit architecture.



Decision support in an executive size. The Model 120.



Support for managers. A powerful new tool for your office with you anywhere you go.

Memory expandable up to 768K bytes. 300 x 400 pixel screen resolution.)

And it also has some extra features you probably wouldn't expect. There are three languages to choose from — enhanced BASIC, compiled Pascal and HPL. And a comprehensive library of software packages to go with them. We built HP-IB and RS232 interfaces into the machine. (So you can attach peripherals or instruments without adding I/O cards.) And we even included a special rotary control knob that lets you adjust instruments or control motor speeds the same way

you'd tune in a radio station.

Portable power for the professional on the move.

If you spend as much time out of your office as in it, you'd probably like a way to take your office with you. Now you can — with HP's Series 70, Model 75. It's a powerful, battery-driven computer that fits in your briefcase.

With its typewriter-like keyboard, 16K RAM (expandable to 24K) and 48K ROM, the HP-75 acts like a full-size desktop computer. But it's just a little larger than an airline ticket folder. And it weighs only 26 ounces.

What can such a small machine do? Investment or financial analysis. Real estate. Statistics. It can manage files. Write memos. Keep track of your appointments... and let you know when it's time to go. In short, the HP-75 can do just about anything a full-size

computer can do. Except it can do it while you're sitting on a plane.

Back down on the ground, you can use the HP-75's HP-IL interface to hook up a video monitor, TV screen, printer or plotter.

You'll be glad to know that the HP-75's price tag is easy-to-take, too. The basic package comes in at under \$1,000*

The right tool for the job.

The rest of the Hewlett-Packard family of individual computers includes pocket-sized professional calculators, powerful hand-held computers, portable computers and personal office computers. Each has its own special features and focus.

For a closer look at HP's personal computers, and a copy of our 20-page book, *Choosing the Right Tool for the Job*, visit your local Hewlett-Packard sales office or authorized HP computer dealer. Call 800-547-3400 (in Alaska, Hawaii or Oregon 503-758-1010) for the location nearest you.

*U.S. list price.

The no-compromise choice for engineers and scientists.
The Model 16.



**HEWLETT
PACKARD**

Circle 196 on inquiry card.

Desktop power that fits in a briefcase.
The HP-75.



PERIPHERALS UNLIMITED

Fantastic Prices!

Our fast service, product selection and our customers' satisfaction make us #1.

NEC Printers

7710 Spinwriter R/O	\$2145
7720 Spinwriter KSR	\$2495
7730 Spinwriter R/O	\$2145
7700 Bi-directional Tractor	\$250
7700 Ribbons	\$5
3510 Spinwriter	\$1545
3515 Spinwriter	\$1699
3530 Spinwriter	\$1545
3550 Spinwriter	\$1899
3500 Bi-directional Tractor	\$225
3500 Ribbons	\$14
NEC Thimbles — All Styles	\$18

NEC Dot Matrix

PC-8023 A-C	\$474
PC-8023 Ribbons	\$14

Okidata Printers

Okidata Microline 82A	\$439
Okidata Microline 83A	\$679
Okidata Microline 84P	\$1069
Okidata Microline 84S	\$1099
Tractor (Oki 80 & 82 Only)	\$60
Okidata Okigraph	\$85

Call for prices on ribbons

Diablo Printers

Diablo 620	\$1349
Diablo 620 Bi-Directional Tractor	\$175
Diablo 630 RO	\$1999
Diablo 630 KSR	\$2700
Diablo 630 Bi-Directional Tractor	\$275
RS232 Cable	\$35

Call for prices on ribbons

NEC Monitors

NEC JB1201 GRN Phosphor	\$149
NEC JC1201 Color	\$339

Epson Printers

MX-80 w/Graphtrax Plus	\$449
MX-80FT w/Graphtrax Plus	\$529
MX-100 (15" Carriage)	\$684
Grappler Plus Interface	\$129
MX-80 Ribbons	\$12
MX-100 Ribbons	\$18

Call for prices on interfaces & cables

IDS Printers

IDS Microprism	\$539
IDS Prism 132	\$1449
IDS Prism 132 w/color	\$1659
IDS Grappler	\$129

Amdtek

Amdtek 12" 300 GRN Phosphor	\$149
Amdtek 13" Color I	\$319
Amdtek 13" Color II	\$739
Amdtek 13" Color III	\$429
Amdisk 3"	\$749

(3" Dual Microfloppy Storage for
APPLE II & IBM PC)

For service, quality and delivery

Call toll free

1-800-343-4114

Ordering information: Our order lines are open 9 A.M. to 5:30 P.M. EST Monday through Friday. Phone orders are welcome; free use of Mastercard and VISA. Personal checks require 2 weeks clearance. Manufacturer's warranty included on all equipment. Prices subject to revision. C.O.D.'s accepted. All U.P.S. shipments are subject to a shipping charge of 1% of the total purchase, with a minimum charge of \$5.00.

PERIPHERALS UNLIMITED

(617) 655-7400

62 North Main Street, Natick, MA 01760

Confessions, Pascal Prime, Wescon, and Perfect Writer

Our resident critic comments on Wescon and text editors.

Jerry Pournelle
c/o BYTE Publications
POB 372
Hancock, NH 03449

First a confession: I don't really hate Pascal. Indeed, I never did, as will become clear shortly. I have tried to keep an open mind about languages. Apparently that's not enough for some of my correspondents; just as LISP addicts don't want to hear about Pascal, Pascal lovers don't want to be told that anyone might consider CB-80—a form of *BASIC* for God's sake!—to be in competition with their beloved.

Nor, apparently, are they willing to believe there may be defects in the language. Sigh. But there are, and in a later section we'll look at something practical that can be done about them.

Second, a problem: BYTE has a long pipeline. I'm writing this in late September, for publication in the February issue. Much of the mail I've received (bundles and bundles of it; ye gods!) is in response to the September issue. But when you read this, most of you will have seen the October, November, December, and January columns and have totally forgotten about the issues raised in September: which is why I must ignore much of my mail. I haven't time to answer very many individual let-

ters (John Carr does some, but he hasn't a lot more time than I do), and, given the pipeline, many of the questions asked will be moot before an answer can appear in *BYTE*.

E'en so, there's much of importance in my unanswered mail file; later on, I'll deal with some of that.

The *BYTE* pipeline is longer than I like; but there is a bright side. About two months before the magazine comes out, I get galley proofs of my articles; and provided that I'm not *too* wordy, I can insert a couple of last-minute announcements, letting these columns stay reasonably up to date. It's not an ideal system, but it's about the best we're going to get.

Zeke Lives!

Mark Twain had the extraordinary experience of reading his own obituary, after which he said, "The reports of my death are greatly exaggerated."

Fortunately, Ezekial, my friend who happens to be an ancient Cromemco Z-2, can say the same. After his trip to Tony Pietsch's place, he returned nearly as good as new.

Nearly: a faulty cable managed to short out an input/output board,

which in turn rendered one of his bus slots inoperable; and we do have an annoying problem with the B disk drive. Tony says the disk problem could probably be fixed by lowering the entire drive system into a vat of TCE (a dry-cleaning solvent) and agitating it for a couple of hours; in the absence of that, we just live with "Please Close Drive Door" the first few times we try to access the B drive. The problem goes away after a few minutes' warm-up.

Update: last night Zeke died again, clobbering all his disks as he did. Today, in despair, I took apart the old iCOM disk system. Lo! I found that there's a bad cable that conveys the 5-volt power; this causes all kinds of weird results, including write operations when the computer is supposed to be reading. Tony Pietsch thinks this is fixable, and thank heaven! I'm just now writing this on the Televideo 950 terminal, and that misplaced Delete key, plus the obscene Back Tab key, will soon drive me out of my mind.

I mention Zeke's revival in part because my mail indicates considerable interest in his health, but in fact there's an illustrative lesson here.

This ancient machine—he was built some five years ago—is still plenty good enough for me to write this article with. When I first got Zeke, we had dying chip problems and a mysterious gremlin that required exorcism; but after the first couple of months, there just weren't any problems at all. Even now, the central machine is in good shape; all our recent problems have been caused by faulty cables.

This seems to be typical: once past the first few months, you shouldn't have any problems for several years. Then, all at once, like the wonderful one-horse shay, everything may collapse. Actually, the electronics could last for decades; it's mechanical stuff—disk drives, switches, fans, cables, connectors, etc.—that goes.

The problem is that five years isn't long in the life cycle of a typewriter; but it's an eternity for a microcomputer. By the time you need repairs on your ancient equipment, the manufacturer will no longer be making it, and it's likely that none of the

technicians will ever have heard of it. This may change when machines begin to sell in hundreds of thousands per model; but just now it seems true enough.

I've no regrets. I've got a lot out of old Zeke, and he may yet last another couple of years; but computer purchasers should be warned: things are moving very fast, and that has consequences.

Meanwhile, I know of only one way to avoid the early (infant mortality) glitches, and that's to buy "used" equipment; that is, either stuff that's been burned in a lot, like Compro's rather expensive CSC grade, or literally used equipment, if you can find someone reliable to buy it from. (One outfit sends out evaluation hardware with the understanding that they'll swap every month or so: that way they get back a thoroughly tested machine.)

The Pascal Prime Project

As I've mentioned before, one of our major projects was Alex's Pascal

Intro. It was intended to be a simple little job, but it ended up taking most of the summer. It also had interesting fallout: in order to test it, I had to write a couple of fairly hairy programs in Pascal. One, a game called Imperial Trader, got out of hand, but eventually I finished it. While writing it, I learned more about Pascal than I'd intended to.

Conclusions first: once you get the hang of it, there's a lot to like about Pascal. My game, for instance, darned near wrote itself once I dreamed up the structure for keeping track of all the important game entities, such as players, planets, products including arms and drugs, prices of products on each planet, police and customs officers, etc. Pascal lets you define your own variable types; in particular, you can define *records* that let you put about 20 different items—some strings, some integers, some real numbers, and some arrays of other stuff—all in one variable. Thus, it's a cinch to get at all the vital data you want: read it, update it, play with it . . .

The best BASIC in the world can't do that. BASIC requires you to have a bunch of arrays, and you can't mix string, character, integer, real, and Boolean variables in the same array—much less can you have an array that contains subarrays the way Pascal records can.

I probably ought to quote Marvin Minsky (MIT computer expert) here: Marvin says that Pascal sacrifices programmer options in order to force programmers to write readable code. He's right, too; the question is whether the gain is worth the cost. I think so. Marvin doesn't.

Of course, Minsky is primarily interested in artificial intelligence, in particular in programs that modify themselves (and thereby are *intentionally* unpredictable in their results), while this column is mostly directed to people who want to use their computers to accomplish some definable result. For AI and hefty experiments in computer science, you need to learn a list-processing language, which in practice means LISP or a derivative; but for getting today's work done, I'm coming to the

HIS CONTRIBUTIONS WERE MAD AS POSSIBLE BY YOURS.

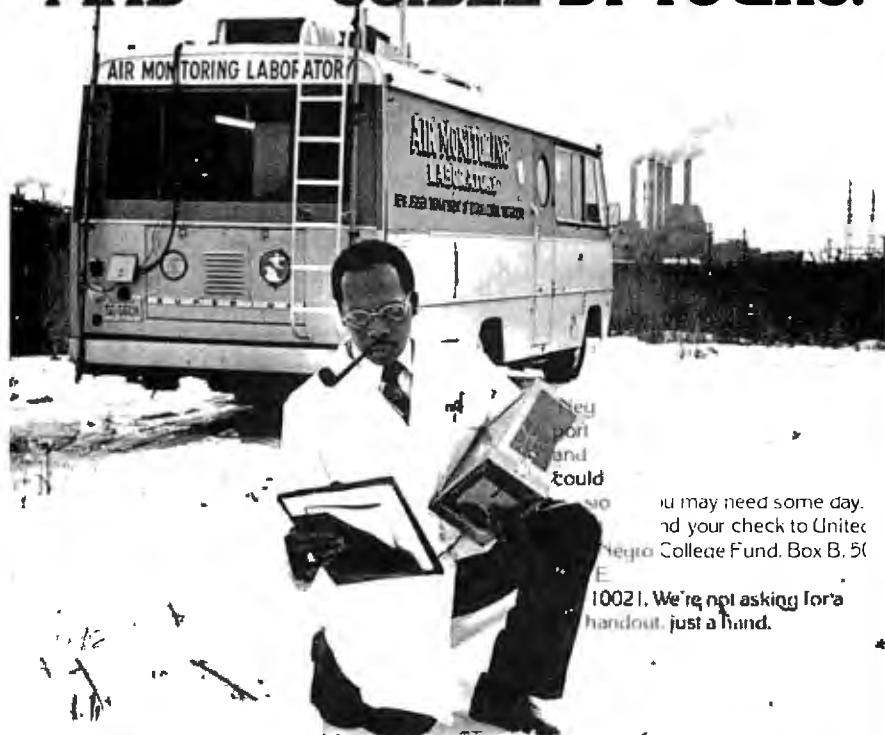

No one can do it alone.

GIVE TO THE UNITED NEGRO COLLEGE FUND.

A mind is a terrible thing to waste.

A public service of this magazine and The Advertising Council.



AMIX

Real-Time Multitasking Executive

for
8080, Z80
and 6809

Gives your application a head start

AMX can save you time and money. You can capitalize on our years of multitasking experience. Start your application using a software executive proven with three years of fault-free operation.

Professional software designers use AMX as the starting point for their product and system designs. AMX shields them from the difficulties of managing the micro, freeing them to concentrate on their application.

SIMPLE OPERATION

Complex control programs are divided into a number of separate, more manageable programs, called *tasks*, each designed to do one job. Tasks are written and tested separately and then combined to form a reliable, finished system.

AMX supervises the orderly execution of these tasks, assuring that the most important jobs always get done first. Tasks appear to be executing simultaneously. It's almost like having a separate CPU for each task!

HARDWARE INDEPENDENCE

AMX does not require a particular hardware configuration. *You* control

your environment. *You* pick the I/O method. *You* decide the preferred interrupt service technique for your system. AMX will support your choice.

AMX is fast, compact, and ROMable. Even though the AMX nucleus is less than 1400 bytes in size, it features multiple task priorities, intertask message passing with priority queuing, external event synchronization, and interval timing.

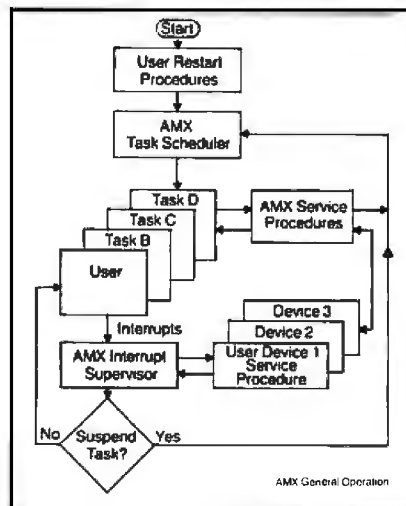

CP/M is a trademark of Digital Research Corp.
Z80 is a trademark of Zilog Corp.

Interface modules are available to allow AMX to be used with C, PASCAL, PL/M, FORTRAN and assembler.

Access to CP/M® disk files in real time is possible using the AMX I/O Supervisor.

COMPLETE DOCUMENTATION

AMX can be judged by the quality of our documentation.

We deliver AMX source on diskette to permit AMX to be moved to the software development system of your choice. Our liberal license agreement permits binary (object) distribution without royalties.

HOW TO ORDER

A specification sheet and price list are available, free. Your check or money order for \$75 will purchase the AMX Reference Manual for immediate evaluation (specify 8080, 8085, Z80 or 6809 processor). Add \$25 for postage and handling outside USA and Canada. The standard AMX Multitasking Executive package, including source code, is \$800.

AMX is the choice of professionals the world over. Make it yours, today.



KADAK Products Ltd.



206-1847 W. Broadway Ave., Vancouver, B.C., Canada V6J 1Y5 Phone: (604) 734-2796 Telex: 04-55670

conclusion that Pascal is my first choice.

However: for all its attractive features, Pascal has some very severe limits. I've discussed many of these before. The I/O system doesn't make sense, and Pascal thinks that the ideal file is a reel of magnetic tape; it has no provision for the kind of random access you can do with disks.

Some of Pascal's worst theoretical limitations have been overcome in practice, as compiler writers tuck in

various nonstandard extensions. The problem with that is we're getting many dialects of Pascal, which severely limits our ability to transfer programs from one machine to another.

Fortunately, though, it isn't hard to overcome many of those limits. Compiler writers tell me they can continue to extend Pascal with little difficulty. The problem is to come up with a "standard" set of extensions, so that programs will remain more or less

portable: and that brings us to Project Pascal Prime.

I've put together some extensions that look interesting; added to "standard" Pascal they create Pascal Prime, a user-oriented language. There will be a discussion of Pascal Prime during the West Coast Computer Faire; as a default case I'll be chairman, although I'm willing to hand that over to anyone better qualified who wants the job. Mostly, I want to bring together people interested in microcomputer Pascal and have a serious discussion of a "standard" extension package.

The meeting has already drawn promises of attendance from several of the major publishers of microcomputer Pascal compilers; if just those who say they're coming can agree, we'll have Pascal Prime de facto.

Candidate Pascal Prime Features

For those uninterested in Pascal, my apologies if the following gets more technical than you've come to expect from me; I wouldn't do it if I didn't think it important.

The first criterion for Pascal Prime is that we don't do *much*. One of Pascal's best points is that it isn't a complex language. We do *not* want to end up with something like the Department of Defense's new language, Ada. Ada was designed by a committee, and it shows; it has hundreds of "features," some absolutely obscure. Pascal Prime will, we hope, stay within the spirit of the original language.

Second, we want programs written in previous Pascals to compile under Prime.

Third, Prime is intended for microcomputers; but we'd like Prime programs to compile on larger systems. Changes will be needed, but we want to keep them to a minimum.

Here are some candidate extensions; discussion is invited.

1. STRING and LONG STRING data types. Most Pascal implementations have type STRING, which stores the string length as the first byte (BYTE 0). This can become standard (certainly type STRING is vital), but this method of implementation limits string lengths to 255 characters

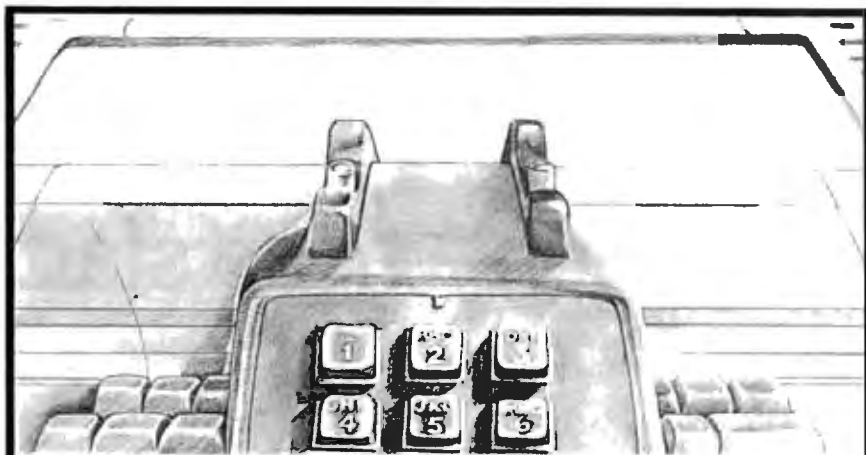

TELEPHONE VOICE RESPONSE

The V100 Telephone Voice Response Unit with telephone interface is an Apple II® or IBM Personal Computer® compatible, low-cost solution to remote data base access arrangements.

\$395⁰⁰
V100-A

- Direct telephone connection, auto-dial/answer
- Touch-tone® generation and detection
- Includes 300 word, LPC vocabulary
- Software for sentence/library construction
- Expandable with 1300 (\$495) high quality LPC words

NEW!

Digital Data Communications for the V100 with our new 300 baud modem upgrade, \$149

Text-to-Speech package available soon!

For a voice demonstration call toll free (800) 538-7002
In California call (408) 942-1595

VYNET CORPORATION

160B Albright Wy.
Los Gatos, CA 95030 (408) 370-0555

DISC-LESS \$1050

Sonics Micro Systems announces the commercial availability of S.D. Systems' . . .

First "Disc-Less" Micro Computer System. \$1050

1. Replaces Floppy Disc Drives.
2. CP/M, MP/M, Oasis and Turbo-Dos compatible.
3. Transparent to operating system disc commands.
4. No moving parts, no alignment, no media failures.
5. Network ready.
6. FAST!!!!!!!!!!!!!!!!!!!!

"Ram-Disc" \$630

- Operating under CP/M the "Ram-Disc 128" functions as a fully compatible floppy drive replacement. Maximum single board configuration of 256K Bytes offers the equivalent capacity of 8" floppies. If more local disc image storage is necessary the Ramdisc system may be expanded to a full 40M Bytes.
- Whether operations require the "Ram-Disc 128" to operate as a floppy replacement or as a high speed data acquisition system is

solely dependent on single system configuration.

- In real time data acquisition and subsequent processing applications the "Disc-less" system approach affords mini computer speed and versatility at micro computer prices.

"Rom-Disc" \$289

- The "Rom-Disc-128" is a direct replacement for floppy disc drives used for the purpose of booting the CP/M operating system. Further the "Rom-Disc-128" is a direct replacement for floppy disc drives used to load and store applications programs.
- A total lack of sensitivity to the storage and handling parameters of standard floppy discs make the "Rom-Disc-128's" media virtually "immune" to familiar system failures.
- Under popular CP/M utilities the "Rom-Disc-128" appears as a simple disc drive.
- With CP/M configured in the S.D. Rom format, systems boot in less than 1/10 of a second.
- Equipped with a high speed RS-232 serial port the "Rom-Disc-128" will accommodate

data transfer to and from the host.

- The "Rom-Disc-128" in conjunction with the previously described "Ram-Disc-128" provide true system portability and independence from floppy disc drives.

- Each "Rom-Disc-128" may be attached to a 256K Byte applications "personality module" allowing maximum system flexibility and personality. "Rom-Disc-128" because of its very nature offers "maximum" protection from software piracy.

"Turbo-Dos" \$350

Z-80 CP/M compatible network ready Turbo-Dos in stock, ready for immediate delivery.

Versa Floppy II "With CP/M 3-0" \$475

- Supports dual 5¼", dual 8" or both. "CP/M 3-0" included.

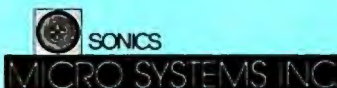

1500 N.W. 62 STREET
FORT LAUDERDALE, FL 33309
1-800-327-5567
IN FLORIDA CALL: 305-776-7177

at Sonics "We are Technology"

on 8-bit machines. This is often annoying, and makes it difficult to work with text. If we had type LONG STRING, which would use 2 bytes for the string length, it would make things easier. (For larger machines, you make things portable by changing all the LONG STRING variables to type STRING—a moment's work.)

2. A default for the CASE statement. Again, almost all implementations have this feature although it was not defined in the standard. We suggest the reserved word OTHERWISE to follow the last case; OTHERWISE rather than ELSE to avoid confusion with IF statements.

3. The compiler should ignore the underbar () character, so that you can use variable names like fist_of_god and first_boy for clarity, but not have to remember the underbars when you just want to write firstboy.

4. Static variables: variables local to a procedure, but which don't go away when you exit the procedure.

Seed for a random-number system is a perfect example: nothing outside the procedure needs to get at the seed, so seed shouldn't be global; but clearly it must stay around between calls to the random function.

5. Allow functions to return REAL and STRING values. Why shouldn't they?

6. The lack of a BREAK statement needs discussion; see my November column. It's desirable to have a way out of a loop without keeping track of dummy variables, but BREAK can be abused. We probably need one, but it should be tamed considerably. Design of a BREAK that fits into the spirit of Pascal needs some thought.

7. Ucase and lcase, which convert strings to uppercase and lowercase respectively, ought to be standard procedures (or functions if we can get functions to return strings). They're often needed, and the usual function writer slows things down a lot when writing these.

8. Do we want dynamic arrays

(redimensionable during run time)? They are convenient, but they're somewhat against the spirit of the language. The lack of redimensionable arrays has annoyed me from the time I first began to study Pascal.

9. We definitely need standards for separate compilation and for "include" statements. Using pseudocomments, such as `{$I+}` and the like, is currently done in most microcomputer Pascal implementations, and although a bit ugly, is acceptable; what's needed is a standard way of implementation.

10. The ISO Standard Pascal permits files almost anywhere. They are particularly necessary in records. Of the microcomputer implementations, Pascal MT+ allows files in records, while most, including UCSD Pascal, don't. It's important to have files in records, because it makes disk operations so much easier.

11. Constant definitions ought to permit elementary arithmetic. Complex arithmetic in the CONST declarations shouldn't be allowed, but `foo = 5; foobar = foo + 3;` definitely ought to be permitted. You certainly should be able to say `bell = chr(7).`

12. Pascal should permit you to read and write enumeration types. That is:

TYPE

```
day = (monday, tuesday,
       wednesday, thursday,
       friday, saturday,
       sunday);
```

VAR

```
today : day
```

and later in the program, the operation

```
today := tuesday;
write(today);
```

will fail. This is monstrously inconvenient, requiring you to have an array of day names (which you can name `dayname`), and then write `dayname[ord(today)]`, which is awkward at best.

13. There ought to be ways for a programmer to set up a stack and get at it. This needs thought lest it make

IF YOUR COMPUTER'S IMPORTANT TO YOU

Protect It!

Without SAFEWARE,[™] you could be uninsured. For as little as \$35 a year, SAFEWARE provides complete protection for all hardware, media and purchased software. Both business and home application. Call toll free today for more information or immediate protection. Columbia National General Agency, 88 E. Broad, Columbus, Ohio 43215. (In Ohio call 1-800-848-2112)

1-800-848-0598





Xerox 5400
\$16,095

IBM Series III
Model 10
\$22,635

Xerox and IBM give you copies as good as the Minolta EP 300. They just cost more.

When we say Xerox* and IBM* give you copies as good as the Minolta EP 300 we're being modest.

Because 74% of consumers interviewed by Nationwide Consumer Testing Institute said the copies produced by the EP 300 were clearly superior.

So, while the Xerox and IBM certainly do bigger jobs, they don't do better jobs than the Minolta EP 300 when it comes to copy quality.

The EP 300 has Minolta's exclusive micro-toning system. So its copies are extraordinarily crisp and clear. With blacker blacks. From top to bottom and edge to edge. On virtually any paper up to 10 x 14"

There's also an electronic troubleshooter to spot and prevent problems. And a universal tray so you can change paper sizes without changing trays. It's all in a copier hardly larger than an office typewriter.

If you'd like the test results, send us the coupon.

If you'd like the name of your nearest authorized Minolta dealer, look under our trademark in the Yellow Pages. Or call toll-free 800-526-5256. In N.J., 201-797-7808.

The Minolta EP 300. The small copier that proves size isn't everything.

The Minolta EP 300.
At up to 10 times the price,
we'd still look good.

©1982 Minolta Corporation. Product appearance and/or specifications subject to change without notice. Xerox® and IBM® are registered trademarks of Xerox Corporation and International Business Machines Corporation, respectively. Prices are those in effect as of 7/1/82.



Minolta EP 300
\$2,195



- Please send me the copy test results.
- I'd like more information. Please have my local dealer contact me.

Name _____

Title _____

Company _____

Address _____

City _____ State _____

Zip _____ Telephone _____

Mail to Minolta Corporation, Business Equipment Division,
101 Williams Drive, Ramsey, NJ 07446

programs too obscure.

14. We need a way to put variables in a specific place in memory and to reserve blocks of memory. This will of course be machine-dependent, but it's very desirable, especially if you have memory-mapped video.

There are probably other desirable Pascal extensions. The criteria are that they stay within the spirit of the language, that they be easy to use, and that they don't make the programs unreadable. They should also be reasonably easy to implement.

The above have received widespread agreement among those I've spoken with, including compiler writers. Other candidate extensions, particularly some that would make Pascal more suitable to use for writing operating-systems programs, are likely to be more controversial and will need considerable thought. Some of those will be detailed next month. The idea is to get an agenda for the meeting at the West Coast Faire.

Wescon and Mini/Micro

Wescon, September 14-16, filled the Anaheim Convention Center with more than 70,000 attendees. The Mini/Micro conference was held at the same time in the Disneyland Hotel. It attracted better than 10,000, plus a large number of Wescon attendees.

Wescon features high-technology components; I didn't spend much time there, although if I were trying to predict the future of the microcomputer world, I might have gotten some insights. I suppose the equipment on display will be in next year's systems, and I expect Ciarcia would have been fascinated.

I spent what little time I had at Mini/Micro, where several systems stood out. For me, the hit of the show was the new Heath/Zenith Z-100 computer. Readers may recall that I'm not much enamored of the IBM Personal Computer (incidentally, IBM wasn't at Mini/Micro). I don't like the Personal Computer because the bus isn't standard and the keyboard is badly designed.

Comes now Heath/Zenith: its product is what amounts to the Per-

sonal Computer on a six-slot (five slots free in the 128/192K-byte system) S-100 bus and with a good keyboard. The Z-100 is a dual-processor 8085/8088 system. It has both black-and-white and color display drivers (no monitor) built in as standard features; all this for slightly more than \$4000. You have to buy your own monitor, from a \$150 green-and-black to about \$800 for color.

The keyboard is very nice: an IBM Selectric layout with enough extra keys to make the full ASCII (American National Standard Code for Information Interchange) character set, plus Control and Escape keys and programmable Function keys. All keys have automatic repeat but with a twist: a "hyperspace" key makes auto-repeat *really* fast.

There's more. The Z-100 comes with dual 5¼-inch disks that read and write IBM Personal Computer format (as does my Compupro); the Z-100's disk controller will also talk to 8-inch disks, meaning that all you need do is connect 8-inch drives with a standard cable and you have both disk-drive sizes up and running, and you can copy files from one to the other using PIP.

There's not a lot new in the Z-100; but it's an excellent implementation of what it is. (Bill Godbout was overheard to mutter that the Z-100 is one of the nicest machines his Compupro team ever designed.)

Heath will sell you both CP/M-86 and MS-DOS in a package with some other programs for about \$500. It also gives you extensive documentation about the machine. I'll have more to say on the system next month; I'm strongly thinking of getting one, and we're talking to Steve Calkins of the Central Los Angeles Heath Electronic Center. The only negative feature I noticed was that there's no detachable keyboard; that is, the monitor is separate, but the machine itself has the keyboard built onto the main computer. In profile, it reminds me a bit of the old Sol computers. That can make for mild space allocation problems, especially here in Chaos Manor where we're up to our clavicles in computers.

I also saw the new DEC Rainbow Personal Computer. Like the IBM, the DEC keyboard has those extra keys between the Shift and the "Z" and "/" keys. The DEC salesman said, "There's a standard about to be adopted, and we *do* try to be reasonably standard." This "standard" comes from Europe. If it really took over here, every American touch-typist would have to learn all over again. I refuse. Fortunately, I suspect I can trust the marketplace to give me a "nonstandard" keyboard I can live with.

The Rainbow has a lot of extra keys, but no Escape key; the salesman said this was to avoid intimidating secretaries. I find that attitude, combined with use of a non-American keyboard, rather interesting.

I didn't get to spend a lot of time with the Rainbow. I'm sure there were a lot of things to like about it.

Adelle Again

One reason I went to the Mini/Micro show was that Greg Decoteau of CTI Data Systems had promised to fix Adelle, my Otrona Attache. She wasn't working because I'd foolishly exposed her to an inadequate voltage converter in Rome.

"Bring it to the show," he'd said. "I'll take care of it there."

This didn't seem very reasonable, but it did promise to be interesting, so I brought the Attache to the show.

Set the scene: a booth with about 20 feet of frontage and 8 feet of depth. Several Attache computers, plus a Mannesmann Tally line printer, on display. Hundreds of people wandering past, looking over Greg's shoulder, asking questions.

And in 16 minutes, 14 seconds, Greg took the Attache apart, disconnected the power-supply unit, installed a new power-supply module, reassembled the computer, and turned it on. It worked fine. And he did all that using a Phillips screwdriver from one of those 89-cent tool sets.

Incidentally, the Otrona still knew the time and date, which had been set back at Chaos Manor before I went to Italy. There's a battery backup for that part of the Attache, so loss of

WILD HARE REPROGRAMS THE TORTOISE

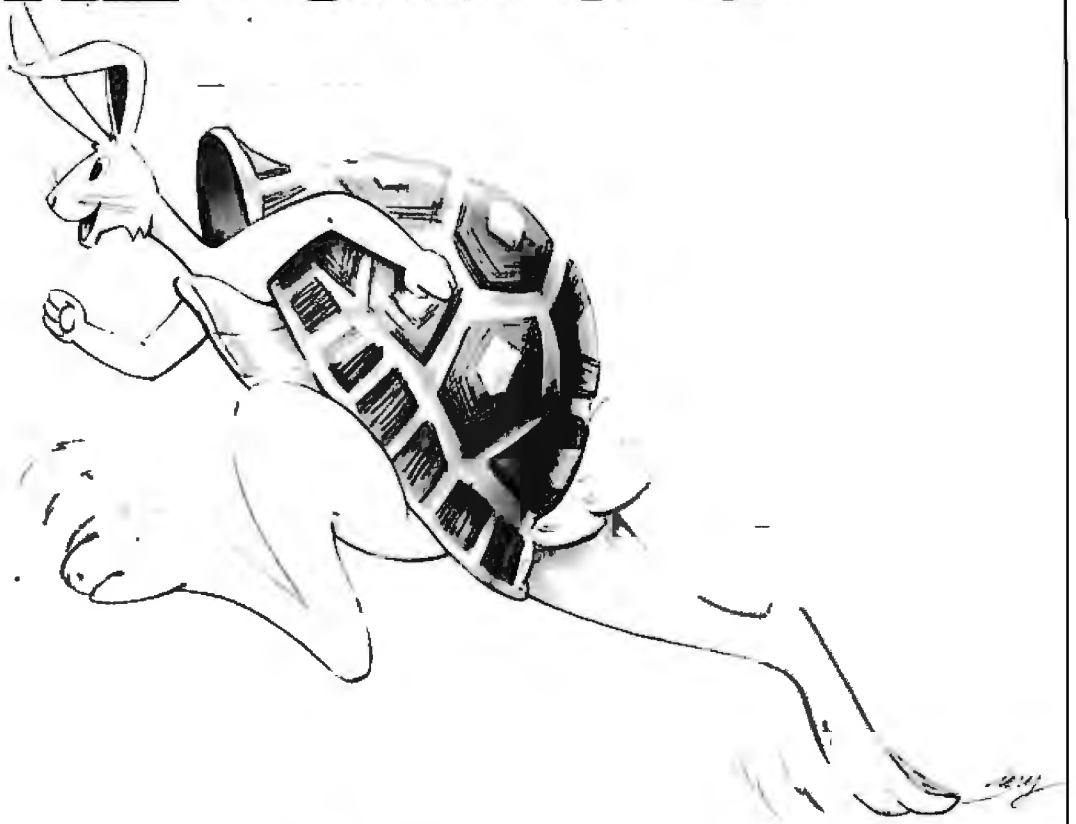

MORE GREAT NEWS FOR DATA GENERAL USERS!

Speedy Hardware puts you out front. Our Enhancer Hardware series is designed to dramatically improve the overall response and throughput of your Data General systems. Designed to look like an incredibly fast disk drive to your operating system, it accesses its 1MB of data in 2.5 microseconds and transfers it at 2 megabytes/second. Make ICOS (CS/COBOL), RDOS and INFOS streak with a 30-day trial run. AOS/Enhancer available soon!

Productive Software wins the race! In the race for productivity, Wild Hare gives you that extra edge by multiplying the capabilities of your Data General system. Wild Hare's TSS operating system enhancements give Data General NOVA and ECLIPSE users the most from their system. TSS allows you to transform RDOS, ICOS (CS/COBOL) and INFOS into true multilingual, multi-user Time Sharing Systems.

This state-of-the-art system accommodates up to 26 users. Each user can independently edit, compile and execute programs using the language of his choice, like FORTRAN, ALGOL, BASIC, COBOL, Pascal, Assembler and more.

TSS combines RDOS, INFOS and ICOS compatibilities with AOS capabilities at a mere fraction of the cost. Try a 30-day trial run and get an even greater run for your money.

Wild Hare wins the marathon. Wild Hare has a new hardware/software scheme. It allows you to take advantage of the latest hardware and software technology, yet lets you preserve your valuable Data General user software investment. Our new "Hare Brain Scheme" is on the starting line, so watch for the latest solutions from Wild Hare. Our good ideas keep multiplying.



wild hare
COMPUTER SYSTEMS INC.

power (or of the whole power supply) doesn't cause it to forget.

The machine was under warranty, so any dealer was authorized to repair it. (CTI isn't actually a dealer, it's in charge of marketing the Attache, and a number of other high-quality products, in Southern California; but in this case CTI acted as a dealer would.) The Attache is built in modules (it was quite interesting to see the innards); dealers have modules, and service consists of replacing modules until the machine works. The dealer doesn't have to know much about electronics—Greg Decoteau doesn't. He's a marketing man.

The results are impressive.

Now that I've got it running again, I've found more to like about the Otrona. The Valet alarm feature is very handy, the graphics are really lovely, and one of these days I'll find a use for the Greek-letter character set that's hidden in there underneath one of the nicest Roman-letter sets I've seen.

There's even a calculator pad. If you hit Control-Shift Lock, the "U," "I," and "O" keys become number keys, while the "P" becomes a "plus," and other interesting transformations take place. You can get key tops that show this (although I don't have them yet). I suspect this is more a gimmick than a feature I'll use often, but it does make it very clear; the Otrona's keyboard can be completely reprogrammed. You could, I suppose, even introduce a Dvorak keyboard as an alternate feature.

Of course, the Kaypro II comes with a full number pad as extra keys.

Yeah, But You're Different . . .

One chap at Mini/Micro said he reads my columns and likes them, but wonders if I don't get better service than the average customer.

That may be; although I try to have my machines taken in by one of the boys, or a student, many of the dealers know my equipment, and I'd be naive if I didn't suspect that a BYTE columnist is likely to be given

more attention than a walk-in.

There's not much I can do about that. I have to report what happens to me, and I can't do much more than that. I don't have the resources to run undercover investigations.

I do pay a lot of attention to *detailed* accounts of problems with software and equipment I've recommended in this column. I can't be the microcomputer world's ombudsman, but I can sometimes be the next best thing because I do know a lot of people in the computer business, and if I forward a letter it will usually be read. More than that I can't do.

Text Editors and Perfect Writing

This started as a review of Perfect Writer, and ended up with a lot about editors in general.

I've mentioned EMACS before. That's the text editor developed at MIT for use on its PDP-11s and other "big" machines. Many years ago, about the time Larry Niven and I got computers, we visited MIT and were given copies of the EMACS documentation. It included pages and pages of commands, so many that I was a bit intimidated. I showed it to my mad friend, who shuffled through it for a few moments and laid it aside without comment.

"Not interested?" I prompted.

"What's the point?" Mac Lean asked. "You won't get that running on our machines."

That situation has changed. At least two EMACS-like editors are now available for microcomputers: MINCE (MINCE is not complete EMACS), which I reviewed last year, and Perfect Writer, which isn't complete EMACS either, but is a pretty healthy subset of it.

What Took You So Long?

I'm probably not the best person to evaluate text editors for several good reasons. First, I'm not really the typical user of editor programs. I use text editors for three purposes: writing programs, writing letters, and creative writing. I spend most of my time on the third task, and if a program doesn't work for *that*, I don't really care much about how good it is at writing letters.

Beyond "Gödel, Escher, Bach"

If you marveled at *Gödel, Escher, Bach* you're ready for **LAWS OF THE GAME**—the book that offers a challenging exploration of **play** as the expression of creativity in nature and culture. The authors analyze games ranging from chess and bridge to board games of their own devising, such as "Survival" and "Hypercycle," showing how games relate to **physics**, biology and sociology. They draw **parallels** with molecular genetics, generative grammar, and the music of Bach and Beethoven. And they conclude with an **imaginary** conversation on the role of play in art and truth.

"Fascinating...Has the character of the deepest sort of discussion among brilliant friends."
—*New Yorker*

With 14 new games devised especially for this book
In paperback, at bookstores now

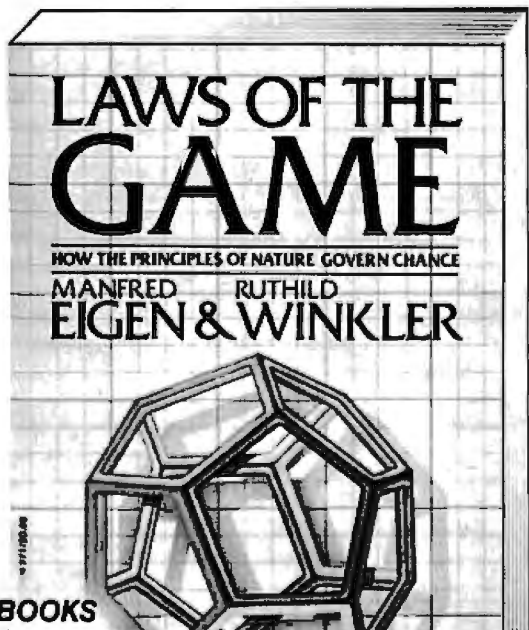



IDE introduces the world's lowest priced IBM PC Winchester disk drives.

At IDE, better technology leads to better pricing. Which is why we can offer you the lowest priced Winchester disk drives in the world. Without sacrificing performance or quality.

Our disk drives are as advanced as any you can buy. They're designed by one of the industry's leading innovators, SyQuest.

They're compact (3.9 in.), use no more power than conventional floppies, and hold up to 5 MBytes of storage.

And they'll fit right into your IBM PC, or if you wish, stand alone as a self-contained unit.

What's more, you can order your drive with fixed or removable disk.

Here are our low prices: In-chassis fixed disk \$1450. In-chassis removable disk \$1500. Self-contained fixed disk \$1650. Self-contained removable disk \$1700.

And when you take advantage of our special offer, you'll save \$150 more.

Why we cost less.

At IDE, we make only one type of product. Add-ons for the IBM PC.

By concentrating our efforts, we run our company more efficiently. And keep costs down.

We also eliminate things that drive costs up, like fancy showrooms and high-priced salesmen.

Free installation and one year warranty.

If you live in a selected major metropolitan area, we'll install our products in your home or office. Absolutely free.

If you don't live in one of these cities, we'll send your product along with the documentation you need to install it within minutes.

And all IDE products come with a full one year guarantee.

Not just 90 days.

Other IDE products.

You can also get a Combination Card from IDE. It comes with up to 256KB of memory plus your choice of up to 3 interfaces, including serial, parallel or SASI hard disk, and clock/calendar/battery.

Plus we offer you a complete line of memory products, including a 512KB board. All at IDE's low prices.

And with IDE's unique upgrade policy, you can trade in your current purchase toward another IDE product for the price differential plus \$25.

Order today.

Cut out the coupon and take advantage of our special offer. And get the lowest priced Winchester disk at an even lower price. But hurry, the offer ends soon. For more information on any IDE products, call us at (617) 272-7360.

Do it today.

And a way to make them even lower.

save \$150

Send me _____ 5 MByte disk drive(s) in the following configurations:
 _____ In-chassis fixed disk _____ In-chassis removable disk
 _____ Self-contained fixed disk _____ Self-contained removable disk

Total charge \$ _____

Mass. Residents add 5% Sales Tax

I have attached CHECK COMPANY P.O.
 Please charge my VISA MASTERCARD

Credit Card #: _____

Expiration Date _____

Signature _____

Name _____ Company _____

Address _____ City _____

State _____ Zip _____ Phone # () _____

IDE Associates

Mail to: IDE Associates, 44 Mall Road, Burlington, MA 01803

Offers ends Feb. 28, 1983

B283

For programming I use Wordmaster, and I've yet to see a better editor for that purpose. For letters I use whatever editor I use for creative writing, which may be a mistake, because my favorite editor isn't designed primarily for writing letters, and there may be some that are better for that purpose. (Tony says not so: that his latest version of WRITE will do the job beautifully.)

But my major need is for a "creative writer's editor." Indeed, the reason I bought a computer in the first place was that I'd seen Electric Pencil in operation down at a company that then called itself Computer Power and Light (it's now known as COMPAL). When I saw Electric Pencil, it was love at first sight. Pencil was shot through with terrible problems, but I didn't care. You can't imagine the joy I felt when I realized that I would *never have to retype a whole page again!* I could put up with all of Pencil's misfeatures (and plain bugs) forever just for that.

When I introduced my collaborator Larry Niven to the joys of writing with computers, he felt the same way. What did we care if Pencil wasn't very well written? For us it worked.

Fortunately, Mac Lean and Tony Pietsch weren't so easy to satisfy. They persuaded us to keep a log of things Pencil did that we didn't like and things we wished it would do that it didn't do. After about two years, Tony began writing a program that would take care of our problems, and in another year he had one he was willing to give us. That was WRITE 0.3; I am now using WRITE 1.6, while Larry, more conservative than I, is still using WRITE 1.51 or thereabouts. Either beats the stew out of Electric Pencil, and for a number of reasons WRITE is, in my judgment, the best *creative writer's* editor in existence—and that includes all machines, mainframes and minicomputers as well as microcomputers.

Just about a year ago, Tony was persuaded to market WRITE, and after he spoke to a number of companies, settled on Ashton-Tate. Now being published by Ashton-Tate is a big deal. It doesn't do things by halves. It doesn't release stuff that

isn't pretty solid, nor will it publish something that isn't expandable. It wants to compete with *everyone*.

Ashton-Tate can probably do that, too; but in order to make WRITE compete with all the other editors, it had to have features that neither Larry nor I ever dreamed of. That has taken time. Lots of time, more time than I ever thought it could take. Eventually I got worried, because I've mentioned WRITE in these columns and I get lots of mail about it, and all I can say is real soon now, which isn't much of an answer. So I have tried to persuade Ashton-Tate to release an early version of WRITE, one not so studded with features but intended primarily for creative writers. I hope this will happen, and maybe by the time this is in galley I'll know when.

What Do You Mean, Writer's Editor?

For me, the primary requirement is that an editor must be *transparent*. When I'm writing I don't need distractions. I don't want my editor telling me things I don't need or want to know. In fact, I don't want to see *anything* up on that screen except my text. In particular, I *hate* it when the editor natters at me. Wordstar, for example, wants to tell me the line and column number every time I press a key. Why, I don't know. It isn't information I often need, and surely if I do need it I can ask for it.

Next, I want the editor to be like an "electric pencil"; that is, I want to be able to move the cursor *rapidly* across the page and write over the wrong words, insert new words, move stuff around, exactly as I did when I used a red pencil on my paper typescripts. (Then I had to retype the page. Ugh.) And I want to do all this without thinking about it.

That means I want *cursor-oriented* commands. When I'm editing on paper, I don't move the pencil forward by sentences, I just move it. And I particularly don't want to have to remember a huge slew of commands in order to get my work done. It's nice to have a lot of special features, but I want the simple, easy-to-remember commands reserved for the stuff I do all the time.

Of course, I've described the "philosophy" of Electric Pencil and WRITE, which works like Pencil with the bugs removed.

There are, however, different views of what makes a perfect editor.

Perfect Writer

At long last, then, we can look at Perfect Writer.

Perfect Writer has many of the strengths and weaknesses of its parent EMACS. However, one of EMACS' strengths is not present: EMACS has online HELP features. If you're fairly sure there's a command that will do what you want, you can always ask, and generally EMACS will tell you. Alas, that's not present in Perfect Writer. I'm not sure why. WRITE has extensive HELP features.

Perfect Writer has cured one of EMACS' problems. At least in early versions of EMACS, the carriage return and linefeed that together make a NEWLINE character in the ASCII character set were treated as two different characters; and since commands in EMACS and Perfect Writer are *character-oriented* rather than *position-oriented*, the Control-f (move cursor forward one character) command did strange things at line ends, as did backspace. Perfect Writer doesn't have that problem, and the cursor moves at line ends exactly as it does anywhere else.

However, Perfect Writer retains all those character-oriented commands. You move forward or backward by lines, and because you must explicitly reformat your text (Perfect Writer, EMACS, and Wordstar are alike, and unlike Pencil and WRITE, in this regard), if you've made insertions, deletions, and changes in a line of text, what Perfect Writer thinks is a line can surprise the heck out of you. I have no doubt you can get used to it, but I'm not keen to.

One other thing I don't like about Perfect Writer is that it uses the kill buffer to move text. That is, whenever you delete anything larger than a single character, Perfect Writer stores that in a last-in/first-out stack, and the command Control-y (for yank) will get it back out for you. This makes undo or unkill easy in

Nobody offers you a wider variety of computer printers and printer experience than Facit/Dataroyal... all the way from low cost (\$695 list) matrix printers, to sophisticated graphics and color matrix printers, to models that print variable size characters and bar codes, to "daisy wheels" and a multimode near letter-quality printer. Industry standard parallel and RS232C serial interfaces are available in all printers.

Our products are built to perform day after day in the most rugged

environments. We achieve that kind of reliability by incorporating modern, trouble-free LSI circuitry, and fewer moving mechanical parts along with a high level of quality control.

Hundreds of computer systems manufacturers choose Facit/Dataroyal products with confidence, as do a great number of Fortune 500 companies who use Facit/Dataroyal peripherals with their systems.

If you want a trouble-free printer, contact your local computer

printer dealer or Facit/Dataroyal, 235 Main Dunstable Road, P.O. Box 828, Nashua, NH 03061, (603) 883-4157.



**FACIT
DATAROYAL**

Circle 140 on inquiry card.

Printers, printers, and more printers.



both EMACS and Perfect Writer, so that if you've accidentally deleted something it's no problem; a feature we don't have in present versions of WRITE, and one I've sometimes wished I had.

I don't wish for unkill enough to pay the price, though: which is that you can't easily move text about, because the buffer is often jammed with "killed" text that refuses to stay dead. This, however, is a personal preference, and I understand that a lot of people *like* using the kill buffer as a text mover.

The final blow, though, is that Perfect Writer natters at me worse than Wordstar. Now it *may* be a function of my Televideo 950 terminal, but I don't think so. Perfect Writer keeps track of all kinds of stuff, and every time you give it a command, before it goes off to execute it, it has to tell you down on a status line what it's about to do; it also tells you what percent of your text is below the cursor, and it updates that with *every* keystroke so

that it flickers like a madman's dreams.

That cursor jumps around like a kangaroo, more than enough to discourage any signs of creativity in me. Of course, I'm always looking for a good excuse not to write; like most professional writers, I hate writing. (I love to *have written*, but that's a different matter entirely.) But I tell you, that jumping cursor is enough to drive me stark, staring mad.

It gets worse, too. Perfect Writer, like EMACS, is normally in the Insert mode: when you type text in the middle of a line, it moves everything to the right each time you type a letter, rather than overstriking the text. It says it has an "Overwrite" mode, which you can get to by going Control-x m and then writing the word overwrite. (In both WRITE and Electric Pencil, you simply toggle from Overstrike to Insert mode by doing Control-f; in WRITE, the cursor changes to show what mode you're in.)

Perfect Writer not only makes it

darned hard to get from Overwrite to Insert mode—and I tend to use Overwrite a *lot* because it's very convenient for touch-typists—but in fact the Overwrite mode doesn't even work. That is, I go Control-x m overwrite and the display changes (Perfect Writer always tells you what mode you're in whether you want to know it or not; there's no way to suppress the annoying Mode Line and "Echo Line"); but although the display now tells me I'm in Overwrite mode, what happens next isn't very predictable. For one thing, backspace, which used to backspace, is now destructive, although there are places within the text where the destruction doesn't show up until later.

I don't want my keys to change their functions. I like consistency.

There are other problems. For instance, suppose you are in Insert (normal) mode, and you type a couple of extra spaces. Those spaces are now in your text. You can't see them, but they're there. And if you backspace, the cursor jumps around

Skier Specials

MicroSci A-2 (Drive for Apple) Controller	\$269.00
Franklin Ace 1000	79.00
	999.00

Spring Specials

IBM Computer Interface AST-Combo Plus 64K	
64K of Ram; Par. & Ser. Port; Clock w/Bat. Backup; Super Drive & Super Spooler Software	
ONLY \$359.00	

Same as 801R	8" Siemens Disk Drive FDD 100-8	NEW
	(Quantity pricing available)	
	ONLY \$239.00	

IF YOU CAN'T FIND IT, WE WILL, AT THE LOWEST PRICE

Drives for Apple & Franklin

Rana Elite I	\$309.00
Rana Elite I w/cont.	379.00
Micro Sci A-2	269.00
Micro Sci Controller	79.00

Apple Products

Videx Videoterm (80 column)	\$239.00
Soft Switch	24.00
16K Memory Card	59.00
Par. Card & Cable	59.00
Grappler +	118.00
Microsoft Z-80 w/cpm	259.00
TG Joy Sticks	39.00
5 1/4 Diskettes (10 ea.)	18.95
Apple Cat Modem	279.00
Micro Modem II	269.00
Versa Card	159.00
Super Fan	59.00

IBM Products

	Qty. 1	Qty. 2
Tandon TM 100-1	\$189	\$179
Tandon TM 100-2	259	Call
Tandon TM 100-4	349	339
AST-Combo Plus 64K (Qty. 1)		369

Modems

Hayes Smart Modem (300 Baud)	\$199.00
Novation D-Cat	139.00

8" Disk Drives

	Qty. 1	Qty. 2
Siemens FDD 100-8	\$239	Call
Shugart 801R	389	379
Mitsubishi Dbl/Dbl	409	399
Qume DT-8 Dbl/Dbl	479	469
Shugart 851R	479	469

Computers

Apple II Plus 48K	Call
Franklin Ace 1000	999.00
Commodore 64	Call

Printers

C. Ioth Prowriter Par.	\$439.00
C. Ioth Starwriter F-10, 40PU	1349.00
Okidata 82A	399.00
Okidata 83A	649.00
Okidata 84P	960.00
Okidata 84S	1025.00
Tractor for 82A	49.00
Tractor for Starwriter	199.00
NEC 8023A	469.00
Epson MX80FT	479.00
Epson MX100FT	689.00

Monitors

AMDEK Video 300C	\$149.00
AMDEK Color I	309.00
AMDEK Color II	689.00
AMDEK Color III	418.00
BMC 12A	86.00
BMC 12EU (20 MHz)	99.00
Zenith 2VM121	104.00

RAM (Prime Parts)

4116 (200ns)	\$1.15 ea.	4164 (200ns)	\$5.90 ea.
2114 (200ns)	1.00 ea.	6116 (200ns)	4.99 ea.

New Expanded Hours
8:00 to 8:00 Mon.—Sat.

Computer Components Unlimited

P.O. Box 1936, Hawthorne, CA 90250
Sales Office: 12308 Burl Avenue
Hawthorne, CA 90250

Order Desk:
(213) 219-0808
Customer Service:
(213) 219-0811

All merchandise new. We accept MC, Visa, Check & P.O.'s from qualified firms. CA Res. add 6 1/2% Sales Tax. Please add shipping: \$3.50 first 5 lbs., 60¢ ea. add. lb.

OVERBUILT.



In Touch with Tomorrow

TOSHIBA

Now you can afford to be choosy. With the Toshiba P1350 dot matrix printer. Choose quality when you want it. Speed when you need it. At a price you'd expect to pay for just one or the other.

For speed, choose the draft mode. 160 CPS. About a page a minute. For quality, choose the LetterPerfect mode. 100 CPS. About twice as fast as a daisy wheel. Or choose the graphics mode at 192 CPS.

The technological breakthrough that makes it possible: Toshiba's fine-wire, overlapping, 24-pin, impact print head. For incredibly high 180 dots per inch density with a single pass.

More choices: variable pitches of 12 CPI or 10 CPI.

Three character fonts. Variable line spacing. Single sheet paper or continuous forms, from 5" to 15" wide, with up to four copies. Friction feed, pin feed tractor or Toshiba's ultra-reliable sheet feeder. And a choice of interfacing: parallel or serial.

Toshiba P1350. It gives you the choices you want. The quality you expect. The reliability you need.



The precision you require. The low-maintenance long life you like. The price you love. With versatility and

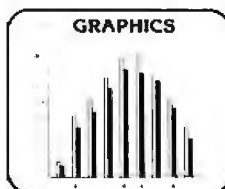

performance that's been proven in more than 7,000 installations.

When it comes to printers, you really have no choice. There's only the Toshiba P1350. Write for the details on everything it can do for you. Toshiba America, Inc., Information Systems Division, 2441 Michelle Drive, Tustin, CA 92680.

Better yet, call toll-free...now!

1-800-648-5000

Ask for operator #198
In Nevada, call (702) 329-9411

UNDERESTIMATED.

LINEAR CIRCUITS		THIS MONTH'S SPECIALS		DISC Controllers		REGULATORS	
DA0820 - 4.95	LM001 1.75	2141L-4	\$1.35	1791	29.00	LAS1405	44.50
TL062CP - .95	LM007 1.40	4116-2	1.60	1793	35.00	LM3177	91.00
TL084CN - 1.50	LM007 1.40	93L422 BIPOLAR	5.95	1795	45.00	78L05, 78L12	.40
LM001 - 1.50	LM007 1.40	RAM's		1797	45.00	LM305G	.75
LM001 - 75	LM007 1.40	2141L-4	\$1.35	D785C	25.00	320T 5.1Z, 15or 24	.80
LM007/748 - .30	LM007 1.40	4116-2	1.60	68000L8... \$90.00		RS232 CONN	
LM008 - .75	LM007 1.40	MK4802-J3-2KX8	8.95	CRT Controllers		DB 25F male \$2.75	
LM008 - .75	LM007 1.40	2147 J3	4.95	TMS9927NL... \$ 9.95		DB 25S female ... 3.75	
LM010 - 1.10	LM007 1.40	4118-4	6.95	8275		HOODS	
LM011 - .50	LM007 1.40	SPECIALS GOOD THRU FEB. 1983		74LS SERIES			
LM018 - .75	LM007 1.40			74LS00 - 20		74LS107 - 36	74LS196 - 85
LM019 - .50	LM007 1.40			74LS01 - 20		74LS109 - 36	74LS197 - 85
LM024 - .65	LM007 1.40			74LS02 - 23		74LS112 - 38	74LS221 - 75
LM034 - .30	LM007 1.40			74LS03 - 23		74LS113 - 45	74LS240 - 90
LM037 - .75	LM007 1.40			74LS04 - 23		74LS114 - 36	74LS241 - 90
LM038 - .75	LM007 1.40			74LS06 - 23		74LS123 - 60	74LS242 - 120
LM039 - .50	LM007 1.40			74LS08 - 23		74LS124 - 125	74LS243 - 120
LM042 - .65	LM007 1.40			74LS09 - 25		74LS125 - 46	74LS244 - 80
LM048 - .65	LM007 1.40			74LS10 - 23		74LS132 - 56	74LS245 - 150
LM049 - .50	LM007 1.40			74LS11 - 25		74LS136 - 45	74LS246 - 110
LM050 - .50	LM007 1.40			74LS12 - 25		74LS137 - 95	74LS251 - 65
LM051 - .50	LM007 1.40			74LS14 - 40		74LS138 - 50	74LS253 - 65
LM052 - .50	LM007 1.40			74LS15 - 35		74LS139 - 52	74LS257 - 68
LM053 - .50	LM007 1.40			74LS16 - 23		74LS147 - 1.95	74LS258 - 68
LM054 - .50	LM007 1.40			74LS17 - 25		74LS151 - 38	74LS259 - 1.40
LM055 - .50	LM007 1.40			74LS18 - 25		74LS153 - 40	74LS266 - 60
LM056 - .50	LM007 1.40			74LS19 - 23		74LS156 - 60	74LS273 - 115
LM057 - .50	LM007 1.40			74LS20 - 23		74LS157 - 80	74LS279 - 48
LM058 - .50	LM007 1.40			74LS21 - 25		74LS158 - 45	74LS280 - 180
LM059 - .50	LM007 1.40			74LS22 - 27		74LS160 - 48	74LS283 - 85
LM060 - .50	LM007 1.40			74LS23 - 27		74LS169 - 70	74LS280 - 75
LM061 - .50	LM007 1.40			74LS24 - 30		74LS171	74LS283 - 95
LM062 - .50	LM007 1.40			74LS25 - 30		74LS172	74LS288 - 1.00
LM063 - .50	LM007 1.40			74LS26 - 30		74LS173	74LS320 - 2.00
LM064 - .50	LM007 1.40			74LS27 - 30		74LS174	74LS323 - 3.50
LM065 - .50	LM007 1.40			74LS28 - 30		74LS175	74LS326 - 80
LM066 - .50	LM007 1.40			74LS29 - 30		74LS176	74LS327 - 68
LM067 - .50	LM007 1.40			74LS30 - 30		74LS177	74LS328 - 1.25
LM068 - .50	LM007 1.40			74LS31 - 30		74LS178	74LS329 - 1.50
LM069 - .50	LM007 1.40			74LS32 - 30		74LS179	74LS360 - 58
LM070 - .50	LM007 1.40			74LS33 - 30		74LS180	74LS378 - 1.25
LM071 - .50	LM007 1.40			74LS34 - 30		74LS181	74LS377 - 1.25
LM072 - .50	LM007 1.40			74LS35 - 30		74LS182	74LS386 - 1.50
LM073 - .50	LM007 1.40			74LS36 - 30		74LS183	74LS390 - 1.30
LM074 - .50	LM007 1.40			74LS37 - 30		74LS184	74LS393 - 1.30
LM075 - .50	LM007 1.40			74LS38 - 30		74LS185	74LS398 - 2.50
LM076 - .50	LM007 1.40			74LS39 - 30		74LS186	74LS520 - 1.00
LM077 - .50	LM007 1.40			74LS40 - 30		74LS187	74LS522 - 3.00
LM078 - .50	LM007 1.40			74LS41 - 30		74LS188	8737 - .95
LM079 - .50	LM007 1.40			74LS42 - 30		74LS189	
LM080 - .50	LM007 1.40			74LS43 - 30		74LS190	
LM081 - .50	LM007 1.40			74LS44 - 30		74LS191	
LM082 - .50	LM007 1.40			74LS45 - 30		74LS192	
LM083 - .50	LM007 1.40			74LS46 - 30		74LS193	
LM084 - .50	LM007 1.40			74LS47 - 30		74LS194	
LM085 - .50	LM007 1.40			74LS48 - 30		74LS195	
LM086 - .50	LM007 1.40			74LS49 - 30		74LS196	
LM087 - .50	LM007 1.40			74LS50 - 30		74LS197	
LM088 - .50	LM007 1.40			74LS51 - 30		74LS198	
LM089 - .50	LM007 1.40			74LS52 - 30		74LS199	
LM090 - .50	LM007 1.40			74LS53 - 30		74LS200	
LM091 - .50	LM007 1.40			74LS54 - 30		74LS201	
LM092 - .50	LM007 1.40			74LS55 - 30		74LS202	
LM093 - .50	LM007 1.40			74LS56 - 30		74LS203	
LM094 - .50	LM007 1.40			74LS57 - 30		74LS204	
LM095 - .50	LM007 1.40			74LS58 - 30		74LS205	
LM096 - .50	LM007 1.40			74LS59 - 30		74LS206	
LM097 - .50	LM007 1.40			74LS60 - 30		74LS207	
LM098 - .50	LM007 1.40			74LS61 - 30		74LS208	
LM099 - .50	LM007 1.40			74LS62 - 30		74LS209	
LM100 - .50	LM007 1.40			74LS63 - 30		74LS210	

with a funny monkey motion that won't go away until you've done a carriage return, or maybe killed to end of line (putting those superfluous backspace characters into the kill buffer, I suppose) . . .

In other words, I don't much care for Perfect Writer, for the same reasons I didn't like MINCE and I don't like EMACS. Yet for many of the same reasons I *don't* like EMACS-type editors, there are those who very much *do* like them. Some people want character- and word-oriented commands, text movement by kill buffer, Insert as the normal mode, and all the rest.

I don't like the editor because it's distracting. Perhaps I haven't given it a fair chance, but I don't think that's true. I've worked with it—and with EMACS—enough to have a pretty good feel for that kind of editor, and my conclusion is that I have to pay too much attention to the *editor*, so that I don't pay enough attention to my writing. I don't want to think about my editor and its features; I want to think about the sentences I'm writing.

Those who'll use an editor primarily for programming, or for writing letters, might well have a different view.

There are plenty of features to Perfect Writer. It has far more commands than I have with WRITE (more than I'd ever bother to learn). It has split-screen capability, whereby you can look at and edit more than one file at a time.

It has very clear documentation. It took me almost no time to get Perfect Writer up and running on my system and get to editing a file. Now of course I know text editors in general, and I've used EMACS rather often, so perhaps that isn't surprising, but in fact the Perfect Writer documents are impressive.

There's also a spelling program that comes as an option with Perfect Writer. I haven't tried it, but it looks clean and easy to learn and I'm sure it's efficient. The documents are clearly written.

There are also lots of print-format features; I can't really compare them with WRITE (or any other editor)

POSTAGE RATES
 ADD 10% FOR ORDERS UNDER \$25.00
 ADD 5% FOR ORDERS BETWEEN \$25.00 AND \$50.00
 ADD 3% FOR ORDERS ABOVE \$50.00

SOLID STATE SALES TEL. (617) 547-7053
 P.O. BOX 74B TOLL FREE 1-800-343-5230
 SOMERVILLE, MASS. 02143 FOR ORDERS ONLY

IT'S FREE!

Announcing the NEW, Spring 1983 Moore Computer Forms and Supplies Catalog

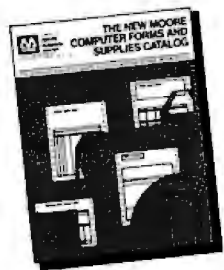

- Our new, 84-page Spring Catalog features more than 800 quality, brand-name products—all guaranteed to meet your 100% satisfaction or your money back
- For all your computer or word processor needs, a wide selection of magnetic media, disk storage, binders, ribbons and furniture
- Over 40 pages of multi-purpose computer forms and labels at low prices, including an ALL-NEW 34-page section of imprinted forms
- Unmatched customer services, like fast order processing, custom imprinting, emergency overnight delivery, plus exclusive toll-free Technical Product Assistance

Now with a NEW 34-page computer forms section!

Mail this coupon or call toll-free
1-800-323-6230
 (In Illinois, Call (312) 459-0210)

YES! Send me a FREE 84-page, full-color copy of the Spring 1983 Moore Catalog

YOUR NAME _____ TITLE _____ BUSINESS PHONE _____

COMPANY NAME _____

ADDRESS _____

CITY _____ STATE _____ ZIP _____

COMPUTER MAKE AND MODEL _____

TYPE OF BUSINESS _____ NO. OF EMPLOYEES _____

CHIP-nology



Software Gourmet Guide & Cookbook Series for 6502, Z80, 8080, and 6800 Programmers

Essential guides designed to take BASIC language programmers into the realm of machine language programming. The complete chip instruction sets are clearly and carefully explained. Descriptions of the fundamental elements of each CPU, including the program counter, index registers, stack pointer, memory, and status flags stress the creative advantages and programming power of each chip. General purpose subroutines, conversion routines, input/output processing, and floating point routines are discussed in depth.

- #6276, Z80 Software Gourmet Guide & Cookbook, \$15.95
- #6280, 8080 Software Gourmet Guide & Cookbook, \$12.95
- #6277, 6502 Software Gourmet Guide & Cookbook, \$12.95
- #6281, 6800 Software Gourmet Guide & Cookbook, \$12.95

#6255 **The 8086/8088 Primer: An Introduction to Their Architecture, System Design, and Programming**, 2nd Ed. (Morse) *Written by the man responsible for the design of the 8086 microprocessor.* Updated to provide novices and professionals alike with a thorough introduction to Intel's 8086 and 8088 microprocessors. \$11.95

#5167 **Z-80 and 8080 Assembly Language Programming** (Spracklen) Everything the applications programmer needs to know for Z80 and 8080 processors. Presents programming techniques with instructions. Exercises and answers included. \$10.75

#6275 **Z80 Instruction Handbook** (Wadsworth) Clearly explains the capabilities of the powerful Z80 instruction set. Serves as a practical reference to industry standard mnemonics, machine code, and usage for each type of instruction provided in the Zilog Z80 CPU. A useful guide to the novice, intermediate, or professional programmer. \$5.95

#0758 **Basic Microprocessors and the 6800** (Bishop) Two books in one: a basic guide to microprocessors for the beginner, and a complete description of the M6800 system for the engineer. Problem section follows each chapter. \$16.50

#183 **Programmer's Guide to the 1802 (With an Assembler for Your Machine)** (Swan) An assembly language primer that has an assembler! Teaches assembly language for the 1802 microprocessor. Coverage includes everything from the binary number system and the fundamentals of machine language to the development of a working 1802 assembler. Simply written, the text is intended for the beginner, but contains information that experts will appreciate. \$8.75

#0897 **The S-100 Bus Handbook** (Bursky) Exclusively discusses S-100 bus computer systems and how they are organized. Covers computer fundamentals, basic electronics, and the parts of the computer. Explains all the operating details of commonly available S-100 systems. Schematic drawings of all boards discussed. Each of the major system boards is detailed as to how it operates and how it connects to the rest of the system. \$17.50

Available at your local computer store or
Order by Phone 1-800-631-0856
 operator BY 23, In NJ call 201-843-0550, ext. 382

Hayden

Items Reviewed

Attache Computer

Otrona Corporation
4755 Walnut St.
Boulder, CO 80301
(303) 444-8100

\$3995

Heath/Zenith Z-100 Computer

Heath Company
Benton Harbor, MI 49022
(616) 982-3200

\$4099

Pascal Prime Project

Alexander Pournelle
c/o Workman & Associates
112 Marion Ave.
Pasadena, CA 91106

If you are interested in
this project, you can write
to this address.

Perfect Writer

Perfect Software Inc.
1400 Shattuck Ave.
Berkeley, CA 94709
(415) 644-3644

\$495

because I don't use those much. Most of my printing is pretty standard—60-character lines, double-spaced, identifying header, and page number; hardly a proper test for a text formatter's capabilities. From what I get out of reading the manuals, most of the text editors have some pretty fancy format capabilities.

They tell me that a number of new computer-system manufacturers are considering Perfect Writer as the text editor to provide with their hardware. They could make a worse choice.

The Things My Postman Brings Me . . .

I mentioned last month my friend Max, who sent his CCS boards back to the factory only to be told that while the boards were in transit, CCS had changed its policy and no longer sends loaners. I've found out why: according to a source at CCS, it sold the loaner boards at a swap meet.

CCS did fix Max's machine; but it wouldn't send his boards back to him until it had his payment for repairs in its office. (His machine had only about 20 hours in operation, but because of all the delays in trying to get it running, the warranty had expired.) Eventually he got his boards, and the machine works.

Max isn't happy. He says, "The

more I thought about it, the more I became sure that I should stand up for my rights as a consumer. I called CCS one more time and asked to speak with the president of the company. According to the CCS receptionist, CCS has no president . . ."

When we got our CCS machines (for Alex and Dr. Possony), we dealt with systems consultant Colin Mick, whom I've mentioned before; and we've had no real problems. I know of many other CCS installations that run smoothly. Alas, though, Max's horror story is not the only one I've heard about what can happen if your CCS doesn't work.

And now, finally, my hate mail, typified by letters from Cherry Davis of Chicago and Ward Harold of Pennsylvania. Why, they (and others) ask, do I not learn the "spirit" of Pascal? Don't I know that "a significant teaching of the structured-programming movement was that the programmer should not even try to compile a program until he has convinced himself that it is free of bugs"? Obviously, I have not "given Pascal much of a chance. If you are still making trivial errors . . . you probably have not spent enough time with the language to really be comfortable with it."

Ms. Davis goes on to inform me that "you tend to confuse evaluation

of a language with evaluation of an implementation of a language . . ." She concludes that I ought to "turn over the project [Alex's Intro package] to someone who has enough experience in Pascal and with microcomputers to write a book from the ground up for teaching Pascal on microcomputers."

Meanwhile, Mr. Harold tells me that I exaggerate when I say Pascal has obscure errors and faults, because "all possible errors for an ISO, or Jensen and Wirth, standard implementation of Pascal are listed in the *Pascal User Manual and Report* . . ."

Yeah. They sure are. Unfortunately, there is no ISO, or Jensen and Wirth, implementation for microcomputers; furthermore, every compiler I know of tends to have pet error messages for the cases when the compiler was just plain confused; and often those messages have no relationship at all to the real error.

In fact, one of the most significant parts of my son Alex's Pascal Primer (down at UCSD it's becoming known as the survival kit) is that he goes through the error messages and shows examples of what might have caused them. Without that, I'd have given up on the language long ago.

Davis and Harold want me to consider the language separately from the implementations—but I just can't do that. Despite a lot of flack to the contrary, this is the User's Column. It has to be, because I'm no computer scientist. I use these machines, and I try to record my experiences; once in a while, those experiences may lead me to some theoretical insights, and they certainly tend to generate strong opinions; but there's no way I can evaluate Pascal—or any other language—separately from my experiences in trying to use it, which means I'm inevitably going to confuse the language with its implementation.

However: for a User's Column, that's not a bug, it's a feature. I like little computers, I've been using them for a long time, and I like talking about what you can do with the little beasts. I leave computer theory to Edsger Dijkstra and others far more qualified than I am. ■



Oryx software Quality Discount

February Specials

GUARANTEED LOWEST PRICES! We will match any advertised price. Just show us the ad.

APPLE

HAYES SMART MODEM, reg. 629 **NOW 499**
ODW JONES ANALYZER

Artsci

Magic Window \$79
Magic Mailer 56
Magic Words 56
Magic Pack Combo (all above) 176

Beagle Bros.

Oes Boss \$22
Utility City 25
Apple Mechanic 25

Broderbund

Apple Panic \$25
Chepflifer 26
Serpentine 26

Charles Mann

Basic Teacher \$30
Teacher Plus 32
Medical II 879

Denver Software

Easy(Exec. Att'g) (Special) \$565
Financial Partner 219
Pascal Tutor 108
Pascal Programmer 108

Howard Software

Real Estate Analyzer \$145
Tax preparer '82 127
Tax preparer state: CA, NY/NJ/IL 60

Krell Co.

Logo \$135
Logo w/o Frills 89

Micropro

WordStar (Reg. CP/M) \$195
MailMerge 85
CalcStar 145
SpellStar 145
SuperSort 120
Data Pak (Special) 329

Microsoft

Basic Compiler \$315
Cobol-80 599
Fortran-80 155
Time Manager 125

Omega

Locksmith \$79
Inspector 47
Watson 44

Games

Hayden Sargon II \$25
Infocom Zork I, II or III 32
Infocom Deadline 42
L & S Crossword Magic 38
Sirtech Wizardry 39
Sirtech Night of Diamonds 29

Misc.

ISM Mathemagic 580
ISA Spellguard 199
LJK Edit 6502 82
On-Line Screen Writer II 95
Grandon A-stat 79 140
STC Mailing list 48
Stoneware OB Master 179
Visicorp Viscicalc 3.3 185
Visicorp Viscischedule 235
Visicorp Adv. Viscicalc (Ap.111) 320
Visicorp Viscipack 499

PFS: Filing Report or Graph

Muse Software

Super Text II \$125
Address book 43
Form letter 87
Data Plot 52

Peachtree

Series 40
G/L, A/R, A/P ea. \$399
Inventory, Payroll ea. 399
*G/L + A/R + A/P (Special) 397
Series 9
Peachcalc 279
Telecommunications 279

Silicon Valley

WORDHANDLER (Special) \$149
Sensible Speller 99

CP/M

Mark of Unicorn

Final Word \$250

MicroPro

WordStar (Special) \$250
MailMerge 95
CalcStar 199
SpellStar 160
SuperSort 170
Data pack (3 in One) 395

Microsoft

Basic 80 \$285
Basic Compiler 325
Fortran 80 345
Cobol 80 570
Macro 80 140

Peachtree

General Ledger \$399
Accounts Receivables 399
Accounts Payables 399
Inventory 399
Payroll 399
Property Management 799
CPA Client Write-up 799
Series 8 Module 485
*Peachpak 4 (G/L, A/R, AP) (Special) 397
Peachtext 350

Star Computer System

G/L, A/R, A/P or Pay \$350
Legal Times Billing 845
Property Management 845

Sorcim

Supercalc \$225
Trans 86 115
Act 155

Supersoft

Diagnostic I \$48
Diagnostic II 83
Disk Doctor 84
Fortran 299
C Compiler 175

Ashton - Tate

D Base II \$485

Byrom Software

BSTAM \$160
BSTMS 160

CP Aids

Please Call

Digital Research

Pascal MT + \$389
MAC 85
SID (8080 Debugger) 65
ZSID (Z80 Debugger) 90
CP/M 2.2 149
C Basic 2 97
PL/1-80 449

Misc.

Oasis "The Word Plus" \$120
Micro Ap Selector V 395
Lifeboat T/Maker II 225
Epic Supervyz 115
The Boss Financial Acctg. 1800
The Boss Payroll System 750
The Boss Time Billing 1090
Fox and Geller Quick Screen 129

Games

Infocom Zork I, II or III \$32
Deadline 50
Yahoo Catchum 32
Adventure (#1-12) 99

And Many More

IBM PC

Micropro WordStar (Special) \$250
Micropro MailMerge 95
IUS EasyWriter II 299
IUS EasySpeller 149
Microstuff Crosstalk 129
Alpha DataBase Manager 170
Alpha Mailing List 85
Compview Vedit 165
Compview CP/M 86 295
Data Most Write-on 110
Woolf Move It 125
ISA Spellguard 247
Easy (Exec. Acctg. Sys.) 625
Easy Planner 145
Ashton-Tate D Base II 485
Lifetree Volkswriter 175
Peachtree Accounting Module 399
*Special Peachpak (GL, AR & AP) 399
Ecosoft Microstat 257
Supersoft Optimizer 160
Northwest Statpak 397
Northwest The Final Word 250

Games

Last Colony \$25
Temple of Apsahai 33
Galaxy 22
Midway Campaign 20
Championship Blackjack 34
Frogger 30
The Warp Factor 35
Commodore 64 Software \$call

Accessories/ Hardware

Boards

Coprocessors 88 card (Ap. II) \$795
Softcard (Z80 CP/M Ap. II) 245
CPS Multifunction 178
Mountain A/O + O/A 289
CCS 12K ROM/PROM 89
CCS A/O Converter 98
CCS Serial Asynch 129

Applescope (your Apple as an Oscilloscope) 595

Videx Enhancer I 149
K & O Enhancer 115
Dan Paymar Lower case 27
ALS Smarterm 379
ALS Z-card 269
Percom Doubler II 167
Bit 3 Full View 80 (AT800) 299
Bit 3 32K Memory (AT400/800) 159
BYAD DS-1 (64K, Z80, CPM for IBM PC) 599
Datamac 64K (IBM PC) 399
Videx Micromodem Chip 25
Xedex Baby Blue (IBM PC) 495
Quadram Deluxe Board (IBM PC) 445
Quadram 128K Ram (IBM PC) 495
Microflazer BK Printer Buffer 135
Versacard 160
Bit 3 Dual Comm-plus (Apple II) 209
16K RAM WIZARD - 16 (Apple II) Special) 79
Echo II Speech Synthesizer 159
Symtec Light Pen (IBM PC) 140
Symtec Light Pen (APII/III) 200

Computers

Commodore/Atari/NEC/Xerox
Call for Price Information

Monitors

Amdek Video 300 \$160
Amdek RGB Color 699
NEC 12" Hires Green 159
Sanyo 12" Hires Green 199
TECO TM - 12 GX Green 147
TECO RGB 13" 525
USI HI-RLS 12" Amber 199
Zenith ZVM 12" Green 115

Modems

Novation Apple-Cat II \$299
Novation 212 Auto Cat 585
Hayes Smartmodem 225
Hayes Smart Modem 1200 520
Micromodem II 319
Hayes Chronograph 199

Printers

Anadex 9500 Series \$1,580
Epson \$Call
C. Itoh Starwriter 1450
C. Itoh Prowriter 499
Diablo 630 2,200
NEC 3530 1,890
NEC 8023A 525
Okidata Microline B2A 460
Okidata Microline B3A 685
Prism 80 (w/ 4 options) inc. color 1,399
Prism 132 (w/ 4 options) 1,547
Smith-Corona TP-1 675

Disk Drives

RANA ELITE I (Ap. II) (Special) \$325
RANA ELITE II \$ Call
RANA ELITE III \$ Call
Rana Controller (Ap. II) 90
Micro Sci A35 (Ap. II) 399
Micro Sci A40 (Ap. II) 385
Micro Sci A70 540
Micro Sci Controller (Ap. II) 90
TANODN TM-100-1(IBM PC) 215
TANODN TM-100-2(IBM PC) 274

And Many More

ORDER TOLL FREE - Outside WI - 1-800-826-1589

Please:

- Wisconsin residents - add 5% sales tax
- Add \$3.50 for shipping per software and small items. Call regarding others.
- Foreign - add 15% handling & shipping for small items & software.

We welcome:

- Visa, Mastercharge - (Add 4%)
- Checks (Allow 1-2 weeks for clearing)
- COD (Add \$1.50 per shipment)

For technical information & in Wisconsin: 715-848-2322
Store prices differ from mail order.

Oryx Software • 205 Scott St. • P.O. Box 1961 • Wausau, WI 54401



LDOS Utilities

*Expand the capabilities
of this popular disk operating system.*

Tim Daneliuk

T & R Communications Associates
4927 North Rockwell St.
Chicago, IL 60625

In this article, I'll review six utility programs that were designed specifically to run under LDOS (Logical Systems' disk operating system). FED, Filter Disk, Partitioned Data Sets, I/O Monitor, Memdisk, and Discater all enhance LDOS significantly, making it by far the best-supported DOS for the TRS-80 Models I and III. This is in part because the original authors of LDOS wrote most of the programs (FED, Filter Disk, and Partitioned Data Sets).

FED

FED (File Editor from Logical Systems Inc.) is a general-purpose file-oriented disk editor, which does not manipulate the disk at a sector or track level but rather at the file level. FED enables the advanced programmer to deal with disk files directly as

About the Author

Tim Daneliuk is an electrical engineer involved in research and product development for the medical electronics industry. T & R Communications Associates is a company he founded to provide technical writing and consulting services for the electronics industry.

they reside on the disk.

On entering the FED environment, you can choose between seeing a full-sector (256-byte) or a half-sector (128-byte) display. Either display is available at any time, but I prefer the half-sector display because it is more

**Each utility
program helps
make LDOS the
best-supported
DOS for the TRS-80.**

readable. These displays show each byte in a selected record of the disk file in both hexadecimal and ASCII (American Standard Code for Information Interchange). The displays include such information as the record number of the file being examined and the relative byte position within the file at which the cursor is pointing. The current command and any related information such as search strings are also displayed.

Once you have named the file to be edited and selected the display mode, you will have available a variety of

commands. FED offers a full complement of record position controls. You may move forward or backward one record, set the display to the beginning or end of a file, or go to a specific record number within the file. Once the record has been found, you can position the cursor over the specific byte and modify it by typing over the existing value with either hexadecimal or ASCII data. You can also have the program search for a specific hexadecimal or ASCII string, thereby enabling you to find one or more occurrences of a particular string in the file.

FED also has provision for explicitly dealing with the *load module format* found in LDOS-executable (/CMD) files. You may locate and calculate a hexadecimal load address and go to the next load block in a file. You can also convert a user-specified word in the file to its binary representation. Finally, FED has several printer-related commands: an entire file may be dumped to the printer, a top-of-form command may be sent to the printer, or just the contents of the screen edit buffer may be sent to the printer.

At a Glance

Name

FED

Type

General-purpose file-oriented editor

ManufacturerLogical Systems Inc.
11520 North Port Washington Rd.
Mequon, WI 53092
(414) 241-3066**Price**

\$40

Format

5¼-inch floppy disk

Language

Z80 machine language

Computer

TRS-80 Models I or III running under LDOS

Audience

LDOS owners

verts the ASCII character set to the BCD (binary-coded decimal) codes used in an IBM Selectric typewriter.

Logical Systems included two tables with this filter. One performs a translation from ASCII to the EBCDIC (extended binary-coded decimal interchange code) used in many mainframe computers. You might use this filter on the communications line to enable a TRS-80 using the LDOS LCOMM communications program to access a mainframe computer. The second translation table implements the Dvorak keyboard on the TRS-80 instead of the common QWERTY.

Several filters are included that are useful for printing or listing data and programs. LISTBAS/FLT formats a BASIC program, so that each statement within a multistatement line is indented and listed separately. This will give you a better idea of program structure. STRIP7/FLT removes the high bit from each character, a feature that is useful in listing files created by some editors that use the high bit for control information. This changes all characters outside the normal ASCII range into ASCII characters. STRIPCNT/FLT removes all control characters in an I/O path. One application of STRIPCNT/FLT is in listing word-processor files on the video screen. By eliminating the control characters, the program makes the file more readable.

With TITLE/FLT you can place a title at the top of each page in a printed program listing. You may optionally have a time and date appended to the title. You can convert all lowercase characters to uppercase and vice versa with UPPER/FLT and LOWER/FLT. You could convert uppercase text files to lowercase and use a word-processor program to manually capitalize the beginning of sentences, proper nouns, etc. SLASH0/FLT will be popular with owners of daisy-wheel printers because it issues a backspace and slash (/) after every zero character to distinguish it from the letter O. Daisy-wheel users will also find PAGEPAWS/FLT useful; it causes the printer to pause at the end of each printed page to allow a new sheet of paper to be inserted. Though

At a Glance

Name

Filter Disk

Type

A set of 14 I/O software filters to supplement those included with LDOS

ManufacturerLogical Systems Inc.
11520 North Port Washington Rd.
Mequon, WI 53092
(414) 241-3066**Price**

\$60

Format

5¼-inch floppy disk

Language

Z80 machine language (source code included)

Computer

TRS-80 Models I and III running under LDOS

Audience

LDOS owners

FED will be popular with the assembly-language programmer who wishes to make minor modifications to an assembled file. FED is efficient and user-friendly.

Filter Disk

Though LDOS comes with several useful I/O (input/output) path filters, these do not even begin to fully exploit LDOS. The Filter Disk package (from Logical Systems Inc.) provides you with 14 filters and, as an added bonus, assembly-language source code.

The most impressive filter is XLATE/FLT, which is a complete translation filter system and can be used for both input and output filtering. With XLATE, you can translate any or all of the ASCII characters to any other code by building a translation table using either the LDOS BUILD command or a word processor capable of generating ASCII files. You can enter the translation table values as hexadecimal numbers (e.g., 1F=2D) or as literal characters (e.g., W=r). You can also specify whether the translation in the I/O path is to take place during output, input, or both. You could, for example, write a translation filter that con-

incorporated in the printer filter provided with LDOS, a separate linefeed filter, LINEFEED/FLT, is also included on the filter disk to add or remove a linefeed after a carriage return. The filter on the disk occupies less memory, an advantage for those who do not need all the features the printer filter offers.

The remaining four filters serve a variety of purposes. MONITOR/FLT will change every control character in its I/O path to an alphanumeric symbol, and every character above hexadecimal 7F to an up-arrow (or left-bracket on some printers) character. MONITOR/FLT is similar to STRIPCNT/FLT except that MONITOR/FLT indicates which control characters are being sent to a particular device. The TRAP/FLT filter can prevent any one character from being sent through an I/O path. You might use this filter while listing disk files to trap a character that causes a dot-matrix printer to change the font sizes. Similarly, REMOVE/CMD will remove all occurrences of a particular byte in a disk file. Finally, the keyboard filter CALC/FLT will do hexadecimal/decimal/binary conversion and hexadecimal arithmetic while you are us-

At a Glance

Name

Partitioned Data Sets

Type

A file-management system that reduces the amount of disk space required for storage

Manufacturer

Misosys
POB 4848
Alexandria, VA 22303-0848
(703) 960-2998

Price

\$40 plus shipping

Format

5¼-inch floppy disk

Language

Z80 machine language

Computer

TRS-80 Models I and III running under LDOS

Audience

LDOS owners

library, you can conserve disk space.

With the implementation of PDS in LDOS systems, two types of files can be library members: executable (/CMD) or data files. The type of executable file PDS will accept is limited, however. First, a /CMD file must be in the proper LDOS load module format. If it is not, PDS will store it as usual, but when you try to execute that member, PDS will think it's a data file and generate the error message Load Module Format Error. The PDS manual mentions this problem but does not go into any real depth on fixing it. For this reason, PDS really should be regarded as a program for the more sophisticated user.

Another limitation of PDS is that LDOS filter programs that are stored in a library cannot be used. They must be copied from the PDS to a regular stand-alone filter file in order to be used in a FILTER command line. Similarly, data files are accessible only after they have been copied from the PDS into a standard LDOS data file.

PDS offers a great deal of versatility not normally found in microcomputer file management.

Despite these limitations, PDS is a very useful program. Its three main functions are to permit available disk space to be used more efficiently by combining files into a library, to simplify the process of making archival backups of crucial data, and to simplify and unclutter the disk directory by having files that are related stored in one PDS library. For example, I created a PDS library that contains my assembly-language development tools: an editor-assembler and two disassembler programs. They are all accessible to me as usual (all are /CMD-type files), and by putting them into one library, I freed up 1.5K bytes of disk space!

At a Glance

Name

I/O Monitor

Type

A program designed to intercept disk error messages and allow user-selected recovery options

Manufacturer

Logical Systems Inc.
11520 North Port Washington Rd.
Mequon, WI 53092
(414) 241-3066

Price

\$25

Format

5¼-inch floppy disk

Language

Z80 machine language

Computer

TRS-80 Models I and III running under LDOS

Audience

LDOS owners

ing another program. I incorporated this filter into my normal LDOS operation and find it particularly useful when writing assembly-language programs. It permits me to do the necessary base conversions and arithmetic right from the editor-assembler environment!

It is no great surprise that the Filter Disk is an excellent piece of software since it comes from the manufacturer of LDOS. The documentation is thorough, and the filters very usable.

Partitioned Data Sets

Partitioned Data Sets (PDS, from Misosys) is an interesting add-on file-management package for LDOS. The basic idea for PDS comes from mini-computer operating systems in which many small programs or data files are stored together in one disk file. The entire file is called a *library*, and each program or data set in the library is called a *member*. If each member were saved as a separate file, a lot of disk space would be wasted because the DOS has a minimum file size of 1 granule (1.25K bytes on a Model I and 1.5K bytes on a Model III). By combining small programs into one

The PDS program is itself a partitioned data set with eight members, which constitute the necessary programs to create and maintain PDS structures under LDOS. The BUILD command is used to create new partitioned data sets. Once this is done, members are added using the APPEND command. It is possible to determine what files are in the PDS and whether they are data or /CMD by using the DIR command. The LIST command enables you to list any individual member in a PDS library in either hexadecimal or ASCII. The KILL command leaves the member in the PDS but makes it unavailable for access. The COPY command transfers a PDS member to a regular LDOS /CMD or data file. The RESTORE command is used with files that have been killed to make them available again, while PURGE is used to actually remove killed members and reclaim the disk space.

PDS offers a great deal of versatility not normally found in microcomputer file management. The thorough documentation and features of PDS make it useful for most intermediate and advanced TRS-80 programmers.

At a Glance

Name
Memdisk

Type
Creates a pseudodisk in memory that can be used like a physical floppy-disk drive

Manufacturer
Logical Systems Inc.
11520 North Port Washington Rd.
Mequon, WI 53092
(414) 241-3066

Price
\$39

Format
5¼-inch floppy disk

Language
Z80 machine language

Computer
TRS-80 Models I and III running under LDOS

Audience
LDOS owners

memory. That part of memory is then treated like a physical floppy-disk drive, and the normal LDOS library commands can be used to access the "memdisk." This capability offers two advantages: first, it provides an extra disk drive to back up and copy files from one nonsystem disk to another. Second, because the memdisk is in memory, disk accesses to this drive are very fast. Consequently, certain kinds of programs can be substantially speeded up by putting their files on a memdisk. An ISAM (indexed sequential-access method) sorting routine could be made faster by putting its index file on a memdisk where it could be sorted much more rapidly.

When the Memdisk program is first enabled, you may specify how many sectors per granule to use and how many RAM (random-access read/write memory) "tracks" this memdisk is to have. If insufficient memory is available for the desired memdisk configuration, an error message appears, and the procedure is aborted. Otherwise, the memory to be used for

I use Memdisk to simplify the day-to-day DOS "housekeeping" chores.

the memdisk is verified with a short memory-checking utility, and control is returned to LDOS when this is finished. Thereafter, the memdisk appears to the system as a normal disk drive. The memdisk may be disabled at any time so that the memory it uses is returned to the system for general DOS use.

I use this program regularly to simplify the day-to-day DOS "housekeeping" chores. The documentation is good, and the program well designed.

Discater

Discater (from Softerware) is a general-purpose disk-cataloging program for LDOS. After loading the program into the TRS-80, you insert the disks to be cataloged one at a time

At a Glance

Name
Discater

Type
A general-purpose disk-cataloging program

Manufacturer
Softerware
16007 Miami Way
Pacific Palisades, CA 90272
(213) 459-3414

Price
\$39.95

Format
5¼-inch floppy disk

Language
Z80 machine language

Computer
TRS-80 Models I and III running under LDOS

Audience
LDOS owners

into the disk drive so their directories can be read. (The program also works with single-drive systems.) Once the catalog is compiled, you can elect to have the entire catalog listed on screen or sent to a printer. You can also search for a particular file to see on which disks it appears.

Discater is a useful program, but it has one deficiency: the documentation is rather sparse. This is not as severe a drawback as it might seem, however, because the program is menu-driven and self-prompting. In general, the program runs well, and I've found it to be a handy tool for locating files on my many disks.

Conclusion

Tandy has recently announced that LDOS will become Radio Shack's official programmer's DOS, as opposed to TRSDOS, which is the user's DOS. Radio Shack stores and computer centers may now display and sell LDOS, which will increase the already considerable popularity of this operating system. With the addition of the six utility programs reviewed here, you can substantially increase the usefulness of LDOS. ■

I/O Monitor

This program (from Logical Systems Inc.) is an error monitor designed to intercept errors generated during disk read or write operations. Normally when these kinds of errors occur, the screen displays an LDOS error message, and the program currently running aborts. With I/O Monitor installed, the error is intercepted, and you are notified as usual. Then you are given four choices: abort the program, continue the program, ignore the error, or retry the disk operation that forced the error. In this way, you have some chance of recovering from the error, or at least minimizing the damage done.

This program will find particular favor with owners of the TRS-80 Model I expansion interface. The disk controller is notorious for I/O errors, and I/O Monitor will make handling these errors much simpler and efficient.

Memdisk

The program Memdisk (from Logical Systems Inc.) sets up a pseudodisk drive in the TRS-80

Book Reviews

68000 Assembly Language Programming

Gerry Kane,
Doug Hawkins, and
Lance Leventhal
Osborne/McGraw-Hill
Berkeley, CA, 1981
577 pages, softcover
\$16.99

Reviewed by
Paul E. Hoffman
2109 Shattuck Ave.
Berkeley, CA 94704

As a programming manual, *68000 Assembly Language Programming* does an admirable job of teaching the basics of assembly language through the use of extremely clear charts and numerous examples. The book also presents a solid background in many of the computer concepts related to assembly-language programming.

With new 16-bit microcomputers appearing every month, it's important to have a manual that completely covers all aspects of programming the 68000. This book is one of the most complete assembly-language manuals available for any chip, and it's written so that a person experienced with other assembly languages can quickly grasp all the concepts unique to the 68000.

While many assembly-language manuals present a few program fragments used in conjunction with descriptions of specific operations, these authors decided to teach the language through complete programs. Because assembler directives are important to most assembly-language programming, the programs listed contain generalized directives. The authors teach the programming of the 68000 as a concrete skill, not an academic exercise.

After an overview of general assembly-language programming, the manual presents the principles of assemblers and provides examples of the common assembler directives. The book then jumps to the 68000 operations set. The set is divided into the categories of frequently, occasionally, and rarely used operations, so the beginner needn't think about too many different codes at a time. This separation makes the operations easier for the novice to learn and for the experienced programmer to remember.

The discussion of addressing modes is much more understandable in this book than in most others, and the drawings accompanying the text are excellent. Learning the concepts of the 68000's addressing modes is especially important for those of us who are more familiar with 8-bit processors. If you don't have a complete grasp of the addressing modes, you'll find it almost impossible to comprehend the concepts of programming in assembly language.

The manual provides over 50 programming examples. The requisite arithmetic manipulations are given, but also included are many examples of character- and string-handling programs. A chapter on handling lists and tables, which the 68000 does quite easily, is another excellent feature.

For the advanced programmer, chapters on parameter passing, subroutines, interrupts, and exceptions prove to be a useful resource. The manual also has a unique feature for assembly-language programmers—a long chapter on interfacing the 68000 with the 6821 peripheral interface adapter. (Most authors have avoided this discussion because of its highly technical nature.) The procedure is

clearly explained, and most programmers, even those with out I/O (input/output) programming experience, should be able to understand it.

The rest of the manual deals with the art of programming in general. The two chapters on problem definition and program design do not deal with assembly language at all, but the chapters on debugging, testing, and maintenance give clear examples and helpful hints for programming with the 68000. The chapter on documentation is outstanding and should be required

reading for all assembly-language programmers. The manual also includes the usual appendixes and a full index.

Unfortunately, the authors did not explore the many differences and similarities between the 68000 and other common chips. Nevertheless, they have presented a complete and well-written manual for the 68000, one that will remain useful for the life of the chip. The manual is quite helpful for the experienced assembly-language programmer and basic enough for the novice. ■

BYTE's Bits

Customs Service to Seize Bogus Apples

The U. S. Customs Service has warned international travelers that counterfeit Apple II computers and related materials violating recorded copyrights or trademarks of Apple Computer Inc. are subject to seizure if brought into this country. Custom agents have seized illegal copies of Apple computers and software entering the U. S. through several West Coast locations and Honolulu.

Customs officials note that suspect machines are identical in size and appearance to genuine Apples, are normally tan in color, and bear such names as Apple II, Orange, Apollo II, Golden, PET TK 1000, and AP II. Some of these units have no brand name, and foreign values of these machines vary from \$100 to \$450.

Only two overseas subsidiaries of Apple Computer are authorized to produce and sell Apple manuals and software: Apple Computer International of Singapore

and Apple Computer Ltd. of the Republic of Ireland.

TI Computer Courses Earn College Credit

The American Council on Education has granted college credit recognition to eight computer training courses offered by the Texas Instruments Education and Development Center. Texas Instruments employees and customers can now earn from 1 to 3 semester hours of college credit while taking one of four software courses: Introduction to TI Pascal, Advanced TI Pascal, Database Management System, and TI Assembly Language. In addition, four courses on computer maintenance are available to Texas Instruments staff members for college credit.

For further information, contact Texas Instruments Inc., Education and Development Center, Attn: Registrar, M/S 2220, POB 2909, Austin, TX 78769. ■

The Magic of the Monte Carlo Method

Roger C. Millikan
5475 Toltec Dr.
Santa Barbara, CA 93111

The Monte Carlo method is a mathematical technique that uses sequences of random numbers to solve problems that might not be solvable otherwise. It is well-suited to microcomputers, especially because most language systems provide a random-number-generating function. Monte Carlo programs tend to be short and simple, yet they provide powerful tools for solving what would otherwise be difficult problems. In this article I will illustrate how the method works by using it to solve two different types of problems.

The first problem involves simulating a physical process with random behavior built into it. For example, consider the diffusion of neutrons through a solid. A given neutron moves in a straight line until it collides with an atom. Then it is deflected at some random angle and proceeds on to the next collision. The result is a zig-zag path of random motions. This can easily be simulated by the Monte Carlo method. Applications such as this are fundamental to the design of atomic reactors.

The Monte Carlo method also offers a way to find the area of odd-shaped regions or the volume of odd-shaped solids. It is in this type of problem that the method seems truly magical. You start with random and unpredictable sets of numbers but soon arrive at a definite answer. This is possible because a collection of random processes may have some average behavior that is constant. Consider flipping a coin 10,000 times. If you flip it once more, no one can predict for certain whether it will come down heads or tails. But you can predict with confidence that approximately 5000 of the previous flips turned up heads.

With the Monte Carlo method, you make use of the average behavior of your random numbers to provide the desired, definite result. Of course, averages are subject to some statistical fluctuation, hence the result is only approximate. But by using more and more random-number trials, you can make the Monte Carlo result more and more accurate. This is where the speed of computers becomes important. A microcomputer can go through a simple looping calculation 10,000 times without exhausting your patience. Nevertheless, you should keep in mind that Monte Carlo calculations give only approximate answers.

The Drunk and the Lamppost

The neutron problem I mentioned earlier has an interesting analogy. Picture a drunk man clinging to a lamppost for support. He decides to head for home and lurches off in a random direction. After staggering some number of steps (no more than 10, for he is quite far gone), a dizzy spell causes him to spin around and head off in a different direction. After 10 of these staggers, the poor fellow collapses to the pavement to sleep it off. (Figure 1 shows several possible paths of the drunk.) Now let's ask a curious question. On the average, how far from the lamppost is the drunk when he collapses?

This question can be answered easily by running a Monte Carlo simulation of the drunk's walk on a microcomputer. After each simulation, we record the distance of the drunk from the lamppost. Averaging the results for 1000 simulations gives a fair approximation for the

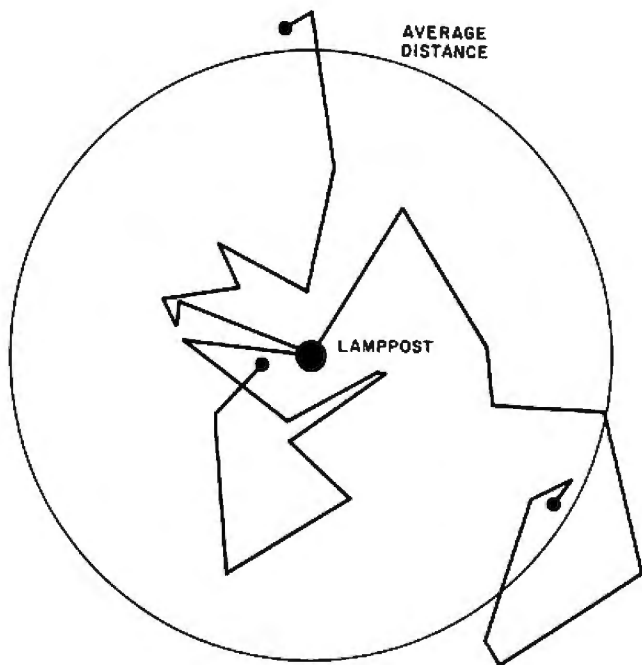

Figure 1: Paths traveled by three drunks upon leaving a lamppost (central spot). Each staggers and lurches 10 times, ending at the location marked by the filled circle at the end of his path. The large circle marks the average radial distance such drunks would travel as calculated by the Monte Carlo program of listing 1.

answer. Listing 1 shows a program in Microsoft BASIC that simulates 1000 drunken walks, each with 10 lurches, and averages the 1000 results. The circle in figure 1 shows the average distance from the lamppost as computed by the program.

Few people care how far the average drunk staggers from a lamppost, but many care how far neutrons travel in radiation shields, and the two are essentially the same problem. At first it may have seemed difficult to solve, but we have seen that the Monte Carlo method makes it easy. This example also exhibits a characteristic that many Monte Carlo programs share: they have a simple loop that is traversed many times. And because there is no need to store many intermediate results, memory requirements are fairly small.

Finding Areas and Volumes

The second type of Monte Carlo problem is well illustrated by the following example. Suppose we want to find the area under the curve $y = x^2$ when x varies from 0 to 1. This is the shaded area of figure 2. If you know integral calculus, you can find the exact answer at once. It is $\frac{1}{3}$. But if you don't know calculus, the problem is extremely difficult.

The Monte Carlo approach to this problem is akin to throwing darts randomly at the boxed-in area of figure 2. Then we count the number of darts that land in the shaded area (under the curve $y = x^2$) and divide this number by the total number of darts thrown. This gives us an approximation of the area under the curve. The more darts thrown, the better the approximation.

Listing 1: The Staggering Drunk problem. This BASIC program uses the Monte Carlo method to calculate the average distance from the lamppost that a drunk will traverse before collapsing, after 10 lurches in random directions.

```

1000 REM Monte Carlo demonstration
1010 D1 = 0
1015 N = 1000
1020 FOR J = 1 TO N
1030   X = 0: Y = 0
1040   FOR K = 1 TO 10
1050     GOSUB 2000
1060     NEXT K
1070   D1 = D1 + SQR((X * X) + (Y * Y))
1080   NEXT J
1090 PRINT "Avg radial distance is"; D1/N
1100 STOP
2000 REM
2010 REM Subroutine gives new x, y with
2020 REM random direction and distance
2030 REM (0 to 10) from old x,y
2040 REM
2050 R = 10 * RND(R)
2060 T = 2 * 3.14159 * RND(T)
2070 X = X + (R * COS(T))
2080 Y = Y + (R * SIN(T))
2090 RETURN

```

The BASIC program shown in listing 2 follows this procedure, except that, instead of throwing darts, the program uses calls to the random-number generator to provide the x, y coordinates for the dart locations. In figure 2, black dots show the locations for 30 points generated in one run of the program. The approximate result for the area in this run was 0.37.

As I mentioned before, Monte Carlo results become more accurate as the number of trials increases. This is shown dramatically in figure 3, which shows the results of several runs of the program in listing 2 using varying numbers of darts or trials. When only 10 trials per run are used, the results for each run vary wildly. But for 10,000 trials per run, the results are reproducible to within 1 percent. Herein lies the major drawback of the Monte Carlo method. For each extra digit of precision in your result, you must do 100 times as many trials. Thus to get a result that has 100 times the accuracy of the result shown for 10,000 trials, we would need 1 billion trials. Even though computers are fast, running through a loop that many times could take weeks. This relationship between the number of trials and the statistical fluctuation of the results thus limits the precision of the Monte Carlo method.

Given this problem, why should anyone be interested in the Monte Carlo method? First, it is generally easy to apply, no matter how complex the problem of interest. The problem may not exhibit as simple a curve as $y = x^2$. Indeed, the curve may be so complicated that even the methods of integral calculus fail. Yet the same short Monte Carlo program can approximate the desired

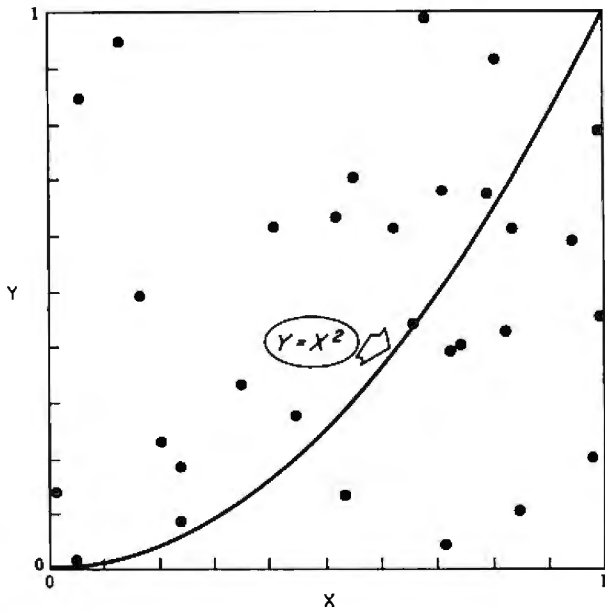

Figure 2: Plot of 30 random x,y points giving a Monte Carlo approximation of the area under the curve $y = x^2$ in the unit square. The area (A) can be estimated as points under the curve divided by total points. In this instance $A = \frac{11}{30} = 0.37$. The true result is 0.333.

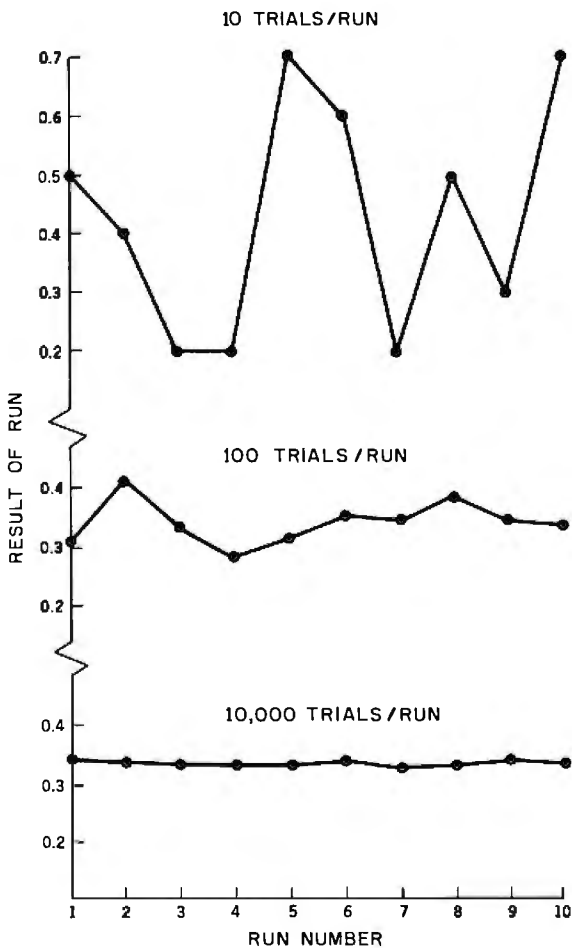

Figure 3: Results of 10 different Monte Carlo runs to find the shaded area of figure 2 showing the statistical fluctuation for three different numbers of trials per run. The exact result is 0.333.

Listing 2: A BASIC program to calculate the area under a curve. In this case the curve is the function $y = x^2$. The program uses the Monte Carlo method with a varying number of tries, from 10 to 10,000. At the bottom of the listing is a sample of the output from the program.

```

1000 DEF FNA(X) = X * X
1010 N = 10 : GOSUB 2000
1020 N = 100 : GOSUB 2000
1030 N = 1000 : GOSUB 2000
1040 N = 10000: GOSUB 2000
1050 STOP
2000 REM Monte Carlo integration
2010 REM subroutine. "N" is the
2020 REM number of points to try.
2030 REM FNA(x) is the defined
2040 REM function  $y = x * x$ .
2050 REM
2060 U = 0
2070 FOR I = 1 TO N
2080 X = RND(X): Y = RND(Y)
2090 IF Y <= FNA(X) THEN U = U + 1
2100 NEXT I
2110 PRINT "For"; N; "tries,"
2115 PRINT " the integral is"; U/N
2120 RETURN
3000 END

```

Output:

```

For 10 tries,
  the integral is .4
For 100 tries,
  the integral is .35
For 1000 tries,
  the integral is .341
For 10000 tries,
  the integral is .3415

```

result. Second, the Monte Carlo method can be extended to three- and higher-dimensional cases with ease. Last, the accuracy and memory of microcomputers are well matched to the natural accuracy and memory requirements of the Monte Carlo method.

Looking toward the future, I see an exciting prospect: Monte Carlo programs have a natural parallelism that might be implemented on clusters of microcomputer chips. This could reduce, in some cases, the excessive amount of time needed for precise results. For example, in a problem where random x , y , and z coordinates are needed for two particles, 1 and 2, we might have six 1-chip computers generating all these random numbers in parallel. For more particles, we could plug in more chips. On a sequential machine, the time requirements for problems with many particles tend to explode. The Monte Carlo method and its natural parallelism offers a possible way around this. Perhaps we can look forward to systems where you plug in a new processor for each new particle or dimension in a problem. ■

Book Reviews

A Practical Introduction to Computer Graphics

Ian O. Angell
Halstead Press
New York, 1981
146 pages
softcover, \$16.95

Reviewed by
John B. Harrell III
Quarters 192-A
PTSMH Naval Shipyard
Portsmouth, NH 03801

In the few short years that microcomputers have been around, many books have been written about computer graphics. Unfortunately, most of them have focused on game

applications or specific computers. *A Practical Introduction to Computer Graphics* by Ian Angell takes a different approach. In addition to addressing the various aspects of computer graphics, the author offers insight into the theory and mathematics behind their creation.

As its title implies, the book is a primer on methods of creating computer graphics. The text is accompanied by examples of graphics routines that you can easily alter to suit your needs. Angell also provides the basic information you'll need to generate such complex graphics structures as detailed machine patterns, various data presentations, and diagrams.

The book has twelve chap-

ters that progress in a logical order and increase in difficulty in terms of the concepts and the examples they present. The first chapter includes such useful information as an informal introduction to two-dimensional graphics and definitions of some of the terms and routines you will encounter throughout the book.

The author addresses graphics by way of an introduction to the mathematics of two-dimensional geometry, and his presentation is logical and easy to understand. Still, you must be somewhat familiar with the mathematical precepts he presents; the detailed derivation found in a typical mathematics text, for example, is omitted. The pre-

cepts are essential because they form a basis for the underlying theory that Angell delineates throughout the remainder of the book. He uses cleverly designed examples to develop and reinforce each precept.

Angell explains each of the two-dimensional space transformations—translation, change of scale, and rotation—clearly and concisely. In addition, he develops the matrix representation necessary to achieve each transformation. He also gives you a method that combines transformations by multiplying transform matrices.

After discussing the tools for producing complex graphics structures, he explains how you can clip a graphics picture

Marymas INDUSTRIES, INC.

In Texas Orders
Questions & Answers
1-713-392-0747

22511 Katy Freeway
Katy (Houston) Texas 77450

To Order
1-800-231-3680
800-231-3681

SAVE BIG DOLLARS ON ALL TRS-80[®] HARDWARE & SOFTWARE

TRS-80[®] BY RADIO SHACK. Brand new in cartons delivered. Save state sales tax. Texas residents add only 5% sales tax. Open Mon.-Fri. 9-6, Sat. 9-5. We pay freight and insurance. Come by and see us. Call us for a reference in or near your city. Ref: Farmers State Bank, Brookshire, Texas.

WE OFFER ON REQUEST

- Federal Express (Overnight Delivery)
- Houston Intercontinental Airport Delivery (Same Day)
- U.P.S. BLUE (Every Day)
- References from people who have bought computers from us probably in your city

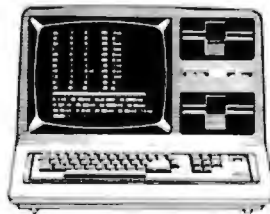

In stock TRS-80 Model II and III

No Tax on Out of Texas Shipments!

Save
10% 15%

OR MORE

Reserve Your Model 16 Today
Telex 77-4132 (Fleks Hou)

WE ALWAYS OFFER

- NO extra charge for Master Card or Visa.
- We use Direct Freight Lines. No long waits.
- We always pay the freight and insurance
- Toll free order number
- Our capability to go to the giant TRS-80[®] Computer warehouse 5 hours away, in Ft. Worth, Texas, to keep you in stock.

JOE McMANUS

* TRS-80 is a Registered Trademark of Tandy Corp

ED McMANUS



to fit within the boundaries of a physical device. He also describes how to cover a certain area of the graphic surface to allow for the addition of text or other information without interference from the graphic pattern.

Another chapter introduces the reader to coordinate geometry in three-dimensional space. Here, too, Angell makes a point to introduce new mathematical concepts as warranted to explain the principles involved.

The concepts of coordinate transformation are explained through a discussion of three-dimensional geometry. Once the author establishes these transformations for three-dimensional space, he explains how to create orthographic projections of three-dimensional objects onto a two-dimensional viewing surface.

Angell also includes a discussion of perspective and stereoscopic views. The orthographic projection of an object in three-dimensional space does not reflect real-world perspective, in which all parallel lines seem to meet on the visual horizon. Stereoscopic views, on the other hand, account for the slight differences in perspective seen by the right and left eyes.

One of the book's most interesting sections concerns the development of hidden line removal algorithms. The author calls the examples he uses "wire figures." The function of hidden line removal algorithms is to make these wire figures resemble solid objects by removing the lines that would not normally be visible.

The remainder of the book focuses on the procedures you

would need to produce complex graphic structures, frame-by-frame animation for computer movies, and other more ambitious projects.

In general, *A Practical Introduction to Computer Graphics* is both well written and well conceived. The graphics examples, which are explicit and well documented, could easily be integrated into a sophisticated graphics package. The book is also an excellent refresher in the mathematics that graphics projects require.

This review would be incomplete, however, without mention of the serious flaws that detract from the book's usefulness. To begin with, the graphics examples are in FORTRAN-IV. In addition, the author has used the Calcomp graphics package, which has limited use among

microcomputer users.

FORTRAN-IV clearly restricts the use of the graphics examples to the small number of microcomputer users who have access to a FORTRAN compiler. Even if you converted the FORTRAN source text to BASIC or Pascal, the lack of access to generalized plotting routines used in the examples would require a considerable amount of programming.

Having worked with the graphics capabilities of a high-resolution system like Technics 4052, I fully appreciate the flexibility that the Calcomp plotting routines offer. Unfortunately, only a few high-resolution graphics systems offer such flexibility, so the excellent examples in this book will probably remain untested by many readers. ■

General Software

Mailing Address:
1454 S. 25th St.
Terre Haute, IN 47803
WE HONOR
VISA and MASTERCHARGE

TOLL FREE - Outside Indiana
1-800-457-0517
ORDER DESKS
(812) 234-9421

Best Selection Best Service

Write for our famous CATALOG. Contains many items not in ad. Still only \$1.00 (refund with purchase) Outside US add \$10 plus Air Parcel Postage. Add \$3.50 postage and handling per each item. Indiana residents add 4% sales tax. Allow 2 weeks on checks. COD add \$3.00 per item. Prices subject to change without notice. All items subject to availability.

	Disk Manual	Manual Only
ARTIFICIAL INTELLIGENCE		
Dental (PAS-3)		\$849/40
Medical (PAS-3)		\$849/40
ASHTON-TATE		
*dBASEII		\$525/50
BALCONES		
The Boss Fin. Acc. System		\$1750
BYROM SOFTWARE		
*BSTAM		\$149
*BSTMS		\$149

COMPUTER CONTROL	
*Fabs (B-Tree)	\$159/35
Ultrasoft	\$159/35
CONDOR COMPUTER	
Condor II	\$515/55
Condor II	\$795/55
DIGITAL RESEARCH	
CP/M	
2.2 Intel MDS-800	\$149/35
Northstar (Horizon)	\$149/35
Micropolis	\$169/35
TRS Model II	\$159/45
CB-80	\$429/45
FL-1-80	\$429/50
CBasic2	\$ 98/30
EPIC COMPUTER	
*Super vyz	\$ 89/25
FAIRCORN	
*Micro B+	
(Specify language)	\$229/30
FINANCIAL PLANNING	
*Mini Model	\$429/50
FRIENDS	
ACCESS 80 I	\$249/50
ACCESS 80 II	\$429/50
FRONTIER SOFTWARE	
Professional	
Time Accounting	\$549/50
General Subroutine	\$269/50
Application Utilities	\$439/50
ISA	
Spellguard	\$229/30
SP/Law	\$109
PASCAL LANGUAGE	
Pascal Z	\$349/40
Pascal MT + V5.5	\$429/40
Compiler	\$316/25
SPP Only	\$165/15
KEY BITS	
Wordsearch	\$179/50
String 80	\$ 84/25
String 80 (Source)	\$279
UNICORN	
Final Word	\$255
LEXISOFT	
*Spellbinder	\$349/55
MICRO AP	
Selector IV	\$249/40
Selector V	\$449/50
SBasic	\$269/40
MICRO TAX	
*Level I	\$249
*Level II	\$995

*Level III	\$749
*Combo II+III	\$1495
Microsoft 5.3	49
Run time module	
MICRO PRO*	
Wordstar	\$295/60
Call for NEW LOW PRICES	
MICROSOFT	
Basic-80	\$298
Basic Compiler	\$329
Fortran-80	\$349
Cobol-80	\$629
M-Sort	\$124
Macro-80	\$144
Edit-80	\$ 84
MuSimp/muMath	\$224
MuLisp-80	\$174
NORTHWEST ANALYTICAL	
*Statpak	\$409/45
OASIS	
*"The Word"	\$ 75
ORGANIC SOFTWARE	
*Textwriter III	\$111/25
*Datebook	\$269/25
*Milestone	\$269/30
PEACHTREE* SOFTWARE	
General Ledger	\$399/60
Accounts Receivable	\$399/60
Accounts Payable	\$399/60
Payroll	\$399/60
Inventory	\$399/60
Mailing Address	\$399/60
for PB Version	add \$119
Series 6-Peachtree	
CPA	\$799/60
Property Mgt	\$799/60
Passive Payroll	\$449/60
Series 7-Peachtree	
Sales Tracker	\$3049/60
AR-Sales Analysis	\$1299/60
Inventory	\$799/40
Order Entry	\$699/40
REDDING GROUP	
*Lynx	\$199/25
SORCIM	
*Pascal/M Z80	\$349/40
Pascal/M 86/88	\$449/40
*Act 65	\$149/20
*Act 68	
*Act 69	
*Act 86/88	\$149/25

*Trans 86	\$119/25
*Supercalc	\$269
SOUTHERN COMPUTERS	
Call for our unbeatable low prices.	
STRUCTURED SYSTEMS GROUP	
GL, AR, AP, PR, OE	\$849/50
Call for others	
SUPERSOFT	
*Diagnostic II	\$ 84/20
*Forth	\$149/30
*SSS Fortran	\$219/30
*Fortran w/RATFOR	\$289/35
*C Compiler	\$175/20
*Tiny Pascal	\$ 80/25
*Disk Doctor	\$ 84/20
*Term I	\$129/25
Term II	\$169/25
Z8000 Xassembler	\$449/35
Games & Others less 10%	
WHITESMITHS	
C Compiler	\$700/40
Pascal (incl C)	\$900/45
IBM PERSONAL COMPUTER	
Wordstar 3.2	\$309/60
Mailmerge	\$109/25
Supercalc	\$269/NA
Viscalc (256K)	\$229/NA
Optimizer	\$200/NA
Supersoft C - CP/M86	\$500/NA
Peachtree	
3 Pak GL, AP, AR	\$595
Final Word	\$265
Condor I, II, III	CALL
Statpak	\$439
BSTAM	\$149
Move-It	\$129
Easy Writer II	\$315
Easy Speller	\$155
Easy Filer (dBase mgr.)	\$335
Spellbinder	\$355/49
APPLE II DOS	
Word Handler II	\$155/49
Broderbund Software	
General Ledger (w/ A/P)	\$435
Payroll	\$325
Professional Easywriter	\$155
Mig. Inventory and Control Program	
T1990, 300 Meg. storage required	
Distributed in Cobol object code	
Call for Info	\$20000/NA
Write for catalog (\$1.00) and other listings	

* Available for Apple with Softcard

7

EAGLE

64K Ram
780 KB Disk Storage
Word Processing, Ultracalc CP/M
C-Basic Software
Smith Corona TP 1
Letter Quality Printer
\$2995.00
Retail Value \$4895.00
EAGLE 1600... CALL

NEC COMPUTERS

8001A \$729.00
8031 \$729.00
8012 \$549.00

PRINTERS

8023 \$499.00
7710/7730 \$2399.00
3510/3530 \$1599.00

MONITORS

JB-1260 \$129.00
JB-1201 \$159.00
JC-1201 \$319.00
JC-1203 \$729.00

TELEVIDEO TERMINALS

910 \$579.00
912C \$699.00
920C \$749.00
925C \$749.00
950 \$950.00

TELEVIDEO COMPUTERS

800A \$1319.00
802 \$2649.00
802H \$4695.00
806 \$5495.00
816 \$9495.00
803 CALL
1603 CALL

TIMEX SINCLAIR 1000

\$89.99



16K Memory Module \$44.95
Vu-Calc \$17.95
Super Math \$12.95
Check Book Manager \$13.95
The Organizer \$14.95
The Budgeter \$13.95
Stock Option \$14.95
Loan & Mortgage Amortizer \$12.95

MONITORS

AMDEK

100 B & W \$74.95
300G \$169.00
300A \$179.00
Color I \$339.00
Color II \$699.00
Color II A \$799.00
Color III \$399.00
Color IV CALL

BMC

12" Green \$79.99
13" Color 1401 (Mid Res.) \$369.00
9191U 13" \$329.00

ZENITH

ZVM 121 \$99.00

SHARP

Sharp 13" Color TV \$275.00

PANASONIC

TR-120MIP (High Res. Green) \$159.00
CT-160 Dual Mode Color \$299.00

HEWLETT PACKARD



\$209

HP 41C \$149.00
HP 10C \$69.00
HP 11C \$79.00
HP 12C \$114.00
HP 15C \$109.00
NEW 16C \$114.00

PERIPHERALS

HP41 Card Reader \$144.00
HPIL Module \$99.00
HPIL Cassette \$449.00
HPIL Printer \$419.00
Quad Memory Module \$64.00
Time Module \$64.00
Extended Function Module \$64.00

SHARP PC-1500 POCKET COMPUTER \$209

CE 150 Printer, Plotter and
Cass. Interface Unit \$172.00
CE 152 Cass. Recorder \$69.00
CE 155 8K Ram
Expansion Module \$94.00

HP 85 \$1969

HP 125 \$1999.00
HP 85 16K Memory Module \$169.00
5 1/4" Dual Floppy Disk \$1799.00
Hard Disk w/Floppy \$4349.00
Hard Disk \$3549.00
"Sweet Lips" Printer \$1219.00
80 Column Printer \$649.00

PRINTERS

SMITH CORONA

TP 1 \$599.00

C. ITOH (TEC)

Starwriter (F10-40CPS) \$1399.00
Printmaster (F10-55CPS) \$1749.00
Prowriter 80 Col. (Parallel) \$499.00
Prowriter 80 Col. (Serial) \$629.00
Prowriter 2 (132 Col.) \$799.00

OKI DATA

82A \$429.00
83A \$659.00
84 (Parallel) \$1079.00
84 (Serial) \$1199.00

IOS

MicroPrism \$649.00
132 (Fully Configured) \$1599.00
80 (Fully Configured) \$1399.00
Call for other configurations.

STAR

Gemini 10 \$379.00

DAISYWRITER

Letter Quality 1049.00

QIABLO

620 \$1179.00
630 \$1849.00

NEC

3550 PRINTER... \$2099

PERCOM DRIVES

5 1/4" 160K Disk Drive \$249.00
5 1/4" 320K Disk Drive \$299.00

AMDEK

310A Amber Monitor \$179.00
310G \$179.00
Amdisk (3 1/4" Drive) \$729.00
DXY Plotter \$759.00
Color II \$699.00

SOFTWARE

I.U.S. Easywriter II \$249.00
I.U.S. Easyspeller \$129.00
Peach Package (GL/AP/AR) \$419.00

PROFESSIONAL

SOFTWARE

IBM/PC Word Processing \$319.00

MOOEMS

HAYES

Smart \$239.00
Smart 1200 (1200 Baud) \$549.00
Chronograph \$199.00
Micromodem II (with Term) \$309.00
Micromodem 100 \$309.00

NOVATION

Cat \$144.00
D-Cat \$159.00
212 Auto Cat \$589.00
Apple Cat II \$279.00
212 Apple Cat II \$609.00

CALL for Price and Availability on
New **NOVATION** Cat 103, 103/212
and J-Cat.

ANCHOR

Mark I (RS-232) \$79.00
Mark II (Atari) 79.00
Mark III (TI-99) 109.00
Mark IV (CBM/PET) \$125.00
Mark V (OSBORNE) \$95.00
Mark VI (IBM-PC) \$179.00
Mark VII (Auto Answer Call) \$119.00
TRS-80 Color Computer \$99.00
9 Volt Power Supply \$9.00

commodore

8032 \$1039.00
CBM 64 CALL
4032 \$749.00
8096 Upgrade Kit \$369.00
Super Pet \$1499.00
2031 \$469.00
8250 Dbl. Sided Disk Drive \$1699.00
D9060 5 Meg. Hard Disk \$2399.00
D9060 7.5 Meg. Hard Disk \$2699.00
8050 \$1299.00
4040 \$969.00
8300 (Letter Quality) \$1549.00
8023 \$599.00
4022 \$399.00
New Z-Ram, Adds CP/M & 64K \$549.00
The Manager \$209.00
Magis CALL
Word Pro 5 Plus \$319.00
Word Pro 4 Plus \$299.00
Word Pro 3 Plus \$199.00
The Administrator \$379.00
Info Pro Plus \$219.00
Power \$79.00
CBM 8032 Dust Cover \$14.99
CBM 8050/4040 Dust Cover \$10.99

computer mail order east
800-233-8950

IN PA. CALL (717) 327-9575, 477 E. THIRD ST., WILLIAMSPORT, PA. 17701

In stock items shipped same day you call. No risk, no deposit on C.O.D. orders. Pre-paid orders receive free shipping within the continental United States with no waiting period for certified checks or money orders. Add 3% (minimum \$3.00) shipping and handling on all C.O.D. and Credit Card orders. NV and PA residents add sales tax. All items subject to availability and price change. **NOTE:** We stock manufacturer's and third party software for most all computers on the market! CALL TODAY FOR OUR NEW CATALOGUE.

FRANKLIN



ACE 1000
ACE 10 with Controller Card
ACE Writer Word Processor
CALL...
FOR SYSTEM PRICE!
ACE 1200.....CALL

PERCOM

DISK DRIVES FOR ATARI

- AT 88-S1... \$399.00
- AT 88-A1.... \$289.00
- RFD 40-S1... \$539.00
- RFD 40-A1... \$329.00
- RFD 40-S2... \$869.00
- RFD 44-S1... \$659.00
- RFD 44-S2... \$999.00



RANA DISK DRIVES

Call for price and availability on the new Rana Disk Drives for The Apple and Franklin Computer Systems.

ATARI*

HOME COMPUTERS



400

- 16K.....\$199
- 32K.....\$274*
- 48K.....\$359*

*Non-Atari Ram

- 410 Recorder \$74.00
- 810 Disk Drive... \$429.00
- 822 Printer \$269.00
- 825 Printer \$589.00
- 830 Modem \$159.00
- 820 Printer \$259.00
- 850 Interface... \$169.00
- CX40 Joy Sticks (pair) . \$18.00
- CX853 Atari 16K Ram..... \$77.95



800

48K.....\$499

New low price effective January 1, 1983.

Call for Price and Availability of the NEW
64K ATARI 1200

- Axlon Ramdisk (128K) \$429.95
- Intec 48K Board . \$159.00
- Intec 32K Board . \$74.00
- One Year Extended Warranty. \$70.00
- CX481 Entertainer Package... \$69.00
- CX482 Educator Package... \$130.00
- CX483 Programmer Package... \$54.00
- CX484 Communicator Package... \$344.00

VISICORP

for Apple, IBM & Franklin

- Visidex... \$189.00
 - Visifile... \$189.00
 - Visiplot..... \$159.00
 - Visiterm..... \$89.00
 - Visitrend/Plot..... \$229.00
 - VisiSchedule... \$229.00
 - Desktop Plan... \$189.00
 - Visical(Apple II, Atari,CBM,IBM). \$179.00
- Visicorp prices for IBM may vary slightly.

CONTINENTAL

- Home Acctn.(Apple/Franklin)... \$59.00
- Home Accountant (IBM)..... \$119.00
- 1st Class Mail (Apple/Franklin) ... \$59.00

BIRIUS

- Free Fall... \$24.00
- Beer Run... \$24.00
- Snake Byte... \$24.00
- Space Eggs... \$24.00
- Sneakers... \$24.00
- Bandits... \$28.00

BRODERBUND

- Apple Panic..... \$23.00
- David's Magic... \$27.00
- Star Blazer..... \$25.00
- Arcade Machine... \$34.00
- Choplifter... \$27.00
- Serpentine..... \$27.00

INFOCOM

- Deadline..... \$35.00
- Star Cross... \$29.00
- Zork I..... \$29.00
- Zork II or III..... \$29.00

MPC

- Bubdisk (128K Ram)..... \$719.00

AXLON

- Ram Disk (Apple/Franklin)..... CALL

Call for Price on
VIC 64

Peripherals and Software.

PROFESSIONAL SOFTWARE
Word Processing for VIC 64.... \$79.95

U-SCI



MICRO-SCI

DISK DRIVES FOR APPLE & FRANKLIN

- A2... \$299.00
- A40... \$349.00
- A70... \$459.00
- C2 Controller... \$79.00
- C47 Controller... \$89.00

FLOPPY DISKS

MAXELL

- MD I (Box of 10)... \$32.00
- MD II (Box of 10)... \$44.00
- FD I (8")... \$40.00
- FD II (8" DD)... \$50.00

VERBATUM

- 5 1/4" SS DD... \$26.00
- 5 1/4" DS DD... \$36.00

ELEPHANT

- 5 1/4" SS SD... \$19.99

VIC 20

\$179.



- VIC 20 Dust Cover... \$9.99
- VIC 1530 Datassette..... \$69.00
- VIC 1540 Disk Drive..... \$339.00
- VIC 1541 (64K Disk Drive)..... CALL
- VIC 1525 Graphic Printer..... \$339.00
- VIC 1210 3K Mem. Exp..... \$32.00
- VIC 1110 8K Mem. Exp..... \$53.00
- VIC 1111 16K Mem. Exp... \$94.00
- VIC 1011 RS232C Term. Interface.. \$43.00
- VIC 1112 IEEE-488 Interface... \$86.00
- VIC 1211 Super Expander..... \$53.00
- VIC Mother Board..... \$99.00

SOFTWARE FOR ATARI

ATARI

- Pac-Man... \$33.00
- Centipede..... \$33.00
- Caverns of Mars... \$32.00
- Asteroids... \$29.00
- Missile Command... \$29.00
- Star Raiders... \$35.00
- Galaxian... \$33.00
- Defender... \$33.00

ON-LINE

- Jawbreaker... \$27.00
- Softporn... \$27.00
- Wizard and the Princess... \$29.00
- The Next Step... \$34.00
- Mission Asteroid... \$22.00
- Mouskattack..... \$31.00
- Frogger... \$31.00
- Cross Fire (ROM)..... \$36.00

SYNAPSE

- File Manager 800+..... \$69.00
- Chicken... \$26.00
- Dodge Racer... \$26.00
- Synassembler... \$30.00
- Page 6... \$19.00
- Shamus... \$26.00
- Protector... \$26.00
- Nutilus... \$26.00
- Slime... \$26.00
- Disk Manager... \$24.00

DATASOFT

- Pacific Coast Highway..... \$25.00
- Canyon Climber..... \$25.00
- Tumble Bugs..... \$25.00
- Shooting Arcade..... \$25.00
- Clowns and Balloons..... \$25.00
- Graphic Master..... \$30.00
- Graphic Generator... \$13.00
- Micro Painter... \$25.00
- Text Wizard..... \$79.00
- Spell Wizard..... \$64.00
- Bishop's Square... \$25.00
- Sands of Egypt... \$25.00

APX

- Text Formatter... \$18.50
- Family Budgeter... \$18.50
- Eastern Front... \$24.00
- Family Cash... \$18.50
- Jukebox... \$13.00
- Downhill... \$18.50
- Outlaw... \$18.50
- Holy Grail... \$24.00
- Player Piano... \$18.50
- Keyboard Piano... \$18.50
- Number Blast... \$13.00
- Frogmaster... \$18.50
- 747 Land Simulator... \$18.50
- Word Processor..... \$40.00

EPYX

- Crush, Crumble & Chomp... \$24.00
- Crypt of the Undead... \$24.00
- Curse of Ra... \$16.00
- Dates tones & Ryn..... \$16.00
- Invasion Orion... \$19.00
- King Arthur's Heir... \$24.00
- Morloc's Tower... \$16.00
- Rescue a Knight... \$24.00
- Ricochet... \$16.00
- Star Warrior... \$29.00
- Temple of Asphai..... \$29.00
- Upper Reaches of Apsai..... \$16.00

CBS

- K-razy Shoot Out... \$32.00
- K-razy Kritters... \$32.00
- K-razy Antics... \$32.00
- K-star Patrol..... \$32.00



**STICK
STAND
\$6.99**

Arcade Action from your
ATARI or VIC Joy Stick

computer mail order west

800-648-3311

IN NV. CALL (702)588-5654, P.O. BOX 6689, STATELINE, NV. 89449

INTERNATIONAL ORDERS: All shipments outside continental United States must be pre-paid by certified check only! Include 3%(minimum \$3.00) shipping and handling.
EDUCATIONAL DISCOUNTS: Additional discounts are available from both Computer Mail Order locations to qualified Educational Institutions.

A High-Resolution Analog-to-Digital Converter for the TRS-80

James Cameron
POB 742
Port Aransas, TX 78373

Interfacing the typical 8-bit microcomputer with the real world often involves the conversion of constantly varying (analog) signals to digital form through some sort of converter and I/O (input/output) circuitry. ADCs (analog-to-digital converters) can be based on readily available 8-bit converter ICs (integrated circuits), such as National Semiconductor's MM5357.

An 8-bit converter IC is an easy and natural match for the 8-bit data bus and the 8-bit architecture of most common microcomputers. However, you'll quickly discover that 8-bit resolution is quite coarse. If you're interested in applications requiring a wide measurement range, or in accuracy better than ± 0.5 percent, the 12-bit ADC interface described in this article and the principles that allow extension of the interface to 14- and 16-bit converters may be what you've been looking for.

The resolution or ability to distinguish digitally between slightly different signals is determined by the number of bits in the conversion. For example, an 8-bit binary scale can be used to count to 256 (0 through 255, actually), or to divide a measurement scale into 256 equal parts. Let's say you were making a Fahrenheit thermometer to read in the range of -44 to $+212$ degrees. An 8-bit converter would give you an output in 1-degree increments, $\pm \frac{1}{2}$ degree of accuracy—there is $\pm \frac{1}{2}$ bit uncertainty in any 8-bit conversion. This is acceptable for

some applications, but to obtain a reading in tenths of a degree, at least 12-bit resolution (which divides the scale into 4096 intervals, or about 1/16-degree intervals) is needed. Of course, it's impossible to simultaneously read 12 bits onto an 8-bit data bus. The trick is to make the 12-bit conversion, hold the data, read the low bits first, then the high bits, and put them together with software. All this, plus some status, over-range, and polarity information can be obtained with the 12-bit Datel/Intersil ICL7109 ADC and four other common ICs.

The Circuit

Figure 1 on page 380 shows the complete interface circuit for a Radio Shack TRS-80 Model I in block diagram form. The ADC is connected to the data bus through an input port and an output port, both of which are enabled by the \overline{IN} and \overline{OUT} lines and an address decoder. The output port is used to control the flow of data and information onto the data bus via the input port. Two latches are used: one configured as the output port with address 1, and the other as the input port with address 0. The three least significant address lines (A0 through A2) are decoded by a 3-to-8 line decoder to select the port. The selected lines are activated by gating the \overline{IN} and \overline{OUT} signals from the TRS-80. The \overline{IN} and \overline{OUT} are NANDed so that if either goes low, the decoder's active-

Marcey Inc.

The METEOR

A System designed for Maximum Reliability, Flexibility and Value

System Specifications:

Processor:

- 4 MHz Z-80A CPU
- 64K Memory - Bank Selected
- 2 Serial & 2 Parallel I/O Ports
- 2K or 4K Shadowed Monitor EPROM
- Double Density Floppy Disk Controller
- Single Board Construction
- Meets IEEE 696 Specifications

Power

Specifications:

- Constant Voltage Power Supply (*Provides Brown-Out Protection*)
- Switchable 110/220V & 50/60 Hz Operation
- +8V/30A +-16V/3A

Chassis

Specifications:

- 1 Slot Shielded Motherboard (*11 Free Slots in Single User System*)
- Dual Double-Sided Double-Density Disk Drives
- 2.2 Megabytes Total Disk Storage
- Black Chassis with Gold Anodized Front Panel

Operating Systems:

- CP/M Version 2.2 Standard (Included)
- Enhanced Command Control Processor

Available Options:

- (Additional Cost)
- 4 Thin-Line Floppy Disk Drives (*5 Megabyte Floppy Disk Storage*)
 - MP/M Multi-User Operating System
 - Turbo-DOS Multi-User Operating System
 - Turbo-DOS Multi-Processor Operating System
 - Custom Wood Cabinet
 - Slave Processors for Multi-Processor Systems

List Price \$4995

Introductory Price \$3495

For Further Information Please Circle Reader Service Card 522

MARCEY Universal S-100 Mainframe

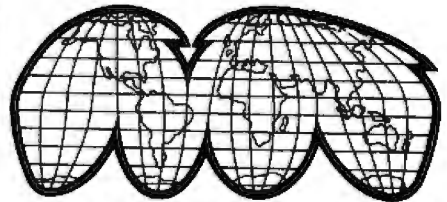

The first S-100 Mainframe that is truly UNIVERSAL.

The power supply is SWITCHABLE between 110/220v and 50/60Hz, and provides BROWN-OUT PROTECTION with its Constant Voltage Transformer.

Available in either 12-slot or 22-slot configurations

Specifications:

- Motherboard — S-100/IEEE-696 — Shielded and Grounded
- Power Supply — +- 8V @ 30A — +- 16V @ 2A
- Constant Voltage Power Transformer
- Switchable 110/220V & 50/60Hz

12 Slot List \$795.00 **Introductory Price \$575.00**

22 Slot List \$995.00 **Introductory Price \$675.00**

For Further Information Please Circle Reader Service Card 523

MARCEY INC.

Distributors of Computers and Computer Products

6700 Valjean Avenue □ Van Nuys, California 91406 □ (213) 994-7734

Dealer Inquiries Invited Quantity Pricing Available

(1a)

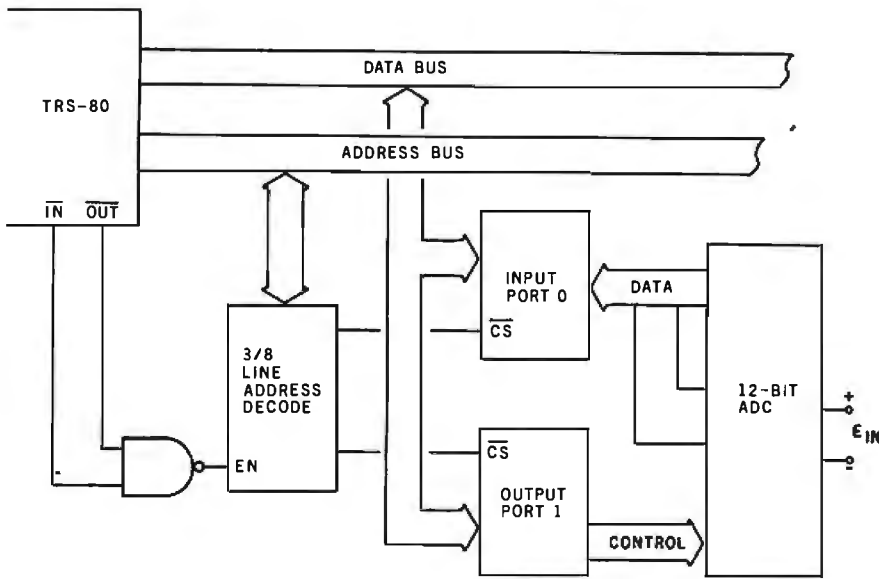
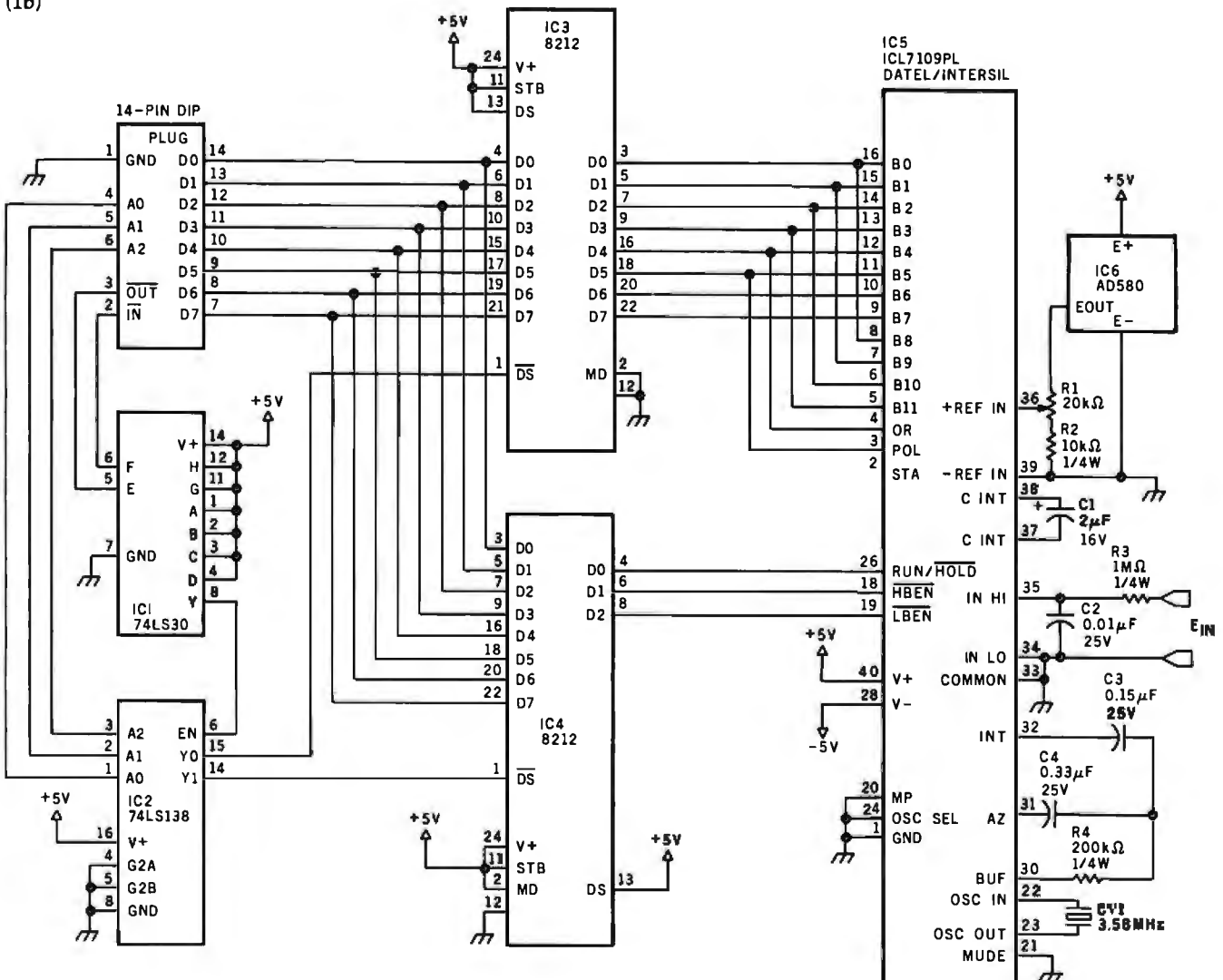

Figure 1: Diagrams of the complete interface circuit. In figure 1a, a block diagram of the circuit shows how the I/O port of the circuit shows how the eight data lines are partitioned into an input bus and into an output bus. Figure 1b is a schematic diagram developed from figure 1a. Note that all eight data lines are used when transferring data to the computer and only three lines are used by the computer to control the ADC.

(1b)



TRAKSTOR. Your Specialty Store For Drives

LOW, LOW, PRICES!!

HIGH PERFORMANCE REMEX FLOPPY DISK DRIVES

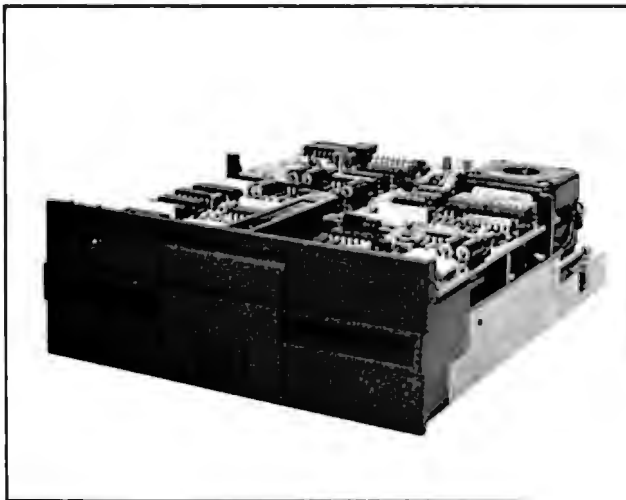

5 1/4" DISK DRIVES

RFD 480 **\$275**
double sided/double density, 48 tpi
(SA 450/TA 101-2 compatible)

RFD 960 **\$345**
double sided/double density, 96 tpi
(SA 460/TA 101-4 compatible)

DC brushless spindle motors for longer life—
30,000 hours MTBF!

Specify standard bezel or low profile
2/3 height

TO ORDER: CALL TOLL FREE (800) 358-4888,
CALL (800) 358-4798 in California

TERMS: VISA, MC, BAC, Check, Money Order—U.S. funds
only. Prices include sales tax. Shipping and handling
charges: \$3.00 for first 3 lbs. plus 35¢ for each additional
lb. Orders over 50 lbs. sent freight collect.

Shipping weights: 8" drive - 16 lbs.; 5 1/4" drive - 4 lbs.

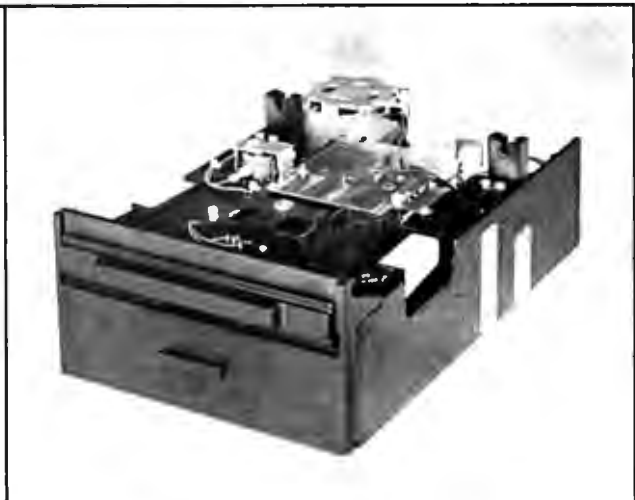

8" DISK DRIVES

RFD 2000 **\$295**
single sided/double density
(SA 801R compatible)

RFD 4000 **\$395**
double sided/double density
(SA 851R compatible)

**FREE TECHNICAL MANUAL WITH
EVERY ORDER**

TRAKSTOR™

TRAKSTOR
2991 White Star
Anaheim, CA 92686

TRS-80 COMPUTERS

**Pure Radio Shack Equipment
Buy By Direct Mail
Call For Your
Discount Prices**

1-800-841-0860

CONVENIENT ORDER ENTRY

TRS-80 COLOR COMPUTER
DISCOUNT PRICED
CALL
BUY DIRECT 26-3004

TRS-80 MODEL III COMPUTER
DISCOUNT PRICED FROM
\$588
26-1061

TRS-80 MODEL 16 COMPUTER
DISCOUNT PRICES FROM
\$4098
26-6001

TRS-80 MODEL II COMPUTER
DISCOUNT PRICED
CALL
26-4002

TRS-80 PRINTERS
DWP-410 *1287.00
DMP-100 *339.00
DMP-200 *679.00
DMP-400 *1013.00
DMP-500 *1523.00

TRS-80 1/III
HARD DRIVES **\$1988**
26-1100

PRICES AND PRODUCTS SUBJECT TO CHANGE WITHOUT NOTICE. ORDERS SUBJECT TO VERIFICATION AND ACCEPTANCE.

ATARI
HOME COMPUTERS
DISCOUNT PRICED FROM BUY DIRECT
\$629

OKIDATA
EPSON
SICM SMITH-CORONA

SMITH CORONA TP-1
DAISY WHEEL PRINTER
DISCOUNT PRICED FROM
\$559

FRANKLIN
ACE 1000 COMPUTER
'CALL

NEW TRS-80 PRODUCTS - CALL

Commodore
TRS-80 SOFTWARE
VISICALC, PROFILE,
SCRIPSIT & MORE
SAVE MONEY

PLEASE WRITE US FOR
FREE

*Copy of our customer discount price list upon request.

*Copy of manufacturers warranty upon request.

**CALL
TOLL FREE
BEFORE YOU
BUY**

MICRO MANAGEMENT SYSTEMS, INC.

PARCEL DIVISION
DEPT. NO. 1
2803 THOMASVILLE RD. EAST
CAIRO, GA. 31728

GA.
INFO **912-377-7120**

TM - TANDY CORPORATION

high enable pin goes high, allowing the selected output line to go low to turn on the right port.

The address decoding shown in figure 1 is only partial, and if other I/O devices are connected, some additional decoding must be provided. Line Y7 on IC2, the decoder, will be activated when, for example, the cassette recorder of a TRS-80 is used, because its address of 255 (hexadecimal FF) will cause A0, A1, and A2 to go high, activating Y7. For complete address decoding, each line from A2 through A7 could be inverted and NANDed to the A2 connection of the decoder (requiring the addition of two more ICs, a 74LS04 hex inverter, and another 8-input 74LS30 NAND gate). By a variety of other rearrange-

This interface extends the 8-bit microprocessor's power into the realm of serious measurement.

ments, the I/O ports may be located anywhere within the 256 possible I/O addresses, except for those reserved by other devices.

Operation

The key to understanding the circuit's operation is in the arrangement of control and data lines on IC5, the ICL7109 ADC. Several options are provided for in the device's design, but as employed here, the device is enabled like this: a control byte is sent to the output port to put a 1 on the RUN/HOLD line (pin 26) of the ADC. After a brief delay, this pin is returned low by sending a second control byte to port 1. A high on the RUN/HOLD pin starts a conversion. When the conversion is finished, the ICL7109 signals with a low on the status pin (STA, pin 39). To read the output data from the ICL7109, a third control byte is sent to port 1, this time putting a low on the high-bits-enable pin (\overline{HBEN} , pin 19). This activates bits 8 through 11 of the converted signal, an over-range indication (bit 12), and a polarity signal (bit 13). During this cycle, the low-order bits (0 through 7) are in a high-impedance state, which means those pins are "invisible" to the data bus.

To get the low bits, another control byte is sent to port 1, putting a low on the low-bits-enable pin (\overline{LBEN} , pin 18). After that, an INP(0) statement reads the low bits through the input port, 00H. A new conversion cycle takes about 33 ms (milliseconds) with the circuit shown. The last completed conversion is held as long as a low is present at pin 26 of IC5.

Circuit Construction

The schematic diagram for this circuit is shown in figure 1b. The diagram also shows the proper pin connections for the DIP (dual-inline package) plug-to-edge-card connector that's required to hook the circuit to either the back of a TRS-80 keyboard unit or an Expansion Interface. (I recommend wire-wrap construction on perf-board.)

Lyc0 Computer Marketing & Consultants

TO ORDER
CALL US

TOLL FREE 800-233-8760

In PA 1-717-398-4079

FEBRUARY ATARI SPECIALS

810 Disk Drive ... \$429.00
400 32K RAM ... \$CALL \$

NEW ATARI
COMPUTER ... \$CALL \$

800 48K... \$499.00

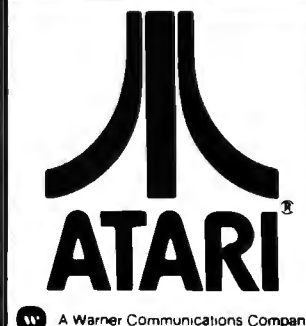

ATARI HARDWARE

410 CASSETTE RECORDER \$ 75.00
825 PRINTER.....\$585.00
830 PHONE MODEM\$149.00
850 INTERFACE.....\$164.00

PACKAGES

CX481 ENTERTAINER\$ 69.00
CX482 EDUCATOR\$125.00
CX483 PROGRAMMER\$ 49.00
CX494 COMMUNICATOR\$325.00

SOFTWARE

CXL4012 MISSILE COMMAND ...\$28.75
CXL4013 ASTEROID\$28.75
CXL4020 CENTIPEDE\$32.75
CXL4022 PACMAN\$32.75
CXL4011 STAR RAIDER\$34.75
CXL4004 BASKETBALL\$26.75
CXL4006 SUPER BREAKOUT\$28.75
CXL4008 SPACE INVADER.....\$28.75
CX8130 CAVERNS OF MARS.....\$31.75
CX4108 HANGMAN\$12.75
CX4102 KINGDOM\$12.75
CX4112 STATES &
CAPITALS\$12.75
CX4114 EUROPEAN
COUNTRIES\$12.75
CX4109 GRAPHIT\$16.75
CX4121 ENERGY CZAR\$12.75
CX4123 SCRAM\$19.75
CX4101 PROGRAMMING I\$19.75
CX4106 PROGRAMMING II.....\$22.75
CX4117 PROGRAMMING III\$22.75
CXL4015 TELELINK\$21.75
CX4119 FRENCH\$39.75
CX4118 GERMAN\$39.75
CX4120 SPANISH\$39.75
CXL4007 MUSIC COMPOSER....\$33.75
CXL4002 ATARI BASIC\$45.75
CX8126 MICROSOFT
BASIC\$65.75
CXL4003 ASSEMBLER
EDITOR\$45.75
CX8126 MACRO
ASSEMBLER.....\$69.75
CXL4018 PILOT HOME\$65.75
CX405 PILOT EDUCATOR\$99.75
CX415 HOME FILING
MANAGER\$41.75
CX414 BOOKKEEPER.....\$119.75

NEW RELEASES

CHOP LIFTER.....\$27.75
APPLE PANIC.....\$23.75
PREPIE\$19.95

THIRD PARTY SOFTWARE

EASTERN FRONT 1941\$25.50
OUTLAW/HOWITZER\$15.50
WIZARD of WAR\$31.00
GORF.....\$31.00
FROGGER.....\$26.00
CHOP LIFTER.....\$27.75
APPLE PANIC.....\$23.75
PREPIE\$19.95
STAR WARRIOR.....\$28.00
CRUSH, CRUMBLE, & CHOMP\$23.00
SHOOTING GALLERY.....\$19.95
VIDEO MATH FLASH\$12.00
MY FIRST ALPHABET\$25.50
BAHA BUGGIES\$24.95
TEMPLE of ASPHALT.....\$27.95
UPPER REACHES
of ASPHALT\$15.00
TRACK ATTACK\$23.00
STAR BLAZER\$25.00
LABYRINTH\$23.00
SEA FOX\$23.00
POOL 1.5.....\$26.95
SPEEDWAY BLAST (ROM)\$29.95
JAWBREAKER\$22.95
THRESHOLD\$29.95
MOONBASE IO\$23.95
PROTECTOR\$24.95
NAUTILUS\$24.95
SLIME\$24.95
SUBMARINE
COMMANDER (ROM)\$36.95
JUMBO JET
PILOT (ROM)\$36.95
SOCCER (ROM)\$36.95
KICKBACK (football ROM)\$36.95

PRINTERS

Okidata 82A\$479.00
Okidata 83A\$719.00
Okidata 84\$1089.00
CitohCALL
Prowriter I\$499.00
Prowriter IICALL
SMITH CORONA TP-1\$625.00
NECCALL
(Interfacing Available)

BUSINESS SOFTWARE

ATARI WORD PROCESSING\$109.00
LETTER PERFECT (ROM)\$149.00
LETTER PERFECT (disc)\$129.00
TEXT WIZZARD\$ 89.00
DATA PERFECT\$ 75.00
VISICALC\$169.00
DATASAM/85.....\$125.00

JOYSTICKS

ATARI CX-40\$18.00
LESTICK\$34.00
WICO COMMAND CONTROL\$23.75
WICO RED BALL\$26.75
WICO TRACK BALL\$54.75
STICK STAND.....\$ 6.75

COMPUTER COVERS

800\$6.99
400\$6.99
410\$6.99
810\$6.99

PERCOM

SINGLE DRIVE (SD)\$399.00
SINGLE DRIVE (DD)\$549.00
DUAL DRIVE (DD).....\$869.00
DUAL HEAD (DD)\$669.00



POLICY



In-Stock items shipped within 24 hours of order. Personal checks require four weeks clearance before shipping. No deposit for COD orders. PA residents add sales tax. All products subject to availability and price change. Advertised prices show 4% discount offered for cash. Add 4% for Mastercard and Visa. Circle 239 on Inquiry card.

TO ORDER
CALL TOLL FREE
800-233-8760
In PA 1-717-398-4079
or send order to
Lyc0 Computer
P.O. Box 5088
Jersey Shore, PA 17740

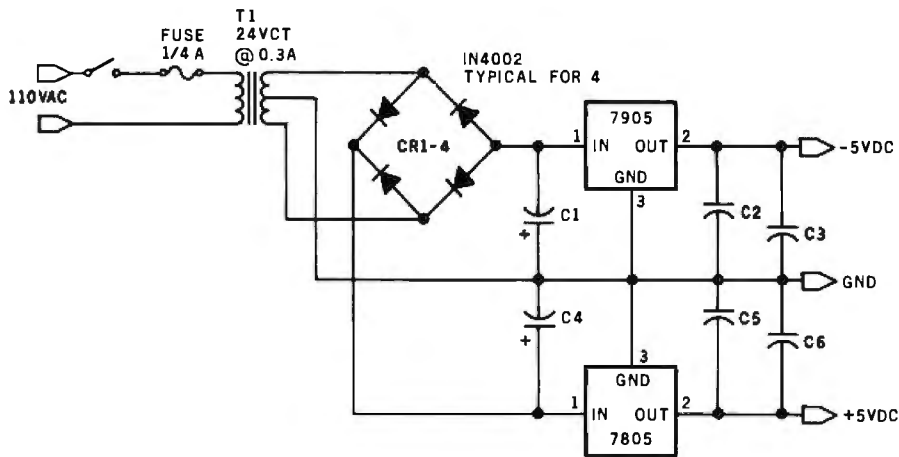

Figure 2: Design of a suggested power supply. The power must be extremely stable if the unit is to live up to its potential.

DIP Plug	Function	TRS-80 Edge-Card Connector
1	Gnd	8
4	A0	25
5	A1	27
6	A2	40
2	IN	19
3	OUT	12
14	D0	30
13	D1	22
12	D2	32
11	D3	26
10	D4	18
9	D5	28
8	D6	24
7	D7	20

Table 1: Connections necessary to hook the ADC board to the edge-card connector of a TRS-80 Model I.

Address		
binary	decimal	
xxxxx000	0	Input port activated; otherwise tri-state
xxxxx001	1	Output port active; otherwise data latched
Control		
xxxxx111	7	Start conversion; output tri-stated
xxxxx110	6	Hold when finished; output tri-stated
xxxxx100	4	Enable high bits; low bits tri-stated
xxxxx010	3	Enable low bits; high bits tri-stated
High Bits		
xx1x xxxx		Positive polarity
xx0x xxxx		Negative polarity
xxx1 xxxx		Out of range signal
xxxx		High data bits

Table 2: Useful codes for controlling, addressing, and reading the ADC.

Optimum performance of the ICL7109 depends on a stable and accurate reference voltage and on good-quality capacitors. Although the ADC has an internal voltage reference, using it causes some reduction of circuit flexibility. The Analog Devices AD580 voltage reference shown in figure 1b has excellent thermal and aging characteristics, as does the Datal/Intersil ICL8069, which could be substituted. Good-quality resistors with low temperature coefficients (such as the metal-film RN55 type) should be used to divide the reference voltage. The values used in figure 1b are for a 4.096-V (volt) input scale, with a 2.048-V reference (details on setting the reference voltage for other input scales are given in the Datal/Intersil data sheet supplied with the ICL7109). The capacitors used should not be disc ceramic; polypropylene or Teflon are best, and Mylar is acceptable. A few 0.01- μ F (microfarad) disc-ceramic capacitors should be placed on the board to bypass the power supplies.

Both +5-V and -5-V supplies are required, for which a good regulated bench supply or the circuit shown in figure 2 will do nicely. The total power drain is about 180 mA (milliamperes) at +5-V, and only a few mA from the -5-V supply. (The connections needed between the DIP plug and the TRS-80 Model I expansion connector are provided in table 1.)

Software

The software to generate the control signals and read and process the data may be written either as part of a BASIC program or as an assembly-language-subroutine. Speed is not critical for this interface because the ICL7109 is a dual-slope, auto-zero, integrating converter, and its conversion time of 33 ms is relatively slow. Listing 1 on page 386 is a BASIC program that includes a delay for conversion, an over-range message, and polarity correction. Testing each individual bit in BASIC is somewhat clumsy because all data is converted to decimal by the in-

dBASE II™ Owners

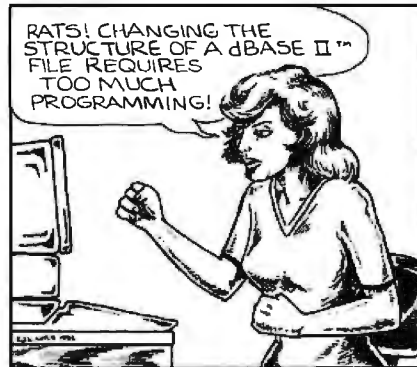

DBPlus™ Will Save The Day!

Faster than a dBASE II™ SORT

Sort a data file on 32 fields, up to 15 times faster than dBASE II™.

More powerful than a MODIFY STRUCTURE

Transform any dBASE II™ data file, by adding, deleting and modifying fields without any programming knowledge. You can even transfer your data to WordStar/MailMerge™.

Able to compress huge data files with a simple command

Save up to 70% of your data transmission costs. Perfect for archival storage of important files.

Disguised as a mild-mannered dBASE II™ utility, in reality DBPlus™ heralds a new era in microcomputers. Software designed for value, quality, and use by human beings. Now at a dealer near you!

DBPlus™

\$99 Introductory price
\$125 after February 1, 1983



"Software For Human Beings"

HumanSoft

661 Massachusetts Avenue
Arlington, MA 02174
(617) 641-1880

DBPlus is a registered trademark of HumanSoft, Inc.
dBASE II is a registered trademark of Ashton-Tate, Inc.

Selection and Delivery

**Call Now
TOLL FREE
800-368-3404**
(In VA, Call Collect 703-237-8695)

AMPEX • INTERTEC • TEXAS INSTRUMENTS • GENERAL DATA
COMM. • ANDERSON JACOBSON • C. ITOH • QUME • BEEHIVE •
DATASOUTH • DIABLO • CENTRONICS • NEC • PRENTICE

MICROS

INTERTEC SUPERBRAIN II
64K DD* **ONLY \$1895**
64K QD* **ONLY \$2295**
64K SD* (96TPI) **ONLY \$2695**
*(includes M/Soft BASIC)
DDS-10 Meg
(Hard Disk) **ONLY \$3195**

DYNABYTE Call

PRINTERS

NEC
7710 Ser. \$2149
7715 \$2196
7730 Par. \$2149
7720 \$2449
7725 \$2496
Std. Tractor 77 xx \$ 199
3510 \$1390
3510 EX ... Call for Special Price
3515 \$1395

DATASOUTH Call

DIABLO
620-SPI \$1144
630-R102/147 \$1949
630-ECS \$2686
630-R153* \$1745

*(for IBM P.C., Apple II, TRS-80)
630-R155 Call
630-K104 (KSR) \$2385

QUME
Sprint 9/45 FP \$1794
Sprint 9/55 FP \$2119
Sprint 9/55 FP/XMEM \$2186
Sprint 9/55 LP/XMEM \$2094
Sprint 11/40-PLIJS Call
Bi-Dir. Forms Tractor \$ 199

CENTRONICS: 34/38 Call

TERMINALS

AMPEX
D80 \$ 699

BEEHIVE (SMART DISPLAY)
DM5 Call
DM5A Call
DM310 (3101 Emulator) Call
DM 3270 (3270 Emulator) Call
Protocol Converter Call

QUME
QVT-102 \$ 594
QVT-103 \$ 739

C. ITOH
CIT 101 \$1350
CIT 161 (Color) Call

TEXAS INSTRUMENTS
745 Standard \$1390
745 Std. (Reconditioned) Call
765 Bbl M'my Call
785/787 Call
810 Basic \$1249
810 Package \$1439
820 Package RO Package \$1610
820 KSR Package Call
840 RO Basic \$ 795
840 RO Tractor Feed Pkg. \$1059
940 Video Ed'tr \$1570

MODEMS

PRENTICE STAR 300 Bd. \$ 124
GDC 1035JL \$ 169
1200-9600 Baud Call
Stat Muxes Call

DISC DRIVES

QUME
Data Trak 5 \$289 or 2 for \$549
Data Trak 8 \$519 or 2 for \$999

SOFTWARE

BISYNC-3780 \$ 769
Wordstar (IBM P.C.) \$ 279
Data Star \$ 218
Mail Merge FREE*
Spell Star \$ 149
Spell Guard \$ 229
Plan 80 \$ 249
d Base II \$ 529
CalcStar \$ 191
SuperSort \$ 158
Super Calc \$ 249
InfoStar Call
CIS Cobol \$ 689
Forms II \$ 159
MACRO 80 \$ 183
"C" Compiler \$ 177

*With purchase of InfoStar.

Special! While They Last!

SOROC TERMINALS

IQ 120 **ONLY \$625**

NOTE: IBM and Burroughs compatible terminals available. Please inquire.

In addition, we can make EIA RS 232 or RS 449 cables to your order, and supply you with ribbons, printer stands, print wheels, thumbles for all printers listed. And many, many more items. CALL NOW.

All items shipped freight collect either motor freight or UPS unless otherwise specified. All prices already include 3% cash discount. Purchase with credit card does not include discount. Virginia residents, add 4% Sales Tax. For fastest delivery send certified check, money order or bank-wire transfer. Sorry, no C.O.D. orders. All equipment is in factory cartons with manufacturers' warranty (honored at our depot). Prices subject to change without notice. Most items in stock.

**TERMINALS
TERRIFIC**



Terminals Terrific, Inc., P.O. Box 216, Merrifield, VA 22116
Phone: 800-368-3404 (In VA, Call Collect 703-237-8695)

Listing 1: This simple BASIC program for the TRS-80 controls the ADC.

100 DEFINT A,B,D

200 P = -1 : OUT 1,7

300 FOR X=1 TO 50: NEXT X

400 OUT 1,6

500 FOR X=1 TO 100: NEXT X

600 OUT 1,4

700 A = INP(0)

800 OUT 1,3

900 B= INP(0)

1100 IF A< 32 GOTO 1300

1200 A = A-32: P = 1

1300 IF A >= 16 GOTO 2000

1400 D = ((256*A)+B)*P

1500 PRINT D

1600 FOR X= 1 TO 200: NEXT X: GOTO 200

1700 END

2000 PRINT "OUT OF RANGE": GOTO 1600

terpreter. The series of steps shown at lines 1000 through 1300 is one way of handling the testing.

Controlling the ADC and testing the status bits is more straightforward in Z80 assembly language because the I/O functions are accomplished with IN and OUT commands and the testing uses the BIT command. For the TRS-80, this can be done as a USR(0)-called subroutine, with the op codes either loaded separately or with a POKE into high memory by a BASIC program. (A summary of control-byte, address, and input-bit patterns is given in table 2 as a quick reference for software design.)

Expansion to 14-Bit and 16-Bit Circuits

The I/O control scheme illustrated by this circuit is easily applied to the even greater resolution and accuracy provided by 14- and 16-bit ADCs. Substituting the Datal/Intersil 8068/7104-16 pair of devices for the ICL7109, for example, merely requires the following changes: the output bits must have three-state outputs on the input port's data lines in three overlapping groups, 0-7, 8-15, and OR and POL bits. Besides the three

**We speak
your language
and translate
your software needs
into efficient and
Quality Services...**

DMA products operate
on the full range of 8080-8088
processors, including the IBM-PC

Here's what you can do!

Data Base Management

The FORMULA.

The Application Generator™

This unique software package lets you create sophisticated business application software without programming. The FORMULA builds files, reports, updates, sorts, and menus and links them all according to the user's specifications. It incorporates features of a data base manager, a word processor, and a compiler into the first "system language" for microcomputers.

Communications

ASCOM™

ASCOM™ is the most versatile asynchronous communication package for microcomputers on the market. It features interactive, menu-driven, and batch operations; supports auto-answer and auto-dial modems; includes most popular protocols; provides network simulation; and many other options. Xerox Corporation, NCR, Monroe Systems for Business, and the big 8 accounting firms use ASCOM.

Utilities

EM80/86™

This software emulator lets you use eight bit software on sixteen bit microcomputers without hardware modifications.

UT-86™

This package of user-friendly utilities for the IBM Personal Computer and similar systems includes copying, directory sorting, patching, and a general purpose file print utility.

Coming Soon

DMA."C"™ — A "C" language compiler which will generate either Z80 or 8086 assembly language code. Due to a unique optimization routine which is based upon a functional "P-code" model, the efficiency of DMA."C" will far exceed that of existing compilers.

SYNC/COM™ — A bisynchronous communication package that will be configurable for a variety of systems and include a flexible interface to the operating system.

The 8086 O. S. Converter™ — A program which will permit programs written for Digital Research's CP/M-86™ to execute under IBM's PC DOS.

DMA DMA DMA DMA DMA

WE SPEAK YOUR LANGUAGE WE SPEAK YOUR LANGUAGE WE SPEAK YOUR LANGUAGE

DYNAMIC MICROPROCESSOR ASSOCIATE
545 FIFTH AVENUE, NY, NY 10017
(212) 687-7115 • Dealer Inquiries only

ONE KEY WORD PROCESSING

on your **TELEVIDEO™**
with **WORDSTAR™** and . . .

**OVER
500 SOLD!**



\$99⁹⁵

MasterCard
Visa

- **NuKey™** Automates the 36 most commonly used word processing functions
- Reduces learning time while increasing operator speed
- For beginners and Wordstar experts
- Comes complete with 14 new matching keycaps

For your TELEVIDEO™ 950, TS-800, TS-800A, and TS-802

PLEASE SEND WORDSTAR SERIAL NUMBER TO:

Business Solutions, Inc.
91 W. Long Lake Rd., Suite 9
Bloomfield Hills, MI 48013
(313) 540-3360

DEALER INQUIRIES INVITED

TELEVIDEO & TELESOLUTIONS™ OF TELEVIDEO / WORDSTAR™ OF MICROPRO INTERNATIONAL
NuKey™ OF BUSINESS SOLUTIONS, INC.

Reliable Business Software

DATASMITH software requires no previous computer experience, so it can be used effectively by your present office staff. The menu-driven systems feature extensive error detection and correction facilities, so they are "friendly" to the user.

- **GENERAL LEDGER.** Everything you need to keep the books. Features easy-to-use data entry and error correction, trial balance, fast post, and a variety of comprehensive reports. Automatic error detection keeps the books in balance. Writes checks and makes journal entries in one operation.
- **PAYROLL.** A very flexible system that adapts to a wide variety of needs. Features Federal, state, and local tax calculations, EI credit, and special pay and deduction amounts. Prints all necessary reports, paychecks, and W-2 forms.
- **DATA MANAGER.** A powerful generalized data management system that lets you define, enter, update, sort, select, and print reports from a database of your own design. Applicable to almost any job where records must be kept, this system can replace literally hundreds of programs.

Put your computer to work with these sophisticated systems now. Programs are available for 48K or larger two-disk systems in your choice of code for Microsoft BASIC-80® under CP/M®, IBM® Personal Computer BASIC, or Micropolis® BASIC.

DATASMITH

Box 8036, Shawnee Mission, KS 66208, (913) 381-9118

(3a)

Analog-to-Digital Converter Parts

IC1	74LS30
IC2	74LS138
IC3,IC4	8212, Intel
IC5	ICL7109CPL, Datel/Intersil
IC6	AD580, Analog Devices (ICL8069 from Intersil may be substituted)
C1	2 μ F, 16 V tantalum
C2	0.01 μ F, 25 V polypropylene
C3	0.15 μ F, 25 V polypropylene
C4	0.33 μ F, 25 V polypropylene
R1	20 k Ω , 15-turn Cermet trimmer
R2	10 k Ω , 1/4 W 1% RN55-type metal film
R3	1 M Ω , 1/4 W 5% carbon film
R4	200 k Ω , 1/4 W 1% RN55-type metal film
CY1	3.58 MHz TV crystal
Plug	14-pin DIP socket and mating insulation-displacement connector
Miscellaneous	Two 14-pin DIP sockets; one 16-pin DIP socket; two 24-pin DIP sockets; one 40-pin DIP socket (wire-wrap); 14-conductor ribbon or insulated cable; wire-wrap wire.

(3b)

Power Supply Parts

T1	Transformer, primary 110 V AC, secondary 24 V, C.T. at 0.3 A
CR1-4	1N4002, or suitable bridge rectifier
C1	470 μ F, 16 V electrolytic
C4	1000 μ F, 16 V electrolytic
C2,C5	1 μ F, 16 V electrolytic
C3,C6	0.01 μ F, 25 V ceramic
7805,7905	Three-terminal IC voltage regulators. LM320/340 series in T0-220 package are equivalent.

Table 3: Parts lists for the converter (3a) and its power supply (3b).

output-control lines ($\overline{\text{RUN/HOLD}}$, $\overline{\text{HBEN}}$, and $\overline{\text{LBEN}}$), a fourth, $\overline{\text{MBEN}}$, is added, and the middle bits are gated onto the data bus in their turn. A few extra lines of code in the software-driver routine, and you're in business.

A second ICL7109 converter could be added by using one of the six unused addresses from IC2, three of the unused output lines on port 01H, and by connecting the three-state output lines of the second ICL7109 onto the secondary data bus going into the 8212 input port. For more than two channels, however, this is probably not as economical as employing the ADC with a multiplexed analog input, which could also be controlled by unused lines on the output port. The circuit could be easily adapted for other popular microcomputers, such as the Apple II, or for S-100 systems, by picking up the appropriate equivalents of the $\overline{\text{IN}}$ and $\overline{\text{OUT}}$ signals from the bus.

This interface extends the 8-bit microprocessor's power into the realm of serious measurement. The principle of using three-state buffers to pass multiple output bytes through a single input port allows a degree of resolution and accuracy usually reserved for expensive equipment, at a total cost of a weekend and less than \$100. ■

THE FORTH SOURCE™

MVP-FORTH – A Public Domain Product

MVP Forth is fig-FORTH modified by 100% of the FORTH-79 Standard Required Word Set plus the vocabulary for the instructional book *Starting FORTH*. Editor, assembler and utilities are included.

Transportability of programs is assured since the kernel of MVP-FORTH is the same for all computers to the machine dependent READ/WRITE instructions.

Modification and extension (up or down) is simplified by having the source code and through the use of MVP-FORTH Programming Aids and Cross Compilers.

The CP/M[®] are supplied on 8", SS/SD, IBM 3740, format disks. The include a track and sector calculation array for down loading to other sizes and formats. Other disks are machine specific.

All About FORTH is an annotated glossary of MVP-FORTH words as well as other dialects. It is in 8080 code, other MVP-FORTH implementations include documentation of the differences between it and other CPU's and computers.

MVP-FORTH PRODUCTS for CP/M[®] IBM-PC[®] and Apple[®]

- || MVP-FORTH Programmer's Kit including disk with documentation, ALL ABOUT FORTH, and STARTING FORTH. Assembly source listing versions. \$100
- | MVP-FORTH Disk with documentation. Assembly source listing version. \$75
- || MVP-FORTH Cross Compiler with MVP-FORTH source in FORTH. \$300
- | MVP-FORTH Programming Aids for decompiling, callfinding, and translating. Specify computer. \$150
- || MVP-FORTH Fast Floating Point for Apple II/II+ on board with 9511 math chip. Requires MVP-FORTH for Apple \$400
- MVP-FORTH Assembly Source Printed listing. \$20
- | | ALL ABOUT FORTH by Haydon. MVP-FORTH reference, plus fig-FORTH and FORTH-79. \$20

*** MVP-FORTH operates under a variety of CPU's, computers, and operating systems. Specify your computer and operating system. CP/M supplied on 8", SS/SD, 3740 format. ***

FORTH DISKS

FORTH with editor, assembler, and manual.

- | | |
|--|---|
| □ APPLE II/II+ by MicroMotion \$100 | □ PET [™] by FSS \$90 |
| □ APPLE II by Kuntze \$90 | □ TRS-80/II [™] by Nautilus Systems \$90 |
| □ ATARI [®] valFORTH \$50 | □ 6800 by Talbot Microsystems \$100 |
| □ CP/M [®] by MicroMotion \$100 | □ 6809 by Talbot Microsystems \$100 |
| □ CROMEMCO [®] by Inner Access \$100 | □ Z80 by Laboratory Microsystems \$50 |
| □ HP-85 by Lange \$90 | □ 8086/88 by Laboratory Microsystems \$100 |
| □ IBM-PC [®] by Laboratory Microsystems \$100 | □ VIC FORTH by HES, VIC20 cartridge \$60 |
| □ NOVA by CCI, quad floppy \$100 | |

Enhanced FORTH with: F-Floating Point, G-Graphics, T-Tutorial, S-Stand Alone, M-Math Chip Support, MT-Multi-Tasking, X-Other Extras, 79-FORTH-79.

- | | |
|---|--|
| □ APPLE II/II+ by MicroMotion, F, G, & 79 \$140 | □ TRS-80/II or III by Miller Microcomputer Services, F, X, & 79 \$130 |
| □ ATARI by PNS, F, G, & X. \$90 | □ TUTORIAL by Laxen & Harris. CP/M with a copy of <i>Starting FORTH</i> \$95 |
| □ CP/M by MicroMotion, F & 79 \$140 | □ Extensions for Laboratory Microsystems IBM, Z80, and 8086 |
| □ Apple II/II+, GraFORTH by Insoft, stand alone graphics \$75 | □ Software Floating Point \$100 |
| □ H89/Z89 by Haydon, T & S \$250 | □ 8087 Support (IBM-PC or 8086) \$100 |
| □ H89/Z89 by Haydon, T \$175 | □ 9511 Support (Z80 or 8086) \$100 |
| □ IBM-PC, PolyFORTH by FORTH Inc., F, G, S, M, MT, & X \$300 | □ Color Graphics (IBM-PC) \$100 |
| □ Multi-Tasking FORTH by Shaw Labs, CP/M, X & 79 \$395 | □ Data Base Management \$200 |

CROSS COMPILERS Allow extending, modifying and compiling for speed and memory savings, can also produce ROMable code. *Requires FORTH disk.

- | | |
|--------------------------------|---------------------------|
| CP/M \$300 | □ IBM [®] \$300 |
| □ H89/Z89 \$300 | □ 8086 [®] \$300 |
| □ TRS-80/II \$300 | □ Z80 [®] \$300 |
| □ Northstar [®] \$300 | □ Apple II/II+ \$350 |
- | fig-FORTH Programming Aids for decompiling, callfinding, and translating. Specify CP/M, IBM-PC, 8086, Z80, or Apple II/II+ \$150

FORTH MANUALS, GUIDES & DOCUMENTS

- | | |
|--|--|
| □ ALL ABOUT FORTH by Haydon. An annotated glossary of common FORTH words. MVP-FORTH reference. \$20 | □ AIM FORTH User's Manual \$12 |
| □ And So FORTH by Huang. A college level text. \$25 | □ APPLE User's Manual MicroMotion \$20 |
| □ FORTH Encyclopedia by Derick & Baker. A complete programmer's manual to fig-FORTH with FORTH-79 references. Flow charted, 2nd Ed. \$25 | □ TRS-80 User's Manual, MMSFORTH \$19 |
| □ Starting FORTH by Brodie. Best instructional manual available. (soft cover) \$16 | □ METAFORTH by Cassidy. Meta compiler in 8080 code \$30 |
| □ Starting FORTH (hard cover) \$20 | □ Systems Guide to fig-FORTH \$25 |
| □ 1980 FORML Proc. \$25 | □ Caltech FORTH Manual \$12 |
| □ 1981 FORML Proc. 2 Vol. \$40 | □ Invitation to FORTH \$20 |
| □ 1982 FORML Proc. \$25 | □ PDP-11 FORTH User's Manual \$20 |
| □ 1981 Rochester FORTH Proc. \$25 | □ CP/M User's Manual, MicroMotion \$20 |
| □ 1982 Rochester FORTH Proc. \$25 | □ FORTH-79 Standard \$15 |
| □ Using FORTH \$25 | □ FORTH-79 Standard Conversion \$10 |
| □ A FORTH Primer \$25 | □ Tiny Pascal in fig-FORTH \$10 |
| □ Threaded Interpretive Languages \$21 | □ NOVA fig-FORTH by CCI with editor, assembler, and utilities \$15 |
| □ Installation Manual for fig-FORTH, contains FORTH model, glossary, memory map and instructions \$15 | □ MVP-FORTH Source Listings |

Source Listings of fig-FORTH, for specific CPU's and computers. The Installation Manual is required for implementation. Each \$15

- | | | | |
|---------|-----------|--------|-----------------|
| □ 1802 | □ 6502 | □ 6800 | □ AlphaMicro |
| □ 8080 | □ 8086/88 | □ 9900 | □ APPLE II |
| □ PACE | □ 6809 | □ NOVA | □ PDP-11/LSI-11 |
| □ 68000 | □ Eclipse | □ VAX | |

Ordering Information: Check, Money Order (payable to MOUNTAIN VIEW PRESS, INC.), VISA, MasterCard or COD's accepted. No billing or unpaid PO's. California residents add sales tax. Shipping costs in US included in price. Foreign orders, pay in US funds on US bank. Include for handling and shipping by Air: \$5 for each item under \$25, \$10 for each item between \$25 and \$99 and \$20 for each item over \$100. Minimum order \$10. All prices and products subject to change or withdrawal without notice. Single system and/or single user license agreement required on some products.

DEALER & AUTHOR INQUIRIES INVITED

MOUNTAIN VIEW PRESS, INC.

PO BOX 4656

MOUNTAIN VIEW, CA 94040

(415) 961-4103



"Mitch Kapor and his team of designers and programmers are incredibly creative: they have come up with more good ideas than they can possibly implement at one time, but they also implement more of them than I would have thought possible."

*Gregg Williams,
BYTE magazine,
December, 1982*

 **LOTUS** 

55 Wheeler Street, Cambridge,
Massachusetts 02138 (617) 492-7171

Circle 235 on Inquiry card.



1-2-3 will be shipped to dealers on January 26, 1983.

Shape-Table Graphics for the TRS-80

Draw complex shapes with a single command.

Dan Rollins
Apartment C
134 Olive St.
Glendale, CA 91206

In the fast-moving world of computer graphics, the TRS-80 Model I and III programmer seems to have been forgotten. When the local Apple users group meets, members admire each other's high-resolution graphics creations while discussing the details of vector plotting, video paging, and shape tables. And all the while, the TRS-80 owner carefully calculates SET/RESET/PRINT @ positions and curses the limitations of these commands.

Ever wish you could draw a complex shape on the screen of your TRS-80 with a single command? Could you use a command for magnifying the size of that shape by using a scaling factor? How would you like to be able to "build" a page of graphics and characters in memory, then move it to the screen at machine-language speeds? Well, the KWIKDRAW program will painlessly add these functions to your repertoire.

KWIKDRAW is a machine-language routine (see listings 1 and 2) that was developed to be used interactively with BASIC. This combination of machine-language speeds and BASIC flexibility allows freedom and ease found in neither medium independently. Additionally, the routine can be located on a BASIC program line. It need not be loaded separately as a SYSTEM tape nor will MEMORY SIZE ever need to be answered. It is loaded along with the BASIC application program.

The methods to accomplish this have been covered in a previous article (see "Vector Graphics for the TRS-80,"

BYTE, January 1983, page 371) and will not be repeated here. In essence, a BASIC program uses POKE commands to insert Z80 op codes into a prepared dummy string on a program line. The address of that string is used as the point to which control is passed via the USR command. Any such routine must be fully relocatable and contain no op-code bytes with values of 00 or 22 hexadecimal.

Vectors

In this article, the word *vector* will be defined as a control code used in moving a cursor for plotting points of a video-screen matrix. Using compass points as an analogy, a vector will be interpreted as motion north (up), south (down), west (left), and east (right), or as any combination of these motions, i.e., northeast (up and right).

Starting at a key position, a vector will advance this cursor in any of eight directions. The new screen position may then be turned on, turned off, or skipped. From this point, another vector will further advance the cursor and take the required action. A series of such vectors may be used to define a *shape*—the basic building block for all graphics applications. A series of shapes, drawn rapidly on the screen, might be used to animate a figure.

Couple this shape-drawing function with the ability to change the shape's key position from drawing to drawing; add the options of enlarging or reducing the size and

The speed and power of an IBM PC on a \$345 Apple® card.

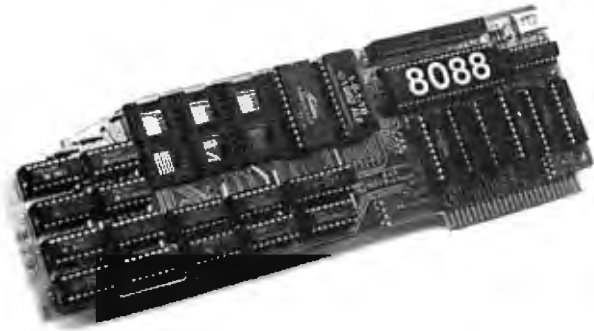

FAST 5 MHZ OPERATION, TRUE MULTIPROCESSING

ALF's AD8088 Processor Card adds a fast 16-bit 8088, the processor used in the IBM PC, to your Apple II. It runs programs from its on-board memory at a full 5 MHz—12% faster than the IBM PC—while the Apple also runs at full speed. And two or more AD8088's can be used in one Apple, to tackle problems that are beyond many mainframe systems.

CP/M-86 AND 192K MEMORY

CP/M-86®, the 8088 version of the industry standard CP/M operating system, is available for the AD8088 for only \$200. AD8088 CP/M-86 uses the popular Microsoft Softcard® disk format so you can buy the latest programs direct from major software distributors like Lifeboat Associates.

CP/M-86 uses only 18K, leaving 46K for programs on a 64K Apple—easily enough memory to assemble 12K of object code. For large programs, our \$370 AD128K Memory Card provides 110K

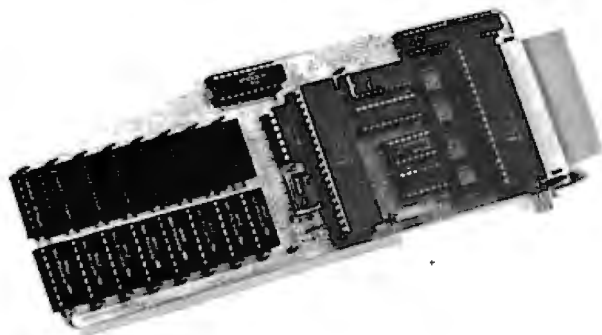

program space, or 174K program space (192K system memory) for an extra \$75.

THE 8087 NUMERIC DATA PROCESSOR

The AD128K Memory Card features a socket for the Intel 8087 Numeric Data Processor. The 8087's 80-bit internal format gives 18 digits of accuracy (Applesoft has only 9). Its speed is equally impressive: it multiplies two 80-bit floating-point numbers faster than the Apple runs 10 machine codes!

FASTER APPLESOFT FOR SCIENTIFIC & ANALYTICAL PROGRAMS

Any program can be rewritten for fast operation with the 8088, but ALF's "FTL" program speeds up math in your existing Applesoft programs—without modification. FTL is activated simply by typing RUN FTL. Programs produced by TASC® or Expediter II® also run faster. The graphs below show the dramatic improvement with FTL.



RELIABLE LOW POWER OPERATION

The clean design of the "AD" series separates the two main components—processor and expansion memory, when needed—on two cards. Low-power components are used for cooler operation: each card draws less than an Apple ROM card—far less than a typical 80-column card.

SEE YOUR APPLE DEALER TODAY

An Apple II computer with 64K (48K plus Language Card equivalent) and 13- or 16-sector disk drive is required. The AD8088 and AD128K can be used in any slot.

Trademarks: "Apple": Apple Computer, "TASC", "Softcard": Microsoft, "Expediter II": Einstein/Goodrow, "CP/M-86": Digital Research

ALF

A L F PRODUCTS INC. 1448 ESTES DENVER, CO 80215

(303) 234-0871

\$595.00

The Last Expansion Unit You Will Ever Have To BUY

The six most commonly required add-on features for your IBM PC

Without Using Any Additional Slots!

- Six additional system slots.
- Two Asynchronous serial ports.*
- Up to 256k of additional memory with our exclusive DPECC (R) (Dynamic Parity Error Correcting Circuitry)*
- Three parallel ports.*
- Real Time Clock.*



The 256k RAM, 2 asynchronous serial ports, 3 parallel ports, and a Real Time Clock are all built on to the motherboard, so you won't have to waste precious slots on them.

The Expansion Unit comes without these options installed.* So you don't have to pay for them if you don't need them. But when you do, all you have to do is plug in the chips and you are ready to go.

**All options are available installed with the Expansion Unit.*



2116 WALSH AVENUE
SANTA CLARA, CA 95050
(408) 727-7548

The one place for all your business & personal computing needs!

We specialize in Speed, Selection & Service!

From business management and accounting software, to the latest entertainment - whatever you need is yours - FAST - from MICRO-MANIA!

- We've got the biggest selection and fastest service on:**
- Software Packages
 - Computer Supplies (including ribbons for OKI-DATA, ANADIX & EPSON printers)
 - Stock & Customized Forms (for all software packages)
 - Labels for all printers
 - Books from Addison-Wesley and others*
 - and much more!

Send for our FREE catalog!

***Addison-Wesley's popular Pocket Guides**

Learn programming the easy, Addison-Wesley way! Their Programming Pocket Guides are just \$6.95 each. Choose BASIC, COBOL, FORTRAN, PASCAL or general PROGRAMMING.



MICRO-MANIA
Dept. B2 • P.O. Box 3048 • Peabody, MA 01960-3048

Call Collect **617-532-5930**
Most orders shipped within 24 hours!

\$6.95 each

FREE shipping

Direction	Vector Character	Move and Plot	Move Only
N	A		1
S	B		2
N then S	C		5
E	D		4
NE	E		5
SE	F		6
W	H		8
NW	I		9
SW	J		:

Table 1: Shape-definition characters interpreted by the KWIKDRAW program. The letters A through J will move and plot the cursor position, while the numbers 1 through 9 and the colon will only move the cursor.

changing the color of the shape; and we have motivation for the invention of shape-table graphics for the TRS-80 and the reason for KWIKDRAW.

KWIKDRAW interprets a BASIC character string as a series of vectors. Shapes are drawn using pixels or any displayable character. A shape may be enlarged by a scaling factor of 2 to 256 and may be drawn anywhere on or partially off the screen. Pages of shapes may be stored in memory for rapid sequential recall.

In writing KWIKDRAW, I decided that ease of programming was more important than using the memory-stringy "bit-stream" method employed in Applesoft.

Shape-interpreters are notorious for being difficult to work with. Applesoft, for example, requires that a shape-table be created as a series of 3-bit codes. The first 2 bits indicate direction (up, down, left, right), and the third indicates a plot/don't-plot action. Byte boundaries are ignored except in defining the end of the shape. These rules tend to make shape defining a complex proposition.

Table 1 contains the shape-definition characters that are interpreted by KWIKDRAW. Notice that all characters may be entered from the keyboard. Though only 5 of the 8 bits of an ASCII (American Standard Code for Information Interchange) character are needed for defining a vector, I decided that ease of programming was more important than using the memory-stingy "bit-stream" method seen in Applesoft. Also, note that provisions are made for moving the cursor without changing the background upon which the shape is drawn.

Defining a Shape

The easiest way to explain how to define a shape is to

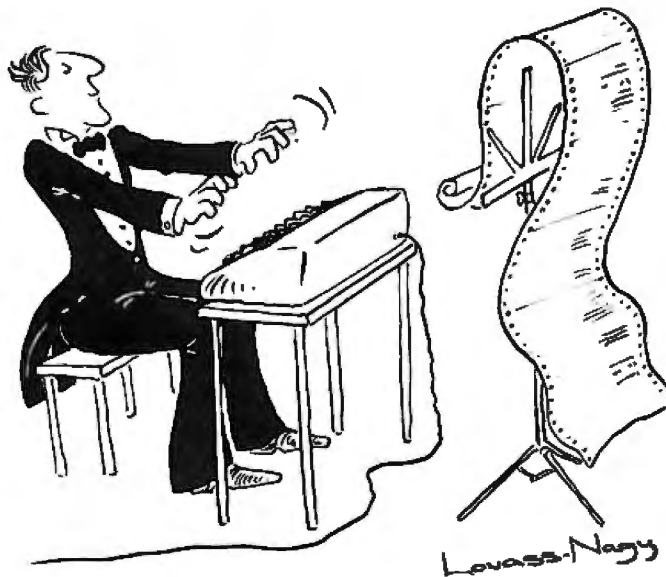

The Well-Tempered Cross-Assembler

Before Johann Sebastian Bach developed a new method of tuning, you had to change instruments practically every time you wanted to change keys. Very difficult.

Before Avocet introduced its family of cross-assemblers, developing micro-processor software was much the same. You needed a separate development system for practically every type of processor. Very difficult and very expensive.

But with Avocet's cross-assemblers, a single computer can develop software for virtually any microprocessor! Does that put us in a league with Bach? You decide

Development Tools That Work

Avocet cross-assemblers are fast, reliable and user-proven in over 3 years of actual use. Ask NASA, IBM, XEROX or the hundreds of other organizations that use them. Every time you see a new microprocessor-based product, there's a good chance it was developed with Avocet cross-assemblers.

Avocet cross-assemblers are easy to use. They run on any computer with CP/M* and process assembly language for the most popular microprocessor families.

XASMO5	6805	\$200 each
XASMO9	6809	
XASM18	1802	
XASM48	8048/8041	
XASM51	8051	
XASM65	6502	
XASM68	6800/01	
XASMF8	F8/3870	
XASMZ8	Z8	
XASM400....	COP400	
XASM75	NEC 7500	\$500
(Coming soon: XASM68K 68000)		

Turn Your Computer Into A Complete Development System

Of course, there's more. Avocet has the tools you need from start to finish to enter, assemble and test your software and finally cast it in EPROM:

Text Editor VEDIT -- full-screen text editor by CompuView. Makes source code entry a snap. Full-screen text editing, plus TECO-like macro facility for repetitive tasks. Pre-configured for over 40 terminals and personal computers as well as in user-configurable form.

CP/M-80 version \$150
 CP/M-86 or MDOS version \$195
 (when ordered with any Avocet product)

In-Circuit Emulators -- MICE In-Circuit Emulator by Microtek. Full capability emulation in a compact, inexpensive device. Accepts high-level ASCII commands through RS 232 serial interface. Downloads programs generated by Avocet cross-assemblers .. examine and modify memory and registers, access I/O ports and control program execution in single instruction and single-cycle modes. Forward and backward tracing for up to 256 qualified cycles ... Assembly/Disassembly commands with symbolic labels make it easy to modify the program under test.

MICE-I versions for 6502, 8048, 8085, NSC 800 and Z-80 \$1,795 each.

MICE-II versions with 2K trace and 32K program memory, plus real-time emulation and hardware break points for 6502, 6809, 68000, 8085 and 8086/8088 \$3,995.

(6805 and 8051 versions available starting second quarter)

ROM Simulator -- ROMSIM by Inner Access eliminates need to erase and reprogram EPROM. Installed in an S-100 host, ROMSIM substitutes RAM for EPROM in external target system. 16K memory can be configured to simulate the 2708, 2758, 2716, 2516, 2732, 2532, 2764, 2564 in either byte or word organization. Avocet's configurable driver makes loading of HEX or COM files fast and easy.

From \$495 depending on cabling and RAM installed.

EPROM Programmer -- Model 7128 EPROM Programmer by GTEk programs most EPROMS without the need for personality modules. Self-contained power supply ... accepts ASCII commands and data from any computer through RS 232 serial interface. Cross-assembler hex object files can be down-loaded directly. Commands include verify and read, as well as partial programming.

PROM types supported: 2508, 2758, 2516, 2716, 2532, 2732, 2732A, 27C32, MCM8766, 2564, 2764, 27C64, 27128, 8748, 8741, 8749, 8742, 8751, 8755, plus Seeq and Xicor EEPROMS.

(Upgrade kits will be available for new PROM types as they are introduced.)

Programmer \$389
 Options include:
 Software Driver Package \$ 30
 RS 232 Cable \$ 30
 8748 family socket adaptor \$ 98
 8751 family socket adaptor \$174

Call Us

If you're thinking about development systems, call us for some straight talk. If we don't have what you need, we'll help you find out who does. If you like, we'll even talk about Bach.

VISA and Mastercard accepted. All popular disc formats now available -- please specify. Prices do not include shipping and handling -- call for exact quotes. OEM INQUIRIES INVITED.

*Trademark of Digital Research.



AVOCET SYSTEMS INC.

DEPT. 283-B
 804 SOUTH STATE STREET
 DOVER, DELAWARE 19901
 302-734-0151

Listing 1: KWIKDRAW assembly-language program.

```

00100 #      PROGRAM ID   :   KWIKDRAW
00110 #      PROGRAMMER  :   Ian Rollins
00120 #      DATE        :   09/24/81
00130 #
00140 #      Program Abstract :
00150 #      This program interprets a string of
00160 #      control characters as a graphics shape,
00170 #      placing it on the screen at the position
00180 #      defined as an X,Y coordinate, scaled to
00190 #      a given value and drawn with either lit
00200 #      or unlit pixels or any displayable
00210 #      character.
00220 #
00230 #      KWIKDRAW requires a BASIC string of
00240 #      "vector definition" bytes and 6 control
00250 #      parameters. These control parameters are
00260 #      passed to the routine by placing them in
00270 #      elements of an INTEGER array :
00280 #
00290 #      PZ(0) = X ordinate (0-127 or 0-63)
00300 #      PZ(1) = Y ordinate (0-47  or 0-15)
00310 #      PZ(2) = VARPTR(shape definition string)
00320 #      PZ(3) = SET/RESET/CHARACTER byte :
00330 #              0=RESET, 1=SET, else=CHARACTER
00340 #      PZ(4) = scaling factor (1-255)
00350 #      PZ(5) = paging argument:
00360 #              0=page OUT, DRAW, page IN
00370 #              1=page OUT, DRAW (build a page)
00380 #              2=DRAW, page IN (display a page)
00390 #              3=DRAW only (don't page)
00400 #      PZ(6-517) = working storage for screen
00410 #
00420 #      Once these values are defined, KWIKDRAW is
00430 #      called via:
00440 #
00450 #              UU=USR(VARPTR(PZ(0)))
00460 #
00470 #      The shape definition string is composed of
00480 #      characters which are interpreted by KWIKDRAW
00490 #      as motions of a cursor - where bits indicate
00500 #      motion North, South, East, West or combinations
00510 #      thereof.
00520 #
00530 #              NORTH   = bit 0   (char AND 1)
00540 #              SOUTH   = bit 1   (char AND 2)
00550 #              EAST     = bit 2   (char AND 4)
00560 #              WEST     = bit 3   (char AND 8)
00570 #              MOVE (don't plot) = bit 5   (char AND 32)
00580 #
00590 # ***** CHART OF CONTROL CHARACTERS *****
00600 # ***
00610 # *** direction          plot/move          move only          ***
00620 # *** -----/-----/-----/----- ***
00630 # *** N                  /   "A"           /   "1"           ***
00640 # *** S                  /   "B"           /   "2"           ***
00650 # *** (plot only) /     "C"           /   "3"           ***
00660 # *** E                  /   "D"           /   "4"           ***
00670 # *** NE                 /   "E"           /   "5"           ***
00680 # *** SE                 /   "F"           /   "6"           ***

```

Listing 1 continued on page 398



"The computer company says call the software company. The software company says call service. Service says it's not in the contract; read the training manual. And nobody understands the manual."

Monroe eliminates a major source of trouble for computer buyers.

Too many sources.

When it comes to buying a computer, the more people you deal with, the lonelier it can get. Fortunately there's one computer company that does business differently: Monroe.

We offer one of the most advanced business microcomputer systems in the world. But unlike our competitors, we accept complete responsibility for your computer system after you buy—even if you buy only one.

Software that's easy to use.

Monroe software covers a wide range of applications, is designed for productivity and is easy to use. Our Extended Basic is closer to everyday English than



competitive Basics. An extensive CP/M®-based library is available. We even offer a software maintenance contract.

Your Monroe representative

 **MONROE**
Litton Systems For Business

At your side every step of the way.

is responsible to you. That's the only way we've done business for 70 years. For more information or a free demonstration in your office, call or write now.

800-526-7843 Ext. 444
(in New Jersey 800-522-4503 Ext. 444)

Monroe Systems For Business

The American Road
Morris Plains, New Jersey 07950

- Yes, I'd like a free demonstration in my office.
 Please send me more information on your computers.

Name _____
Title _____
Company _____
Address _____
City _____ State _____ Zip _____
Phone _____

PMN 1 83

Micromint will put both a computer development system and an OEM dedicated controller in the palm of your hand for as little as \$127.*

The Z8 Basic Computer/Controller represents a milestone in microcomputer price-performance. The entire computer is 4" by 4 1/2" and includes a tiny BASIC interpreter, 4K bytes of program memory, one RS-232 serial port and two parallel ports plus a variety of other features. The Z8 microcomputer board is completely self-contained and optimized for use as a dedicated controller. Can be battery operated. Comes with over 200 pages of documentation.

Z8 BASIC COMPUTER/CONTROLLER

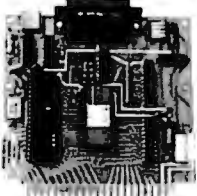

- Uses Zilog Z8671 single chip microcomputer
- On board tiny BASIC interpreter
- 2 parallel ports plus serial I/O port.
- Just connect a CRT terminal and write control programs in BASIC
- 4K bytes of RAM. EPROM pin compatible
- Baud rates 110-9600 BPS
- Data and address buses available for 124K memory and I/O expansion
- Consumes only 1.5 watts at +5, +12 & -12v.

- BCC01 Z8 Basic Computer**
Assembled & Tested . . \$199.00
- BCC02 Z8 Basic Computer**
Kit \$169.00

COMING SOON
A/D Converter 8 Channel 8 Bit
AC I/O Board
• 4 Channel 115Vac inputs
• 4 Channel 115Vac outputs
20 MA ADAPTER

Z8 MEMORY, I/O EXPANSION & CASSETTE INTERFACE

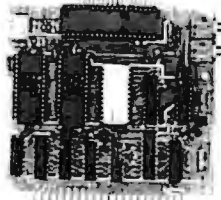

The Z8 Memory, I/O Expansion & Cassette Interface Board (Z8 Expansion Board for short) allows you to add up to 8K of additional memory plus three 8-bit parallel ports to your Z8 Basic Computer/Controller. The memory expansion will support any combination of byte wide RAM memory chips or 2716 or 2732 EPROM. The cassette interface is 300 baud Kansas City Standard (2400Hz/1200Hz).

- BCC03 Z8 Expansion Board**
w/4K memory \$140.00
- BCC04 Z8 Expansion Board**
w/8K memory . . \$170.00

Z8 EPROM PROGRAMMER

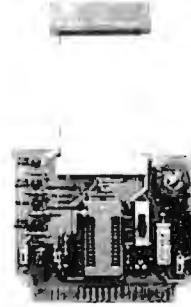

The EPROM Programmer board allows you to transfer application programs in BASIC or Assembly language directly from RAM to either 2716 or 2732 EPROMS. Requires Z8 Basic Expansion Board for operation.

NOTE: We recommend the higher current UPS03 or UPS04 power supply when using the EPROM Programmer.

- BCC07 Z8 EPROM Programmer**
Assembled & Tested
. . . \$145.00

Z8 SERIAL EXPANSION BOARD

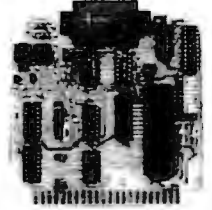

The Serial Expansion Board adds an additional RS-232C serial port to the Z8 system. It runs at 75 to 19,200 baud in all standard protocols. The 20 ma. current loop is opto-isolated for reliability and protection.

- BCC08 Z8 Serial Board**
Assembled & Tested . . . \$180.00

- MOTHER-BOARD**
MB02 Z8 Mother Board
with 5 connectors (Gold)
Assembled & Tested . . . \$81.00

- UNIVERSAL POWER SUPPLY**
+5 @ 300 ma. +12 & -12V @ 50 ma.
UPS01 Assembled and
Tested \$ 35.00
- UPS02 Kit** \$ 27.00
- +5 @ 1 amp. +12 & -12V @ 50 ma.
UPS03 Assembled and
Tested \$ 60.00
- UPS04 Kit** \$ 50.00

- Z8 CROSS ASSEMBLERS**
- FROM ALLEN ASHLEY
XAS01 For TRS-80 Mod I \$ 75.00
XAS02 For TRS-80 Mod III \$ 75.00
XAS03 For CP/M-8" . . . \$150.00
- FROM MICRO RESOURCES
MR01 CP/M-8" Diskette . \$ 75.00
MR02 APPLE II CP/M 5 1/4" \$ 75.00

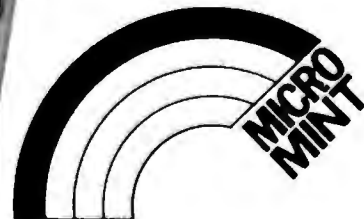
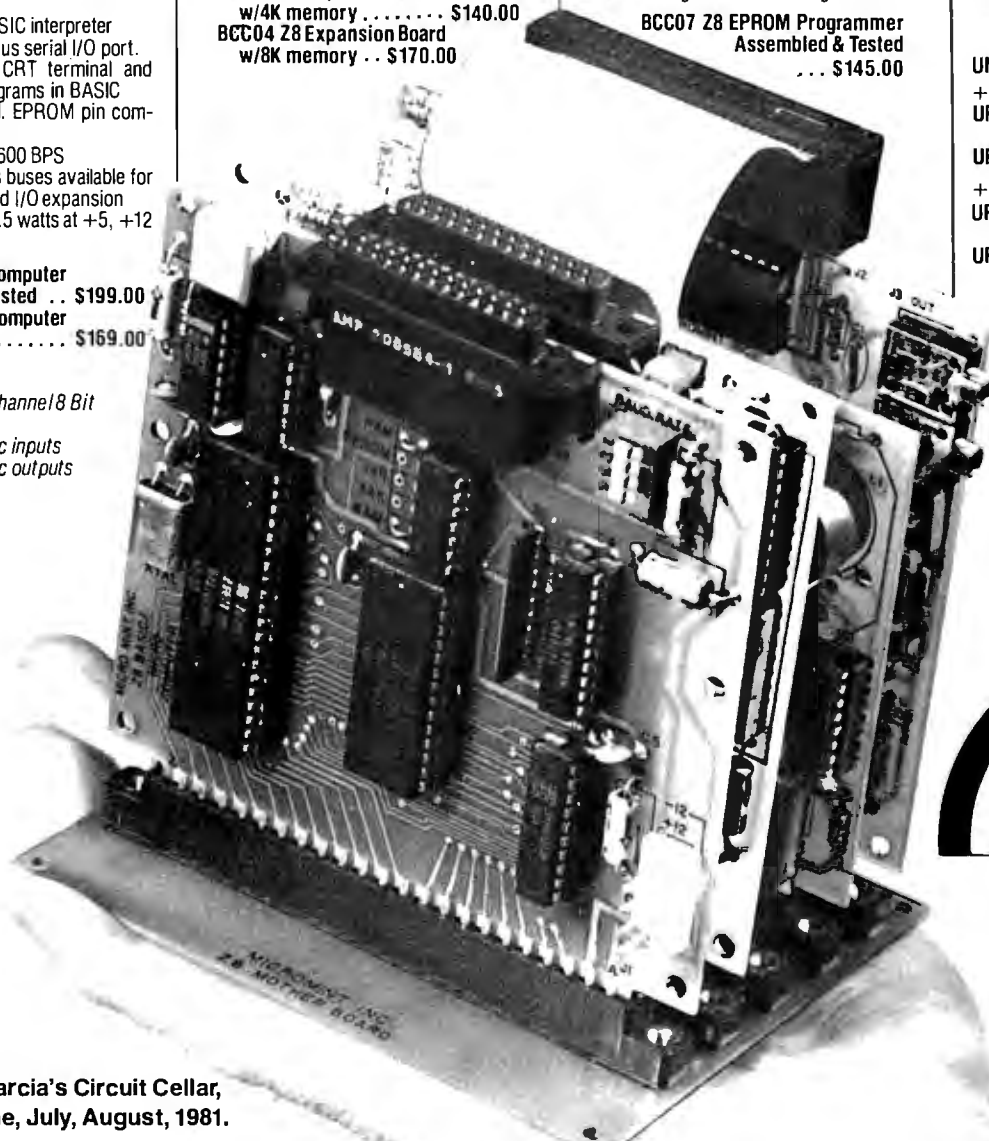

MICROMINT INC.
561 Willow Avenue
Cedarhurst, NY 11516

To Order:
Call Toll Free
1-800-645-3479
For Information Call:
1-516-374-6793

Circle 261 on inquiry card.

*In quantities of 100

As featured in Ciarcia's Circuit Cellar,
Byte Magazine, July, August, 1981.

Listing 1 continued:

```

001F EDB0      01290          LDIR                ;store screen to memory
                01300 ;
0021 DD6E05    01310 POSKIP LD      L,(IX+PTRLSB) ;point HL to BASIC's
0024 DD6606    01320          LD      H,(IX+PTRMSB) ; variables list
0027 46        01330          LD      B,(HL)        ;set LENGTH of strings
0028 23        01340          INC     HL
0029 5E        01350          LD      E,(HL)
002A 23        01360          INC     HL
002B 56        01370          LD      D,(HL)
002C EB        01380          EX      DE,HL         ;HL => control characters
002D DD5601    01390          LD      D,(IX+XPOS)   ;DE register defines the
0030 DD5E03    01400          LD      E,(IX+YPOS)   ; current X,Y coordinates
                01410 ;
0033 2B        01420          DEC     HL            ;set up for main loop
                01430 ;
0034 23        01440 MAIN  INC     HL            ;loop decodes each vector byte
0035 DD4E09    01450          LD      C,(IX+SCALE)
                01460 ;
0038 CB46      01470          BIT    0,(HL)        ;motion NORTH?
003A 2803      01480          JR     Z,CHKSTH      ;bit not ON, so skip
003C 7B        01490          LD      A,E          ;bit is ON, adjust the
003D 91        01500          SUB    C              ; Y pointer NORTH by
003E 5F        01510          LD      E,A          ; the scaling factor
003F CB4E      01520 CHKSTH BIT    1,(HL)        ;motion SOUTH?
0041 2803      01530          JR     Z,CHKEST
0043 7B        01540          LD      A,E
0044 81        01550          ADD    A,C
0045 5F        01560          LD      E,A
0046 CB56      01570 CHKEST BIT    2,(HL)        ;motion EAST?
0048 2803      01580          JR     Z,CHKWST
004A 7A        01590          LD      A,D
004B 81        01600          ADD    A,C
004C 57        01610          LD      D,A
004D CB5E      01620 CHKWST BIT    3,(HL)        ;motion WEST?
004F 2803      01630          JR     Z,CHKPLT
0051 7A        01640          LD      A,D
0052 91        01650          SUB    C
0053 57        01660          LD      D,A
0054 CB6E      01670 CHKPLT BIT    5,(HL)        ;plot/no plot flag ON?
0056 2815      01680          JR     Z,OKPLOT      ;bit is OFF so PLOT
                01690          ;else the following jump
                01700          ;sends control looping
                01710          ;back to set another
                01720          ;control character
                01730 ;
                01740 ;-----
0058 10DA      01750 JMPER2 DJNZ  MAIN     ;span #2 of the "bridge"
                01760 ;-----
                01770 ;
                01780 ;These lines "page" the updated video storage area
                01790 ;back IN to the screen. The action is skipped
                01800 ;when the paging argument = 1 or 3 (bit 0 is ON).
                01810 ;
005A DDDB0B46  01820 EXIT  BIT    0,(IX+PAGER) ;PX(5) = 1 or 3 ?
005E C0        01830          RET    NZ            ; then back to BASIC
                01840 ;
005F FDE5      01850          PUSH   IY           ;else page IN to screen
0061 E1        01860          POP    HL           ;HL => storage
0062 11013C    01870          LD      DE,3C01H
0065 1D        01880          DEC     E            ;DE => screen memory

```

Listing 1 continued on page 402

Now NRI takes you inside the new TRS-80 Model III microcomputer to train you at home as the new breed of computer specialist!

NRI teams up with Radio Shack advanced technology to teach you how to use, program and service state-of-the-art microcomputers...

It's no longer enough to be just a programmer or a technician. With microcomputers moving into the fabric of our lives (over 250,000 of the TRS-80™ alone have been sold), interdisciplinary skills are demanded. And NRI can prepare you with the first course of its kind, covering the complete world of the microcomputer.

Learn At Home in Your Spare Time

With NRI training, the programmer gains practical knowledge of hardware, enabling him to design simpler, more effective programs. And, with advanced programming skills, the technician can test and debug systems quickly and easily.



Training includes the TRS-80 Model III microcomputer, professional LCD multimeter, the NRI Discovery Lab, Computer Assisted Instruction programs and hundreds of demonstrations and experiments.

(TRS-80 is a trademark of the Radio Shack division of Tandy Corp.)



Only NRI gives you both kinds of training with the convenience of home study. No classroom pressures, no night school, no gasoline wasted. You learn at your convenience, at your own pace. Yet you're always backed by the NRI staff and your instructor, answering questions and giving you guidance.

You Get Your Own Computer to Learn On and Keep

NRI training is hands-on training with practical experiments and demonstrations. You don't just program your computer, you go inside it...watch how circuits interact...interface with other systems...gain a real insight into its nature.

You also work with an advanced liquid crystal display hand-held multimeter and the NRI Discovery Lab,[®] performing over 60 separate experiments. Both microcomputer and equipment come as part of your training for you to use and keep.

Computer Assisted Instruction

Your TRS-80 even helps train you. You receive 8 special lesson tapes in BASIC

computer language. Using them in your microcomputer, you "talk" to it as you progress. Errors are explained, graphics and animation drive home key points. Within a matter of minutes, you'll be able to write simple programs yourself.

Send for Free Catalog... No Salesman Will Call

Get all the details on this exciting course in NRI's free, 100-page catalog. It shows all equipment, lesson outlines, and facts on other electronics courses such as Electronic Design, Industrial Electronics, TV/Audio/Video Servicing... 11 different career opportunities in all. Keep up with the latest technology as you learn on the latest model of the world's most popular computer. If card has been used, write to:



NRI Schools
McGraw-Hill Continuing
Education Center
3939 Wisconsin Avenue
Washington, D.C. 20016

We'll give you tomorrow.

Listing 1 continued:

```

0066 01FF03 01890      LD      BC,3FFH
0069 03      01900      INC     BC          ;BC is byte count (1024)
006A ED80    01910      LDIR                     ;base memory to screen
                        01920 ;
006C C9      01930      RET                      ;<<<<<< Program EXIT <<<<<<<
                        01940 ;
                        01950 ;
006D C5      01960 OKPLOT  PUSH    BC          ;save table byte counter
006E D5      01970      PUSH    DE          ; and current X,Y
                        01980 ;
                        01990 ;           These nested loops draw a block of pixels (or
02000 ;           characters) which is SCALE wide and SCALE high.
                        02010 ;
                        02020 ;
                        02030 ;           +-----+
006F D5      02040 YLOOP  PUSH    DE          ;
0070 DD4609  02050      LD      B,(IX+SCALE) ;
                        02060 ;
                        02070 ;           +-----+
0073 E5      02080 XLOOP  PUSH    HL          ;save main registers *
0074 C5      02090      PUSH    BC          ; *
                        02100 ; *
0075 DD7E07  02110      LD      A,(IX+SRBYTE) ;if 5th argument is *
0078 FE02    02120      CP      2          ;1 or 0, mode is PIXEL
007A 3B23    02130      JR      C,PXMODE
                        02140 ;
02150 ;*****
02160 ;* This section determines a screen address *
02170 ;* at entry : D = column position (0-63) *
02180 ;* E = screen row (0-15) *
02190 ;* at exit : HL => video memory at requested byte *
02200 ;* destroys HL and BC registers *
02210 ;*****
02220 ;
007C 7A      02230 CHMODE  LD      A,D          ;check X,Y coordinates to make
007D FE40    02240      CP      64         ; sure that they are valid
007F 305C    02250      JR      NC,PLTSKP ;for CHARACTER mode.
0081 7B      02260      LD      A,E
0082 FE10    02270      CP      16
0084 3057    02280      JR      NC,PLTSKP
                        02290 ;
0086 63      02300      LD      H,E
0087 6A      02310      LD      L,D          ; set row and column
0088 CB25    02320      SLA     L
008A CB25    02330      SLA     L          ;column = column * 4
008C CB2C    02340      SRA     H
008E CB1D    02350      RR      L
0090 CB2C    02360      SRA     H
0092 CB1D    02370      RR      L          ;HL = HL/4
0094 FDE5    02380      PUSH    IY
0096 C1      02390      POP     BC          ;BC => storage
0097 09      02400      ADD     HL,BC       ;HL => byte to alter
0098 DD7E07  02410      LD      A,(IX+SRBYTE) ;set plot character
009B 1B3F    02420      JR      SVBYTE     ;store the CHARACTER arg.
                        02430 ;
                        02440 ;-----
009D 1B89    02450 JMPER1  JR      JMPER2 ;span #1 of the "bridge"
                        02460 ;-----
                        02470 ;
                        02480 ;

```

Listing 1 continued on page 404

A calculated way to cut your electricity costs.

Saving on electricity costs is as easy as switching light bulbs. This *free* slide rule calculator from Westinghouse shows you where to begin.

Use your Westinghouse Energy-Saving Calculator to take a hard nosed look at the lamps you are using now. Your calculator will help you select the most efficient type of lamps for offices, plants, show rooms and display areas.

If you have fluorescents, substituting Westinghouse Econ-o-watt® lamps for standard lamps will have an immediate effect of up to six watts per socket, with no appreciable change in light level.

Or save up to 80% in energy by replacing incandescent lighting with high pressure sodium lamps. They save energy while producing an equivalent

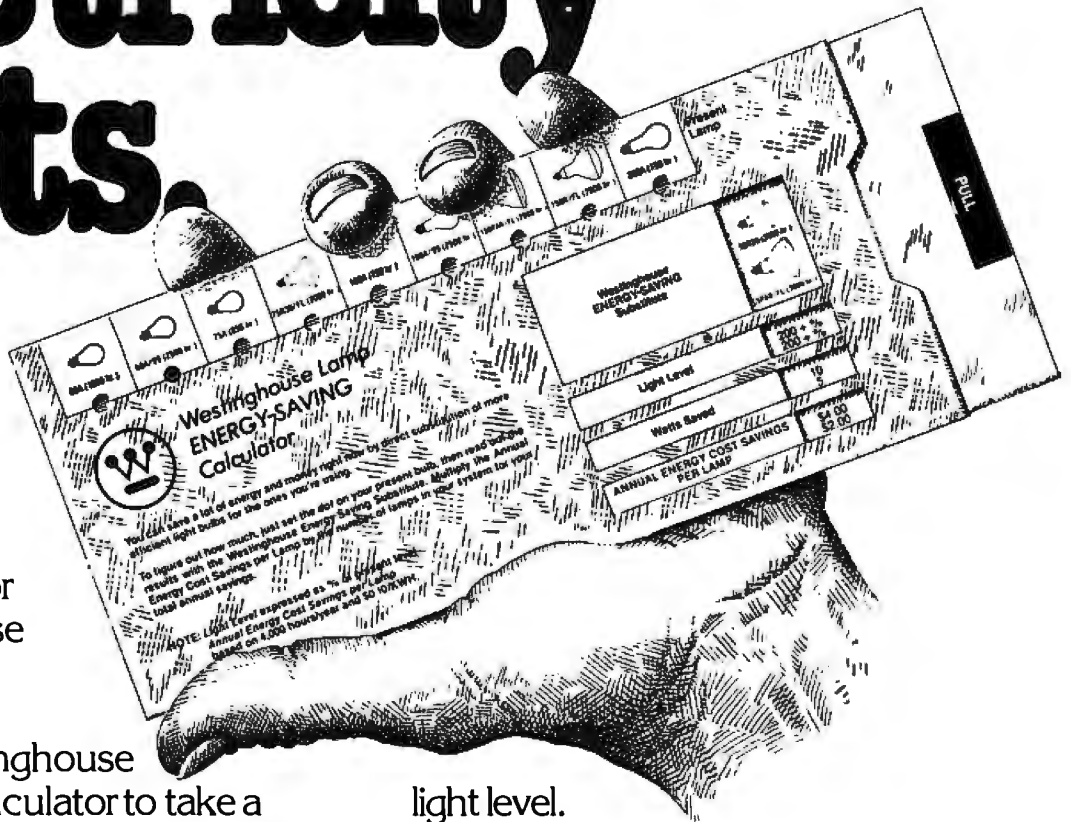

light level.

Westinghouse lamp products and programs are calculated to help save you from rising electricity costs. Our free calculator will show you how.

Get your free energy-saving calculator now! Call toll-free 800-631-1259.



Westinghouse

Lamp Divisions
Bloomfield, New Jersey 07003

```

02490 ;*****
02500 ;* This is a relocatable SET/RESET routine ; *
02510 ;* At entry : D = X (0-127) ; *
02520 ;* E = Y (0-47) ; *
02530 ;* (IX+SRBYTE) = SET/RESET code (0 = RESET, 1 = SET)*
02540 ;* destroys HL, BC, AF registers ; *
02550 ;*****
02560 ;
009F 7A 02570 PXM0DE LD A,D ;skip if invalid coordinates
00A0 FE80 02580 CP 128
00A2 3039 02590 JR NC,PLTSKP
00A4 7B 02600 LD A,E
00A5 FE30 02610 CP 48
00A7 3034 02620 JR NC,PLTSKP
02630 ;
00A9 26FF 02640 LD H,0FFH
00AB 7B 02650 LD A,E
00AC 24 02660 DIV3 INC H ;divide Y value by 3
00AD B603 02670 SUB 3 ;leaving quotient in H res.
00AF 30FB 02680 JR NC,DIV3 ; H is 0-15
00B1 C603 02690 ADD A,3 ;and remainder in B res.
00B3 47 02700 LD B,A ; B is 0-2
00B4 6A 02710 LD L,D
00B5 CB25 02720 SLA L ;L = X * 2
00B7 CB2C 02730 SRA H
00B9 CB1D 02740 RR L
00BB CB2C 02750 SRA H ;Divide HL by 4, leaving
00BD CB1D 02760 RR L ;remainder (0 or 1) in Carry
00BF CB10 02770 RL B ;determine pixel position by
00C1 04 02780 INC B ;B =DIV3 rmdr * 2 + DIV4 rmdr + 1
00C2 AF 02790 XOR A
00C3 37 02800 SCF
00C4 8F 02810 GETBIT ADC A,A ;determine pixel value by
00C5 10FD 02820 DJNZ GETBIT ; taking 2 to the Bth power
02830 ;
00C7 FDE5 02840 PUSH IY
00C9 C1 02850 POP BC
00CA 09 02860 ADD HL,BC ;HL => byte to alter
02870 ;
00CB CB7E 02880 BIT 7,(HL) ;check if currently
00CD 2002 02890 JR NZ,GFXOK ; graphics, so if so
00CF 3680 02900 LD (HL),80H ; else clear the byte
00D1 DDCB0746 02910 GFXOK BIT 0,(IX+SRBYTE) ;if SET/RESET flag is 0
00D5 2803 02920 JR Z,RESET ; then skip ... else
00D7 B6 02930 SET OR (HL) ;add a bit to screen byte
00D8 1802 02940 JR SVBYTE
00DA 2F 02950 RESET CPL
00DB A6 02960 AND (HL) ;mask bit from byte
02970 ;
00DC 77 02980 SVBYTE LD (HL),A ;store the altered byte
02990 ;
00DD C1 03000 PLTSKP POP BC ;restore registers used by
00DE E1 03010 POP HL ; plot routines
03020 ; *
00DF 14 03030 INC D ; *
00E0 1091 03040 IJNZ XLOOP ;plot SCALE horizontal points*
03050 ; *
03060 ; ***** *
03070 ; *
00E2 D1 03080 POP DE ; *

```

REWARD.

Find great bargains in this list and reap the rewards: immediate availability, 24-hour express delivery, toll-free technical support, 60-day trial with full refund privileges and special volume discounts.

DATABASE MANAGEMENT

dBase II-
Ashton-Tate \$ 475
Condor II-Condor
Computer Corp. \$ 450
Data Star-MicroPro
Call For Price
Easy Filer-
I.U.S. \$ 280
VisiFile-VisiCorp \$ 190

SPREADSHEETS/ CALCULATORS

SuperCalc-Sorcim
Call For Price
VisiCalc 256K-
VisiCorp \$ 195
Calc Star-MicroPro
Call For Price
Multiplan-
Micro Soft \$ 225

COMMUNICATIONS

Emulink (IBM PC 3270)
Micro Link Corp \$ 995
Emulink (Apple 3270)
Micro Link Corp \$ 795
Crosstalk-Micro Stuf \$ 120
BSTAM-Byron Software \$ 150

WORD PROCESSING/SPELLING

Wordmate-Softword Systems \$ 495
Wordstar-MicroPro Call For Price
Mailmerge-MicroPro Call For Price
Wordstar/Mailmerge-
MicroPro Call For Price
Spellbinder-Lexisoft \$ 295
Easywriter II-I.U.S. \$ 265
The Final Word-Mark of the Unicorn \$ 245
Select w/Superspell-Select Info.
Sytems \$ 395

WANTED

Help in reducing our inventory. Pick up one of these specials—priced so low we're actually losing money!

HAYES SMARTMODEM 1200
(in stock) \$525
CROSSTALK
MicroStuf \$120
dBASE II
Ashton-Tate \$475
SUPERCALC
Sorcim Call For Price
WORDMATES (IBM PC)
From Softword Systems—
the professional's choice in
IBM PC word processing. \$495

LANGUAGES/ UTILITIES

C Basic-
Digital
Research \$ 125
M Basic-
Micro Soft \$ 275
CB 80-
Digital
Research \$ 420
Basic Compiler-
Micro Soft \$ 310
Fortran 80-
Micro Soft \$ 395
CoBol 80-
Micro Soft \$ 575
Pascal MT+ -
Digital
Research \$ 425
PL-1 80-Digital
Research \$ 420

MISCELLANEOUS

Milestone-Organic
Software \$ 245
StatPak-NW
Analytical \$ 395
VisiSchedule-VisiCorp \$ 245
VisiTrend/Plot-VisiCorp \$ 245
Supersort-MicroPro Call For Price
Datebook-Organic Software \$ 245

MODEMS

Hayes Micromodem II \$ 275
Hayes Smartmodem 300 \$ 212

PRINTERS

Epson MX80 FT \$ 555
Epson MX100 FT \$ 745
IDS Prism 80 \$1335
Okidata 82A \$ 439
Okidata 83A \$ 705
NEC 3550 33cps wp \$1900

Call toll-free 800-328-2260

(In Minnesota, 612-544-3615)

American Express • MasterCard • VISA
3.5% surcharge on all credit orders.

Purchase orders accepted from corporate accounts. All orders are shipped UPS.
3% shipping charge on software items. 2% shipping charge on hardware items.

DATASOURCE

DATASOURCE SYSTEMS MARKETING CORP.

1660 South Highway 100, Minneapolis, MN 55416

Circle 141 on inquiry card.

Listing 1 continued:

```

00E3 1C      03090      INC      E      ;
00E4 0D      03100      DEC      C      ;
00E5 2088    03110      JR       NZ,YLOOP; Plot SCALE vertical points
                03120 ;
                03130 ;
                03140 ;
00E7 D1      03150      POP      DE      ;restore current X,Y
00E8 C1      03160      POP      BC      ; and save table counter
00E9 18B2    03170      JR       JMPER1  ;so to MAIN via JUMPERS
0000        03180      END
00000 TOTAL ERRORS
25739 TEXT AREA BYTES LEFT

```

```

CHKEST 0046 01570 01530
CHKPLT 0054 01670 01630
CHKSTH 003F 01520 01480
CHKWST 004D 01620 01580
CHMODE 007C 02230
DIV3   00AC 02660 02680
EXIT   005A 01820
GETBIT 00C4 02810 02820
GFXOK  00D1 02910 02890
JMPER1 009D 02450 03170
JMPER2 0058 01750 02450
MAIN   0034 01440 01750
OKPLOT 006D 01960 01680
PAGER  000B 01000 01210 01820
PLTSKP 00DD 03000 02250 02280 02590 02620
POSKIP 0021 01310 01220
PTLRSB 0005 00960 01310
PTRMSB 0006 00970 01320
PXMODE 009F 02570 02130
RESET  00DA 02950 02920
SCALE  0009 00990 01450 02050
SET     00D7 02930
SRBYTE 0007 00980 02110 02410 02910
SUBYTE 00DC 02980 02420 02940
XLOOP  0073 02080 03040
XPOS   0001 00940 01390
YLOOP  006F 02040 03110
YPOS   0003 00950 01400

```

Listing 2: KWIKDRAW BASIC-language program. The assembly-language programming from listing 1 has been incorporated into the DATA statements in lines 500-670. This data will be packed into line 20. Lines 10-50 may then be used as a kernel for your own BASIC programs.

```

5 '
      KWIKDRAW
      machine language shape drawing program
      by DAN ROLLINS
      11/10/81

6 '**
  ** This program sets up the machine language program
  ** for use as a USR routine. After a successful RUN,
  ** RUN again for a simple demonstration.
  **

```

Listing 2 continued on page 408



FORMULA INTERNATIONAL INC.

12603 Crenshaw Blvd., Hawthorne, CA 90250

For Information (213) 973-1921 • Orders Only (outside Calif.) (800) 672-8758



pineapple™

The Alternative! The Compatible! The Affordable! 48K Color Computer Kit!



\$645.00 EACH

(please add 5% shipping and handling)

FEATURES:

- ★ Fully compatible with Apple® II+
- ★ Singleboard for easy assembly
- ★ Popular 6502 MPU for large amount of software
- ★ Game paddle connector on both sides of case
- ★ Built in 2-watt amplifier for realistic sound effect with volume control
- ★ 8 on board peripheral connectors for expansion
- ★ 14 key numeric key-pad
- ★ 5-amp switching power supply

Easy to assemble! All components are clearly silk-screened on the high quality double-sided mother board. All integrated circuits, IC sockets, peripheral connectors, keyboard, switching power supply and the professional high impact plastic case are included.

NEW

High Quality 16K RAM Card Kit

(no cable required)

Same feature as the one we've been selling but without the mess of Dip-wire for Apple® & Pineapple™.

\$59.95 per kit

5¼" Flexible Disc Sale

Why buy other brands when you can buy WABASH discs for much less and backed by 1-year factory warranty.

All discs come with Hub Rings

M13A411X	5¼" SSDD Soft Sector	\$2.25	} 10-99
M43A411X	5¼" SSDD 10 Hard Sector	\$2.25	
M53A411X	5¼" SSDD 16 Hard Sector	\$2.25	
M14A411X	5¼" DSDD Soft Sector	\$3.65	
F111111X	8" SSSD IBM compatible	\$2.45	
F131211X	8" SSDD 26 sectors 128 bytes	\$3.05	

16K RAM Card Kit For Your Apple® & Pineapple™ Computer



Kit includes:

- High Quality P.C. Board • 8 ea. 4116 (200ns)
- All the IC's & parts • 16-pin Dip wire • Easy to assemble. You can do it in less than 30 minutes!

\$49.95 per kit

5¼" Disc Drive 100% Apple® & Pineapple™ Compatible



We did it once, response was great!

Now we are doing it again, don't miss it!

\$295.00 ea. w/o controller

\$385.00 ea w/controller

Replacement Keyboard For Your Apple® II Computer

Got a bad Keyboard? Here's the alternative!

- ★ Full ASCII code
- ★ N-key rollover function
- ★ TTL level output
- ★ On-Off indicator
- ★ Low power consumption
- ★ With upper/lower case function

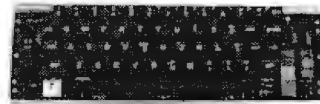

\$99.95 ea.

At last! Here's the computer case everyone has been looking for!

Ideal for your homebrew

*AP-II 6502 MPU based computer.

Made with high impact plastic.

Color and shape are compatible

with the standard Apple II

computers.

Introductory Offer

\$150.00 ea.

Keyboard not included see our Ad in this page.

MODEL: AP-II

*AP-II model is compatible with Apple II but not manufactured by Apple Computers, Inc. ©Apple or Apple II is a registered trade mark of Apple Computers, Inc.

6502 MPU Based Computer Motherboard!

You ask for it, you got it!

- ★ 48K on board memory (4116)
- ★ 12K on board EPROM memory (2716 or 2732)
- ★ 8 expansion slots for peripheral cards
- ★ Composite-video output
- ★ size: 14¼" x 8½"



\$99.95 ea.

Switching Power Supply For Apple®, AP-II, and Pineapple Computer

Compact size switching power supply.

Specification: 4006A 4007A

+5V at 3A 5A

-5V at 2A 3A

+12V at .5A 1A

-12V at .5A 1A

4006A **\$99.00** ea. 4007A **\$145.00** ea.

Size: Width 3½", Depth 9¾", Height 2¼"

Size and mounting holes will be same as the one used in Apple II.



* Apple is a registered trademark of APPLE COMPUTERS, INC.

SHIPPING AND HANDLING CHARGES
Under \$50.00 Purchase Over \$50.00 Purchase

Inside California	10%	5%
Outside Calif. (Incl. Mexico & Canada)	15%	10%
Overseas	25%	20%

Minimum Order \$10.00 / Calif. Residents add 6.5% Sales Tax. Phone Orders Accepted on VISA or MC ONLY, NO C.O.D.'s. Prices subject to change without notice.



STORE HOURS
MON-FRI — 10-7
SAT — 10-6

```

10 CLEAR 2000 :DIM P%(517) :CLS '* parameter & screen storage
20 KD$="-----234 or more dashes-----"
-----
-----"
30 V=VARPTR(KD$)
40 POKE 16526,PEEK(V+1) :POKE 16527,PEEK(V+2)
50 DEFUSR0=PEEK(V+1)+PEEK(V+2)*256 '* non-disk omit this line
99 '**
    ** This code reads the DATA lines and pokes the op codes
    ** into the dummy$ --KD$-- on line 20
    **
100 ADDR=PEEK(V+1)+PEEK(V+2)*256 '* starting address
110 IF LEN(KD$)<234 THEN CLS :PRINT "KD$ IS TOO SHORT" :EDIT 20
120 CLS :PRINT@ 975,"CODE IS BEING POKED INTO KD$"; :PRINT@ 0,;
130 READ A$ :IF A$="END" THEN 200
140 B$=LEFT$(A$,1) :C$=RIGHT$(A$,1)
150 M=ASC(B$)-48+(B$>"9")*7 :L=ASC(C$)-48+(C$>"9")*7
160 CS=CS+M+L '* calculate checksum
170 PRINT A$;" " ; '* display each byte
180 POKE ADDR,M*16+L :ADDR=ADDR+1 '* store an op code
190 GOTO 130
200 IF CS = 3330 THEN PRINT "*SUCCESSFUL* ";
    ELSE PRINT "*** BAD DATA ***" :STOP
210
    DELETE 99-670 '* delete unwanted lines

500 DATA CD,7F,0A,E5,DD,E1,DD,2B,11,0C,01,15,19,E5,FD,E1
510 DATA DD,CB,0B,4E,20,0B,EB,21,01,3C,2B,01,FF,03,03,ED
520 DATA B0,DD,6E,05,DD,66,06,46,23,5E,23,56,EB,DD,56,01
530 DATA DD,5E,03,2B,23,DD,4E,09,CB,46,28,03,7B,91,5F,CB
540 '
550 DATA 4E,28,03,7B,81,5F,CB,56,28,03,7A,81,57,CB,5E,28
560 DATA 03,7A,91,57,CB,6E,28,15,10,DA,DD,CB,0B,46,C0,FD
570 DATA E5,E1,11,01,3C,1D,01,FF,03,03,ED,B0,C9,C5,D5,D5
580 DATA DD,46,09,E5,C5,DD,7E,07,FE,02,38,23,7A,FE,40,30
590 '
600 DATA 5C,7B,FE,10,30,57,63,6A,CB,25,CB,25,CB,2C,CB,1D
610 DATA CB,2C,CB,1D,FD,E5,C1,09,DD,7E,07,18,3F,18,B9,7A
620 DATA FE,80,30,39,7B,FE,30,30,34,26,FF,7B,24,D6,03,30
630 DATA FB,C6,03,47,6A,CB,25,CB,2C,CB,1D,CB,2C,CB,1D,CB
640 '
650 DATA 10,04,AF,37,8F,10,FD,FD,E5,C1,09,CB,7E,20,02,36
660 DATA 80,DD,CB,07,46,28,03,B6,18,02,2F,A6,77,C1,E1,14
670 DATA 10,91,D1,1C,0D,20,88,D1,C1,18,B2,END
799 '**
    ** This demonstrates the drawing and scaling
    ** features of KWIKDRAW
    **
800 FS$="IDDDFJHHHI"
810 M$(1)="D" :M$(2)="4D" :M$(3)="44D" :M$(4)="444D"
820 X=63 :Y=23 '* coordinates for shape
830 SR=1 '* draw with LIT pixels
840 SC=1 '* scale at minimum
850 PG=0 '* page OUT and IN

```

The COEX

Anatomy of a Printer

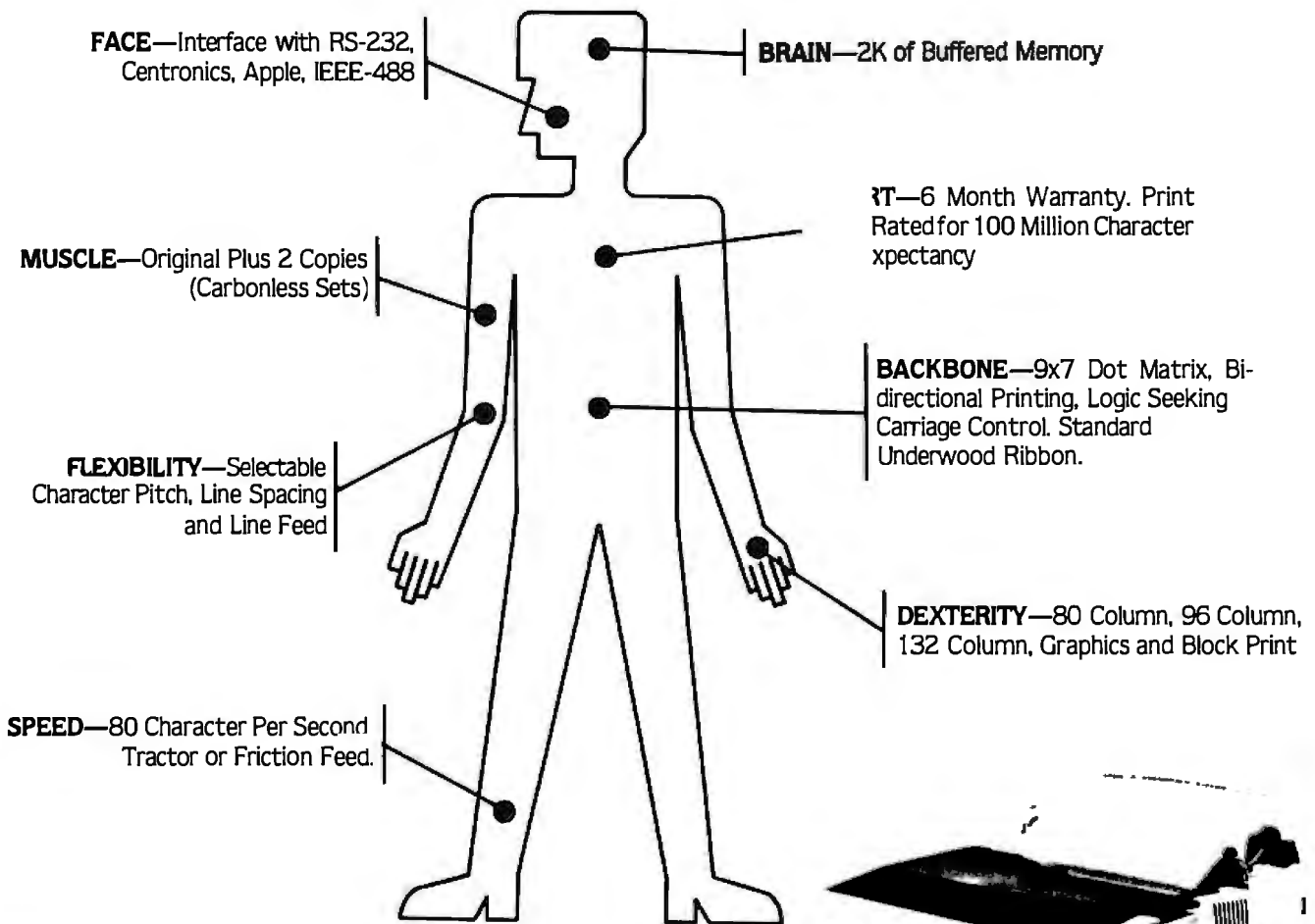

SPECIFICATIONS:

- CHARACTER FORMATION PROCESS . . . Serial, impact dot matrix
- STANDARD FONT 9 x 7 (7 needles), 6 x 6 for graphics printing
- PRINTING DIRECTION Bi-directional
- NUMBER OF COLUMNS 80, 96 or 132. (40, 48 or 66 for enlarged characters)
- CHARACTER SIZE 2.57 mm (.101") x 2.0 mm (.079") for standard 80-column line
- CHARACTER DENSITY 5 CPI for 40 column, 10 CPI for 80 column, 12 CPI for 96 column and 16.7 CPI for 132 column
- LINE SPACING 1/6", 1/8" and 1/12"
- PRINTING SPEED 80 characters per second
- NUMBER OF COPIES 2 (original plus 2 copies for carbonless sets)
- PAPER WIDTH 8" to 10" for friction-fed paper and 3" to 10" sprocket-fed paper
- INKED RIBBON Standard Underwood spool type 1/2" (13 mm) wide by 11.5 yards (10.5 m) long
- DIMENSIONS 387 mm (15.3") wide by 309 mm (12.2") deep by 124 mm (4.9") high. With tractor-feed assy, height is 171 mm (6.7")
- POWER CONSUMPTION 90 watts maximum operation 25 watts standby
- WEIGHT 8.5 Kg (19 lbs.)

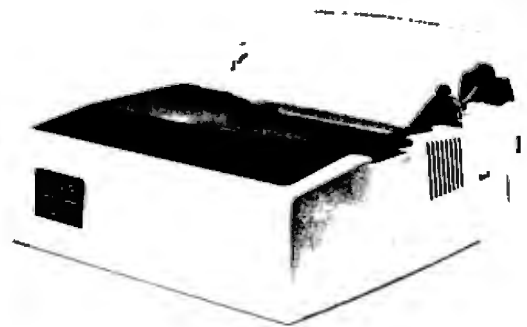

Best of all, the price . . .

\$349⁰⁰

COEX 80-FT

OPTIONS:

- COEX Interface Card to Apple **\$49.95**
- Demo Disc for Apple Available to Dealers

Dealer Inquiries Invited

"Have You Kissed Your Computer Lately?"

Components Express, Inc.

1380 E. Edinger • Santa Ana, Calif. 92705 • 714/558-3972

Terms of Sale: Cash, Checks, Credit Cards, M.O., C.O.D. Calif. residents add 6% sales tax.

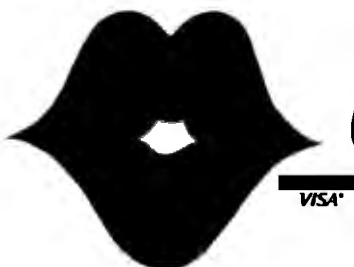

Listing 2 continued:

```
860 XD=-1 :YD=-1 :SD=1 '** X,Y and scale directions
870 M=M+1 :IF M>4 THEN M=1
880   A$=FSS+M$(M)
890   GOSUB 1000           '** draw the shape
900   SC=SC+SD*.4 :IF SC<1 OR SC>7 THEN SD=-SD :GOTO 900
910   X=X+XD*SC :IF X<-10 OR X>137 THEN XD=-XD :GOTO 910
920   Y=Y+YD*SC :IF Y<-5 OR Y>52 THEN YD=-YD :GOTO 920
930   FOR DELAY=1 TO 100 :NEXT
940 CLS :GOTO 870
997 '**
    ** Routine draws a predefined figure.
    ** On entry :
    **     X and Y   screen coordinates
    **     A$       holds shape characters
    **     SR       is SET/RESET/CHARACTER byte:
998 '**           0 = draw with RESET pixels
    **           1 = draw with SET pixels
    **           else = CHARACTER for drawing
    **     SC       is scaling factor
    **     PG       is paging instruction:
999 '**           0 = page OUT, draw, page IN
    **           1 = page OUT, draw
    **           2 = draw, page IN
    **           3 = draw only
    **
1000 P%(0)=X :P%(1)=Y :P%(2)=VARPTR(A$)
    :P%(3)=SR :P%(4)=SC :P%(5)=PG
1010 UU=USR0(VARPTR(P%(0)))
1020 RETURN
```

READ AMERICA'S NUMBER 1 NON-SELLER.

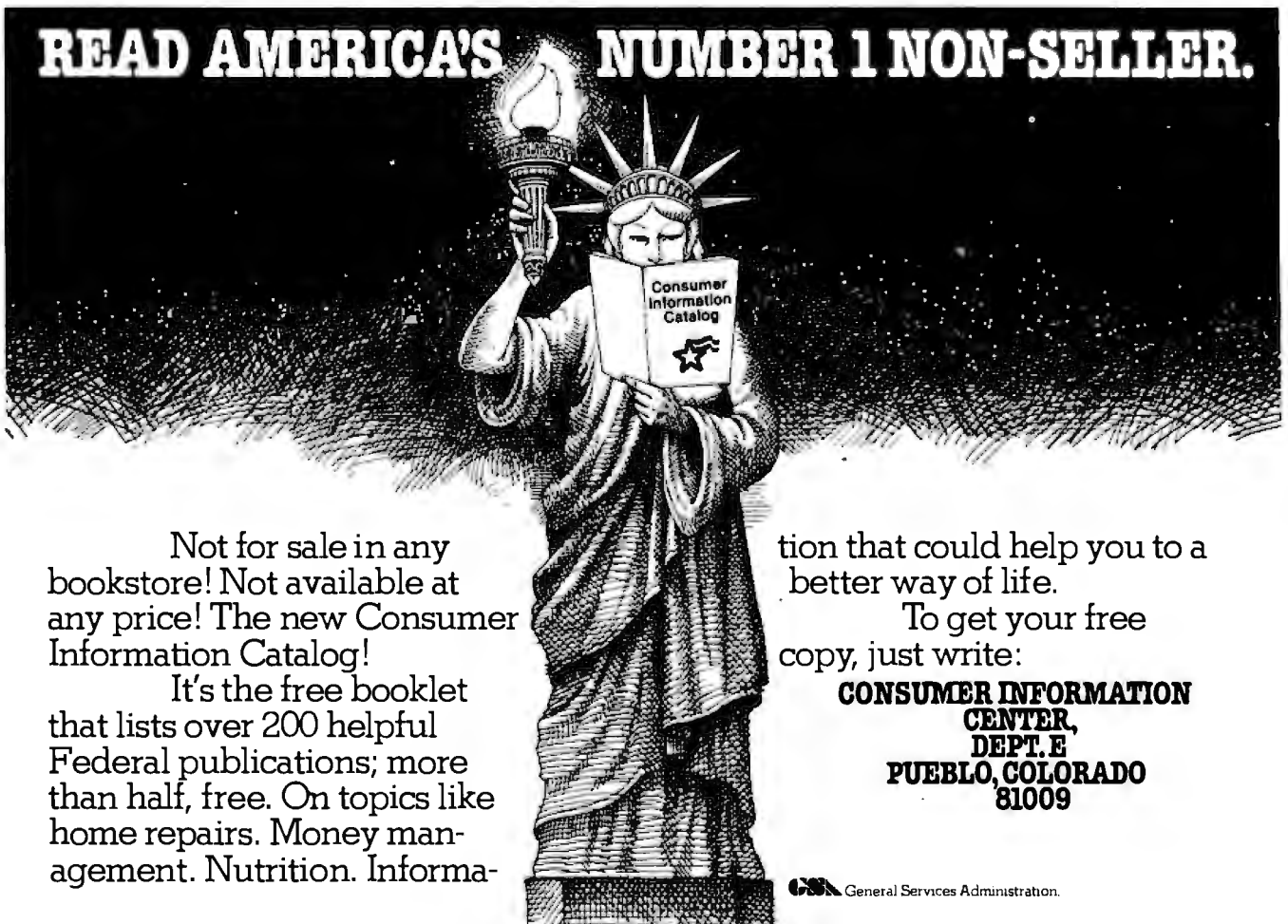

Not for sale in any bookstore! Not available at any price! The new Consumer Information Catalog!

It's the free booklet that lists over 200 helpful Federal publications; more than half, free. On topics like home repairs. Money management. Nutrition. Informa-

tion that could help you to a better way of life.

To get your free copy, just write:

**CONSUMER INFORMATION
CENTER,
DEPT. E
PUEBLO, COLORADO
81009**

CSA General Services Administration.

FREE SHIPPING

IBM® Personal Computer Products

Davong 5 MB Hard Disk System	\$1525.00
12 MB Hard Disk System	2099.00
IBM PC-2 Drive System	\$CALL

Quadram - Quadboard with Parallel

Port, Serial Port, Clock/Calendar,
Expandable to 256 K.

64 K on brd.	\$425.00
128 K on brd.	539.00
192 K on brd.	629.00
256 K on brd.	719.00

Quadram Memory Expansion

192 K Maximum	
64 K on brd.	\$230.00
128 K on brd.	350.00
192 K on brd.	490.00

Amdek Monitors

Mod. 300 Phosphor	\$150.00
Composite Color III	345.00
IBM RGB Compatible Color II	650.00
Color I	300.00

IBM/TRS 80 Disk Drives/Cabinets

TM 100-1 Single 40 Track Drive	\$189.00
with Cabinet & P/S	235.00
TM 100-2 Double 40 Track Drive	289.00
TM 100-3 Single 80 Track Drive	289.00
TM 100-4 Double 80 Track Drive	379.00
8" Dual Slim Line Power Supply & Cabinet	225.00
5¼ External Power Supply & Cabinet	49.00

VISA, MASTERCARD (\$100 Min., Add 2%)
Or Certified Check

90 Day Warranty (Parts & Labor)
TRS 80 is a Registered Trademark, Tandy Corp.
Prices Subject to Change Without Notice

DATA MAIL

1-(800) 635-5555

P.O. BOX 818, RESEDA, CA 91335

FREE SHIPPING IN CONTINENTAL U.S.
(TRS 80 MOD III EXCEPTED)

(213) 993-4804
(In Calif.)

Circle 211 on inquiry card.

Apple II® Computer Products

Apple Compatible Controller Card	\$79.95
Apple Compatible Disk Drive w/Cabinet & Cable	265.00
w/Controller	325.00
16 K Ram Card	60.00
Printer/Graphics Interface	99.95
Davong 5 MB Hard Disk System	1525.00
Davong 12 MB Hard Disk System	2099.00
Apple Compatible Joysticks	42.95

Epson/Smith-Corona Printers



MX80	\$425.00
MX80 F/T	470.00
MX100	640.00

Smith Corona TP-1 Letter Quality Daisy Wheel	565.00
TRS 80 / IBM Parallel Printer Cable	20.00
(with purchase of printer)	

STAR MICRONICS GEMINI 10	399.00
GEMINI 15	499.00



Our TRS 80® Mod III

48 K; 2 Tandon 5¼ Disk
Drives w/ RS 232.. **\$1700.00**

Memory & Media

IBM 64 K Upgrade Kit (9-4164)	\$79.95
16 K Upgrade Kit (4116)	12.95

Maxell Diskettes	
MD1 - S/S - D/D	\$36.00/Box of 10
MD2 - D/S - D/D	46.00/Box of 10

Commodore VIC-64 **\$CALL**



SA2 ROBOT

\$1495

The SA2 is a robot developed for the educational market, and has been designed to meet a requirement for a robot which will emulate, in behaviour and physical attributes, larger industrial robots.

The arm can access 360°, with a reach of 18 inches and a maximum lift of ½lb

Circle 212 on inquiry card.

The Syntheasy

A low cost speech unit complete with Votrax speech output chip, unlimited vocabulary, power supply, speaker and case, all for only -

\$149.95



DEALER INQUIRIES INVITED
For further information contact

INTELLIGENT ARTEFACTS LTD.

19205 Parthenia St., Suite H
Northridge, CA 91324

Tel (213) 993-4803

Listing 3: The CREATE program, used to design your own graphics shapes. It also creates a shape-definition string for use with the KWIKDRAW program.

```

5  '**
   **
   **          CREATE
   **  This program is used in generating a
   **  shape definition string for display by
   **          KWIKDRAW
   **          .....by Dan Rollins
   **
10  CLS :INPUT"Need instructions";Q$ :IF Q$="Y" :GOSUB 9000
15  CLEAR 2000 :DEFINT A-Z :DIM V(255)
20  CK$=" /SCIDHLXAM"+CHR$(13)          '** valid command keys
25  VK$="123456789!"+CHR$(34)+"#$$&'()0" '** valid vector keys
30  CL$=CHR$(30) :I=1
35  IM$="X:### Y:## offsets:#### ## @:#### P:### len:###"
40  FOR J=1 TO 9 :READ A$,DX(J),DY(J) :CH(J)=ASC(A$) :NEXT
45  DATA J,-1, 1, B, 0, 1, F, 1, 1, H,-1, 0, C, 0, 0
50  DATA D, 1, 0, I,-1,-1, A, 0,-1, E, 1,-1
55  INPUT"coordinates for model (X,Y--defaults: 30,10)";X1,Y1
60  INPUT"coordinates for working shape (defaults: 30,30)";X2,Y2
65  PRINT :PRINT"String literal to edit or <ENTER> to start anew"
70  PRINT :SHAPE$="C" :INPUT SHAPE$
75  IF SHAPE$="" GOTO 85
80  FOR J=1 TO LEN(SHAPE$) :V(J)=ASC(MID$(SHAPE$,J,1)) :NEXT
85  LAST=LEN(SHAPE$) :X1=30 :Y1=10 :X2=30 :Y2=30
90  PTR=0 :GOSUB 700 :GOSUB 800          '** start in EXTEND mode
95  '**
   ** main loop interprets commands, displays data
   **
100 PRINT@ 0,"COMMAND: ";
105 PRINT USING IM$;X,Y,X-X2,Y-Y2,INT(X/2)+INT(Y/3)*64,PTR,LAST;
110 GOSUB 1000 :GOSUB 3000 :IF K2=0 THEN 100
115 ON K2.GOSUB 200,250,300,400,500,600,650,700,800,75,10000
120 IF K2=12 GOTO 6000
125 GOTO 100
199 '**
   ** routine moves the cursor forward          <spacebar>
   **
200 IF PTR=LAST THEN RETURN
210 PTR=PTR+1 :V=V(PTR) :GOSUB 4000
220 IF V AND 64 THEN SET(X,Y)
230 RETURN
240 '**
   ** back up cursor          </>
   **
250 IF PTR<1 THEN RETURN
260 V=V(PTR) :IF V AND 64 THEN RESET(X,Y)
270 V=NOT V(PTR) AND 15          '** invert all bits to back up
280 GOSUB 4000 :PTR=PTR-1 :RETURN
290 '**
   ** Search for a vector          <S>
   **
300 PRINT@ 0,"search vector?";CL$;
310 GOSUB 1000 :GOSUB 2000 :IF K1=0 GOTO 310
320 IF K1=10 THEN RETURN
330 V1=V :PTR=PTR+1 :GOTO 350
340 PTR=PTR+1 :V=V(PTR) :IF V=V1 THEN PTR=PTR-1 :RETURN
350 GOSUB 4000 :IF V AND 64 THEN SET(X,Y)
360 IF PTR=LAST THEN RETURN

```

Listing 3 continued on page 414

RadioShack TRS-80's

Full Line

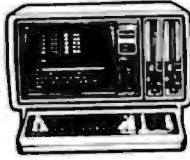
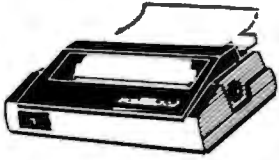

YOU CAN SAVE money when you buy Radio Shack TRS-80 Computers from **Pan American Electronics**. Pan American Electronics went into business in 1976 and led the way in bringing consumers original Radio Shack TRS-80 Computers at reduced prices. **NO** other company has done it longer. **NO** other company has done it better and **NO** other company sells them for less.

Pan American Electronics

TOLL FREE NUMBER 800/531-7466

1117 Conway Avenue • Department B
Mission, Texas 78572
Phone: 512/581-2766
Telex Number 767339

TM — Trademark of Tandy Corporation

Micro Power Bench™



- Single Switch Control of CPU and Peripherals
- Built in circuit breaker protects your system
- Four power expansion outlets
- Optional power surge protection (\$39)
- Optional vent fan (\$39)
- Compatible with IBM, APPLE, TRS-80 and others

Dealer or ordering info.

800-343-4311
Master Charge and Visa Accepted

CAB-TEK, Inc.
Riverside St., Nashua NH 03062
CIVILIZING COMPUTERS
MX 80
ACOUSTIC ENCLOSURE \$99!



RIES INVITED

MAGIC PRINT

oOo

How Magic
Is MagicPrint™?

Lifeboat Associates

proportionally-spaced,

professional text formatter? And page footnotes too!!!

...True, you love your high quality daisywheel printer...

Its sleek lines, power, speed ... but do you make use

Of all its abilities such as true proportional printing

boldface, underline, double-strike, over-strike,

single character kerning and micro centering,

accenting and other goodies -- fifty+ in all.

MagicPrint works with most any text editor or

word processing program. Features include:

*multiple line page headers and footers

*print line left or right or centered

*line-by-line trapping of errors

*hanging indents and outdents

*multiple column capability

And for WordStar™ users

proportional printing

using WS commands!

For MagicPrint

Call Lifeboat

\$195 retail,

deals for

dealers

too

!

oOo

Roses R Red

Violets are Blue

Our MagicPrint offers

Multiple column printing

Listing 3 continued:

```
370 GOTO 340
390 '**
    ** Change a single vector at cursor          <C>
    **
400 IF PTR=LAST RETURN
410 PRINT@ 0,"vector to change?";CL$;
420 GOSUB 1000 :GOSUB 2000 :IF K1=0 GOTO 420
430 IF K1=10 THEN RETURN
440 V(PTR+1)=V :GOSUB 200
450 RETURN
490 '**
    ** Insert a single vector                  <I>
    **
500 PRINT@ 0,"vector to Insert?";CL$
510 GOSUB 1000 :GOSUB 2000 :IF K1=0 GOTO 510
520 IF K1=10 THEN RETURN
530 FOR J=LAST TO PTR+1 STEP-1
540     V(J+1)=V(J)
550 NEXT :LAST=LAST+1
560 V(PTR+1)=V
570 GOSUB 4000 :IF V AND 64 THEN SET(X,Y)
580 PTR=PTR+1 :RETURN
590 '**
    ** Delete a single vector                  <D>
    **
600 IF PTR=LAST THEN RETURN
610 PRINT@ 0,"Deleting a vector";CL$;
620 FOR J=1 TO 300 :NEXT
630 FOR J=PTR+1 TO LAST :V(J)=V(J+1)
640 NEXT :LAST=LAST-1 :RETURN
645 '**
    ** Hack off line & extend                  <H>
    **
650 PRINT@0,"Hacking from cursor on";CL$
660 FOR DELAY=1 TO 300 :NEXT
670 LAST=PTR :GOTO 800
690 '**
    ** List (draw) entire figure                <L>
    **
700 CLS :X=X1 :Y=Y1
710 FOR J=1 TO LAST
720     V=V(J) :GOSUB 4000
730     IF V AND 64 THEN SET(X,Y)
740 NEXT
750 PTR=0 :X=X2 :Y=Y2
760 RETURN
790 '**
    ** Extend the shape                          <X>
    **
800 IF PTR=LAST GOTO 840
810 FOR J=PTR TO LAST :V=V(J)
820     GOSUB 4000 :IF V AND 64 THEN SET(X,Y)
830 NEXT :PTR=LAST
840 PRINT@ 0,"EXTEND: (0 for COMMAND) X:";
850     PRINT X;" Y:";Y;" len:";LAST;CL$;
860     GOSUB 1000 :GOSUB 2000 :IF K1=0 THEN 860
870     IF K1=10 THEN RETURN
880     PTR=PTR+1 :LAST=PTR :V(PTR)=V
890     GOSUB 4000 :IF V AND 64 THEN SET(X,Y)
900 GOTO 840
990 '**
```

Listing 3 continued on page 416

QUALITY
SERVICE
AVAILABILITY



ACTIVE, YOUR
NUMBER ONE
CHOICE

Active Electronic

Active Electronics
Your one stop source for the widest variety of factory fresh electronic components

FEATURING
THE 1982 I.C. MASTER
139.95
WHILE QUANTITIES LAST

Extensive Product Offering

Semiconductors, Integrated Circuits, Micro-computer Boards, Microprocessor and Support Circuits, Transistors, Diodes, Capacitors, Resistors, Optoelectronics, Potentiometers, Relays, Multimeters, Switches, Knobs, Connectors, Sockets, P.C. Boards, Enclosures, Data and Reference Books, Soldering Aids, AND MUCH MORE

Superior Service

Greater choice. Easier, faster ordering and more reliable deliveries. Active's all NEW comprehensive Fall/Winter catalog is now available — FREE OF CHARGE. Circle No. 6 on free information card or write to: P.O. Box 8000, Westboro, MASS. 01581 U.S.A.

Call Toll Free 800-343-0874
MASS. customers call (617) 366-0500

From Computer Plus to YOU...

PLUS after PLUS after PLUS

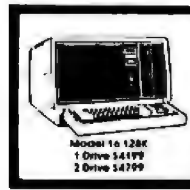

Model 16 128K
1 Drive \$4199
2 Drive \$4799



Color Computer 16K 5235
with Ext. Basic 1305
with 32K Ext. Basic 1420

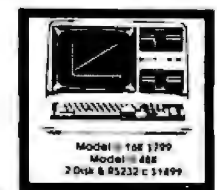

Model 16 128 1709
2 Disk & 85232 c \$1899



Color Computer Disk Drive
Drive 0 6470 Drive 1 6299



Smith Corona 161
Daisy Wheel 1578

BUY DIRECT Here are just a few of our line offers... call TOLL FREE for full information.

COMPUTERS	PRICE	PRICE	PRICE
Model II 64K	\$2675	R.S. Modem I D.C.	130
Model III 4K LEV I	599	R.S. Modem II D.C.	210
MODEL III 16K	799	Signalman Modem	89
MODEL III 48K	864	PRINTERS	
Model III 48K	1899	Daisy Wheel II	1745
2 Disk & RS232 c	235	DWP-410	1335
Color Computer 16K	305	Smith Corona 161 Daisy Wheel	575
w/extended basic	420	Epson MX80	499
Color Computer 32K-64K	230	Epson MX100	549
w/extended basic	4199	CGP-115	735
Model 16 1DR 128K	4799	DMP-100	315
DI-1 Data Terminal	599	DMP-200	599
RT-210 Portable Terminal	779	DMP-400	1029
MODEMS		DMP-500	1569
Lynx Direct Connect III/Mini	235	Okidata 80	320
Hayes Smart Modem II	235	Okidata 82A	399
Hayes Smart Modem 1200	599	Okidata 83A	655
R.S. Acoustic Coupler AC-3	134	Okidata 84 Parallel	999
		Okidata 92	510
		Okidata 93	859
		P. C. Plotter Printer	999
		DISK DRIVES	
		R.S. Model III 151-Drive	650
		Tandon 40 Track III	289
		Color Computer Drive 1	289
		Color Computer Drive 0	470
		Primary Hard Disk Mill	3699
		Primary Hard Disk Mill	1999
		ETC.	
		CCR-81 recorder	52
		C. C. Joysticks	22
		16K RAM N.E.C. 200 N.S. chips	25
		64K Ram Chips	75
		Color Computer Flex D O S	99
		Brand Name Software *	
		Send for listing.	
		R.S. Software 10% off list	
		*Color Computer 64K requires Disk II & D.S.	

Circle 108 on inquiry card.
We have the lowest possible Fully Warranted Prices AND a full complement of Radio Shack Software.

TOLL FREE
1-800-343-8124

computer plus

P.O. Box 926
48 King Street
Littleton, MA 01460
617-486-3193

write for your free catalog

*Prices subject to change without notice.
Not responsible for typographical errors.
RS-80 is a registered trademark of Tandy Corp.



DISCOUNT PRINTER RIBBONS

Brand New, Top Quality, Exact Replacement Ribbons & Cartridges. These Ribbons Produce Super Jet Black Impressions and Ultra Reliable Print Life. They Are Delivered to Your Door Promptly for Much Less Than Most Retail Stores

★SPECIAL! BUY 10 and GET ONE FREE!

YOUR PRINTER	PACK SIZE	RETAIL LIST**	YOUR WHOLESALE PRICE	SIZE	COMMENTS	CAT. ORDER#
ANADEx 9000 Series	1 pk	14.00 ea	14.00	500'	Nylon Jet Blk	C-777
CENTRONICS 700-703, 737, 779	3/pk	18.95/3 pk	11.95/3 pk	563" x 45'	Nylon Jet Blk	C-700
CENTRONICS 100, 101A, 102, 103, 300, 301, 306, 308, 330, 358, 398, 500, 501, 503, 508, 588, 620, 820.	3/pk	26.33/3 pk	17.55/3 pk	1" x 108'	Nylon Jet Blk	C-100
CENTRONICS 704-705	1/pk	16.95 ea	13.95/Giant Cart	5'18" x 210'	5 mil High Speed	C-7045
DEC 1/2 x 40Y0.	3/pk	17.77/3 pk	12.95/3 pk	1/2" x 120'	Giant Cart	R-7045
DEC 1/2 x 60Y0.	3/pk	20.12/3 pk	14.25/3 pk	1/2" x 180'	Double Spools	R-600
DIABLO HYTYPE II (M/S BLK) HI YIELD. FITS 70 PRINTERS!	1/pk	9.31 ea	6.87 ea	5/16" x 'High Yield'	Double Spools	R-644
PSON MX70.80	1/pk	16.00 ea	16.00 ea	500" x 60'	300,000 plus imp.	C-511
3M - "SILVER DOLLAR" Sys. 34, Sys. 32 MOLA, Series IMOL4974, 5256, 3287, 3770, 3771-3774, 4974, 5100, 5103, 5110, 5228, 5256, 5320MOLA	5/pk	5.80 ea	14.90/5 pk	9/16" x 30'	Nylon Jet Blk	C-522
BM - HARMONICA 1/4". SERIES I. MOD 4973/II. 3200, 3289, MOD 2.	3/pk	9.42 ea	20.85/3 pk	1 2" x 108'	Nylon Jet Blk	R-300
VEC SPINWRITER	4/pk	23.40/3 cart	23.60/4 pk rb. reload	1/2" x 51'	Nylon/Ex Lng Life	R-400
JUME (FITS 80 PRINTER MOOS)	3/pk	18.00/3 pk	13.95/3 pk	1/4" x 310'	Multistrike Film	C-525
RADIO SHACK DAISY WHEEL II	1. pk	24.95/3pk	8.25	250'	Mylar Multistrike	C-789
RADIO SHACK LP11, LPV	one:pk	13.95/cart	8.95/Reload rib. only	500" x 45'	Nylon Incl Instr	R-733
RADIO SHACK LP11, LP1V	3/pk	18.95/3 pk	11.95/3 pk	563" x 45'	Nylon Jet Blk	C-700
TELETYPE MOD 33, 28, 35, 37, 38, 88.	10/pk	2.40 ea	13.90/10 pk	1/2" x 36'	Nylon Jet Blk	R-450
WANG M/S. 5541W, WC, 5581, WO, 6581W, 2281W	1/pk	6.85 ea	5.95 ea	5/16" x 393'	Multistrike Film	C-550

40% OFF!!
OR MORE

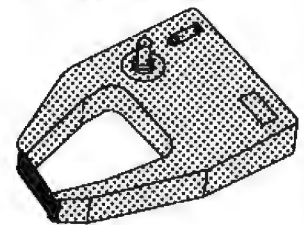

TERMS:

MINIMUM PURCHASE - \$20
PAYMENT BY: C.O.D.(UPS), CHECK, MASTER CARD, OR VISA CHARGE CARD.

VOLUME DISCOUNTS:

20 - 50 PACKS 10%

51 - 100 PACKS 15%

*UNDER \$20, ADD \$5 HANDLING.

**APPROX. RETAIL. PRICE VARIES.

ANCIE LABORATORIES

5200-J Philadelphia Way 301-345-6000 (Wash. D.C. Loc)
Lanham, Maryland 20706 301-792-2060 (Baltimore, MD Loc)
800-638-0987 (National)

NAME _____
ADDRESS _____
CITY _____ STATE _____ ZIP _____

QTY _____ CAT.# _____ AMT. _____

TOTAL _____

Check Enclosed
 C.O.D.
 VISA
 MASTER CHARGE
ACCT. # _____
EXP. DATE _____
MIN. ORDER \$20
PRICES SUBJECT TO CHANGE

ANCIE Laboratories 301-345-6000 (Wash. D.C. Local)
5200-J Philadelphia Way 301-792-2060 (Baltimore, MD Local)
Lanham, Maryland 20706 800-638-0987 (National)

```

    ** get 1 key with blinking cursor
    **
1000 IF POINT(X,Y) THEN RESET(X,Y) :GOSUB 5000 :SET(X,Y)
    ELSE SET(X,Y) :GOSUB 5000 :RESET(X,Y)
1010 K$=INKEY$ :IF K$="" THEN GOSUB 5000 :GOTO 1000
1020 K=ASC(K$) :RETURN
1990 '**
    ** decode keypad as a vector byte
    **
2000 K1=INSTR(VK$,K$)
2010 MP=0 :IF K1>9 THEN MP=1 :K1=K1-9
2020 V=CH(K1)-16*MP
2030 RETURN
2040 '**
    ** non-disk: for above use
    ** 2000 K1=0 :FOR J=1 TO LEN(VK$)
    ** 2002 IF MID$(VK$,J,1)=K$ THEN K1=J
    ** 2004 NEXT
    ** same for below, using CK$
    **
2990 '**
    ** Decode a command
    **
3000 K2=INSTR(CK$,K$) :RETURN
3990 '**
    ** adjust X and Y according to vector V
    **
4000 IF V AND 1 LET Y=Y-1
4010 IF V AND 2 LET Y=Y+1
4020 IF V AND 4 LET X=X+1
4030 IF V AND 8 LET X=X-1
4040 X=X+(X>127)*128 - (X<0)*128      '** screen wrap-around
4050 Y=Y+(Y>47)*48 - (Y<0)*47
4060 RETURN
4990 '**
    ** short delay routine
    **
5000 FOR DELAY=1 TO 30 :NEXT :RETURN
5990 '**
    ** exit editor, compile shape$           <ENTER>
    ** and write to disk
    **
6000 SHAPE$=""
6010 FOR J=1 TO LAST
6040 SHAPE$=SHAPE$+CHR$(V(J))
6050 NEXT
6060 PRINT@ 0, CL$; :INPUT"disk save on line number";LN!
6070 PRINT CL$; :LINEINPUT"string variable name? ";SN$
6080 DW$=STR$(LN!)+" "+SN$+"="+CHR$(34)+SHAPE$+CHR$(34)
6083 PRINT DW$ :PRINT
6085 Q$="" :INPUT"format ok";Q$ :IF Q$="N" CLS :GOTO 6060
6090 IF F1=0 THEN F1=1 :PRINT CL$; :LINEINPUT "filespec? ";FS$
    :OPEN"O",1,FS$
6100 PRINT#1,DW$
6110 '
6120 CLS :Q$="" :INPUT "edit another string (Y/N)";Q$
6130 IF Q$="N" THEN CLOSE :END
6140 GOTO 65
8999 '**

```

```

** instructions
**
9000 CLS :PRINT "      CREATE...a graphics editor for KWIKDRAW"
9010 PRINT"This program is an aid in creating and modifying a"
9020 PRINT"string of vector characters: `A'-'J' and `1'-'`:"
9030 PRINT"You may input or build this string with the editor."
9040 PRINT"      The NUMERIC KEYPAD is used to      <9>  <8>  <7>"
9050 PRINT"move a cursor in the desired          *   :   *"
9060 PRINT"pattern. Use these keys whenever      <6> - * - <4>"
9070 PRINT"you are prompted for a VECTOR and    *   :   *"
9080 PRINT"while extending the shape.          <1>  <2>  <3>"
9090 PRINT"      The <0> key is used to cancel commands and to"
9100 PRINT"exit EXTEND mode."
9110 PRINT"      You may define the X and Y screen positions for"
9120 PRINT"your `model' and your `working copy'. The top line"
9130 PRINT"shows: the current X and Y, offsets from the start,"
9140 PRINT"the PRINT@ position, position within the shape,"
9150 PRINT"and length of the shape string.";
9160 PRINTTAB(50);"Press <ENTER>"; :X=126 :Y=46 :GOSUB 1000
9999 '***
      ** Menu of commands                                <M>
      **
10000 CLS :PRINT TAB(9);"Create - graphics editor for KWIKDRAW"
10010 PRINT"commands:";TAB(38);"...by Dan Rollins"
10040 PRINT"      <spacebar>...cursor forward"
10050 PRINT"      </>.....cursor backward"
10060 PRINT"      <A>.....Abort edit without change"
10070 PRINT"      <ENTER>.....exit editor & save shape to disk"
10080 PRINT"      <D>.....Delete a single vector"
10090 PRINT"      <L>.....List (draw) shape, cursor to start"
10100 PRINT"      <S>.....Search for a vector"
10110 PRINT"      <C>.....Change a vector"
10120 PRINT"      <I>.....Insert a single vector"
10130 PRINT"      <X>.....eXtend shape (enter EXTEND mode)"
10135 PRINT"      <1> - <9>....vector keys for S,C,I,X commands"
10140 PRINT"      <0>.....escape from S,C,I,X commands"
10160 PRINT"      <SHIFT>.....move-only vector (with <1> - <9>)"
10170 PRINT"      <M>.....display this list";
10175 PRINT TAB(50);"press <ENTER>";
10180 X=126 :Y=46 :GOSUB 1000
10190 IF I=0 THEN I=1 :CLS :RETURN
10200 GOTO 700

```

XEROX SPECIAL • 8088 CO-PROCESSOR \$699

FOR 820 820II (64K RAM INCLUDED - UPGRADABLE TO 256K)



820-II FEATURES: 4MHz, 280A, CPM BASED, 64K RAM, 12" HIRES SCREEN (24 x 80), DD DISK CONTROLLER, THIN LINE GRAPHICS, ENHANCED SCREEN FEATURES (HL INTENSITY, REVERSE VIDEO, FLASHING CHARACTERS), TONE GENERATOR, 2 RS-232 PORTS, ONE PARALLEL PORT, ALSO BOOTS AS INTELLIGENT TERMINAL.

820/820 II OPTION PKG. I Save \$461

- 280C CPU SPEEDUP - to 8MHz for 820II \$149
- 280C CPU SPEEDUP - to 8MHz for 820II \$189
- DISPLAY RISER - Elevates 5" Steel Construction \$ 29
- ACRYLIC GREEN SCREEN - Molded to RCRT \$ 19
- ANTI-GLARE SCREEN - Nylon, stretches over CRT \$ 19
- SYSTEM DUST COVERS - (3) (8" slightly higher) \$ 29

OPTION PACKAGE II Save \$791

- INCLUDES ALL THE OPT. PKG. I PLUS--
- 10 Diskettes (DS & 8" slightly higher) \$ 25
- Surge Protected Multiple Outlet Strip \$ 29
- Enter Key for Numeric Keypad \$ 19
- Cooling Fan - fits in display processor, \$ 35
- Disk Drive Head Cleaning Kit - 5" or 8" \$ 25

8088 Co-Processor 64k	\$ 899	820 Double Density Kit	\$ 249	5 MB Hard Disk - exp. to 20 MB	\$ 1955
128k Version	\$ 799	820X Extended DD (870K/5ide)	\$ 99	32k Printer Buffer	\$ 250
256k Version	\$ 1050	Amber or Green CRT replacement	\$ 88	Hayes Smartmodem	\$ 239
256k Version + CPM-86	\$ 1230	Parallel Printer Cable	\$ 49	Anti-Static Floor Mat	\$ 25

XEROX 820 II SYSTEMS

	LIST	SALE
5 1/4" DS/DD	\$3295	\$1995*
5 1/4" DS/DD	\$3895	\$2295*
8" SS/DD	\$4095	\$2695*
8" DS/DD	\$4895	\$2995*
10 MB/Floppy	\$7695	\$4895

*with Tandem drive

microNEST

Box 545, 1700 Front Street
Fort Benton, MT 59442
CALL COLLECT TO ORDER:
(406) 622-5851 9-4 MST, M-F

VISA, MC, CK, MD, CDD, AmEx for VISA or MC, AmEx for DYNAmicSoft, Vx LPB, Midcom (E.I.A.)

XEROX 8088 is a trademark of XEROX Corp. CPM is trademark of Digital Research Corp.

Xerox 25 cps Delay	\$1195	VISAcount	\$ 99	CITON Prowler	\$ 479	DEALER INQUIRIES WELCOME!
Xerox 40 cps Delay	\$2395	Beachdisk	\$349	Prowler 2	\$ 659	
Cume Sprint 11 + 40	\$1395	CP+	\$119	F-10 Delay	\$1399	

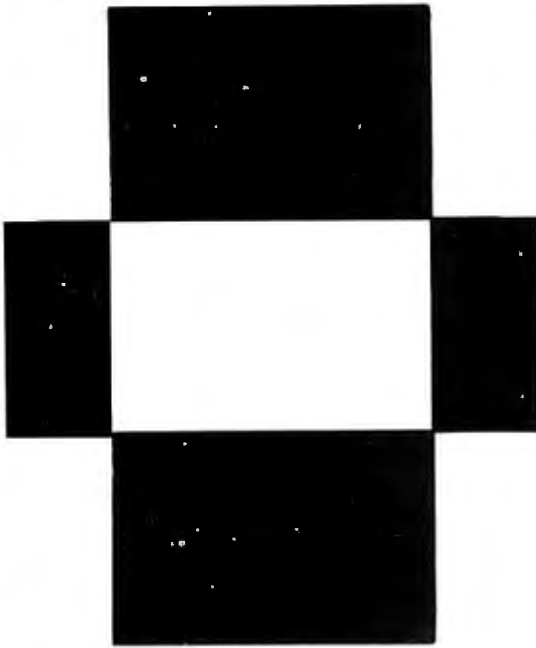

Figure 1: A simple figure drawn using the CREATE program.

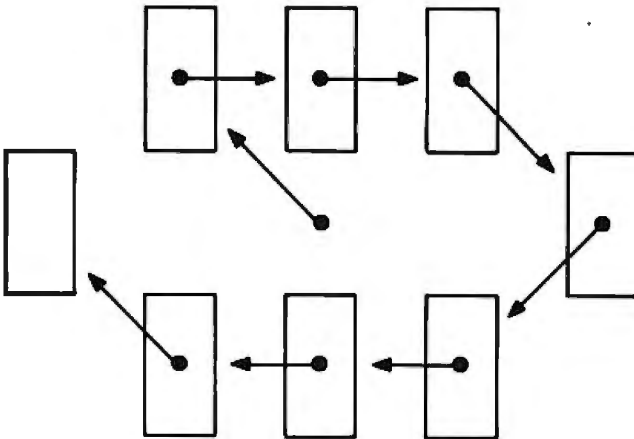

Figure 2: Sequence of cursor moves showing how figure 1 was drawn. The figure has been expanded for clarity.

Text continued from page 394:

walk through a sample session. For example, to create figure 1, we ordinarily write this BASIC subroutine:

```
1000 SET(X-1,Y-1) :SET(X,Y-1) :SET(X+1,Y-1)
      :SET(X+2,Y)
1010 SET(X+1,Y+1) :SET(X,Y+1) :SET(X-1,Y+1)
      :SET(X-2,Y)
1020 RETURN
```

A GOSUB to this routine would slowly draw the shape in a position relative to the key position defined by the X and Y coordinates.

Defining the same figure as a series of vectors can be as easy as running the CREATE program (see listing 3) and

using the numeric keypad to move a dot in the necessary pattern. But to *understand* the process, look at figure 2. Beginning at a central position, the first cursor motion will be northwest with the resulting pixel turned on. The next two motions are east, etc. The result is a pattern of directions:

NW, E, E, SE, SW, W, W, NW

Referring to table 1, we see that these vectors are defined by the characters

I D D F J H H I

The shape would be defined within a BASIC program as

SHAPE\$ = "IDDFJHHI"

Now that the shape is defined, it may be drawn at any screen position by storing a few parameters and invoking the KWIKDRAW USR routine.

The shape-interpreter will look at the bit positions of each of the vector bytes to determine the direction in which to move the cursor. The control codes (A through J and 1 through :) were chosen specifically for the bit positions of their binary values. Using these bit patterns as instructions, KWIKDRAW decodes these bytes as motions of a cursor. For example:

Direction	Vector		Bits	Vector		Bits
	ASCII	hexadecimal	76543210	ASCII	hexadecimal	76543210
			WESN			WESN
North	= A = 41 =		01000001	1 = 31 =		00110001
East	= D = 44 =		01000100	4 = 34 =		00110100
Northeast	= E = 45 =		01000101	5 = 35 =		00110101

Bit 0 (the rightmost bit) of a byte is the flag for moving north, and bit 3 indicates motion east. When both bits 0 and 3 are 1, motion is to the northeast. Also, notice that A and 1 have the same binary value with the exception that bit 4 is on in the latter. This bit is tested to determine whether to move without changing whatever is in the background. Bits 5, 6, and 7, untested by the program, are on only for the convenience of the BASIC programmer.

The first action taken by KWIKDRAW in vector interpretation is the adjustment of its X,Y pointer. Usually, the key position (the X,Y pair passed to the program) will not be plotted. Remember, the principal aspect of a vector is *motion in space*. If you want the very first character to indicate a screen change at the exact coordinate defined by the X,Y parameters, a move and plot command of C will first move the cursor north, then south and plot the position. Otherwise, the first position plotted will be offset by one step from the starting X,Y coordinate in the direction defined by the vector.

Passing Parameters

Four basic parameters are required by KWIKDRAW in its processing of a shape-definition string:

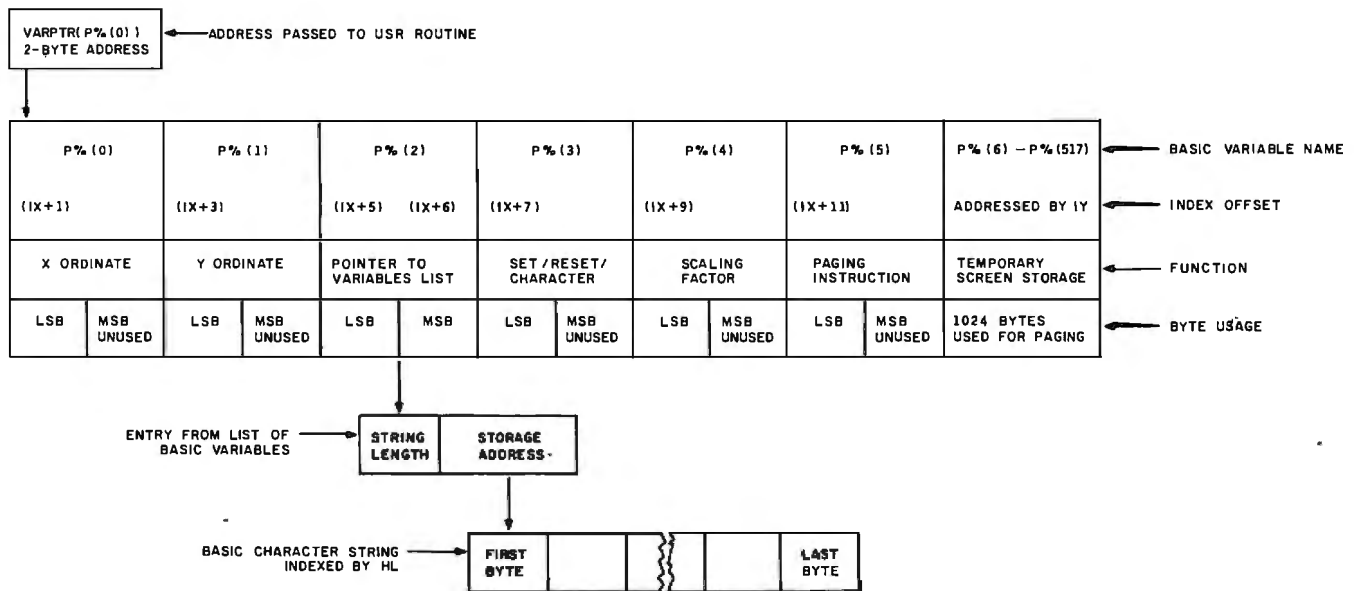

Figure 3: Organization of string data accessed by the VARPTR function of the KWIKDRAW program.

- where to draw the shape (an X,Y coordinate pair)
- whether to set/reset a pixel or use a character
- a pointer to the shape-definition string
- a scaling factor to define the size of the shape

Additionally, you may decide whether or not to page the screen workspace in or out of video memory—more on that later.

An inherent limitation of the USR hook is that only one integer argument at a time may be passed to the routine it calls. Because of the number of parameters needed by KWIKDRAW, a sophisticated protocol was developed. The arguments are placed in elements of an integer array, and the address of the first array element is passed to KWIKDRAW.

The VARPTR function returns an address that points either directly or indirectly to the storage address of the variable.

VARPTR(*integer array variable*) points directly to a contiguous block of main memory, addressing the LSB (least significant byte) of the variable named. The next higher address is the MSB (most significant byte), the following 2 bytes are the LSB and MSB of the array element next in line, etc. For example:

```
10 A%(0) = 2
20 PRINT PEEK(VARPTR(A%(0))),
    PEEK(VARPTR(A%(0))+1)
```

This will print

2 0

The variable is stored using the two's complement convention. Negative numbers have been increased by 1 and

have had all bits flip-flopped. Thus, if $A\%(0) = -2$, the result would be

254 255

VARPTR(*string variable*) returns an address that is the location of a block of data associated with the string. The address itself will contain a 1-byte string length (0-255). The next 2 bytes are a pointer to the actual main-memory storage location for the characters. This address is read in normal Z80 format, that is, MSB followed by LSB. Figure 3 should help in visualizing just how the addresses are accessed by KWIKDRAW.

One word of caution when using these facts in conjunction with the USR command. It is usually desirable to include the VARPTR function explicitly as the USR argument, rather than setting a variable to the value for reuse. For example, always pass the pointer with

```
UU = USR(VARPTR(P%(0)))
```

Don't use

```
VP = VARPTR(P%(0)) : UU = USR(VP)
```

The reason for this is based upon Microsoft's variables table handling. Simple (nonarray) variables are inserted into the list on the fly. As a new simple variable is created, all array variables are pushed higher in memory. In the example above, VP will point correctly *until the storage for the UU variable is allocated*. The insertion of UU into the variables table alters the position of the P%() array, making the value of VP invalid. Also, the address returned by VARPTR(*string variable*) may be invalidated by BASIC's string reorganization.

START YOUR OWN COMPUTER CO.

HOW TO START YOUR OWN SYSTEMS HOUSE **\$36.**

7th edition, November 1981
 Written by the founder of a successful systems house, this fact-filled 220-page manual covers virtually all aspects of starting and operating a small systems company. Contracts, proposals, agreements and a complete business plan are included in full, and may be used immediately. Proven, field-tested solutions to the many problems facing small turnkey vendors are presented.

HOW TO BECOME A SUCCESSFUL COMPUTER CONSULTANT **\$28.**

by Leslie Nelson, 4th revised edition, December 1981
 The rewards of the consultant can be high: freedom, more satisfying work and doubled or tripled income. This manual provides comprehensive background information and step-by-step directions for those interested to explore this lucrative field.

HOW TO START YOUR OWN COMPUTER STORE **\$145.**

1st printing, March 1983
 You too can participate in the 1983 computer store boom... follow the success patterns (and learn from the mistakes) of 170 computer stores we investigated while preparing this manual. • Detailed analysis of the five major computer store strategies • franchises • distributors • start-up plan • low-budget plans • detailed business plan.

HOW TO START YOUR OWN WORD PROCESSING SERVICE **\$48.**

by Leslie Nelson, 2nd edition, November 1982

FREE-LANCE SOFTWARE MARKETING **\$36.**

by B.J. Korites, 3rd edition, June 1980

1983 SOFTWARE WRITER'S MARKET **\$28.50**

1st printing, January 1983

HOW TO SELL YOUR MICRO SOFTWARE **\$19.95**

by B.J. Korites, Ph.D. May 1982

Send check, money order, VISA, Master Charge or American Express # and exp. date. Publisher pays 4th class shipping. Add \$1.00 per book for UPS shipping (USA only). NJ residents add 5% sales tax. For faster shipment on credit card orders call (201) 783-6940.

ESSEX PUBLISHING CO. Dept. 2
 285 Bloomfield Avenue • Caldwell, N.J. 07006

P%(0) = key horizontal (X) ordinate:
 display range: 0-127 (PIXEL mode)
 0-63 (CHARACTER mode)

P%(1) = key vertical (Y) ordinate:
 display range: 0-47 (PIXEL mode)
 0-15 (CHARACTER mode)

P%(2) = pointer to string variable data block:
 usually VARPTR(shape\$)

P%(3) = display mode:
 0 = RESET pixels
 1 = SET pixels
 2-255 = display character

P%(4) = scaling (magnification) factor:
 possible range: 1-256 (0 = 256)
 practical range: 1-15

P%(5) = paging code:
 0 = copy screen to memory, draw shape,
 copy memory to screen
 1 = copy screen to memory, draw shape
 2 = draw shape, copy memory to screen
 3 = draw shape (in memory only)

Table 2: Control parameters used in the passing of parameters to the shape interpreter.

We will train you in UNIX™ and the "C" Language

...And, back it with 50 years of technical experience.

The leader in on-line data information equipment and applications for over 50 years, Bunker Ramo now provides a training course which gives you:

- A one terminal/one user classroom environment
- Proven hands-on learning techniques
- Comprehensive textbooks
- Complete course documentation
- State-of-the-art instructional methods
- Special group registration rates

- Current course offerings include:
- Introduction to the UNIX environment (5 days)
 - Introduction to "C" programming language (5 days)
 - Advanced UNIX methods (5 days)
 - Advanced "C" methods (5 days)

For a detailed prospectus, call or write:
 Bunker Ramo Information Systems Training Services Group
 35 Nutmeg Drive
 Trumbull, CT 06609
 (203) 386-2600



These problems crop up only when they're least expected. They may always be avoided by taking this precaution: *Never define a new variable between the storing of parameters in the P%() array and the invoking of the USR command.* This is the first place to start looking when KWIKDRAW does something unexpected.

Table 2 indicates the array variables used in the passing of parameters and the limits associated with each. Discussion of this parameter array will always refer to the P%() array. Any INTEGER variable array would work, however, and the "%" character may be omitted if a DEFINT command has been specified for the variable.

Note that invalid data in these variables will *not* crash the program. A possible problem, however, is encountered when the scaling factor is set to 0. KWIKDRAW will appear to lock up because it cycles through the SET/RESET routine more than 65,000 times per shape-definition byte. The practical range for scaling a pixel shape is approximately 1 to 15.

Invalid X,Y coordinates are ignored by the program. A shape may be drawn so that part of it is off the screen. Specifying ordinates less than 0 or greater than the screen size is allowed. It is usually advisable to use a central point of the shape as the key vector during shape-definition. This gives the shape its maximum range of motion during animation. Another reason for this precaution is due to the nature of the scaling function.

When the scaling factor is greater than 1, each vector will be drawn as a filled rectangle SCALE wide by SCALE high. The rectangle will be placed with its northwest corner at the current cursor position, and cursor motion will

Description of the KWIKDRAW Assembly-Language Program

Much of the utility of KWIKDRAW is rooted in the fact that it is located on a BASIC program line and avoids the necessity of reserving high memory. Several trade-offs were needed to accomplish this end. Speed is traded for relocatability, program size is traded for compatibility with the BASIC program line format, and modularity is seemingly lost in the necessity of avoiding CALLs.

The program is, however, written in a modular style with each section being basically self-contained. First, the program initializes its variables. Then it takes the requested paging action. The next section interprets each of the bytes of the vector string. It adjusts the horizontal and vertical pointers, determines plot/no plot action, and plots a position according to the scaling parameter. Finally, the return paging action is taken and execution is passed back to BASIC.

The CALL to 0A7F hexadecimal in line 1050 returns HL with the address of the first byte of the P% () array. The IX index register is immediately set to this value by pushing it from HL onto the stack and popping it into IX. Because this address points directly to the X (horizontal) ordinate, the offset byte used in accessing the value would assemble to a 0. Because BASIC line format dictates that this must be avoided, IX is decremented. The X ordinate is now found in the address referred to by IX+1.

The address used for the start of screen storage is used several times during the program. It is convenient to have it accessible as a main register. This address is the same as the location of the seventh element of the parameter array P%(6), and is calculated by adding 12 to the USR argument, i.e., the start of the P%() array. Then it is saved in the IY register. Lines 1850, 2380, and 2840 access this address with a PUSH and a POP to another register.

When the storage address has been determined, the paging action takes place. Two of the four possible paging codes, held in P%(5), request that the current contents of the screen be copied to storage before any shape-drawing occurs. Testing the lowest bit of P%(5) sets a flag used in selecting the desired action. The BIT op code used here (testing a single bit of a byte at an indexed address) is very useful in this type of bit-logic application. As with all BIT testing, the Z flag is set when the bit is off. Think of it as complementing the test bit and placing it into the Z flag, or remember that the Z flag is set as if a CP (compare) operation was performed between the test bit and a 0.

When the paging argument is 0 or 1, the screen is moved into the storage area. Notice in lines 1250-1280 that absolute addresses of 3C00 and 0400 hexadecimal must be loaded into the HL and BC registers. Here again, the zero bytes must be avoided so that the registers are loaded, then decremented or incremented to the correct values. The LDIR (load, increment, and repeat) op code duplicates the screen bytes into the storage area where they may be altered with a minimum of screen hashing.

Lines 1310-1420 finish the initialization process. The number of characters in the vector string is saved in the B register, the starting X and Y coordinates are placed into the D and E registers respectively, and HL is pointed to just before the start of the vector string. The program is now set

up to begin the interpretation process.

The main loop decodes each vector byte as motions of an X,Y pointer. HL is adjusted to point to the byte to decode. The bits of this byte are tested individually. The DE pointer is adjusted in any of eight directions—according to which of the bits are on. Adjustments are made in increments of the scaling factor. When DE has been updated, the fifth bit is tested for a plot/no plot action. If the byte being examined is an ASCII character between 1 and ; (31-3A hexadecimal), the main body of the program is skipped. Register B is decremented; if it's not 0, execution loops back to decode another vector.

A truly modular program would simply make a CALL to the plot routine when the characters A through H were encountered. KWIKDRAW must jump past the program exit code to line 1960 where the plotting action begins. A pair of nested loops is set up in lines 1960-2090. If programmed in BASIC, the rest of this program would look something like

```
10 FOR J=1 TO SCALE
20   FOR K=1 TO SCALE
30     SET(X+K,Y+J)
40     NEXT K
50 NEXT J
```

When SCALE = 0, the loops are each performed 256 times. This mistake will cause a delay of about 7 seconds per (plotting) vector byte.

The loops are ended at lines 3030-3170. The outer-scaling loop sends control back to the top of the main loop by way of a two-span bridge. Because the Z80 JR (jump relative) op code has a range of -126 to +129 bytes from the program counter, and the distance between the bottom and the top of the loop is outside this range, this indirect route must be taken. Two spans to the bridge avoid breaking up any of the logical program modules.

The assembler code analogous to the SET(X+K,Y+J) example from above is actually two separate modules. Depending on the value of the SET/RESET/CHARACTER parameter passed in P%(3), a point is defined as either a single pixel or an entire byte of memory. When P%(3) is greater than 1, the code beginning at line 2230 (CHARACTER mode) is invoked. Here, a PRINT@ screen position (0-1023) is calculated from the X and Y coordinates. The formula used is position = (Y*256 + X*4) / 4. This is calculated very rapidly using the register shift and rotate directives. The position obtained is added to the start of the screen storage area, yielding an address to which the parameter byte is saved.

Calculations for determining which pixel to set or reset are somewhat more complicated. Both a PRINT@ position and a pixel value must be ascertained. The former is simply position = (INT(Y/3)*256 + INT(X/2)) / 4. The remainder of the Y/3 operation (0-2) is saved in the B register, and the carry flag holds the remainder left after the division by 4 (0 or 1).

A pixel is lit by applying a logical OR to the graphics byte at the indicated position. Masking the same value from the

Text box continued on page 423

Text box continued:

byte will darken this pixel. Graphics bytes will always have a value greater than or equal to 128 (80 hexadecimal). Applying the logical OR to one of these values:

1	2
4	8
16	32

and to any graphics byte, will light the respective pixel.

The SET/RESET routine of KWIKDRAW determines which of these values to use by multiplying the B register by 2 and adding the carry flag value, then extracting 2 to the power of the resulting sum. The formula, where MOD is a remainder function, is

$$\text{bit} = 2 \uparrow (\text{MOD}(Y/3) * 2 + \text{MOD}(\text{INT}(Y/3) * 256 + \text{INT}(X/2)) / 4)$$

Once these numbers have been obtained, the screen storage byte is modified for the indicated action. Any nongraphics

byte at the position is first changed to a blank graphics byte. For a SET action, the pixel value is compared with the current byte using a logical OR operation. A RESET action is performed by complementing the pixel value and then performing a logical AND with the position byte. The resulting byte is saved at line 2980. Incidentally, this SET/RESET routine is modeled after the one found in the Level II ROM. Several modifications made it relocatable and speeded it up a bit.

Both the SET/RESET and the CHARACTER routines check for coordinates that would modify bytes outside the storage area. When an X,Y pair is out of range, the routine is simply skipped—allowing shapes to be drawn wholly or partially off the screen.

Finally, the last vector byte has been interpreted when the B register is decremented to 0 by the DJNZ on line 1750. Execution falls through to the paging and exit module. Here, the paging argument is again tested. A value of 0 or 2 causes the updated storage area to be copied onto the screen. Control is then handed back to the BASIC program.

imal), and DE is set to the address of the sixth element of the P%() array. The LDIR op code then copies the screen to the storage area. Paging back into video RAM is accomplished by reversing these registers so that the storage area is copied to the screen.

A detailed description of the KWIKDRAW shape-table interpreter (listing 1) is included with this article in a separate text box. This, plus the remarks within the listing, will explain the structure of the program and detail the techniques used in this example of hybrid programming.

The problem new users will most often experience with KWIKDRAW is incorrect handling of parameter passing. A BASIC programmer is used to having English-sounding words like PRINT and DRAW as commands. KWIKDRAW takes a giant step backward in this respect. There is no easy way to remember which parameter goes in which element of the P%() array.

I suggest that a copy of table 2 (the list of parameter codes) should be available for easy reference during programming with KWIKDRAW.

A Graphics Editor

CREATE is a handy utility program for defining the vector strings needed by KWIKDRAW (see listing 3). It is a graphics editor in much the same way that BASIC's EDIT mode is a text editor. Normally, you'll design a shape on a graphics worksheet and use CREATE for encoding it into a vector string.

Operation is simple; define two pairs of key X,Y coordinates at the prompts. The first is the position at which a reference model is drawn. The latter is for the working copy. Next, CREATE expects input of a series of vector characters that are to be edited. This is the only time you'll have to refer to table 1. You may use a null entry here to define your starting shape string as C—the plot-the-key-position vector described earlier. To edit a few

changes to a predefined string, you may read it in from disk, set SHAPE\$ to its value, and skip this input prompt.

Commands recognized by CREATE are

SPACEBAR	Advance the cursor
/	Back up the cursor
A	Abort edit without change to SHAPE\$
ENTER	Exit editor and save the shape
D	Delete a single vector
L	List (draw) the shape, cursor to start
S	Search for a vector
C	Change a single vector
I	Insert a single vector
X	Enter EXTEND mode (add vectors)
0	Escape from S,C,I,X commands
1-9	Vector keys for S,C,I,X commands
SHIFT	Move-only vector—with <1> through <9>

The L, S, C, and I commands are followed by a vector from the numeric keypad. The X command expects a series of such vectors.

Visualize the keypad as being superimposed on the screen with 8 at the top, 4 on the left, 3 at the lower right, etc. Move the cursor and plot the resulting pixel by pressing the key corresponding to the desired direction. Press the Shift key with the direction key to include a move-only vector. The 0 key is used to escape from any of the above commands.

Some important data is displayed during the editing process: the current X,Y pixel coordinate, the current PRINT@ position, the length of the string, and the current offsets from the starting X and Y. Though positions are relative during KWIKDRAW's interpretation of the shape, knowing the size of the shape is handy in defining multiple shapes (alphabetic characters, frames of anima-

tion), and the X,Y offsets are needed for chaining a series of complex figures.

Pressing the Enter key from COMMAND mode saves the shape in the variable SHAPE\$ for processing to disk. Don't have disks? Use LPRINT SHAPE\$ and copy it into your applications program. Don't have a printer? Get a pencil.

Disk users will be prompted for a file name and a sequential file is opened. You'll then be prompted for a line number and a variable name. The string is written as a BASIC line in the format

```
line# variablename="....vector characters...."
```

For example:

```
10240 SHAPE$(2,4)="IDDFJHHI"
```

The resulting file may be merged with an applications program that contains the KWIKDRAW routine. It would be easy to change the format so that the shape may be read as a DATA line.

Multiple Pages and Other Trivia

Some of the utility of KWIKDRAW will not be completely apparent until it has been used a few times. For example, a working page may be filled with any byte (except 0 or 1) by

```
CL$="CDDD"
```

```
P%(0)=0 :P%(1)=0_____ X and Y to top left
```

```
P%(2)=VARPTR(CL$)_____ point to the four vectors
```

```
P%(3)=2 - 255_____ byte to fill (in CHARACTER mode)
```

```
P%(4)=16 _____ scaling factor
```

```
P%(5)=3 _____ don't page IN or OUT
```

```
UU=USR0(VARPTR(P%(0))) fill the page
```

Use this as a subroutine for clearing a page before building a frame of animation.

Sometimes BASIC is too slow in processing changes to a page between displays. By defining the P%() array with two dimensions, more than one page of video storage is available. For example, DIM P%(517,2) provides three (0, 1, and 2) separate pages for manipulation. Doubly dimensioned array variables are stored with the first-dimensioned subscripts varying fastest. Thus, P%(0,1) of the above example will actually be stored in the addresses sequentially adjacent to P%(517,0).

KWIKDRAW doesn't care what variable address it receives as the USR parameter. It *does* expect this address to point to a series of parameters followed by 1024 bytes for paging. Therefore, any of the dimensioned pages may be accessed by placing the parameters in the elements 0 through 5 of that subscript level, then invoking the shape-interpreter. At the expense of memory, multiple paging can provide maximum speed.

Get your computer talking and save \$126.

The Type-'N-Talk™ speech synthesizer is now available for only \$249.

The Type-'N-Talk™ text-to-speech synthesizer automatically translates your text into electronic speech and allows your computer to speak with an unlimited vocabulary. Standard with an RS-232C interface, Type-'N-Talk has an internal microprocessor and 750 character buffer. And remember, it doesn't use your computer's memory to make your text speak.

Here's what you get.

- Unlimited vocabulary SC-01 speech synthesizer chip.
- Text-to-speech algorithm for translation.
- RS-232C interface.
- Selectable Baud (75-9600).

“talk is cheaper”

Votrax®

Type-'N-Talk is covered by a limited warranty. Write *Votrax* for a free copy. 500 Stephenson Highway, Troy, MI 48084.

- Spelling and phoneme access modes.
 - 750 character buffer.
 - Data echo of ASCII characters.
 - Complete installation and programming instructions.
- Great new software is available for Type-'N-Talk equipped computer systems.

To order, see your local computer retailer or call toll-free

1-800-521-1350

Michigan residents, call (313) 588-0341. MasterCard, VISA or personal check accepted. The price is \$249 plus \$4 for delivery. Educational discount available. Add sales tax in Michigan and California.

© VOTRAX 1982



Listing 4: Subroutines for use with the KWIKDRAW program.

```

998  '**
    ** subroutine compiles a vector string which will
    ** connect 2 points. Most useful for coordinate pairs
    ** separated by 3 or less vectors -OR-
    ** when the line between the points is straight.
999  '** On entry   : X1,Y1 = starting point
    **             : X2,Y2 = ending point
    **             : IN = 1 for plot vectors, 0 for move only
    ** On exit    : A$ holds vector string
    **             : X1,Y1 become X2,Y2
    **
1000 A$=""
1010 IF X1=X2 AND Y1=Y2 THEN RETURN
1020   V=0
1030   IF Y1>Y2 THEN V=V OR 1
1040   IF Y1<Y2 THEN V=V OR 2
1050   IF X1>X2 THEN V=V OR 8
1060   IF X1<X2 THEN V=V OR 4
1070   A$=A$+CHR$(64-IN*16+V)
1080 GOTO 1010
1999 '**
    ** subroutine rotates a vector string
    ** on entry   : A$ = string to rotate
    **             : R = number of 45 degree rotations (1-7)
    ** on exit    : B$ holds rotated vector string
    **
2000 B$=""
2010 FOR J=1 TO LEN(A$)
2020   V=ASC(MID$(A$,J,1)) :V1=V AND 15
2030   FOR K=1 TO R
2040     V2=0
2050     IF V1 AND 1 THEN V2=V2 OR 5
2060     IF V1 AND 2 THEN V2=V2 OR 10
2070     IF V1 AND 4 THEN V2=V2 OR 6
2080     IF V1 AND 8 THEN V2=V2 OR 9
2090     IF (V2 AND 3)=3 THEN V2=V2 AND 12
2100     IF (V2 AND 12)=12 THEN V2=V2 AND 3
2110     V1=V2
2120   NEXT K
2130   B$=B$+CHR$(V1 OR (V AND 240))
2140 NEXT J :RETURN

```

Listing 4 contains two subroutines that are useful in manipulating a predefined vector string. The routine at line 1000 demonstrates the flexibility of the bit logic of the shape-interpreter. Write a program that generates X,Y pairs—say a sine/cosine routine that draws a circle. For each new X,Y pair, call this routine and concatenate a string from the return value in A\$. The result would be a vector string that will draw a circle in the blink of an eye.

I determined that rotating a shape has limited value—considering the asymmetric nature of the TRS-80 pixel. Therefore, this is not a function handled by KWIKDRAW. It is simulated in the subroutine at line 2000, which will rotate a shape in increments of 45 degrees.

Normally, the resulting string would be typed into a program rather than calling this routine during operation.

Conclusion

The descriptions in this article can't convey the dynamic nature of shape-table graphics. I urge you to enter and use KWIKDRAW to see for yourself just what is possible. The effect is orders of magnitude beyond anything possible with BASIC alone. You've got a graphics tool now that can really "shape up" your TRS-80 graphics. Its use is limited only by your own imagination. Dazzle your friends with your programming expertise . . . you might even dazzle yourself! ■

For \$20, Mr. Rollins will provide a Model I disk. It contains the published listings plus some further examples of shape-table graphics, including a program that manipulates a jumbo ASCII character set.

When your people need information from the company computer, they should be able to get it with their own two hands.



Information.

It can be useful or useless. Timeliness makes the difference.

And therein lies the problem. In the conventional scheme of things, you can't get immediate answers from a computer. Because your questions can't be answered until they've been translated into FORTRAN or COBOL or RPG II or some other programming language.

Consider, now, the achievement of the Sperry Univac System 80 computer.

One of the good things System 80 brings you is ESCORT, a unique programming language you and anyone else in your company can handle

with fluency. Because it reads like English. And you work with simple sentences.

ESCORT gives you the power to create your own precisely defined reports instantly, whenever the need arises. Right at your desk.

In fact, anyone in your organization with a need to know can generate customized reports in a matter of minutes. ESCORT actually enables even a novice to create programs while learning. A tutorial mode takes the user through the process, step by step, explaining what's required.

Because the information content is defined by the user request, the user gets only the

Sperry Univac is a division and registered trademark of Sperry Corporation.



SPERRY UNIVAC

We understand how important it is to listen.

information required. The computer gives you everything you asked for, not everything it has.

So you not only save time getting data, you save time evaluating it.

The potential for application spans all departments, at all levels, from top management on down. ESCORT dispenses the information riches of the data base to each according to his need.

With or without ESCORT, System 80 is a superb medium-

scale business computer. The fact is, it outperforms the competition, model for model, in most parameters of consequence. And as your needs expand, you can upgrade capabilities without replacing the entire system. That is not universally true in the industry.

The Sperry Univac System 80. Another demonstration of how we at Sperry define our products by the real-world needs of the people who use them. Another demonstration

of the value of listening.

We invite you to review the System 80's uncommon capabilities. Our "System 80 vs. IBM" and our ESCORT brochures are a good place to begin. Copies are yours for the asking from your local Sperry Univac marketing office.

Or call or write Sperry Univac, Department 100, P.O. Box 500, Blue Bell, PA 19424. Toll-free phone: 800-523-2496 (9 a.m. to 5 p.m.). In Pa. call collect 215-646-3378.

SYSTEM 80 ESCORT

News and Speculation about Personal Computing

Conducted by Sol Libes

Random Rumors: It's rumored that Commodore Business Machines and some of its alternate suppliers are working on CMOS (complementary metal-oxide semiconductor) versions of the 6502 microprocessor (used in the Apple II, Atari 400 and 800, and Commodore personal computers) that would allow low-power operation. . . . One reliable source tells me that this year IBM plans to offer a high-resolution color video monitor for the Personal Computer that emulates IBM's 3279 terminal. . . . Word has it that Radio Shack will soon start selling the Casio handheld computer and drop one of the Sharp models it currently handles. . . . It is rumored that Apple Computer Inc. will shortly cut the price for the Apple II and Apple III by 10%. . . . Sharp is reportedly working on a computer based on Motorola's 68000 microprocessor that will provide a single-user Unix operating system, similar to the Fortune Systems 32:16.

What's Going on at the Shack? It is now over half a year since Radio Shack introduced its 16-bit computer, the Model 16, with the promise of a three-user operating system running on the Motorola 68000 microprocessor housed within the unit. However, so far purchasers can run only the old TRS-80 Model II single-user 8-bit Z80 operating system and applications software. Rumors have been floating around that Microsoft was adapting its Xenix operating system for the Model 16. Now it turns out

that the operating system was really being developed by Ryan-McFarland and that Tandy later changed its mind and went to Charles River Data Systems for the multi-user operating system. Finally, it is expected that Tandy will also offer a single-user 16-bit operating system designed by Ryan-McFarland, in which case I wonder if there will be upward migration from the single- to multiuser systems.

Tandy reported that computer sales rose 69% for the last fiscal year, up to \$624 million from \$369 million, and that these sales now account for 31% of the company's business—back in 1978, computers accounted for only 2.4%. Further, Tandy claims that the TRS-80 Model II accounted for 25% of its computer sales; the Model III, 27%; the Color Computer, 7.2%; pocket computers, 2.5%; software sales, 8.5%; printer sales, 16.7%; and computer-related products, 12.2%. (It is strange that these percentages do not total 100%.)

Tandy also reported that gross profits as a percentage of sales were 59.3%—far higher than the norm for the electronics industry. Net profits were reported to be 11%. Radio Shack now has 392 computer centers and plans to open 125 more. It also sells computers through 5127 company-owned stores and another 2999 franchised outlets. The number of stores will increase by 170 this year.

At IBM: Rumors concerning IBM's future plans suggest that the firm intends to enter

the portable-computer market with a "baby" Personal Computer system made outside the U. S. by Matsushita, that it is at the preproduction stage of a new 4-inch floppy-disk drive, and that it will introduce soon a 3270 IBM terminal emulator and RJE (remote job entry) package for the Personal Computer with an anticipated selling price of \$700. A high-resolution color monitor is also expected that will allow the Personal Computer to emulate an IBM 3279 terminal. Because the Personal Computer costs less than IBM's series 327x terminals, which are used with IBM's large mainframe computers, doubtless customers of such systems will be switching to the IBM Personal Computer for their terminal needs.

IBM has also started selling enhancements for its Displaywriter desktop word-processor system that allow it to act as a terminal. Further, IBM now sells the p-System (Pascal language) for the Displaywriter for users who want it to function as a complete computer system. The Displaywriter uses an Intel 8086 microprocessor, and therefore it's strange that IBM doesn't plan to offer the MS-DOS and CP/M-86 operating systems for the unit, considering that these are available for the Personal Computer. Of course, concurrent CP/M-86 for the Displaywriter can be purchased directly from Digital Research. I can only wonder now if Microsoft will offer MS-DOS for the unit.

IBM offers one other desktop unit, called the System 23 Datamaster. It is the most expensive of IBM's small computers but uses an 8-bit

microprocessor (the Intel 8085, an enhanced version of the 8080). It's likely this processor was chosen because the Datamaster was introduced before the Displaywriter and the Personal Computer. The Datamaster offers much more disk storage capacity than either, however.

It seems likely that IBM will replace the Displaywriter and Datamaster with enhanced versions of the Personal Computer, probably using the new Intel 80286 processor (an enhancement of the 8086). Thus the next Displaywriter may be the Personal Computer with a display and keyboard better suited to word processing, and the next Datamaster may be a Personal Computer with larger disk storage. In this way, IBM could maintain upward compatibility through its entire line of desktop computers, terminal compatibility with its mainframes, and workstation compatibility with its new networking system. If this happens IBM will have the most comprehensive line of office-product computer systems in the industry.

In the meantime, IBM is due to introduce soon its hard-disk option (using the Seagate 5¼-inch drive) for the Personal Computer. Word is that the firm expects to sell about 300,000 this year alone. Also Tecmar, which develops peripherals and enhancements compatible with the Personal Computer, is reportedly planning to introduce a Winchester add-in using either one or two Syquest Technology 3.9-inch, 5-megabyte hard-disk drives with removable media. This would be an ideal combination, allowing the

like operating system for the board (the company also expects to introduce IBM Personal Computer and TRS-80 versions later on).

On the marketing front, reports say that Apple is still having friction with its independent retail dealers. The most recent rub is Apple's new in-house national-accounts program to sell directly to the Fortune 1000 companies. Second, despite many attempts, Apple has been unable to control sales by unauthorized discount retailers that are underselling authorized dealers. These discounters are believed to be obtaining their Apple IIs from authorized dealers who overbuy to get a better discount and then secretly reship at just a few dollars above cost. Apple says it will take strong action to cut off the supply lines to unauthorized dealers. In the meantime, the six West Coast mail-order dealers cut off by Apple over a year ago, who then filed suit against Apple, have not been able to get the government to take up their case.

Of Clones and Look-Alikes: You can tell a really

successful product by how many "clones" (imitations) exist for it. For example, I know of two TRS-80 Model I/Model III clones currently sold, and Apple Computer Inc. is trying to stop the importation and sale of a number of clones from the Far East. Already about six IBM Personal Computer clones are made in the U. S., and at a Japan electronics show held this past October, Hitachi, Mitsubishi, NEC (Nippon Electric Company), Matsushita, Sanyo, and Toshiba all showed IBM-compatible systems, many of which will appear in this country later in the year. The question is whether a product is as compatible as its manufacturer claims it is. Many clone suppliers contend that, compared to the original, their product is far superior, contains added features, and gives you more value for your dollar.

You have to look closely at these claims because, in all too many cases, such statements conceal hidden snags. It may be that a clone maker cannot copy the original product exactly without violating some hardware patent or software copyright and thus has to get around this by changing part

of the design and calling the change an added feature. The net result is that the clone is not a clone but a look-alike—it may be able to run some of the software made for the original but not all of it; or, it may work with some of the plug-in peripherals but not all of them.

For example, one system that is advertised as IBM-compatible uses 3-inch floppy disks. Now how do you take a program supplied on an IBM Personal Computer 5¼-inch floppy disk and get it into this new machine? I suppose what the supplier probably means is that once you get a program onto the 3-inch disk, it will run on the company's computer.

Another system is advertised as disk-compatible with the IBM Personal Computer, the Osborne 1 and the Xerox 820. Interpret this to mean that you can copy a file (or the whole disk) from one system's disk format to the other's. But how does the Personal Computer's 8088 program execute on the supplier's Z80-based system? And how does a program that uses the special I/O (input/output) features work on a system with different I/O procedures? What the manu-

facturer really means by "disk compatibility" is that many (but not all) data or text files can be converted from the original format to run on the "compatible" machine.

New companies entering the personal computer market will find their entry easier if they make their machines compatible with the dominant machines on the market. However, purchasers should look very closely at such compatibility claims to see if something less than 100% compatibility is offered and, if so, whether this will create problems.

Zilog to Sample Z800: Word has it that Zilog will soon begin distributing samples of its new upgrade of the Z80, called the Z800, with production expected this fall. The Z800 will be upward compatible with the Z80 (in other words, it will execute a Z80 machine-code program) and will offer an expanded instruction set and enhanced performance features. Zilog is promising a three- to five-fold performance improvement. The processor will run at clock speeds as high as 25



CompuPro

8 and/or 16 Bits.

A CompuPro Systems Center is much more than a computer store: it is the first place to look for business, scientific, and industrial computing solutions. When you're ready for professional level, state-of-of-the-art microcomputing, turn to the professionals listed below...they're ready for you.

- | | | | |
|---|--|---|--|
| <p>ACC
833 Steirlin Road #B110
Mountain View, CA 94043
(415) 969-4969</p> | <p>Byte Shop of Hayward
1122 B Street
Hayward, CA 94541
(415) 886-4732</p> | <p>Comcen Technology Ltd.
45/46 Wychtree Street
Morrison
Swansea, U.K. SA6 8EX
(0792) 796000</p> | <p>Gifford Computer Systems
(division of G & G Engineering)
1922 Republic Avenue
San Leandro, CA 94577
(415) 895-0795</p> |
| <p>Advanced Information Mgt., Inc.
145 Kentucky Street
Petaluma, CA 94952
(707) 763-7283</p> | <p>Capacity Plus Computers
250 Alamaha Street N-14
Kahului, Maui, HI 96732
(808) 877-3496</p> | <p>Computer Center, Inc.
1514 University Avenue
Berkeley, CA 94703
(415) 845-6366</p> | <p>Gifford Computer Systems
230 California Street #207
San Francisco, CA 94104
(415) 391-4570</p> |

with other tasks while the system sends data to the printer. A software module is available that allows multiple processors to be connected via any number of network configurations so that each user can access the resources of any others. (Software protection can also lock resources to make them inaccessible.) This system is presenting a serious challenge to MP/M in the 8080/Z80 multiuser/multi-tasking marketplace. Further, it is likely that other software houses may introduce similar packages.

The 16-bit market as yet has no definite leader, although Microsoft with MS-DOS currently appears to be the chief contender. When the first 8086-based personal computer was introduced by Seattle Computer Products (SCP) back in 1979, there was no software for it. Digital Research was working on CP/M-86, but it was a low-priority project. Microsoft, however, created a version of BASIC in 8086 code, so SCP started furnishing BASIC with its system and wrote a DOS. A year later, Digital Research finally introduced CP/M-86 just as other vendors started to introduce 8086-based systems. CP/M-86 and SCP-DOS, although very similar in structure and operation, were not compatible.

When IBM went looking for a disk operating system for the Personal Computer, the company approached Digital Research but for some reason didn't hit it off. Because IBM was also negotiating for Microsoft's BASIC, Microsoft quickly obtained the rights to SCP-DOS and adapted it to the Personal Computer. Microsoft renamed it MS-DOS and licensed it to about two-dozen other hardware vendors.

Microsoft will soon introduce version 2 of MS-DOS to overcome some of the limitations of the first version,

provide more features, and achieve upward compatibility with Microsoft's Xenix, a multiuser/multitasking DOS based on the Unix operating system and licensed from Bell Laboratories. Digital Research has introduced a multitasking version of CP/M-86; however, with IBM using MS-DOS (IBM calls it Personal Computer DOS) as its principal operating system (the company also offers CP/M and the p-System at significantly higher cost) it's very likely that, in the 16-bit market at least, MS-DOS will dominate. What makes a DOS successful is the software available to run under it. It appears to me that there are far more software houses developing software to run under MS-DOS than under CP/M-86. Most 8086 hardware suppliers appear to be hedging their bets by furnishing both operating systems.

Mail-Order Sales to

Stop: Following in the footsteps of Apple Computer Inc. and Hewlett-Packard, two software suppliers are trying to stop mail-order sales of their products. Micropro International (creator of Wordstar, et al.) of Sausalito, California, and TCS Software, Houston, Texas, have notified dealers that they must cease mail-order sales and sell only to customers to whom they can provide post-sale support. Micropro is believed to have as many as 100 mail-order dealers. Considering the difficulty Apple has had trying to cut off mail-order sales, it will be interesting to see how successful software suppliers will be in this effort.

Intel Profile: Founded only 14 years ago, Intel Corporation has proved to be one of the most innovative companies in the microcomputer field. It has a long string of

firsts: the first practical dynamic RAM, the first microprocessor, the first EPROM, the first 1K-bit static RAM, the first 8-bit microprocessor, the first 32-bit microprocessor, and the first single-chip microcomputer. It now employs nearly 17,000 people and does close to \$1 billion of business. This year, Intel is expected to introduce a 256K-bit EPROM, a 64K-bit EEPROM, and a 4-megabit bubble-memory device (a 16-megabit device is expected next year). A 1-megabit dynamic RAM is also in development (imagine a full 64K bytes in one integrated circuit).

In the microprocessor field, Intel expects to introduce a new 32-bit microprocessor called the 80386 (or iAPX386) that is upward compatible with the 8086 family. Intel will also start shipping the 80286, an enhanced 8086 with virtual-memory ability. We can expect to see a version of this device with 8-bit I/O also. The current iAPX-432 32-bit microprocessor is also due for an upgrade in microcode and interconnection capabilities to improve its throughput. It is also expected that the new 432 will be able to handle gigabytes of memory. Intel is also known to be doing research in speech recognition; however, introduction of any devices in this area still appears to be several years off.

A Unix Status Report:

My son (who is quite familiar with the Unix operating system) and I recently conducted a survey of Unix-like operating systems for microcomputers. We canvassed 35 companies selling such operating systems for microcomputers and discovered the following: four companies sell Unix-like operating systems for 8-bit systems; two are for 6809 systems and two for Z80 systems. All but one provide multitasking and multiuser facilities.

Further, utilities are available that run on CP/M-based systems and provide many Unix-like facilities such as I/O redirection and hierarchical file system.

An incredible number of software houses are now supplying Unix-licensed and Unix-like operating systems for 16-bit microcomputers. The most popular version is for Motorola's 68000, second is for Zilog's Z8000; less popular are versions for the Intel 8086 and the National Semiconductor 16032, the latter probably because it is so new. Virtually all of these operating systems require large memories and hard-disk systems. Although almost all of these systems provide the basic features of Unix, most are lacking features such as virtual-memory management. Many lack process- and memory-management features common on standard minicomputer Unix systems.

Also, Unix systems typically have good program development and text processing support. However, you may have to pay extra for anything other than the minimum with these systems. Nearly every vendor charges extra for languages such as BASIC, Pascal, FORTRAN, and COBOL. Some even charge extra for a C compiler (Unix is written in C). Further, none offer a high-level debugger (sdb is the standard utility that Unix programmers use for debugging C programs). Lack of a debugger certainly makes program development more of a hassle and more time consuming. It's interesting that three suppliers provide CP/M emulators that run as a task under Unix.

New Machine Goes to

Hollywood: Tracy Kidder's book *The Soul of a New Machine* (Little, Brown, 1981) won a Pulitzer prize for general nonfiction, and now Columbia Pictures has taken

an option on it to possibly make it into a movie. The book describes in a very human way the struggle to develop the Data General MV-8000 32-bit super mini-computer.

The Software Stars:

Which are the three top-selling microcomputer software packages to date? If you guessed Microsoft BASIC, CP/M, and Visicalc, give yourself a gold star. Microsoft BASIC, which is now running on more than 1 million microcomputers, is the top seller. Originally written in 1975 by Bill Gates and Paul Allen to run on the MITS (management information and text system) Altair 8800 computer, it is today available on virtually every major microcomputer system and is considered the standard for BASIC interpreters. It has been implemented on some large computers. Second in popularity is the CP/M disk operating system currently running on over a half-million microcomputers and more than 600 different systems. Written by Gary Kildall in 1974, its first appearance was on the IMSAI 8080 microcomputer system in 1976. Third is Visicalc, written for the Apple II computer in 1979 by Dan Bricklin, Bob Franston, and Steve Lawrence; it has already sold over 300,000 copies and is currently available for many other systems as well.

All three packages were developed on large computer systems by pioneering individuals working outside of commercial organizations. They did not perceive the broad-based acceptance that their efforts would receive, and at the time they didn't realize that within a few years they would be leaders of large companies employing a hundred or more people and grossing many millions of dollars each year.

Shakeout Predicted:

Currently several hundred microcomputers are on the market, all based on a mere handful of microprocessors, operating systems, and application programs. Therefore, many of the systems are nearly identical inside and out. Yet there is a limited amount of dealer shelf space on which to show them, creating a bottleneck at the retail level. System suppliers have tried to become more aggressive in their marketing, but only the better-financed and established companies are succeeding. Add to this the current recession, and it's no surprise that industry pundits are predicting a shakeout among personal computer manufacturers in the very near future as marketing becomes more important than the products themselves.

What's New In Video Games?:

Mattel and General Instrument Corporation have announced a new venture called Playcable that will allow owners of Mattel Intellivision units to access games via cable-television systems. Control Video Corporation of Washington plans a similar service, to be accessed via the telephone lines, for Atari 5200 game owners. Meanwhile, CompuServe is offering games that can accommodate up to 10 players at a time. CompuServe claims that one game, called Megawars, is its second largest revenue producer, attracting 2000 players a week at a rate of \$5 per hour. X-rated games are also becoming quite an attraction in bars and even at home.

Gross income from arcade games has skyrocketed in the last few years but appears to have leveled off at about \$8 billion (yes, billion) and arcade-game suppliers are searching for new ways to increase game playing. Thus

under development and due shortly on the arcade scene are games using videodiscs and three-dimensional games in which the enemy appears to be hurtling objects directly at the player. The videodisc creates more life-like pictures and sound, with explosions that are more like the real thing. Atari has already demonstrated a prototype game using holography to create ghost-like three-dimensional images. There is no word on whether the firm actually plans to produce it.

Random News Bits:

Radio Shack has cut the price of its Color Computer from \$399 to \$299, no doubt to be more competitive with Commodore, Texas Instruments and Atari. . . . Comprosys Ltd, 1 Branch RD, Park St., St Albans AL1 4RJ, England, is selling a ROM for the ZX81 that turns that \$99 machine into a development system with full-screen editor, multi-file operating system, assembler, debugger, and more. . . . Intel appears to be the

first company to meet the Department of Defense specifications for its comprehensive subset of the Ada language. . . . Hewlett-Packard has established a new Personal Office Computer division in Sunnyvale, California, that will be separate from the Personal Computation group, which produces the company's current line of personal computers. . . . Users of CompuServe will soon be able to use the U. S. Postal Service E-COM (Electronic Computer Originated Mail). Unfortunately, it is only available to business users. . . . NEC claims to have developed a software technique for recognizing handwritten characters with 99.5% accuracy. ■

MAIL: I receive a large number of letters each month as a result of this column. If you write to me and wish a response, please include a self-addressed, stamped envelope.

Sol Libes
c/o **BYTE Publications**
POB 372
Hancock, NH 03449 ■

BYTE's Bits

Articles on Computers and Writing Sought

The Writing Instructor is a quarterly journal on teaching composition. The theme of the Summer 1983 issue will relate computers to writing instruction. Authors are encouraged to submit articles about computer-aided instruction, the use of word-processing and interactive computer programs for composition, personal classroom experiences using computers in writing instruction, computer-aided assessment of student tests, and speculative or reflective essays on the implications of computers in the

humanities.

Articles should be no longer than 15 double-spaced typewritten pages. You may use internal documentation whenever practical; otherwise, use the *MLA Handbook*. Submit two copies of your manuscript along with pertinent biographical information and a stamped, self-addressed envelope to *The Writing Instructor*, c/o The Freshman Writing Program, University of Southern California, Los Angeles, CA 90089, Attn: Randall Adams, Issue Editor, Summer 1983. ■

Event Queue

February 1983

February

Continuing Engineering Education, George Washington University, Washington, DC. Among the courses being offered are "Selecting Small Computers for Business and Government," "Local Communication Networks and Digital PBXs," and "Computer Communications Systems and Networks." Course fees range from \$685 to \$855. Further details are available from Douglas Green, Continuing Engineering Education, George Washington University, Washington, DC 20052, (800) 424-9773; in the District of Columbia, (202) 676-8515.

February

Seminars of Interest to Women Professionals, various sites in the New York City and Boston metropolitan areas. This series of one- and two-day seminars is presented by Boston University Metropolitan College. Among the topics on the agenda are "Tactical Innovations in Marketing Management," "Sales Management for Today's Newly Promoted Sales Manager," and "Data Processing Fundamentals for Accounting and Financial Managers." The seminar fees are \$325 and \$495, depending on duration. For registration information, contact Ms. Joan Merrick, University Seminar Center, Suite 415, 850 Boylston St., Chestnut Hill, MA 02167, (617) 738-5020.

February-March

Courses for Developers and Users of Computer Systems, various sites throughout the U.S. Among the courses being offered by the AMA (American Management Associations) are "Fundamentals of Data Processing for the Non-data Processing Executive,"

"BASIC: A Computer Language for Managers," and "Database Concepts and Design." For complete registration and course information, contact the AMA, 135 West 50th St., New York, NY 10020, (212) 586-8100.

February-June

Intensive Seminars of Interest to Data Processing Professionals, Boston metropolitan area. Among the two- to five-day seminars offered are "Project Management" and "Data Communications." Registration fees range from \$495 to \$975. For a seminar bulletin, contact Ms. Ginny Bazarian, Office of Continuing Education, Higgins House, Worcester Polytechnic Institute, Worcester, MA 01609, (617) 793-5517.

February-June

Seminars in Simulation, Management, Statistics, and Computer Science, various sites throughout the U.S. "Simulation Modeling for Decision Making," "Database Design," and "Satellite Communications Technology" are some of the topics to be presented. For details, contact the Institute for Professional Education, POB 756, Arlington, VA 22216, (703) 527-8700.

February 14-18

Auditing in the Contemporary Computer Environment, New York, NY. This course is designed for internal auditors and financial and data-processing professionals. It provides a comprehensive audit approach for computer-based systems, including how to evaluate controls and how to design a program of tests using questionnaires, checklists, software tools, and flow charts. For details, contact Marge Umlor, EDP Auditors Foundation, 373 South Schmale Rd., Carol Stream, IL 60187.

February 15-18

Embedded Computer Systems, Boston, MA. Participants in this course will learn how to design reliable and fault-tolerant systems, how to implement real-time and interrupt-driven controls, and how to evaluate bus structures, protocols, and networking. The registration fee is \$845. For details, contact Ruth Dordick, Integrated Computer Systems, 3304 Pico Blvd., POB 5339, Santa Monica, CA 90405, (213) 450-2060.

February 15-18

Peripheral Array Processors for Signal Processing and Simulation, University of California, Los Angeles. The fee for this course is \$845. Contact Marc Rosenberg at the UCLA Extension, Continuing Education in Engineering and Mathematics, 6266 Boelter Hall, Los Angeles, CA 90024, (213) 825-1047.

February 15-18

Designing Real-Time Hardware for Digital Signal and Image Processing, Washington, DC. Participants in this short course will learn how to implement digital filters, fast Fourier transforms, correlation, modulation, and other real-time processes by designing with general-purpose 16-bit microprocessors. Case histories and lectures will be featured. The fee is \$845. For further details, contact Ruth Dordick, Integrated Computer Systems, 3304 Pico Blvd., POB 5339, Santa Monica, CA 90405, (213) 450-2060.

February 16-18

The Third Annual TALMIS, Ambassador West, Chicago, IL. This conference brings together software publishers and users of microcomputer-based training systems. Issues on the agenda include the home market, local networking, new

hardware, and successful distribution channels. Question-and-answer sessions will be held. Further information is available from Mary O'Keefe, TALMIS Inc., 115 North Oak Park Ave., Oak Park, IL 60301, (312) 848-4000.

February 16-19

Data and Telecommunications/Japan Exposition '83, Tokyo Ryutsu Centre, Tokyo, Japan. For information, contact Cahners Exposition Group, Cahners Plaza, 1350 East Touhy Ave., POB 5060, Des Plaines, IL 60018, (312) 299-9311. In Japan, contact Cahners Exposition Group S.A., Hino Building 3F, 3-4-11 Uchikanda, Chiyoda-ku, Tokyo 101, Japan; tel: 03-254-6041.

February 21-23

Office Automation Conference, Civic Center, Philadelphia, PA. More than 200 exhibitors are expected to participate in this conference. Fifty technical sessions will explore such topics as current and advanced office technology and human factors and social issues. Further details are available from the American Federation of Information Processing Societies Inc., 1815 North Lynn St., Arlington, VA 22209, (703) 558-3624.

February 22-26

The Eighteenth Annual Bias-Microelettronica '83, Milan, Italy. This international exhibition is expected to attract more than 80,000 visitors. Areas of interest include active and passive components, instrumentation and equipment for component manufacturing, laboratory instrumentation, microcomputers, peripherals, and telecommunications systems. For information, contact Ente Italiano Organizzazione Mostre, Bias-Microelettronica '83, Viale

Premuda 2, 20129 Milan, Italy; tel: 796.096; Telex: CONSEL 334022.

February 23-25

Microcomputers in Education, New York, NY. This hands-on workshop is designed for teachers and administrators. Topics on the agenda include Logo, Pascal, microcomputers as laboratory instruments, and microcomputers in mathematics and science. Fees range from \$120 to \$300, depending on length of participation. For full details, contact Technical Education Research Centers Inc., 8 Eliot St., Cambridge, MA 02138, (617) 547-3890.

February 24-25

Computers in Construction, San Diego, CA. This seminar is designed to assist construction contractors and construction management firms in acquiring computer systems. The registration fee is \$395. For further information, contact CIP Information Services Inc., 1105-F Spring St., Silver Spring, MD 20910, (301) 589-7933.

February 25-27

The Second Annual Computer Expo '83, Tupperware Convention Center, Orlando, FL. This exposition focuses on hardware, software, word processing, graphics, peripherals, supplies, services, and computer furnishings for mini- and microcomputers. Seminars will be held. For details, contact Tom Blayney, POB 1185, Longwood, FL 32750, (305) 339-1731.

March 1983

March

Continuing Engineering Education Courses, George Washington University, Washington, DC. Among the courses

being offered are "Managing Data Processing Systems in Multiproject Environments" and "Design of Digital Control Systems." Fees range from \$685 to \$855. Further details are available from Douglas Green, Continuing Engineering Education, George Washington University, Washington, DC 20052, (800) 424-9773; in the District of Columbia, (202) 676-8515.

March 1-4

Computer Network Design and Protocols, Washington, DC. This short course emphasizes the practical aspects of network design, interfacing, protocols, and packet switching. Topics include how to determine system requirements, how to use packet- and message-switching techniques, and how to interface local systems to value-added networks. The fee is \$845. For more information, contact Ruth Dordick, Integrated Computer Systems, 3304 Pico Blvd., POB 5339, Santa Monica, CA 90405, (213) 450-2060.

March 4-5

Conference on Computer Technology: The Challenge to Business and Industry, Brown University, Providence, RI. Plenary addresses and seminars will focus on such topics as future technology and applications, robotics, and training and education requirements. For additional information, contact the Conference on Computer Technology, Registration Office, AIESEC Box 1930, Brown University, Providence, RI 02912, (401) 861-4835.

March 7-11

Computer-Aided Engineering and Manufacturing: Seminars and Exhibition, McKimmon Center, North Carolina State University, Raleigh. This comprehensive program is de-

In Less Than 3 Minutes

Your IBM Model 50, 60, 65, 75, or 85
Electronic Typewriter
can be an RS232C PRINTER or TERMINAL



CALIFORNIA MICRO COMPUTER Models 5060 and 5061 can be installed easily and require NO modifications to the typewriter.

For additional information contact:

CALIFORNIA MICRO COMPUTER
9323 Warbler Ave., Fountain Valley, CA.
92708 (714) 968-0890

MULTI-PROGRAMMER SYSTEM-10

Features:

- Dedicated keys and large display vocabulary for ease of use.
- I/O - 6 baud rates, 13 formats including Intellec, Textronix and Motorola.
- EPROMs, E²PROMs and bipolars.
- Gang option - programs eight at once.
- Remote control option.

\$945

PROGRAMS
OVER 250
DEVICE TYPES



NEW
S-15
\$845

GANG
OPTION
\$445

FUNCTIONS:

DISPLAY DEVICE DATA
EDIT RAM DATA
DEVICE PROGRAM
TYPE SELECTION

CRC-RAM
LOAD DATA
COMPARE FIELDS
FILL MEMORY FIELD
BLOCK MOVE
DIAGNOSTICS
and more.

BYTEK

COMPUTER SYSTEMS CORP

2283 East Linton Blvd.

Delray Beach, Fla. 33444 (305) 272-2051

Event Queue

signed to update manufacturing managers, engineers, and professionals on the capabilities of computers, microprocessors, robotics, and CAD/CAM (computer-aided design/manufacturing) systems through discussions, hands-on experience, and demonstrations. For further information, write to Robert Edwards, Industrial Extension Service, North Carolina State University, POB 5506, Raleigh, NC 27650.

March 8-9

ACM SIGCOMM '83—Symposium on Communications Architectures and Protocols, University of Texas, Austin. This symposium is sponsored by the Association for Computing Machinery. Address inquiries to Rebecca Hutchings, Honeywell/FSD, 7900 Westpark Dr., McLean, VA 22102, (703) 827-3982.

March 8-10

Semicon/Europa '83, Zuespa Convention Center, Zurich, Switzerland. The Semiconductor Processing and Equipment Symposium will include technical papers and exhibits on such topics as process-related defects, pattern definition, and process chemistry. Full details are available from the Semiconductor Equipment and Materials Institute Inc., Suite 212, 625 Ellis St., Mountain View, CA 94043, (415) 964-5111.

March 8-11

Distributed Processing, Mini and Microcomputer Implementations, Washington, DC. This course is designed to provide a comprehensive introduction to distributed processing hardware and software. Topics of interest include unique design requirements of distributed systems and how

to partition systems tasks and hardware. The fee is \$845. Further details are available from Ruth Dordick, Integrated Computer Systems, 3304 Pico Blvd., POB 5339, Santa Monica, CA 90405, (213) 450-2060.

March 8-11

Local Area Networks, Los Angeles, CA. This course focuses on the practical integration of available software and hardware elements, based on an understanding of network architectures and protocols. The fee is \$845. For further details, contact Ruth Dordick, Integrated Computer Systems, 3304 Pico Blvd., POB 5339, Santa Monica, CA 90405, (213) 450-2060.

March 9-11

Secretary Speakout '83, Sheraton Hotel, Boston, MA.

The theme for this symposium is "The Professional Secretary's New Identity in the Information Age." Speakers will address the impact of office technology through case history presentations, panels, open microphone sessions, and discussion groups. This event is sponsored by the Professional Secretaries International Research and Educational Foundation. Full details are available from Candace M. Louis, PSI, Crown Center G-10, 2440 Pershing Rd., Kansas City, MO 64108, (816) 474-5755.

March 12-17

The Twenty-fourth Annual Management Conference of the Electronic Representatives Association, Cancun, Mexico. Educational programs, special meetings, round-table discussions, and workshops will highlight this annual event.

THE ULTIMATE

THE ULTIMATE SOFTWARE PACKAGE FOR YOUR CPM MACHINE

WORDSTAR \$300 MPM.HAL
MAILMERGE DATABASE

(REFERENCE CARDS INCLUDED)

THIS IS A LIMITED OFFER—ORDER NOW

MONEYORDER, COD, CREDITCARD ORDERS
SHIPPED WITHIN 24 HRS

PERSONAL CHECKS TAKE 10 DAYS (MANUALS NOT INCLUDED)

CALL (915) 533-8725 NOW

OR SEND YOUR ORDER TO:

HAL SOFTWARE BROKERAGE

P.O. BOX 6051

EL PASO TEXAS

79906-6051

TEXAS RESIDENTS

ADD 5% SALES TAX



WHEN HAL SPEAKS 2001 LISTENS

PUT PRICES IN CHECK

ZIP PACK
RELOAD RIBBONS
FOR
NEC 8023A
APPLE PRINTERS
C. ITOH PROWRITER
\$7.99 EA. \$89.99 DOZ.

CARTRIDGE RIBBONS FOR
EPSON
MX-80 MX-100
\$7.99 \$12.95
\$89.99 \$139.86
DOZ DOZ

MEMOREX
DISKETTES
5 1/4 SINGLE SIDE - DUAL DENSITY
\$24.99
10 PACK

LABEL
SPECIAL
\$2.99
/K
(5K/MIN.)

1 ACROSS 3 1/4" x 1 1/8" CONTINUOUS LABELS

COMPLETE LINE OF OTHER RIBBONS AVAILABLE. PLEASE CALL

ALL ABOVE PRICES INCLUDE SHIPPING.

Check-Mate

51 DIAUTO DR. P.O. BOX 103

RANDOLPH, MA 02368

TOLL FREE 800-343-7706 IN MASS 617-963-7694

WE ACCEPT MASTER CARD & VISA
MASS. RESIDENTS ADD 5% SALES TAX

PHONES OPEN 9AM-7PM EASTERN TIME

Contact the Electronic Representatives Association, 20 East Huron St., Chicago, IL 60611, (312) 649-1333.

March 14-15

The Seventh Annual Conference of the Michigan Association for Computer Users in Learning—MACUL '83, Hyatt Regency, Dearborn, MI. Sessions and speakers will highlight this conference. For more information, contact Betty VandenBosch Shaw, Coordinator of Mathematics, Flint Community Schools, 923 East Kearsley, Flint, MI 48502, (313) 762-1007.

March 14-17

The Seventh Annual Federal Office Systems Expo—FOSE '83, Washington Convention Center, Washington, DC. Sixty high-level sessions will cover the development of integrated office systems in both

government and industry. More than 200 companies will display the latest in office systems technology. For more information, contact Mary Beth Gouled, National Trade Productions Inc., 9418 Annapolis Rd., Lanham, MD 20706, (800) 638-8510; in Maryland, (301) 459-8383.

March 14-18

Computer Graphics Applications for Management and Productivity—CAMP '83, International Congress Center, Berlin, West Germany. This conference features tutorials, technical papers, and exhibits that reflect the practical applications and state of the art of computers and computer-graphics technology. Topics on the agenda include computer-aided design and manufacturing, sales-support graphics, and improving the use of engineering data. A

hardware and software exhibition will be held. Full particulars are available from the World Computer Graphics Association, Suite 250, 2033 M St. NW, Washington, DC 20036, (202) 775-9556.

March 15-16

Selecting a Microcomputer for Scientific and Engineering Applications, Colorado School of Mines, Golden, CO. This short course reviews hardware and software technology for potential buyers of microcomputers in relation to specific scientific and engineering applications. The fee is \$195. Contact the Space Office, Colorado School of Mines, Golden, CO 80401, (303) 273-3321.

March 15-18

Distributed Processing, Mini and Microcomputer Imple-

mentations, San Diego, CA. For details, see March 8-11.

March 15-18

Local Area Networks, Boston, MA. For details, see March 8-11.

March 16-17

Business-Expo, Houston, TX. This show features everything from computers, copiers, and telephone equipment to interior decorating, office design, and financial consulting. More than 20 seminars on business technologies will be offered. Complete details are available from Business-Expo, 702 East Northland Towers, 15565 Northland Dr., Southfield, MI 48075, (313) 569-8280.

March 17-19

The Third Annual Microcomputers in Education Conference, Arizona State Universi-

FREE 56 page catalog

Forms and for MICRO

invoices, statements and letterheads work with programs from over 200 software sources... or program forms with guides provided. Full color catalog also has stock tab paper, diskettes, other supplies.

- Quality products, low prices
- No "handling charges"
- Small quantities
- Money-Back Guarantee

Fast service by mail or PHONE TOLL FREE

1 + 800-225-9550 (Mass. res. 1 + 800-922-8560)

NAME _____

COMPANY _____

CITY, STATE and ZIP _____

SOFTWARE BRAND (to help us send correct info.) _____ PACKAGE # _____ Do own programming

COMPUTER MAKE _____ MODEL _____ Not Purchased

FOR USER OR Employee?

Neb's Computer Forms

CODE 11004



78 Hollis Street, Groton, Massachusetts 01471
A division of New England Business Service, Inc.

All the **STORAGE**
and
All the **SOFTWARE**
you ever wanted on the IBM-PC,
IN ONE INTEGRATED PACKAGE

Complete Integrated Accounting System:

- A/P
- A/R
- G/L
- Payroll
- Inv.

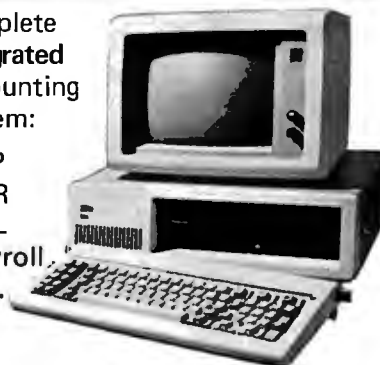

- Perfect Writer
- Perfect Speller
- Perfect Filer
- Perfect Calc

5 MB HARD DISK
plus LISTED SOFTWARE

\$2,995.

10 MB available also

The Business Manager™

Event Queue

ty, Tempe. The theme for this conference is "Forward to the 3 C's: Communicating, Calculating, and Computing." Demonstrations, workshops, and presentations will emphasize the potential of computers to revolutionize the learning process. Topics to be explored include how computers are changing the nature of: content in subject areas, teaching, and what it means to be well educated. University credit will be available. Further information can be obtained from Marilyn Sue Ford, B-47 Payne Hall, College of Education, Arizona State University, Tempe, AZ 85287, (602) 965-7363.

March 18-20

The Eighth West Coast Computer Faire, Civic Auditorium and Brooks Hall, San Francisco, CA. Attendance this year is expected to reach 40,000. More than 600 ex-

hibitors and a wide assortment of seminars make this one of the largest annual computer shows. For more information, contact The Computer Faire, 333 Swett Rd., Woodside, CA 94602, (415) 851-7075.

March 21-24

Interface '83, Miami Beach Convention Center, Miami, FL. This conference will cover all aspects of data communications and information processing in technology, management, policy, and strategy. It is cosponsored by McGraw-Hill's *Business Week* and *Data Communications* magazines. For further details, contact The Interface Group, 160 Speen St., POB 927, Framingham, MA 01701, (800) 225-4620; in Massachusetts, (617) 879-4502.

March 21-24

Personal Microcomputer In-

terfacing and Scientific Instrumentation Automation, Virginia Polytechnic Institute and State University, Blacksburg, VA. This is a hands-on workshop where the participant designs and tests concepts with the actual hardware. The fee is \$595. For more information, contact Dr. Linda Leffel, C.E.C., Virginia Tech, Blacksburg, VA 24061, (703) 961-4848.

March 22-24

Cincinnati Business Show, Exhibition-Convention Center, Cincinnati, OH. A wide range of products and services will be displayed, including computers, satellite equipment, electronic mail systems, and telecommunications equipment. For more information, contact Ray G. Nemo, Cincinnati Business Show, 10608 Millington Court, Cincinnati, OH 45242, (513) 791-6300.

March 22-25

Computer Network Design and Protocols, San Diego, CA. For details, see March 1-4.

March 22-25

Embedded Computer Systems, Washington, DC. For details, see February 15-18.

March 24-25

Computers in Construction, Orlando, FL. For details, see February 24-25.

March 24-25

The Western Educational Computing Workshops, Hayward, CA. These workshops, sponsored by the California Educational Computing Consortium, provide demonstrations and hands-on experience with new computer applications, software, and hardware. Contact Jerry Rose, Computer Center, California State University,

The Byte Shop® Franchise Opportunity.

Computer retailing has survived the economic hard times like no other industry: with phenomenal growth and profit.



Computer Retailing:
The growth industry of the 1980s.

Just wait until the economy gets hot! That's why this is a good time to consider the Byte Shop® opportunity.

If you are motivated to make a commitment to success in the computer retailing industry, you owe it to yourself to evaluate the Byte Shop® Franchise prospectus. Cash required: \$60,000. Franchise fee only \$10,000.

Just call or write.
21130 Cabot Boulevard
Hayward, CA 94545
415/783/8272

 **ByteShop®**
the affordable computer store.

Name _____
Company _____
Address _____
City/State/Zip _____
Phone _____

Byte Shop is a registered trademark of Byte Industries.

DECADES OF SERVICE Washington Computer Services

97 Spring St., New York, NY 10012 an affiliate of (WASHINGTON ELECTRONIC COMPANY) est. 1912

TO ORDER: Call our toll-free number: (800) 221-5416. In N.Y. State and for technical information: (212) 226-2121. Hours: 9 AM-5:30 PM (EST) Monday-Friday TELEX: 12-5606 CABLE: WASHCOMP NYK



The Professional's Workstation

NEC APC

8086. 16 bit processor; Two 8" DSDD disk drives; 128K RAM (to 256K); green or RGB color screen.

PERFECT FOR:
Word Processing
CAD/CAM graphics
(1024 x 1024 resolution)
DataBase Management
Accounting
Chang Lab's Microplan
IBM emulations
CP/M-86, MSDOS, UCSD P.

This new state-of-the-art workstation out-performs all others near its price range.

PRICES START BELOW
\$3300.00
(One disk drive, green)

On N.Y.S. Contract #P-07220
NEC COMPUTERS AND MONITORS

PLEASE! Do not confuse us with mail order dealers. We are a full service distributor serving the data processing & installation needs of business & industry from micros to mainframes. System houses, educational institutions & governmental agencies given special consideration. Leasing available. N.Y. State agencies, municipalities, and schools—call us for information on our O.G.S. term contracts on hardware & software.

Please call to make an appointment for demonstration of this extraordinary computer at our showroom. Prices subject to change without notice; call for latest prices. Prices include 3% cash discount. N.Y. residents add sales tax. CP/M® is a trademark of Digital Research. All sales subject to our standard sale conditions (available on request). Above prices do not include customization or installation.

25800 Hillary St., Hayward, CA 94542.

March 24-25

Workshop on Performance and Evaluation of Local Area Networks, Worcester, MA. This workshop will seek to increase interaction and communications between active researchers and systems developers on the performance and evaluation of local-area networks. Contact T. C. Ting, Computer Science Department, Worcester Polytechnic Institute, Worcester, MA 01609, (617) 793-5670.

March 25

Communication Aids and Computers: A Voice for the Non-Vocal, Stokes Auditorium, Children's Hospital, Philadelphia, PA. This conference will present recent advances in technology, methodology, and research as they relate to computers and speech technology. Sessions will include lectures, videotapes, and equipment demonstrations. The registration fee is \$75 (if postmarked prior to March 4, 1983, the fee is \$65). This conference is sponsored by the Children's Seashore House and the Division of Child Development and Rehabilitation of the Children's Hospital of Philadelphia. For further information, contact Joan Bruno, Chief Speech Pathologist, Children's Seashore House, 4100 Atlantic Ave., Atlantic City, NJ 08404, (609) 345-5191, ext. 205.

March 25-27

Fantasylair '83, Tonkawa High School, Tonkawa, OK. This annual spring gaming convention is sponsored by the Northern Oklahoma Dungeoneers. It features fantasy and war games, tournaments, a costume contest, seminars, and prizes. The admission is \$3 per day; group discounts are available. For information, contact the Northern Oklahoma Dungeoneers,

POB 241, Ponca City, OK 74602, (405) 762-0349.

March 28-31

National Design Engineering Show and Conference, McCormick Place, Chicago, IL. The conference is sponsored by the American Society of Mechanical Engineers' design engineering division. It will run concurrently with the National Plant Engineering and Maintenance Show and Conference. Details are available from Clapp & Poliak Inc., 708 Third Ave., New York, NY 10017, (212) 661-8410.

April 1983

April 5-8

Computers/Graphics in the Building Process, Convention Center, Washington, DC. The focus will be on the needs of private sector and federal users for computer/graphics applications in architecture, engineering, design, planning, and management of the building process. America's top 400 construction contractors and 500 leading design firms are expected to attend the tutorials, exhibits, and technical and management sessions. This event is cosponsored by the National Academy of Sciences' Advisory Board on the Built Environment (ABBE) and the World Computer Graphics Association (WCGA). For details, contact the WCGA, Suite 399, 2033 M St. NW, Washington, DC 20036, (202) 775-9556.

April 5-8

Distributed Processing, Mini and Microcomputer Implementations, Boston, MA. For details, see March 8-11.

April 5-8

The Second Annual Convention and Exposition of the Electronic Funds Transfer Association—EFT Expo, Riviera Hotel, Las Vegas, NV. Gen-

Huntington's Disease... The Genetic Time Bomb!



NATIONAL
HUNTINGTON'S DISEASE ASSOCIATION
Suite 501, 1441 Broadway, New York, N.Y. 10018
212-966-4320

79-11

THIS SPACE CONTRIBUTED BY THE PUBLISHER

Kill surges fast as lightning Surge Sentry... for pure power

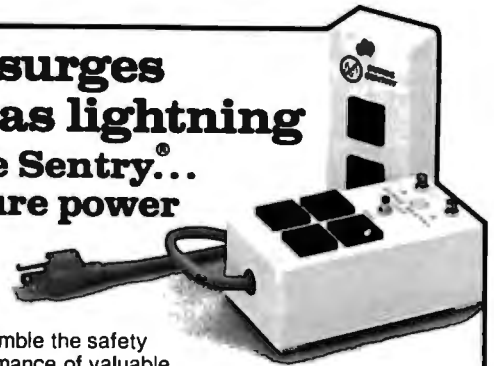

Don't gamble the safety and performance of valuable electronic equipment. Surge Sentry keeps power pure by guarding against transient impulses, damage from voltage drops and other destructive power line disturbances.

Surge Sentry:

- Clamps transient impulses in picoseconds
- Dissipates 1,000,000 watts in 100 microseconds
- Maintains its speed and performance without deterioration
- Gives visual indication of proper operation
- Is UL and CSA listed (most models)
- Has a one-year repair-or-replace warranty

To learn more about power line disturbances, our line of plug-in power protection, and where to obtain your Surge Sentry, call toll-free (800) 892-1342. In California, (408) 438-5760.



**RKS
INDUSTRIES**

RKS Industries, Inc.
4865 Scotts Valley Drive
Scotts Valley, CA 95066

FEBRUARY SPECIALS

ParaDynamics R.M. Mainframe, 18 slots w/C.V.T. p/s & state of the art cooling	637.00
CROMEMCO, 16 FDC D.D. Disk Controller Board	506.00
MORROW DESIGNS, WB-800 8 Slot Motherboard	75.00
VOTRAX, Type-n-Talk, compatible w/most computers	219.00
TECMAR'S Shared Device (4) Controller for IBM PC	319.00
CCS, 64K Dynamic RAM Board	319.00
GODBOUT/COMPUPRO, RAM 16, static 64K board	489.00
ADDS Viewpoint, green screen terminal w/detached k.b.	495.00
AMDEK, Color II, Hi-RES, RGB, 13" monitor	695.00
E.C.T. RM-10 slot MB w/15AMP p/s	225.00
EPSON MX100 III	595.00
SCION'S MicroAngelo, Multi-Trans. Color graphics	Call
TELEVIDEO Terminal, TVI 950	895.00

HOURS 9:00 AM — 6:00 PM M-F

Subject to Available Quantities • Prices Quoted Include Cash Discounts.
Shipping & Insurance Extra.

We carry products from all Major Manufacturers



UV EPROM ERASER

- * Erases over 15 EPROMS - 15 minutes erase time
- * Element life 7700 hours
- * Intensity: 12Ws/cm² at 1"
- * Erases all UV EPROMS (2716, 2732, 2516, 2532, etc.)

\$49.95*

* HOBBY MODEL

INDUSTRIAL MODEL

QUV-T8 / 2N

\$68.95

WITH TIMER AND
SAFETY SWITCH

QUV-T8 / 2T

\$97.50

INTELLIGENT PROGRAMMER STAND ALONE RS-232

- * RELIABLE
- * EASY COPY (No external
equipment needed)
- * USER FRIENDLY

COMPATIBLE:
IBM PC, TRS-80, APPLE, CPM,
FLEX, TEKTRONICS, MDS

(MCS-48)

PROGRAMMING
PRICE INCLUDES
PERSONALITY MODULE

\$489.00

PROGRAMS: 2508, 2516, 2532, 2716, 27C16, 27C32,
2732A, 2758, 8748, 8749H, 8748H

OPTIONAL MODULES: 2564, 2764, 8755A, 8741

- * STAND ALONE, CRT, OR COMPUTER CONTROL
- * UPLOAD/DOWNLOAD IN MOTOROLA OR INTEL HEX FORMAT
- * MICROPROCESSOR BASED * 4 K INTERNAL RAM
- * 90 DAY PARTS & LABOR WARRANTY ON ALL PRODUCTS

SOON TO BE RELEASED:

PROMPRO-8 128K Version \$689.

MONEY BACK GUARANTEE

LOGICAL DEVICES INC.

781 W. OAKLAND PARK BLVD. • FT. LAUDERDALE, FL 33311

Phone Orders (305) 974-0967 • TWX: 510-955-9496

SEE US AT COMDEX SPRING - BOOTH #3019

Event Queue

eral and concurrent sessions will focus on electronic payment systems and services. Topics to be covered include automated teller machines, home information and financial services, legal issues, and technical standards. Further information is available from the EFT Association, Suite 800, 1029 Vermont Ave. NW, Washington, DC 20005, (202) 783-3555.

April 10-13

APL83, Sheraton Washington Hotel, Washington, DC. This conference and exhibition includes hands-on displays and presentations of technical papers. For particulars, contact D & S Whyte Associates, Conference and Exhibits Manager, Suite 200, 117 King St., Alexandria, VA 22314, (703) 548-2802.

April 11-15

Intergraphics '83, Takanawa Prince Convention Center, Tokyo, Japan. This conference and exhibition will cover a wide range of computer-graphics topics, including business and management graphics, virtual machine languages, and chemical and biochemical applications of computer graphics. Complementing formal programs will be speakers, discussions, and tutorials. For complete details, contact the World Computer Graphics Association, Suite 250, 2033 M St. NW, Washington, DC 20036, (202) 775-9556.

April 12-13

Selecting a Microcomputer for Scientific and Engineering Applications, Golden, CO. For details, see March 15-16.

April 12-15

Computer Network Design and Protocols, Boston, MA. For details, see March 1-4.

April 13-20

Hanover Fair '83—Cebit '83, Hanover, West Germany. The Hanover Fair is one of the world's largest industrial trade fairs. Attention will be paid to office equipment and data-processing technology. More than 1200 exhibitors from 30 countries will display their products to a crowd of more than 230,000. Full information is available from the Hanover Fairs Information Center, Salem Industrial Park, POB 338, Whitehouse, NJ 08888, (800) 526-5978; in New Jersey, (201) 534-9044.

April 15-17

The Use of Computers in Psychology, Hilton, Wilmington, NC. With a focus on microcomputers, the five planned symposia will explore such issues as statistical and therapeutic applications and the use and misuse of microcomputers in psychological assessment. For complete details, write to Steven R. Edelman, Association of Eastern North Carolina Psychologists, 105 Lou Dr., Goldsboro, NC 27530.

April 19-21

Electro/83—High-Technology Electronics Exhibition and Convention, Coliseum and Sheraton Centre, New York, NY. For information, contact Electronic Conventions Inc., 999 North Sepulveda Blvd., El Segundo, CA 90245, (800) 421-6816; in California, (213) 772-2965. ■

In order to gain optimal coverage of your organization's computer conferences, seminars, workshops, courses, etc, notice should reach our office at least three months in advance of the date of the event. Entries should be sent to: Event Queue, BYTE Publications, POB 372, Hancock NH 03449. Each month we publish the current contents of the queue for the month of the cover date and the two following calendar months. Thus a given event may appear as many as three times in this section if it is sent to us far enough in advance.

Books Received

The Art of Programming the 1K ZX81, M. James and S. M. Gee. London, England: Bernard Babani Publishing Ltd. (The Grampians, Shepherds Bush Rd.), 1982; 86 pages, 11.1 by 17.6 cm, softcover, ISBN 0-85934-084-8, \$1.95.

Assembly Language Programming for the Apple II, Robert Mottola. Berkeley, CA: Osborne/McGraw-Hill, 1982; 143 pages, 16.4 by 23.3 cm, softcover, ISBN 0-931988-51-9, \$12.95.

BASIC Exercises for the Apple, J. P. Lamoitier. Berkeley, CA: Sybex, 1982; 258 pages, 17.7 by 22.8 cm, softcover, ISBN 0-89588-084-9, \$12.95.

The Cosmic Mind-Boggling Book, Neil McAleer. New York: Warner Books, 1982; 207 pages, 13.3 by 20.2 cm, softcover, ISBN 0-446-97663-6, \$7.95.

Discover FORTH, Learning and Programming the FORTH Language, Thom Hogan. Berkeley, CA: Osborne/McGraw-Hill, 1982; 142 pages, 16.5 by 23.4 cm, softcover, ISBN 0-931988-79-9, \$14.95.

Fun with Microcomputers and BASIC, Donald D. Spencer. Reston, VA: Reston Publishing Co., 1981; 128 pages, 21.2 by 27.8 cm, softcover, ISBN 0-8359-2214-6, \$9.95.

A Guide to Software in Applesoft, Bruce Presley. New York: Lawrenceville Press, 1982; 181 pages, 21.5 by 27.8 cm, softcover, ISBN 0-442-25890-9, \$12.95.

Inside Atari DOS, Bill Wilkinson. Greensboro, NC: Compute! Books, 1982; 120 pages, 15.5 by 22.4 cm, spiral binder, ISBN 0-942386-02-7, \$19.95.

Interface Projects for the Apple II, Richard C. Hallgren. Englewood Cliffs, NJ: Prentice-Hall, 1982; 170 pages, 17.4 by 23.4 cm, softcover,

ISBN 0-13-469387-6, \$12.95.

An Introduction to Programming and Problem Solving with Pascal, 2nd edition, G. Michael Schneider, Steven W. Weingart, and David M. Perlman. New York: John Wiley & Sons, 1982; 468 pages, 16.4 by 23.3 cm, hardcover, ISBN 0-471-08216-3, \$21.95.

Introduction to UCSD p-System, Charles W. Grant and Jon Butah. Berkeley, CA: Sybex, 1982; 370 pages, 17.7 by 22.8 cm, softcover, ISBN 0-89588-061-X, \$14.95.

Microcomputers in Amateur Radio, Joe Kasser. Blue Ridge Summit, PA: Tab Books, 1981; 307 pages, 12.7 by 20.8 cm, softcover, ISBN 0-8306-1305-6, \$9.95.

Microcomputers, What They Are and How to Put Them to Productive Use! A. J. Dirksen. Blue Ridge Summit, PA: Tab Books, 1982; 231 pages, 19.5 by 23 cm, softcover, ISBN 0-8306-1406-0, \$11.95.

Microprocessor Systems, Interfacing, and Applications, Robert J. Bibbero and David M. Stern. New York: John Wiley & Sons, 1982; 195 pages, 16.4 by 23.4 cm, hardcover, ISBN 0-471-05306-6, \$20.

Pocket Guide to BASIC, Roger Hunt. Reading, MA: Addison-Wesley, 1982; 64 pages, 4 by 6.3 cm, softcover, ISBN 0-201-07744-2, \$6.95.

Pocket Guide to COBOL, Ray Welland. Reading, MA: Addison-Wesley, 1982; 96 pages, 4 by 6.3 cm, softcover, ISBN 0-201-07750-7, \$6.95.

Pocket Guide to FORTRAN, Philip Ridler. Reading, MA: Addison-Wesley, 1982; 64 pages, 4 by 6.3 cm, softcover, ISBN 0-201-07746-9, \$6.95.

Pocket Guide to Pascal, David Watt. Reading, MA: Addison-Wesley, 1982; 64 pages, 4 by 6.3 cm, softcover, ISBN 0-201-07748-5, \$6.95.

Pocket Guide to Programming, John Shelley. Reading, MA: Addison-Wesley, 1982; 64 pages, 4 by 6.3 cm, softcover, ISBN 0-201-07736-1, \$6.95.

Practical Guide to Computers in Education, Peter Coburn, Peter Kelman, Nancy Roberts, Thomas F. F. Snyder, Daniel H. Watt, and Cheryl Weiner. Reading, MA: Addison-Wesley, 1982; 266 pages, 16.4 by 23.4 cm, softcover, ISBN 0-201-10563-2, \$9.95.

Practical Pascal Programs, Greg Davidson. Berkeley, CA: Osborne/McGraw-Hill, 1982; 205 pages, 21.1 by 27.5 cm, softcover, ISBN 0-931988-74-8, \$15.99.

Problem Solving and Computer Programming, Peter Grogono and Sharon H. Nelson. Reading, MA: Addison-Wesley, 1982; 284 pages, 16.4 by 23.4 cm, softcover, ISBN 0-201-02460-8, \$14.95.

Programming Microcomputers with Pascal, M. D. Beer. New York: Van Nostrand Reinhold, 1982; 256 pages, 15.3 by 23.4 cm, softcover, ISBN 0-442-2136-9, \$13.95.

Solid-State High-Frequency Power, Irving M. Gottlieb. Reston, VA: Reston Publishing Co., 1982; 246 pages, 16.4 by 23.3 cm, hardcover, ISBN 0-8359-7048-5, \$21.95.

Structured Programming with COMAL, Roy Atherton. New York: Halsted Press, 1982; 266 pages, 16.4 by 23.4 cm, hardcover, ISBN 0-470-27318-6, \$49.95.

The Z8000 Microprocessor, A Design Handbook, Bradley K. Fawcett. Englewood Cliffs, NJ: Prentice-Hall, 1982; 310 pages, 17.4 by 23.2 cm, softcover, ISBN 0-13-983734-5, \$16.95. ■

This is a list of books received at BYTE Publications during this past month. Although the list is not meant to be exhaustive, its purpose is to acquaint BYTE readers with recently published titles in computer science and related fields. We regret that we cannot review or comment on all the books we receive; instead, this list is meant to be a monthly acknowledgment of these books and the publishers who sent them.

BYTE's Bits

CP/M Bulletin Board Up In Los Angeles

Software Centre International has a remote CP/M and bulletin-board system up and running in Los Angeles. Callers can send, receive, and read messages, and the system accepts data rates of 110, 300, 450, 600, and 710 bits per second. The system features an extensive catalog of the latest Apple, Atari, CP/M, IBM Personal Computer, and TRS-80 software titles. It's open 24 hours a day, and you're invited to

leave messages and new ideas for the community.

Soon, volumes of CP/M Users Group (CPMUG) public-domain software will be available for downloading. The firm also plans to offer an array of source programs targeted at Apple, Atari, and TRS-80 users.

Contact The Software Centre, 11768 West Pico Blvd., West Los Angeles, CA 90064, (213) 473-1136, or leave a message for the system operator, "SYSOP," on the bulletin board, (213) 479-3189. ■

Ask BYTE

Conducted by Steve Clarla

CP/M for Homebrewed Systems

Dear Steve,

I have been bitten by the homebrew bug. I have a tentative design for a Z80-based computer with 64K bytes of memory and a memory-mapped video display that I plan to build with a Standard Microsystems Corporation CRT-5037. The system will use a Western Digital Corporation FD-1771 floppy-disk controller and whatever ROM (read-only memory) I may need. I'm fairly confident of my hardware and programming abilities, up to and including writing an operating-system monitor.

What would it take to run

the CP/M disk operating system? Is it generalized enough to be flexible; is a source listing available so that I can change the software to suit my system? How does CP/M talk to its host system? Is it merely designed for serial video? Can system ROM exist anywhere in memory? Does Digital Research even release this sort of information to Joe-Average hobbyist?

I know that tackling this will not be a piece of cake, but I'm a technician and do this sort of stuff for a living. In fact, I enjoy it—save for occasional head-to-wall bangings.

Phil Rorex
Long Beach, CA

CP/M (control program for

microcomputers) is made by Digital Research Corporation. In order to protect its product, no source code is available. The CP/M operating system is made up of the following main subsystems:

FDOS (functional disk operating system)—which is divided into (a) the BIOS (basic input/output system), which handles data transfers to and from peripherals, and (b) BDOS (basic disk operating system), which manages all disk files

CCP (console command processor)—which reads and processes your commands
TPA (transient program area)—a program storage and operating area

BOOT—a program that tells you where the CCP is located.

The BIOS is unique for each microcomputer. When you buy CP/M, you configure the BIOS so that it knows where your printer, terminal, and other devices are located. All other parts of CP/M are truly hardware-independent.

It takes a minimum of 16K bytes to run CP/M, and system ROM can be placed in the TPA. A bootstrap ROM is usually located at hexadecimal 0000 to read in the CP/M system. Digital Research has extensive documentation concerning the loading and implementation of CP/M. For further information, contact Digital Research Corp., POB 579, Pacific Grove, CA 93950, (408) 649-3896. . . . Steve

Remote IBM Keyboard Operation

Dear Steve,

I'd like to use my IBM Personal Computer's keyboard some 75 feet away from the main machine. Do you know a simple driver circuit using buffers and Schmitt triggers that will let me do this?

Buryl B. Noah
Hartsdale, NY

I addressed this problem several years ago in an article

titled "Come Upstairs and Be Respectable" (May 1977 BYTE, page 50; also available in Ciarcia's Circuit Cellar, volume 1, from BYTE/McGraw-Hill, Princeton Rd., Hightstown, NJ 08520, (609) 426-5254). The parallel output of the keyboard is converted to serial data by a UART (universal asynchronous receiver/transmitter), then transmitted over a long twisted pair. Because the output of the IBM's keyboard is

serial, all you need to do is build the part of the circuit that buffers and detects the signals (figure 1).

The preferred method for transmitting data over long distances is to use a balanced line. In my article, I used National Semiconductor's 5-volt differential line driver, DS8830, and a line receiver, DS8820. Texas Instruments makes equivalent devices called the SW75182 and the SW75183. . . . Steve

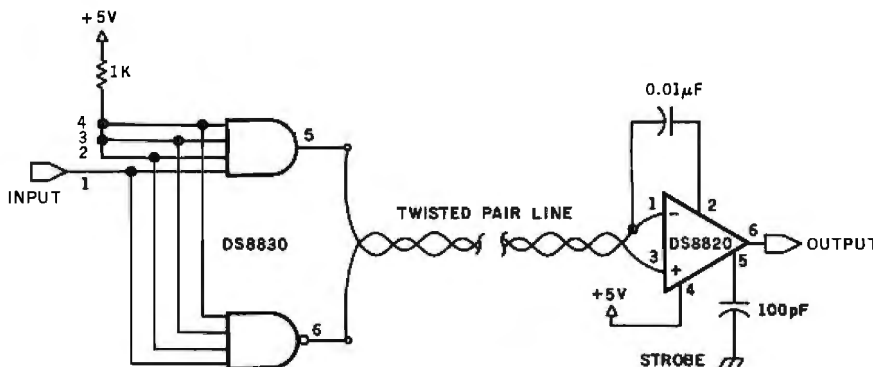

Figure 1

Doubling Expansion Interface Memory

Dear Steve,

The Expansion Interface for the Radio Shack TRS-80 Model I has only 16K bytes of memory. I would like to upgrade that to 32K bytes. How do I go about it? I see that there are eight unused sockets inside the interface. Can I plug in eight more 4116-200ns dynamic-memories, or is there more to it than that?

Michael Meyers
San Bernardino, CA

Expanding the Radio Shack Expansion Interface from 16K bytes to 32K is simply a matter of plugging eight additional memories (type 4116-200ns) into the eight empty sockets you mentioned. The only precautions are to be sure that the circuits are oriented properly and you must avoid any static damage

by touching a ground connection before handling the devices. Naturally, all power must be off before inserting or removing any ICs from a computer or expansion interface. . . . Steve

Speaking of Speech Recognition

Dear Steve,

As a long-time subscriber to BYTE, I have enjoyed your many articles. In particular, I was quite impressed by your article entitled "Use of Voiceprints to Analyze Speech," which appeared in the March 1982 BYTE (page 50).

In that article, you made reference to speech-recognition systems, both for professional computing systems and personal computers. You also mentioned that budget-priced speech-recognition systems, costing in the neighborhood of \$500, are available. Do you know where I could get more information about such systems? Could you give me the names and addresses of one or more companies that market speech-recognition systems for personal computers? Are any systems available for S-100 bus computers?

R. L. Froemke
Tallahassee, FL

The field of speech recognition is emerging from science fiction into reality. Many companies are making products for both the hobbyist and the industrial computer markets. Here's a list of several companies marketing speech-recognition systems. . . . Steve

Centigram Corp.
Suite 108
155A Moffett Dr. Park
Sunnyvale, CA 94086

Interstate Electronics
707 East Vermont St.
Anaheim, CA 92803

Perception Technology Inc.
95 Cross St.
Winchester, MA 01890

Scope Electronics Inc.
1860 Michael Faraday Dr.
Reston, VA 22090

Scott Instruments
Suite 5
815 North Elm Street
Denton, TX 76201

Threshold Technology
1829 Underwood Blvd.
Delran, NJ 08075

Verbex Corp.
2 Oak Park
Bedford, MA 01730

Voicetek
POB 388
Goleta, CA 93017

Interchanges Slow, If Possible

Dear Steve,

I have a Radio Shack TRS-80 Model III at home and an Apple II Plus at work. Both machines have two 5¼-inch disk drives. I would like to write ASCII files and BASIC programs to disk with either machine and be able to read them with both.

Currently, I must transfer files through RS-232C serial interfacing, modems, and over telephone lines. The disk drives for both computers run at 300 rpm (revolutions per minute), so is it possible, with software only, to read files with the TRS-80 from a disk written by the Apple and vice versa?

Finis E. Gentry
Prospect, KY

Your question about interchanging disks between Radio Shack and Apple computers points up a major problem in the personal computer industry: because the disk for-

mats are not similar, it is impossible for one computer to read another computer's disk.

The fact that the disks run at the same speed is of no relevance because the number of sectors is not the same, the directories are stored on different tracks, and the data formats are not alike. Your method of using an RS-232C interface and a modem to transfer between computers works fine. But it's terribly slow if data is transferred at

300 bps (bits per second). If both computers are in the same room, the serial ports can be directly connected and data transferred at rates of up to 19,200 bps.

One of the strong points of the CP/M operating system (distributed by Digital Research) is that its disk formats are identical for different computers. Therefore, the disks are portable and can be saved on one computer and loaded on another. . . . Steve■

NEW

IMMEDIATE
DELIVERY



**INCOMM AUTO DIAL 300/1200
(212A) MODEM FOR \$599.00**
**INTRODUCTORY GET ACQUAINTED
PRICE!**

(For A Limited Time Only!)

**FOR A AUTOMATIC DIALING
300/1200 BAUD MODEM \$495.00**
(Limit Two Per Customer) *Compatible with Hayes

YOU DO NOT NEED A TELEPHONE
"To originate or to receive a call" Simply hook up the modular jack (RJ11C) directly to the phone line, then type the phone number in your terminal or Microcomputer and the **INCOMM Auto Dial 212A Modem** will automatically dial the number and make the connection. It will then remember the number and will redial by a simple command. The reliability of all **INCOMM** products is so high that we back our products with a full **TWO YEAR WARRANTY!**

DEALER INQUIRIES INVITED!
(Some selected territories are still available)

**CALL COLLECT TO ORDER
DESK ONLY (312)459-8874**
(Bank Cards accepted).

INCOMM
115 N. Wolf Road
Wheeling, IL 60090
(312)459-8881

Clubs and Newsletters

By Word of Mouth

W.P. News: Writer's POV on Word Processing is a newsletter for wordsmiths who work with computers. It is published bimonthly by Word of Mouth Enterprises. The newsletter includes evaluations of hardware and software for writing needs, interviews with authors, and up-to-date developments for writers. The annual subscription fee is \$20. For more information, write to Word of Mouth Enterprises, 1765 North Highland #306, Hollywood, CA 90028.

Attention: Dentists

Dentists in Detroit have formed a users group for those who have purchased the Dental Practice package from Moore Business Systems Inc. The group's members discuss various hardware and software products, assist members with specific computer problems, and plan to develop a library of self-help materials. For more information, forward a self-addressed envelope to W.A. Riggert, D.D.S., Parkwood Dental Group, 10831 West Ten Mile Rd., Oak Park, MI 48237.

Experimenters In Canada

Ipsa Facto is a publication of the Association of the Computer-Chip Experimenters, a nonprofit, educational organization based in Ontario, Canada. Meetings are held on the second Tuesday of each month, September through June, at 7:30 p.m. in room B123, Sheridan College, 1430 Trafalgar Rd., Oakville, Ontario. Membership dues are \$18 and entitle you to six issues of *Ipsa Facto*. For fur-

ther information, write to Mike Franklin, Association of Computer-Chip Experimenters, 650 Laurier Ave., Milton, Ontario L7T 4R5, Canada, or call (416) 878-0740.

Foghorn from FOG

The First Osborne Group (FOG) is for Osborne users and other computer owners. The group plans to present reviews of new software and hardware in its newsletter, *Foghorn*, and through local meetings. Vendors or interested individuals can contact Craig R. Chun, Apt. 225, 1607 Parkmoor Ave., San Jose, CA 95125, or call (408) 947-1650.

OSBUG In Canada

An Osborne 1 Users Group (OSBUG-Canada) meets on the third Monday of each month in the Vancouver area. OSBUG-Canada works with both FOG and the Northwest Osborne Users Club. Further information can be obtained by contacting Debra Danny, 15227 Russell Ave., White Rock, British Columbia, V4B 5C3 Canada, or by phoning (604) 536-0266.

TRS-80 Users In Chicago

The Chicago TRS-80 Users Group publishes a monthly newsletter. *Chicatrug News* prints "All the TRS-80 News You Need When You Need It." Single issues are \$1.50; subscriptions cost \$12 for one year in the U.S., \$16 in Canada and Mexico, and \$26 elsewhere. Press releases and articles are welcome. For further information, contact Emmanuel B. Garcia Jr. & Associates, Suite 2118, 203

North Wabash, Chicago, IL 60601, or call (312) 782-9750.

Audio-Visual News Updated

Navanews is the biweekly bulletin of the National Audio-Visual Association (NAVA), an international trade association of audio-visual/video dealers, manufacturers, and producers. Subscriptions are \$50 per year. For information, write to NAVA, 3150 Spring St., Fairfax, VA 22031, or call (703) 273-7200.

Southern Hobbyists

The CSRA Computer Club is an active group of computer hobbyists and professionals that has been producing a monthly newsletter for six years. Dues are \$12 a year; students are half price. Anyone interested may attend meetings which are held on the third Thursday of each month at 7:30 p.m. For more information, write to the CSRA Computer Club, POB 284, Augusta, GA 30903.

Tips for the Salesman

Master Salesmanship is a newsletter that focuses on effective techniques for selling data-processing products and services. For a free copy of *Master Salesmanship*, call Michael Lodato at (213) 889-2607, or write to M.W.L. Inc., 32038 Watergate Court, Westlake Village, CA 91361.

Attention: Homebrewers

The *Homebrew Computer Club Newsletter* will keep you

posted on this San Francisco Bay area club's monthly meeting dates and locations. To subscribe, write to the *Homebrew Computer Club Newsletter*, POB 626, Mountain View, CA 94042.

Newsletter Offer

The Small Business Systems Group publishes a newsletter that is available free for six months from the date of your return of the Product License Agreement proving purchase of at least \$150 of hardware or software sold through SBSG. For details, write to the Small Business Systems Group, Newsletter Subscription, 6 Carlisle Rd., Westford, MA 01886, or call (617) 692-3800.

Phoenix Valley Idea Exchange

The Phoenix Valley of the Sun IBM PC Idea Exchange is held once a month for anyone interested in using and programming the IBM Personal Computer. It is sponsored by the United Systems Corporations of Phoenix, Arizona. For meeting information, write to the IBM PC Idea Exchange, c/o United Systems Corporations, 1074 East Sandpiper Dr., Tempe, AZ 85283, or call (602) 831-9363.

SVC³ Presents: A New Club

The Silicon Valley Color Computer Club is for TRS-80 Color Computer owners. It meets on the fourth Tuesday of each month at 7:30 p.m. in the GTE-Sylvania Cafeteria, Building #3, 100 Ferguson Dr., Mountain View, California. For more information, call

(408) 749-1947, or write to the Silicon Valley Color Computer Club, POB 61593, Sunnyvale, CA 94088.

Support for Home Computer Users

The International Home Computer Users Association is an independent, nonprofit organization formed as a support group for home computer owners. It provides members with an information and referral service, a biweekly bulletin, consumer aid, and a monthly newsletter. The group has published information on how to start a users group in your area. For more information, write to ICA, POB 371, Rancho Santa Fe, CA 92067.

Apfelsaft Comes from West Germany

The *Apfelsaft* newsletter is available to Apple and Basis Computer users anywhere in the world. It is produced for English-speaking people living overseas. *Apfelsaft* (apple-juice) is supported by the Ramstein Computer Club, which meets monthly. For further information, write to *Apfelsaft*, Wade Arnold, Benzinning 37, D-6750 Kaiserslautern, West Germany, or call (0631) 93396.

SUN In Illinois

The Sinclair Users Network (SUN) is a nationwide users group for owners of Sinclair ZX80/81 and Timex/Sinclair 1000 computers. It produces monthly bulletins and quarterly newsletters containing the latest information from Sinclair, Timex, and other manufacturers. For further information, write to Diana Wright, 2170 Oak Brook Circle, Palatine, IL 60067, or call (312) 934-9375.

Information from Waterloo

Infowat is the newsletter produced by Watsoft Products Inc., a company established by the University of Waterloo in Ontario. The newsletter has reviews of educational software developed by the university. A subscription (10 issues) costs \$10 (Canadian funds in Canada, U.S. dollars elsewhere). To receive information, write to *Infowat*, POB 943, Waterloo, Ontario N2J 4C3, Canada. ■

If you would like BYTE readers to know about your club or newsletter send the details accompanied by no more than one newsletter to Clubs and Newsletters, BYTE Publications, POB 372, Hancock, NH 03449. Overseas groups are encouraged to participate. Please allow at least three months for your announcement to appear.

Not Just Another Summer Camp.

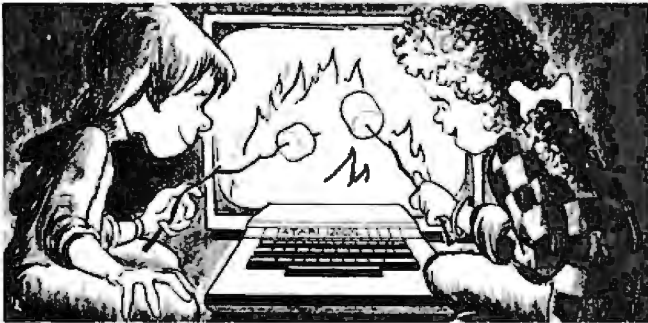

Learning is part of the fun at ATARI® Computer Camps.

- Coed, ages 10-16
- With or without computer skills
- 2, 4, or 8 week sessions
- Traditional camp activities
- Convenient locations
- Professional Camp Directors

CALL FREE 800/847-4180

**ATARI
COMPUTER CAMPS**

For more information and a free, color brochure, call free 800/847-4180 or write to 40 East 34th Street, Dept. C.T., New York, N.Y. 10016 (please include age and phone number). Outside U.S. or in New York State, call collect 212/889-5200. Staff applicants should apply in writing.

© A Warner Communications Company



Epson MX80 F/T III Call
Epson MX100 F/T III Call

C. Itoh ProWriter 8510AP, 120 CPS, Graphics, Parallel \$459

NEC 8023A, 100 CPS, Tractor/friction fee, Graphics, parallel . . . \$459

Okidata ML80P, 80 CPS . . . \$338
Okidata ML82A, 120 CPS . . \$399
Okidata 84, 200 CPS, 132 col \$698
Okidata 84S 200 CPS, Serial \$1099

Star Microtronics Gemini 10 8x8 matrix Hi Res. graphic, 100CPS, friction/tractor feed, parallel . . \$389
Gemini 15 15" carriage . . . \$495

MICRO DECISION COMPUTER
Two disk drives, CPU, Terminal and FREE software. Special . . \$1,995





IBM Personal Computer
Call for prices and availability



AST MEMORY CARDS
ComboPlus, MegaPlus and IQ Plus cards for IBM PC. Call for best price

TELEVIDEO TERMINALS

910 List \$689	\$668
912 List \$925	\$738
920 List \$885	\$785
925 List \$995	\$729
950 List \$1,195	\$935

C. ITOH F-1D PRINTER
40 CPS daisywheel printer. Parallel. Limited time offer. . . \$ Call

COMREX CR-1-S Daisywheel, 17 CPS, Parallel \$789.00
COMREX CR-1-S As above but serial w/tractor \$789.00

MONITOR SALE

Dynax GM-120, Green	\$139
Dynax AM-121, Amber	\$159
Taxan KG12N, Green	\$145
Taxan KA12N, Amber	\$150
NEC JC1203 RGB for IBMPC	\$749
Cable- NEC to IBM	\$19
Princeton HK-12 RGB for IBM	\$575
Taxan RGBvision I, 330 dot	\$365
Taxan RGBvision II, 510 dot	\$549
Taxan RGBvision III, 630 dot	\$640
Cable-Taxan to IBM or Apple	\$19

5 1/4" TANDON DRIVES
The newest, IBM PC compatible. Installation instruction included.

TM100-1A, SSDD 160K	\$175
TM100-2A, DSDD 320K	\$259



Kaise Autorange Digital Multimeter
3.5-digit LCD w/ auto unit & sign indication. Full auto ranging on Volt & Ohm w/ 10Amp AC/DC range.
Model SK-6440
Special \$89.50

BROTHER PRINTER HR-1
Letter quality daisywheel printer, 15 CPS, friction feed, Parallel interface. Super value \$759.00

NEC SPINWRITER 3550 Serial interface. Ideal for PC \$2,099.00

To order, please send money order or cashier's check. Personal or company checks require 2-3 weeks to clear. Prices reflect 3% cash discount. Visa/Mastercard accepted. Shipping, insurance & handling charges: 3% of total order value by UPS Surface, 5% by UPS Air or Parcel Post. California residents add sales tax. COD's require 20% deposits. Prices & availability subject to change without notice. Send for Monthly Specials and Catalog.

EASTERN ENTERPRISES, INC.
2937 S. VAIL AVE., LOS ANGELES, CALIF. 90040
TOLL-FREE OrderDesk **(800)392-7081** Calif., Alaska, Hawaii (213)725-3080

Software Received

Apple

The Apple's Core, a tutorial program. The disks and manual comprising this package serve as a beginner's guide to Applesoft BASIC. Each lesson in the manual corresponds to a program on the disk. For the Apple II Plus; floppy disk, \$49.95. The Little Professor, POB 301, Swanton, VT 05488.

The Arithmetic Classroom, part of a set of tutorial programs. The programs in this package cover the basic principles of mathematics. Each program covers a different aspect of math. For the Apple II Plus; floppy disk, \$49.95. Sterling Swift Publishing Co., 1600 Fortview Rd., Austin, TX 78704.

Artesians, an arcade-type game. You must steal several containers of water from a four-story building while sneaking through the floors and avoiding the guards, dogs, and the artesians. For the Apple II; floppy disk, \$34.95. Renaissance Technology Corp., 1070 Shary Circle, Concord, CA 94518.

Beneath Apple Manor, an adventure-type game. This remake of the original game includes high-resolution graphics and sound. Your mission is to explore an underground maze and find treasures. For the Apple II; floppy disk, \$29.95. Quality Software, Suite 105, 6660 Reseda Blvd., Reseda, CA 91335.

The Blade of Blackpoole, an adventure-type game with graphics. Your quest is for the magical sword Myraglym. You must fight off beasts and flesh-eating plants as you search the caverns near the blackpoole. For the Apple II; floppy disk, \$39.95. Sirius Software Inc., 10364 Rockingham Dr., Sacramento, CA 95827.

Bug Battle, an arcade-type game. Bugs have invaded

your garden and your laser is the only defense you have against them. Game features include graphics and sound. For the Apple II Plus and Apple III; floppy disk, \$22.50. United Software of America, 750 Third Ave., New York, NY 10017.

Bug Byter, a screen-oriented 6502 machine-language debugger. This debugger features a display of all registers, literal and transparent breakpoints, and a resident assembler and disassembler. For the Apple II; floppy disk, \$47.50. Computer Advanced Ideas Inc., Suite 341, 1442A Walnut St., Berkeley, CA 94709.

Bulk Mailer, a mailing-list program. This system is configured for either a floppy-disk or a hard-disk system. It can store 1200 names on a floppy disk or 32,000 names on a hard disk. Names can be coded and retrieved. For the Apple II; floppy-disk version, \$125; Corvus hard-disk version, \$250. Satori Software, 5507 Woodlawn Ave. N, Seattle, WA 98103.

Career Directions, a program to help high school students identify career interests. By completing a series of exercises, students can determine the type of career they prefer. For the Apple II; floppy disk, \$59.95. Systems Design Associates Inc., 723 Kanawha Blvd. E, Charleston, WV 25031.

Caves of Olympus, an adventure-type game. You are far beneath the Palace of Anson Argyris. You must try to escape the attack of the Laren invaders by traversing the caves of Olympus. For the Apple II Plus; floppy disk, \$39.95. Howard W. Sams & Co. Inc., 4300 62nd St., POB 558, Indianapolis, IN 46268.

Counting Plus, an educational program designed to introduce very young children to the principles of numbers. It covers simple count-

ing, addition, and subtraction. For the Apple II; floppy disk, \$34.95. The Little Professor (see address above).

Desktop/Plan II, a financial planning, budgeting, and analysis package with graphics. This program lets you build modifiable financial models. It can make use of Visicalc data files. For the Apple II; floppy disk, \$250. Visicorp, 2895 Zanker Rd., San Jose, CA 95134.

Diamond IX, a baseball statistics package. A coach can keep individual and team statistics to see his team's strong and weak points. Reports can be displayed or sent to a printer. For the Apple II; floppy disk, \$41.95. Competitive Computing Inc., 15 Sequoia Dr., Watchung, NJ 07060.

Disk O' Utilities, a package containing 13 utility programs, including automatic line numbering for Applesoft programs, a program to recover files, a catalog sorter, and a routine to indicate the number of free sectors on a disk. For the Apple II Plus; floppy disk, \$13.95. Broadway Software, Suite 136, 642 Amsterdam Ave., New York, NY 10012.

Diversi-DOS, a utility program that's compatible with Apple DOS 3.3. This program loads and saves BASIC, binary, and text files two to five times faster than DOS 3.3. A keyboard and print buffer are provided. For the Apple II; floppy disk, \$30. Diversified Software Research Inc., 5848 Crampton Court, Rockford, IL 61111.

The DOS Enhancer, a set of utility programs to speed up Apple DOS 3.3. These programs increase the speed of disk-file saves and reads. Additionally, the programs have expanded menus and are said to run BASIC programs five times faster than

DOS 3.3. For the Apple II; floppy disk, \$69.95. S & H Software, 58 Van Orden Rd., Harrington Park, NJ 07640.

DOS Helper, a utility program that lets you change DOS commands, modify error messages, alphabetize catalogs, expand catalog displays, restore deleted files, lock or unlock files, and more. For the Apple II; floppy disk, \$29.95. The Little Professor (see address above).

Ernie's Quiz, a set of four educational games for children aged 4 to 7. This package includes guessing and counting games, a make-a-face puzzle, and a puzzle using Sesame Street Muppet characters. For the Apple II; floppy disk, \$50. Apple Computer Inc., 20525 Mariani Ave., Cupertino, CA 95014.

Family Pak 1, a trio of games for the entire family: Hi-Lo, Hangman, and Go Fish. For the Apple II; floppy disk, \$29.95. Cortland Data Systems, POB 14414, Chicago, IL 60614.

Fore, a golf simulation game featuring high-resolution graphics. This game offers a choice of two courses, eight types of terrain, and 15 clubs. For one to four players. For the Apple II; floppy disk, \$29.95. Epyx/Automated Simulations Inc., 1043 Keil Court, Sunnyvale, CA 94086.

Games for the Apple Computer, a program disk of modules that lets you create games. This package complements Franklin, Knoltnow, and Finkel's book *Techniques for Creating Golden Delicious Games for the Apple Computer*. For the Apple II; floppy disk, \$47.90, including the book. John Wiley & Sons Inc., 605 Third Ave., New York, NY 10158.

Instant Mathematical Programming, a program package that solves a variety of

mathematical problems. Designed for professionals or students, this program can, for example, handle simultaneous equations in algebraic form. For the Apple II; floppy disk, \$250. PCD Systems Inc., 163 Main St., POB 143, Penn Yan, NY 14527.

Instant Zoo, a set of five programs for children aged 7 to 10. This package has fast-moving games to help develop pattern-recognition and word skills. For the Apple II; floppy disk, \$50. Apple Computer Inc. (see address above).

League Registration, a filing system for sports league information. This system lets you organize, manage, and retrieve league and player information. A program disk can hold information on up to 500 players. For the Apple II Plus; floppy disk, \$150. Market Computing, 201 15th Ave. SW, Puyallup, WA 98371.

League Scheduling, a program that creates a round-robin schedule for one or more athletic leagues. It prepares a game schedule taking into account teams, times, days of the week, and holidays or rainouts. For the Apple II Plus; floppy disk, \$100. Market Computing (see address above).

League Standings, a program that registers game results and computes league and team standings for one or more leagues. This program records win/loss statistics, displays statistics on screen, and lets you edit statistics. For the Apple II Plus; floppy disk, \$100. Market Computing (see address above).

Long-Term Reservations, a time-scheduling program that handles reservations for sports facilities where long lead-times and variable-length time periods are desired. Completed schedules can be sent to a printer. For

the Apple II Plus; floppy disk, \$100. Market Computing (see address above).

Mix and Match, a set of four educational games for children. This package includes a muppet match game, an animal word game, a puzzle, and a word game. An editor is provided for the word game. For the Apple II; floppy disk, \$50. Apple Computer Inc. (see address above).

Monster Mash, an arcade-type game. Your job is to prevent the monsters from leaving the graveyard and attacking the people in the city. All you have are your reflexes and the Monster Mash. For the Apple II and Apple III; floppy disk, \$29.95. The Software Farm, 3901 South Elkhart, Aurora, CO 80014.

PDQ 1.0, a database-management program featuring user-friendly prompts, simple commands, and fast retrieval. Its files can hold up to 28,000 characters. You can have as many as eight files on two drives. For the Apple II; floppy disk, \$59.95. Howard W. Sams & Co. Inc. (see address above).

The Programmable Cube, a program for solving the Rubik's Cube puzzle. Serving as an exercise in programming instruction, this package allows you to develop a cube-solving program. Video displays generated by this program are suitable for black-and-white or color monitors. For the Apple II; floppy disk, \$34.95. Metacomet Software, POB 31337, Hartford, CT 06103.

Quick-Search Librarian, a database-management program that cross-references literature citations. Technical references or journal articles can be cross-referenced with up to 12 keywords. One thousand articles or references can be stored on a single disk. For the Apple II

Plus; floppy disk, \$75. Interactive Microware Inc., POB 771, State College, PA 16801.

Rapid Reader, an educational program. This program helps to increase reading speed by progressively training you to rapidly recognize words and whole sentences. For the Apple II; floppy disk, \$39.95. Silicon Valley Systems, Suite 4, 1625 El Camino Real, Belmont, CA 94002.

Short-Term Reservations, a time-scheduling program that can make weekly lists of reservations for sports facilities and print out the schedule showing reserved times, facilities, and contact persons. For the Apple II Plus; floppy disk, \$100. Market Computing (see address above).

Spotlight, a set of four games for children aged 9 to 13. The games cover such advanced ideas as how light is reflected and elementary logic. For the Apple II; floppy disk, \$50. Apple Computer Inc. (see address above).

Swim Meet, a management program for scheduling swimming meets. This program registers contestants, records times, assigns lanes, and prints a list of final standings. For the Apple II Plus; floppy disk, \$125. Market Computing (see address above).

Tennis Draw, a tennis tournament-management program. This program registers and seeds players and teams for matches. It follows the U. S. Tennis Association rules. For the Apple II Plus; floppy disk, \$60. Market Computing (see address above).

Transylvania, an adventure-type game. The object of this game is to rescue a princess from the evil vampire. You must search a forest and a castle deep within Transylvania—avoid the werewolf.

For the Apple II; floppy disk, \$34.95. Penguin Software, 830 4th Ave., Geneva, IL 60134.

Visicalc Advanced Version, an electronic spreadsheet program. This version allows you to protect memory cell contents and hide sensitive information. It includes on-screen help displays. For the Apple III; floppy disk, \$400. Visicorp (see address above).

Atari

Alien Garden, an arcade-type game. You're an alien critter in a garden of crystal flowers. You must eat, bump, or sting as many flowers as you can before they destroy you. For the Atari 400/800; cartridge, \$39.95. Epyx/Automated Simulations Inc., 1043 Kiel Court, Sunnyvale, CA 94086.

Armor Assault, a simulation game. You're the commander of NATO's armored forces. You must try to stop the enemy's armored columns from rolling across the North German plain. For one or two players. For the Atari 400/800; floppy disk, \$39.95. Epyx/Automated Simulations Inc. (see address above).

Bandits, an arcade-type game. You must guard the supplies on a lunar supply depot from the thieving aliens. You are armed with a mobile laser gun and protected by a limited shield. For the Atari 800; floppy disk, \$34.95. Sirius Software Inc., 10364 Rockingham Dr., Sacramento, CA 95827.

BASIC Routines, a set of program routines and instructions to help you learn how to program an Atari computer. This package features common subroutines for player graphics and disk utilities. For the Atari 400/800; floppy disk, \$24.95. Adventure International, POB 3435, Longwood, FL 32750.

Software Received

Disk Workshop, a set of disk-utility programs that allows you to edit disks, copy disks rapidly, send a disk directory to a printer, and use machine-language strings in BASIC programs. For the Atari 400/800; floppy disk, \$39.95. Synergistic Software, Suite 201, 830 North Riverside Dr., Renton, WA 98055.

Diskey, a disk-utility program. With this program, you can examine and modify any sector on a disk, list unreadable sectors, send data in a sector to a printer, and copy a disk. Only one disk drive is required. For the Atari 400/800; floppy disk, \$49.95. Adventure International (see address above).

Gorf, a set of four arcade-type games: Astro Battles, Laser Attack, Space Warp, and Flag Ship. In all the games, you must destroy the attacking aliens to increase your score. For the Atari 400/800; floppy disk, \$39.95. Roklan Software, 10600 West Higgin Rd., Rosemont, IL 60018.

Labyrinths, a role-playing game. From a list of characters, you choose an identity to explore the labyrinth, find treasures, and fight monsters. For the Atari 400/800; floppy disk or cassette, \$28.95 and \$24.95, respectively. Progressive Computer Applications, POB 46, Burtonsville, MD 20866.

Paint, an educational program for children. This program lets your child draw color pictures on the screen, enlarge the picture, save it, and use different "brush" strokes and textures. For the Atari 400/800; floppy disk, \$39.95. Reston Publishing Co. Inc., 11480 Sunset Hills Rd., Reston, VA 22090.

Programmer's Workshop, a set of six utility programs. This package includes a disk-to-cassette transfer program, a compare utility for BASIC programs, and a cassette data-rate increase utility. For

the Atari 400/800; floppy disk, \$39.95. Synergistic Software (see address above).

Sneakers, an arcade-type game. Shoot the aliens before they destroy your ships. This game features five levels of skill and up to nine attacks per level. Points are scored for each alien shot. For the Atari 800; floppy disk, \$34.95. Sirius Software Inc. (see address above).

Wizard of Wor, an arcade-type game. As you progress through a series of mazes, you must destroy the wizard and the various creatures that aid him to score points and win the game. For the Atari 400/800; floppy disk, \$39.95. Roklan Software (see address above).

CP/M

Accounts Receivable, an accounts-receivable package. This menu-driven package features on-demand reports for customer lists and master, aged analysis, and control reports. For CP/M-based systems; floppy disk, \$1095. Cougar Mountain Software, 10 South Latah, POB 6886, Boise, ID 83707.

Data Champ, a database-management program. Designed for the first-time user, this package allows you to create a customized database. The manual includes a complete training program. For CP/M-based systems; floppy disk, \$395. Innovative Micro Systems, 12506 East 21st St., Tulsa, OK 74219.

Disk Fix, a disk editor and file-recovery utility program. You can examine, copy, and edit any disk sector. It lets you recover disk files, reconstruct damaged sectors, and use both hexadecimal and ASCII numbers. For CP/M-based systems; floppy disk, \$150. The Software Store, 706 Chippewa Square, Marquette, MI 49855.

The Disk Inspector, a disk-utility program that lets you examine any sector on any

disk. Sectors from two different drives can be simultaneously displayed, copied, or modified. For CP/M-based systems; floppy disk, \$29.95. Realworld Software Inc., Suite 103, 913 South Fourth St., DeKalb, IL 60115.

Fancy Font System, a text-processing and print-formatting package designed for use with the Epson MX-80 printer. You can use a wide variety of letter fonts or create your own special font. For CP/M-based systems; floppy disk, \$180. Softcraft, Suite 1641, 8726 South Sepulveda Blvd., Los Angeles, CA 90045.

MenuMaster, a system that allows you to develop custom menus for applications programs. The menus can provide user prompts, help and error messages, and error trapping. For CP/M-based systems; floppy disk, \$195. Borland International, 69 Upper Georges St., Dun Laoghaire, Dublin, Republic of Ireland.

S-BASIC, a structured BASIC translator and compiler. This version of BASIC features the ability to reference subroutines by name, indenting to display program structure, and other such functions. Program line numbers are not required. For HDOS- and CP/M-based systems; 5¼-inch floppy disk, \$49.95. Sunflower Software, 13915 Midland Dr., Shawnee, KS 66216.

IBM Personal Computer

Aqua Run, an arcade-type game. You are a diver seeking treasure in an undersea maze. You must protect yourself from the undersea creatures by avoiding or spearing them. For the IBM Personal Computer; floppy disk, \$39.95. Soft Spot Micro Systems Inc., POB 415, North Canton, CT 06059.

Data Champ, a database-management program (see description under CP/M). For the IBM Personal Com-

puter; floppy disk, \$395. Innovative Micro Systems, 12506 East 21st St., Tulsa, OK 74219.

Executive Suite, a simulation game. In this game, you're an executive moving up the corporate ladder. You move through job interviews, middle management, and on into the executive suite. For the IBM Personal Computer; floppy disk, \$39.95. Armonk Corp., Suite 955, 610 Newport Center Dr., Newport Beach, CA 92660.

FORTH/level 2, an implementation of the FORTH language. This package features a multitasking real-time operating system with online documentation and support for the 8087 mathematics processor chip. For the IBM Personal Computer; floppy disk, \$300. FORTH Inc., 2309 Pacific Coast Highway, Hermosa Beach, CA 90254.

The Graphics Generator, a graphics generation program to create bar graphs, pie charts, and line or function graphs from mathematical data. You can superimpose graphs, send graphs to a printer, or save them on disk. For the IBM Personal Computer; floppy disk, \$195. Robert J. Brady Co., Bowie, MD 20715.

Graphmagic, a graphics generation program. You can draw visual representations of mathematical data in the form of bar and line graphs, pie charts, and scattergrams. For the IBM Personal Computer; floppy disk, \$89.95. International Software Marketing Ltd., Suite 421, 120 East Washington St., Syracuse, NY 13202.

Helpware, an interface program to IBM PC-DOS. This program simplifies using PC-DOS by providing a menu of file-manipulation commands. Files can be displayed, edited, and renamed with a single command. For the IBM Personal Computer; floppy disk, \$195. Soft-

Introducing...the Byte Book Club

FORMERLY COMPUTER PROFESSIONALS' BOOK CLUB

POWERFUL TOOLS! POWERFUL SAVINGS!

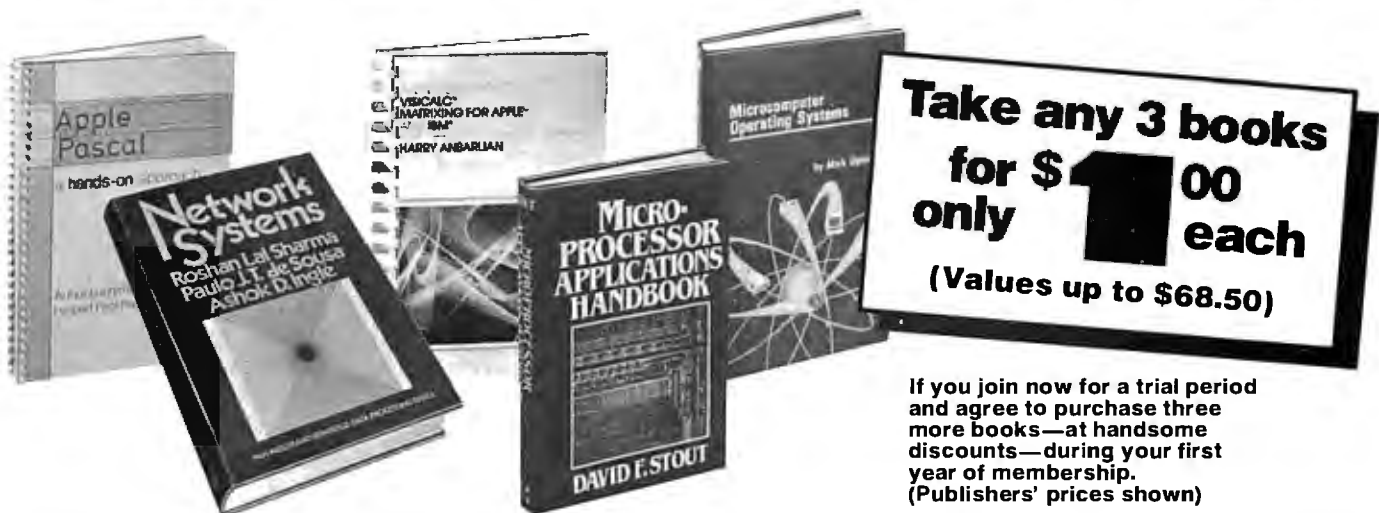

MICROPROCESSOR APPLICATIONS HANDBOOK By D. R. Stout
617/988B \$35.00
(Counts as 2 of your 3 books)

NETWORK SYSTEMS By R. Sharma, P. J. T. deSousa, A. D. Ingle
582557-0B \$29.95
(Counts as 2 of your 3 books)

SOFTWARE ENGINEERING: A Practitioner's Approach By R. S. Pressman
507/813B \$32.95
(Counts as 2 of your 3 books)

CIARCIA'S CIRCUIT CELLAR, Volume 2 By S. Ciarcia
109/63X \$14.75

COMPILER CONSTRUCTION: Theory and Practice By W. Barrett, and J. D. Couch
788/499B \$25.93
(Counts as 2 of your 3 books)

AN INTRODUCTION TO VISICALC® MATRIXING FOR APPLE® AND IBM® By H. Anbarlian
016/054 \$22.95

BUILD YOUR OWN Z-80 COMPUTER—and—280 USERS MANUAL. By S. Ciarcia & J. Carr
582337-3B \$29.90
(Counts as 2 of your 3 books)

MICROCOMPUTER OPERATING SYSTEMS By M. Dahmke
150/710 \$15.95

MINICOMPUTER AND MICRO-PROCESSOR INTERFACING By J. C. Cluley
582585-6B \$27.50
(Counts as 2 of your 3 books)

THE SOUL OF A NEW MACHINE By T. Kidder
582439-6 \$13.95

APPLE PASCAL By P. Luehrmann
491/712 \$16.95

MICROCOMPUTER GRAPHICS AND PROGRAMMING TECHNIQUES By H. Katzan, Jr.
582576-7 \$18.95

BASIC: GETTING STARTED By W. S. Davis
582355-1 \$5.95

INTERFACE PROJECTS FOR THE TRS-80 By R. C. Hallgren
582466-3 \$18.95

PRINCIPLES OF INTERACTIVE COMPUTER GRAPHICS, 2/e By W. M. Newman & R. F. Sproull
463/387B \$32.50
(Counts as 2 of your 3 books)

THE SMALL COMPUTER CONNECTION By N. L. Shapiro
564/124 \$16.95

THE DEVIL'S DP DICTIONARY By S. Kelly-Bootle
340/226 \$8.50

INTRODUCTION TO WORD-STAR™ By A. Naiman
582594-5 \$21.95

APPLE PASCAL GAMES By D. Hergert & J. T. Kalash
582521-X \$19.95

TRS-80 GRAPHICS FOR THE MODEL I AND MODEL III By D. Kater & S. Thomas
333/033 \$12.95

WORD PROCESSING HANDBOOK By I. Flores
582645-3B \$34.50
(Counts as 2 of your 3 books)

INVITATION TO FORTH By H. Katzan, Jr.
582284-9 \$17.50

PROGRAMMING WITH ADA: An Introduction by Means of Graded Examples By P. Wegner
789/24X \$17.95

Why YOU should join the Byte Book Club now!

- **Best and newest books from ALL publishers!** Books are selected from a wide range of publishers by expert editors and consultants to give you continuing access to the best and latest books in your field.
- **Big savings!** Build your library and save money too! Savings range up to 30% or more off publishers' list prices—usually 20% to 25%.
- **Bonus books!** You will immediately begin to participate in our Bonus Book Plan that allows you savings up to 80% off the publishers' prices of many professional and general interest books!
- **Convenience!** 14-16 times a year (about once every 3-4 weeks) you receive the Club Bulletin FREE. It fully describes the Main Selection

and alternate selections. A dated Reply Card is included. If you want the Main Selection, you simply do nothing—it will be shipped automatically. If you want an alternate selection—or no book at all—you simply indicate it on the Reply Card and return it by the date specified. You will have at least 10 days to decide. If, because of late delivery of the Bulletin you receive a Main Selection you do not want, you may return it for credit at the Club's expense.

As a Club member you agree only to the purchase of three additional books during your first year of membership. Membership may be discontinued by either you or the Club at any time after you have purchased the three additional books. Orders from outside the U.S. cannot be accepted.



Fill out the card and mail today! If the card is missing, write to:

BYTE BOOK CLUB, P.O. Box 582, Hightstown, New Jersey 08520

Software Received

wrights Inc., Suite 100, 12606 Greenville Ave., Dallas, TX 75243.

Mathemagic, a mathematics-processing program. You can enter mathematical formulas into this program using names for variables, build libraries of formulas, and use arrays of formulas and variables. For the IBM Personal Computer; floppy disk, \$99.95. International Software Marketing Ltd. (see address above).

Millionaire, a stock market simulation game. You can simulate buying and selling stocks, using put and call options, buying on margin, and borrowing against your net worth. The game gives you 15 stocks to manipulate. For the IBM Personal Computer; floppy disk, \$99.95. Blue Chip Software, Suite 125, 19824 Ventura Blvd., Woodland Hills, CA 91364.

muMath/muSimp-80, a mathematics processing package. You can enter mathematical formulas using algebraic notation. This program will simplify the formula and provide the answer. For the IBM Personal Computer; floppy disk, \$300. Microsoft Inc., 10700 Northrup Way, Bellevue, WA 98004.

The Pascal Toolkit, A Pascal utility program for use with MS-DOS. This program features an implementation of turtle graphics, console control commands, printer controls, and serial communications capabilities. For the IBM Personal Computer; floppy disk, \$150. Hi Tech Computer Services, 17 Mein Dr., New City, NY 10956.

Pool 1.5, a high-resolution graphics simulation game. This program allows you to play eight-ball, rotation, nine-ball, or straight pool. It features shot replay and friction control. For the IBM Personal Computer; floppy disk, \$34.95. Innovative Design Software Inc., POB 1658, Las

Cruces, NM 88004.

Softspool, a software print-spooler program that creates a user-defined print-spooler buffer in memory. It permits output to be sent to a printer while another program is running. For the IBM Personal Computer; floppy disk, \$49.95. Rickerdata, POB 288, Burlington, MA 01803.

Suite 16 Manager, an interface program to IBM PC-DOS. This program simplifies entering commands by providing a menu of command options. You can create your own menus for applications programs. For the IBM Personal Computer; floppy disk, \$60. Softwhere, 2162 Deerfield St., Thousand Oaks, CA 91362.

Visibridge, a Visicalc utility program that enhances report-printing capabilities by providing variable-width columns, column suppression, decimal point alignment, and disk storage. For the IBM Personal Computer; floppy disk, \$81. Solutions Inc., POB 989, Montpelier, VT 05602.

TRS-80

The BASIC Answer, a processing utility program for creating structured BASIC programs. Designed for use with the LDOS operating system, this utility lets you use labels instead of absolute line numbers. For the TRS-80 Models I and III; floppy disk, \$69. Logical Systems Inc., 11520 North Port Washington Rd., Mequon, WI 53902.

League Registration, a filing system for sports league information (see description under Apple). For the TRS-80 Models I and III; floppy disk, \$150. Market Computing, 201 15th Ave. SW, Puyallup, WA 98371.

Games for the II, a set of five arcade-type games: Skydiver, Star Battle, The Wall, Space Swarm, and Mayhem. Each game features graphics

and automatic scorekeeping. For the TRS-80 Model II; 8-inch floppy disk, \$29.95. Maryland Model II Games, 3304 Carlton Ave., Temple Hills, MD 20748.

Pandemonium, a word game. The object of this game is to place 25 random letters onto a playing board matrix to construct three-, four-, or five-letter words. A 6000-word dictionary is built into the program. For the TRS-80 Models I and III; floppy disk, \$39.95. Soft Images, 200 Route 17, Mahwah, NJ 07430.

Other Computers

ACCR, a simple database-management program. You can store, retrieve, search, and edit information about your personal finances or property. This program requires 16K RAM. For the ZX81/Timex-Sinclair 1000; cassette, \$19.95. R. S. Panwar, 2035 Kentland Dr., Houston, TX 77067.

ADDR, a simple database-management program. You can store, retrieve, search, and edit information. You can also create an address list or home inventory. This program requires 16K RAM. For the ZX81/Timex-Sinclair 1000; cassette, \$19.95. R. S. Panwar (see address above).

The Birthday Program, a program that will display the name of the birthday person, play the "Happy Birthday"

song, and display a birthday cake. Enter a secret word to blow out the candles. For the VIC-20; cassette, \$3.95. Soft 4 You, POB 3254, Reston, VA 22090.

The Math Teacher, a tutorial program using color and graphics. This program provides drill instruction in the basics of addition, subtraction, multiplication, and division. It features three levels of difficulty and displays a student's score after 25 problems are answered. For the NEC PC8001A; floppy disk, \$29.95. Computech, Department NEC-MT-BY, POB 7000-309, Redondo Beach, CA 90277.

Text Editor, Assembler, and Disassembler, a set of three programs for assembly-language programming. The text editor is a line-oriented editor; the assembler and disassembler are for 8080/Z80 files created by the editor. For the North Star Horizon; floppy disk, \$75. Polaris Software, POB 22825, San Diego, CA 92122.

Utopia, a simulation game in which you become the ruler of a country. You control the economy, food supply, and defense. But beware of the pirates, hurricanes, and rebels. For one or two players. For the Intellevision Master Component; cartridge, \$34.97. Mattel Electronics, 5150 Rosecrans Ave., Hawthorne, CA 90250. ■

This is a list of software packages that have been received by BYTE Publications during the past month. The list is correct to the best of our knowledge, but it is not meant to be a full description of the product or the forms in which the product is available. In particular, some packages may be sold for several machines or in both cassette and floppy-disk format, the product listed here is the version received by BYTE Publications.

This is an all-inclusive list that makes no comment on the quality or usefulness of the software listed. We regret that we cannot review every software package we receive. Instead, this list is meant to be a monthly acknowledgment of these packages and the companies that sent them. All software received is considered to be on loan to BYTE and is returned to the manufacturer after a set period of time. Companies sending software packages should be sure to include the list price of the packages and (where appropriate) the alternate forms in which they are available.

MICROSTAT® - Release 3.0 MICROSTAT® + baZic® = PERFORMANCE

The best just got better! MICROSTAT has been the leader in the statistics field for microcomputers since 1979, and the new release 3.0 outperforms and is noticeably faster than previous versions. Just a few of the features include:

GREATER ACCURACY

BCD with up to 14 digit precision;

PROGRAM ENHANCEMENTS

Missing data capabilities and many more;

FASTER EXECUTION

Calculation time greatly reduced;

DYNAMIC FILE ALLOCATION

Data can be inserted, added, or deleted;

SPECIAL PRICE:

For a limited time get MICROSTAT plus baZic complete with program disk and documentation for each for \$395.00, save \$50.00!



The MICROSTAT - baZic version requires: a Z80 CPU, CP/M™ and 48K of memory. Available formats: 8" SD disk or 5 1/4" North Star only. Check with your dealer for other formats. Also available for: Microsoft's Basic-80™, North Star DOS and IBM. For more information, call or write:

ECOSOFT INC.

P.O. Box 68602
Indianapolis, IN 46268-0602
(317) 255-6476

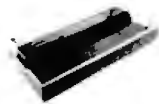

MICROSTAT is a registered trademark of ECOSOFT, INC.
baZic is a registered trademark of MICROMIKES, INC.
CP/M is a registered trademark of DIGITAL RESEARCH
Basic-80 is a registered trademark of MICROSOFT

 EPSON MX-80 \$389 MX-80 F/T \$475 MX-100 \$599	 TRS-80 MODEL III 48K \$849 48K, 2 Drives \$1599	 MODEL 16 MOD 16, 1 Dr. \$4499 MOD 16, 2 Dr. \$4799
---	--	--

<p>★ COMPUTERS</p> <p>IBM P. C. \$4399.95 320K RAM Memory, two 320K Disk Drives, DOS 1.1, Color Graphics Card, Hi-Res. BMC GreenScreen Monitor, Parallel Card, RS-232 Serial Card, Clock-Calendar, Wordstar and Visicalc.</p> <p>IBM P. C. \$2699.95 64K RAM Memory, two 320K Disk Drives and Drive Controller</p> <p>TRS-80 Model III. \$1599.00 48K, two 40 track, single side Disk Drives.</p> <p>RS-232 Serial Interface \$92.00 TRS-80 Model III 48K. \$849.00 Franklin Ace 1000. \$1377.00 64K, Fully Apple Compatible</p> <p>★ PRINTERS</p> <p>Epson MX-80 \$389 MX-80 F/T \$475 MX-100 \$599</p> <p>Okidata ML 80 \$350 ML 82A \$425 MLB3A \$699 ML 84 \$1049</p> <p>PARALLEL ML 84 \$1149</p> <p>SERIAL</p>	<p>Gemini 10. \$389 Gemini 15. \$499 Smith-Corona T.P.I. \$599.00 Serial or Parallel</p> <p>★ DISK DRIVES</p> <p>TEAC - Complete with Power Supply & Cabinet 40 Track Single Side \$239 40 Track Dual Side \$340 80 Track Single Side \$340 80 Track Dual Side \$399</p> <p>TANDON - Complete with Power Supply & Cabinet 40 Track Single Side \$239 40 Track Dual Side \$319 80 Track Single Side \$319 80 Track Dual Side \$369</p> <p>TEAC - Bare 40 Track Single Side \$199 40 Track Dual Side \$289 80 Track Single Side \$289 80 Track Dual Side \$349</p> <p>TANDON - Bare 40 Track Single Side \$199 40 Track Dual Side \$269 80 Track Single Side \$269 80 Track Dual Side \$319</p>
---	--

THESE ARE OUR CASH DISCOUNTED PRICES. U.S.D. AND CHARGE ORDERS ARE IN-PRIMER. ALL COMPUTERS ARE SHIPPED PRESENT COLLECTION. PRICES, SPECIFICATIONS AND AVAILABILITY ARE SUBJECT TO CHANGE WITHOUT NOTICE. IBM & IBM FEDERAL COMPUTERS ARE TRADEMARKS OF INTERNATIONAL BUSINESS MACHINES, INC. TRS-80 AND RADIO SHACK ARE TRADEMARKS OF TANDY CORPORATION.

918/825-4844 **Small Business COMPUTERS**
118 SO. MILL ST
PRYOR, OK 74361

12" B&W MONITOR

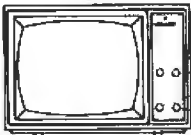

Contrast
Power/Bright
V-Hold
H-Hold

VIDEO 100 by AMDEK

FULL
FACTORY
WARRANTY **\$79⁹⁵**

for APPLE

16K RAM CARD

Language Transparent
COEX FACTORY WARRANTY **\$69⁹⁵**

5 1/4" Floppy DISKETTES

All Certified-100% Guaranteed

BOX of 100 ... **\$149⁰⁰**
Above with
Hub Rings **\$169.00**

FLOPPY DISK DRIVE

From Fourth Dimension Systems
with ● Track Zero Micro Switch
● DOS 3.2.1 & DOS 3.3
● CP/M and PASCAL

DESIGNED
FOR YOUR **\$287⁹⁵**
APPLE™
Controller Card
for above **\$99.00**

COEX 80-FT DOT MATRIX PRINTER

- Interface with Apple™, Centronics RS-232, IEEE-488
- 9x7 Dot Matrix, 80 CPS, Bi-Directional Printing
- 2K Buffered Memory
- 80, 96, 132 Columns, Graphics and Block Printing
- Selectable Char Pitch, Line Spacing and Feed

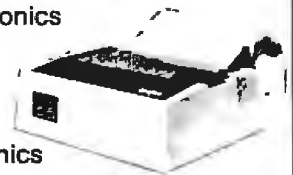

COEX Interface Card to APPLE **\$49.95**

\$349⁰⁰

VISION-80[©] \$249⁰⁰

80x24 Video Display Card
Vista Computer Company's new Vision-80 board is a sophisticated yet easy to use video display card for the Apple™ computer.

PARALLEL INTERFACE EPSON TO APPLE

New From
COEX **\$49⁹⁵** CABLE
INCLUDED

PROTOTYPING CARDS

for APPLE.... **\$19.95**
for I.B.M. **\$49.95**

EXTENDER CARDS

for APPLE... **\$16.95**
for I.B.M. **\$19.95**

"Have You Kissed Your Computer Lately?"

Components Express, Inc.

VISA® 1380 E. Edinger • Santa Ana, Calif. 92705 • 714/558-3972
Terms of Sale: Cash, Checks, Credit Cards, M.O., C.O.D. Calif. residents add 6% sales tax.



Passing Untyped Parameters in UCSD Pascal

An assembler-language function and a "trick" are combined in a parameter-passing method.

Eliakim Willner
Datronics Inc.
675 Third Ave.
New York, NY 10017

Pascal's best feature is that it is strongly typed. The programmer must declare all variable types beforehand as integers within a certain range, real numbers, characters, user-defined, and so on.

But strong typing, while desirable in most situations, can be a hindrance in others. In particular, for certain systems programming applications programmers often have to pass a variable of unspecified type as a parameter to a subroutine. A close look at the parameter-passing schemes available in Pascal shows that the language was not designed for applications requiring untyped parameters.

Because Pascal is a block-structured language, individual tasks within a program are coded as separate functions and procedures. Each module may have protected data that is not accessible from other modules. Data is passed from one module to another by means of one of two pa-

parameter-passing schemes. The most common method uses value parameters, which allows the subroutine to have its own copy of the passed parameter. This preserves the integrity of the calling routine's data.

If, on the other hand, the programmer wants the subroutine to return a different value in the parameter instead of the original one, "variable

type of variable passed from the calling routine. This applies to both parameter-passing schemes I've described, and it would seem to eliminate Pascal as an implementation language for certain systems applications.

Fortunately, however, a method exists that allows the programmer to pass a value of unspecified type as a parameter to a subroutine. Although my example is written for UCSD Pascal Version IV by Softech Microsystems, the method could be adapted easily to other versions of Pascal and other languages. I'll begin with an example of a situation in which a programmer would need to use this technique.

A method exists that allows the programmer to pass a value of an unspecified type as a parameter to a subroutine.

parameters" may be used. In this instance, the subroutine is given the address of the parameter and performs its manipulations on the original memory locations in the calling routine where the parameter is located.

In keeping with Pascal's strong type-checking features, most compilers and their run-time systems assure that the type of parameter declared in the subroutine matches the

Describing a Problem

In a well-designed piece of software, the end user is presented with a completely formatted screen that resembles a blank form, with entry headings and space for the entries. As you make entries, your data is checked for validity. Detailed error messages immediately notify you of your mistakes, and you're given time to correct them.

Constructing this sort of end-user interface takes a significant amount

About the Author

Eliakim Willner is a data-processing consultant specializing in mini- and microcomputer systems. He teaches data processing at Kingsborough Community College of the City University of New York.

of programming time, and the resulting code constitutes a major portion of the program. A general-purpose utility that enables the application programmer to set up screens and specify valid entries with ease is a valuable tool.

Such a utility has two sections. The first is a stand-alone program that lets the application programmer format each screen. The second section consists of a set of subroutines to be linked to the application program. As soon as the screen is formatted, it is stored as a data file to be used by the subroutines. The subroutines access the data file to set up the screen and guide you through the process of entering the data, performing validity checks, and so on.

To perform validity checks the routines must know which values are acceptable for each entry on the screen. Typically, the utility provides a number of predefined types—a dollars-and-cents type or a date type, for example. The application programmer specifies the type for each entry when the screen is originally set up. Because this information becomes part of the data file for that screen, it is accessible to the utility subroutines.

After the utility subroutines perform their tasks, the validated data is returned to the application program for the necessary processing. The application programmer must specify which variables are to be passed the entered data when the utility subroutines are invoked. Normally this is easily accomplished by writing something like GETSCREEN (VARIABLE1, VARIABLE2, . . .). Here GETSCREEN is a utility subroutine and the VARIABLEn (variables) in the application program are passed the data. In our present discussion, however, GETSCREEN is a subroutine in a general-purpose utility.

In one application the data passed back in VARIABLE1 might be an integer, so VARIABLE1 would be declared an integer. But in another application using the utility, VARIABLE1 might accept data of the character type, and it would be declared as such.

Although the utility subroutines know from the data file what kinds of

TeleVideo® Users!

NOW 92 WORDSTAR® COMMANDS

The TV2000 is Designed for the
925,950, Intelligent I and 800
Through 816 Computers

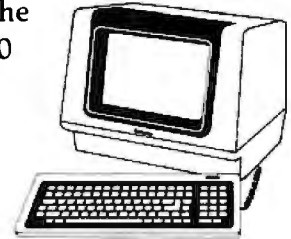

Features:

- 46 single key stroke commands
- 41 shifted commands
- 5 MailMerge commands
- Faster cursor and keyboarding
- User-oriented command selection & location
- Soft switch activates the enhancement with no loss of TeleVideo attributes.

Includes:

46 replacement key caps
Replacement ROM

**SUGGESTED RETAIL
PRICE \$220**

Custom keyboard layout
available for special codes
or formats

WordTechSystems

953 Mountain View Dr. Suite 114
Lafayette, California 94549
(415) 254-7747

Trademark Wordstar® MicroPro International—TeleVideo® TeleVideo Systems, Inc.
MailMerge® MicroPro International

COMPUTER GEAR—WHOLESALE!

Purchase your Hardware and Software directly from an OEM/Systems Integrator. Take advantage of our buying power! We stock a full line of Board Level Components, Software, and Peripherals for all the Popular Machines in use today. These include S-100, GODBOUT, MORROW, APPLE, IBM PC, TRS80, OSBORNE, HP, NORTHSTAR, SUPERBRAIN, NEC, Z/H-89, XEROX, and many others. Call for your needs. We'll give you the Lowest Prices, and the Technical Support and Know-How we are quickly becoming well-known for. Satisfied Customers Nationwide! The Nation's Custom Systems House for Business, Education, Science

SOME OF OUR CURRENT SPECIALS:

MICROSOFT MBASIC 80 \$199 • ASHTON-TATE dBASE II \$459 • SYSTEMS PLUS FMS81 \$299
MICROPRO: WORDSTAR \$259, SPELLSTAR \$159, MAILMERGE \$99, PACKAGE-ALL THREE \$489

COMPUPRO	
Z-80 CPU	\$219
8085/88	\$319
DISK 1	\$359
DISK 2	\$599
RAM 16	\$439
RAM 17	\$399
INTERF 1	\$189
SYS B16A	\$4495
INTERF 2	\$189
INTERF 3	\$445
INTERF 4	\$269
ENCLOS 2	\$669
CP/M 2.2	\$149
CP/M 86	\$269
MP/M 816	\$769
B:	\$5675

AMD SIN.BD.COMP.	\$675
VIO-X2 VIDEO BD	\$319
SO SYS VDB-8024	\$459
IBM PC/2DR/MON	\$3749
SSM VB2 VIDEO	\$199
PERTEC 5 1/4" DSDD	\$125
MORROW MULTI/O	\$279

MORROW DESIGNS	
NEW! MICRODECISION COMPLETE COMPUTER (INCLUDES CP/M, WORDSTAR, MBASIC, DISK)	
1 DRIVE \$945	2 DRIVES \$1219
NEW 12" GREEN TERMINAL \$499	
DJDMA WCP/M \$439	DJ2D WCP/M \$349
65K RAM \$429	MULTI I/O \$299
HARD DISK SUBSYSTEMS, DRIVES—CALL	
DECISION 1 MICROCOMPUTER—CALL	

SSM VB3A \$399 QUICKCODE \$219 QUICKSCREEN \$129 SUPERCALC \$225
TELEVIDEO TERMINAL SALE: 925 - \$749 SANYO 12" GR(HI RES) \$209 AMDEK 300G \$159
LIMITED SPECIAL: USI 12" AMBER MONITOR-20MHZ (SHARPER THAN SANYO) \$199

WE ARE THE LARGEST IN THE CUSTOM CONFIGURATION OF COMPLETE STATE-OF-THE-ART S-100 SYSTEMS, AT PACKAGE PRICING, WITH INTEGRATION, BURN-IN, & PROGRAMMING.

New: CCT Disk Drive Subsystems. Industrial quality 5 1/4", 8", floppy and/or hard disk custom configurations. Strictly the highest quality. ONE 5 1/4" APPLE/IBM: \$299 DUAL 8" SSDD: \$799 DUAL 8" DSDD: \$1199
NO SUPER SPECIAL: 8" DUME/5MEG SHUGART: \$1550—W/DMA CONT&CP/M: \$1999

Announcing the CCT SUPER SUPPLY: +8V@ 8 to 3DA; ±16V to 3A+; +24 V to 10A+; +12V@ 2A+; -5V@ 2A+
A well-engineered, compact supply plugable to handle virtually any Mainframe/Floppy/Hard disk combo. Call us.

WE HAVE A LARGE STOCK OF IBM PC SOFTWARE. SPECIAL: MICROSOFT IBM PC 64K RAMCARD — \$299!
Micropro—Microsoft—dBase 11—Spellguard—Supercalc Call for any CP/M Software—We stock all formats, at big discount!

WOW! SPECIALS \$5 GOOD THROUGH MONTH END. As supplies last. Rainchecks may be given if possible. Cash Sales Only!

CUSTOM COMPUTER TECHNOLOGY

1 CRAFTSMAN COURT, BOX 4160, SEDONA, ARIZONA, 86340 (602) 282-6299
PRICES & AVAILABILITY SUBJECT TO CHANGE. ALL PRODUCTS NEW, AND CARRY FULL MANUFACTURER'S WARRANTIES
CALL FOR CATALOG. FREE TECHNICAL HELP TO ANYONE. WE CAN CONFIGURE BOARDS & SOFTWARE FOR YOUR SYSTEM.
PLUG-IN & GO. AZ RESIDENTS ADD APPLICABLE SALES TAX. CP/M.TM. DIGITAL RESEARCH

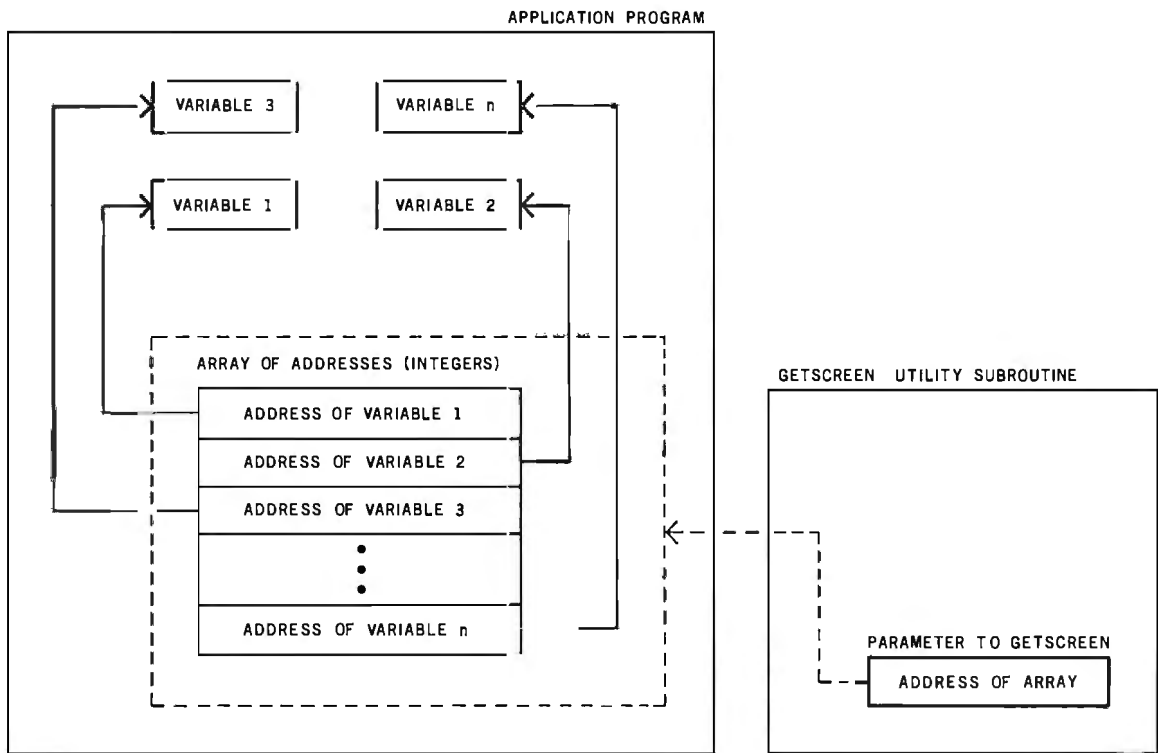

Figure 1: Construction of an array in the application program containing the addresses-as-integers of each variable that will receive a value entered onto a screen. The array is passed as a variable parameter to GETSCREEN. GETSCREEN will input and validate the screen entries and then return the values to the variables of the application program using the addresses specified in the array.

values each application needs for the VARIABLE_n, the parameters corresponding to the VARIABLE_n must be declared. As stated earlier, in Pascal the type of parameter declared in the subroutine must match the type of the corresponding variable in the calling routine. But in this case the author of the utility does not know the type of any of the variables passed from the application. In other words, the programmer needs to pass a value of unspecified type to a subroutine.

Identifying a Solution

To solve this problem, we will use a method adapted from a technique commonly found in assembler-language programs. This technique is similar to Pascal's variable parameter scheme in that the subroutine does not receive its own copy of a piece of data but instead is given its actual address.

The programmer writes the GETSCREEN routine so that it has only one parameter, an array of integers. Each integer in the array represents the address in memory of one

VARIABLE_n that will receive a value input to the screen. The array will have as many integers as the screen has data items. (See figure 1.)

GETSCREEN uses these integer/addresses as though they were variable parameters: it stores each data item entered and verified into the ad-

It is not difficult to write an ADDR function and make it part of the language.

dress specified by the appropriate integer in the array. Note that both the application program and the utility subroutine must explicitly manipulate addresses, while when variable parameters are employed the manipulation and passing of addresses is transparent to the programmer.

Two important questions remain: How does the application program discover the addresses of the VARI-

ABLE_n to be placed in the array? and How does the utility subroutine use these addresses—which are really just integers—to pass values back to the VARIABLE_n?

Adding a Function

In many languages, discovering the address of a variable is a relatively straightforward procedure. In PL/I, for example, the function ADDR (VARIABLE1) returns the address of VARIABLE1. Pascal does not contain an ADDR function, but writing one is easy, and making it a part of the language is simply a matter of including it in the system library.

The application programmer must write the function in the assembler language of the local processor to find the address of *any* variable, regardless of type. A Pascal subroutine will not permit this, but UCSD Pascal does allow assembler-language subroutines to be written with untyped parameters. The ADDR function shown in listing 1 is written in PDP-11 assembler language but can be adapted easily to any assembler

An ADDR Function for Pascal

The following directions will guide you through creating the ADDR function, including it in the system library, and using it in a program.

1. Using the system editor, create a text file containing your version of ADDR.
2. Make sure that the .OPCODES and .ERRORS files for your assembler are on the system disk. Invoke the assembler by typing "a" at the outer-operating-system level. Respond appropriately to the prompts for text, code, and listing file names.
3. Invoke the library utility by typing "x" at the outer-operating-system level and responding to the prompt with "library" (library.code must be on your system disk). You will be asked to supply an output file name. Type any name ending in ".code" that doesn't already exist on your disk, such as "new.code." When you are prompted for an input file name, type "system.library." Then type "e" to copy all of the segments of your old library to what will become your new

library. Type "n," then type the name of the code file containing your assembled ADDR function. Type "e" and then "q" to exit the library. Respond to the "notice" prompt by pressing Return.

4. Invoke the filer and "c" (change) the name of the system.library to old.library, and of new.code (or whatever you called it) to system.library. If the new system.library works as it should, you can remove the old.library.
5. Write the program that will use the ADDR function. Declare it as follows among the function declarations before you declare any function or procedure that uses it:

```
FUNCTION ADDR (VAR  
  ANYTHING) : INTEGER;  
  EXTERNAL;
```

6. Use the "r" (Run) command at the outer-operating-system level to compile, link, and execute your program. The next time you want to execute your program, type "x" and then the name of the ".code" file created by the linker.

its value, it simply pops the return address and saves it, pops the address of the parameter and holds it momentarily, and pops the "junk" and discards it. Then it replaces the address of the parameter on top of the stack as the returned value and branches back to the calling routine.

The ADDR function must be declared an external routine in the application program. To use the function, the application programmer declares an array of integers whose size is the maximum number of entries permitted for a screen. The number of entries for a particular screen may be stored in that screen's data file or passed as an additional parameter to GETSCREEN. Before GETSCREEN is invoked, the ADDR function is applied to each variable that will hold a validated screen value (the VARIABLE_n), and the resulting integer-form addresses are assigned to successive elements of the array (see listing 2).

Using a Trick

As soon as the utility subroutine receives the array of addresses, it must be able to use them to store the entered and validated data items in the appropriate places. The problem is that in Pascal and most other languages, the closest you can come to touching addresses is via pointers. And although pointers are really just addresses and addresses are really just integers, Pascal does not allow the pointers and addresses to mix. To sidestep this restriction you must employ one of Pascal's more infamous tricks—using a variant record to define the same storage location as both an integer and a pointer (see listing 3).

A variant record is required for each possible data type that the VARIABLE_n of the application program may assume. Listing 3 contains variant records for the integer and character types called INT__POINTER and CHAR__POINTER. These variant records contain no tag field; the "CASE INTEGER OF 1: . . i. 2: . . ." is a device to enable the utility subroutines to refer to each variant record under two aliases.

When, for example, the alias

Listing 1: The PDP-11 version of the assembler-language ADDR function. The reader should become familiar with the UCSD Adaptable Assembler (see the UCSD Pascal Users Manual) before attempting to adapt ADDR to other processors.

```
.func    addr,l  
;  
;this function returns as its value  
;the address of its single parameter  
;  
mov      (sp) + ,return    ;pop the return address and save it.  
mov      (sp) + ,address    ;address of parameter. pop and save.  
tst      (sp) +            ;pop the junk.  
mov      address, -(sp)    ;return addr of param to top of stack.  
jmp      @return          ;depart to calling routine.  
  
return    .word  
address    .word  
end
```

language supported by the UCSD system. (Complete instructions to assemble ADDR and include it in the system library are given in the text box.)

The routine itself is quite simple. When a function with variable parameters is invoked in the UCSD system, the interpreter pushes one word of what is for our purposes "junk"

onto the system stack, pushes the addresses of the variable parameter(s), and pushes the return address. After the function returns, the interpreter expects to find these elements removed from the stack and the value of the function on top of the stack.

Because our ADDR function returns the address of its parameter as

TELEVIDEO DEALERS & DIST.

Our general accounting programs operate on CP/M¹ & MP/M² compatible systems, including TurboDos³ and MMMost⁴.

1. **C.A.T.S.** (3 levels of User help – Computer Assisted Tutorial Software.
2. **OUTSTANDING DOCUMENTATION.**
3. **MULTI-USER** (w/file & record lock.)
4. **MULTI-COMPANY** (w/consolidation)
5. **FULLY INTEGRATED** w/single source entry (or stand alone)

MONEY BACK GUARANTEE

COUGAR MOUNTAIN SOFTWARE
10 S. Latah Box 6886
Boise, Idaho 83707
208-344-2540

TM: 1. & 2. Digital Research; 3. Software 2000;
4. TeleVideo.

Future Shock!

age **65**
years worked **40**
retirement benefits **0**

The U.S. Department of Labor has a free booklet that will help you answer these questions and a lot more. Send for it today.

Write: Pensions, Consumer Information Center, Pueblo, Colorado 81009

U.S. Department of Labor

Bill Cosby
says:
“When you
learn CPR,
you’re
ready to
save lives—
anywhere.” •



Listing 2: Skeleton application program illustrating how the table of addresses is declared, filled, and sent to the utility subroutine.

```
PROGRAM APPLICATION_SKELETON;

CONST
    MAX_ENTRIES_PER_SCREEN = 100;           {OR WHATEVER}

TYPE
    TABLE_TYPE = ARRAY [1..MAX_ENTRIES_PER_SCREEN] OF INTEGER;

VAR
    TABLE_OF_ADDRESSES : TABLE_TYPE;
    VARIABLE1            : CHAR;           {FOR EXAMPLE}
    VARIABLE2            : {WHATEVER THEY MAY BE}
    .
    .
    .

FUNCTION ADDR (VAR ANYTHING) : INTEGER; EXTERNAL;

BEGIN
    .
    .
    .
    TABLE_OF_ADDRESSES[1] := ADDR (VARIABLE1);
    TABLE_OF_ADDRESSES[2] := ADDR (VARIABLE2);
    .
    .
    .
    GETSCREEN (TABLE_OF_ADDRESSES);
    .
    .
    .
END.
```

Listing 3: Skeleton utility subroutine illustrating how the table of addresses is used to send validated values back to the application program.

```
PROCEDURE GETSCREEN_SKELETON;

TYPE
    INT_POINTER = RECORD
        CASE INTEGER OF
            1 : (POINTER_AS_INTEGER : INTEGER);
            2 : (POINTER              : ^INTEGER)
        END;

    CHAR_POINTER = RECORD
        CASE INTEGER OF
            1 : (POINTER_AS_INTEGER : INTEGER);
            2 : (POINTER              : ^CHAR)
        END;

VAR
    INT           : INT_POINTER;
    CHARACTER    : CHAR_POINTER;
    CH            : CHAR;

BEGIN
```

Listing 3 continued:

```
{FOR THE PURPOSE OF THIS EXAMPLE ASSUME THAT GETSCREEN HAS  
ALREADY DETERMINED THAT THE FIRST SCREEN ITEM IS OF TYPE CHAR AND  
HAS BEEN INPUT TO THE LOCAL VARIABLE CH.}
```

```
.  
.  
CHARACTER.POINTER_AS_INTEGER := TABLE_OF_ADDRESSES[1].
```

```
{THE POINTER TO CHARACTER IN ITS INTEGER GUISE IS SET EQUAL TO THE  
ADDRESS OF VARIABLE1 IN ITS INTEGER GUISE.}
```

```
CHARACTER.POINTER1 := CH;
```

```
{VOILA! VARIABLE1 IN THE APPLICATION NOW CONTAINS THE FIRST  
SCREEN VALUE.}
```

```
.  
.  
END.
```

CHARACTER.POINTER_AS_INTEGER is used, CHARACTER.POINTER may be manipulated as any integer. The utility, knowing that a particular address in the array of integer/addresses passed to it by the application program belongs to a variable of type character, may take that

integer/address and assign it to CHARACTER.POINTER_AS_INTEGER.

Once that happens, any reference to CHARACTER.POINTER1 is a reference to a character variable in the application program. Thus, as soon as the utility subroutine GETSCREEN

has accepted and validated an input of type character, it only has to assign it to CHARACTER.POINTER1 and the data will be transported back to the application.

Because the utility knows from the data file what type variable each screen entry must be assigned to, it can take the corresponding address from the array and move it into the appropriate variant record. When the value itself is assigned to the pointed-to location, it lands exactly where the application expects to find it.

A parameter or parameters of unspecified type may be passed to a subroutine in Pascal. Purists may object to such tricks and pragmatists may point to other languages where machinations like these are unnecessary. But in defense of Pascal, few languages provide such a rich and balanced variety of features. To the credit of its designer and its implementers at UCSD, Pascal is flexible enough to accommodate situations for which it was not originally intended. ■

BUILD YOUR COMPUTER BREADBOARDS & INTERFACES FASTER AND EASIER WITH NEW VECTOR PLUGBOARDS

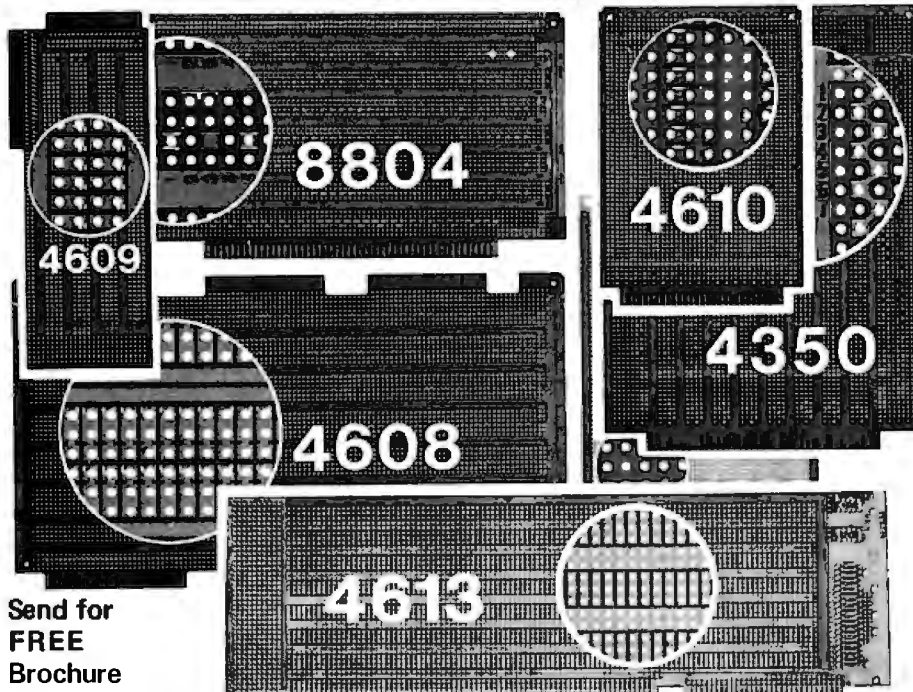

New 4613 series – for IBM Personal Computer. Three models available.

New 4614, 4615 series – for VME Bus. Six models available.

4610 series – for STD-Bus. Three models available.

4608 series – for Multibus solderable, or unpatterned.

8804 series – for S-100. Seven models available.

4607 – for DEC LSI-11/PDP8-11, Heath-11.

4609 – for Apple II, Super-Kim, Pet Commodore with Expandamem.

4350 – for TI 980

4611 series – for Motorola Exorciser

Send for
FREE
Brochure



ALSO: Connectors • Enclosures • Mother Boards • Extenders 748209
VECTOR ELECTRONIC COMPANY, Inc., 12460 Gladstone Ave., P.O. Box 4336, Sylmar, CA 91342-0336; (213) 365-9661

A Terminal Program for the TRS-80 Model III

A world of information is just a phone call away.

Ralph L. James
Department of Mathematics
California State College
Turlock, CA 95380

Imagine having these resources available to your TRS-80 Model III: general-use databases such as The Source and CompuServe, research-oriented databases such as Dialog, specialized databases covering practically any subject, and electronic bulletin boards for any interest. If the prospect appeals to you, all you need to do is transform your Model III into a "smart" terminal. Your telephone will do the rest.

Before attempting the conversion, you'll need two things. First, you must have a serial port (e.g., an RS-232C board) so that your Model III can communicate via a modem over the telephone lines. Of course, you'll also need a program that enables the computer to perform as a terminal. I wrote such a program for my TRS-80 Model III and have used it successfully over the past few months.

Several features of the TRS-80 Model III make it attractive for use as a terminal. First, its Control key (shift down-arrow) lets you enter control characters from the keyboard. On most larger computers, these characters control the operating system. For example, you might use Control-C to terminate program execution. A second important feature of the Model III is an (optional) RS-232C serial-interface board. I particularly like a couple of other features, such as the lowercase characters and the single-unit design of

the Model III that incorporates the video display, keyboard, and disk drives. The only disadvantage of the Model III is that its screen has 64 columns instead of the usual 80. But for my work, at least, that hasn't been a serious drawback.

I wrote the terminal program in Z80 assembly language, which operates at 300 bits per second (bps), the most frequently used speed for remote terminals that communicate over the telephone line (chances are it would work satisfactorily at higher transmission rates, but that hasn't been tested). Note that the program is written only for the TRS-80 Model III and will not run on a Model I.

The program requires one or two disk drives and a minimum of 32K bytes of RAM (random-access read/write memory). The terminal program supports disk operations. For example, you can store a program on one of your disks and then either send it to the remote computer or store the output from the remote computer on a disk. If you have no disk drives and only 16K bytes of RAM, you can still use the program by simply eliminating the disk-related section (I will explain this in detail later).

If you want listings or hard copy of output from the remote computer, you can use a parallel printer. Again, the program will work even if you don't have a printer. You can either

eliminate the printer-related sections of the program or disregard the printer-related commands.

I designed the terminal program (see listing 1) to access a PDP-11/45 minicomputer with version 7.0 of the RSTS/E operating system. A different operating system or computer may call for some changes to the program. I tried to make it as flexible and universal as possible so that no major changes should be necessary.

You may want to custom design the program to suit your particular needs. That way, you can incorporate the features you need and eliminate those you don't. (Hereafter, I will use "computer" to refer to the remote computer and "Model III" to refer to the TRS-80 Model III to avoid confusion between the two.)

Initializing the RS-232C Interface

The main section of the program, which allows the Model III to communicate with the computer (without printer or disk capability), is very simple. (See figure 1 for an illustration of its operation.) First, the RS-232C interface is initialized. A "don't wait" condition is necessary, so in line 480 of the program a 0 is loaded into location 16890. In line 500, all the bits in location 16889 are set to 1 by calling RSINIT (I needed an 8-bit word length with 1 stop bit and no parity; the eighth bit is ignored. Call your computer center or system

Listing 1: Model III terminal program. This listing contains all options for use with a printer and disk drives.

SOURCE LISTING FOR TERMINAL PROGRAM

```

00100      ORG          5400H
00110      ;***** MAIN PROGRAM CONSTANTS *****
00120      DUPLEX EQU 5200H      ;DUPLEX FLAG
00130      KBCHAR EQU 002BH     ;KEYBOARD SCAN
00140      VDCLS EQU 01C9H     ;CLS
00150      VDCHAR EQU 0033H    ;VIDEO DISPLAY
00160      RSINIT EQU 005AH    ;INITIALIZE RS232
00170      RSRV EQU 0050H     ;RS232 RECEIVE
00180      RSTX EQU 0055H     ;RS232 XMT
00190      CHAR EQU 5202H     ;CHAR STORAGE
00200      RCVBYT EQU 16872    ;RCV LOCATION RS232
00210      CURSOR EQU 143      ;CURSOR CHARACTER
00220      CURLOC EQU 4020H    ;CURSOR ADDRESS
00230      ;***** BUFFER CONSTANTS *****
00240      PRCHAR EQU 003BH    ;LINE PRINTER ROUTINE
00250      BUFLAG EQU 5201H    ;BUFFER FLAG
00260      BUFPTR EQU 5203H    ;BUFFER POINTER
00270      BUFNUM EQU 5205H    ;BUFFER COUNT
00280      BUFBEQ EQU 5800H    ;FIRST BUFFER LOC
00290      ;***** DISK CONSTANTS *****
00300      XMTBYT EQU 41F0H    ;RSTX BUFFER
00310      DOS EQU 402DH      ;TRSDOS
00320      DCB EQU 5207H     ;DCB FOR A DISK FILE
00330      ERNL EQU 5213H    ;LSB OF ERN
00340      ERNM EQU 5214H    ;MSB OF ERN
00350      EOF EQU 520FH     ;# BYTES IN LAST RECORD
00360      CTRD EQU 5239H    ;RECORD COUNTER
00370      BUFFER EQU 523BH   ;1ST ADDR OF DISK BUFFER
00380      READ EQU 4436H    ;READ RECORD FROM DISK
00390      CLOSE EQU 442BH   ;CLOSE FILE
00400      OPEN EQU 4424H    ;OPEN FILE
00410      INIT EQU 4420H    ;OPENS NEW FILE
00420      WRITE EQU 4439H   ;WRITE RECORD TO DISK
00430      TEMPST EQU 533BH  ;TEMP STORAGE FOR SCREEN
00440      LINE DEFM 'Enter Filename' ;PROMPT
00450      ;*****
00460      CALL VDCLS      ;CLS
00470      XOR A          ;ZERO A REGISTER
00480      LD (16890),A    ;NO WAIT CONDITION
00490      LD A,255        ;SET UP RS232
00500      LD (16889),A   ;INITIALIZE RS232
00510      CALL RSINIT    ;INITIALIZE RS232
00520      XOR A          ;ZERO A
00530      LD (BUFLAG),A  ;BUFFER CLOSED
00540      LD (DUPLEX),A  ;HALF DUPLEX
00550      CALL BUFSET    ;INITIALIZE BUFFER
00560      RCV          ;CHECK RS232 RECEIVE
00570      LD A,(RCVBYT)  ;PUT CHAR IN A
00580      JR Z,KEYBD    ;IF NO CHAR, GO
00590      CP 10         ;LINE FEED?
00600      JR Z,RCV      ;IF SO IGNORE IT
00610      LD (CHAR),A   ;SAVE CHAR
00620      CALL VIDEO    ;PRINT CHARACTER
00630      LD A,(BUFLAG) ;BUFFER STATUS
00640      CP 0          ;BUFFER CLOSED?
00650      JR Z,KEYBD    ;IF SO GO
00660      CALL BUFPUT    ;PUT CHAR IN BUFFER
00670      KEYBD        ;CHECK KEYBOARD
00680      JR Z,RCV      ;GO CHECK RS232 IF NO CHAR
00690      LD (CHAR),A  ;SAVE CHAR
00700      CP 2          ;TURN BUFFER ON?
00710      JP Z,BUFON    ;IF SO, GO DO IT
00720      CP 15         ;TURN BUFFER OFF?
00730      JP Z,BUFOFF  ;IF SO, GO DO IT
00740      CP 5          ;ERASE BUFFER?
00750      JP Z,BUFER    ;IF SO, GO DO IT
00760      CP 16         ;PRINT BUFFER?
00770      JP Z,BUFPR    ;IF SO, GO DO IT
00780      CP 1          ;BREAK KEY?
00790      JP Z,DOS      ;IF SO, RETURN TO DOS
00800      CP 18         ;CTRL/R
00810      JR NZ,SET1    ;IF NOT, GO
00820      PUSH AF        ;SAVE A

```

Listing 1 continued on page 460

Apple® Business Software:
ACCOUNTING PLUS II®
from \$329



Now, pay less
and get great
service, too!

Finest, easiest-to-use accounting system for Apple/Franklin Computers. Now at a special *Introductory Discount Price*. Uses 6502 machine language. Comes with its own firmware card. Upgradable and fully integrated. Price includes our complete customer support package. Call Toll Free (800) 327-7701. In Fla., collect: (305) 757-5416.



Software Management Group, Inc.
12555 Biscayne Boulevard, Suite 805
Dept. BY, Miami, Florida 33181

*Apple and Accounting Plus II are trademarks of Apple Computer, Inc. and Software Dimensions, Inc., respectively.

Circle 473 on Inquiry card.

COMPUTERS

- FRANKLIN ACE 1000\$939
- SYSCOM\$699
- IBM/PC\$2795
(64K—2 DISK DRIVES—COLOR BOARD)
- COLUMBIA MPC
(IBM CLONE—128K).....\$2950
- ALTOS—EAGLE—ATARI—OSBORN

PRINTERS

- NEC 3550 (FOR IBM PC).....\$1995
- NEC 3510 (EX)\$1475
- NEC 3515 (EX)\$1499
- IDS MICROPRISM\$579
- C. ITOH PRINTMASTER\$1695
- OKIDATA 82A\$429

Send for FREE Brochure of our Complete Line of Monitors, Terminals and more.

**COMPUTERS
and more**

2420 University Ave., Suite 3, San Diego, Ca. 92104
(619) 291-1442, Telex 697120, Datamax Attn: Dept. 322

Circle 474 on Inquiry card.

DON'T READ THIS

UNLESS YOU ARE INTERESTED IN SOPHISTICATED SOFTWARE WITH EXCELLENT DOCUMENTATION.

Our general accounting programs operate on CP/M¹ & MP/M² compatible systems, including TurboDos³ and MMMost⁴.

1. C.A.T.S. (3 levels of User help — Computer Assisted Tutorial Software).
2. OUTSTANDING DOCUMENTATION.
3. MULTI-USER (w/file & record lock).
4. MULTI-COMPANY (w/consolidation)
5. FULLY INTEGRATED w/single source entry (or stand alone)

DEALER INQUIRIES INVITED
MONEY BACK GUARANTEE
COUGAR MOUNTAIN SOFTWARE
10 S. Latah Box 6886
Boise, Idaho 83707
208-344-2540

TM: 1. & 2. Digital Research; 3. Software 2000; 4. TeleVideo.



SCORE HIGHER ON THE SAT USING THIS 5 1/4 INCH DISKETTE ON THE APPLE COMPUTER. DRILLS ON MATH, READING, GRAMMAR, STANDARD WRITTEN ENGLISH, ANTONYMS, AND ANALOGY. EXPLAINS RIGHT AND WRONG ANSWERS.

SAT.....\$33.95

HIGH SCHOOL ENTRANCE EXAMS..\$25.00

DELIVERY IN 3-5 DAYS.

SEND MONEY ORDER TO OR CALL :

FINER PROGRAMMING SERVICE

7310 PARKDALE AVENUE

CINCINNATI, OHIO 45237

(513) 761-0380

Circle 463 on inquiry card.

Like-new products



For free catalog, phone toll-free (800) 225-1008 in Massachusetts (617) 938-0900

Genstar REI Sales Company

6307 DeSoto Ave., Ste. J / Woodland Hills, CA 91367

Circle 464 on inquiry card.

micro-PROLOG

the fifth generation language for micros

- *μ*-PROLOG is an interactive version of PROLOG currently available for CP/M 2.xx Z80's.
- PROLOG is the Artificial Intelligence language chosen by Japan as the core language for their Fifth Generation Computers.
- PROLOG grew out of AI research in computational logic. PROLOG means PROgramming in LOGic.
- A PROLOG program comprises a set of facts and rules. It unifies:
 - relational data and relational queries,
 - recursive list processing,
 - pattern directed rule based programming, within a single framework of logic programming.
- Current applications: Expert Systems, Natural Language Understanding, Intelligent Data Bases.

Distribution Formats

5": North Star, Zenith Z89, IBM PC (with Z80 card)
Apple II (Z80 card, lower case reqd), Osborne
8": S55D IBM 3740

Need more info?

Sample the language with the 160 page Primer. Price can be set against software.

Prices

Software (with Z75 Manual & Primer) \$15
Primer \$15
Prices include air P&P

LOGIC PROGRAMMING ASSOCIATES Ltd.
10 BURTWOOD CLOSE,
LONDON SW18, ENGLAND

CPM TM Digital Research Inc., Z80 TM Zilog Corporation,
micro-PROLOG & *μ*-PROLOG TM LPA Ltd

Circle 465 on inquiry card.

Listing 1 continued:

```

00830 JP DISKRD ;GO READ FILE
00840 CP 6 ;CTRL/F ?
SET1 JR NZ,SET2 ;IF NOT, GO
00850 JR NZ,SET2 ;SAVE A
00860 PUSH AF ;GO READ FILE AND SEND
00870 JP DISKRD ;CTRL/G ?
00880 SET2 CP 7 ;GO XMT BUFFER TO COMPUTER
00890 JP Z,BUFXTM ;CTRL/J ?
00900 CP 10 ;IF SO, CONTINUE SENDING
00910 JP Z,PAU2 ;CTRL/W ?
00920 CP 23 ;WRITE BUFFER TO DISK
00930 JP Z,DISKSV ;CTRL/D ?
00940 CP 4 ;IF NOT, GO
00950 JR NZ,SET ;GET DUPLEX FLAG
00960 LD A,(DUPLEX) ;TOGGLE FLAG
00970 XOR 1 ;SAVE FLAG
00980 LD (DUPLEX),A ;RCV FLAG
00990 JP RCV ;CARRIAGE RETURN ?
01000 SET CP 13 ;IF SO, SEND IT
01010 JR Z,XMT ;DUPLEX FLAG
01020 LD A,(DUPLEX) ;HALF DUPLEX?
01030 CP 0 ;IF FULL DUPLES, DON'T PRINT
01040 JR NZ,XMT
01050 CALL VIDEO
01060 XMT LD A,(CHAR) ;RESTORE CHAR TO A
01070 CALL RSTX ;XMT CHARACTER
01080 JP RCV ;START OVER
01090 ;***** VIDEO - PRINTS CHAR ON VIDEO *****
01100 VIDEO LD A,(CHAR) ;GET CHAR
01110 PUSH HL ;SAVE HL
01120 CP 13 ;CARRIAGE RETURN
01130 JR Z,CURS2 ;IF SO, GO
01140 CP 8 ;BACKSPACE ?
01150 JR NZ,CURS ;IF NOT, GO
01160 CURS2 LD HL,(CURLOC) ;CURSOR LOCATION
01170 LD A,32 ;BLANK
01180 LD (HL),32 ;BLANKS PREVIOUS CURSOR
01190 LD A,(CHAR) ;RESTORE CHAR TO A
01200 CURS CALL VDCHAR ;PRINT CHAR
01210 LD HL,(CURLOC) ;GET CURSOR LOCATION
01220 LD A,CURS2 ;CURSOR HAR
01230 LD (HL),A ;PRINT CURSOR
01240 LD A,(CHAR) ;RESTORE CHAR TO A
01250 POP HL ;RESTORE HL
01260 RET
01270 ;***** BUFON - TURNS BUFFER ON *****
01280 BUFON LD A,1
01290 LD (BUFLAG),A ;BUFFER OPEN
01300 JP RCV ;GO BACK
01310 ;***** BUFOFF - TURNS BUFFER OFF *****
01320 BUFOFF XOR A
01330 LD (BUFLAG),A ;BUFFER CLOSED
01340 JP RCV ;GO BACK
01350 ;***** BUFR - DUMPS FROM BUFFER TO PRINTER *****
01360 BUFR LD HL,(BUFNUM) ;NUMBER OF CHARS IN BUFR
01370 LD A,H ;GET MS COUNT
01380 OR L ;MERGE LS
01390 JR NZ,LOP1 ;BUFFER EMPTY, GO BACK
01400 JP RCV
01410 LOP1 LD DE,BUFBEG ;FIRST BUFFER CHAR
01420 PTLOOP LD A,(DE) ;CHAR TO PRINT
01430 PUSH DE
01440 CALL PRCHAR ;PRINT IT
01450 CALL KBCHAR ;CHECK KEYBOARD
01460 POP DE
01470 CP 3 ;CTRL C?
01480 JR NZ,LOP
01490 JP RCV ;STOP PRINT, GO BACK
01500 LOP INC DE ;PT TO NEXT CHAR
01510 DEC HL ;NUMBER OF CHARS REMAINING
01520 LD A,H ;GET MS COUNT
01530 OR L ;MERGE LS COUNT
01540 JR NZ,PTLOOP ;GO IF COUNT NOT ZERO
01550 JP RCV ;DONE
01560 ;***** BUFR - ERASES BUFFER *****
01570 BUFR CALL BUFRSET ;ERASES BUFFER
01580 JP RCV ;DONE
01590 BUFRSET LD HL,0
01600 LD (BUFNUM),HL ;NUMBER OF CHARS SET TO 0
01610 LD HL,BUFBEG
01620 LD (BUFPTR),HL ;INITIALIZE BUFR POINTER
01630 RET
01640 ;***** BUFR - PUTS CHAR INTO BUFFER *****
01650 BUFR LD HL,(BUFPTR) ;NEXT POSITION
01660 LD A,(CHAR) ;GET CHAR
01670 LD (HL),A ;PUT CHAR IN BUFFER
01680 INC BUFPTR ;INC BUFR PTR
01690 LD HL,(BUFPTR),HL ;STORE IT
01700 LD HL,(BUFNUM) ;OLD NUMBER OF CHARS

```

Listing 1 continued:

```

01710      INC      HL          ;ADD 1
01720      LD       (BUFNUM),HL ;STORE IT
01730      RET
01740 ;***** DISKRD --READ A FILE FROM DISK *****
01750 DISKRD CALL    FILNAM      ;SETS UP DCB
01760      LD       B,0          ;LRL SET TO 256
01770      LD       DE,DCB       ;1ST ADDR OF DCB
01780      LD       HL,BUFFER    ;1ST ADDR OF DISK BUFFER
01790      CALL    OPEN         ;OPENS SPECIFIED FILE
01800      CALL    RESTOR       ;RESTORE SCREEN
01810      LD       A,(ERNM)     ;MSB OF ERN
01820      LD       H,A         ;MSB OF ERN IN H
01830      LD       A,(ERNL)     ;LSB OF ERN
01840      LD       L,A         ;LSB OF ERN IN L
01850      LD       (CTRD),HL   ;# OF RECORDS TO READ
01860      DEC      A           ;LSB-1 OF ERN
01870      OR       H           ;ERN = 1 ?
01880      JR       Z,RDR3      ;IF SO, GO
01890 RDR3  LD       DE,DCB     ;GETTING READY TO READ
01900      CALL    READ         ;MOVE RECORD TO DBUFF
01910      LD       HL,BUFFER    ;1ST DBUFFER ADDR
01920      LD       DE,(BUFPTR)  ;DESTINATION
01930      LD       BC,100H      ;256 BYTES TO MOVE
01940      POP     AF           ;RESTORE A
01950      CP       6           ;CTRL/F ?
01960      PUSH    AF           ;SAVE A
01970      JR       NZ,LDBUF    ;MOVE BYTES TO BUFFER
01980      CALL    FAST        ;SEND TO COMPUTER
01990      JR       GETMR       ;CONTINUE
02000 LDBUF LDIR          ;MOVE BYTES TO BUFFER
02010      LD       (BUFPTR),DE  ;SAVE NEW BUFFER POINTER
02020      LD       HL,(BUFNUM)  ;NEED TO UPDATE BUFNUM
02030      INC      H           ;ADD 256 TO HL
02040      LD       (BUFNUM),HL  ;SAVE # CHAR
02050 GETMR LD       HL,(CTRD)   ;PREVIOUS # RECORDS
02060      DEC      HL          ;CURRENT # RECORDS
02070      LD       (CTRD),HL   ;SAVE IT
02080      DEC      HL          ;CHECK IF (CTRD) IS 1
02090      LD       A,L        ;LSB
02100      OR       H           ;MERGE MSB
02110      JR       NZ,RDR3    ;IF (CTRD)>1, READ NEXT RECORD
02120 RDR3  LD       DE,DCB     ;1 RECORD LEFT
02130      CALL    READ         ;PUT IT IN DBUFFER
02140      LD       A,(EOF)     ;EOF OF LAST RECORD
02150      CP       0           ;FULL 256 BYTES ?
02160      JR       NZ,RDR3    ;IF NOT, GO
02170      LD       DE,(BUFPTR) ;DISTINATION
02180      LD       HL,BUFFER    ;SOURCE
02190      LD       BC,100H      ;# OF BYTES TO MOVE
02200      POP     AF           ;RESTORE A
02210      CP       6           ;CTRL/F ?
02220      PUSH    AF           ;SAVE A
02230      JR       NZ,LDBUF1  ;PUT INTO BUFF
02240      CALL    FAST        ;SEND TO COMPUTER
02250      JR       RDR3       ;DONE
02260 LDBUF1 LDIR          ;MOVE 'EM
02270      LD       (BUFPTR),DE  ;SAVE BUFFER POINTER
02280      LD       HL,(BUFNUM)  ;UP DATE BUFNUM
02290      INC      H           ;ADD 256 TO HL
02300      LD       (BUFNUM),HL  ;SAVE # OF CHAR IN BUFFER
02310      JR       RDR3       ;FINISHED READING FILE
02320 RDR3  LD       A,(EOF)     ;# BYTES TO MOVE
02330      LD       C,A        ;A
02340      LD       B,0         ;# BYTES TO MOVE IN BC
02350      POP     AF           ;GET A
02360      CP       6           ;CTRL/F ?
02370      PUSH    AF           ;SAVE A
02380      JR       Z,RD        ;IF CTRL/F GO
02390      LD       HL,(BUFNUM)  ;PREVIOUS # IN BUFF
02400      ADD     HL,BC        ;UPDATE IT
02410      LD       (BUFNUM),HL  ;SAVE BUFNUM
02420      LD       DE,(BUFPTR) ;DESTINATION
02430 RD    LD       HL,BUFFER  ;SOURCE
02440      POP     AF           ;RESTORE A
02450      CP       6           ;CTRL/F ?
02460      PUSH    AF           ;SAVE A
02470      JR       NZ,LDBUF2  ;PUT INTO BUFF
02480      CALL    FAST        ;SEND TO COMPUTER
02490      JR       RDR3       ;DONE
02500 LDBUF2 LDIR          ;MOVE BYTES INTO BUFF
02510      LD       (BUFPTR),DE  ;SAVE NEW BUFF POINTER
02520 RDR3  LD       DE,DCB     ;READY TO CLOSE FILE
02530      CALL    CLOSE       ;CLOSE IT
02540      JP       RCV        ;FINISHED, GO BACK
02550 ;***** BUFXT - DUMPS FROM BUFFER TO COMPUTER *****
02560 BUFXT LD       BC,(BUFNUM) ;# CHAR IN BUFFER
02570      LD       A,B        ;MSB
02580      OR       C           ;MERGE LSB

```

Listing 1 continued on page 462

MEMOREX Flexible Discs

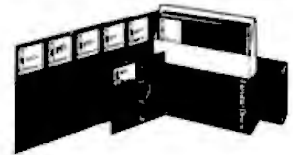

BEST PRICES IN THE U.S.

Call for our special dealer program. C.O.D.'s accepted.
TOLL FREE (800) 652-8168
In California (213) 901-8881



U.S. EXCHANGE
14831 Bessemer St.
Van Nuys, CA 91411-2773

Circle 466 on Inquiry card.

ATR8000: THE DOUBLE DENSITY DISK INTERFACE FOR



ATARI®
800/400

- 16K RAM upgradable to 64K.
- With OSA+

Version 4 is double density.

- Runs standard 5 1/4" or 8" drives.
- A Z80 4 MHz controller.
- A serial and a parallel port.
- Software compatible with existing ATARI software.
- Is CP/M compatible (with 64K).

ATR8000 \$499.95
OSA+ Version 4 \$ 49.95
5 1/4" drive \$399.95
64K Upgrade —Call—

SOFTWARE PUBLISHERS, INC.

2500 E. Randol Mill Rd., Suite 125
Arlington, TX 76011 (817) 469-1181

Circle 467 on Inquiry card.

Votrax SC-01A SPEECH SYNTHESIZER



\$50 Each

Order in Ones or Thousands

The SC-01A Speech Synthesizer is a completely self-contained solid state device. This single chip phonetically synthesizes continuous speech of unlimited vocabulary.

The SC-01A contains 64 different phonemes which are accessed by a 6-bit code. Computer interfaces and text-to-speech algorithms also available for product development.

Votrax is a trademark of Federal Screw Works
Call 1-800-645-3479, in N.Y. 1-516-374-6793

MICROMINT INC.,
917 Midway
Woodmere, N.Y. 11598



Call for
quantity pricing.



Circle 468 on Inquiry card.

IBM PC Software

SOFTSPOOL^(tm)—printer spooler
 *Creates true foreground/background operation
 *Buffer sizes user modifiable (1-128K)
 *Program execution no longer linked to printer speed.
 \$49.95 (includes disk & doc)

KEYSWAP^(tm)—typing utility
 *Transforms the PC's keyboard into a standard type-
 writer keyboard
 *Poorly positioned keys are relocated and replaced
 *Optional audible feedback on "toggle" keys
 *Increases "touch typist" efficiency
 *\$69.95 (includes disk, stick-on labels & doc)

BOTH PROGRAMS

*Work with any program that runs under DOS
 (EASYWRITER^(tm), VISICALC^(tm), WORDSTAR^(tm),
 etc.)

*Ideal for Business or Software development

PROCRYPT^(tm)—software protection program
 *Encrypts, serializes, and copy protects your programs—
 Call for price!

SOFTSPOOL & KEYSWAP for \$99.95

FOR ORDERS OR INFO CALL—(617) 662-0856

OR SEND CHECK TO:

Rickerdata
 P.O. Box 288
 Burlington, MA 01803

MC & VISA
 accepted
 Add \$2.50 S&H

terms & conditions may change w/o notice

Circle 370 on inquiry card.

**MEMOREX
 FLEXIBLE DISCS**

**WE WILL NOT BE UNDER-
 SOLD!** Call Free (800)235-4137
 for prices and information. Dealer
 inquiries invited and C.O.D.'s
 accepted.

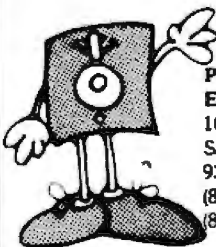

**PACIFIC
 EXCHANGES**
 100 Foothill Blvd.
 San Luis Obispo, CA
 93401. In Cal call
 (800)592-5935 or
 (805)543-1037

Circle 318 on inquiry card.

**DISKETTES
 3M Scotch[®] BRAND**

AT SUPER LOW PRICES
 WE WILL SHIP YOUR
 ORDER WITHIN 24 HOURS
 AND WE PAY THE
 SHIPPING CHARGES



COD ACCEPTED

DEALER INQUIRIES INVITED



**CALL TOLL FREE
 800 922-8193**

IN CALIFORNIA
 800 468-1068



Tayco Business Forms
 Computer Supplies
 Post Office Box 805
 Newbury Park, CA 91320

Circle 402 on inquiry card.

Listing 1 continued:

```

02590      JP          Z,RCV          :BUFFER EMPTY, GO BACK
02600      LD          HL,BUFBEG  :!ST BUFFER ADDR
02610      XMTLP    LD          A,(HL)    :!CHAR TO BE SENT
02620      LD          (CHAR),A  :!SAVE THE CHAR
02630      CP          0          :ASCII 0 ?
02640      JR          Z,TEMP3   :!IF SO, SKIP IT
02650      CP          141       :!GRAPHIC CR
02660      JR          NZ,OK1    :!IF NOT IGNORE
02670      LD          A,13      :!CHANGE TO CR
02680      OK1     LD          (CHAR),A  :!SAVE CHAR
02690      LD          (XMTBYT),A  :!PUT CHAR IN XMT BUF
02700      SENDIT  CALL       RSTX      :!SEND IT
02710      JR          Z,SENDIT   :!WAIT UNTIL SENT
02720      CP          13        :!CARRIAGE RETURN?
02730      JR          Z,TEMP3   :!IF SO, GO
02740      LD          A,(DUPLX)  :!DUPLX FLAG
02750      CP          0          :!HALF DUPLEX ?
02760      JR          NZ,TEMP   :!IF FULL DUP, GO RCV
02770      CALL     VIDEO       :
02780      JR          TEMP3     :!SKIP RCV
02790      TEMP    CALL       RSRV    :!CHECK RS 232 RCV
02800      LD          A,(RCVBYT)  :
02810      CP          0          :!ANYTHING THERE?
02820      JR          Z,TEMP     :!IF NOT, LOOK AGAIN
02830      LD          (CHAR),A  :!SAVE CHAR
02840      CALL     VIDEO       :!PRINT CHAR
02850      TEMP3  DEC         BC      :!DECREASE BUFF COUNT
02860      LD          A,B        :!TEST FOR 0 COUNT
02870      OR          C          :
02880      JP          Z,RCV      :!ALL DONE, GO BACK
02890      INC         HL         :!INCREASE CHAR LOCATION
02900      LD          A,(CHAR)   :!GET CHAR
02910      CP          13        :!CARRIAGE RETURN ?
02920      JR          NZ,XMTLP   :!IF NOT, GO GET NEXT CHAR
02930      LD          A,(HL)     :!NEXT CHAR IN BUFF
02940      CP          0          :!IS IT A 0 ?
02950      JR          NZ,PAUSE   :!IF NOT, GO PAUSE
02960      LD          A,C        :!TEST IF LAST CHAR
02970      DEC         A          :
02980      OR          B          :
02990      JP          Z,RCV      :!LAST CHAR 0, SO DONE
03000      PAUSE   CALL       RSRV    :!CHECK FOR INCOMING CHARS
03010      LD          A,(RCVBYT)  :!GET CHAR
03020      CP          0          :!ANYTHING THERE ?
03030      JR          Z,PAU1     :!IF NOT, GO CHECK KEYBOARD
03040      CP          10        :!LINE FEED ?
03050      JR          Z,PAUSE   :!IF SO, IGNORE IT
03060      LD          (CHAR),A  :!SAVE CHAR
03070      CALL     VIDEO       :!PRINT RECEIVED CHAR
03080      JR          PAUSE     :!GO CHECK RS232 RCV
03090      PAU1    CALL       KBCHAR  :!CHECK KEYBOARD
03100      CP          0          :!ANYTHING THERE ?
03110      JR          Z,PAUSE   :!IF NOT, GO CHECK RS RCV
03120      CP          3          :!CTRL/C ?
03130      JP          NZ,XMTLP   :!GO SEND MORE CHARS
03140      TEMP2  PUSH      HL      :!SAVE CURRENT BUFF LOC
03150      PUSH     BC          :!SAVE BUFF COUNT
03160      JP          RCV       :!GO TO RCV
03170      PAU2    POP        BC     :!BACK FROM RCV
03180      POP        HL        :
03190      BACK   JR          XMTLP  :!GO SEND MORE CHARS
03200      *****  DISKSV - DUMP BUFFER TO DISK *****
03210      DISKSV  LD          BC,(BUFNUM) :!# CHARS IN BUFFER
03220      LD          A,C        :!LSB
03230      OR          B          :!MERGE MSB
03240      JP          Z,RCV      :!BUFFER EMPTY
03250      CALL     FILNAM      :!SETS UP DCB
03260      LD          HL,BUFFER   :!DCB ADDRESS
03270      LD          DE,DCB     :!DCB ADDRESS
03280      LD          B,0         :!HL SET TO 256
03290      CALL     INT1       :!OPENS FILE
03300      LD          HL,(BUFNUM)  :!# CHARS TO WRITE
03310      LD          A,L        :!EOF
03320      LD          (EOF),A     :!SAVE IT
03330      CP          0          :!EOF - 0?
03340      JR          Z,OK        :!C TRD, IS OK
03350      LD          A,H        :!MUST INCREMENT (CTRD)
03360      INC         A          :!A CONTAINS # RECORDS
03370      OK     LD          (CTRD),A  :!# RECORDS TO WRITE
03380      LD          (ERNL),A    :!LSB ERN
03390      LD          A          :!ZERO A
03400      LD          (ERNM),A    :!MSB ERN
03410      LD          HL,BUFBEG  :!SOURCE
03420      WDISK   LD          BC,256  :!# BYTES TO MOVE
03430      LD          DE,BUFFER   :!DESTINATION
03440      LD         LR         :!MOVE 256 BYTES TO DRUFF
03450      LD         DE,DCB     :!DCB ADDRESS
    
```

Listing 1 continued:

```

03460 CALL WRITE WRITE TO DISK
03470 LD BC,178 RECORD COUNT
03480 DEC BC RECORDS LEFT
03490 LD A,B :MISC
03500 OR C :MERGE LSB
03510 JR Z,FINWR :IF DONE
03520 LD (CTR0),BC :SAV
03530 JR WDISK
03540 FINWR LD DE,DCB :DCB ADDRESS
03550 CALL CLOSE :CLOSE FILE
03560 CALL RESTOR :RESTORE SCREEN
03570 JP RCV :DONE
03580 ;***** FILNAM - SETS UP FILENAME *
03590 FILNAM LD HL,16256 :SOURCE
03600 LD BC,128 :# OF CHARS
03610 LD DE,TEMPST :DESTIN
03620 LDIR :SAVE LAST 2 LINES
03630 LD A,64
03640 LD IX,16256 :1ST ADDR OF 1ST LINE
03650 LINE1 LD (IX+0),CURSOR :DRAW LINE
03660 LD (IX+64),32 :CLEARS LAST LINE
03670 INC IX :INC PRINT POSITION
03680 DEC A :DONE ?
03690 JR NZ,LINE1 :FINISH LINE
03700 LD HL,LINE :PRINT 'ENTER FILENAME'
03710 LD B,14 :NUMBER OF CHARS TO PRINT
03720 LD DE,16320 :1ST PRINT LOCATION
03730 MESS LD A,(HL) :PUT CHAR IN A
03740 LD (DE),A :PRINT IT
03750 INC HL :INC MESSAGE POINTER
03760 INC DE :INC PRINT LOCATION
03770 DEC B :DEC COUNTER
03780 JR NZ,MESS :IF NOT DONE, GO BACK
03790 START LD C,0 :INITIAL CHAR COUNT
03800 LD HL,16336 :1ST CURSOR LOCATION
03810 LD (HL),CURSOR :PRINT CURSOR
03820 START1 CALL KBCHAR :CHECK KEYBOARD
03830 CP 0 :ANYTHING THERE ?
03840 JR Z,START1 :IF NOT, CHECK AGAIN
03850 LD (CHAR),A :SAVE CHAR
03860 CP 3 :CTRL/C ?
03870 JR NZ,CONT1 :IF NOT, GO
03880 CALL RESTOR :RESTORE SCREEN
03890 JP RCV :ESCAPE BACK
03900 CP 3 :CNTRL/C ?
03910 JR NZ,CONT1 :IF NOT, GO
03920 CALL RESTOR :RESTORE SCREEN
03930 JP RCV :BACK TO MAIN ROUTINE
03940 CONT1 CP 8 :BACK SPACE ?
03950 JR NZ,CONT :IF NOT, GO
03960 LD A,C :GET CHAR COUNT
03970 CP 0 :FIRST CHAR ?
03980 JR Z,START :IF SO, START OVER
03990 DEC C :DECREASE COUNT
04000 LD A,32 :BLANK
04010 LD (HL),A :BLANKS PREV CURSOR
04020 DEC HL :DEC CURSOR LOC
04030 LD (HL),CURSOR :PRINT CURSOR
04040 JR START1 :GO BACK TO KEYBOARD
04050 CONT CP 13 :CARRIAGE RETURN ?
04060 JR Z,MOVE :IF SO, GO
04070 LD A,C :GET COUNT
04080 CP 23 :MAX FILENAME LEN
04090 JR Z,START1 :MUST HAVE CR, GO BACK
04100 LD A,(CHAR) :GET CHAR
04110 LD (HL),A :PRINT IT
04120 INC HL :INCREASE CURSOR LOC
04130 LD (HL),CURSOR :PRINT CURSOR
04140 INC C :INC COUNT
04150 JR START1 :GO CHECK KEYBOARD
04160 MOVE LD A,32 :BLANK
04170 LD (HL),32 :ERASE CURSOR
04180 LD B,0 :CHAR COUNT IN BC
04190 LD HL,16336 :SOURCE
04200 LD DE,DCB :DESTINATION
04210 LDIR :MOVE FILENAME TO DCB
04220 LD A,13 :CARRIAGE RETURN
04230 LD (DE),A :CARRIAGE RETURN IN DCB
04240 RET :DONE
04250 ;***** RESTOR - RESTORES LAST 2 LINES TO SCREEN *****
04260 RESTOR LD BC,128 :# OF CHARS
04270 LD HL,TEMPST :SOURCE
04280 LD DE,16256 :DESTINATION
04290 LDIR :RESTORES LAST 2 ROWS TO SCREEN
04300 RET
04310 ;***** FAST - SENDS CHARS TO THE COMPUTER *****
04320 FAST LD A,(HL) :CHAR TO SEND
04330 CP 0 :ASCII ZERO ?

```

CHIPS & DALE

THE INFLATION FIGHTERS!

4116 250ns 8/89.50 100+ \$1.05 ea.
 4116 200ns 8/11.00 100+ \$1.18 ea.
 4116 150ns 8/13.50 100+ \$1.40 ea.
 4116 120ns 8/15.50 100+ \$1.65 ea.
 2114L 300ns 8/10.50
 2114L 200ns 8/12.00
 *4164 200ns \$5.45 ea.
 *4164 150ns \$6.25 ea.
 *6116 150ns \$5.50 ea.
 *6116 200ns \$4.50 ea.

*1791 Disk Controller \$20.00
 1777 Disk Controller \$17.50
 *280A CPU \$3.00 ea.
 8251A \$4.00 ea.
 2716-1 (5V)350ns 8/45.50 ea. \$6.25 ea.
 2716 (5V)450ns \$3.25 ea.
 *2732 (5V)450ns \$4.75 ea.
 *2532 (5V)450ns \$4.75 ea.
 *2764 5V 300ns 28 pin \$12.00 ea.
 *2764 5V 24 pin CALL
 *2564 5V CALL
 **8087 CALL
 68000 CALL

Allow up to 3 wks. for personal checks to clear. Please include phone number. Prices subject to change without notice. Shipping & Handling for Chips \$3.50. FOB Bellevue, WA. for all else. Wash. residents add 6.5% Sales Tax.

CHIPS & DALE 1-206-451-9770
 10655 N.E. 4th St., Suite 400
 Bellevue, WA 98004

POWER PROTECTION FOR YOUR SYSTEM

The Datasaver™ AC Power Backup fits most desktop and portable microcomputer systems. Call Cuesta Systems, Inc. at (805) 541-4160 for product information and application literature.

VISA/Mastercard orders call (800) 851-8055.

INSTANT POWER

Listing 1 continued:

```

04340      JR      Z,G03          ;IF SO, SKIP IT
04350      CP      141          ;GRAPHICS CHAR ?
04360      JR      NZ,G02        ;IF NOT, SKIP
04370      LD      A,13          ;CARRIAGE RETURN
04380 G02  LD      (CHAR),A        ;SAVE CHAR
04390      LD      (XMTBYT),A    ;PUT IN XMT BUF
04400      CALL   RSTX          ;TRY SENDING IT
04410      JR      Z,G01          ;TRY AGAIN
04420      CALL   VIDEO         ;PRINT CHAR
04430      INC    HL            ;POINT TO NEXT CHAR
04440      DEC    BC            ;DEC COUNTER
04450      LD      A,C          ;LSB
04460      CP      0            ;DONE?
04470      JR      NZ,FAST       ;IF NOT, GO
04480      RET                    ;DONE
04490      END      5400H

```

Text continued from page 458:

operator to determine the characteristics you need.) Refer to your Model III reference manual for an explanation of the RSINIT ROM (read-only memory) subroutine.

After initialization is completed, the main program continues with line 560, which checks the RS-232C port. If nothing has been received, the keyboard is checked. If, however, a character was received, it is displayed on the screen and then the keyboard is checked. If no character is received from the keyboard, the RS-232C port is checked again. If a character is entered from the keyboard, it is transmitted to the computer out the RS-232C port and the port is checked for received data.

The VIDEO subroutine (line 1100) displays the character on the screen. Notice that there is no call to VIDEO following the keyboard check. This indicates the "full-duplex" mode—every character sent to the computer is echoed back so that a character entered from the keyboard is

displayed on the screen after it is received from the computer. If the computer operates in the "half-duplex" mode there is no echo, and characters entered from the keyboard must be displayed on the screen before they are sent to the computer. The terminal program has both full- and half-duplex capability and is initially in the half-duplex mode. To switch to full-duplex, simply press Control-D. To return to half-duplex, press Control-D again (this key toggles the duplex mode). If, at first, you find that characters entered from the keyboard are displayed twice on the screen, then the computer is in the full-duplex mode; toggle the terminal program to full-duplex. Incidentally, lines are not restricted to the screen width of 64 characters. Lines are terminated by the ENTER key and may be longer than 64 characters (though they will wrap around on the screen).

I decided to add a cursor, because it's hard to use the editor on the PDP-11/45 without one. The VIDEO

subroutine to accomplish this is necessarily complex. If you don't want a cursor you can define the cursor character to be an ASCII 32 instead of a 143 in line 210, or you can simply eliminate all lines in VIDEO that are associated with the cursor (there won't be much left).

When the PDP-11/45 receives a carriage return, it echoes back a carriage return as well as a linefeed character (ASCII 10). But the "linefeed-inhibit" feature keeps the video display from skipping a line. (If this feature causes problems with your printer, you can take it out.) The PDP-11/45 returns a linefeed even in the half-duplex mode, so a carriage return is not displayed following the keyboard scan in this mode. If you find that the computer you are using does not echo a carriage return, then you will want to delete the feature.

Customized Versions

There are three different versions of the terminal program. The first is for a Model III that has 16K or more bytes of RAM but no printer or disk drives. In this case you can modify the terminal program by deleting lines 230-440, 530, 550, 630-660, 700-950, and 1270-4480 and then assembling what is left. This is the simplified terminal program that permits your Model III to communicate with the remote computer.

Printer Option

If you have a parallel printer, you'll want to use it to obtain program listings and hard copy of data output

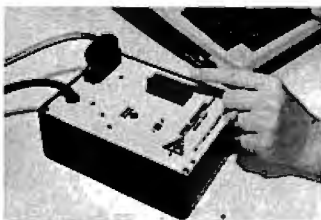

- Programs 2508, 2138, 2510, 2110, 21010, 2532, 2132, 2132A, 21032, 250, 2764, 27C64, MCM68766, 27128.
- RS-232, 3 line serial interface, Xon/Xoff format, DB-25 I/O connector.
- No personality modules - software control EPROM selection.
- Extended diagnostics.
- LED warning indicates power applied to EPROM socket.
- Supports Intel, Motorola, and Intel 8086 data formats as well as HEX data dump.
- Automatic baud rate selection.
- Textool zero insertion force socket.
- Available CP/M software.



PIVY, 003, P.O. BOX 387
BAY ST. LOUIS, MISSISSIPPI 39520
(601) 467-8231

953A, programs most 24 pin EPROMS.

Price -

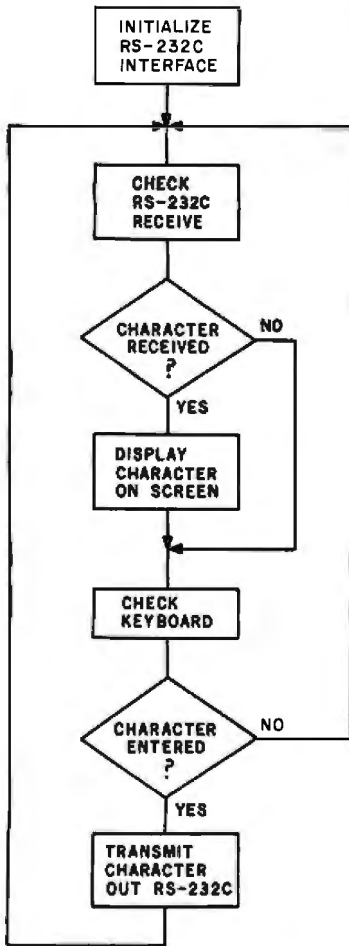

Figure 1: Operation of the main section of the terminal program. The RS-232C board is controlled from the program.

from the computer. In the interest of simplicity, I decided to avoid any kind of handshaking or sending "stall" or pause characters when using a printer. But rather than output characters to the line printer as they

are printed on the screen, I used the scheme that follows.

If you press Control-B, every character that appears on the screen thereafter is put into a buffer in the Model III. (See table 1 for a list of all program commands.) When the output ceases from the computer, press Control-P and everything that is in the buffer will be sent to the printer. If you want to stop printing before the entire contents of the buffer are printed, you can press Control-C to return to the terminal program. Control-C is used as an "escape" throughout the program.

Two other keys control the buffer. Control-O turns it off (i.e., closes off the buffer to character insertion). In addition, Control-E erases the buffer. (A listing of all control keys appears in table 1.)

The only disadvantage to using a buffer this way is that it has a limited

amount of space, so you may run out of RAM. I haven't found this to be a problem, though, even when the buffer is used for some disk operations as well. The assembled version of the terminal program occupies less than 1K bytes of RAM, which leaves at least 15K bytes of RAM for the buffer on a 16K-byte Model III.

The second version of the terminal program is for a Model III that has 16K or more bytes of RAM, a parallel printer, and no disk drives, as described above. Only the following lines should be deleted from the program in listing 1: 290-440, 780-940, and 1740-4480. In addition, the program should be moved down in memory as much as possible to maximize the size of the buffer. Make the changes in these addresses as listed in table 2. This version of the terminal program might be called the simplified program with printer capability.

Key	Function
Break	returns you to TRSDOS
Control-D	toggles duplex mode
Control-B	opens buffer
Control-O	turns buffer off
Control-E	erases buffer
Control-P	dumps buffer to line printer
Control-G	dumps buffer to computer a line at a time
Control-R	reads from disk and dumps into buffer
Control-W	writes to disk
Control-J	jumps back and continues sending to computer
Control-F	fast transfer from disk to computer

Table 1: Control commands for the terminal program.

IMMEDIATE DELIVERY



**TECHNOLOGICAL
BREAKTHROUGH**

LOW PRICES



INCOMM M-1200 (212A)
\$475.00

WHY PAY MORE FOR OLD TECHNOLOGY
IF OUR NEW LOW PRICED MICROPROCESSOR
DESIGNED MODEMS CAN SATISFY YOUR NEEDS?

OUR MODEM PRODUCT LINE CONSISTS OF 300 bps ACOUSTIC COUPLER, 300 bps DIRECT CONNECT, 1200 bps DIRECT CONNECT, 300/1200 bps DIRECT CONNECT, SINGLE AUTOMATIC DIAL 300/1200 MULTIPLE DIAL 300/1200. THEY ARE ALL BELL COMPATIBLE AND FCC REGISTERED MODEMS. ACCESSORIES IN OUR PRODUCT LINE CONSIST OF TELEPHONE SETS, A/B/C SWITCHES, CABLES AND ACCESSORIES, WITH MORE TO COME!



**INCOMM AUTO DIAL
300/1200**
\$630.00

**INCOMM MODEMS
2 YEAR WARRANTY!**



**INCOMM 300/1200
(A212A)**
\$575.00

DEALER INQUIRIES INVITED!
Please call today with your order.
Bank Cards are accepted.

**Corporate Office:
INCOMM
115 N. Wolf Road
Wheeling, Illinois 60090
Sales: 312-459-8881
Service: 312-459-8874**

Line Number		
100	ORG	42F2H
120 DUPLEX	EQU	42E9H
190 CHAR	EQU	42EBH
250 BUFLAG	EQU	42EAH
260 BUFPTR	EQU	42ECH
270 BUFNUM	EQU	42EEH
280 BUFBEQ	EQU	45AEH
4490	END	42F2H

Table 2: Memory address changes required for the printer option. Make these changes to the program in listing 1 to maximize the amount of memory in the buffer.

Disk Drive Option

The third version of the program uses a Model III that has one or more disk drives, 32K or more bytes of RAM, and a parallel printer. This version is identical to the program in listing 1 and has two disk operations: (1) sending data from disk to the computer and (2) saving data received from the computer on disk.

The first operation employs two different methods to transfer data

from a disk to the computer. The first method is a line-by-line transfer and the second is a continuous transfer. A line-by-line transfer is desirable because I access a PDP-11/45, which, in the immediate mode, has an immediate diagnostic for BASIC. In other words, if a BASIC program line with a syntax error is entered, for example, the computer will respond immediately and return an error message. It's useful to be able to cor-

rect a line immediately after the error message is displayed.

The line-by-line transfer makes use of the buffer. When you enter Control-R from the keyboard, a window opens up on the screen. You are then asked to enter the name of the disk file you want loaded into the buffer. The file is then dumped into the buffer and the screen is restored to its previous configuration. If the buffer already has data in it, the disk file is added to it. You can erase the buffer first with a Control-E. You can also close the buffer with a Control-O so that other characters are not put into it. If you enter Control-C as one of the filename characters, the screen is restored and execution jumps back to the main program.

Pressing a Control-G sends the data in the buffer to the computer. It is sent one line at a time; the operation pauses after a carriage return is encountered. This gives the computer a chance to respond. To send the next line, just press any key (except Control-C).

To escape from this "send" mode, enter Control-C, which returns you to the main section of the program. If the computer sends an error message after you have sent a line, you can correct the line before continuing on to the next one. Enter the corrected line and then press Control-J, and the Model III will continue sending where it left off. This way, you can send and edit a relatively large program in just a few minutes. The bother of having to send a character after each line is offset by the convenience of being able to edit a line immediately after it has been sent to the computer.

In the unlikely event that you have a program whose size exceeds the buffer, simply save it on disk in segments. Then successively load each part, send it to the computer, erase the buffer, load the next part, send it to the computer, and so on. This way you can save a program of any size.

The second transfer operation, continuous send, is similar but even easier. When you press Control-F, you will be asked to enter a filename just as before. The contents of that file will be sent without pauses to the computer. The characters will be dis-



VALENTINE DAY SPECIAL II

IBM-PC SPECIALS:

AST EXPANSION MEM' 64K...\$269 128K...\$369 192K...\$499 256K...\$569 SEATTLE RAM+ with SERIAL: 64K...\$349 128K...\$429 192K...\$499 256K...\$599 PERSYST SPECTRUM BOARDS and INSTA DRIVE CALL FOR PRICES...AUTOMATED BUSINESS MACHINES (IBM) Expandable MEMORY BOARDS Start at 64K \$119 each additional 64K add \$100

NEDEX BABY BLUE CARD (CP/M compatible).....\$499
 NEC 3550 (IBM-PC Compatible).....\$1979

SOFTWARE:

dBASE II.....\$479 SPELLBINDER.....\$249
 VISICALC (256K).....\$195 SUPERCALC.....\$189
 PEACHTREE PEACHPAK only.....\$335

CP/M SPECIALS:

COMPLETE SYSTEM READY TO GO—2DS DD Drives, TELETEK mother board 64K CP/M 5 1/4.....\$1999 8.....\$2349 TELEVIDEO and ADDS Terminals available. CROMEMCO'S NEW C-10SP \$1698 SCION MICROANGELO with SCREENPAK II MA \$12.....\$775 MA \$20.....\$999 ZENITH All in one: Z-120.....\$3295 SANYO MBC-3000.....\$4795 NORTHSTAR Advantage 64K.....\$2595 TELEVIDEO TS-80.....\$2595. We carry **COMUPRO BOARDS and COMPUTERS** SOFTWARE: We carry all major brands, call for our low prices. DIGITAL RESEARCH: MAC.....\$88 SID.....\$96 P/L 1-80.....\$429 MICROSOFT: BASIC 80.....\$249 BASIC COMPILER.....\$299 FORT-RAN 80.....\$359. MICROPRO.....SUPERSOFT.....ASHTON-TATE.....

APPLE SPECIA S:

MICROSOFT PREMIUM PAK.....\$479 MICRO-SCI disk drive.....\$299 Controller.....\$94. We carry all **SOFTWARE and GAMES for APPLE**

EPSON MX80FT III.....\$509 MX100 III.....\$689 C' TOH Prowriter 3499, LETTER QUALITY PRINTERS ALSO AVAILABLE...CALL

SPECIAL DEPARTMENT FOR UNIVERSITIES. WE ACCEPT PO's. ALL PRICES ARE SUBJECT TO CHANGE...PLEASE CALL FIRST



Suite #186 • 25422 Trobuco Rd., #105 El Toro, CA 92630
 (714) 766-8114

CP/M is a registered trademark of Digital Research. Apple is a trademark of Apple Computer.

played on the screen as they are sent. These characters are not put into the buffer, so there is no limit to the size of the program you send. The computer must be able to accept these characters as they are sent. If for some reason it is not ready, perhaps because of heavy use, some characters may be lost. Continuous send eliminates the need for handshaking or the use of stall or pause characters. There is no escape from the transfer operation; you must wait until the entire file has been sent.

The other disk operation, saving data sent from the computer, is easy as well. First put the incoming data into the buffer just as though you were going to output it to the printer. When the output has ceased, close the buffer with a Control-O so that no extraneous data is put into the buffer. Then enter a Control-W. You will be asked to enter a filename, after which the data will be written from the buffer to disk and the screen will be restored.

A Few Final Notes

Some of the more popular word processors store data with zero as a final character. This will not present a problem, because the program disregards zeros. In addition, a carriage return is often stored as an ASCII 141 character. The program will translate that to an ASCII 13 so that it will not be displayed on the screen.

The program has no disk-error recovery routines, so if a disk error occurs (if the computer tries to read a nonexistent file, for example) the program will probably bomb. Don't panic; simply press the Reset button to reboot, reload the program, and you'll be back in business. Whatever you do, don't hang up the telephone, because you will probably still be logged in, and the next person who accesses the computer may get into your account. I didn't put in any disk-error recovery capability so that I could limit the length of the listing.

One final note of caution: if you press Control-J (jump back) without having jumped out in the first place, the program will almost certainly crash. ■

IBM. USERS

SAVE 25% ON YOUR PC UPGRADES

ANATRON MULTIFUNCTION RAM BOARD ^{64 KB} Standard \$450

Socketed for easy memory expansion • Each port individually disabled
Parallel Printer Port may be configured as LPT1 or LPT2 or LPT3
Two RS 232 ports configured as COM1 and COM2 • Base address selectable on any 64 KB boundary • All features fully compatible with IBM PC

EVERYTHING FOR THE PC

HARDWARE

- Disk Drives:
 - Single Sided [160 kb]\$239.00
 - Double Sided [320 kb]\$300.00
- RAM Expansion Packages for
 - Mother Board [16 kb]\$25.00
 - Memory Expansion Board [64 kb]\$130.00
- Printers [NEC, EPSON, OKIDATA]\$CALL
- Monitors [NEC, TEKO, AMDEK]\$CALL
- Diskettes [3M ^{single sided} double sided]\$CALL
- Extension Cables for:
 - Printer\$CALL
 - Monitor (two cable set)\$CALL
 - Keyboard\$CALL

SOFTWARE

- Condor DBMS
- Ed-Word® Screen Editor/Word Processor
- NECPRINT [NEC 8023AC print utility]
- GRAPHDUMP

Prices reflect 3% Cash Discount

More hardware and software coming.
Call for details.

AEGIS SYSTEMS

P.O. Box 401
Terms FOB Saline

202 West Bennett Street, Saline, Michigan 48176
Hours 9 a.m. — 5 p.m. E.S.T.

1-800 521-0521
Michigan [313] 429-2678

RHINO® / APPLE SYSTEM I

\$4,995.00

An integrated high-tech robotic package for education, research, and industrial planning. Hardware. Teaching software programs. Comprehensive instruction manual. Peripherals available. System includes:

- RHINO® XR-1 (Standard Hand, Standard Power Supply)—¼" aluminum arm construction, optical encoders on each axis, six DC Servo Gear motors, digital design w/on-board microprocessor, built-in self-test program, 22.5" max. reach, 32" height, ¼" width, 5 lb. lifting capacity
- Apple II +, 48K
- Apple Disk II w/interface
- CCS 7710A RS-232C interface
- RHINO®/Apple interface cable
- Apple Monitor III—Green 12"
- RHINO®/Apple software package #1 (RASP 1)
- RHINO®XR-1 "Introduction to Robotics" 250 pg. manual
- Tool kit for robotic arm
- Instruction for RHINO®/Apple hook-up
- Apple DOS 3.3 Software System w/manual
- Apple system manuals w/software instruction manual



For information on the basic RHINO® system and other RHINO®/Apple integrated packages, contact:

RHINO

R O B O T S

Rhino Robots, Inc.
308 S. State, Champaign, IL. 61820
217/352-8485 TWX 910 245-0151

Systems shipped F.O.B. Champaign, IL. Price & specifications may be altered without notice.

What's New?



Full-Stroke Keyboard for Atari

The B Key 400, a full-stroke keyboard, provides an alternative to the Atari 400's membrane keyboard. Manufactured by Inhome Software, the B Key 400 is easy to install and has all the features of a full-stroke

keyboard. It's available for \$119.95 from Inhome Software Inc., 2485 Dunwin Dr., Mississauga, Ontario L5L 1T1, Canada, (416) 828-0775.

Circle 550 on inquiry card.

Large Keyboards for Disabled

Cacti Computer Services has designed an 11- by 21-inch pressure-sensitive keyboard system for individuals with limited hand or finger control. This system consists of a keyboard with widely spaced contacts, a driver routine, an interface to plug into the computer, connecting cables, and a plastic mask. Once the driver routine has been loaded, the computer's keyboard combines with the large keyboard to run commercially available

software without modifications.

Several keyboard layouts are offered, and custom arrangements can be made at no additional charge. The system is presently marketed for use with Apple and Commodore PET/CBM computers. It costs \$525. For full details, contact Cacti Computer Services, 130 9th St. SW, Portage la Prairie, Manitoba, R1N 2N4, Canada.

Circle 551 on inquiry card.

Expansion Slots for Color Computer

Up to four separate peripherals can be simultaneously connected to Radio Shack's TRS-80 Color Computer with Maple Leaf Systems' Multiport, a multiple-slot expansion unit. Each peripheral is on line and accessible to a program by means of a POKE command. With Multiport, the Color Computer is able to switch between peripherals under software control, which allows a single program access to any or all peripherals at any time. Multiport is described as a powerful hardware circuit that connects directly to all models of the Color Computer.

Multiport comes assembled and tested for \$99.50, and full instructions are included. It's available from Maple Leaf Systems, POB 2190, Station C, Downsview, Ontario M2N 2S9, Canada.

Circle 552 on inquiry card.

Interfaces in Computing

Interfaces in Computing is an international journal for system designers, electronic engineers, technicians, and production managers concerned with computing technology. Topics addressed in this quarterly range from low-speed communications between microprocessors to high-performance buses linking mainframes. Hardware and software inter-

facing are given equal priority.

Annual subscriptions to Interfaces in Computing cost 160 Swiss francs (approximately \$89), including postage. Further details are available from Elsevier Sequoia S. A., POB 851, CH-1001 Lausanne 1, Switzerland; tel: (021) 20 73 81; Telex: 26 620 ELSACH.

Circle 553 on inquiry card.

Microdoctor Diagnoses Computers

Dataman Designs' Microdoctor is an intelligent device to help engineers diagnose faults in computers and computer-controlled products. Microdoctor's built-in printer produces hard-copy printouts of preprogrammed tests on chips in addressing space. This device is capable of testing ROMs (read-only memories), RAMs (random-access read/write memories), and I/O and data lines. It can also be used for memory-mapping unknown systems and writing to or reading from any device in address or I/O space. Memory contents are printed out in hexadecimal or ASCII codes.

Microdoctor, a Z80-based product, comes with a Z80 disassembler that can be used to print out disassembled listings of the ROM in any Z80 system. Disassemblers for other microprocessors are available. The Microdoctor

What's New?

costs £295. Contact Data-man Designs, Lombard House, Cornwall Rd., Dorchester, Dorset, DT1 1RX, England; tel: (0305) 68066; Telex: 418442. Circle 554 on inquiry card.

MISCELLANEOUS

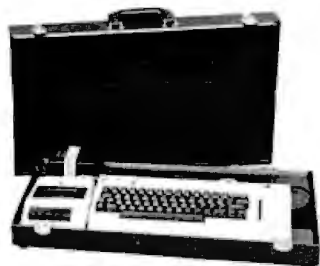

Computer Cases for Commodore 64

The Computer Case Company has added two carrying cases designed for the Commodore 64 to its product line. Made of luggage material with hard sides, brass hardware, and key locks, each case has room enough for additional equipment, papers, and manuals. Built-in rubber pads protect furniture, and steel lugs on the bottom protect the case when it's transported.

The CM703 case holds the Commodore, one or two disk drives, and the power supply. The CM704 case holds the computer, the data set program recorder, and the power supply. Both models can accommodate the Commodore VIC-20 and related equipment. These carrying cases are available at many computer stores or factory-direct from the Computer Case Co., 5650 Indian Mound

Court, Columbus, OH 43213, (800) 848-7548; in Ohio, (614) 868-9464. Circle 555 on inquiry card.

ASUs Ease Selection of Peripherals

Giltronix's series of automatic switching units (ASUs) is designed to facilitate automatic selection of peripherals by means of a computer or control device. ASUs give you remote peripheral options and the ability to select a printer, modem, etc. without leaving the keyboard. Giltronix ASUs have built-in software for unmanned computer-programmed control over peripherals. Networking capabilities are said to be enhanced through a specialized line-driving function. By connecting an ASU to a modem, remote-site port selection and operation can be achieved. Giltronix ASUs can switch RS-232C lines (TD, RD, RTS, CTS, DTR, DSR, DCD, and TC) and come configured for switching RS-232C ASCII/asynchronous data I/O devices.

Three models are currently available: the ASU3, ASU5, and ASU7 (three, five, or seven ports, respectively). Optional features include manual override and front-panel LED (light-emitting diode) monitoring. Prices range from \$449 to \$658. Full technical specifications can be obtained from Giltronix Inc., 970 San Antonio Ave., Palo Alto, CA 94303, (415) 493-1300. Circle 556 on inquiry card.

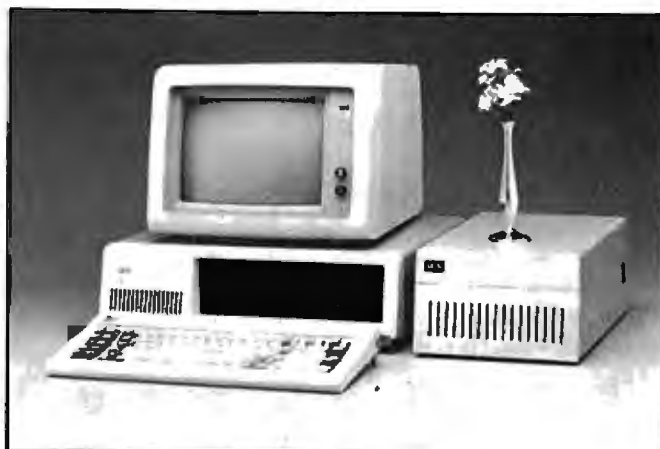

Expansion Frame for the IBM PC

The PCX-6 expansion frame from RCS gives the IBM Personal Computer six additional system slots. Its fully socketed motherboard permits simple expansion by insertion of appropriate chips. Optional support equipment for the PCX-6 includes two asynchronous serial ports, three parallel ports, a real-time clock, and an extra heavy-duty power supply for running a 5¼-inch Winchester hard-disk drive inside the Personal Computer. RCS also offers 64K-byte memory increments (192K-byte maxi-

mum) featuring DPECC (dynamic parity error-correction circuitry). DPECC memory detects single- and double-bit parity errors and corrects single-bit errors without system processor overhead and without interrupts.

The PCX-6 can be purchased with or without the optional equipment installed. Prices begin at \$595. Full information is available from RCS Inc., 2116A Walsh Ave., Santa Clara, CA 95050, (408) 727-7548.

Circle 557 on inquiry card.

Extra Slot for Apple Motherboard

Legend Industries' Soft 8 card plugs directly into the Apple II's slot 7 and provides slots 7 and 8. Switching between slots is software-driven, and you can shift back and forth between cards with simple software commands. With Soft 8, you can place nine software-accessible cards in your Apple.

Soft 8 is supplied with software that lets you modify standard Apple DOS so that it will recognize the added slot. The suggested retail price is \$84.95. Soft 8 is manufactured by Legend Industries Ltd., 2220 Scott Lake Rd., Pontiac, MI 48054, (313) 674-0953.

Circle 558 on inquiry card.

What's New?

Atari/CP/M Interface

USS Enterprises' Critical Connection provides the means to connect an Atari 400 or 800 to a CP/M system so that the Atari can use the CP/M system's printer, disk drives, and keyboard. This system is made up of hardware to connect an RS-232C port on a CP/M system to an Atari disk/printer port, 50 feet of cable, and an 8-inch single-density disk with software that makes the CP/M system's drives, printer, and keyboard replace the Atari's.

The Critical Connection costs \$175. The company requests that you provide the name of the CP/M system to be connected to the Atari. For a brochure describing the Critical Connection and further purchasing information, contact USS Enterprises, 6708 Landerwood, San Jose, CA 95120, (408) 997-0264. Circle 559 on inquiry card.

Floor Stand for Joysticks

The Grand Stand Company's joystick floor stand is designed for optimum positioning, comfort, and control. The company claims that it is an aid in eliminating wrist and elbow fatigue and improves finger dexterity. The stand is made from solid wood with a walnut finish and streamlined appearance. It costs \$34.95. Order from the Grand Stand Co., 4231 Bluebell Ave., Studio City, CA 91604. Circle 560 on inquiry card.

Interactive Training Programs for Professionals

American Training International (ATI) produces interactive training programs for popular software packages. These programs are targeted for professional users and are designed for CP/M systems and the IBM Personal Computer. ATI's menu-driven software provides hands-on practice, and a course can be completed in an average time of less than 45 minutes. Each course contains a general introduction and periodic refreshers.

ATI complements the training disks with a user's handbook that serves as a referenced hard-copy version of the information covered. Current titles available include PlanPower for Visicalc, D. B. Power for dBASE II, ATI-Power for IBM PC-DOS, and ATI-Power for CP/M. Each course costs \$75. For full details, contact ATI Inc., Suite 300, 3800 Highland Ave., Manhattan Beach, CA 90266, (213) 546-4725. Circle 561 on inquiry card.

Diagnostic Service for Immediate Updates, Solutions

Tele-Maintenance, a communications and diagnostic service from Rotating Logic Systems, provides immediate hard-disk analyses and software updates. According to the company, electronic analyses over toll-free telephone lines will ensure

that correct service solutions are conveyed to the user's display screen or printer. Routing software updates and service inquiries to factory technicians will give customers on-the-spot service and

corrections. Full particulars on the Tele-Maintenance service will be supplied by Rotating Logic Systems, Highland and White St., Greensburg, PA 15601, (412) 832-0140. Circle 562 on inquiry card.

SYSTEMS

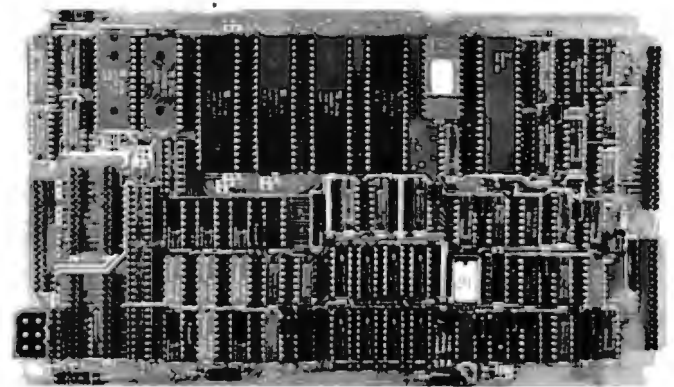

Compact Z80 Board

Davidge Corporation's DSB-4/6 single-board computer measures 10 by 5 $\frac{3}{4}$ by $\frac{3}{4}$ inches—small enough to fit inside a 5 $\frac{1}{4}$ -inch floppy-disk enclosure. The DSB-4/6 comes with a disk controller that automatically interfaces with both single- or double-density 5 $\frac{1}{4}$ - and 8-inch floppy-disk drives simultaneously, a Centronics-type parallel port, a parallel hard-disk port that provides 8-bit bidirectional I/O and A0 and A1 address lines, a 2K-byte boot EPROM (erasable programmable read-only memory), and 64K bytes of RAM (random-access read/write memory). The

DSB-4/6 can be configured for two or four RS-232C serial ports of which three can be used for standard peripherals; the fourth port is available for a modem. The company offers a choice of the 4-MHz Z80A or the 6-MHz Z80B processor.

In single units, the price for the DSB-4/6 ranges between \$695 and \$995, depending on processor and number of I/O ports desired. Quantity discounts are available. For complete details, contact Davidge Corp., Suite X, 1951 Colony St., Mountain View, CA 94043. Circle 563 on inquiry card.

What's New?

User-Friendly Multiuser System

Z-Disk is a fully integrated desktop multiuser system designed for office or small business use from Product Associates Inc. This system features a simple menu-choice sequence and a mouse for easy menu selection. For each user, Z-Disk dedicates a processor module that contains a Z80 microprocessor, 64K bytes of RAM (random-access read/write memory), and complete I/O capabilities. A master processor module supervises all user requests for shared storage and peripheral devices. Communication between the master processor and user modules is handled by a high-speed parallel bidirectional synchronous inter-processor data channel.

Standard features include a user-to-system interface that makes Z-Disk user-friendly for nontechnical users, two serial ports, one parallel port, and field-expansion capabilities for up to five users. System software is made up of MP/M, CP/NOS, and Comstar software, which provides this system with an extensive base of CP/M-compatible applications functions. The Comstar software gives Z-Disk integrated word-processing, planning, and communications capabilities. It uses an interactive prompting menu approach to guide users through application procedures.

Mass storage for Z-Disk includes up to 40 mega-

bytes of Winchester disk drives and a floppy-disk drive. Single Z-Disks have a base price of \$2995; quantity and OEM (original equipment manufacturer) discounts are available. For full information, contact Product Associates, 465 Convention Way, Redwood City, CA 94063, (415) 364-3121. Circle 564 on inquiry card.

Workstations Run Two Concurrent Jobs

Wordplex Corporation's 80-4 workstation can serve as the host computer in a three-terminal cluster. In an 80-4 network, the control station and its two satellites have individual displays and keyboards, 128K bytes of memory, and independent Z80 microprocessors. The control station has a double-sided double-density 5¼-inch floppy-disk drive (600K bytes of storage) and a 10-megabyte Winchester disk drive that's shared by all three workstations.

Wordplex's Gemini operating system highlights the 80-4 workstation. Gemini is said to give the 80-4 the processing power of two terminals in each satellite workstation through a Dualground processing technique. This process permits each satellite to load and run two concurrent tasks in main memory, with each job having a distinct screen image and keyboard buffer. Each workspace (ground) in the

Dualground system comprises 32K bytes of dedicated memory. Also, a block of up to 24K bytes of memory is divided between the two workspaces and dynamically assigned as required.

The 80-4 offers users the option of running CP/M and CP/M-compatible applications on a stand-alone basis, and the cluster can have two ports for external communications. Op-

tional equipment for the 80-4 workstation includes 5¼-inch double-sided double-density floppy-disk drives for the satellite terminals. A fully configured system costs less than \$8000 per workstation. For complete details, contact Wordplex Corp., 141 Triunfo Canyon Rd., Westlake Village, CA 91361, (213) 889-4455. Circle 565 on inquiry card.



Mastermax Based on Z80/S-100

Mastermax, a four-slot S-100 Z80-based computer, is marketed by John D. Owens Associates. This single-card computer has dual 8-inch floppy-disk drives, 64K bytes of bank-selectable RAM (random-access read/write memory), and a four-channel direct memory access controller. The floppy-disk controller can handle both single- and double-density data transfers and control up to four 5¼- or 8-inch disk drives in either DMA (direct memory access), interrupt, or programmed I/O modes. Mastermax also incorporates 4-MHz operation, IEEE 696.1/D compliance, the CP/M operating system, two

parallel I/O ports, and two RS-232C serial channels, one of which is programmable in either DMA, interrupt, or programmable I/O modes. When equipped with the TurboDOS multi-user operating system, Mastermax can accommodate four users accessing the same bus and database.

Options for Mastermax include 10-, 20-, and 40-megabyte Winchester hard-disk drives. With documentation, the basic system costs \$2540. Further information is available from John D. Owens Associates, 12 Schubert St., Staten Island, NY 10305, (212) 448-6283.

Circle 566 on inquiry card.

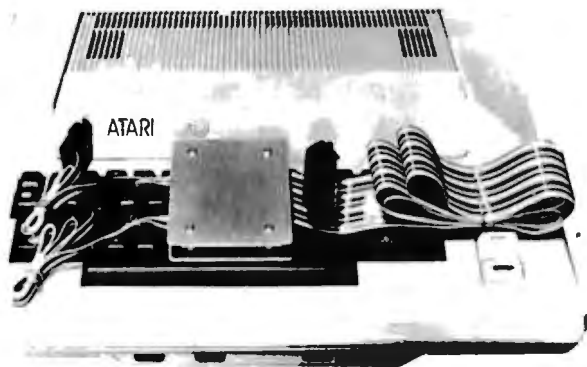

Atari Printer Interface

Looking Glass Micro-products' Interface No.1 allows any printer with a Centronics-compatible parallel interface to be connected to an Atari 400/800 via controller jacks J3 and J4. The interface comes with a printer-handler that replaces the one resident in the Atari and occupies less than 128 bytes of user program area. The printer-handler is compatible with Atari cartridges and programs and

comes on either cassette or disk.

Complete documentation, installation instructions, and program listings are supplied with Interface No.1. It costs \$85, which includes a 15-day money-back guarantee. Dealer inquiries are invited. Full details are available from Looking Glass Microproducts, POB 5084, Loveland, CO 80537.

Circle 567 on inquiry card.

Random-Access Printing

Interactive Structures, manufacturer of the Pkaso ID12 Color Printer Interface, has introduced the IS Pipeline print buffer. Featuring random-access printing, Pipeline lets you select sentences, paragraphs, graphs, or pictures from different programs or computers so that you can compose and print a finished document. Pipeline is useful for inserting graphs into reports, placing addresses on form let-

ters, and compiling letters out of component paragraphs. Standard operating functions include conventional FIFO (first-in, first-out) operation, data compression for space saving, the ability to bypass buffer operations for straight-through printing, a simple erase feature to clear the buffer, and automatic duplication. The Pipeline's memory can be expanded from 8K bytes to 128K bytes, and the

system is compatible with any Centronics-type parallel computer-printer connection.

Pipeline comes with a plug-in power supply, cabling, and manual. It's guaranteed for one year and ranges in price from \$195 to \$405, depending upon buffer size. For further details, contact Interactive Structures Inc., 146 Montgomery Ave., Bala Cynwyd, PA 19004, (215) 667-1713.

Circle 568 on inquiry card.

Pac RAT Stores Up to 8 Megabytes

Damco's Pac RAT (random-access tape) gives you from 5 to 8 megabytes of on-line random-access storage (unformatted) in a package the same size and shape of a standard 5¼-inch floppy-disk drive. Each of Pac Rat's two magnetic tape cartridges has 88 tracks of 60 or 95 sectors (256-byte sectors) per track. A single read or write accesses each cartridge. Pac Rat's power requirements and controller interface are floppy-disk standard so that it can plug into existing systems. In small quantities, it costs less than \$480. Contact Damco, 2210 18th Ave., Rock Island, IL 61201, (309) 793-0655.

Circle 569 on inquiry card.

8086 Upgrade for Heath/Zeniths

Technical Micro Systems' H-1000 is an 8086 upgrade that replaces the

2-MHz Z80 board in Heath/Zenith H-89/Z89 computers. This board retains all the Z80 board's features while providing a 16-bit 8086 processor, two additional I/O slots, 128K bytes of RAM (random-access read/write memory) that can be expanded to 1 megabyte, a dual-speed software-controlled clock for the Z80, and the ability to run the MS-DOS or CP/M-86 operating systems. It's completely compatible with existing Heath hardware and software. When in its 8086 mode, the H-1000 is software-compatible with Z-100 systems and the IBM Personal Computer under MS-DOS or CP/M-86.

In single units, the H-1000 costs \$1495. Full details are available from Technical Micro Systems Inc., Department H, 366 Cloverdale, Ann Arbor, MI 48105, (313) 994-0784.

Circle 570 on inquiry card.

Modem Operates Independently of Host

Visionary 100 is a 300-bps (bit-per-second) programmable 8085 microprocessor-controlled modem that operates independently of the host computer. When your computer is switched off or working on a task, this modem can automatically answer a telephone, receive and store a transmission in its memory, and activate a front-panel message-waiting indicator. Additionally, the Visionary 100 can print a message, complete with date and

What's New?

time, to your terminal.

Standard features include an 8K-byte control program; a 2K-byte buffer that can be expanded to 24K bytes; a real-time clock and calendar; programmable auto-answer, auto-dial, auto-send, and reception; and storage and retrieval of telephone numbers, custom commands, and text files. Data formats provided are serial, binary, asynchronous 7 or 8 data bits, 1 or 2 stop bits, and no parity. Data rates of 300 or 1200 bps to the host machine and 300 bps to telephone lines are standard.

The Visionary 100 uses an RS-232C interface and is Bell System 100 series compatible (answer or originate). It costs \$595 from Visionary Electronics Inc., 141 Parker Ave., San Francisco, CA 94118, (415) 751-8811.

Circle 571 on inquiry card.

Printmate 99

MPI's Printmate 99 is an 80-column dot-matrix printer. It features a 1K-byte memory buffer, tractor and friction feeds, and built-in Centronics-type and RS-232C interfaces. It can print at 100 characters per second.

Options for the Printmate 99 include a 2K-byte memory buffer and a single-sheet feeder. The suggested price is \$695. Full specifications can be obtained from MPI, 4426 South Century Dr., Salt Lake City, UT 84107, (800) 821-8848; in Utah, (801) 263-3081.

Circle 572 on inquiry card.

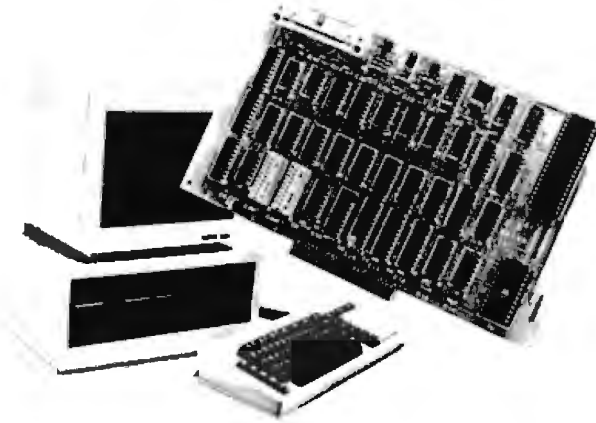

CP/M-86 and CP/M-80 Compatibility for Victor 9000

Small Systems Engineering Corporation's Victor-80 plug-in card lets the Victor 9000 run either 16-bit CP/M-86 or 8-bit CP/M-80 software. Victor-80 is based on Zilog's Z80 microprocessor and features up to 64K bytes of RAM (random-access read/write memory) running at speeds of up to 6 MHz with no wait states. It plugs directly into any of the Victor's four internal expansion slots and permits all standard CP/M 2.2 software to run without modification.

The Victor-80 comes with a floppy disk containing two files for software toggling between CP/M-86 and CP/M-80. Files generated under either CP/M are structurally identical, and any file created under

one operating system can be used by the other without restrictions. Other standard features of this card include a built-in Corvus hard-disk interface and the ability to accommodate as many as four Corvus 20-megabyte disks simultaneously. Optional high-speed backup capabilities include the Corvus Mirror and a video-cassette recorder.

In single units, the 4-MHz Victor-80-A card costs \$595, and the Victor-80-B, which operates at 6 MHz, lists for \$650. Complete information is available from Small Systems Engineering Corp., 1056 Elwell Court, Palo Alto, CA 94303, (415) 964-8201.

Circle 573 on inquiry card.

entry gives a brief description, price, operating system versions, and the vendor's name, address, and telephone number. Many of the programs will run under CP/M-86, MP/M-80, MP/M-86, and Concurrent CP/M-86 and all are said to be available for the CP/M-80 operating system.

Single copies of the index cost \$10; outside North America, \$14. Order from the Small Systems Group, POB 5429, Santa Monica, CA 90405.

Circle 574 on inquiry card.

Business Packages Catalog

A free catalog featuring more than 40 business applications packages and publications for Apple II and III computer users is available from Monument Computer Service. It includes accounting, word processing, payroll, and medical billing programs. Contact Monument Computer Service, Village Data Center, POB 603, Joshua Tree, CA 92252, (619) 365-6668.

Circle 575 on inquiry card.

New Release Explores Database Software

David Kruglinski's Data Base Management Systems is purported to be the definitive source for thorough and objective information on microcomputer database-management packages. It is intended to supply the information you need to intelligently decide how to buy

PUBLICATIONS

CP/M Software Index

The third edition of the CP/M Software Index lists more than 1600 programs offered by 507 vendors. Produced by the Small Systems Group, the index is

organized into five major areas: systems programs, general applications, accounting applications, utility applications, and industry-specific software. Each

What's New?

and use database-management software for your business. In this book, the capabilities of file, relational, and network/hierarchical systems are defined and standards for evaluating database-management software are provided. Several software packages are examined, including Condor Series 20, dBASE II, FMS-80, Datastar, and many others that run under CP/M.

Data Base Management Systems, a 256-page paperback book, costs \$16.95 and is available from Osborne/McGraw-Hill, 630 Bancroft Way, Berkeley, CA 94710, (415) 548-2805.

Circle 576 on inquiry card.

Inside the Personal Computer

The revised edition of Tenley Design's Inside the IBM Personal Computer can be ordered from Starware. This book provides a detailed explanation of the system's operation and serves as a supplement to the IBM Personal Computer Technical Reference Manual. The theory behind the system board electronics is described, and a design for a multifunction I/O board that's compatible with the IBM's expansion slots is provided. Information on interfacing user-supplied hardware and software to the system is presented.

Inside the IBM Personal Computer costs \$12.95. It's published and distributed by Starware, 1701 K

St. NW, Washington, DC 20006.

Circle 577 on inquiry card.



Directory Helps Consumers Compare Software

Information Sources' Small Systems Software and Services Sourcebook is designed to help you avoid purchasing programs that don't fill your needs. In nontechnical terms, this work describes the applications and limitations of 1300 minicomputer and microcomputer programs for machines manufactured by Apple, Commodore, Data General, Digital Equipment Corporation, Hewlett-Packard, Honeywell, NEC, and Zenith. This book, which is more than 500 pages, also gives you data on related services, hardware and operating system compatibility, purchasing terms, and vendors.

The Small Systems Software and Services Sourcebook is a limited

edition available at a one-year subscription rate of \$125. A 600-page comprehensive supplement with up-to-the-minute listings is included with each subscription. For further details, contact Information Sources Inc., 1807 Glenview Rd., Glenview, IL 60025, (312) 724-9285. Circle 578 on inquiry card.

Comprehensive Software Catalogs

Queue has produced three free catalogs describing discount and educational software. Queue Catalog #10 lists more than 100 programs for the Atari, and Catalog #11 focuses on programs for the VIC-20. Listing several thousand programs from more than 140 publishers, Catalog #12 is devoted to the Apple computer.

Queue's educational software catalogs cover all grade levels from kindergarten (Catalog #8) to college (Catalog #9) and Apple, PET, and TRS-80 computers. To order, specify computer and catalog number. Queue Inc., 5 Chapel Hill Dr., Fairfield, CT 06432, (203) 335-0908.

Circle 579 on inquiry card.

SOFTWARE

Orbquest

Orbquest is a role-playing CP/M game from Digital Marketing Corporation. The game, set in a fantasy universe, chal-

lenges you with ever-changing situations where monsters and pitfalls confound your search for an orb buried in a multilevel dungeon. With each journey into the dungeon, you gain experience and magical powers that make you stronger and help you get closer to the glittering orb.

Orbquest requires a 56K-byte CP/M system and a cursor-addressable terminal. It costs \$39.95, including a manual. It's available from Digital Marketing Corp., 2670 Cherry Lane, Walnut Creek, CA 94596, (415) 938-2880.

Circle 580 on inquiry card.

Free IBM PC Programs

B & L Computer Consultants is offering two free programs for the IBM Personal Computer. Electronic Disk causes system RAM (random-access read/write memory) to emulate a 160K-byte disk drive. It's said to be 50 times faster than a drive. This program requires 256K bytes of memory and is referenced as drive C. Electronic Disk can be employed in any application where a regular disk drive is being used.

New Reset provides two types of resets to DOS. The resets use the Control 1, Control 2, and Control 3 keys for single-handed control operation. Control 1 functions exactly like the IBM's Control ALT DEL sequence, and Control 2 functions similarly except

Alspa Computer, Inc.

The price-performance leader. Includes Z80A, 1 or 2 full 8" drives (double density, double sided), 3 serial and 1 parallel port, and Winchester port. Prices start at less than \$2000. DEALER and OEM inquiries invited

SPECIALS on INTREGATED CIRCUITS

6502	7.45	10/ 6.95	50/ 6.55	100/ 6.15
6502AJ6512A	8.40	10/ 7.95	50/ 7.35	100/ 6.90
6520 PIA	5.15	10/ 4.90	50/ 4.45	100/ 4.15
6522 VIA	6.45	10/ 6.10	50/ 5.75	100/ 5.45
6532	7.90	10/ 7.40	50/ 7.00	100/ 6.60
2114-L200		2.45	25/ 2.30	100/ 2.15
2716 EPROM		4.90	5/ 4.50	10/ 4.00
2532 EPROM		7.90	5/ 7.45	10/ 6.90
6116 2Kx8 CMOS RAM		7.90	5/ 7.45	10/ 6.90
4116 RAM				8 for 14
Zero Insertion Force 24 pin Socket (Scanbe)				2.00

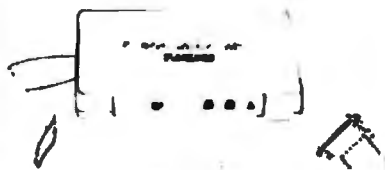

Anchor Automation Signalman Modems

FREE SOURCE MEMBERSHIP WITH SIGNALMAN
All Signalman Modems are Direct Connect, and include cables to connect to your computer and to the telephone. Signalman Modems provide the best price-performance values, and start at less than \$100 Dealer and OEM inquiries invited

- Mark I RS232
- Mark II for Atan 850
- Mark IV for CBM/PET with software
- Mark V for Osborne (software available)
- Mark VI for IBM Personal Computer
- Mark VII Auto Dial/Auto Answer
- Mark VIII Bell 212 Auto Dial/Answer

DC HAYES Smartmodem	229
RS232 MODEM — Acoustic	119
RS232 MODEM — CCITT frequencies	175

We carry Apple II+ from Bell & Howell

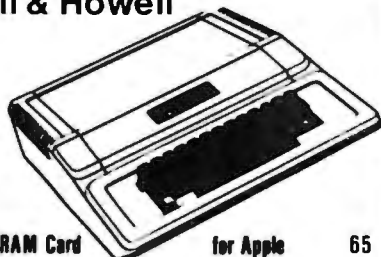

16K RAM Card for Apple	65
Apple LOGO	150
Video Recorder Interface	545
Super Serial Card	149
Thunderclock Plus	119
Z80 Softcard and CP/M	295
Parallel Printer Interface/Cable	80
Grappler Interface	139
TG Products Joystick for Apple	48
TG Paddles	32
DC Hayes Micromodem II	299
Videx 80 Column Card	259
fullFORTH+ for Apple (Itg-Forth)	85
Silentype Printer and Card	310
Graphics Tablet and Card	645
Apple PASCAL Language	195
Apple FORTRAN	160
We stock EDUWARE Software	
GENIS I Courseware Development System	145
Unicom Grade Reporting or School Inventory	250
Executive Briefing System with fonts	225
Apple Dumping (Microtek) Printer Interface	115
Apple Dumping with 16K Buffer	160
PIE Writer Word Processor	120

Commodore

See us for Personal, Business, and Educational requirements. Educational Discounts available.

PETSCAN \$245 base price

Allows you to connect up to 35 CBM/PET Computers to shared disk drives and printers. Completely transparent to the user. Perfect for schools or multiple word processing configurations. Base configuration supports 2 computers. Additional computer hookups \$100 each

Commodore COMMUNICATES! COMPACK \$129

Intelligent Terminal Package includes ACIA hardware based interface; DB25 Cable and STCP Software with remote telemetry, transfer to/from disk, printer output, XON-XOFF control, user program control, and status line

VE-2 IEEE to Parallel Interface 119

Includes case, power supply, full 8-bit transmission, and switch selectable character conversion to ASCII

VIC 20	189	VIC Sargon II Chess	32
VIC Printer	335	VIC GORF	32
VIC 3K RAM	32	Meteor Run (UMI)	39
VIC 8K RAM	53	VIC Radar Raltrace	24
VIC 16K RAM	99	Amok (UMI)	20
VIC Disk Drive	395	Snakman	15
VIC Pinball	32	Rubik's Cube	13
VIC Omega Race	32	Programmers Reference	15
Spiders of Mars (UMI)	39	Renaissance (UMI)	39
VIC Draw Poker	24	VIC Superslot	23

VICTORY Software for VIC

Street Sweepers	12	Maze in 3-D	12
Night Rider	11	Cosmic Debris	12
Treasures of Bat Cave	12	Grave Robbers Advent	11
Games Pack I	12	Games Pack II	12
Victory Casino	8	Adventure Park I	12
Adventure Pack II	12	Trek	11

TNW 488/103 with DAA	450
Compute!'s First Book of PET/CBM	11
POWER ROM Utilities for PET/CBM	78
WordPro 3+ - 32K CBM, disk, printer	195
WordPro 4+ - 8032, disk, printer	300
SPELLMASTER spelling checker for WordPro	170
COPY-WRITER Professional Word Processor	159
VISICALC for PET, ATARI, or Apple	190
PETRIX PET to Epson Graphics Software	35
SM-KIT enhanced PET/CBM ROM Utilities	40
Programmers Toolkit - PET ROM Utilities	35
PET Spacemaker II ROM Switch	36
2 Meter PET to IEEE or IEEE to IEEE Cable	40
Dust Cover for PET, CBM, 4040, or 8050	8
VIC or C64 Parallel Printer Interface	85
CMC IEEE-RS232 Printer Interface — PET	120
SADI Intelligent IEEE-RS232 or parallel	235
Library of PET Subroutines	12
Programming the PET/CBM (Compute!) — R. West	20
Compute! First Book of VIC	11
Whole PET Catalog (Midnight Gazette)	8
Color Chart Video Board for PET	125
PET Fun and Games (Cursor)	11

FlexFile for PET/CBM \$110

Database, Report Writer with Calculations, Mailing Lists

FORTH for PET full FIG model — Cargill/Riley	\$50
Metacompiler for FORTH for independent object code	30

KMMM PASCAL for PET/CBM	85
EARL for PET/CBM Disk-based ASSEMBLER	65

Super Graphics — BASIC Language Exercises	45
Fast machine language graphics routines for PET/CBM	

RAM/ROM for PET/CBM	4K \$75 8K \$90
----------------------------	-----------------

DISK SPECIALS

SCOTCH (3M) 5"	10/ 2.30	50/ 2.10	100/ 2.05
SCOTCH (3M) 8"	10/ 2.45	50/ 2.20	100/ 2.15

We stock VERBATIM DISKS

Write for Dealer and OEM prices

BASF 5" or 8"	10/ 2.00	20/ 1.95	100/ 1.85
Wabash 5"	10/ 1.80	50/ 1.75	100/ 1.70
Wabash 8"	10/ 2.00	50/ 1.95	100/ 1.90

We stock MAXELL DISKS

Write for dealer and OEM prices

Disk Storage Pages	10 for \$5	Hub Rings 50 for \$6
Disk Library Cases	8"—3.00	5"—2.25
Head Cleaning Kits	11	

CASSETTES—AGFA PE-611 PREMIUM

High output, low noise, 5 screw housings		
C-10	10/ 61	50/ 58 100/ 50
C-30	10/ 85	50/ 82 100/ 70

SPECIALS

Timex/Sinclair Computer	79
Zenith ZVM-121 Green Phosphor Monitor	109
VOICE BOX Speech Synthesizer (Apple or Atari)	
BMC Green and Color Monitors	
Many printers available (Star, Brother, OKI, etc.)	
We Stock AMDEK Monitors	
Watanabe Intelligent Plotter 1095	6-pen 1395
Staticide anti-static spray	6
dBASE II	390
Panasonic TR-120M1P 12" Monitor (20 MHz)	149
Panasonic CT-160 Dual Mode Color Monitor	285
Franklin Computers - special system price	
Hewlett Packard Calculators	

USI Video Monitors—Green or AMBER 20 MHz h-res Dealer and OEM inquiries invited



ALL BOOK and SOFTWARE PRICES DISCOUNTED

A P Products	15% OFF
Synertek SYM-1 Microcomputer	SALE 189
KTM-2/80 Synertek Video and Keyboard	349
KTM-3/80 Synertek Tubeless Terminal	385

ZENITH data systems

Z90-80 64K	1995
Z90-82 64K, 1 double dens drive	2245
Z37 1.3 Megabyte Dual Drive	1355
Z19 Video Terminal (VT-52 compatible)	695
ZT-1 Intelligent Communications Terminal	479
Z100 16-bit/8-bit System	CALL



ATARI SPECIALS

800 Computer	669	Microsoft BASIC	72
400—16K	269	MISSILE COMMAND	29
810 Disk Drive	440	ASTEROIDS	29
825 Printer	625	STAR RAIDERS	34
850 Interface	170	Space Invaders	29
Inside Atari DOS	18	Music Composer	35
Joysticks or Paddles	19	Caverns of Mars	33
16K RAM (Microtek)	69	PAC-MAN	36
32K RAM (Microtek)	99	CENTPEDE	36
Pilot	65	First Book of Atari	11
Super Breakout	29	Anchor Modem—Atari	85
APX Software	Call	Other Atari products	Call

WRITE FOR CATALOG

Add \$1.25 per order for shipping. We pay balance of UPS surface charges on all prepaid orders. Prices listed are on cash discount basis. Regular prices slightly higher. Prices subject to change.

252 Bethlehem Pike Colmar, PA 18915 215-822-7727 **A B Computers**

What's New?

that the memory is not erased. Control 3 does not involve rebooting from floppy disk; it merely returns you to the DOS prompt.

To receive these programs, send \$6 to cover disk and handling costs to B & L Computer Consultants, Free Programs Numbers 1 and 3, 226 South Cole, Boise, ID 83709. A contribution of \$15 and \$10, respectively, is requested if you find these programs useful.

Circle 581 on inquiry card.

Workshop Helps Atari Programmers

The Disk Workshop from Synergistic Software, a set of seven utility programs for Atari 400/800 computers, is designed to help you with programming functions. Disk Workshop includes disk-editing capabilities, fast copying of disks, a formatted disk directory that can be sent to a printer, the ability to use machine-language character strings in BASIC, a screen dump for the Epson MX-80 printer outfitted with Graftrax or Graftrax Plus, and the ability to transfer large files to disk or cassette. One program in the set, Micro-DOS, gives you a RAM-resident program similar to Atari's DUP.SYS. Micro-DOS is online and available at any time.

The Disk Workshop requires 32K bytes of memory and a single disk drive.

It costs \$34.95 and is available from Synergistic Software, Suite 201, 830 North Riverside Dr., Renton, WA 98055, (800) 426-6505; in Washington, (206) 226-3216.

Circle 582 on inquiry card.

8087 Coprocessor Products

Microware has introduced a line of products for the 8087 coprocessor implementation on the IBM Personal Computer. The Fastpak includes Intel's 8087 numeric data processor, installation instructions, and your choice of four programming languages. The 87/88 Guide, a handbook on using the 8087 processor, accompanies this package. This guide introduces 8087 programming using 87Macro and the IBM Macro Assembler or the CP/M-86 assembler. In addition, it has assembly-language listings that can be keyed in and run on the IBM. The guide can be purchased separately for \$18.95. Fastpak is \$375.

Microware is marketing a variety of languages for use with the processor, most of which require a 128K-byte IBM PC with one disk drive and a compiler. 87Pascal, a library of floating-point routines that directly drive the 8087, is said to increase the speed and accuracy of Pascal programs. For applications demanding numerous transcendental, roots, or powers, Microware offers 87FORTRAN. The 87BASIC package allows you to

perform both single- and double-precision arithmetic with the 8087.

The timesaving 87Macro is designed for applications requiring the full power of the chip. It contains a preprocessor that generates the complete 8087 instruction set and a library of macroinstructions and subroutines to simplify writing 8087 code. A double-sided double-density disk drive and the IBM Macro Assembler are required.

Each language is available as part of Fastpak or separately for \$125. For details, contact Microware Inc., POB 79, Kingston, MA 02364, (617) 746-7341.

Circle 583 on inquiry card.

Modula II Language Lifts Pascal's Restrictions

Volition Systems' Modula II is said to be a simple but powerful high-level programming language that solves the problems inherent in Pascal. Serving as an alternative to assembly language, C, and Ada for systems programming, this language was designed by Niklaus Wirth, the creator of Pascal. Modula (MODULAR LAnguage) features include modules, processes, separate compilation, dynamic array parameters, and low-level machine access. It consists of a p-code interpreter that's upward compatible with the Apple Pascal interpreter, a one-pass compiler, a library-management utility, and a standard module library.

A small language supple-

mented by library modules, **Modula II** requires a 64K-byte Apple II with the Apple Pascal operating system. The initial release provides access to the Apple Pascal file system and UCSD Pascal intrinsics by means of library modules. The compiler accepts the full Modula II language, as defined in the ETH Zurich Modula II report, with minor implementation restrictions. Programs are compiled into p-code.

Modula II costs \$550. Quantity discounts are offered. Updates and user-support via electronic mail are also available. For further details, contact Volition Systems, POB 1236, Del Mar, CA 92014, (714) 457-3865.

Circle 584 on inquiry card.

EPSON

MX 80 F/T III
MX 100 III 100 CPS

BOTH WITH GRAFTRAX+
HX-20 COMPUTER

Cards and cables for all computers
Please Call For Best Prices

OKIDATA

82 A \$399⁰⁰
83 A \$649⁰⁰

16K RAM CARD

Compatible with:
DOS 3.3, CP/M,
Visicalc, PASCAL
2 YR. WARRANTY

\$59⁰⁰

BASIS 108

APPLE COMPATIBLE
COMPUTER
CALL FOR LOWEST PRICE

SMITH-CORONA TP-1



LETTER QUALITY
DAISY WHEEL
\$575⁰⁰

SOFTWARE

WE HAVE IT ALL!
OVER 500 TITLES

• APPLE • CP/M
• IBM • ATARI
PARTIAL LISTING

ACCOUNTING PLUS	\$CALL
ALIBABA	\$CALL
ARCADE MACHINE	31.00
AZTEC	\$CALL
BPI — G/L, A/R, A/P	299.00
CURSE OF RA	15.00
DB MASTER	169.00
FIRST CLASS MAIL	59.00
FLIGHT SIMULATOR	27.00
FROGGER	\$CALL
HOME ACCOUNTANT	59.00
KNIGHT OF DIAMONDS	25.00
MICRO-PRO	\$CALL
MICROSOFT	\$CALL
PEACHTREE	\$CALL
PERFECT SOFTWARE	\$CALL
PFS	\$CALL
RASTER BLASTER	22.00
SUPERCALC	215.00
TEMPLE OF APSHAI	27.00
WORD HANDLER II	139.00
WIZARDRY	35.00
ZORK I, II, III	27.00

HARDWARE

WE CARRY MOST
PRODUCTS. PLEASE
CALL IF NOT LISTED

PARTIAL LISTING

DISK LIBRARY CASE	2.50
FLIP FILE	20.00
GRAPPLER +	139.00
HAYES MICROMODEM II	269.00
JOYPORT	49.00
KRAFT JOYSTICK	47.00
M & R ENTERPRISES	\$CALL
MX-80 PRINTER STAND	19.00
MX-PLUS	45.00
MICROBUFFER II 32K	239.00
MICRO-SCI DRIVES	\$CALL
MICROSOFT IBM RAMCD	299.00
MICROSOFT SOFCARD	239.00
NOVATION PRODUCTS	\$CALL
PAYMAR LCASE, REV.7	20.00
PKASO	158.00
PRACTICAL PERIPHERALS	\$CALL
SHIFT KEY MODIFICATION	12.00
VISTA PRODUCTS	\$CALL
WLOCARD	119.00
WIZARD BPO	158.00

VISICORP

IBM-APPLE II-APPLE III

Visilink (Apple)	179.00
Visicalc (IBM or Apple)	179.00
Desktop Plan II (Apple)	179.00
Desktop Plan (IBM)	249.00
Visidex (IBM or Apple)	179.00
Visifile (Apple)	179.00
Visifile (IBM)	249.00
Visiplot (Apple)	145.00
Visischedule (Apple)	229.00
Visiterm (Apple)	75.00
Visitrend/Plot (Apple)	229.00

QUENTIN RESEARCH, INC.

5 1/4" DRIVE **269⁰⁰**

SATURN SYSTEMS

64K	\$319 ⁰⁰
128K	459 ⁰⁰
V-C Expand 80	99 ⁰⁰

Mountain Computer

CPS Card	159.00
CPS Cable	\$CALL
Ramplus+32K	145.00
Rom Writer	145.00
Clock	195.00
Music System	299.00
Super Talker	149.00
Expansion Chassis	559.00
Card Reader	\$CALL
A/D-D/A	269.00
Visicalc Expander	\$CALL

Legend Industries

64K (includes V-C plus)	\$299 ⁰⁰
128K (inc. Videex V-CALC 80 w/mem. exp.)	479 ⁰⁰
Pascal Super Systems	\$CALL

Verbatim

5 1/4" (100)	\$239 ⁰⁰
5 1/4" (10)	26 ⁰⁰
8" (10)	39 ⁰⁰
Head Cleaning Kit	7 ⁰⁰

KENSINGTON MICROWARE

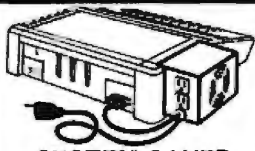

SYSTEM SAVER

- Surge Suppression
- Dual Outlet
- U.L. Listed
- Fits Apple Stand

\$65

TG Products

Paddles	\$29 ⁰⁰
Joystick II	40 ⁰⁰
Select-A-Port	47 ⁰⁰
All of Above	109 ⁰⁰
Trakball	\$CALL
Joystick III	\$CALL
Joystick IBM	45 ⁰⁰

MONITORS

BMC 12" Green Au	88 ⁰⁰
BMC 12" Green Eu	129 ⁰⁰
USI P13-12" Amber	169 ⁰⁰
USI P14-9" Amber	159 ⁰⁰
NEC 12" Green	179 ⁰⁰
NEC 12" Color	349 ⁰⁰
AMDEK	\$CALL
SANYO	\$CALL

Videx

80 Column	\$239 ⁰⁰
Enhancer II	119 ⁰⁰
Softswitch	25 ⁰⁰
Function Strip	59 ⁰⁰
Inverse Video	19 ⁰⁰
Appewriter Pre-Boot	19 ⁰⁰
Visicalc 80 Software	49 ⁰⁰
Visicalc 80 w/mem. exp.	74 ⁰⁰

EPSON RIBBONS MX 80 \$ 7⁰⁰ea or 3 for 20⁰⁰
MX 100 11⁰⁰ea or 3 for 32⁰⁰

DEALER
INQUIRIES
INVITED



COMPUTER
DISCOUNT
PRODUCTS

MAIL ORDERS & RETAIL STORE
860 S. Winchester Blvd.
San Jose, CA 95128
(408) 985-0400

HOURS: MON-FRI 8AM - 7PM - SAT & SUN 10AM - 4PM



MEI
(415) 873-3055

DYNAMIC RAMs

4164-150ns	5.75
4164-200ns	5.50
4116-150ns	1.30
4116-200ns	1.15

STATIC RAMs

2016P	3.85
2016P-1	4.50
6116P-3	4.75
6116LP-3	5.50
6264	CALL
2114LC3-200ns	1.35

EPROMs

2708	3.50
2716	3.85
2716-1	4.25
2732	4.50
2732-200ns	9.50
2764-250ns	15.00
2764-350ns	13.00
2764-450ns	11.00
2532-450ns	5.75
2546	18.00

Z80 FAMILY.....CALL

CALL FOR WHOLESALE PRICING.
MORE "I C'S" IN STOCK
MINIMUM ORDER: \$25.00

Circle 285 on Inquiry card.

★ HOLIDAY SALE ★

-DRIVES-

Tandon TM100-1 (For IBM) 185⁰⁰
Tandon TM100-2 (For IBM) 265⁰⁰

-TERMINALS-

Televideo 910C 580⁰⁰
Televideo 920C 765⁰⁰
Televideo 925C 770⁰⁰
Televideo 950C 870⁰⁰

-PRINTERS-

NEC 8023A 100CPS Matrix 485⁰⁰
NEW Serial Adapter For 8023A 89⁰⁰
Package-Serial Adapter & 8023A 565⁰⁰

-MONITORS-

NEC 1201 HI Res Green 169⁰⁰
NEC 1202 RGB Color 798⁰⁰

-MODEMS-

Hays Smartmodem (300 Baud) 224⁰⁰
Smartmodem (1200 Baud) 600⁰⁰
Micromodem 100 (S100) 315⁰⁰

Engineering Specialties

1501-B Pine Street
P.O. Box 2233
Oxnard, CA 93030

CALL (805) 487-1665 or 487-1666
For FAST Delivery

Circle 170 on Inquiry card.

☆☆ **SUPER** ☆☆☆
ISA's DATABASE

The only DBMS with all these features:

- ★ PROVEN in one year of test marketing
- ★ TOUGH, reliable file structure
- ★ MENU driven for simplicity and easy use
- ★ ARITHMETIC with stored calculations
- ★ FAST set-up and report formatting
- ★ CLEAR user-oriented documentation
- ★ PRINTS totals & subtotals - mail labels
- ★ REFORMATS and merges data files
- ★ MULTI-DISK files: Up to 128K records
- ★ SORTS full disks on up to 40 fields
- ★ PRODUCTION input of repetitive data
- ★ USE existing data files
- ★ COUPLES to word processors
- ★ POSTS transactions to master file
- ★ SEARCH by strings, ranges, comparisons
- ★ DATA COMPRESSION: Over twice as many labels as the other system

For TRS-80* Models I, II, III, & 16 - 250.00
CP/M† - 295.00

Ask your Dealer or Write:
Institute for Scientific Analysis, Inc.
P. O. Box 7186, Dept. B-2
Wilmington, DE 19803 (215) 358-3735

*T.M. Tandy Corp. †T.M. Digital Research

Circle 209 on Inquiry card.

MICRO-USERS:

**PUBLICATION EXPLOSION
BUGGING YOU?**

Now, up-to-date abstracts of features, hardware/software, book reviews, programs, etc. from popular micro publications.

Search and select YOUR topics of interest. Subscribe to:

Peek

Journal of Micro Abstracts
\$30.00 / 12 months

Send check/MO, name & address to:

Peek

B. Skovronek, Ed.
88 Moraine Road

Morris Plains, N.J. 07950

Systems, business, utility, education, home, technical, and occasionally, games.

Verbatim
flexible disks

Call Free (800) 235-4137 for prices and information. Dealer inquiries invited. C.O.D. and charge cards accepted.

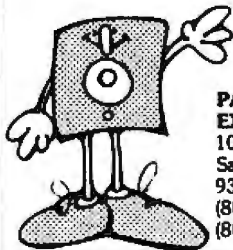

PACIFIC EXCHANGES
100 Foothill Blvd.
San Luis Obispo, CA 93401. In Cal call (800) 592-5935 or (805) 543-1037.

Circle 318 on Inquiry card.

**New Sources of S-100 Buss
Mainframes & Disk
Enclosures**

Power Regulation
meeting previous standards

Ann Arbor Terminals

60 Lines Display
48 Programmable Keys
1,499 prepaid

CALL FOR PRICES

MICRO MIDWEST

10205 W. 69 TERR.
MERRIAM, KS. 66203
913-362-3462

Circle 260 on inquiry card.

STOP LOSING MONEY ON TIME-SHARE SERVICE S

LOGICSIM



CP/M based
professional
logic
simulator

- ★ For engineering work stations
- ★ For gate-array, custom and all other IC designers
- ★ For digital system engineers

Nine logic states, ability to simulate TTL/NMOS/CMOS/PMOS logic, ROM's and RAM's, three-state and transfer gates, window nodes, propagation delays, spike and race analysis, expandable pin-number based TTL macro library plus numerous other features make LOGICSIM comparable to industry standard simulators.

Try it now. Send us a \$30 check for LOGICSIM demo copy and User's Manual.

Please specify 8" IBM 3740/ 5" APPLE II (13/16 sector). CP/M based 56K to 64K systems (APPLE's with CP/M card). Introductory price \$276.

For more information, call (408) 578-8096. Or write:
E/Z ASSOCIATES, 5589 Starcrest Dr., San Jose, CA 95123

APPLE, CP/M, LOGICSIM are trademarks of Apple Computer, Digital Research and E/Z ASSOCIATES

Circle 156 on inquiry card.

*** ADDS ***

VIEWPOINT TERMINALS

\$495

In addition EPI carries printers DEC & DG compatible terminals and modems. Items in stock are shipped within 24 hours. ALL orders shipped COD. All items are new and in factory cartons with manufacturers warranties.

ECONOMY PERIPHERALS INC.

(404) 952-0213

Circle 158 on Inquiry card.

**Expand Your
Networking Capabilities**

With the new ASCE Four Port intelligent switch all your RS-232C networking problems can be solved. Whatever your switching applications the ASCE Switch allows you to switch with ease. Because the switch is intelligent it allows you to change between peripherals from your keyboard. The switch can even be interlocked in your text. When you consider the time you saved due to the simplicity of installation, the elimination of extra cabling and the exclusion of knob turning the ASCE Four Port intelligent switch is the perfect way to expand your networking capabilities.

Advanced Systems Concepts, Inc.
PO BOX 0 - ALTADENA, CALIFORNIA 91001
(213) 793-6971

Circle 11 on inquiry card.

**NEW
LOWER PRICES**

**"THE ORIGINAL BIG BOARD"
OEM - INDUSTRIAL - BUSINESS - SCIENTIFIC
SINGLE BOARD COMPUTER KIT!
Z-80 CPU! 64K RAM!
(DO NOT CONFUSE WITH ANY OF OUR FLATTERING IMITATORS!)**

NEW!

**PARTIALLY ASSEMBLED KITS
For All Sockets Installed
And Soldered Add \$50.
(Not For Blank PCB)**

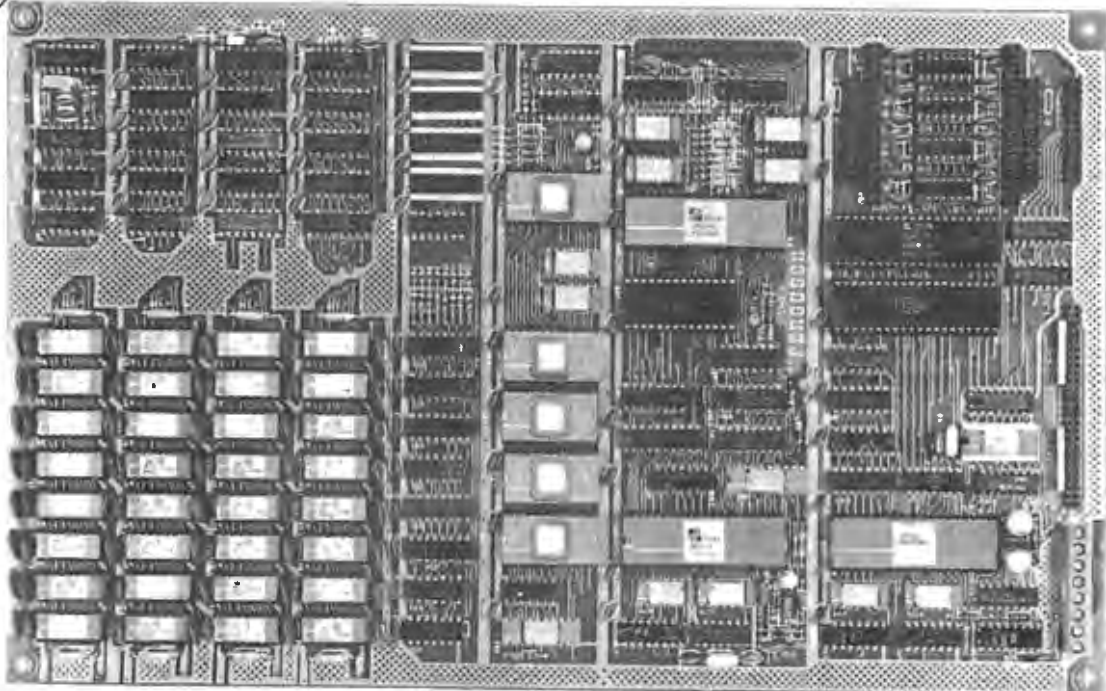

**WANT MORE INFO?
Full Documentation and
Schematics — \$5.**

THE BIG BOARD PROJECT: With thousands sold worldwide and over two years of field experience, the Big Board may just be one of the most reliable single board computers available today. This is the same design that was licensed by Xerox Corp. as the basis for their 820 computer.

The Big Board gives you the right mix of most needed computing features all on one board. The Big Board was designed from scratch to run the latest version of CP/M*. Just imagine all the off-the-shelf software that can be run on the Big Board without any modifications needed.

\$319⁰⁰** (64K KIT BASIC I/O)

SIZE: 8 1/2 x 13 3/4 IN.
SAME AS AN 8 IN. DRIVE.
REQUIRES: +5V @ 3 AMPS
+ - 12V @ .5 AMPS.

FULLY SOCKETED! FEATURES: (Remember, all this on one board!)

64K RAM

Uses Industry standard 4116 RAM's. All 64K is available to the user, our VIDEO and EPROM sections do not make holes in system RAM. Also, very special care was taken in the RAM array PC layout to eliminate potential noise and glitches.

Z-80 CPU

Running at 2.5 MHZ. Handles all 4116 RAM refresh and supports Mode 2 INTERRUPTS. Fully buffered and runs 8080 software.

SERIAL I/O (OPTIONAL)

Full 2 channels using the Z80 SIO and the SMC 8116 Baud Rate Generator. FULL RS232! For synchronous or asynchronous communication. In synchronous mode, the clocks can be transmitted or received by a modem. Both channels can be set up for either data-communication or data-terminals. Supports mode 2 Int. Price for all parts and connectors: \$39.95

BASIC I/O

Consists of separate parallel port (Z80 PIO) for use with an ASCII encoded keyboard for input. Output would be on the 80 x 24 Video Display.

BLANK PC BOARD — \$119

The blank Big Board PC Board comes complete with full documentation (including schematics), the character ROM, the PFM 3.3 MONITOR ROM, and a diskette with the source of our BIOS, BOOT, and PFM 3.3 MONITOR.

24 x 80 CHARACTER VIDEO

With a crisp, flicker-free display that looks extremely sharp even on small monitors. Hardware scroll and full cursor control. Composite video or split video and sync. Character set is supplied on a 2716 style ROM, making customized fonts easy. Sync pulses can be any desired length or polarity. Video may be inverted or true. 5 x 7 Matrix - Upper & Lower Case.

FLOPPY DISC CONTROLLER

Uses WD1771 controller chip with a TTL Data Separator for enhanced reliability. IBM 3740 compatible. Supports up to four 8 inch disc drives. Directly compatible with standard Shugart drives such as the SA800 or SA801. Drives can be configured for remote AC off-on. Runs CP/M* 2.2.

TWO PORT PARALLEL I/O (OPTIONAL)

Uses Z-80 PIO. Full 16 bits, fully buffered, bi-directional. Uses selectable hand shake polarity. Set of all parts and connectors for parallel I/O: \$19.95

REAL TIME CLOCK (OPTIONAL)

Uses Z-80 CTC. Can be configured as a Counter on Real Time Clock. Set of all parts: \$9.95

CP/M* 2.2 FOR BIG BOARD

The popular CP/M* D.O.S. to run on Big Board is available for \$139.00.

BIG BOARD SOFTWARE SPECIAL — \$149

Through special arrangement with CDL we offer a powerful package of 1 TDL Z-80 software that has a suggested retail of almost \$600. Includes: Extended Disk Business Basic, ZEDIT text editor, MACRO II Macro Assembler, LINKER, DEBUG I and DEBUG II. Supplied on 8 in. diskette with extensive manual.

PFM 3.3 2K SYSTEM MONITOR

The real power of the Big Board lies in its PFM 3.3 on board monitor. PFM commands include: Dump Memory, Boo!CP/M*, Copy, Examine, Fill Memory, Test Memory, Go To, Read and Write I/O Ports, Disc Read (Drive, Track, Sector), and Search PFM occupies one of the four 2716 EPROM locations provided. Z-80 is a Trademark of Zilog.

Digital Research Computers
(OF TEXAS)

P.O. BOX 401565 • GARLAND, TEXAS 75040 • (214) 271-3538

TERMS: Shipments will be made approximately 3 to 6 weeks after we receive your order. VISA, MC, cash accepted. We will accept COD's (for the Big Board only) with a \$75 deposit. Balance UPS COD. Add \$4.00 shipping.

USA AND CANADA ONLY

*TRADEMARK OF DIGITAL RESEARCH. NOT ASSOCIATED WITH DIGITAL RESEARCH OF CALIFORNIA, THE ORIGINATORS OF CPM SOFTWARE
**1 TO 4 PIECE DOMESTIC USA PRICE.

Maxell Diskettes



The floppy disks that meet or exceed every standard of quality. Dealer inquiries invited.

Call Toll Free
1-800-237-8931.

In Florida, call
813-577-2794.



Tech Data Corporation
3251 Tech Drive North
St. Petersburg, FL 33702

Circle 403 on Inquiry card.

LOOKING AT PRINTER BUFFERS?

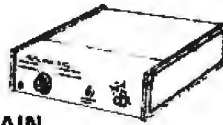

BE CERTAIN...
YOU GET WHAT YOU THINK YOU'RE GETTING:

SPOOL-Z-Q is THE

COMPLETE, NOTHING ELSE TO BUY,
STAND ALONE PARALLEL PRINTER
BUFFER PLUS FEATURES NOT FOUND ON
OTHER BUFFERS SUCH AS:

- SWITCH SELECTABLE "PAUSE ON FORM FEED" MODE, FOR SINGLE SHEET PRINTING
- AUTOMATICSPACE CHARACTER COMPRESSION
- 32K CHARACTERS CAPACITY STANDARD, 64K AND 128K MODELS AVAILABLE. USER EXPANDABLE.
- NO HARDWARE OR SOFTWARE MODIFICATIONS REQUIRED.
- AND MUCH MORE. WRITE OR CALL FOR FULL DETAILS.



PRICE (32K INCLUDES CABLE) \$279.95

JVB ELECTRONICS

1801 Fulton Avenue, Suite 1
Sacramento, California 95825
Phone: (916) 483-0708

DEALERS INQUIRY INVITED

Circle 223 on inquiry card.

NEW!! The Apple users group software library bonanza at truly affordable prices. For the first time enjoy your Apple to its fullest capacity using specially packed disks with over 80 outstanding programs each. Not available from any other source!

• Applesoft • 3.3 DOS

PROGRAMS \$1-EACH

APPLEWARE INC. offers
An extensive variety of interesting, useful and entertaining programs indispensable to the serious computerist including:

Business	Educational	Graphics
Games	Music	Science
Utilities	Data Base	Finance

Library disks 1, 2 & 3 are mixed categories and new disks 4 (Games), 5 (Utilities), 6 (Graphics) & 7 (Integer) at \$59.95 each. Why pay more?

Order direct from this ad and save up to \$136. Buy disk library package 1, 2 & 3 and get a special bonus disk FREE — over 260 programs for \$179.95 + shipping. For best value, get all 8 disks for \$349, postage prepaid, for over 530 of our best programs at 65¢ each! Call now toll free: 1-800-327-8664

Florida: 1-305-987-8665
6400 Hayes St.
Hollywood, FL 33024



Circle 27 on inquiry card.

C LANGUAGE PROGRAMMERS

c-systems
C COMPILER

Now with: **c-window™**

The first c language source level program testing and debugging tool.

- Single step by c source line.
- Set breakpoints at line numbers.
- Display and alter variables by symbol name, using c expression syntax.
- No more printf or assembler level debugging!

c-window™ is a support package for the **c-systems C COMPILER** for 8086/8088 based systems.

Contact:

c-systems Fullerton, CA 92634
P.O. Box 3253 714-637-5362

TM c-systems

Circle 66 on Inquiry card.

Atlantic Cabinet Computer Furniture



- A complete range of quality work stations designed specifically to house all micro-computers.
- Delivered heavily packed, in self-assembly form needing only a Phillips screwdriver and a few minutes of your time to assemble.
- Manufactured from 1" all wood particle board surfaced with hard-wearing melamine veneer, in Oak or Walnut.
- Dealer and Distributor inquiries welcome.
- For more information, contact your local dealer, write or call Atlantic Cabinet (301) 223-8900.

ATLANTIC CABINET CORPORATION
P.O. Box 100, Williamsport, Maryland 21795

Circle 37 on inquiry card.

DISCOUNT DRIVES

Apple II Disk Drives	\$285.00
Controller	\$90.00
Tandon TM100-2 5 1/4"	
d/s TRS-80	\$249.00
Tandon TM100-4 5 1/4"	
d/s Zenith	\$319.00
Tandon TM848-1 8"	\$355.00
Tandon TM848-2 8"	
thinline d/s	\$417.00
Tandon TM603 10 MB Wini	\$899.00
Tandon TM603E 14.2 MB Wini	\$995.00
SASI Interface	\$125.00
Xebec Controller	\$349.00

Elephant floppy disks ss/sd \$17.95 (box of 10)
"ALL floppies discounted & 100% guaranteed"

WHOLESALE SUPPLIERS

Div. B.O.S.S. Inc.

P.O. Box 22428 Carmel, CA 93922
Call (408) 373-0320

Circle 435 on inquiry card.

GAME DESIGNER

HAVE YOU HEARD ABOUT
THE FROB™

The Game Development System
For the Atari® VCS™
Now Available for
the Atari 5200 HES™

It allows just about anyone the opportunity to design home video cartridges for the Atari game consoles.

The Miracle of Creation Can be Yours™



Call: 408-429-1552
or write: Frobco P.O. Box 2780
Santa Cruz, CA 95063

Circle 325 on Inquiry card.

SYSTEM/Z'S BASIC/Z

A New COMPILED Basic for CP/M or MDOS

- No Royalties - No Run-time Charges
- Generates machine code (8080/Z80)
- Sort Verb - 2000 elements in 2 seconds
- Alpha-numeric Labels
- Chain with Common
- BCD Floating Point Math to 18 Digits
- Editor Tests Syntax As You Type
- Recursive, Multi-line, User Functions
- Dynamically Dimension Arrays
- Selectively Erase Arrays
- Trace and Single-step debugging
- Multi-tiered Error Trapping
- Cursor Addressing, Reverse and Blinking Video

Want to see how it works?
Get DAMAN's Mail-List program for \$30 BASIC/Z run-time packages are included.

Just want further info?
Call or write for free BASIC/Z brochure and mini-manual
BASIC/Z lists for \$345, but from DAMAN it's:
\$312 Post Paid to North America
VISA and Master Card Accepted, COD available or \$298 with cash discount (cash, check, money order)

Add \$7 for airmail shipment outside N. America
Specify 8" Microp/Vector Graphic, Apple, Osborne,
NEC, N. Star
Full BASIC/Z Documentation \$35 (credited to full order)

Suite 14-04
3322 Mem
Parkway, S.W.

daman

(205) 883-8113
Huntsville
Alabama 35801

Circle 134 on inquiry card.

Get Smart!



Get Your Computer An
Automatic Port Selector
(ASU-3)

Our ASU-3 will connect your CPU or CRT to any one of 3 peripherals. Just enter a command from your keyboard and the desired peripheral is automatically connected. Also available for 5 and for 7 peripherals. The baud rate is set automatically. Many options are available. The only low cost, smart switch on the market.

SWITCH TO GILTRONIX.

GILTRONIX, INC.
UNIVERSAL INTERFACE PRODUCTS

978 San Antonio Rd., Palo Alto, CA 94308 Call (415) 433 1300

Circle 185 on inquiry card.

THE COMPUTER SPECIALISTS

IBM®



IBM® PC OUTFIT

System unit with 64K, 2 double-sided double-density Disk Drive 640K, Monochrome display & printeradapter, DOS, Disk Drive controller

Call or Write

SOFTWARE & ACCES.

- IBM Orig. 5 1/4" Disk SS/DD pk. of 10 34.95
- IBM Orig. 5 1/4" Disk DS/DD pk. of 10 49.95
- TANDON DS/DD Disk Drive 320K 279.95
- IBM is a registered trademark of IBM, Inc.
- BIG BLUE CPM Card 469.95
- QUADRAM Parallel printer card 129.95
- QUADRAM 129.95
- QUAD Board 64K 449.00
- QUAD Board 256K 749.00
- MICROSOFT RAM Card 64K 279.95
- 256K 629.95
- VISICALC/256K 185.00
- SUPERCALC 209.95
- VISITREND/VISIPLOT 239.95
- VISIDEX 184.95
- VISIFILE 239.95
- CURTIS PC Pedestal for Monochrome Display 69.95
- POWER TEXT Word Proc 299.95
- PEECH TREE Accounting GL, AP&AR 3-pk. 469.00

FRANKLIN®



ACE 1000

Hardware and software compatible w/Apples® II plus™ 64K RAM, Upper & lower case, 12-key numeric keypad, Built-in fan, Type-writer style keyboard

Franklin ACE 1000 64K, Disk Drive with Controller, 12" Hi Res Green Monitor, ACE writer

1 year extended warranty

Call or Write

Apple II® plus 64K Super Outfit

Apple II® plus 48K, 16K memory expansion card, Apple disk drive II with interface DOS 3.3, Apple III 12" monitor, Apple writer, Apple monitor stand 101 ready-to-run programs,

PLUS:

You get these **FREE** softwares, Apple Stellar Invaders Value \$29⁰⁰ Olympic Decathlon Value \$35⁰⁰

Only **\$1779⁹⁹**
1 year extended warranty

apple®



WORD PROCESSOR SYSTEM

Apple II plus 48K, 16K mem. expansion, Apple Disk Dr. w/interface DOS 3.3, 12" Hi Res Green Monitor, OKIDATA 80 Printer, Interface Card & Cable, Screenwriter II

Only **\$2249⁰⁰**

SOFTWARE & ACCESSORIES FOR APPLE® and FRANKLIN®

RANA
Elite 1 Disc Drive, 15% more storage than Apples' w/controller Only **\$409⁵⁰**

MICRO SCI
A-2 Disc Drive, the cost effective alternative to the Disc II, with controller Only **\$389⁹⁵**
without controller Only **299.95**

KENSINGTON
System Saver Fan, with built-in surge protector for Apple® II Only **\$74⁹⁵**

MICRO PRO Special Offer!
Word Pack Includes WordStar, MailMerge, and SpellStar All 3 for Only **\$329⁰⁰**

NOVATION
Apple Cat II, direct line modem Only **\$299⁹⁵**
Apple Cat II, 212 Upgrade Only **\$329⁹⁵**
Auto Cat 1200 Only **\$589⁹⁵**
Apple is a registered trademark of Apple Computer, Inc.

VISICORP PROGRAMS

- Visicalc \$184⁹⁵
- Visiplot \$239⁹⁵
- Visidex \$184⁹⁵
- Desktop Plan II \$194⁹⁵
- Visifile \$184⁹⁵
- Visiterm \$79⁹⁵
- Visischedule \$239⁹⁵

ADDITIONAL "ADD-ONS"

- DC HAYES Micromodem II \$284⁹⁵
- VIDEX Keyboard Enhancer II \$119⁹⁵
- VIDEX Videoterm 80 Col. Board \$259⁹⁵
- VIDEX Function Strip (f/use w/Enhancer II) \$62⁹⁵
- TKC Numeric Keypad (Apple® only) \$134⁹⁵
- ABT Numeric Keypad (Apple® only) \$99⁹⁵
- THUNDERCLOCK PLUS \$119⁹⁵
- PKASO Parallel interface \$134⁹⁵
- MICROSOFT Z-80 CPM Card \$249⁹⁵
- MICROSOFT 16K Ram Card \$89⁹⁵
- TG Joystick \$47⁹⁰ KRAFT Joystick \$44⁹⁵

VOTRAX TYPE-N-TALK

Lets your computer talk to you Only **\$199⁹⁵**
Available for Apple/Franklin/Atari/NIC-20

NEW! APPLI CARD
Z-80 Card w/64K RAM 4 mhz Only **\$349⁹⁵**

FORMAT II WORD PROCESSOR
with mail list, user friendly... Only **\$199⁹⁵**

MICROSOFT PREMIUM PACK
Z-80 CPM Card, VIDEX Videoterm 80 Col. board, CPM user's guide & MICROSOFT RAM Card
All for only **\$509⁹⁵**

Plus you receive a FREE VidexSoft Switch (a \$30 Value!)

MICROBUFFER II by Practical Peripherals
32K... Only **\$249⁹⁵** 16K... Only **\$214⁹⁵**

MICROBUFFER for EPSON
16K Parallel **\$134⁹⁵** 8K Serial **\$134⁹⁵**

Franklin ACE is a trademark of Franklin Computer Co.

COMPUTER SPECIALS!

TEXAS INSTRUMENTS
TI 99 4/A with RF Modulator ... \$199⁹⁵
After Mfg's Cash Rebate, Plus 2 FREE offers from TI Call or Write for details!

COMMODORE
VIC-20 with RF Modulator \$177⁹⁰
RCA VP-3501 built-in modem \$329⁹⁵
ATARI 400 Call
TIMEX Sinclair 1000 \$89⁹⁵
48K Memory 49.95 32K Memory 99.95

SHARP (Handheld)
PC-1500 with CE-150 Printer \$299⁹⁵
PC-1211 with CE-122 Printer \$109⁹⁵

hp HEWLETT PACKARD

HP-83A \$1149 ⁹⁵	HP Accessories
HP-85A \$2099 ⁹⁵	82901M 5 1/4" Dual Disc Drive \$1894 ⁹⁵
HP-87A w/128K \$2394 ⁹⁵	82905A Serial Printer \$189 ⁹⁵
HP-87 XM \$2495 ⁹⁵	HP-7470A Graphics plotter
HP-125 \$2099 ⁹⁵	also avail. in Serial II/Apple® Franklin® and IBM® \$1185 ⁹⁵

DISKETTE SPECIALS!

- (10 pk except where indicated)
- MAXELL MD-1 SS 5 1/4" 34.95
 - MAXELL MD-2 DS/DD 5 1/4" 49.95
 - MAXELL FD-2 DS/DD 8" (Soft Sector) 59.95
 - VERBATIM SS/DD 5 1/4" 31.95
 - VERBATIM DS/DD 5 1/4" 46.50
 - MEMOREX SS/DD 5 1/4" 23.95
 - CONTROL DATA SS/DD 5 1/4" (12 pk) 25.95
 - NEW! IBM SS/DD 5 1/4" 34.95
 - NEW! IBM DS/DD 5 1/4" 49.95

For quantity discount prices please call or write!

PRINTERS

NEC

New! 3550 Letter quality printer for IBM PC, Auto proportional spacing, Bidirectional, Bold & shadow printing, Justification, Centering, Underscoring, Sub/verscripting, 35 CPS, 2099.50
8023 Pro writer. 100 CPS, 136 Column, Parallel, Bidirectional, Tractor & friction. High resolution graphics 514.95

SMITH CORONA TP-1 Letter quality Daisy wheel printer. Serial or Parallel interface, 120 words per minute 629.00

OKIDATA

MICROLINE 82A 120 CPS, Bidirectional, Parallel-Serial, 80/132 Columns, Friction & Pin Feed 429.95

MICROLINE 83A F/T 120 CPS, Bidirectional, 136 Columns, Serial/Parallel, Friction and Tractor 684.95

EPSON

MX-80 III F/T 80-136 Column Dot Matrix, Tractor or Friction Feed, Bidirectional, 80 CPS, Graffrax Plus Call
MX-100HIF/T 136-233 Column, Tractor or Friction Feed, Bidirectional, 80 CPS, Graffrax Plus Call

MONITORS

- USI PI-2 12" High Res. Green 159.00
 - USI PI-3 12" High Res. Amber 189.00
 - AMDEK 300 12" Green 149.95
 - AMDEK 13" Color I 329.00
 - AMDEK Color II RGB High Res. 699.95
 - AMDEK Color Interface Board II/RGB 159.00
 - NEC JC 12" Color 349.95
 - EPSON CR-6500 12" Color 309.95
- ELECTROHOME**
ECM-1302-1 13" RGB Monitor Hi-Res. with NTSC Interface 399.95
1302-2 High Res. RGB 599.95
COLOR BOARD for APPLE® II 199.95

OSBORNE



DOUBLE-DENSITY

With Wordstar, Mailmerge, Supercalc, C Basic and M Basic.

Call for Low Price!

Software & Accessories

- X-MON monitor adapter 39.95
- CENTRONIX printer cable 59.95
- Keyboard extender cable 4 ft. 49.95
- RS232 Serial cable 39.95

Games for Osborne

- Velor 20.00
- Star Trek 15.00
- Trapper 15.00
- Catacomb 18.00

ATARI



WORD PROCESSOR

Atari 800 48K, Atari 810 Disk Drive, Atari Word Processor, 850 Interface, Okidata Microline 82A Printer with Connecting Cables

Call or Write

Atari 800 48K complete with a 13" color TV
Call or Write

CORPORATE ACCOUNTS WELCOME

(212)260-4410

TOLL FREE OUT-OF-STATE

800-221-7774
800-221-5858

67 West 47th Street, New York, N.Y. 10036
115 West 45th Street, New York, N.Y. 10036
MAIL ORDER ADDRESS: 36 E. 19th St. New York, N.Y. 10003

47st Computer
Computers and Business Equipment
A Division of 47st Photo Inc.



Items on sale for limited time only, and are subject to limited availability. Not responsible for typographical errors. This ad supersedes all other ads prior to Feb. 1983. Prices effective as of Dec. 22, 1982 and are subject to change without notice. All orders subject to verification and acceptance. Minimum shipping and handling \$4.95

Four (as in Quad) Function IBM PC Board



- Up to 256KB of Parity Memory
- Async Communication Port
- Clock-Calendar with Battery Back-up
- Allows Full 1 Megabyte Addressing
- One Year Warranty
- Parallel Port can be added for an extra \$50
- Free Software — Super Disk and Super Spooler

ORDER **64K . . . \$359**
TOLL FREE 128K \$419
192K \$469
FREE SHIPPING 256K \$569

(800) 531-5475 (if outside of Texas)
(512) 250-1523 (if in Texas)

CompuAdd Corp.
13010 Research Blvd. No. 218
Austin, Texas 78750

Circle 86 on inquiry card.

5 1/4" Tandon Drives

- **TM 100-1** \$189
(single sided, 40 TRK, single or double density) Free Shipping
- **TM 100-2** \$259
(double sided, 40 TRK/side single or double density) Free Shipping
- **TM 100-4** \$349
(double sided, 80 TRK/side 96 TPI, double density) Free Shipping

ORDER — TOLL FREE

1-800-531-5475 (If outside of Texas)
(512) 250-1523 (If inside of Texas)

"If we can't ship the next working day,
we won't take the order."

Master Card/Visa or check.
Texas Residents add 5% sales tax.

CompuAdd Corp.
13010 Research Blvd - # 218
Austin, Texas 78750

Circle 87 on Inquiry card.

SMITH-CORONA TP-1

Letter Quality Daisy Wheel Printer



- SERIAL OR PARALLEL INTERFACE
- MICROPROCESSOR ELECTRONICS

ORDER TOLL FREE **\$569**
FREE SHIPPING

(800) 531-5475 (if outside of Texas)
(512) 250-1523 (in Texas)

CompuAdd Corp.
13010 Research Blvd. No. 218
Austin, Texas 78705

Circle 88 on inquiry card.

Verbatim®

Floppy Discs
CALL NOW — TOLL FREE
1-800-328-DISC

Dealer inquiries invited. C.O.D.'s and charge cards accepted.

All orders shipped from stock, within 24 hours. Call toll FREE.



North Hills Corporation

3564 Rolling View Dr.
White Bear Lake, MN 55110
1-800-328-DISC
MN Call Collect 1-612-770-0485

Circle 302 on Inquiry card.

ELIZA IS HERE!

AT LAST! A FULL IMPLEMENTATION of the original ELIZA program is now available to run on your microcomputer!

Created at MIT in 1966, ELIZA has become the world's most celebrated artificial intelligence demonstration program. ELIZA is a non-directive psychotherapist who analyzes each statement as you type it in and then responds with her own comment or question — and her remarks are often startlingly appropriate!

Designed to run on a large mainframe, ELIZA has hitherto been unavailable to personal computer users except in greatly stripped down versions lacking the sophistication which made the original program so fascinating.

Now, our new microcomputer version possessing the FULL power and range of expression of the original is being offered at the introductory price of only \$25. And if you want to find out how she does it (or teach her to do more) we will include the complete Source Program for only \$20 additional.

Order your copy of ELIZA today and you'll never again wonder how to respond when you hear someone say "Okay, let's see what this computer of yours can actually do!"

ELIZA IS AVAILABLE IN THE FOLLOWING DISK FORMATS:

- 1 Standard 8 inch single density for all CP/M based computers. \$25 for ELIZA.COM - add \$20 for Microsoft BASIC-80 Source
- 2 5 1/4 inch CP/M for Apple II equipped with Z-80 SoftCard \$25 for ELIZA.COM - add \$20 for Microsoft BASIC-80 Source
- 3 5 1/4 inch for 48K Apple II with Applesoft ROM and DOS 3.3 \$25 for Protected File - add \$20 for Applesoft Source
- 4 5 1/4 inch for 84K IBM Personal Computer. \$25 for Protected File - add \$20 for IBM Disk BASIC Source
- 5 5 1/4 inch for Osborne I Microcomputer. \$25 for Protected File - add \$20 for Microsoft BASIC-80 Source

ARTIFICIAL INTELLIGENCE RESEARCH GROUP

921 NORTH LA JOLLA AVENUE
LOS ANGELES, CALIFORNIA 90046
(213) 658-7368 (213) 854-2214
MC, VISA and CHECKS ACCEPTED

Circle 32 on Inquiry card.

wabash®

When it comes to Flexible Disks, nobody does it better than Wabash.

MasterCard, Visa Accepted.
Call Free: (800) 235-4137

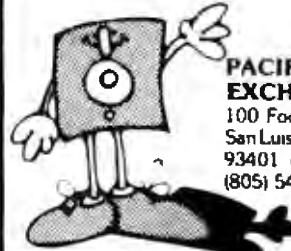

PACIFIC EXCHANGES
100 Foothill Blvd
San Luis Obispo, CA
93401 (In Cal call
(805) 543-1037)

Circle 318 on Inquiry card.

ANALOG ↔ DIGITAL DIGITAL ↔ ANALOG

CONVERSION MODULES
SOFTWARE
GAIN CONTROL

High accuracy programmable gain instrumentation amplifier — custom board test — \$100 — 9 to 15 kHz conversion time — miscable high and low inputs — gain from 1 to 1024 — 12 bit — sample and hold amplifier 8-channel differential — 16-channel — analog to digital high accuracy — programmable gain instrumentation amplifier — custom board test — \$100 — 9 to 15 kHz conversion time — miscable high and low inputs — gain from 1 to 1024 — 12 bit — sample and hold amplifier 8-channel differential — 16-channel — analog to digital high accuracy — programmable gain instrumentation amplifier — custom board test — \$100 — 9 to 15 kHz

For additional details about the AD-100-4 and other Fine California Data Corporation 100% individually tested, high reliability products, circle the reader service card number below or for faster response write or call us.

CALIFORNIA DATA CORPORATION
3475 Old Conejo Road, Suite C-10
Newbury Park, CA 91320
(805) 498-3651

Circle 68 on Inquiry card.

IBM® PC SOFTWARE

FORTH-32™ allows access to all of the PC memory using intermixed 16/32 bit addressing. Screen editor, assembler, decompiler, debug, graphics, CASE, and DOS interface. Package Builder Utility produces compact, marketable software. \$150. Floating Point Library (Software or 8087). \$50.

QUESTalk™ Asynchronous Communications connects your PC to other computers. Menu driven with help feature. Terminal or local mode. UPLOAD/DOWNLOAD file transfers. Multiple BAUD rates. \$45.

PrintPak™ allows customized printouts via menu driven selection of page headers, line numbers, character type, time, date and more. \$45.

DiskPak™ recovers erased files, prints, views and modifies sectors and more. \$35.

Edlin Recovery Utility reclaims the file you thought you lost when the disk was full. \$35.

QUEST IS A REGISTERED TRADEMARK OF CALIFORNIA DATA CORPORATION. FORTH-32, QUESTalk, PRINTPAK, DISKPAK, AND EDLIN ARE TRADEMARKS OF OUR



QUEST RESEARCH, INC.

PO Box 2553 • Huntsville, AL 35894 • 205-533-9405
Toll Free 800-558-8088

Circle 358 on inquiry card.

EDGE-86 AN INDUSTRIAL QUALITY 8086 OEM SYSTEM

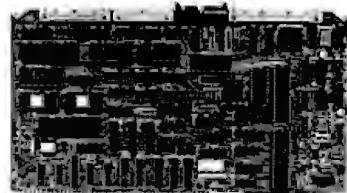

- **HARDWARE**
 - A Multibus® COMPATIBLE 8086 CPU BOARD WITH DMA FLOPPY CONTROLLER, INTERRUPT CONTROLLER, PROGRAMMABLE TIMERS, 3 SERIAL PORTS, TWO PARALLEL I/O PORTS, AND 8K BYTES OF PROM WITH BOOT STRAP LOADER FOR CP/M/86™.
 - 128K BYTES DYNAMIC RAM BOARD.
 - 4-SLOT MULTIBUS CARD CAGE, WITH COMPLETE DOCUMENTATION AND SCHEMATICS; ALL FOR . . . \$1250.
- **SOFTWARE**
 - CP/M/86.0.S WITH COMPLETE UTILITIES . . . \$250.
 - OFF THE SHELF DELIVERY

EDGE MICRO SYSTEMS
195 W. EL CAMINO REAL, SUNNYVALE, CA 94086
TELEPHONE: 408-738-4729

* Multibus TM of Intel. 1MCP/M86 TM of Digital Research

Circle 160 on inquiry card.

We Have It!.. Computers, Disk Systems, Printers and Terminals

**Call For Super Value
On S-100 System With
Dbl. Dens. 8" Drives!**

INTERTEC SUPERBRAIN II FREE MicroSoft Basic 80

Self contained computer with dual disks and two SR232C ports, complete with CP/M® 2.2

64K Jr.....	\$2099
64K QD.....	\$2495
64K SD.....	\$2949
10 Meg. DDS Hard Disk.....	\$2995

VIDEO TERMINALS

SOROC IQ 120.....	\$595
SOROC IQ 130.....	595
HAZELTINE ESPRIT.....	Call
HAZELTINE ESPRIT II.....	Call
HAZELTINE 1420.....	Call
HAZELTINE 1500.....	Call
HAZELTINE 1510.....	Call
HAZELTINE 1520.....	Call
TELEVIDEO 910C.....	Call
TELEVIDEO 912C.....	Call
TELEVIDEO 920C.....	Call
TELEVIDEO 925C.....	Call
TELEVIDEO 950C.....	Call
TEXAS INSTRUMENTS 940 Basic.....	\$1299
TI 940 Package.....	\$1699
TI 745 Portable Terminal.....	1249
INTERTEC INTERTUBE III.....	749
ZENITH Z19.....	729

PRINTERS

ANADIX DP-9001A.....	\$1369
ANADIX DP-9501A.....	1429
PAPER TIGER IDS-445G.....	Special! 599
PRISM PRINTER IDS-80 w/o color.....	1149
PRISM PRINTER IDS-80 w/color.....	1499
PRISM PRINTER IDS-132 w/color.....	1695
NEC 3510 RO, RS232C, 35 CPS.....	Now 1619
NEC 3530 RO, Cent. Inter., 35 CPS.....	Only 1859
NEC 7710 RO, RS232C, 55CPS.....	2375
NEC 7720 KSR, RS232C, 55CPS.....	2795
NEC 7730 RO, Cent. Inter., 55CPS.....	2375
QUME SPRINT 9/45	

Ltd. or Full, 45CPS, RS232C, Now 1998

C. ITOH PRO WRITER, Parallel.....	549
C.ITOH PRO WRITER, Ser. & Par.....	649
DIABLO 620 RO, RS232C, 20 CPS.....	1249
DIABLO 630 RO, RS232C, 55CPS.....	2299
CENTRONICS 730-1 Par.....	Now Low 299
CENTRONICS 737-3 RS232C.....	389
CENTRONICS 704-11 Parallel.....	1695
CENTRONICS 704-9 RS232C.....	1595
CENTRONICS 122G Parallel, 120CPS.....	949
EPSON MX-80.....	489
EPSON MX-80FT.....	589
EPSON MX-100FT.....	789
EPSON RS232 Serial Interface.....	65
EPSON RS232/2K Buffer Interface.....	129
EPSON GRAFTRAX II.....	90
EPSON Apple® Printer Interface.....	75
TEXAS INSTRUMENTS TI 810 Basic.....	1349
TI-810 Basic RS232C & Parallel.....	1395
TI-810 w/full ASCII, Vert. forms control, compressed print.....	1599
TI-820 RO Basic.....	1645
TI-820 KSR Basic.....	1839
TI-810 Package w/LQ.....	2099

OKIDATA MICROLINE-80.....	359
Tractor feed option.....	50
MICROLINE 82A.....	459
MICROLINE 83A.....	729
MICROLINE 84 Parallel.....	1149
MICROLINE 84 Serial.....	1249

MONITORS

ZENITH ZYM-121, 12" Green Phos.....	115
AMDEK 100 12".....	Now Low! 99
AMDEK 100G 12" Gr. Phos.....	149
AMDEK 300 12" High Res.....	179
AMDEK COLOR-1, 13".....	339
AMDEK COLOR-II, 13" GRB Hi. Res.....	755
AMDEK COLOR-III, 13" RGB.....	419
APPLE® Adapter for RGB.....	159

NorthStar
Call For Prices

FLOPPY DISK SYSTEMS

MORROWDISCUS 2D Sng. DD.....	898*
MORROW DUAL DISCUS 2D DD.....	1549*
MORROW DISCUS 2 + 2, 2 side, DD.....	1239*
MORROW DUAL DISCUS 2 + 2.....	2139*
MORROW DUAL DMA DISCUS 2D.....	1619*

HARD DISK SUBSYSTEMS

MORROW DESIGNS	
DISCUS M5, 5 Meg.....	Now Low 1559*
DISCUS M 10, 10 Meg.....	3095*
DISCUS M26, 26 Meg.....	3795*
CORVUS 5 Meg.....	2375
CORVUS 12 Meg.....	2969
CORVUS 18 Meg.....	3799
MAEZON 5 Meg.....	1695
MAEZON 10 Meg.....	1949
MAEZON 15 Meg.....	2799
INTERTEC 10 Meg.....	Special! 2999

*Includes CP/M® 2.2 and MicroSoft Basic.

FLOPPY DISK

CONTROLLER BOARDS

CROMEMCO 16 FDC, DD.....	499
NORTH STAR DD.....	479
MORROW DISK JOCKEY 2D, A&T.....	329
INTERSYSTEMS FDC-2, A&T.....	439
TARBELL DD, A&T.....	445
SYSTEMS GROUP DD, DMA.....	439

ESCON CONVERSION FOR IBM ELECTRIC

Complete w/microprocessor controller and power supply. Factory built. User installs solenoid assembly or it can be done at the ESCON factory.

RS232C Serial & Parallel.....	534
Cable for above.....	25

PROM PROGRAMMERS

SSM PB1 Kit.....	152
SSM PB1, A&T.....	225

MODEMS

NOVATION CAT, Acoustic.....	149
D-CAT, Direct Connect, (300 Baud).....	155
AUTO CAT Auto Answer.....	219
APPLE CAT.....	329
D-CAT (1200 Baud).....	599
103 JLP Auto Answer.....	219
DC HAYES MICROMODEM II (Apple).....	339
HAYES SMART MODEM (300 Baud).....	239
HAYES SMART MODEM (1200 Baud).....	595
POTOMAC MICRO MAGIC (S-100).....	339

CALIFORNIA COMPUTER SYSTEMS

Z80 CPU Board.....	269
Disk Controller 2422, w/CP/M®.....	359
16K Static, A&T.....	259
32K Static, A&T.....	399
64K Dynamic RAM.....	335
SYSTEM 2210 w/64K, CP/M® 2.2.....	1895

CPU BOARDS

(Assembled unless noted)

NORTHSTAR Z-80 (ZPB, A/A).....	269
INTERSYSTEMS (MPU-80).....	349
SSM CB1 8080, A&T.....	214
SSM CB2, Z-80 A&T.....	289
SSM CB2, Z-80 Kit.....	219
SYSTEMS GROUP Z-80 with I/O.....	419

MEMORY BOARDS

NORTHSTAR 16K RAM.....	199
H-RAM 64K.....	589
H-RAM 32K.....	419
CROMEMCO 16KZ.....	419
CROMEMCO 64KZ.....	595
CROMEMCO 256KZ.....	1095

MEMORY MERCHANT

16K Static, 4 MHz.....	159
64K Static, 4 MHz.....	549

SYSTEMS GROUP

DM6400, 64K Board.....	529
DMB6400, 64K Board.....	420
HDM2800, 128K Board.....	1095

GODBOUT (A&T)

CPU-Z.....	249
CPU 8085 88.....	359
RAM 20 32.....	359
RAM 17 64.....	510
RAM 21.....	1149
INTERFACE 1.....	215
INTERFACER 1.....	215
INTERFACER 2.....	215
DISK 1.....	425
SYSTEM SUPPORT 1.....	335
ENCLOSURE 2 (Desk).....	699
ENCLOSURE 2 (RACK).....	759

VIDEO BOARDS w/o Mapped

SSM VB2 I/O, Kit.....	169
SSM VM2 I/O, A&T.....	229
Memory Mapped	
SSM VB1C, 16x64, Kit.....	152
SSM VB1C, 16x64, A&T.....	206
SSM VB3, 80 Char. 4MHz, Kit.....	359
SSM VB3, 80 Char. 4 MHz, A&T.....	419

APPLE® BOARDS

CALIFORNIA COMPUTER

7710A Asynchronous Ser. Inter.....	139
7712A Synchronous Ser. Inter.....	149
7424A Calendar Clock.....	99
7728A Centronics Printer Inter.....	99

**Call for price on MORROW
MICRO DECISION and
CROMEMCO SP-10**

**We stock a complete inventory
of MAXELL, MEMOREX,
SCOTCH and VERBA TIM for all
your Diskette requirements.**

Write for free catalog.

MiniMicroMart, Inc.

943 W. Genesee St.
P.O. Box 2991 B
Syracuse, New York 13220

(315) 422-4467

TWX 710-542-0431



All prices F.O.B. shipping point, subject to change. All offers subject to withdrawal without notice. Advertised prices reflect a 2% cash discount (orders prepaid prior to shipment). C.O.D.'s & Credit Cards, 2% higher.

TeleVideo™ USERS!

- COGITATE Fast Dump/Restore System for TS 802H, 806.**
- Back-up files twice as fast as PIP.
 - Double the storage, up to 700K/diskette, with multiple diskette capability **\$90.00**
- COGITATE Type Ahead With Print Screen**
- Print key prints screen.
 - 64 character typeahead buffer **\$90.00**
- COGITATE 2780/3780 Communications System.**
- Communicates with most IBM systems.
 - Many features for remote job entry **\$400.00**
- TurboDOS**
- MULTI-USER **\$750.00**
 - SEMINARS **\$250.00**
- CP/M® is registered trademark of Digital Research, Inc.
TurboDOS is a registered trademark of Software 2000, Inc.
PLUS OTHER GOOD TELEVIDEO STUFF!

COGITATE, Inc.

SPECIALISTS IN UNIQUE TELEVIDEO SOFTWARE
24000 Telegraph Road, Southfield, MI 48034
(313) 352-2345
VISA/MASTER CARD Accepted

Circle 76 on Inquiry card.

DISKETTES AND DISKETTE DUPLICATION

DISKETTES (Hub Ring/Write Protect)

Certified 100% error free

	Box of 10
5 1/4" Single Side/Single Density	\$17.50
Single Side/Double Density	20.00
Double Side/Double Density	24.00
8 Single Side/Single Density	20.00
Single Side/Double Density	25.50
Double Side/Double Density	30.00

Specify soft. 10 or 16 sector on 5 1/4" diskettes
Shipping \$1.50 (Cal. add tax)
Money Order/VISA/MasterCard/C.O.D.

DUPLICATION

- Duplication services — all popular formats
 - All services performed on latest technically advanced equipment
 - Prices start at \$1.90, including diskette
- Please write for full description of all Hoffman services and prices.

Hoffman
COMPUTER PRODUCTS
1720 FLOWER AVE. QUARTER, CA 91010
(213) 303-1571

Circle 197 on Inquiry card.

QUALITY QUANTITY PRINTER KIT! LETTER QUALITY PRINTER KIT! LETTER QUALITY PRINTER KIT!

From **\$200.** Do It Yourself & SAVE!
FOR THE OLIVETTI PRAXIS® 30 & 35
ELECTRONIC OFFICE TYPEWRITERS
Full KSR with RS-232 Serial/Parallel Comb.
or Centronics Compatible Parallel Only.

COMPARE... THEN CALL

(615) 727-6000
SYSTEMED CORPORATION
P.O. Box 18, Mountain City, TN 37683

Circle 399 on inquiry card.



BASF FlexyDisks®

5 1/4"

Specify soft,

10 or 16 sector	Price/10	Price/100
1 side/double density	\$20.00	\$185.00
2 sided/double density	34.50	325.00

8"

Specify soft

or 32 sector	Price/10	Price/100
1 side/single density	\$21.00	\$195.00
1 side/double density	29.50	275.00
2 sided/double density	34.50	325.00

Certified Check - Money Order - Personal Check
Allow up to 2 weeks for personal checks to clear.
Add \$1.50 to each order for U.P.S. shipping charges.
NJ Residents add 5% NJ Sales Tax

DATA
EXCHANGE, INC.

280 Dukes Parkway, P.O. Box 85
Somerville, N.J. 08876 • (201) 725-6680

Dealer Inquiries Invited

Circle 139 on Inquiry card.

\$99 SINGLE BOARD COMPUTER/CONTROLLER

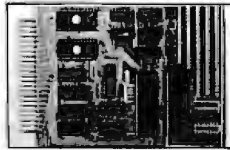

MODEL MCG-85 FEATURES:

- 8085A CPU
- 2K System Monitor ROM
- 256 Bytes of RAM
- RS232C Port
- Parallel & Serial I/O
- Two 8 Bit Prog Ports
- One 6 Bit Prog Port
- 4 1/2 x 6 1/2 PCB
- Automatic Baud Rate
- 5 Interrupts
- 14 Bit Counter/Timer
- Onboard Prototyping
- 6.144 MHz Crystal
- Onboard Expansion
- *4K ROM &/or
- *4K RAM or CMOS RAM

STOCK \$99 Kit \$135 A&T.

Expansion Boards available. Visa, M.C., Amex & COD accepted.

ATLANTIS COMPUTERS

31-14 Broadway
Astoria, N.Y. 11106
212/728-6700

Circle 38 on Inquiry card.

CALL 800-343-1078 FOR THE BEST PRICE.

Call P.R.I.C.E. for big savings on home computers, software, video cassette recorders, car stereo, home stereo, portable radios and tape recorders, cordless telephones, and answering machines, video games, tapes, and movies.

P.R.I.C.E. will beat any legitimate offer on in-stock items. Call our toll-free number now! 800-343-1078. In Mass. 617-961-2400.

P.R.I.C.E.™

67 Teed Dr., B283, Randolph, MA 02368

Circle 316 on Inquiry card.

5 1/4" Floppy Disk Drives

(Direct IBM® Plug-in)

TANDON Model TM 100-1 . \$189* ea.
TANDON Model TM 100-2 . \$269* ea.
12" Green Phosphor Zenith Monitor \$109* ea.

IBM EXPANSION BOARDS

64K Memory \$275* ea.
128K Memory \$375* ea.
192K Memory \$450* ea.
256K Memory \$510* ea.
Floppy Controller \$180* ea.
16K System BD Memory . \$ 25* ea.
MC / VISA or C.O.D. with certified check or money order. Arkansas residents add sales tax.

For information or orders, call
501-777-9859

G-H Computer Systems, Inc.
P.O. Box 871 • Hope, AR 71801
* Plus Shipping.

Circle 179 on Inquiry card.

MicroScript™

Are you wasting valuable time trying to format complex documents with a word processor or obsolete text formatter?

MicroScript™ is a state of the art text formatter specifically designed for the production of technical manuals, specifications, and other complex documents. This powerful tool pays for itself the first time you use it. Featuring:

- generalized markup
- left alignment
- center alignment
- right alignment
- justification
- left indentation
- right indentation
- bold text
- underscored text
- proportional spacing
- fully definable page
- multiple columns
- headers and footers
- floating text blocks
- footnotes
- variable line spacing
- widow suppression
- section numbering
- imbedded documents
- automatic lists
- macro processing
- symbol processing
- table of contents
- direct printer control
- initialization profile
- page numbering

\$99 postpaid within U.S., outside U.S. add \$10. CA residents add 6%. Specify CP/M-80*, CP/M-86*, MS-DOS*, or PC-DOS*; printer type; disk format.

Software Technique™

6531 Crown Blvd., Suite 3A • San Jose, CA 95120
(408) 997-5026

* CP/M-80, CP/M-86 trademarks of Digital Research, MS-DOS trademark of Microsoft, PC-DOS trademark of IBM Corporation.

Circle 390 on Inquiry card.

ZENITH/Heath Users

Double Your 5 1/4" disk storage capacity without adding a drive.

Get twice as much from your H88 or H89 microcomputer. Our FDC-880H floppy disk controller, in conjunction with your 5 1/4" drives, for example, expands memory capacity from 256 bytes to 512 bytes per sector.

And it handles single and double-sided, single and double-density, 8" and 5 1/4" drives — simultaneously.

C.D.R. Systems Inc.
Controlled Data Recording Systems Inc.
7210 Clairmont Mesa Blvd., San Diego, CA 92111
(714) 560-1272

Circle 71 on Inquiry card.



P.O. Box 4430X
 Santa Clara, CA 95054
 Will calls: 2322 Walsh Ave.
 (408) 988-1640

Same day shipment. First line parts only. Factory tested. Guaranteed money back. Quality IC's and other components at factory prices.

INTEGRATED CIRCUITS

Phone orders only (800) 538-8196

7400TL	7400	7401	7402	7403	7404	7405	7406	7407	7408	7409	7410	7411	7412	7413	7414	7415	7416	7417	7418	7419	7420	7421	7422	7423	7424	7425	7426	7427	7428	7429	7430	7431	7432	7433	7434	7435	7436	7437	7438	7439	7440	7441	7442	7443	7444	7445	7446	7447	7448	7449	7450	7451	7452	7453	7454	7455	7456	7457	7458	7459	7460	7461	7462	7463	7464	7465	7466	7467	7468	7469	7470	7471	7472	7473	7474	7475	7476	7477	7478	7479	7480	7481	7482	7483	7484	7485	7486	7487	7488	7489	7490	7491	7492	7493	7494	7495	7496	7497	7498	7499	7500
--------	------	------	------	------	------	------	------	------	------	------	------	------	------	------	------	------	------	------	------	------	------	------	------	------	------	------	------	------	------	------	------	------	------	------	------	------	------	------	------	------	------	------	------	------	------	------	------	------	------	------	------	------	------	------	------	------	------	------	------	------	------	------	------	------	------	------	------	------	------	------	------	------	------	------	------	------	------	------	------	------	------	------	------	------	------	------	------	------	------	------	------	------	------	------	------	------	------	------	------	------	------

INTRODUCING A BRAND NEW MICROCOMPUTER

VENTURE is a single board computer that is an adventure for the hobbyist. It is a learning, training computer as well as just plain fun for anyone who wants to get into a state-of-the-art computer at reasonable cost.



VENTURE comes in kit form or fully assembled and tested. You can get it in its minimum configuration for as little as \$195.00 or take it all the way to floppy disks and voice. It can be expanded as a kit or fully assembled, at your own pace and choice.

Quest 1802 software. VENTURE DOS will accommodate up to four 5 1/4" double density floppies. A complete 1802 programming book is available. All versions of VENTURE are shipped with a set of manuals written to be understood by the inexperienced as well as experienced user.

A standard 60-pin bus with 5 slots, parallel ports and 2 serial ports with full handshaking (75 to 9600BAUD) allow expansion into floppy disks, color, EPROM programmer, printer, model of your choice. Later expansion will add a light pen, a universal user programmable music sound board, General Purpose Instrument Bus, and a high resolution color/grayscale pixelmapped video board.

- RESISTORS 10% tolerance 10 per type .05 31*
- 100 per type .015 31*
- 5000 per type .0085 192*
- 350 piece pack, 5 per type .1 85*
- 100 per type .015 31*
- 5000 per type .0085 192*
- 350 piece pack, 5 per type .1 85*

- MONITORS 19" 192*
- 21" 212*
- 24" 242*
- 28" 282*
- 32" 322*
- 36" 362*
- 40" 402*
- 44" 442*
- 48" 482*
- 52" 522*
- 56" 562*
- 60" 602*
- 64" 642*
- 68" 682*
- 72" 722*
- 76" 762*
- 80" 802*
- 84" 842*
- 88" 882*
- 92" 922*
- 96" 962*

- KEYBOARDS 100 per type .015 31*
- 5000 per type .0085 192*
- 350 piece pack, 5 per type .1 85*
- 100 per type .015 31*
- 5000 per type .0085 192*
- 350 piece pack, 5 per type .1 85*

- DISK WRAP TOOLS In stock Complete in c/f for \$10.00
- DISK WRAP TOOLS In stock Complete in c/f for \$10.00
- DISK WRAP TOOLS In stock Complete in c/f for \$10.00

On-Board Options
 16 channel A to D; 5 slot 60 pin bus, 2 serial ports, parallel ports, 4 video options incl. color, 48K RAM, Votrax voice synthesizer, sound generator, EPROM, full BASIC, disassembler, editor, assembler, metal cabinet, additional power supply, ASCII keyboard real time clock calendar.

Expansion Options
 Floppy disk, EPROM programmer, light pen, universal user programmable music, sound board high resolution color/grayscale pixel mapped video board. General Purpose Instrument Bus, 8088 co-processor board.

Minimum VENTURE System \$195.00
 Kit includes CPU and control with 4K of RAM, 1K of scratchpad, 2K monitor, 1861 video graphics, cassette interface and separate HEX keyboard with LED displays for address and output. Power supply is included along with 2 game cassettes. The main board is 16" x 20" and includes space for all of the previously discussed on-board options. Full on-board expansion can be completed for under \$1000.00. Call for further details, option prices, etc.

RCA Cosmac 1802 Super Elf Computer \$106.95

The Super Elf is a tremendous value as it combines video, digital displays, LED displays, and music, all on a single board for \$106.95.

The Super Elf expansion capability is virtually unlimited and you can do it inexpensively one step at a time. Expansion includes cassette interface, additional memory, color video, Basic, ASCII keyboard, printer, floppy, S-100 bus, RS232, etc.

The Super Elf comes complete with power supply and detailed 127 page instruction manual which includes over 40 pages of software, including a series of lessons to help get you started and a music program and graphics target game. Many schools and universities are using the Super Elf as a course of study. OEM's use it for training and

R&D. A monthly newsletter. Questdata is devoted exclusively to software for the Super Elf and there are many software books available at low cost. The Super Elf computer system is now available as a series of bare boards as well as full kits and assembled.

Bare Boards: Super Elf \$35.00. Super Expansion \$35.00. Power Supply \$10.00. S-100 Core \$35.00. Dynamic RAM \$40.00. Manuals \$10.00. Super Basic \$45.00. "Eat & Run" cassette \$14.95

Free 14 Page Brochure
 Send or call for a free brochure on all details and pricing of the Super Elf and its expansion. We will get it right out to you!

Apple Peripheral Kits
 SERIAL I/O INTERFACE 0 to 30,000 baud, D.T.R., Input & output from monitor or basic, use Apple as intelligent terminal, Bd only (P/N 2) \$14.95, Kit (P/N 2A) \$51.25, Assembled (P/N 2C) \$62.95.

PROTOTYPING BOARD (P/N 7907) \$21.95.
 PARALLEL TRIAC OUTPUT BOARD 8 triacs, each can switch 110V, 6A loads, Bd only (P/N 210) \$19.20, Kit (P/N 210A) \$119.55.

APPLE II GAME PADDLES Adam and Eve \$38.00.
 16K RAM Board to take you to 64K. Assem. \$67. Kit \$57.

Interface Kits
 SERIAL/PARALLEL INTERFACE Bidirectional, Baud rates from 110 to 19.2K, sw selectable polarity of input and output strobe, 5 to 8 data bits, 1 or 2 stop bits, parity odd or even or none, all characters contain a start bit, +5 & -12V required. Bd only (P/N 101) \$11.95, Kit (P/N 101A) \$42.89.

RS-232/TTL INTERFACE Bidirectional, requires ±12V, Kit (P/N 232A) \$9.95.
 RS-232/20mA INTERFACE Bidirectional, 2 passive opto-isolated circuits, Kit (P/N 7901A) \$14.95.

PROM Eraser
 Will erase 25 PROMs in 15 minutes. Ultraviolet, assembled, 25 PROM capacity \$37.50 (with timer \$69.50), 6 PROM capacity DSHA/U/L version \$83.00 (with timer \$119.00).

Z80 MicroProfessor \$135.00
 Single board computer. Learning, teaching, prototyping, 2K RAM, keyboard, displays: cassette interface. Tiny BASIC \$19.00. All fully assembled.

MONTHLY SPECIALS

2114	8/\$13.95	2732-2	\$10.95
2114L3	8/\$14.95	4164-150	6.75
2764	\$14.50	1771	15.95
Z80 DMA	\$ 9.95	1791	24.95
μPD 765	\$34.95	1793	26.95
LM317K	\$ 1.50	2532	6.50

Z80 Microcomputer Kit \$69.00
 16 bit I/O, 2 MHz clock, 2K RAM, ROM Bread-board space. Excellent for control. Bare Board \$28.50. Full Kit \$79.00. Monitor \$20.00. Power Supply Kit \$35.00. Tiny Basic \$30.00.

Modem Kit \$60.00
 State of the art, orig., answer. No tuning necessary. 103 compatible 300 baud. Inexpensive acoustic coupler plans included. Bd. only \$17.00. Article in June, July, Aug. Radio Electronics, 1981.

60 Hz Crystal Time Base Kit \$4.40
 Converts digital clocks from AC line frequency to crystal time base. Outstanding accuracy.

Video Modulator Kit \$9.95
 Convert TV set into a high quality monitor who affecting usage. Comp. kit w/full instr.

Multi-volt Computer Power Supply
 8v 5 amp, ±18v .5 amp, 5v 1.5 amp, -5v .5 amp, 12v .5 amp, -12v option. ±5v, ±12v are regulated. Basic Kit \$35.95. Kit with chassis and all hardware \$51.95. Add \$5.00 shipping. Kit of hardware \$16.00. Woodgrain case \$10.00. \$1.50 shipping.

Type-N-Talk by Votrax
 Text to speech synthesizer with unlimited vocabulary, built-in text to speech algorithm, 70 to 100 bits per second speech synthesizer, RS232C interface \$275.00. Speech IC \$59.00.

Voltage Mate \$18.50
 \$125 shipping. Switching regulator kit with adjustable AC/DC voltage conversion. 3 modes of operation: step up, step down, inversion. Jumper selectable modes of operation. Input voltage 5-15 VDC. output voltage - 24 to + 30 VDC. current draw 30-250 ma

UHF Pre-amplifier Kit \$34.95
 \$2.00 shipping. Improves uhf reception dramatically. 25 db gain assem. version \$57.50. Articles Radio Elect. Mar. May, 1981

Fluke Multimeters
 D800 \$125 —D802 \$189.—D804 \$249.

Rockwell AIM 65 Computer
 6502 based single board with full ASCII keyboard and 200 column thermal printer. 20 char. alphanumeric display ROM monitor; fully expandable \$445.00, 4K version \$454.00, 4K Assembler \$35.00, 8K Basic Interpreter \$65.00.

Special small power supply 5V 2A 24V .5A assem. in frame \$59.00. Molded plastic enclosure to fit both AIM 65 and power supply \$52.50. AIM 65 1K in cabinet with power supply, switch, fuse, cord assem. \$571.00, 4K \$586.00, 65/40-5000 AIM 65/40 w/16K RAM and monitor \$1295.00, RAM Board Kit (16K, 195) (32K, A215). V0640 Video Interface Kit \$119.00, A&T \$149.00. Complete AIM 65 in thin briefcase with power supply \$532.00. Special Package Price: 4K AIM, 8K Basic, power supply, cabinet \$615.00.

AIM 65/KIM/SYM/Super Elf 44 pin expansion board; board with 3 connectors \$22.95. *Send for complete list of all AIM products.

Elf II Adapter Kit \$24.95
 Plugs into Elf II providing Super Elf II 44 and 50 pin plus S-100 bus expansion. (With Super Expansion), High and low address displays, state and mode LED's optional \$18.00.



Super Color S-100 Video Kit \$99.00
 Expandable to 256 x 192 high resolution color graphics. 6847 with all display modes computer controlled. Memory mapped, 1K RAM expandable to 6K. S-100 bus 1802, 8080, 8085, 280, etc. Dealers: Send for excellent pricing/margin program.

TERMS: \$5.00 min. order U.S. Funds. Calif. residents add 6% tax. \$10.00 min. VISA and MasterCard accepted. \$1.00 insurance optional. Shipping: Add 5%; orders under \$25.00—10%. Prices subject to change. FREE: Send for your copy of our 1982 QUEST CATALOG. Include 88¢ stamp.

Verbatim® Diskettes



Top-quality Verbatim® Diskettes from **Tech•Data**, your complete word and data processing supply center. Dealer inquiries invited.

Call Toll Free
1-800-237-8931.
 In Florida, call
813-577-2794.

Tech•Data Corporation
 3251 Tech Drive North
 St. Petersburg, FL 33702

Circle 404 on Inquiry card.

NEW! M-68000 SINGLE BOARD COMPUTER

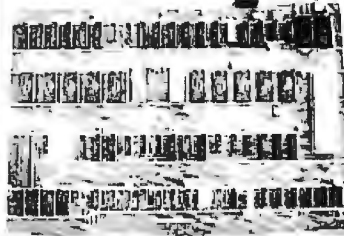

FEATURES:
 16 bit Motorola 68000 CPU operating @ 10MHz, 20K bytes on board fast static RAM, 16K bytes of on board EPROM space, 7 levels of prioritized autorestored interrupts, 2 memory expansion buses (up to 256K), 2 serial communication ports (RS-232C), 16-bit bidirectional parallel port, 4800 peripheral communication bus, 546-bit counter/timers with vectored interrupts, on board real time clock, software compatible with Motorola MEX68KDS1 board.

PRICE:
 Bare board with documentation \$99.95
 MEX68KDS1 compatible monitor in 2764 EPROM's \$128.00
 M68000 CPU & memory map PROM \$115.00
 Shipping and handling (Domestic) \$3.00
 (Foreign) \$15.00
 ©1988 WTEK 06/08/88 V75.400 06/24/88

EMS Educational
 Microcomputer
 Systems
 P.O. BOX 16115 IRVINE, CA 92713-0115
 714-553-0133

Circle 162 on Inquiry card.

6800 Micro Modules

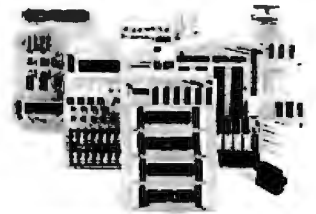

FOR INTERFACING TO: sensors, transducers, analog signals, solenoids, relays, lamps, pumps, AC motors, DC motors, stepper motors, keyboards, displays, 488 GPIB.

ADDITIONAL FEATURES: 6800 MPU, counter/timer, fail safe battery back up

WINTERK
 Winterk Corp.
 1801 South Street
 Lafayette, IN 47904
 317-742-8426

Circle 438 on Inquiry card.

STOP

Wasting Money! We Have the World's Most Cost Effective Development System.



- Includes Hexkit 1.0, a powerful 100% machine code editor/debugger utility program that makes coding for 8-bit Micros a snap.
- Program from Commodore VIC-20 keyboard into built-in 4K ROM emulator
- Jumper to target ROM socket
- Test programs in circuit
- Built-in EPROM programmer and power supply
- Burns & runs EPROMs for the Commodore VIC-20, too
- Comprehensive manuals
- Fits EXPANSION PORT

PROMQUEEN CARTRIDGE ONLY \$199

Send for Free Brochure

Gloucester Computer Bus Co.

6 Brooks Rd., Gloucester, MA 01930
 617-283-7719

VISA AND MASTERCARD ACCEPTED

Commodore approved product

Circle 187 on Inquiry card.

THE SORT IBM®

General Sort and Merge Utility
 Created exclusively for the IBM Personal Computer
 \$95

THE SORT SORTS:

- BASIC, PASCAL, FORTRAN, COBOL and MailMerge files
- sequential/random files
- records organized by items and lines
- for all common data types (string-text, integer, real, double precision)
- for all common date types (string-text, integer, real, double precision)
- external and internal data representations
- interactive parameter preparation
- record selection

Requires 48 K and one disk drive

Also OMS SOFTWARE DEVELOPMENT SERIES

- PASCAL SCREEN UNIT Access screen and keyboard from Pascal program \$40
- PASCAL DOUBLE PRECISION ARITHMETIC PACKAGE - Increase your Pascal integer arithmetic precision to 32 bits! \$40
- UTILITY PACKAGE - converts video modes, opens communication lines, speeds up I/O, Sets Epson and NEC tabs. \$25

*Registered trademark of IBM.

Send order with check/money order to
ORGANIZATIONAL MANAGEMENT SYSTEMS, INC.
 3 Chickory Court, Glen Arm, Md. 21057
 (301) 668-9011

MD residents include 5% sales tax

Circle 311 on Inquiry card.

Get more out of your Apple with the MICRO on the Apple Series

Vols. 1, 2, & 3 \$24.95 ea.
 + \$2.00 shipping each volume

Each book includes more than 30 programs —
all on DISKETTE

Machine Language Aids
 I/O Enhancements
 Runtime Utilities
 Graphics & Games
 Hardware & Reference
 Information



To order toll free:

1-800-345-8112
 In PA 1-800-662-2444

MICRO INK, Inc.
 P.O. Box 6502
 Chelmsford, MA 01824

Circle 257 on Inquiry card.

WIRESMASTER

Whip your wire wrap and PC layout problems with **WIRESMASTER**



WIRESMASTER is a software tool for design, layout, and assembly of hardware. Your schematic is fed to **WIRESMASTER**, which produces network maps, cross-references, wire and parts lists, and debug checklists. **CHANGEMASTER** keeps track of fixes and updates. **PLOTBOARD** and **PRINTBOARD** give pictures of the layout. Post-processors for wirewrap machines available. Runs on 8 and 16 bit CP/M, CDOS, and MSDOS. \$200.

AFTERTHOUGHT ENGINEERING 7266 Courtney Dr., San Diego, CA 92111, (714) 279-2868.

Circle 13 on Inquiry card.

S-100 Single Board WINCHESTER "EASY DISK CONTROLLER"

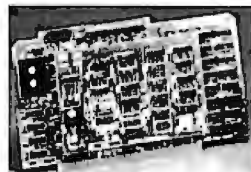

- Works with any S-100 CPU + IEE 696
- Supports 5 1/4", 8" and 14" Drives
- ST-506, SA-1000, SA-4000 Interfaces
- Record Accessible 1-K sector buffer frees host memory, matches DMA speed
- On-board microprocessor - auto seeks, simple, very small software driver
- Dealers and Distributors invited

Assembled and tested with formatter/test program and operating system drivers.

VISA, MasterCard - specify drive - \$545.

Monitor Dynamics, Inc.
 1121 West Ninth St. • Upland, CA 91786
 (714) 985-7214

Circle 286 on Inquiry card.



Solve your disc problems, buy 100% surface tested Dysan diskettes. All orders shipped from stock, within 24 hours. Call toll FREE (800) 235-4137 for prices and information. Visa and Master Card accepted.

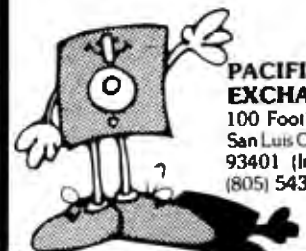

PACIFIC EXCHANGES
 100 Foothill Blvd.
 San Luis Obispo, CA
 93401 (In Cal. call
 (805) 543-1037.)

Circle 318 on Inquiry card.

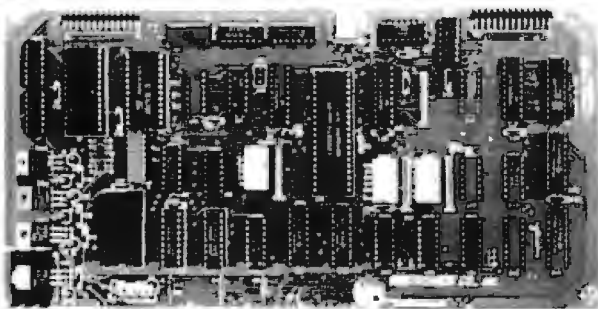

SBC-880 S-100 IEEE STAND ALONE SINGLE BOARD COMPUTER

USES Z-80A (2 or 4MHz)

FEATURES: RS232 Serial I/O Port • Parallel Ports for Centronics or Gen Purpose Printer • Three 16 bit Programmable Timers, one used for baud rate • EPROM Circuitry for 2708, 2716, or 6116 (2K RAM) • 1K On Board RAM Circuitry locatable on 1K boundaries • Power On EPROM Jump Circuitry • Phantom EPROM Circuitry

Kit
\$240

A & T
\$265



FDC-1 S-100 IEEE 696 FLOPPY DISC CONTROLLER

USES WD1795-02

FEATURES: State of the art digital separator • Drives can be any ANSI 5¼" or 8" drive • Drive Size, Step Rates, Formats can be intermixed without changing software • Runs SD, DD, SS and DS Formats • Digital Prewrite Compensation.

Assembled and Tested **\$295.00** Kit **\$265.00**



S-100 IEEE REAL TIME CLOCK CALENDAR

GIVE YOUR COMPUTER THE Hour-Min.-Sec.-Day-Month-Year

FEATURES: Date provided as Day, Month, Year with Leap Year register bit • Time provided as 12 or 24 hour program selectable format, hours, minutes and seconds • Time and Date settable by program control • Plus or Minus 30 second time adjustment • 4 Time Interrupts available—1 hour, 1 minute, 1 second and 1040Hz (approx. 1 millisecond) • Crystal Controlled time reference • On board Rechargeable Data Sentry Battery

Assembled and Tested **\$139.00** Kit **\$115.00**

★ SPECIAL ★

APPLE II COMPATIBLE FLOPPY DISC CONTROLLER

DIRECTLY DRIVES ANY ANSI, SHUGART OR TANDON DISK DRIVES

Frees you from Apple disc drives and Apple look alike drives.

FEATURES: Compatible with CP/M, PASCAL and Apple DOS 3.3 • Drives can be any standard Shugart compatible 5¼ drive • Reads 13 or 16 Sector Discs, hard or soft sector • 7 Cards can be used to drive 14 Disc Drives (two drives each card)

Controller **\$99.95**
Tandon, D/D TM100-1 **\$225.00**

APPLE II COMPATIBLE ASCII

FULL KEYBOARD



FEATURES: N-Key Rollover Function • Shift lock, Underscore and [] • High Flexibility for Modification or Expansion • Plug-in Compatible with Apple II • Compact size, mounts in Apple II Case • Full Typewriter Keyboard with TTL level ASCII outputs • On-Off Indications • Low Power Consumption

Assembled and Tested **\$99.00**

S-100 IEEE 696 CARD CAGES AND MOTHER BOARDS

- ★ Ground Shielding Network prevents cross talk
- ★ LED Power Indicator
- ★ Easy Access to Power and Reset Lines
- ★ Available in 6, 8, and 12 slot cages

	6 Slot	8 Slot	12 Slot
Bare Board	\$20.00	\$25.00	\$35.00
Kit	40.00	55.00	80.00
Assembled & Tested	55.00	80.00	115.00
A & T and in Card Cage	80.00	115.00	155.00

SUNTRONICS PROTOTYPE BOARDS



APPLE Prototype Board. Double sided glass with gold plated Apple and General Purpose terminals. Contains matrix of 17 x 63 solder plated donuts on .15" x .1" spacing. Great for 14, 16, 24 pin IC's.

SUN-722 **\$13.75**



S-100 Prototype Board. Double sided glass with gold plated, numbered S-100 terminals. Matrix of 25 x 78 solder plated donuts on .15" x .1" spacing. Locations for headers and regulators. Great for 14, 16, 24 pin IC's.

SUN-721 **\$17.85**

General Purpose Experimental Prototype Boards (Solder Plated w/Double Sided Terminals on .156" Centers)

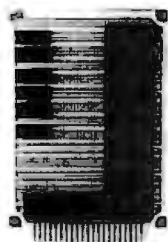

15/30 pin, 3/4 x 4/4 board w/.1" x .2" hole spacing and power strip run every 1.2". Allows 6x7 8pin IC's or 2x3 24pin IC's

SUN IC-S **\$1.65**

22/44 pin, 4/4 x 6/4 board w/.1" hole spacing. Contains 4 rows of 67 pins with power strips between rows. Pattern of 4 columns of 67 pins. Takes all sizes of IC's.

SUN U-75 **\$3.25**

22/44 pin, 4/4 x 7 board w/.1" x .2 hole spacing and power strips every 1.2". Allows 10x10 8pin IC's or 3x7 24pin IC's.

SUN IC-L **\$3.95**

Dealer Inquires Invited

EPROM's, RAM's, CPU, and MISC

	1-7	8 up	50 up		1-7	8 up	50 up
				6116P-3 (150nS)	6.10	5.75	CALL
2732	4.75	4.40	CALL	2114L-2 (200nS)	—	1.62	CALL
2532	7.65	5.95	CALL	4164 (150nS)	CALL	CALL	CALL
2764	16.95	14.50	CALL	Z-80A CPU	5.29	—	—
				16K RAM Expansion Kit For TRS-80 Model III	\$11.00/8		

SAMWOO MONITORS

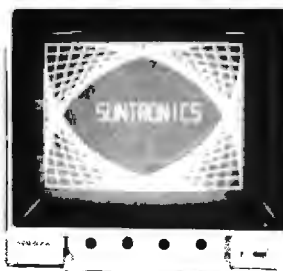

Features: Composite Video Input/Output • Switchable Input Impedance 75 or 10K ohm • 750 Line Resolution at Center and 500 Lines at Corners • Dimensions are 12.13"x11.34"x11.65" for the 12" model and 8.66" x 8.54"x9.05" for the 9" model

9" 18Mhz BANDWIDTH

Black and White **\$117.00**
Green **121.00**
Orange **125.00**

12" 12MHz BANDWIDTH

Black and White **\$127.00**
Green **130.00**
Orange **134.00**

Add \$7.50 Shipping and Handling for this item
Dealer Inquires Invited



SUNTRONICS CO., INC.

12621 Crenshaw Blvd., Hawthorne, CA 90250

STORE HOURS: MON.-FRI. 9:00am to 6:30pm
SATURDAY 10:00am to 5:00pm

CALIFORNIA OUTSIDE CALIFORNIA TOLL FREE

213-644-1149

(for Tech Info and Calif. orders)

1-800-421-5775

(Order Desk Only)

Mail Order—Minimum Order: \$10. Send Money Order or Check to: P.O. BOX 1957—Dept. B, HAWTHORNE, CA 90250. VISA or Mastercard (please include expiration date). Add \$2.00 postage and handling to order. CA residents add 6% sales tax. Apple is a registered trademark of Apple Computer Inc.

Maxell Floppy Disks

The Mini-Disks
with maximum quality.



Dealer inquiries invited. C.O.D.'s accepted. Call FREE (800) 235-4137.

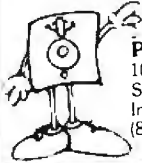

PACIFIC EXCHANGES
100 Foothill Blvd., San Luis
San Luis Obispo, CA 93401.
In Cal. call (800) 592-5935 or
(805)543-1037

Circle 318 on Inquiry card.

8087 SUPPORT

For the
IBM PC and
CP/M-86.

8087 CHIP..... \$223
APPLICATIONS

FFTs..... \$75
MATRIXPAK..... \$75

87/88 GUIDE VOLUME I... \$19.95

LANGUAGE SUPPORT

87MACRO™..... \$150
87BASIC™..... \$150
87PASCAL™..... \$150
87FORTRAN™..... \$150

IBM Personal Computer is a registered trademark of IBM Corp. CP/M-86 is a trademark of Digital Research, Inc. 8087 is a trademark of Intel Corp. 87/88GUIDE, 87MACRO, 87BASIC, 87PASCAL, 87FORTRAN and MicroWare are trademarks of MicroWare, Inc.

MicroWare

P.O. Box 79
Kingston, MA
02364
(617) 746-7341

Circle 278 on Inquiry card.

MEDICAL SOFTWARE

MediSoft specializes in non-accounting software applications for the medical professional, pharmacy, hospital and teaching institution. Emphasis is on literature retrieval, drug information, patient data processing, diagnostics and biosimulation. We are currently marketing and developing software in these areas. If you are a program designer with medical interests or a medical professional with programming interests, contact us for a prospectus on our future and yours.

MediSoft



Medical Professions Building
1595 Soquel Drive, Suite 350
Santa Cruz, CA 95065
(408) 476-7861

Circle 250 on Inquiry card.

price or quality?

Get both... with a MICRO CONNECTION, the quality, direct connect, Bell 103 modem. Independent reviewer writes, "When the going gets rough, if a MICRO-CONNECTION can't make it, then nothing will. In the area of sensitivity and noise elimination, it will perform as good or better than my \$995" modem. An excellent value for \$159. Autodial/Autoanswer for \$199.

the microperipheral corporation

2643 151st Place N.E.,
Redmond, WA 98052

(206) 881-7544



Circle 273 on Inquiry card.

NOW MAKE SOLID CONNECTIONS.... Male or Female

RS 232 GENDER REVERSERS



\$19.95 each
postpaid
American Made

Order either two male or two female connectors with all 25 pins interconnected. Both Gender Reversers just \$34.95 postpaid. Purchase Orders from rated firms accepted. Get free illustrated catalog of interface and monitoring equipment.



B&B electronics

P.O. Box 475-B • Mendota, IL 61342
Phone (815) 539-5827

Circle 43 on Inquiry card.



Scotch

DISKETTES

SAVE 40% Write for our complete list.

5 1/4" Specify soft, 10 or 16 sector	Price/10
#744D 1 side/sgl/dbl dens	\$26.70
#745 2 sides/dbl dens	38.40
#746 1 side/77 track	33.80
#747 2 sides/77 track	45.50

8" Specify soft or 32 sector	Price/10
#740 1 side/sgl dens	27.30
#741 1 side/dbl dens	35.80
#743 2 sides/dbl dens	43.60

CHECKS - VISA - MC - C.O.D.
(313) 777-7780 ADD \$2 SHIPPING

LYBEN COMPUTER SYSTEMS
27204 Harper Ave.
St. Clair Shores, MI 48081

Authorized Distributor
Information Processing Products



Circle 236 on Inquiry card.

LOOK TO THE FUTURE...

EPROM-32

The only EPROM programmer you need!

- IEEE-696 (S-100) EPROM programmer for single supply (+5V) EPROMs
- Programs current 1K through 16K (byte) EPROMs plus future 32K EPROMs.
- EPROM can be verified through a port or located in memory space for verification and use.
- Personality Modules adapt board to different EPROM types:
PM-1 - 2508, 2758 PM-3 - 2732, 2732A PM-6 - 68764
2516, 2716 PM-4 - 2564 PM-7 - 2528
PM-2 - 2532 PM-5 - 2764 PM-8 - 27128
- Single zero-insertion-pressure socket accommodates both 24-pin and 28-pin EPROM packages.
- On-board DC-to-DC converter with adjustable regulator for programming voltage.
- Double-sided PC board with solder masks, silkscreen and gold-plated contact fingers.
- 8080/80 control software includes commands for programming, verification, disk I/O and editing.
- Comprehensive user's manual contains source listing of control software.

\$269.95

(assembled & tested)

MicroDynamics

Corporation
P.O. Box 17577
Memphis, TN 38117
(901)-755-0619

Price includes EPROM-32, documentation and two Personality Modules (specify). Additional Modules - \$7.95. Control software on 8 inch single density CP/M compatible diskette - \$9.95.

MasterCard & Visa

TN residents add 6% sales tax.

Circle 271 on Inquiry card.

PC/FORTH™

Complete FORTH program development systems for the IBM® Personal Computer. Packages include interpreter/compiler with virtual memory management, line editor, custom screen editor, assembler, decompiler, utilities, file and record access modules, and many demonstration programs. 150 page user manual. . . . \$100.00

Software floating point, Intel 8087 support, color graphics extensions, and target compiler available of additional cost.

Specify PC-DOS or CP/M-86®. One disk drive and 48 kbytes RAM required. Software supplied on 5 1/4 inch single sided soft sectored double density diskettes.

Laboratory Microsystems

4147 Baethoven Street
Los Angeles, CA 90066
(213) 306-7412

IBM is a registered trademark of International Business Machines Corp. CP/M is a registered trademark of Digital Research, Inc.

Circle 227 on Inquiry card.

UNIFORTH

Check with us before you order FORTH from any other distributor. UNIFORTH is available for most Z-80, 8086/8088, LSI/PDP-11, 68000 or 16032 computers, either stand-alone or as a task under an operating system. UNIFORTH adheres to the FORTH-79 standard, and includes a video editor, floating point routines, and an assembler. We offer a solid, professional system with extensive documentation and option packages. Prices: \$60 (basic) to \$300 (multi-user).

Requires 8" floppies.

Unified Software Systems
P.O. Box 2644
New Carrollton, Md 20784
(301) 552-1295

Circle 423 on Inquiry card.

DECADES OF SERVICE

Washington Computer Services

97 Spring Street
New York, New York 10012

TO ORDER: CALL OUR TOLL-FREE NUMBER: (800)221-5416

In N.Y. State and for technical information: (212) 226-2121

HOURS: 9 AM-5:30 PM (EST) Monday-Friday

an affiliate of **WASHINGTON ELECTRIC COMPANY** est. 1912

CUSTOM COMPUTER ROOM WIRING SINCE 1960

TELEX: 12-5606

CABLE: WASHCOMP NYK

FULLY CONFIGURED BUSINESS SYSTEMS

The following are some examples of the fully assembled and tested business and scientific computer systems which we offer:

IMS INTERNATIONAL The Premier Multi-User Computer System
8000 SX, multi-user, multi-processor, turbo DOS
CPM 2.2. FULL 2 YEAR WARRANTY!
5000IS, S-100 desk top mainframe
On-Site Service Contracts Available

CALL FOR CONFIGURATION

MORROW DESIGNS MICRODECISION from below \$1200
8088/8055—Runs both 8 & 16 bit software. Green or high res. color. CP/M, MS-DOS
ZENITH APC-8086, 16 bit, 128K, 8" DRIVES, 1024 x 1024 Color Graphic, 32 bit F.P. Proc., MS DOS, CP/M 86 from \$3295
NEC

PC-8800 Personal Computer

The Professional's Work Station
NEC on N.Y.S. Contract #P-07220

IBM 68000 16 bit multi-user, S-100. UNIX V. 7 SCALL

A SEATTLE COMPUTER 8086 16 bit, 128K RAM, S-100. Syst. #2 \$3499

Systems **XEROX** **MORROW DESIGNS**
California Computer Systems **GODBOUT** **ALTOS**
InterSystems **NorthStar** 8 & 16 BIT BOARDS & SYSTEMS

SCION MicroAngelo Hi Res Graphics Systems SCALL
Similar savings on **SSM, DELTA, DYNABYTE, TELEVIDEO, DIGIAC, ADDS, DEC, DATA GEN., ATARI, TECMAR AND MANY OTHERS**

PRINTERS

Teletype 40. 300 LPM-typewriter quality, RS-232 interface. This quality printer is available in many configurations including forms access, quietized case, etc. from Only \$3200

Teletype43 from \$995
ANADEX DIABLO MANNESMANN TALLY
CENTRONICS EPSON NEC AMERICA
C. ITOH FACIT QUME
DATA PRODUCTS OKIDATA SMITH CORONA
DIGITAL EQUIP. CORP. OLIVETTI TELETYPE
INTERGRAL DATA SYS. QANTEX TEXAS INSTRUMENTS

Where Do You Turn To Solve Your Computer Puzzle?

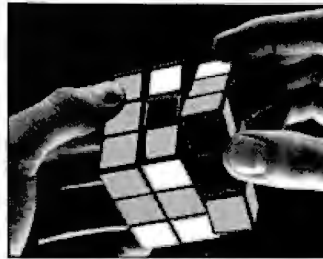

TURN TO US!

We'll show you the easiest way to put the pieces together.

Matched, Compatible, Proven—
Use Someone Else's Engineering to Supplement Yours.

SOFTWARE

Over 2000 business, scientific, professional applications & educational packages are available. Call with your requirements for our advice or a quotation.

8" DISK DRIVE SALE

NOW!

8" SHUGART SA801R \$385 8" SHUGART SA 851R \$540 2 for \$1025
QUME DATATRACK 8 or MITSUBISHI \$550 2 for \$1050
Enclosure, power supply for 2 8" drives A & T \$350
MORROW DISCUS 2D + CP/M® MICROSOFT BASIC, CONT. \$950
VISTA SCALL

HARD DISK SPECIALS

CORVUS

TERMINALS

MORROW DESIGNS **AMCO** **RODS** & **XCOMP** **KORAN**
PMMI MODEM \$359
TELETYPE ADDS IBM 1301
TELEVIDEO ANN ARBOR DIGITAL EQUIP. CORP.
LEAR SIEGLER VISUAL HAZELTINE

AMPEX Dialogue 81™ Interactive Terminal

• Full cursor control
• Full editing keys
• Full visual attributes
• 2 pages (4 page optional)
• Printer port
• Black & White, Green, or Amber screen



\$795

BACK TO SCHOOL SPECIAL! ZENITH ZT-1

Built-in Auto Dial Modem Terminal
DEC VT-52 Compatible;
96 ASCII + 33 graphics cursor
control keys. Editing functions. Many other functions.



\$669

PLEASE! Do not confuse us with mail order dealers. We are a full service distributor serving the data processing & installation needs of business & industry from micros to mainframes. System houses, Educational institutions & governmental agencies given special consideration. Leasing available.

N. Y. State agencies, municipalities, and schools — call us for information on our O.G.S. term contracts on hardware & software.

DEALER and INTERNATIONAL INQUIRIES WELCOME

For fast delivery, send certified check, money order or call to arrange direct bank wire transfer. Personal or company checks require two to three weeks to clear. Prices subject to change without notice: call for latest prices. Prices include 3% cash discount. N.Y. residents add sales tax. Qantex is a trademark of North Atlantic Industries, Inc. CP/M® is a trademark of Digital Research. All sales subject to our standard sale conditions (available on request). Call for shipping charges. Above prices do not include customization or installation.

SUPER I/O™

Low Cost I/O Expansion Board

Build and interface projects in minutes. Use with any Z80™ processor. Use simple In/Out instructions. No complicated controllers to init. Features I/O or memory map.

- 32 byte wide channels
- 16 Input/16 Output
- 256 bits of I/O. Options for TRS™, SIM-CLAR™ and Z80™ socket interface cables.

*Trade marks

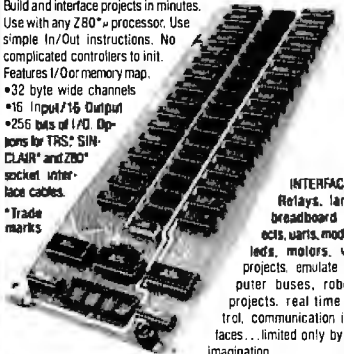

INTERFACE
Relays, lamps, breadboard projects, modems, leds, motors, voice projects, emulate computer buses, robotics projects, real time control, communication interfaces... limited only by your imagination.

WIN/MILL Research, Inc.
INNOVATIVE PRODUCTS FOR INNOVATIVE PEOPLE
453 Crampton Avenue | ORDER PHONE (only) (702) 329-0441
Reno, Nevada 89502 | For priority info. send \$ASE.

Circle 437 on inquiry card.

Improve the EPSON?

Sure, with **Auto On-Line™**

Forget to turn the EPSON back on-line? Auto On-Line remembers.

Does the remote printer hang up because people leave it off-line? If someone leaves it off-line for more than 20 seconds, Auto On-Line turns it back on-line automatically. No more hang-ups.

Assembled, tested and ready to plug in to any MX80 series printer.

Send check or money-order \$19.95 (Postage and Handling INCLUDED, Conn. res. add 7 1/2% tax.) Dealer inquiries welcome.

KRER Associates
6 Waterbury Rd,
North Haven, CT 06473

Circle 224 on inquiry card.

SAVE \$\$\$

IBM™-PC USERS
Buy RAM Card/Serial Port direct from the manufacturer

COMPARE OUR PRICES

RAM Card 64K populated, expandable to 512K \$239
RAM Card 128K populated, expandable to 512K \$319
RAM Card 256K populated, expandable to 512K \$479
RAM Card 512K populated, expandable to 512K \$799
Above each RAM Card with Serial Port, add \$80
Expansion Kit 64KB (tested), only \$70

LOOK AT THESE FEATURES!

- Multilayer Board for Low Noise.
- Socketed for Easy Upgrade to 512K memory.
- One Year Warranty
- Parity Generate/Check - Error Detecting Capability
- Fully compatible with IBM-PC Software & Hardware Specs
- Easy to Follow Instructions Included
- Serial Port may be Configured as COM1 or COM2
- Address Flexibility - Each 64K Block is Address Selectable for any Base Address.

Dealers inquiries welcome • Add \$5 for Shipping • California Resident, Add 6% Sales Tax.
Call or Send Check/Money Order to:
MK Research
14682 Orange Acres • Irvine, California 92714
Telephone: (714)559-1598

Circle 284 on inquiry card.

TAXMAN-83

An Interactive TAX MANAGEMENT Program for VisiCalc™ & Super Calc™ Users

TAXMAN-83 provides you with the capability to easily calculate your 1982 taxes by using the already proven VisiCalc™ and SuperCalc™ electronic spreadsheets.

TAXMAN-83 prepares and prints 1982 individual income tax returns. TAXMAN-83 considers all tax alternatives, computes the lowest tax possible, tests reasonableness and tells you which forms are necessary for filing. TAXMAN-83 includes the following forms/schedules: Federal 1040; Schedules A, B, C, D, E, F, G, R, PP, SE, ES, U, W; Forms 1116, 2106, 2119, 2210, 2440, 2441, 3468, 3903, 4136, 4137, 4255, 4562, 4563, 4625, 4684, 4797, 4798, 4835, 4852, 4970, 4972, 5329, 5544, 5695, 5884, 6249, 6251, 6252, 6478, 6765, 6781; Tax schedules X, YS, YJ, Z, Tax tables; Sales tax tables for all states.

TAXMAN-83 is now available for most microcomputers utilizing VisiCalc™ or SuperCalc™.

PRICED AT ONLY **\$95.00**
Call: 1-205-533-7590

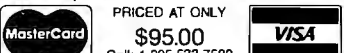

ATSUKO COMPUTING INTERNATIONAL
303 Williams Avenue, Huntsville, AL 35801

©1982 by ATSUKO COMPUTING INTERNATIONAL. All rights reserved. This software is a trademark of ATSUKO COMPUTING INTERNATIONAL. SuperCalc is a trademark of VisiCorp. SuperCalc is a trademark of SYBEX Corporation.

Circle 39 on inquiry card.

NEW PRODUCT!



CP/M Z80-A SINGLE BOARD COMPUTER

- On board video • Wide line and thin line graphics
- 128K of RAM • Sasi interface • Floppy disk controller for up to four 5-1/4 and four 8 inch drives, single/double density simultaneously • 4 serial ports • Full Centronics printer port • Expansion bus • Extended track buffer • 16K printer buffer
- DMA • Compact size (8-1/4 x 12-1/4)

\$600.00 on orders placed and paid for prior to March 1, 1983 FOB Los Angeles, CA \$7.00 shipping

INSIGHT ENTERPRISES, CORPORATION
373 N. Western Ave., Suite 12,
Los Angeles, CA 90004 (213) 461-3262
Dealer, OEM, International Inquiries Welcome



Circle 208 on inquiry card.

PRINTER CABLES

ALSO CRT & MODEM CABLES

CUSTOM MFG. TO YOUR SPECIFICATIONS
SEND FOR FREE CATALOG OR SEND A SAMPLE

-IT WILL BE RETURNED WITH QUOTATION
-SPECIFY QUANTITIES TO BE QUOTED

SECTOR SYSTEMS CO.
PO BOX 751
MARBLEHEAD, MA 01945

Circle 380 on inquiry card.

The ACCOUNTER

for Apple II, 48K, One Disk Drive Double Entry, Menu-Driven GENERAL LEDGER

- Cash Journal • Check Record • Revenues
- Receivables • Payables • Payroll

- ▶ Flexible, simple to apply
- ▶ Sort, test, view, audit
- ▶ Current financial statement
- ▶ User-error recovery
- ▶ Formatted printout
- ▶ 60-page manual
- Many more features

GREAT FOR NON-ACCOUNTANTS

Limited-time special \$89.00
Add \$5.79 tax in California
Money-back guarantee



CYCLONE SOFTWARE
10395 Flora Vista Ave.
Cupertino, CA 95014

Circle 133 on inquiry card.

Y.E.S., We have the best... prices available on I.C.'s.

2114	200ns	1.50
4116	150ns	1.35
4164 Pla.	200ns	5.50
4164 Cer.	200ns	5.70
4164 Cer.	150ns	6.00
6116P-3	150ns	4.75
6116LP-3	150ns	5.70
58725 NMOS	200ns	4.50
2716	450ns	3.40
2732	450ns	4.00
2764	250ns	9.95
2532	450ns	4.90
Z80A CPU, CTC, PIO		3.35
Z80A SIO		12.00
8255A-5		3.00
D8080A 2MHZ		3.90
Z80B CPU		10.00

*C.O.D., Master Charge and Visa accepted.
*Ask for OEM quantity prices.

Yang Electronic Systems, Inc.
307 Compton Ave., Laurel, MD 20707
(301)776-0076

Circle 461 on inquiry card.

Scotch® Diskettes

Rely on Scotch® diskettes to keep your valuable data safe. Dependable Scotch diskettes are tested and guaranteed error-free. The low abrasivity saves your read/write heads. They're compatible with most diskette drives.



(800)235-4137



Dealer inquiries invited

Circle 318 on inquiry card.

SPEECH SYNTHESIZERS

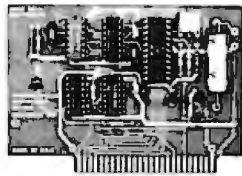

JBEs Speech Synthesizers use the Votrax SC-01 Phoneme Synthesizer chip. The SC-01 phonetically synthesizes continuous speech of unlimited vocabulary. The SC-01 contains 64 different phonemes and 4 levels of inflection accessed by an 8 bit code. It requires 10 Bytes per second for continuous speech. Both boards have an audio amp for direct connection to an 8 ohm speaker.

Documentation includes basic user programs, a phoneme chart and listing of coded words to help you get started. Documentation for the Apple II[®] Speech Synthesizer includes a disk with text to speech program.

81-088 Apple II Speech Synthesizer \$129.95
 81-120 Parallel Input Speech Synthesizer \$149.95
 Prices include the SC-01 Chip. SC-01 sold separately for \$39.95

A-D & D-A CONVERTER

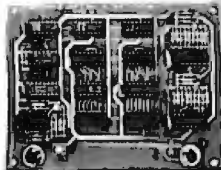

JBE A-D & D-A Converter can be used with any system having parallel ports.

- Interfaces with JBE Parallel I/O Card
- D-A Conversion time — 5µs
- A-D conversion time — 20µs
- Uses JBE 5V power supply
- Parallel inputs & outputs include 8 data bits, strobe lines & latches
- Analog inputs & outputs are medium impedance 0 to 5 volt range.

79-287 ASSM. \$79.95
 Bare Board \$39.95

SOLID STATE SWITCH



Your computer can control power to your printer, lights, stereo & any 120VAC appliances up to 720 watts (6 amps at 120VAC). Input 3 to 15VDC • 2-14MA TTL compatible • Isolation — 1500V • Non zero crossing • Comes in 1 or 4 channel version

79-282-1 ASSM. \$13.95
 Bare Board \$6.95
 79-282-4 ASSM. \$49.95
 Bare Board \$24.95

6502 MICROCOMPUTER

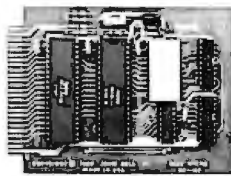

6502 MPU, 6522 VIA, 2716 EPROM, 2114 RAM single board computer. Single 5 volt power supply at 400 Ma. Two independent 8 bit I/O ports with handshake lines. RC controlled 1 MHz clock.

Complete documentation. I/O lines use 50 pin edge connector. Data and address lines are not accessible. Mod. for 2532 is included. EPROM is not included. 1K RAM, 2K EPROM, 2 I/O ports.

80-153 Assm. \$110.95

Z-80 MICROCOMPUTER

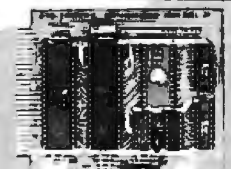

Z-80 MPU, Z-80 PIO, 2716 EPROM, 2114 RAM single board computer. Single 5 volt power supply at 300 Ma. Two independent 8 bit I/O ports with handshake lines. RC controlled 2MHz clock.

Complete documentation. I/O lines use 50 pin edge connector. Data and address lines are not accessible. Mod. for 2532 is included. EPROM is not included. 1K RAM, 2K EPROM, 2 I/O ports.

80-280 Assm. \$129.95

CRT CONTROLLER

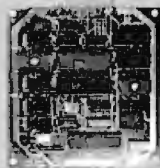

This intelligent CRT Controller uses an 8085A CPU and an 8275 Integrated CRT Controller. It features:

- 25 lines (80 char./line)
 - 5x7 dot matrix
 - Upper & lower case
 - Two 2716's (controller & char. generator)
 - Serial interface RS232 & TTL
 - Baud rates of 110, 150, 300, 600, 1200, 2400, 4800 and 9600
 - Keyboard scanning system
 - Unencoded keyboard required
 - Uses +5V & ±12V Power Supplies
 - Does not have graphic capabilities.
- Documentation includes program listing and composite video circuit.

Bare Board only (with doc) \$39.95
 2716 Char. Gen. A7 \$19.95
 2716 Program A12 \$19.95
 2716 ASCII A12 \$19.95
 11.34 MHz XTAL \$5.00

MINI VIDEO 40 X 24

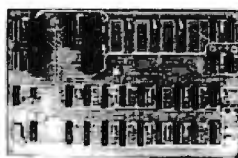

This board can be used to add a video display to your AIM or other computer. It can also, with the addition of a parallel keyboard, 5V power supply and video monitor, be used as a home computer. It will run Tom Pittman's Tiny Basic. The 2716 character gen. will produce 256 8x8 characters, ASCII upper and lower case and graphic characters. The 44 pin expansion connector can be used to add up to 6K of memory or extra I/O ports. Power requirements: 5 volts 600 MA 3 watts.

Documentation includes schematic, parts list, connector pin outs, and source listing for video display and Monitor. Control character response:

- H back space
- I up one line
- J line feed
- L clear screen and home
- M carriage return
- U forward space non destructive

The cursor is flashing underline type.

82-140A assm. W/O EPROMS \$149.95
 Character Gen. A7 \$19.95
 Tiny Basic + Monitor \$39.95
 GPIO Parallel Input \$19.95
 Bare Board with doc. \$79.95

JBE I MICROCOMPUTER

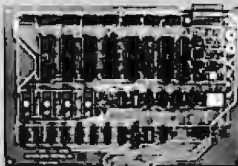

JBE's 7.75 x 11.75 6502 base Microcomputer has the capacity for 16K of EPROM, 4K of RAM, 8 Parallel Ports and 1 Serial Port. Monitor and Tiny Basic are also available.

Both versions include sockets for 2716s or 2532s, 8 16 pin sockets for I/O interfacing and a DB25 connector for RS232.

All address and data lines are brought off the board to the 50 pin edge connector. (Similar to the Apple II bus.)

This board also features power on reset and cassette interface.

81-030C Fully Populated \$399.95
 81-030M Partially Populated \$299.95
 2716 EPROM (with Tiny Basic) \$19.95

81-260 "SLIM"

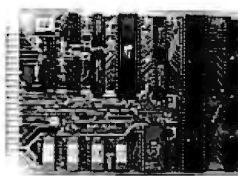

Single board large scale integration Microcomputer. This 4.5 x 6.5 board uses the 6502 Microcomputer, two 6522 VIA's four 2114 RAM's, 2516, 2716 or 2532 EPROM. The fully buffered 22/44 pin bus is similar to the KIM[®], SYM[®], and AIM[®] expansion connector. The four 8 bit I/O ports connect through 16 pin dip sockets. This board was designed for control and is ideal for Personal and OEM use.

- 6502 MPU
- Two 6522 VIA's
- Four 2114 RAM's (2K bytes)
- One EPROM 2516 or 2532
- Crystal clock 1 MHz
- Requires 5V 1AMP power
- 4.5 x 6.5 card
- Power on reset
- Fully buffered-expandable
- Solder mask-both sides

Use your Apple II Computer, JBE 6522 Parallel Interface card and EPROM Programmer as a development system for SLIM.

81-260A Assm. \$199.95

PERIPHERALS FOR SLIM



RAM EPROM Memory (32K)
 81-330A Assm. W/O Memory \$99.95
 81-330B Bare Board \$49.95

8 Slot Mother Board
 81-320A Assembled \$99.95
 81-320B Bare Board \$49.95

24 Hour Real Time Clock
 81-350A Assembled \$149.95
 81-350B Bare Board \$49.95

Analog I/O Interface
 81-036A Assembled \$199.95
 81-036B Bare Board \$49.95

12 Port Parallel I/O (6-6522S)
 82-036A Assembled \$169.96
 82-036B Bare Board \$49.95

Tiny Basic + Monitor EPROM \$39.95



JOHN BELL ENGINEERING, INC.

ALL PRODUCTS ARE AVAILABLE FROM JOHN BELL ENGINEERING, INC. • 1014 CENTER ST., SAN CARLOS, CA 94070
 ADD SALES TAX IN CALIFORNIA • ADD 5% SHIPPING & HANDLING 3% FOR ORDERS OVER \$100



SEND \$1.00 FOR CATALOG

(415) 592-8411

10% OUTSIDE U.S.A.
 ADD \$1.50 FOR C.O.D.

WILL CALL HOURS: 9am - 4pm



**BATTERY BACKUP 32K
CMOS RAM/EPROM
S-100 MEMORY BOARD
8 or 16 BIT DATA PATH
\$199 KIT, \$279 A&T**

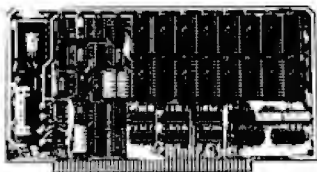

- * 6MHz
- * phantom option
- * IEEE 696 (S-100) compatible
- * extended addressing switch selectable
- * bank select
- * EPROM can be mixed with RAM

Yang Electronic Systems, Inc.

307 Compton Avenue, Laurel, MD 20707

(301) 776-0076

Circle 462 on inquiry card.

NEW FOR APPLE II®

**LOW-COST PRECISION
A/D CONVERTER**

- * IDEAL FOR MONITORING AND CONTROL
- * RESOLUTION TO ONE MILLIVOLT
- * RANGE OF ± 4.864 VOLTS
- * MAXIMUM CONVERSION TIME 200MS
- * 4 DIFFERENTIAL ANALOG INPUTS
- * 4 OPTICALLY ISOLATED DIGITAL CONTROL OUTPUTS
- * EXPANDABLE TO 64 CHANNELS
- * LOW POWER CONSUMPTION
- * CUSTOM SENSORS AND SYSTEMS AVAILABLE

\$250 WITH FULL YEAR WARRANTY

LAWSON LABS, INC.

5700 RAIBE ROAD
COLUMBIA FALLS, MONTANA 59912

406-387-5355

Circle 228 on inquiry card.



**Scotch®
DISKETTES**

Call Toll-Free
1-800-328-DISC for prices and information. Dealer inquiries invited. C.O.D. and charge cards accepted. All orders shipped from stock, within 24 hours. Call toll FREE



North Hills Corporation

3564 Rolling View Dr.
White Bear Lake, MN 55110

1-800-328-DISC

MN Call Collect 1-612-720-0485

Circle 303 on inquiry card.

THE BURNER I/O

Has a complete EPROM programmer, two serial ports, one parallel I/O port with handshaking and memory management.

Programmer features: • Programs 2704, 2708, 2508, 2758, 2716, 2516, TMS2716, 2732, 2732A, 2764 • CP/M compatible software supplied in EPROM that can be easily written on a diskette. EPROM selection is done with software. Does not use programming modules • Programmer is totally I/O mapped • Programming socket is zero insertion force type • Programming voltages generated on board.

I/O Features: • 2 fully independent RS-232 serial ports • Baud rate Generators are independently programmable from 50 to 19200 baud • Independent 8 bit output, input and status flags • 4 direct sense lines.

Memory management features: • Controls address lines A16-A23 • Is disabled with standard ADSB signal.

Options: • Complete board with programmer, I/O and memory management, \$354.95 • Programmer only, \$219.95 • I/O only, (2S + P) \$219.95 • Prog. and I/O, \$329.95 • Memory management only \$109.95.

Memory management may be added to programmer or I/O for \$25.00. All combinations are assembled and tested. Delivery Stock Shipping: UPS surface \$3.00, UPS air \$5.00.

EXTENDED PROCESSING

3861 Woodcreek Lane
San Jose, Ca. 95117
(408) 249-8248

Circle 268 on inquiry card.

Low IC Prices

2716 \$3⁴⁰

5V 2K x 8 EPROM 450ns

2732 \$4¹⁰

EPROM 450ns

2764 \$10⁴⁰

EPROM 450ns

6116P-3 \$4⁸⁰

CMOS 2K x 8 static RAM

80C85 \$17²⁰

CMOS 8085 CPU, with info

Send for catalog. Quantity prices available. Colorado residents add tax. Add \$1 shipping per order. Credit card OK.

Colorado Chips

P. O. Box 111, Frisco, CO 80443

Circle 471 on inquiry card.

**EPSON
NEW REPLACEMENT
RIBBON CARTRIDGES**

MX 70-80 \$ 4.75 ea.

MX 100 10.75 ea.

Please add \$.75 ea. handling/shipping.

LABELS

\$12.00/5000

STOCK #10350—1-15/16" x 3 1/2" x 1 wide.

White—pressure sensitive—pin feed—4w" carrier, packed 5000 per box. Add \$2.50 per box handling/shipping.

TERMS: Visa & M.C. (add 4%), check or money order. C.O.D.'s. add \$2.00, min. order \$12.00. CA residents add 6% Sales Tax.

S&W COMPUTER SUPPLY CO.

25422 TRABUCO RD. SUITE #200
EL TORO, CA. 92630 • (714) 768-0370

Circle 373 on inquiry card.



**RS232C Computer compatible
Paper Tape Transmitter/Model 612**

Stops and starts on character at all speeds, uses manual control or X-on, X-off 90-260 volt, 50-60 Hz power. 50-9600 baud, up to 150 char/sec synchronous or asynchronous; gated internal or external clock, RS 232C, current loop or parallel output, reads 5-8 level tape, 7-11 frames per character, even or odd parity. Desk top or rack mount.

Addmaster Corporation, 415 Junipero Serra Drive, San Gabriel, CA 91776, (213) 285-1121, Telex 674770 Addmaster SGAB

Circle 7 on inquiry card.

\$645 excluding shipping

- Portable Olivetti Typewriter
- Daisy Wheel Printer
- Based on the Praxis 30
- Centronics Compatible Printer

OLIVETTI APPROVED

- Already own a Praxis?
- Easy to install interface available

TO ORDER—See your local dealer or send check or money order to:

ARK Microsystems

925 Greenwood St.
Ann Arbor, MI 48104
(313) 769-7253

Circle 31 on inquiry card.

Printed Circuit A/B Switch



- Ideal for switching RS-232 devices
- High Quality Printed Circuit Board
- 325 pin D-subminiature Connectors
- 20 circuits switched



Kit & Assembly Drawing \$34.95 ppd.
Assembled & Wave Soldered \$39.95 ppd.

Visa/Master Charge (201) 227-8411

PMI

16-6 Passaic Avenue
Fairfield, New Jersey 07006

Circle 331 on inquiry card.

wabash[®] diskettes

for as low as

\$1.39 each!

Now...Get High Quality at a Low Price

Wabash means quality products that you can depend on. For over 16 years, Wabash has been making high quality computer products. Wabash diskettes are made to provide error-free performance on your computer system. Every Wabash diskette is individually tested and is 100% certified to insure premium performance.

Why Wabash is Special

The quality of Wabash diskettes is stressed throughout the entire manufacturing process. After coating, all Wabash diskettes go through a unique burnishing process that gives each diskette a mirror-smooth appearance. Wabash then carefully applies a lubricant that is specially formulated to increase diskette life. This saves you money, since your discs may last longer. It also assists your disk drives in maintaining constant speed which can reduce read and write errors.

Special Seal...Helps Prevent Contamination

To keep out foreign particles, a unique heat seal bonds the jacket and liner together. A special thermal seal which avoids contamination from adhesives, is then used to fold and seal the jacket. This results in outstanding performance and true reliability. Wabash then packages each diskette, (except bulk pack) in a super strong and tear resistant Tyvek[®] envelope. The final Wabash product is then shrink-wrapped to insure cleanliness and reduce contamination during shipment.

Each Diskette is 100% Critically Tested

Since each step in the Wabash diskette manufacturing process is subject to strict quality control procedures, you can be sure Wabash diskettes will perform for you. And every Wabash diskette meets the ultra-high standards of ANSI, ECMA, IBM and ISO in addition to the many critical quality control tests performed by Wabash. Wabash does all of this testing to provide you with consistently high quality diskettes. Reliability and data integrity - that's what Wabash quality is all about.

Flexible Disc Quantity Discounts Available

Wabash diskettes are packed 10 discs to a carton and 10 cartons to a case. The economy bulk pack is packaged 100 discs to a case without envelopes or labels. Please order only in increments of 100 units for quantity 100 pricing. With the exception of bulk pack, we are also willing to accommodate your smaller orders. Quantities less than 100 units are available in increments of 10 units at a 10% surcharge. **Quantity discounts** are also available. Order 500 or more discs at the same time and deduct 1%; 1,000 or more saves you 2%; 2,000 or more saves you 3%; 5,000 or more saves you 4%; 10,000 or more saves you 5%; 25,000 or more saves you 6%; 50,000 or more saves you 7% and 100,000 or more discs earns you an 8% discount off our super low quantity 100 price. Almost all Wabash diskettes are immediately available from CE. Our warehouse facilities are equipped to help us get you the quality product you need, when you need it. If you need further assistance to find the flexible disc that's right for you, call the Wabash diskette compatibility hotline. Dial toll-free 800-323-9868 and ask for your compatibility representative. In Illinois or outside the United States dial 312-593-6363 between 9 AM to 4 PM Central Time.

Circle 80 on Inquiry card.

SAVE ON WABASH DISKETTES

Product Description	Part #	CE quant. 100 price per disc (\$)
8" SSSD IBM Compatible (128 B/S, 26 Sectors)	F111	1.99
8" Same as above, but bulk pack w/o envelope	F111B	1.79
8" SSSD Shugart Compatible, 32 Hard Sector	F31A	1.99
8" SSDD IBM Compatible (128 B/S, 26 Sectors)	F131	2.49
8" DSDD Soft Sector (Unformatted)	F14A	3.19
8" DSDD Soft Sector (256 B/S, 26 Sectors)	F144	3.19
8" DSDD Soft Sector (512 B/S, 15 Sectors)	F145	3.19
8" DSDD Soft Sector (1024 B/S, 8 Sectors)	F147	3.19
5 1/4" SSSD Soft Sector w/Hub Ring	M11A	1.59
5 1/4" Same as above, but bulk pack w/o envelope	M11AB	1.39
5 1/4" SSSD 10 Hard Sector w/Hub Ring	M41A	1.59
5 1/4" SSSD 16 Hard Sector w/Hub Ring	M51A	1.59
5 1/4" SSDD Lanier No-problem compatible	M51F	2.99
5 1/4" SSDD Soft Sector w/Hub Ring	M13A	1.89
5 1/4" Same as above, but bulk pack w/o envelope	M13AB	1.69
5 1/4" SSDD Soft Sector Flippy Disk (use both sides)	M18A	2.79
5 1/4" SSDD 10 Hard Sector w/Hub Ring	M43A	1.89
5 1/4" SSDD 16 Hard Sector w/Hub Ring	M53A	1.89
5 1/4" DSDD Soft Sector w/Hub Ring	M14A	2.79
5 1/4" DSDD 10 Hard Sector w/Hub Ring	M44A	2.79
5 1/4" DSDD 16 Hard Sector w/Hub Ring	M54A	2.79
5 1/4" SSQD Soft Sector w/Hub Ring (96 TPI)	M15A	2.69
5 1/4" DSQD Soft Sector w/Hub Ring (96 TPI)	M16A	3.79

SSSD = Single Sided Single Density; SSDD = Single Sided Double Density; DSDD = Double Sided Double Density; SSQD = Single Sided Quad Density; DSQD = Double Sided Quad Density; TPI = Tracks per inch.

Buy with Confidence

To get the fastest delivery from CE of your Wabash computer products, send or phone your order directly to our Computer Products Division. Be sure to calculate your price using the CE prices in this ad. Michigan residents please add 4% sales tax or supply your tax I.D. number. Written purchase orders are accepted from approved government agencies and most well rated firms at a 30% surcharge for net 30 billing. All sales are subject to availability, acceptance and verification. All sales are final. Prices, terms and specifications are subject to change without notice. All prices are in U.S. dollars. Out of stock items will be placed on backorder automatically unless CE is instructed differently. Minimum *prepaid* order \$50.00. Minimum *purchase order* \$200.00. International orders are invited with a \$20.00 surcharge for special handling in addition to shipping charges. All shipments are F.O.B. Ann Arbor, Michigan. No COD's please. Non-certified and foreign checks require bank clearance.

For shipping charges add \$8.00 per case or partial-case of 100 8-inch discs or \$6.00 per case or partial-case of 100 5 1/4-inch mini-discs for U.P.S. ground shipping and handling in the continental United States.

Mail orders to: Communications Electronics, Box 1002, Ann Arbor, Michigan 48106 U.S.A. If you have a Master Card or Visa card, you may call and place a credit card order. Order toll-free in the U.S. Dial 800-521-4414. If you are outside the U.S. or in Michigan, dial 313-994-4444. Order your Wabash diskettes from Communications Electronics today.

Copyright ©1982 Communications Electronics™

Ad # 110582



Order Toll-Free! **wabash**
800-521-4414 error-free
In Michigan 313-994-4444 **diskettes**

**COMMUNICATIONS
ELECTRONICS™**

Computer Products Division

854 Phoenix □ Box 1002 □ Ann Arbor, Michigan 48106 U.S.A.
Call TOLL-FREE (800) 521-4414 or outside U.S.A. (313) 994-4444

BYTE February 1983 493

RanaSystems

EliteOne \$295.
EliteTwo \$499.
EliteThree \$649.
EliteController \$ 89.



HARDWARE/SOFTWARE

GARDEN OF EDEN COMPUTERS

13147 Cedar Street
Westminster, CA 92683

714-894-9528

24 Hours - 7 Days

Ask for our newest Price List



Circle 180 on inquiry card.

MICRO PIE

PARALLEL INTERFACE EXPERIMENTER



SIMULATES 10 ON/OFF I/O'S
CONNECTS TO TTL CMOS AND
PI CHIPS (8255-6522-6821)
SIMPLIFIES DEBUGGING
FAST SETUP...COMPACT

TEKSYM CORPORATION
14504 COUNTY ROAD 15
MINNEAPOLIS, MN. 55441

Circle 406 on inquiry card.

CONTROL DATA DISKETTES

5 1/4" SPECIFY SOFT. 10 or 16 SECTORS

	PRICE/10	PRICE/50	PRICE/100
SSSD	\$23.00	\$112.00	\$215.00
SS00	26.00	126.00	235.00
DSDD	32.00	156.00	295.00

8" SPECIFY SOFT or 32 SECTORS

	PRICE/10	PRICE/50	PRICE/100
SSSD	\$25.00	\$122.00	\$223.00
SSDD	30.00	145.00	263.00
DSDD	34.80	165.00	303.00

CALL TOLL FREE - ORDERS ONLY

800-824-7888 ALL STATES EXCEPT CA
800-852-7777 FOR CA RESIDENTS

ASK FOR OPERATOR #906

CHECKS, M.O., VISA, M.C. - ADD \$2.00 SHIPPING
CA RESIDENTS ADD 6% SALES TAX

Creativity Unlimited
P.O. Box 3304, Saratoga, CA 95070-1304

Circle 125 on inquiry card.

RTL

Relocatable Threaded Language \$150

RTL is a new language which retains the speed and extensibility of Forth but adds many additional advantages as a result of its more structured dictionary. Names, code, and variables are all stored in separate areas for easy generation of headerless, romable code. All code is relocatable. RTL supports local variables, multitasking, redirected I/O, and even allows definitions to be changed retroactively. All source code is included. Versions are currently available or under development for 68000, 6809, 8080, 280, 8086, 8088, and 6502.

RTL Programming Aids
10844 Deerwood SE
Lowell, MI 49331
(616) 897-5672

Circle 371 on inquiry card.

BASF DISKETTES

BASF Diskettes at competitive price. Call TOLL FREE (800) 235-4137 for prices and information. Visa and Master Card accepted.

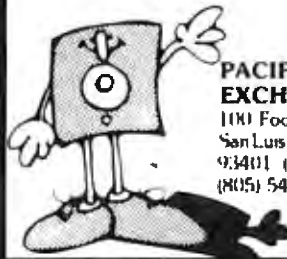

PACIFIC EXCHANGES
1181 Foothill Blvd
San Luis Obispo, CA
93401 (In Cal call
(805) 543-1037)

Circle 318 on inquiry card.

SUPER-FAST! Z80 DISASSEMBLER \$69.95

Uses Zilog Mnemonics, allows user defined labels, strings, and data spaces. Source or listing-type output with Xref to any device. Available for Z80 CP/M or TRS-80.

SLR Systems
200 Homewood Drive
Butler, PA 16001
(412) 282-0864

Add \$2.00 shipping. Specify format required. Check, money order, VISA, Master Card, C.O.D. PA residents add 6% sales tax. Dealer Inquiries Invited - CP/M, TRS-80 TM of Digital Research, Tandy Corp

Circle 383 on inquiry card.



MORROW DESIGNS DECISION 1

If you also buy either an upgrade or a terminal & printer, Else \$3995

\$2995

WIS MEG HD & 5 1/4" DSDD CP/M

Cross-in-mailboard swap maintenance program

INCLUDING MORROW \$3995 Call on all MORROW Products

Decision 1, 14 Slot 5-100, 2.50, 65K Static, 1 to 6 user (Need more memory, Software & I/O for 6 users) Desk top, with 3 Serial & 1 CP/M Wordstar, Base 800 Correct II, Logscale, Basic, Plot, & Pascal Data Base Management System

CPC also includes: Payroll, GL, AR, AP, Fixed Assets, Raw & Finished Inventory, Mail List, Transcendental Pak, Loan Amortization, 6 Function Compound Interest, 400K of CP/M Utility Source Code and StarTrek

Shipment from factory with factory warranty. Professional tutoring buddy system for beginners.

CompuPro

All CompuPro cost plus 10% or less. Shipment from distributor's stock. Call for our system prices.

TeleVideo

Computers, terminals & software at cost-plus prices

Ashton-Tate

Full line of dBase II, Financial Planning, Forecasting & related software

PRINTERS: OKI, Citoh, NEC, Diablo, M/T, etc.

TERMS: Cash with order. App 2% handling 10% on callation, 15% restocking charge FOB ship point. CALL US 9AM to 10PM 205 879-5976 205 879-4735

CostPlus COMPUTERS
P.O. Box 6114 • Birmingham, AL 35259-6114
Our bank: 1st National of Birmingham, (205)326-5120

Circle 123 on inquiry card.

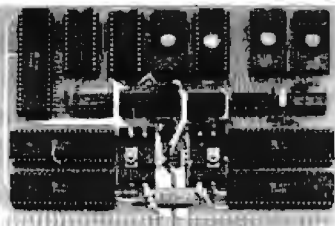

COMPACT 20K SINGLE BOARD COMPUTER

µCortex™/20K has 64 I/O lines, 6502 CPU, 4K RAM, 16K EPROM, 4 Mhz crystal, power-on 555 start-up and reset, 4 NMIs, two 7805 regulators. Support boards and software packages available. Single unit price: 2K RAM: \$159.95; 4K RAM: \$169.95 (EPROMs not included). Smaller µCortex™/65 board with 1K RAM, 2 or 4K EPROM, 16 I/O lines, 555, crystal and NMI: \$79.95. Add \$3.75 for shipping/handling. OEM discounts.

Cortex Research Corporation
1912 Raymond Dr., Northbrook, IL 60062
Phone: 312-480-1088

Circle 122 on inquiry card.

FREE! FREE! FREE! FREE! FREE!

SEND FOR OUR NEW 1983 PARTS CATALOG THOUSANDS OF SURPLUS ELECTRONIC PARTS, SUPPLIES AND DEVICES. **ALL ELECTRONICS CORP** 905 S. Vermont Ave. P.O. Box 20406 Los Angeles, Cal. 90006

Circle 14 on inquiry card.

Why use other computer media when you could be using

Scotch®

high quality error free media?

Get Scotch Diskettes Directly From Communications Electronics
There's a lot of valuable data stored on the diskettes in your computer or word processing system. In 1981, a diskette manufacturer calculated that the "true cost of a diskette" was \$186.50 after data loading. With inflation, the actual cost is well over \$200.00 today. That is why you don't want to use just any diskette, you want the high reliability and quality of Scotch diskettes. You can trust Scotch diskettes to deliver that accuracy because each diskette is tested before it leaves the factory and is certified error-free. That means fewer errors and less lost data. Flexible discs may look alike, but they don't all perform alike. Scotch diskettes can deliver all the performance you'll ever need. The low abrasivity of Scotch diskettes, 32% below industry average, saves wear and tear on your read/write heads, which means fewer service calls due to head problems. Longer and more reliable service is yours when you buy Scotch diskettes since they far exceed the industry standard durability tests. Finally, your Scotch diskettes are packaged in units of 10, complete with color-coded labels (except bulk product) to make your filing easier.

Flexible Disc Quantity Discounts Available

Scotch diskettes are packed 10 discs to a carton and five cartons to a case. Please order only in increments of 100 units for quantity 100 pricing. We are also willing to accommodate your smaller orders. Quantities less than 100 units are available in increments of 10 units at a 10% surcharge. **Quantity discounts** are also available. Order 500 or more discs at the same time and deduct 1%; 1,000 or more saves you 2%; 2,000 or more saves you 3%; 5,000 or more saves you 4%; 10,000 or more saves you 5%; 25,000 or more saves you 6%; 50,000 or more saves you 7% and 100,000 or more discs earns you an 8% discount off our super low quantity 100 price. Almost all Scotch diskettes are immediately available from CE. Our warehouse facilities are equipped to help us get you the quality product you need, when you need it. If you need further assistance to find the flexible disc that's right for you, call the 3M/Scotch flexible disc compatibility hotline. Dial toll-free 800-328-1300 and ask for the Data Recording Products Division. In Minnesota or outside the United States dial 612-736-9625 between 9 AM to 4 PM Central Time.

SAVE ON SCOTCH FLEXIBLE DISCS

Product Description	Part #	CE quant. 100 price per disc (\$)
8" SSSD IBM Compatible (128 B/S, 26 Sectors)	740-0	2.19
8" Same as above, but bulk pack w/o envelope	740-0B	1.99
8" SSSD Shugart Compatible, 32 Hard Sector	740-32	2.19
8" SSSD CPT 8000 Compatible, Soft Sector	740-0-8000	2.89
8" SSDD IBM Compatible (128 B/S, 26 Sectors)	741-0	2.89
8" DSDD Soft Sector (Unformatted)	743-0	3.49
8" DSDD Soft Sector (256 B/S, 26 Sectors)	743-0/256	3.49
8" DSDD Soft Sector (512 B/S, 15 Sectors)	743-0/512	3.49
8" DSDD Soft Sector (1024 B/S, 8 Sectors)	743-0/1024	3.49
5 1/4" SSDD Soft Sector w/Hub Ring	744D-ORH	2.34
5 1/4" Same as above, but bulk pack w/o envelope	744D-ORHB	2.14
5 1/4" SSDD 10 Hard Sector w/Hub Ring	744D-10RH	2.34
5 1/4" SSDD 16 Hard Sector w/Hub Ring	744D-16RH	2.34
5 1/4" DSDD Soft Sector w/Hub Ring	745-ORH	3.09
5 1/4" DSDD 10 Hard Sector w/Hub Ring	745-10RH	3.09
5 1/4" DSDD 16 Hard Sector w/Hub Ring	745-16RH	3.09
5 1/4" SSQD Soft Sector w/Hub Ring (96 TPI)	746-ORH	2.99
5 1/4" DSQD Soft Sector w/Hub Ring (96 TPI)	747-ORH	3.99

SSSD = Single Sided Single Density; SSDD = Single Sided Double Density; DSDD = Double Sided Double Density; SSQD = Single Sided Quad Density; DSQD = Double Sided Quad Density; TPI = Tracks per inch.

Circle 81 on Inquiry card.

Save on Scotch Static Control Floor Mats

Scotch Velostat Electrically Conductive Floor Mats, drain static charge before it can cause serious problems with computer or word processing equipment. Order number 1853 is a black 4' x 5' size mat with lip. Cost is \$170.00 each. Order number 9453 is the same mat, but the color is earthtone brown, which is designed to blend with any office decor. Cost on the 9453 mat is \$259.00 each. All Velostat mats come complete with 15 feet of ground cord. All mats are shipped freight collect.

Save on Scotch Data Cartridges

Scotch Data Cartridges are available from CE in three different configurations. The DC100A data cartridge is a small version of the DC300A data cartridge. The DC100A contains 140 feet of 0.150" tape in a package measuring 2.4 x 3.2 x 0.5 inches. Cost is \$14.00 each. The DC300A is a pre-loaded tape cartridge containing 300 feet of one mil thick by 1/4" computer tape. The DC300A costs \$18.00 each. The DC300XL is an extra length data cartridge with 450 feet of tape. It is the same size and interchangeable with the DC300A. The DC300XL provides a total storage capacity of 34.5 million bits at 1600 BPI. The cost of the DC300XL is \$22.00 each.

Scotch Head Cleaning Diskettes - Helps Cut Downtime

When the read/write heads on information processing machines are dirty, that can cause you a lot of grief. Now...with Scotch brand head cleaning diskettes, you can clean the read/write heads on the diskette drives yourself in just 30 seconds and as often as they need it. Simply apply the cleaning solution to the special white cleaning fabric. Insert the cleaning diskette into the drive and access the heads for 30 seconds. That's all there is to it. Regular use of the head cleaning diskettes can save you much of the grief caused by dirty heads. We recommend you use them once a week, or more often if your system gets heavy use. Each kit contains two head cleaning diskettes, and enough solution for 30 cleanings. Order # 5-CLE is for 5 1/4" drives and order # 8-CLE is for 8" drives. Only \$25.00 each plus \$3.00 shipping per kit.

Buy with Confidence

To get the fastest delivery from CE of your Scotch computer products, send or phone your order directly to our Computer Products Division. Be sure to calculate your price using the CE prices in this ad. Michigan residents please add 4% sales tax or supply your tax I.D. number. Written purchase orders are accepted from approved government agencies and most well rated firms at a 30% surcharge for net 30 billing. All sales are subject to availability, acceptance and verification. All sales are final. Prices, terms and specifications are subject to change without notice. All prices are in U.S. dollars. Out of stock items will be placed on backorder automatically unless CE is instructed differently. Minimum *prepaid* order \$50.00. Minimum *purchase order* \$200.00. International orders are invited with a \$20.00 surcharge for special handling in addition to shipping charges. All shipments are F.O.B. Ann Arbor, Michigan. No COD's please. Non-certified and foreign checks require bank clearance.

For shipping charges add \$8.00 per 100 diskettes and/or any fraction of 100 8-inch diskettes, or \$6.00 per 100 diskettes and/or any fraction of 100 5 1/4-inch mini-discs. For cleaning kits, add \$3.00 per kit. For tape data cartridges, add \$1.00 per cartridge, for U.P.S. ground shipping and handling in the continental United States.

Mail orders to: Communications Electronics, Box 1002, Ann Arbor, Michigan 48106 U.S.A. If you have a Master Card or Visa card, you may call and place a credit card order. Order toll-free in the U.S. Dial 800-521-4414. If you are outside the U.S. or in Michigan, dial 313-994-4444. Order your Scotch computer products from Communications Electronics today.

Copyright ©1982 Communications Electronics™

Ad # 120182



Order Toll-Free!
(800) 521-4414

In Michigan (313) 994-4444

3M

Authorized Distributor

COMMUNICATIONS ELECTRONICS™

Computer Products Division

854 Phoenix □ Box 1002 □ Ann Arbor, Michigan 48106 U.S.A.
Call TOLL-FREE (800) 521-4414 or outside U.S.A. (313) 994-4444

**DATA COMMUNICATION
SPECIALISTS FOR
IBM PC & SEATTLE
COMPUTERS**

Teleprocessing software available for above computers to time-sharing host or between two users (send binary files, also). Version 2 software, \$60; Version 3, IBM PC \$95, SEATTLE \$160. Write for details or \$3.00 for manuals.

SEATTLE 8086 GAZELLE

Computer system.

SPECIAL PRICE for SEATTLE SYSTEM (desktop) + 4-port serial board + cables + choice of Microsoft BASIC, Pascal, FORTRAN, or COBOL.

Write for literature and prices on above systems, or call for quote.



CSCS
COMPUTER & STATISTICAL
CONSULTING SERVICES

P.O. Box 5351
Terre Haute, IN 47805
(812) 466-4111

At Last!!

**POWER
TOOL!**

*Can Something
Really Transfer So
Much Information
So Well For So Little?*

The FORTEX XCopy

Really Can!

Great for Winchester backups •
Knows when the floppy is full and can
break the file • "Submit" feature
automatically copies preselected files •
Runs on CP/M, MP/M & MSDOS

Best of all, it costs only \$99!

FORTEX
SYSTEMS CORPORATION

Call Collect: 1935 New York Ave.
516-549-4713 Huntington Sta.,
N.Y. 11746

**VOI E SYNTHESIZER
VOCAB ARY DEVELOPMENT SYSTEM**

CREATE YOUR OWN CUSTOM VOCABULARIES
For TI 5220 or GI SP-250 Speech Synthesizers
Using Your S-100 or INTELLEC™ Micro

INCLUDES HARDWARE AND SOFTWARE FOR:
DMA Voice Digitizing and Playback (8 bit mu-law codec)

• Parameter Extraction and Coding • Screen Oriented
Parameter Editor • Voice Synthesis

MODEL VPP-696 for S-100 (IEEE-696 Compatible) - CP/M80
MODEL VPP-796 for INTELLEC™ MDS - ISIS II

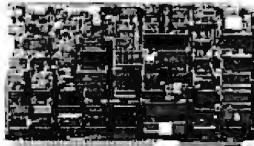

adisa corporation
APPLIED DIGITAL SIGNAL ANALYSIS
P.O. Box 1364 Palo Alto, CA 94301 (415) 326-7303
adisa is a trademark of Intel Corp

**Valuable FORTRAN Enhancements
with STRPAK™**

STRPAK is a collection of 135 sub-
routines and functions specifically
designed to enhance FORTRAN-80
with:

- String processing routines.
- Character processing routines.
- Directional character and number I/O.
- CP/M system calls and file controls.

STRPAK source code
(in RATFOR and MACRO-80): . . \$25.

RATFOR preprocessor for
FORTRAN-80: \$ 55.



Computer Company
DIVISION OF Sea Data Corporation
One Bridge Street, Newton, MA 02158
TEL. (617) 244-8190 TLX: 951107

Alphabetical LIST and database program. Designed
for variable length fields and flexibility. Enter 50
records without a disk wait.
Send selected records to screen, printer or disk file
sort or re-sort records by ANY field.

Introducing ALISTA an advanced version of ALIST
with added arithmetic capabilities.

Simplified Users Guides (ALIST or ALISTA) (Included)
MAIL/PHONE LIST REFERENCE/CITATION FILE CARDS 10.00 10.00

Users guides for ALISTA ONLY. (Included)
CHECKBOOK/BUDGET HOME INVENTORY 10.00

.LIST (Alphabetical LIST program) 150.
.LISTA (Added features) 175.

HONOR SYSTEM SOFTWARE
2562 E. Glade
Mesa, AZ 85204
(602) 892-2434

Circle 59 on Inquiry card.

VIC-H8-CRT

VIC 20 or 64 Bus Extender Board \$44*
5 slots-3 installed, gold plated contacts

VIC 20 24K Memory Expansion Board \$189*

24Kb. static 200 nano sec RAM, buffered,
low power, LED power indicator, gold
plated board contacts, socket for
EPROM (2716 type)

VIC 20 24K Memory Expansion Board
with EPROM \$239*

Same as above, 40 character screen with
EPROM (2716 type)

CRT Electronics with keyboard \$279*

For Ball Brothers or Zenith type CRT's,
reverse video, blinking, underlining, 11
baud rates, upper/lower case, 80 x 24
character screen, clear end of line, clear
end of page, clear screen

H8 16K Memory Expansion Board \$229*
16K static RAM RS232 serial, 8 line paral-
lel with line drivers

*plus shipping and handling -
Washington Residents add sales tax.

BAZ ELECTRONICS

P.O. Box 4895, Federal Way, WA 98003
(206) 874-3029



**Electronic
Circuit
Analysis**

- DC and AC analysis
- Very fast, machine language
- Infinite circuits on multiple passes
- Worst case, sensitivity analysis
- Dynamic modification
- 64 Nodes, 127 branches
- Compare circuits
- Log or linear sweep
- Full file handling
- Frequency response, magnitude and phase
- Complete manual with examples
TRS-80 (TRSDOS) \$90.00
- CP/M \$150.00

Tatum Labs
P.O. Box 722
Hawleyville, CT
06440
(203) 426-2104

I WILL BEAT ANY COMPETITOR'S PRICE
PROVIDED IT IS NOT BELOW MY COST.
TRY TO BEAT THESE IC PRICES:

DYNAMIC RAM		
64K	200 ns	\$4.85-
64K	150 ns	5.25
16K	150 ns	1.25
EPROM		
2764	250 ns	\$10.25
2732	450 ns	4.15
2716	450 ns	3.33
2532	450 ns	4.70
STATIC RAM		
6116P-3	150 ns	\$4.40
2016	100 ns	4.00
2114	200 ns	1.60
Z80A FAMILY		
CPU, CTC, or PIO		\$ 3.39
DART		7.50
DMA or SIO/O		13.50

MasterCard VISA
All Prime Parts
MICROPROCESSORS UNLIMITED
24,000 South Peoria Ave.
BEGGS, OK 74421
(918) 267-4961 and (918) 267-4796

Prices subject to change. Call for volume prices. Subject to available quantities.

FOR ONLY \$129.95 Learn Computing From The Ground Up

Build a Computer kit that grows with you, and can expand to 64k RAM, Microsoft BASIC, Text Editor/Assembler, Word Processor, Floppy Disks and more.

EXPLORER/85

Here's the low cost way to learn the fundamentals of computing, the all-important basics you'll need more and more as you advance in computer skills. For just \$129.95 you get the advanced design Explorer/85 motherboard, with all the features you need to learn how to write and use programs. And it can grow into a system that is a match for any personal computer on the market. Look at these features: 8085 Central Processing Unit, the microprocessor "heart" of the Explorer/85. (Join the millions who will buy and use the 8080/8085 in year after year.) Four 8-bit ports for input/output ports from which you can input and output your programs, as well as control exterior switches, relays, lights, etc. a cassette interface that lets you save and reload programs you've learned to write. . . . delete 2,000 byte operating systems, making it easy to learn computing in several important ways. . . . It allows simpler, faster writing and entering of programs. . . . It permits access by you to all parts of the system so you can check on the status of any point in the program. . . . It allows tracing each program step by step, with provision for displaying all the contents of the CPU (registers, flags, etc. . . .) and it does much more!

You get all this in the starting level (Level A) of the Explorer/85 for only \$129.95. Incredible! To use, just plug in your 8VDC power supply and terminal or keyboard/display — if you don't have them, see our special offers below.

- Level A computer kit (Terminal Version) . . . \$129.95 plus \$3 P&I.*
- Level A kit (Hex Keypad/Display Version) . . . \$129.95 plus \$3 P&I.*

LEVEL B — This "building block" converts the motherboard into a two-slot S100 bus (industry standard) computer. Now you can plug in any of the hundreds of S100 cards available.

- Level B kit . . . \$49.95 plus \$2 P&I.*
- S100 bus connectors (two required) . . . \$4.85 each, postpaid.

LEVEL C — Add still more computing power: this "building block" mounts directly on the motherboard and expands the S100 bus to six slots.

- Level C kit . . . \$39.95 plus \$2 P&I.*
- S100 bus connectors (five required) . . . \$4.85 each, postpaid.

LEVEL D — When you reach the point in learning that requires more memory, we'll give you two choices: either add 4k of a memory directly on the motherboard, or add 16k to 64k of memory by means of a single S100 card, our famous "JAWS".

- Level D kit (CHECK ONE) . . . 4k on-board . . . \$49.95 plus \$2 P&I.*
- 16k S100 "JAWS" . . . \$149.95 plus \$2 P&I.*
- 32k S100 "JAWS" . . . \$199.95 plus \$2 P&I.*
- 48k S100 "JAWS" . . . \$249.95 plus \$2 P&I.*
- 64k S100 "JAWS" . . . \$299.95 plus \$2 P&I.*

LEVEL E — An important "building block" it activates the ROM/EPROM space on the motherboard. Now just plug in our 8k Microsoft BASIC or your own custom programs.

- Level E kit . . . \$5.95 plus \$0.4 P&I.*

MICROSOFT BASIC — It's the language that allows you to talk English to your computer! It is available (three ways):

- 8k cassette version of Microsoft BASIC (requires Level B and 12k of RAM minimum; we suggest a 16k S100 "JAWS" — see above) . . . \$64.95 plus \$2 P&I.*
- 8K ROM version of Microsoft BASIC (requires Level B and Level C and 4k RAM; just plug into your Level E sockets. We suggest either the 4k Level D RAM expansion or a 16k S100 "JAWS") . . . \$99.95 plus \$2 P&I.*
- Disk version of Microsoft BASIC (requires Level B, 32k of RAM, floppy disk controller, 8" floppy disk drive) . . . \$325 postpaid.

TEXT EDITOR/ASSEMBLER — The editor/assembler is a software tool (a program) designed to simplify the task of writing programs. As your programs become longer and more complex, the assembler can save you many hours of programming time. This software includes an editor program that enters the programs you write, makes changes and saves the programs on cassettes. The assembler performs the clerical task of translating symbolic code into the computer-readable object code. The editor/assembler program is available either in cassette or a ROM version.

- Editor/Assembler (Cassette version; requires Level B and 8k (min) of RAM — we suggest 16k "JAWS" — see above) . . . \$49.95 plus \$2 P&I.*
- Editor/Assembler (ROM version; supplied on an S100 card; requires Level B and 4k RAM (min) — we suggest either Level D 16k "JAWS") . . . \$99.95 plus \$2 P&I.*

8" FLOPPY DISK — A remarkable "building block" that adds our 8" floppy disk when you need faster operation, more convenient program storage, perhaps a business application, and access to the literally thousands of programs and program languages available today. You simply plug them into your Explorer/85 disk system — it accepts all IBM-invented CP/M programs.

- 8" Floppy Disk Drive . . . \$49.95 plus \$12 P&I.*
- Floppy Controller Card . . . \$199.95 plus \$2 P&I.*
- Disk Drive Cabinet & Power Supply . . . \$69.95 plus \$3 P&I.*
- Drive Cables (set up for two drives) . . . \$25.00 plus \$1.50 P&I.*

CP/M 2.2 Disk Operating System includes Text Editor/Assembler, dynamic debugger, and other features that give your Explorer/85 access to thousands of existing CP/M-based programs. . . . \$15.00 postpaid.

NEED A POWER SUPPLY? Consider our AP-1. It can supply all the power you need for a fully expanded Explorer/85 (note: disk drives have their own power supply). Plus the AP-1 fits neatly into the attractive Explorer steel cabinet (see below).

- AP-1 Power Supply kit (8V @ 5 amp; fits deluxe steel cabinet) . . . \$39.95 plus \$2 P&I.*

NEED A TERMINAL? We offer you choices: the least expensive one is our Hex Keypad/Display kit that displays the information on a calculator-type screen. The other choice is our ASCII Keyboard/Computer Terminal kit that can be used with either

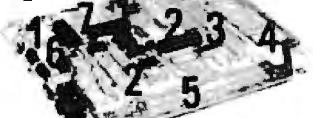

1. Plug in Netronics's Hex Keypad/Display
2. Add Level B to convert to S100
3. Add 4k RAM
4. Plug in Level E here: either Microsoft BASIC or Editor/Assembler in ROM
5. Add two S100 boards
6. Add your own custom circuits (prototyping area)
7. Connect terminal

a CRT monitor or a TV set (if you have an RF modulator).

- Hex Keypad/Display kit . . . \$69.95 plus \$2 P&I.*
- FASTERM-64 TERMINAL KIT — Featuring a 56 key ASCII Keyboard, 128 character set upper and lower case, 75 ohm output, 8 baud rates — 150 to 19,200 (switch selectable), RS232C or 20MA output 32 or 64 character by 16 line formats, complete with Deluxe Steel Cabinet and Power Supply . . . \$199.95 plus \$3 P&I.*



ORDER A SPECIAL-PRICE EXPLORER/85 PAK — THERE'S ONE FOR EVERY NEED.

- Beginner Pak (Save \$26.00) — You get Level A (Terminal Version) with Monitor Source Listing (\$25 value) AP-1 5-amp power supply, Intel8085 Users Manual. . . (Reg. \$199.95) SPECIAL \$169.95 plus \$4 P&I.*
- Experimenter Pak (Save \$53.40) — You get Level A (Hex Keypad/Display Version) with Hex Keypad/Display, Intel 8085 User Manual, Level A Hex Monitor Source Listing, and AP-1 5-amp power supply. . . (Reg. \$279.95) SPECIAL \$219.95 plus \$6 P&I.*
- Special Microsoft BASIC Pak (Save \$103.00) — You get Levels A (Terminal Version), B, D (4k RAM), E, 8k Microsoft in ROM, Intel8085 User Manual, Level A Hex Monitor Source Listing, and AP-1 5-amp power supply. . . (Reg. \$439.70) SPECIAL \$329.95 plus \$7 P&I.*
- Add a Rom-Version Text Editor/Assembler (Retains Levels B and D or S100 Memory) . . . \$99.95 plus \$2 P&I.*

Starter 8" Disk System — Includes Level A, B floppy disk controller, one CDC 8" disk-drive, two-drive cable, two S100 connectors; just add your own power supplies, cabinets and hardware . . . (Reg. \$1065.00) SPECIAL \$699.95 plus \$12 P&I.*

- 32k Starter System . . . \$1045.95 plus \$13 P&I.*
- 48k Starter System . . . \$1085.95 plus \$13 P&I.*
- 64k Starter System . . . \$1145.95 plus \$13 P&I.*
- Add to any of above Explorer steel cabinet, AP-1 five amp. power supply, Level C with two S100 connectors, disk drive cabinet and power supply, two sub-D connectors for connecting terminal. . . (Reg. \$225.00) SPECIAL \$199.95 plus \$13 P&I.*
- Complete 64K System, Wired & Tested . . . \$1650.00 plus \$26 P&I.*
- Special Complete Business Software Pak (Save \$625.00) — Includes CP/M 2.2 Microsoft BASIC General Ledger, Accounts Receivable, Accounts Payable, Payroll Package. . . (Reg. \$1325) SPECIAL \$699.95 postpaid.

*P&I stands for "postage & insurance." For Canadian orders, double this amount.

Continental Credit Card Buyers Outside Connecticut:

TO ORDER
Call Toll Free:
800-243-7428

To Order From Connecticut, or For Technical Assistance, Call (203) 354-9375

CP/M is a reg. trademark of Digital Research

★ (Clip and mail entire ad) ★

SEND ME THE ITEMS CHECKED ABOVE
Total Enclosed (Conn. Residents add sales tax) \$ _____
Paid by:

- Personal Check
- Cashier's Check/Money Order
- VISA
- MASTER CARD (Bank No. _____)

Acct. No. _____ Exp. Date _____

Signature _____

Print Name _____

Address _____

City _____ State _____ Zip _____

Kit can be used with either

NETRONICS Research & Development Ltd.
333 Litchfield Road, New Milford, CT 06776

ANNOUNCING TWO NEW TERMINALS

Smart • Fast • Graphics • Matching Modem and \$295 Printer

Netronics announces a state of the art breakthrough in terminals. Now at prices you can afford, you can go on-line with data-bank and computer phone-line services. It's all yours: "electronic newspapers," educational services, Dow-Jones stock reports, games, recipes, personal computing with any level language, program exchanges, electronic bulletin boards — and more every day!!!



Netronics offers two new terminals, both feature a full 56 key/128 character typewriter-style keyboard, baud rates to 19.2 kilobaud, a rugged steel cabinet and power supply. The simplest one, FASTERM-64, is a 16 line by 64 or 32 character per line unit, with a serial printer port for making hard copy of all incoming data, and optional provisions for block and special character graphics. The "smart" version, SMARTERM-80, features either 24 line by 80 characters per line or 16 by 40 characters per line, it offers on-screen editing with page-at-a-time printing, 12,000 pixel graphics, line graphics, absolute cursor addressing, underlining, reverse video, one-half intensity and much more. . . . simply plug them into your computer or our phone modem and be on-line instantly. Use your TV set (RF modulator required) or our deluxe green-phosphor monitor pictured above. For hard copy just add our matched printer.

Price breakthrough!!! Own the FASTERM-64, a complete terminal kit, ready to plug in for just \$199.95 or order the SMARTERM-80 kit for just \$299.95, (both available wired and tested.) Be on-line with the million-dollar computers and data services today. . . . we even supply the necessary subscription forms.

More good news: All the components in our terminals are available separately (see coupon), so you buy only what you need!!!

FASTERM-64 . . . DISPLAY FORMAT: 64 or 32 characters/line by 16 lines . . . 96 displayable ASCII characters (upper & lower case) . . . 8 baud rates: 150, 300, 600, 1200, 2400, 4800, 9600, 18,200 (switch select) . . . LINE OUTPUT: RS232C or 20 ma current loop . . . VIDEO OUTPUT: 1V P/P (EIA RS-170) . . . CURSOR MODES: home & clear screen, erase to end of line, erase cursor line, cursor up & down, auto carriage return/line feed at end of line & auto scrolling . . . REVERSE VIDEO . . . BLINKING CURSOR . . . PARITY: off, even or odd . . . STOP BITS: 1, 1.5, 2 . . . DATA BITS PER CHARACTER: 5, 6, 7 or 8 . . . CHARACTER OUTPUT: 5 by 7 dot matrix in a 7 by 12 cell . . . PRINTER OUTPUT: prints all incoming data . . . 1K ON BOARD RAM . . . 2K ON BOARD ROM . . . CRYSTAL CONTROLLED . . . COMPLETE WITH POWER SUPPLY . . . OPTIONAL GRAPHICS: POE; includes plus 30 special graphics characters . . . ASCII ENCODED KEYBOARD: 56 key/128 characters.

SMARTERM-80 . . . DISPLAY FORMAT: 80 characters by 24 lines or 40 characters by 16 lines 1280 displayable ASCII characters (upper & lower case) 8 baud rates: 110, 300, 600, 1200, 2400, 4800, 9600, 19,200 . . . LINE OUTPUT: RS232C or 20 ma current loop . . . VIDEO OUTPUT: 1V P/P (EIA RS-170) . . . EDITING FEATURES: insert/delete line, insert/delete character, forward/back tab . . . LINE OR PAGE TRANSMIT . . . PAGE PRINT FUNCTION . . . CURSOR POSITIONING: up, down, right, left, plus absolute cursor positioning with read back . . . VISUAL ATTRIBUTES: underline, blink, reverse video, half intensity, & blank . . . GRAPHICS: 12,000 pixel resolution block plus line graphics . . . ON-SCREEN PARITY INDICATOR . . . PARITY: off, even or odd . . . STOP BITS: 110 baud 2, all others 1 . . . CHAR. OUTPUT: 7 by 11 character in a 9 by 12 block . . . PRINTER OUTPUT . . . 60 OR 50 HZ VERTICAL REFRESH . . . BLINKING BLOCK CURSOR . . . CRYSTAL CONTROLLED . . . 2K ON BOARD RAM . . . ASCII ENCODED KEYBOARD: 56 key/128 character . . . 4K ON BOARD ROM . . . COMPLETE WITH POWER SUPPLY.

TELEPHONE MODEM 103 O/A . . . FULL DUPLEX, FCC APPROVED . . . DATA RATE: 300 baud . . . INTERFACE: RS232C and TTY . . . CONTROLS: talk/data switch (no need to connect and disconnect phone), originate/answer switch on rear panel . . . NO POWER SUPPLY REQUIRED.

ASCII KEYBOARD ASCII-3 . . . 56 KEY/128 CHARACTER ASCII ENCODED . . . UPPER & LOWER CASE . . . FULLY DEBOUNCED . . . 3 VOLT FOLLOWER . . . POE OR NEG LOGIC WITH POE SENSITIVE . . . PRINTERS + 5 & -12V DC (SUPPLIED FROM VIDEO BOARDS)

REQUIRE COMET I . . . SERIAL I/O TO 9600 BAUD . . . 80 CHARACTER COLUMN (32 COMPRESSED) . . . 10" TRACTOR FEED . . . UPPER/LOWER CASE . . . INDUSTRY STANDARD RIBBONS . . . 4 CHARACTER SIZES . . . 9 BY 7 DOT MATRIX . . . BI-DIRECTIONAL PRINTING



Continental U.S.A. Credit Card Buyers Outside Connecticut
CALL TOLL FREE 800-243-7428

To Order From Connecticut Or For Tech. Assist. Call (203) 354-9375
NETRONICS R&D LTD. Dept.
333 Litchfield Road, New Milford, CT 06776
Please send the items checked below:

- COMPLETE FASTERM-64 TERMINAL (includes FASTVID-64 video board ASCII-3 keyboard, steel cabinet and power supply) . . . kit \$199.95 plus \$3 P&I . . . wired & tested \$249.95 plus \$3 P&I . . . graphics option: add \$19.95 to each of above
- COMPLETE SMARTERM-80 TERMINAL (includes SMARTVID-80 video board, ASCII-3 keyboard, steel cabinet and power supply) . . . kit \$299.95 plus \$3 P&I . . . wired and tested \$369.95 plus \$3 P&I
- FASTVID-64 VIDEO BOARD (requires +5 & -12V DC) . . . kit \$99.95 plus \$3 P&I . . . graphics option add \$19.95 . . . wired & tested \$129.95 plus \$3 P&I . . . graphics option add \$19.95
- SMARTVID-80 VIDEO BOARD (requires +5 & +/-12V DC) . . . kit \$199.95 plus \$3 P&I . . . wired & tested \$249.95 plus \$3 P&I
- DELUXE STEEL TERMINAL CABINET . . . \$199.95 plus \$3 P&I
- ASCII-3 KEYBOARD (requires +5 & -12VDC) . . . kit \$69.95 plus \$3 P&I . . . wired and tested \$89.95 plus \$3 P&I
- POWER SUPPLY (powers ASCII-3 keyboard & video boards) . . . kit only \$19.95 plus \$2 P&I
- ZENITH VIDEO MONITOR (high resolution green phosphor) . . . wired & tested \$149.95 plus \$6 P&I
- TELEPHONE MODEM MODEL 103 O/A . . . wired & tested \$189.95 plus \$3 P&I
- DOT MATRIX PRINTER Comet 1 . . . wired & tested \$299.95 plus \$10 P&I
- RF MODULATOR MOD RF-1 . . . kit only \$8.95 plus \$1 P&I
- 3FT-25 LEAD MODEM/TERMINAL OR PRINTER/TERMINAL CONNECTOR CABLE . . . \$14.95 ea plus \$2 P&I

For Canadian orders, double the postage. Conn. res. add sales tax.

Total Enclosed \$ _____
 Personal Check Cashier's Check/Money Order
 VISA MasterCard (Bank No. _____)
Acct. No. _____ Exp. Date _____
Signature _____
Print Name _____
Address _____
City _____ State _____ Zip _____

LIFE ISN'T CHEAP.

SHARE THE COST OF LIVING.

GIVE TO THE AMERICAN CANCER SOCIETY.

THE SPACE CONTAINED AS A PUBLIC SERVICE

And then there were none.



The list of already extinct animals grows . . . the great auk, the Texas gray wolf, the Badlands bighorn, the sea mink, the passenger pigeon . . .

What happens if civilization continues to slowly choke out wildlife species by species?

Man cannot live on a planet unfit for animals.

Join an organization that's doing something about preserving our endangered species. Get involved. Write the National Wildlife Federation, Department 105, 1412 16th Street, NW, Washington, DC 20036.



It's not too late.

SUNNY LOW LOW COST POWER SUPPLIES (LINEAR & SWITCHING) FOR S-100, DISK DRIVES

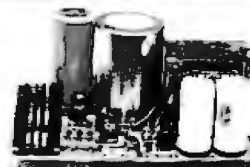
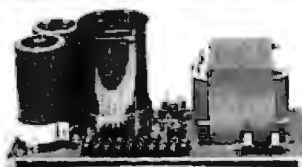

S-100 & Two Disk ST.

+24V(OR 12V)

S ₃	SLOT								
S ₄	(1 Floppy & 1 Hard Disk) 6 SLOT & 2 FLOPPY	4A	1A	4-5A PEAK	8A	3A	8 3/4" x 5" x 4 3/4"	92.95	

DISK POWER SUPPLIES: OPEN FRAME, ASSY. & TESTED, REGULATED, ADJUSTABLE & FUSES PROTECT.

H0	2 x 8 SLIMLINE	2.5A		2.5A - 5A PEAK			5" x 4" x 4"	45.95
R-1	2 x 8" or 2 x 5 1/4" DISK	3A	1A	3A - 5A Peak	2A		8" x 4" x 3 3/4"	54.95
R-2	3 x 8" (or 5 1/4") FLOPPY	6A	1A	6A - 8A Peak		1. 8 1/2" x 5" x 4 5/8" or 2. 10" x 4 7/8" x 3 3/4"		69.95
R-3	or 1x Floppy & 1x Hard	6A	1A	6A - 8A Peak		1. 9" x 6 1/4" x 4 3/8" or 2. 9" x 5 1/4" x 5 1/4"		69.95

OPTION: ±12V @ 1A CAN BE ADDED TO ITEM "R₃" SIZE 1. ONLY, COSTS \$12.00 MORE.

S-100 POWER SUPPLY KITS (OPEN FRAME WITH BASE PLATE, 3 HRS. ASSY. TIME)

ITEM	(IDEAL FOR)	+8V	-8V	+16V	-16V	+28V	SIZE: WxDxH	PRICE
KIT 1	15 CARDS	15A	---	2.5A	2.5A	---	12" x 5" x 4 7/8"	54.95
KIT 2	20 CARDS	25A	---	3A	3A	---	12" x 5" x 4 7/8"	61.95
KIT 3	DISK SYSTEM	15A	1A	3A	3A	5A	13 1/2" x 5" x 4 7/8"	69.95

6 SLOT MAINFRAME ASSY. & TESTED ONLY \$399.95 + SHIPPING \$18.00

FOR TWO EA. 8" THINLINE FLOPPY (TANDON TM848-1 SS/DD & TM848-2 DS/DD OR EQUIV.) OR ONE HARD DISK. • 110/220 VAC, 50/60 HZ, EMI FILTER & POWER ON/OFF INDICATOR • POWER SUPPLY: +8V/8A, ±16V/3A, +5V/5A OVP, -5V/1A & 24V/5A • S-100 BUS 6 SLOT CARD CAGE • 1 EA. AC CORD, 2 EA. DC CABLES WITH POWER CONNECTOR FOR DISK DRIVES • 4.5" COOLING FAN • 7 EA. DB25 CUT-OUTS, 1 EA. 50 PIN & 1 EA. CENTRONIC CUT-OUTS • CUSTOM FINISH & LOGO-LESS, COMPACT SIZE: 12"(W) x 19"(D) x 9.8"(H) 34 1 RS

DEALER INQUIRIES INVITED

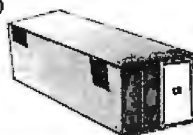

SHIPPING FOR EA. PWR SUPPLY: \$5.50 IN CALIF; \$8.00 IN OTHER STATES; \$18.00 IN CANADA. FOR EA. TRANSFORMER: \$5.00 IN ALL STATES; \$12.00 IN CANADA. CALIF. RESIDENTS ADD 6.5% SALES TAX.

ATTENTION O.E.M.'S
YOUR SPECIAL NEEDS OR DESIGNS OF TRANSFORMER LINEAR & SWITCHING PWF SUPPLY WILL BE MADE TO ORDER AT SUNNY LOW LOW COST & FASTEST DELIVERY.

MAILING ADDRESS:
P.O. BOX 4296
TORRANCE, CA 90510
TELEX. 182558

SUNNY INTERNATIONAL
(TRANSFORMERS MANUFACTURER)
(213) 328-2425 MON-SAT 9-6

SHIPPING ADDRESS:
22129 1/2 S. VERMONT AVE
TORRANCE, CA 90502



WE WILL NOT BE UNDERSOLD

TERMINALS

Zenith ZT-1	\$679.00
Zenith ZT-100	\$595.00
Televideo 910+	\$595.00
Televideo 925	\$779.00
Televideo 950	\$969.00

RAM

16K Ram Kit for Apple II, TRS80 200 nano seconds; 4116 chips	\$17.50
---	---------

DISKETTES

Maxell 5 1/4" single side	\$39.00
Maxell 8" single side	\$49.00
Maxell 5 1/4" double side	\$45.00
Maxell 8" double side	\$55.00
BASF 5 1/4"	\$26.95
BASF 8"	\$36.00
Verbatim 5 1/4"	\$26.95
Verbatim 8"	\$36.00
5 1/4 File Box	\$19.95

TELECOMMUNICATIONS

Novation Cat Modem	\$139.00
Novation D-CAT	\$155.00
Novation AUTO-CAT	\$209.00
Novation APPLE CAT	\$319.00
Hayes Smart Modem	\$249.00
Hayes Smart Modem 1200	\$589.00
Hayes Micro-Modem	\$319.00
Hayes Chronograph	\$229.00
Signalman Mark I	\$85.00

COMPUTERS

Sanyo MBC 100 64K	CALL
Call for information on the complete Sanyo line.	
Sanyo MBC 1200	CALL
Sanyo MBC 2000	CALL
Sanyo MBC 3000	CALL
Sanyo MBC 4000	CALL
Franklin Ace 1000	CALL
ZENITH	
Z-89 48K	CALL
Z-90 64K	CALL
Z-100	CALL
Call for prices on the complete Zenith line.	

SOFTWARE

MICROPRO™	
WordStar	\$379.00
MailMerge	\$195.00
Customization Notes	\$359.00
SpellStar	\$195.00
DataStar	\$259.00
CalcStar	\$119.00
MICROSOFT	
Basic Interpreter	\$349.00
Basic Compiler	\$389.00
Fortran 80	\$499.00
Cobol 80	\$695.00
DATA BASE	
dBase II	\$495.00

The CPU Computer Corporation
Announces:

CPUnet™

The Local Area Network that uses
real CP/M™ for Apples. CPUnet™
allows you to run hundreds of
popular CP/M™ programs, on your
Apple terminals, without disk drives!
Call for more information.

\$2995.00

APPLE ACCESSORIES

16K Card by Microsoft	\$79.00
32K Card by Saturn	\$199.00
64K Card by Saturn	\$419.00
128K Card by Saturn	\$585.00
Softcard Plus by Microsoft	CALL
Keyboard Enhancer II by Videx	\$125.00
Videoterm by Videx	\$259.00
Game Paddles by TG	\$49.00
Joystick by TG	\$49.00
Pkaso Cards	CALL
ALF 3 Voice Board	\$229.00
System Saver by Kensington	\$75.00
Microbuffer II 16K w/graphics	\$259.00
Microbuffer II 32K w/graphics	\$229.00
APPLE INTERFACE CARDS BY CCS	
Serial Asynch #7710	\$139.00
Centronics #7729	\$149.00
ADVANCED LOGIC	
Add-Ram 16K Card	\$79.00
Z-Card CP/M for the Apple II	\$225.00
Smarterm 80 Column Board w/Softswitch	\$249.00

APPLE SOFTWARE

MICROPRO™	
WordStar	\$379.00
MailMerge	\$190.00
SpellStar	\$190.00
DataStar	\$259.00
CalcStar	\$115.00
VISICORP	
VisiCalc	\$199.00
VisiTerm	\$79.00
VisiDex	\$199.00
VisiPlot	\$169.00
VisiFile	\$199.00
VisiSchedule	\$259.00
VisiTrend/Plot	\$239.00
MISCELLANEOUS	
Micro/Terminal	\$79.00
Screenwriter II	\$129.00
Executive Briefing System	\$169.00
Supercalc	\$279.00
Personal Filing System	\$115.00
PFS Report Writer	\$75.00
Word Handler	\$169.00
PFS Graph	\$99.00
Multiplan by Microsoft	\$229.00

PRINTERS

NEC 7710 Serial	\$2395.00
NEC 7720 KSR	\$2749.00
NEC 7730 Parallel	\$2395.00
NEC 3510 Serial	\$1850.00
NEC 3520	\$2099.00
NEC 3530 Parallel	\$1850.00
NEC 3550 for the IBM PC	\$2095.00
Antex "Generic Model of the Prowriter"	\$479.00
Epson MX-80	CALL
Epson MX-80FT	CALL
Epson MX-100	CALL
IDS Micro Prism	CALL
IDS PRISM 80	CALL
IDS PRISM 132	CALL
Okidata Microline 80	CALL
Okidata Microline 82A	CALL
Okidata Microline 83A	CALL
Okidata Microline 84	CALL

MONITORS

Sanyo 9" B&W	\$159.00
Sanyo 9" Green	\$165.00
Sanyo 12" B&W	\$179.00
Sanyo 12" Green	\$199.00
Sanyo 13" Color	\$399.00
SMD 13" Color	\$329.00
Zenith 12" Green	\$99.00
Zenith 13" Color	\$339.00
Electrohome 13" Hi-RES Color Monitor	\$829.00
Electrohome 13" Color	\$379.00
Electrohome 12" B&W	\$179.00
Electrohome 12" Green	\$189.00
Electrohome 9" B&W	\$149.00
Electrohome 9" Green	\$159.00

DISK DRIVES

CCI 100 for the TRS-80 Model 1 5 1/4" 40 track	\$299.00
CCI 189 for the Zenith Z-89 5 1/4" 40 track	\$379.00
CORVUS 5M with Mirror	\$2895.00
CORVUS 10M with Mirror	\$4195.00
CORVUS 20M with Mirror	\$4895.00
CORVUS Interfaces	CALL
RANA SYSTEMS add-on Disc Drive for the Apple II	
Elite One 40 Track	CALL
Elite Two 80 Track	CALL
Elite Three	CALL
Elite Controller	CALL

IBM PC ACCESSORIES

64K Card by Microsoft	\$299.00
128K Card	\$469.00
192K Card	\$599.00
256K Card	\$789.00
Quaddram	CALL
Joystick by TG	\$49.00
Combo Card by Apparat	\$249.00
Tandon TM 100-2 for the IBM	CALL
Call for more IBM PC add-ons.	

IBM PC SOFTWARE

INFORMATION UNLIMITED	
Easy Writer	\$289.00
Easy Speller	\$149.00
Easy Filer	\$319.00
VISICORP	
VisiCalc 256K	\$199.00
VisiFile	\$219.00
VisiTrend/VisiPlot	\$259.00
VisiDex	\$209.00
VisiTerm	\$99.00
MICROPRO™	
MailMerge	\$195.00
WordStar	\$379.00
MISCELLANEOUS	
Supercalc by Sorcim	\$279.00
Superwriter by Sorcim	\$289.00
Home Accounting Plus	\$139.00
ENTERTAINMENT	
Deadline	\$39.00
Temple of Apschai	\$29.00
Curse of Ra	\$15.99
Call For More IBM Software And Accessories	

CP/M is a registered trademark of Digital Research.

**TO ORDER CALL TOLL FREE
1-800-343-6522**

For fast delivery, send certified checks, money orders, or call to arrange direct bank wire transfers. Personal or company checks require one to three weeks to clear. All prices are mail order only and are subject to change without notice. Call for shipping charges.



The CPU Shop



DEALER INQUIRIES PLEASE CALL 1-800-343-7036

420-438 Rutherford Ave., Dept. BY14, Charlestown, Massachusetts 02129

Hours 9 AM - 9 PM (EST) Mon.-Fri. (Sat. till 6)
Technical information call 617/242-3361

TWX- 710-348-1796
Circle 124 on inquiry card.

Massachusetts Residents call 617/242-3361
Massachusetts Residents add 5% Sales Tax

TRUE MAIL ORDER PRICES

With so many so-called Mail Order establishments using "toll free" lines, and grandiose advertising, how can you, the customer, expect to receive true mail order savings? We have done away with large ads, and free phone lines to offer comparable service passing on the savings to you.

THINK! You still SEND YOUR MONEY in the mail to an unknown untested party, and delivery is still often doubtful and certainly protracted in most cases.

PRINTERS	LETTER QUALITY	IBM	NEC PERSONAL COMPUTER
OKIDATA 80 no tractor \$ 319 80 with tractor \$ 369 82A no tractor \$ 419 82A with tractor \$ 459 83A \$ 669 84A parallel \$ 1009 84A serial \$ 1119 2K Buffer \$ 50 Graphics 82A, 83A \$ 73	serial or parallel C-Itoh F10 \$1345 Brother HRI \$ 849 Smith Corona TPI \$ 569	Monte Carlo Card 64K \$ 399 I.C. Magic \$ 69	PC-8001 \$699 PC-8012 \$459 PC-8031 \$699 COMING!—NEW NEC-APC
C-Itoh SPECIAL Comet II (125 cps) \$ 499 Full 15" width text printer	PRINTER CONNECTORS TRS-80 Cables only \$ 22 Apple Int. & Cable \$ 75 Atari-printer Cable \$ 24 IBM PC-printer Cable \$ 24 Male Centronics-printer Cable \$ 24 RS232 male-male \$ 19 <i>Configured for any computer, please specify your computer.</i> IDS Cable \$ 33 Apple Graphics Card with Cable to Epson/NEC/C-Itoh \$ 89	VERBATIM 5 1/4" SS/SD \$22.50 5 1/4" SDD \$24.00 5 1/4" DSSD \$35.00 8" DS/DD \$39.00 8" SS/DD \$35.00 Available in soft sector and hard sector 10/16	GENERIC DISKETTES 5 1/4" SS/SD in plastic library case \$21 Library Cases Alone 5 1/4" \$ 2.50 8" \$ 3.50
C-Itoh PRINTERS 80 col. parallel printer \$ 449 80 col. serial printer \$ 589 132 col. parallel printer \$ 679 132 col. serial printer \$ 729 Prac. Peripheral 8K Serial Buffer with X on/off Epson \$ 111 Graphics Prowriter (120 cps) \$ 444	MONITORS Zenith ZVM-121 Green \$ 90 TECO ED 1200 line hires Green \$ 111 NEC Anti Glare Green \$ 155 AMDEK 300G \$ 155 AMDEK Color \$ 333 AMDEK Color II (IBM Available) \$699	IBM/APPLE DRIVES Tandon TMS-100-1 \$202 TMS-100-2 \$265 TMS-100-4 \$383 Software patch for IBM \$ 66 RANA Elite 1 Add on Drive \$333 Quad drive Apple controller For Elite 2/3/4 \$ 99 write for price/availability \$ 99 DAVONG (Apple and IBM) 5 MB \$1525 10 MB \$2025 15 MB \$2245	MODEMS Hayes Smart Modem \$212 Hayes Micro Modem \$259 Hayes Chronograph \$179 Apple - Cat II \$279 IBM - Smart Modem Cables \$ 22 RAM CARDS Apple 16K Card \$ 66 32K Card \$125 IBM 64K Quad Board \$375 Apple Vista Vision 80 \$242
STAR PRINTERS Gemini 10 and 15. Call for Pricing			

Send orders and inquiries to:

Computer Apparatus™
P.O. Box 32063 • Aurora, CO 80041

TELEPHONE ORDER INQUIRIES:
(303) 759-9251

10 a.m. to 2 p.m. Mountain Time. Monday to Friday.

We have access to a vast range of computer products from the many stocking distributors in Denver. We cater for a range of brand name peripherals and software for TRS-80, Apple, IBM, Atari and CP/M users. SEND in a card stating your interests for our free catalog.

DELIVERIES: 4-6 weeks at worst, all orders are fully dated. (Includes mail and shipping time).
PERSONAL CHECKS: OKAY, but cashiers checks, money orders, etc., will receive shipping preference
VISA AND MASTERCARD: Add 4% to total we CHARGE only WHEN we SHIP.
CATALOG: Descriptions/charts/pricing and availability on all our products. Prices subject to change without notice
SHIPPING: VIA UPS add \$2.00 plus 1% of order total. All brands are registered trademarks.

Please Circle Inquiry Card to
Receive Our Comprehensive Catalog

Best Price • Good Quality • Swift Delivery • Export

COMPUTER	PRINTER	IBM PC
The Best Graphic Personal Computer LNW 801 Z80A, 65K, 480 x 192. \$1,250 WCP/M board. \$1,500	EPSON MX80 F/T Graftrax \$525 MX100 \$679	AMDEK 310 monitor \$189 IDS Microprism 480 \$525 EPSON MX 80 F/T \$520 NEC 3550 letter quality \$1,945 C.I.TOH F-10 40cps \$1,395 Microsoft 128K RAM \$360 EASY WRITER II IUS \$255 CP AIDS Master Tax \$1,195 LEGAL TIMEKEEPING STAR \$725 Digital Research Pascal MT + 86 \$310 Concurrent CP/M 86 \$299 Peachtree GL, AR, AP \$330 Structured Systems Accounting \$700
Multiuser Business/Engineer CROMEMCO Best Price Anywhere CS1 5 1/4" floppy, Z80 \$2,956 CS1H W/5 MB hard disk \$5,247 CS102E 256K RAM, 88000 & Z80 two 5 1/4" floppy \$4,087 no error correction \$3,747 CS1D2 512K RAM, 6800 & Z80 two 8" floppy \$7,397 C10 84K, 12" monitor Z80A, keyboard \$1,090	Integral Data System MICROPRISM 75 cps excellent print/110 cps 84 x84 graphic, RS232/parallel pin & friction feed \$525 PRISM 80 200 cps, 80 col. \$945 w/graphics 84 x84 \$1,025 PRISM 132 200 cps, 132 col. \$1,100 w/graphics 84 x84 \$1,180 graphic, color, friction \$1,590 TI 810 Superb \$CALL OKIDATA MICROLINE 84 parallel \$1,025 PRINTEK 920 340cps, 144 x 144 \$2,450	DIGITIZER/PLOTTER HOUSTON INSTRUMENT HI PAD DIGITIZER DT-11 11" x 11" \$725 AMDEK AMPLER 11" x 14" \$780
Professional/Word Process ZENITH NORTH STAR Z90-80, 64K \$2,050 HORIZON, 1 quad drive, HD5 \$3,999 ADVANTAGE 2 \$2,999 CROMEMCO 64K, 12" monitor, 390K floppy, letter quality printer, CP/M type O.S. + word processing + spreadsheet \$2,600	*Letter Quality* C.I.TOH Starwriter F-10 40 cps \$1,395 QUIME 9/45 \$1,840 DIABLO 620 \$1,238 BROTHER HR-1 Parallel \$950 NEC 7710 \$2,299 3550 \$1,945	DISK DRIVE Mitsubishi 8" DD, DS bare \$410 dual 8" subsystem \$1,099 Tandon 5 1/4" DD, DS bare \$280
Zenith 16-Bit Z-110 dual drives, 128K RAM color board, 225 x 640 graphic, IBM PC compatible \$2,998 ZVM-134 superb color monitor \$528	TERMINAL ZENITH Z19 smart terminal \$835 ZT-1 w/modem telecom \$580 HAZELTINE ESPRIT II \$588 III \$788 BEEHIVE DM5 A \$995 IBM 3101-10 \$1,295 TELEVIDEO 970 \$1,119 VISUAL 300 \$948	SOFTWARE dBASE II Ashton-Tate database \$499 CONDOR II BASIC 80 \$450 MICROSOFT BASIC 80 \$285 Micro Pro WORDSTAR \$295 MAILMERG \$105 Digital Research CP/M 2.2 \$139 Accounting Plus System Plus \$399
16-bit CPU WICAT S150 1FS 1-user \$7,520 256K RAM, CRT, 2 floppies *68000* S150 WS 1-user \$8,999 256K RAM, 10MB hard disk, 960KB floppy CRT, OS + 1 language S150-3 WS 3-users \$10,800 same as S150 WS S150-6 WS 6-users \$12,800 512K RAM same as S150 WS Graphics 300 x 400 \$900 DUAL 68000, 512K RAM, 20MB hard disk, IBM floppy, UNIX, S100 \$14,500 ALDOS ACS8600-12 500K RAM 20MB hard disk \$9,750 Business System Software \$1,995 TERAK, SWTPC, TELEVIDEO, NEC Call	MONITOR ZENITH 12" green \$114 COLOR IV 720 x 400 \$1,050 COLOR II RGB 13" \$725 COLOR I 13" \$340 300 G 12" green \$169 SANYO 13" RGB \$875 NEC 12" green \$170 1203 RGB \$725 Electrohome RGB 580 x 235 \$999	CALL (212) 937-6363 free catalogue Prices subject to change. American Express, Visa/Mastercard add 3% F.O.B. point of shipment. 20% restocking fee for returned merchandise. Personal checks take 3 weeks to clear. COD on confirmed check only. N.Y. residents add sales tax. Manufacturers' warranty only. International customers, please confirm price before order. Accept P.O. from Fortune 500 & schools.
	MODEM D.C. Hayes Smartmodem 300 baud \$220 300/1200 baud \$570 Novation CAT 300 baud \$165 1200 baud \$590	Computer Channel TELEIX: 21-65 44th Road 429418 Long Island City, NY 11101 CSTNY

Computer Channel

8" Disk Drive Double-Density \$249.95

Printers on Sale



PRINTER PRICES SLASHED !!!

High speed dot matrix printers with all the features of the higher-priced best-selling machines for a lot less money!!! 100 CPS, 9 x 9 dot matrix with true lower case descenders, high-resolution bit image and block graphics, superscript & subscript, underlining, backspacing, double strike and emphasized print modes, proportional space font, friction feed, tractor feed, and roll paper, 5, 6, 8 1/2, 10, 12, & 17 pitch, programmable line spacing, FREE 2.3K buffer, Epson pin and plug compatible, user replaceable print head, extended 6 month factory warranty.

PRM-66010 10" wide carriage \$439.95
 PRM-66015 15" wide carriage \$569.95
 PRA-66100 Apple card & cable \$45.00
 PRA-66200 Serial interface card \$69.95

HIGH-SPEED, HIGH QUALITY - Okidata

Microline 82A 80/132 column, 120 CPS, 9 x 9 dot matrix, friction feed, pin feed, adjustable tractor feed (optional), handles 4 part forms up to 9.5" wide, rear & bottom feed, paper tear bar, 100% duty cycle/200,000,000 character print head, bi-directional/logic seeking, both serial & parallel interfaces included, front panel switch & program control of 10 different form lengths, uses inexpensive spool type ribbons, double width & condensed characters, true lower case descenders & graphics
 PRM-43082 with FREE tractor CALL

Microline 83A 132/232 column, 120 CPS, forms up to 15" wide, removable tractor, plus all the features of the 82A.
 PRM-43083 with FREE tractor CALL

Microline 84 132/232 column, Hi-speed 200 CPS, full dot graphics built in, plus all the features of the 83A.
 PRM-43084 Centronics parallel CALL
 PRM-43085 Serial with 2K buffer CALL

PRA-27081 Apple card \$39.95
 PRA-27082 Apple cable \$19.95
 PRA-27087 TRS-80 cable \$24.95
 PRA-43081 2K hi speed serial card \$149.95
 PRA-43082 Hi-res graphics ROMs 82A \$49.95
 PRA-43083 Hi-graphics ROMs 83A \$49.95
 PRA-43088 Tractor option for 82A \$49.95
 PRA-43080 Extra ribbons pkg. of 2 \$9.95

8023 DOT MATRIX - NEC

100 CPS, proportional spacing, hi-resolution graphics, correspondence quality printing, bi-directional tractor & friction feed.
 NEC-8023A 8023 parallel \$499.95
 NEC-8023-01 8023 ribbon \$11.95

Letter Quality Printers

LETTER QUALITY PRINTER - Jade

Uses standard daisy wheels and ribbon cartridges, 16 CPS bi-directional printing, semi-automatic paper loader (single sheet or fan fold), 10/12/15 pitch, up to 16" paper, built-in noise suppression cover.
 PRD-11001 Centronics parallel \$899.95
 PRD-11002 RS-232C serial model \$969.95
 PRA-11000 Tractor Option \$119.95

STARWRITER F-10 - C. Itoh

New 40 CPS daisy wheel printer with full 15" carriage, uses standard Diablo print wheels and ribbons, both parallel and serial interfaces included.
 PRD-22010 Starwriter F-10 \$1495.95

TP-1 LETTER QUALITY - SCM

12 CPS daisy wheel printer from Smith Corona.
 PRD-45101 Centronics parallel \$648.95
 PRD-45102 RS-232C serial \$648.95

PRINTER PALS - F.M.J. Inc.

Desk top printer stand and continuous form paper holder.
 PRA-99080 for MX-80, MX-80FT, Oki 82A, NEC .. \$29.95
 PRA-99100 for MX-100, Oki 83A & 84 \$34.95
 PRA-99700 for letter quality printers \$49.95

8" Disk Drives

Siemens FDD 100-8 single-sided double-density
 MSF-201120 \$274.95 ea 2 for \$249.95 ea

Shugart SA810 half-size single-sided double-density
 MSF-108100 \$424.95 ea 2 for \$394.95 ea

Shugart SA860 half-size double-sided double-density
 MSF-108600 \$574.95 ea 2 for \$549.95 ea

Shugart SA801R single-sided double-density
 MSF-10801R \$394.95 ea 2 for \$389.95 ea

Shugart SA851R double-sided double-density
 MSF-10851R \$554.95 ea 2 for \$529.95 ea

Tandon TM848-1 single-sided double-den thin-line
 MSF-558481 \$379.95 ea 2 for \$369.95 ea

Tandon TM848-2 double-sided double-den thin-line
 MSF-558482 \$494.95 ea 2 for \$484.95 ea

Qume DT-8 double-sided double-density
 MSF-750080 \$524.95 ea 2 for \$498.95 ea

5 1/4" Disk Drives

Tandon TM100-1 single-sided double-density 48 TPI
 MSM-551001 \$219.95 ea 2 for \$199.95 ea

Shugart SA400L single-sided double-density 40 track
 MSM-104000 \$234.95 ea 2 for \$224.95 ea

Shugart SA455 half-size double-sided 48 TPI
 MSM-104550 \$349.95 ea 2 for \$329.95 ea

Shugart SA465 half-size double-sided 96 TPI
 MSM-104650 \$399.95 ea 2 for \$379.95 ea

Tandon TM100-2 double-sided double-density 48 TPI
 MSM-551002 \$294.95 ea 2 for \$269.95 ea

Shugart SA450 double-sided double-density 35 track
 MSM-104500 \$349.95 ea 2 for \$329.95 ea

Tandon TM100-3 single-sided double-density 96 TPI
 MSM-551003 \$294.95 ea 2 for \$269.95 ea

Tandon TM100-4 double-sided double-density 96 TPI
 MSM-551004 \$394.95 ea 2 for \$374.95 ea

MPI B-51 single-sided double-density 40 track
 MSM-155100 \$234.95 ea 2 for \$224.95 ea

MPI B-52 double-sided double-density 40 track
 MSM-155200 \$344.95 ea 2 for \$334.95 ea

5 1/4" Cabinets with Power Supply

END-000216 Single cab w/power supply \$69.95
 END-000228 Dual cab w/power supply \$94.95

Place Orders Toll Free

Continental U.S. Inside California
 800-421-5500 800-262-1710

For Technical Inquires or Customer Service call:

213-973-7707

JADE

Computer Products

4901 W. Rosecrans, Hawthorne, CA 90250

We accept cash, checks, credit cards, or Purchase Orders from qualified firms & institutions. Minimum prepaid order \$15 California residents add 6 1/2% tax. Export customers outside the US or Canada please add 10% to all prices. Prices and availability subject to change without notice. Shipping & handling charges via UPS Ground 50¢/lb. UPS Air \$1.00/lb minimum charge \$3.00

Dual Disk Sub-Systems

Disk Sub-Systems - Jade

Handsome metal cabinet with proportionally balanced air flow system, rugged dual drive power supply, power cable kit, power switch, line cord, fuse holder, cooling fan, never-mar rubber feet, all necessary hardware to mount 2-8" disk drives, power supply, and lan, does not include signal cable.

Dual 8" Sub-Assembly Cabinet

END-000420 Bare cabinet \$49.95
 END-000421 Cabinet kit \$199.95
 END-000431 A & T \$249.95

8" Sub-Systems - Single Sided, Double Density

END-000423 Kit w/2 FD100-8Ds \$650.00
 END-000424 A & T w/2 FD100-8Ds \$695.00
 END-000433 Kit w/2 SA-801Rs \$999.95
 END-000434 A & T w/2 SA-801Rs \$1195.00

8" Sub-Systems - Double Sided, Double Density

END-000426 Kit w/2 DT-8s \$1224.95
 END-000427 A & T w/2 DT-8s \$1424.95
 END-000436 Kit w/2 SA-851Rs \$1274.95
 END-000437 A & T w/2 SA-851Rs \$1474.95

8" Slimline Sub-Systems

Dual Slimline Sub-Systems - Jade

Handsome vertical cabinet with scratch resistant baked enamel finish, proportionally balanced air flow system, quiet cooling fan, rugged dual drive power supply, power cables, power switch, line cord, fuse holder, cooling fan, all necessary hardware to mount 2-8" slimlinedisk drives, does not include signal cable.

Dual 8" Slimline Cabinet

END-000820 Bare cabinet \$59.95
 END-000822 A & T w/0 drives \$179.95

Dual 8" Slimline Sub-Systems

END-000823 Kit w/2 TM848-1 \$919.95
 END-000824 A & T w/2 TM848-1 \$949.95
 END-000833 Kit w/2 TM848-2 \$1149.95
 END-000834 A & T w/2 TM848-2 \$1179.95

Modems

SIGNALMAN - Anchor

Direct-connect automatic answer/originate selection, 300 Baud full duplex, Bell 103, includes RS-232 cable, portable - perfect for Osborne or KayPro II
 IOM-5600A Signalman \$89.95

SMARTMODEM - Hayes

Sophisticated direct-connect auto-answer/auto-dial modem, touch-tone or pulse dialing, RS-232C interface, programmable
 IOM-5400A Smartmodem \$224.95
 IOK-1500A Hayes Chronograph \$218.95
 IOM-2010A Micromodem II w/Term prgm \$329.95
 IOM-2012A Terminal program for MMII \$89.95
 IOM-1100A Micromodem 100 \$368.95

1200 BAUD SMARTMODEM - Hayes

1200 and 300 baud, all the features of the standard Smartmodem plus 1200 baud, 212 compatible, full or half duplex.
 IOM-5500A Smartmodem 1200 \$599.95

1200 BAUD SMART CAT - Novaton

103/212 Smart Cat & 103 Smart Cat, 1200 & 300 baud, built-in dialer, auto re-dial if busy, auto answer/disconnect, direct connect, LED readout displays mode, analog/digital loop-back self tests, usable with multi-line phones.
 IOM-5241A 300 baud 103 Smart Cat \$229.95
 IOM-5251A 1200 baud 212/103 Smart Cat \$549.95
 IOM-5261A 300 baud 103 J-Cal \$129.95

Circle 217 on inquiry card.

Disk Drive for Apple II

\$269.95

Apple II Accessories

APPLE DISK DRIVE - Apple Compatible

Totally Apple compatible, 143,360 bytes per drive on DOS 3.3, track 0 microswitch, high speed lead screw positioner, full one year factory warranty, half-track capability - reads all Apple software, plugs right in to Apple controller as second drive, DOS 3.3, 3.2.1, Pascal, & CP/M compatible.

MSM-123200 Add-on Apple Drive \$279.95
MSM-123100 Controller w/DOS 3.3 \$99.95

16K RAM CARD - for Apple II

Expand your Apple II to 64K, use as language card, full 1 year warranty. Why spend \$175.00 ?

MEX-16700A Save over \$115.00 \$59.95

Z-CARD for Apple II - A.L.S.

Two computers in one, Z-80 & 6502, more than doubles the power and potential of your Apple, includes Z-80 CPU card CP/M 2.2 and complete manual set, Pascal compatible, utilities are menu-driven, one year warranty.

CPX-62800A A & T with CP/M 2.2 \$169.95

SMARTERM II - A.L.S.

80 column x 24 line video card for Apple II, addressable 25th status line, normal/inverse or high/low video, 128 ASCII characters, upper and lower case, 7 x 9 dot matrix with true descenders, standard data media terminal control codes, CP/M Pascal & Fortran compatible, 50/60 Hz, 40/80 column selection from keyboard

IOV-2500A ALS Smarterm II \$179.95

SERIAL I/O CARD - A.L.S.

Full feature serial card for modems & printers, baud rates from 110 to 19,200, CTC/RTS & X-on/X-off protocols, auto line feed, RS-232C cable interface included.

IOI-1000A A & T \$79.95

MODEM CARD for APPLE - SSM

Better than Hayes! Better than Novation! Direct connect ModemCard plugs directly into Apple - no external components, auto-dial, auto-answer, Bell 103 compatible, full and half duplex, touch-tone or pulse dialing generated on board, Micromodem II software compatible, displays modem information on screen, audio monitoring of phone line, no serial port required, two year factory warranty, FREE Source Subscription with purchase of Transend software.

IOM-3000A ModemCard \$289.95
SFA-55770010M Transend 1 w/Source \$79.95
SFA-55770020M Transend 2 w/Source \$129.95
SFA-55770030M Transend 3 w/Source \$239.95

2 MEGABYTES for Apple II

Complete package includes: Two 8" double-density disk drives, Vista double-density 8" disk controller, cabinet, power supply, & cables, DOS 3.2/3.3, CP/M 2.2, & Pascal compatible.

1 MegaByte Package Kit \$1495.00
1 MegaByte Package A & T \$1695.00
2 MegaByte Package Kit \$1795.00
2 MegaByte Package A & T \$1995.95

ULTRA-VIOLET EPROM ERASERS

Inexpensive erasers for industry or home.

XME-3100A Spectronics w/o timer \$69.50
XME-3101A Spectronics with timer \$94.50
XME-3200A Economy model \$39.95

JADE Computer Products

IBM PC Accessories

ADD ON DISK DRIVE for IBM PC- Tandon

Single sided or double sided, double density disk drives for IBM PC, these are exactly the same disk drives used by IBM at half the price

MSM-551001 TM100-1 single sided \$219.95
MSM-551002 TM100-2 double sided \$294.95

SERIAL I/O for IBM PC - Profit Systems

Two asynchronous serial RS-232C I/O ports, real time clock-calender, includes software

IOI-8100A Card with 1 port \$159.95
IOI-8101A Card with 2 ports \$199.95

SERIAL/PARALLEL for IBM PC - Profit Sys

Two asynchronous serial RS-232C I/O ports, one parallel printer I/O port, real time clock-calender, includes software

IOI-8110A 1 serial & 1 parallel \$199.95
IOI-8111A 2 serial & 1 parallel \$229.95

TASC MASTER for IBM PC - Profit Systems

The Tasc Master is an intelligent parallel printer and dual port asynchronous communication adapter with built in buffer, two RS-232C I/O ports, parallel printer I/O port, 16K or 64K buffer, on-board CPU increases system throughput

IOI-8120A 1 serial/parallel/16K \$329.95
IOI-8121A 1 serial/parallel/64K \$399.95
IOI-8122A 2 serial/parallel/16K \$359.95
IOI-8123A 2 serial/parallel/64K \$429.95

EXTENDER CARD for IBM PC - Profit System

All bus signals extended, signal names silk screened on top of board, gold-plated card edge, low noise

TSX-300A IBM PC extender \$45.00

PROTOTYPING CARD for PC - Profit Systems

Highly versatile wire-wrap or solder prototyping board for your IBM PC, large bread board area, power and ground planes to reduce noise, all holes are plated through, card is solder masked on both sides, all signals names are silk screened on both sides

TSX-310A \$59.95

512K PC/RAM STACK - Hammond

A high quality, high density memory expansion board for your PC, cool-quiet-reliable operation, full parity checking, unique stacking sockets, expandable from 256K to 512K, MDRIVE high speed RAMdisk software only \$25.00 with board purchase

MEX-25600A 256K Assembled & tested \$795.00
MEX-51200A 512K Assembled & tested \$999.95
MEX-25600S MDRIVE disk emulator \$25.00

256K PC/RAM - Hammond Engineering

User expandable from 64K to 256K, same high quality as RAM STACK above, designed to meet all your medium memory expansion requirements

MEX-64000A 64K Assembled & tested \$299.95
MEX-128000A 128K Assembled & tested \$399.95
MEX-192000A 192K Assembled & tested \$499.95
MEX-256000A 256K Assembled & tested \$569.95

PC/SASI RAM - Hammond Engineering

Three boards in one, 256K of RAM, RS-232C asynchronous serial interface, and a SASI (Shugart Associates Standard Interface) hard disk interface

IOX-6000A PC/SASI RAM \$1095.00

Video Monitors

HI-RES 12" GREEN SCREEN - Zenith

15 MHz bandwidth 700 lines/inch, P31 green phosphor, switchable 40 or 80 columns, small, light-weight & portable.

VDM-201201 List price \$189.95 \$115.95

HI-RES GREEN MONITORS - NEC

20 MHz bandwidth, P31 phosphor ultra-high resolution video monitor, high quality, extremely reliable.

VDM-651200 Deluxe 12" \$199.95
VDM-651260 Economy 12" \$149.95
VDM-65092 Deluxe 9" \$179.95

12" COLOR MONITOR - NEC

High resolution color monitor with audio.

VDC-651212 Color monitor \$389.95
NEC-1202D RGB color monitor \$999.95

12" COLOR MONITORS - Taxan

18 MHz high resolution RGB color monitors fully compatible with Apple II and IBM PC, unlimited colors available.

VDC-821210 RGBvision I, 380 lines \$389.95
VDC-821220 RGBvision II, 510 lines \$589.95
VDC-8221230 RGBvision III, 630 lines \$689.95
VDA-821200 RGB card for Apple II \$99.95

COLOR MONITORS - Amdek

Reasonably priced color video monitors.

VDC-80130 13" Color I \$379.95
VDC-801320 13" Color II \$894.95
IOV-2300A DVM board for Apple \$199.95

AMBER or GREEN MONITORS - Jade

High resolution 18 MHz compact video monitors.

VDM-751210 12" Amber phosphor \$149.95
VDM-751220 12" Green phosphor \$139.95
VDM-750910 9" Amber phosphor \$149.95
VDM-750920 9" Green phosphor \$139.95

Single Board Computer

SUPERQUAD - Adv. Micro Digital

Single board, standard size S-100 computer system, 4 MHz Z-80A, single or double density disk controller for 5 1/4" or 8" drives, 64K RAM, extended addressing, up to 4K of EPROM, 2 serial & 2 parallel I/O ports, real time interrupt clock, CP/M compatible.

CPC-30800A A & T \$724.95
IOX-4232A Serial I/O adapter \$29.95

Z-80 STARTER KIT - SD Systems

Complete Z-80 microcomputer with RAM, ROM, I/O, keyboard, display, kludge area, manual, & workbook.

CPS-30100K Kit with workbook \$299.95
CPS-30100A A & T with workbook \$469.95

PB-1 - SSM Microcomputer

2708, 2716 EPROM board with on-board programmer.
MEM-99510K Kit with manual \$154.95
MEM-99510A A & T with manual \$219.95

PROM-100 - SD Systems

2708, 2716, 2732 EPROM programmer with software.
MEM-99520K Kit with software \$189.95
MEM-99520A A & T with software \$249.95

ISO-BUS - Jade

Silent, simple, and on sale - a better motherboard
6 Slot (5 1/4" x 8 1/2")

MBS-061B Bare board \$22.95
MBS-061K Kit \$39.95
MBS-061A A & T \$69.95
12 Slot (9")
MBS-121B Bare board \$34.95
MBS-121K Kit \$69.95
MBS-121A A & T \$109.95

MBS-181B Bare \$54.95
MBS-181K Kit \$99.95
MBS-181A A & T \$149.95

ACTIVE TERMINATOR - CompuPro

A true mother's helper.

TSX-100A A & T \$59.45

New !!! CP/M Plus 3.0

NEW CP/M 3.0 - Digital Research

CP/M 3.0 is Digital Research's latest version of the industry standard disk operating system. It features many performance improvements such as intelligent record buffering, improved directory handling, "HELP" facility, time/date stamping of files and many more improvements. AND A TREMENDOUS INCREASE IN SPEED !!!, it is fully CP/M 2.2 compatible and requires no changes to your existing application software. Available only to Versal floppy II owners with SBC-200 CPU's

- CP/M 2.2 compatible
- Easily customized
- Easier to learn and use
- High performance file system
- Time and date stamps on file
- Automatic disk log-in of removable media
- Support for 1 to 16 banks of RAM
- Supports up to 16 drives of 512 Megabytes each
- Up to ten times faster than CP/M 2.2
- Console I/O re-direction
- Easy to use system utilities with HELP facility
- Power batch facility
- Designed for application programmers
- Resident system extensions
- Sophisticated programmer utilities
- Designed with the business user in mind

SFC-55009057F CP/M 3.0 8" with manuals \$200.00
SFC-55009057D CP/M 3.0 manual set \$30.00

S-100 Memory Boards

256K RAMDISK - SD Systems

ExpandoRAM III expandable from 64K to 256K using 64K x 1 RAM chips, compatible with CP/M, MP/M, Oasis, Cromemco, & most other Z-80 based systems, functions as ultra-high speed disk drive when used with optional RAMDISK software.

MEM-65064A 64K A & T \$474.95
MEM-65128A 128K A & T \$574.95
MEM-65192A 192K A & T \$674.95
MEM-65256A 256K A & T \$774.95
SFC-55009000F RAMDISK sftwr CP/M 2.2 \$44.95
SFC-55009000F RAMDISK with EXRAM III \$24.95

64K STATIC RAM - Jade

Uses new 2K x 8 static RAMs, fully supports IEEE 696 24 bit extended addressing, 200ns RAMs, lower 32K or entire board phantomable, 2716 EPROMs may be subbed for RAMs, any 2K segment of upper 8K may be disabled, low power typically less than 500ma.

MEM-99152B Bare board \$49.95
MEM-99152K Kit less RAM \$99.95
MEM-32152K 32K kit \$199.95
MEM-56152K 56K kit \$289.95
MEM-64152K 64K kit \$299.95
Assembled & Tested add \$50.00

16K STATIC RAM - Mem Merchant

4MHz lo-power static RAM board, IEEE S-100, bank selectable, addressable in 4K blocks, disable-able in 1K segments extended addressing.

MEM-16171A 16K A & T \$149.95

S-100 Disk Controllers

DISK 1 - CompuPro

8" or 5 1/4" DMA disk controller, single or double density, single or double sided, 10 MHz.

IOD-1810A A & T \$449.95
IOD-1810C CSC \$554.95

VERSALFLOPPY II - SD Systems

Double density disk controller for any combination of 5 1/4" and 8" single or double sided, analog phase-locked loop data separator, vectored interrupts, CP/M 2.2 & Oasis compatible, control/diagnostic software PROM included.

IOD-1160A A & T with PROM \$359.95
SFC-55009047F CP/M 3.0 with VF II \$99.95

2242 DISK CONTROLLER - C.C.S.

5 1/4" or 8" double density disk controller with on-board boot loader ROM, free CP/M 2.2 & manual set.

IOD-1300A A & T with CP/M 2.2 \$399.95

DOUBLE D - Jade

High reliability double density disk controller with on-board Z-80A, auxiliary printer port, IEEE S-100, can function in multi-user interrupt driven bus.

IOD-1200B Bare board & hdwr man \$59.95
IOD-1200K Kit w/hdwr & sftwr man \$299.95
IOD-1200A A & T w/hdwr & sftwr man \$325.95
SFC-59002001F CP/M 2.2 with Double D \$99.95

New CP/M Plus Version 3.0 FREE !!! *

Shopping for S-100 Boards ? WE CAN BEAT ANY PRICE !!

<p>THREE BOARD SET - SD Systems</p> <p>FREE CP/M 3.0 Save \$800.00</p> <p>S-100 board set with 4 MHz Z-80A, 64K of RAM expandable to 256K, serial and parallel I/O ports, double-density disk controller for 5 1/4" and 8" disk drives, new and improved CP/M 3.0 manual set, system monitor, control and diagnostic software. Includes SD Systems SBC-200, 64K ExpandoRAM III, Versal floppy II, and FREE CP/M 3.0 - all boards are assembled & tested.</p> <p>* 64K Board Set with FREE CP/M 3.0 \$1195.00 256K Board Set with FREE CP/M 3.0 \$1395.00</p>	<p>THREE BOARD SET - CCS</p> <p>FREE CP/M 2.2 Save \$700.00</p> <p>Limited Quantity</p> <p>S-100 board set featuring high speed DMA CPU and disk controller, includes 4 MHz DMA Z-80A CPU, 64K of high speed RAM, 2 serial and 1 parallel I/O ports, double-density DMA disk controller for 5 1/4" or 8" drives, FREE CP/M 2.2 on 8" disk with full manual set, all necessary diagnostic and control software. Package consists of the new CCS 282C DMA CPU, new CCS DMA disk controller (not the old 2422), & CCS 2065 64K RAM, and FREE CP/M 2.2 - all boards are assembled & tested with full factory warranty.</p> <p>SPECIAL PACKAGE PRICE Save over \$700.00 .. \$694.95</p>
---	--

Call Jade Toll Free for Prices

SD Systems, CCS, CompuPro, SSM Microcomputer, Memory Merchant
Scion, Jade Computers, Dual Systems, Advanced Digital, Vector Graphics

S-100 I/O Boards

I/O-4 - SSM Microcomputer
2 serial I/O ports plus 2 parallel I/O ports.
IOI-1010B Bare board w/manual \$35.00
IOI-1010K Kit with manual \$179.95
IOI-1010A A & T with manual \$249.95

I/O-5 - SSM Microcomputer
Two serial & 3 parallel I/O ports, 110-19.2K Baud
IOI-1015A A & T \$289.95

INTERFACER 4 - CompuPro
3 serial, 1 parallel, 1 Centronics parallel.
IOI-1840A A & T \$314.95
IOI-1840C CSC \$414.95

THE BUS PROBE - Jade
Inexpensive S-100 Diagnostic Analyzer
So your computer is down. And you don't have an oscilloscope. And you don't have a front panel... You're not alone - most computers have their occasional bad days. But without diagnostic equipment such as an oscilloscope (expensive!) or a front panel (expensive!), it can be very difficult to pinpoint the problem. Even if you have an extender board with a superfast logic probe, you can't see more than one signal at a time. You're stuck, right? Not anymore; Jade is proud to offer our cost-effective solution to the problems mentioned above: **THE BUS PROBE.** Whether you're a hobbyist with a cantankerous kluge or a field technician with an anxious computer owner breathing down your neck, you'll find THE BUS PROBE speeds your repair time remarkably. Just plug in THE BUS PROBE and you'll be able to see all the IEEE S-100 signals in action. THE BUS PROBE allows you to see inputs, outputs, memory reads and writes, instruction fetches, DMA channels, vectored interrupts, 8 or 16 bit wide data transfers, plus the three bus supply voltages.

TSX-200B Bare board \$59.95
TSX-200K Kit \$129.95
TSX-200A A&T \$159.95

S-100 CPU Boards

SBC-200 - SD Systems
4 MHz Z-80A CPU with serial & parallel I/O, 1K RAM, 8K ROM space, monitor PROM included.
CPC-30200A A & T \$329.95

THE BIG Z - Jade
2 or 4 MHz switchable Z-80 CPU board with serial I/O, accommodates 2708, 2716, or 2732 EPROM, baud rates from 75 to 9600.
CPU-30201B Bare board w/manual \$35.00
CPU-30201K Kit with manual \$149.95
CPU-30210A A & T with manual \$199.95

2810 Z-80 CPU - C.C.S.
2 or 4 MHz Z-80 CPU with serial I/O port & on-board monitor PROM, front panel compatible.
CPU-30400A A & T with PROM \$289.95

CPU-Z - CompuPro
2 1/4 MHz Z80A CPU, 24 bit addressing.
CPU-30500A 2 1/4 MHz A & T \$279.95
CPU-30500C 3/6 MHz CSC \$374.95

8085/8088 - CompuPro
Both 8 & 16 bit CPUs, standard 8 bit S-100 bus, up to 8 MHz, accesses 16 Megabytes of memory.
CPU-20510A 6 MHz A & T \$398.95
CPU-20510C 6/8 MHz CSC \$497.95

S-100 Video Boards

MICROANGELO - Scion
Ultra-high-resolution 512 x 480, 256 color or black & white S-100 video board
IOV-1500A A & T \$799.95

JADE Computer Products

DUAL DRIVE SUBSYSTEMS



HORIZONTAL OR VERTICAL
Fully Assembled and Tested Units

w/two Shugart 801R SS/DD	\$ 975.00
w/two Shugart 851R DS/DD	1225.00
w/two Qume DT-8 DS/DD	1250.00
w/two Tandon 848-1 SS/DD	995.00
w/two Tandon 848-2 DS/DD	1195.00
Cabinet A & T w/Power Supply and Accs.	235.00
Cabinet Top and Bottom	69.50

California Computer Systems
SPECIAL!



CCS SYSTEM 2410 . . \$1995.00

- Includes CP/M® 2.2
- 2-Serial/1-Parallel Port
- DMA Disk Controller
- Hardware Vectored Interrupts
- 2-Real Time Clocks
- Supports CP/M®, MP/M®, OASIS

CCS 2300 System, A & T . 1695.00

- 2810 CPU Only—255.00
- 2422 Disk Controller Only—330.00
- 2066 64K Only—360.00
- 2300A Mainframe **NEW!!** Only—455.00
- CCS Apple Boards . . . Call Toll Free For Prices

S-100-4 MINI'S

Choose the System that fits your needs!
A complete computer system ready to add on a terminal and printer. All Systems include CP/M® software and system manual set. Full six-month parts and labor warranty excluding drives which carry the full O.E.M. manufacturers warranty. All S-100-4 Systems advertised are in stock assembled and tested available for immediate delivery.

MINI FLOPPY

Only \$1395.00 COMPLETE



- ★ with 48 TPI single sided double density 5 1/4" . . \$1395.00
- ★ with 48 TPI double sided double density 5 1/4" . . \$1495.00
- ★ with 96 TPI double sided double density 5 1/4" . . \$1650.00

An inexpensive but powerful system featuring a 4 slot S-100 bus chassis with the XOR S-100 board set; 4-MHZ Z-80 CPU ★ 64K dynamic memory ★ multi-sector mixed density disk controller ★ 2-RS232 output ports in the rear for your terminal and printer ★ 3 eight-bit parallel ports on the CPU ready to add a cable and interface to your printer ★ All above systems are in stock ★ Includes CP/M® 2.2.
CP/M is a trademark of Digital Research

HARD DISK

Only \$2995.00 COMPLETE



These S-100-4 Systems may be very small in size (9"H x 9 1/2"W x 18 1/2"L) but look at the size of the ATASI® 5 1/4" Winchester hard disks we offer!

4 models to choose from

- ★ Seagate 5 Megabyte System \$2995.00
- ★ #3020 15.6 Megabyte System \$3495.00
- ★ #3033 26 Megabyte System \$3995.00
- ★ #3046 36 Megabyte System \$4495.00

The above systems include a 96 TPI double sided double density 5 1/4" floppy as standard. The hard disk is controlled via Western Digital's controller for hard disks. Other features are the same as system at left. *Megabyte sizes mentioned above are the available storage space after formatting.

TAPE BACKUP

WITH HARD DISK Only \$4250.00 COMPLETE



Now available through U.S. Micro Sales, the XOR IRWIN 510 S-100-4 tape backup system with 10 megabytes of hard disk storage. Back up your hard disk

on a mini-tape (we're talking 10 meg.) in less than 3 1/2 minutes! The above system includes a 96 TPI DS/DD floppy drive and this system's modular design allows you to add a second floppy for only \$395.00.

★★★ XOR COMPATIBLE SOFTWARE ★★★

WORD PROCESSING & TEXT EDITING

WordStar	\$275.00
MailMerge	100.00
SpellStar	175.00
Random House Thesaurus	135.00
TEX (Text Formatter)	90.00
Mince (Text Editor)	145.00
Scribble (Formatter)	145.00
(Both Mince & Scribble)	245.00
Random House Thesaurus	135.00
Final Word (Word Processor)	265.00
Peach Pack (4 Programs)	450.00
Spell Guard	225.00
WordMaster (Text Editor)	115.00
The Word Plus (Spelling Checker)	130.00

DATA APPLICATIONS

dBASE II	\$595.00
Quickcode (Program Generator, Screen Builder for dBASE II)	250.00
FMS-80	890.00
FMS-80-11	440.00
DataStar (Data Entry & Ret.)	245.00
CalcStar (Elec. Spreadsheet)	145.00
BT-80 (Rec. Retrieval)	175.00
Access Manager (For B-Tree)	250.00
SuperCalc	265.00
Maiman (M/L Manager)	119.00
NAD (M/L Manager)	90.00
Recover (Lost Data Recovery)	65.00

LANGUAGES

MBasic-80	\$290.00
MBasic Compiler	325.00
CBasic 2	100.00
CB-80 (Compiler)	455.00
Fortran-80	375.00
PL/I-80 (Language)	450.00
Pascal MT+ (Language)	445.00
Pascal MT+ (Compiler)	310.00
Cobol-80 (Language)	585.00
C Compiler (Language)	215.00
ADA (Compiler)	265.00
MAC (Macro Assem.)	85.00
Macro-80 (Macro Assem.)	150.00

Formats for XOR, NORTHSTAR, ALTOS, VECTOR GRAPHICS, Etc.

COMMUNICATIONS

Move-it	\$ 80.00
Crosstalk	160.00
BSTAM	149.00
BSTMS	149.00
Term II	150.00

CP/M® HELPS

ATI-CP/M® Power 2.2 (Training)	75.00
Supervyz	95.00
CP+ (English Language Menus)	125.00
Smart Key	50.00
Smart Print	30.00
ISIS (CP/M®) (Translator)	199.00
Disk-Edit	90.00

ACCOUNTING

Peachtree - Series 4	
General Ledger	\$395.00
Accounts Receivable	395.00
Accounts Payable	395.00
Inventory	395.00
Payroll	395.00
Peach Pak (G/L, A/R, A/P)	900.00
Accounting Plus	CALL
Structured Systems	CALL
Medical	845.00
Dental	845.00
Master Tax (Prof 1040)	1500.00
Standard Tax (A 1040)	550.00

OTHER APPLICATIONS

SuperSort	\$190.00
M-Sort	170.00
Q-Sort	89.00
Disk Doctor	89.00
Pearl 1 (Entry Lev. Prg. Gen.)	45.00
Pearl 2 (Int. Prog. Gen.)	250.00
Pearl 3 (Advanced)	450.00
ATI D.B. Power (dBase II Training)	75.00
ATI SuperCalc (Training)	75.00
ATI MBasic (Training)	75.00
ATI WordStar (Training)	75.00
DeSpool (Background Print Utility)	45.00
ZSID (Debugger)	89.00



TWO Locations to Serve You

☆ EAST Coast Call (815) 485-4002

☆ WEST Coast Call (714) 891-2677

OUT
OF
STATE

ORDER TOLL FREE!

1 - 800 - 435-9357

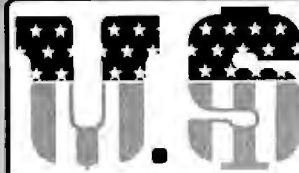

MICRO SALES

★ MADE IN U.S.A. BY AMERICANS ★

★ EAST ★ 11 Edison Drive, New Lenox, Illinois 60451
★ WEST ★ 6182 Garden Grove Blvd., Westminster, CA 92683

TERMS: We accept VISA/MC, prepay, check or money order. Please allow personal check two weeks to clear before shipment. \$5.00 handling charge on all orders under \$50.00. 15% Restocking Fee. All orders shipped via U.P.S. unless otherwise specified. All UPS C.O.D. orders over \$100.00 require a cashiers Check. ★ Our products carry a full 6 months parts and labor warranty excluding drives, printers and terminals which carry the full O.E.M. factory warranty. PRICES SUBJECT TO CHANGE WITHOUT NOTICE.

UNIVERSAL POWER SUPPLY

For Big Board, Apple or Aim 65
+5VDC @ 3 Amps
+12VDC @ .750 Amps
-12VDC @ .750 Amps
-5VDC @ .500 Amps
Dimensions: 4" x 4" x 11"

\$69.95

DISK DRIVE POWER SUPPLY

For 2 - 8" or 5" Drives
+ 5VDC @ 4 Amps
+24VDC @ 3 Amps
- 5VDC @ 1 Amp



AC Cables for 2 Drives \$7.50

Dimensions: 4" x 4" x 11"

\$59.95

S-100 POWER SUPPLY



+8VDC @ 30 Amps
+16VDC @ 6 Amps
-16VDC @ 6 Amps
PC Board Design

Dimensions: 5" x 6" x 11"

\$89.50

TERMINALS

Televideo 910+ with green screen. \$575
T.V. 925 \$739 T.V. 950 \$945
Adds Viewpoint Model 3A+ \$519
Zenith Z-19 \$740

PRINTERS

Epson MX-80FT \$549.00
Epson MX-100FT \$699.00
Okidata 82A 80 column \$465.00
Okidata 83A 132 column \$745.00
C-ITOH Prowriter I \$525.00
I.D.S. Microprism Model 480 . \$565.00

8" DISK DRIVES

SA801R 388.00 ea. Two for 379.00 ea.
SA851R 535.00 ea. Two for 529.00 ea.
QUME DT-8 . 540.00 ea. Two for 529.00 ea.
Tandon 848-1 395.00 ea. Two for 388.00 ea.
Tandon 848-2 525.00 ea. Two for 519.00 ea.
Mitsubishi Model 2896 DS/DD 475.00 ea.

S-100 MOD KIT by XOR

For test or systems applications.
Complete S-100 12 Slot Main-
frame with Disk Drive Power Supply
for 4 Drives.

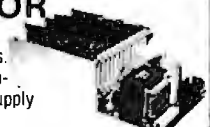

SPECIFICATIONS

Unregulated	Regulated
+8V @ 30A	+5V @ 5A
±16V @ 6A	+24V @ 3A
	-5V @ 1A

\$225.00 Kit with 12 S-100 Bus Connectors
\$255.00 Assem. and Tested with 12 Bus Connectors
\$15.00 AC/DC Drive Cable Set for 2 Drives
Dimensions 6" x 10" x 18" — Shipping Weight 25 lbs.

Cooling
Power

4 1/8"

Low Velocity
Whisper® Fans
Only \$18.00 ea.
Finger Guards
\$2.50 each.

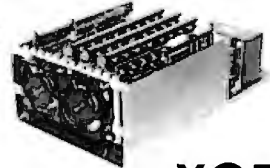

XOR

S-100 MOD

CUSTOMER SERVICE HOTLINE 1 - (714) 898-5525

S-100-4



\$1695.00

- ★ 4 Slot S-100 Bus
- ★ Includes CP/M* 2.2 and Mani
- ★ Two Separate Power Supplies
- ★ All Cables Provided
- ★ XOR S-100 Board Set
- ★ Dimensions only 9" x 9" x 18 1/2"

S-100-4 System Complete with:

2-Tandon Thinline 8" (Model TM-848-1 SS/DD)
Part #S-1000-40 \$1695.00
2-Tandon Thinline 8" (Model TM-848-2 DS/DD)
Part #S-1000-39 \$1950.00

Now we are able to offer Mitsubishi thinline drives
DSDD model 2896 for full 2.4 megabytes of formatted
storage. All S-100-4 systems with these drives will
include a full 6 months parts and labor warranty in-
cluding the drives! Part #S-1000-34

S-100-8



\$1795.00

TERMINAL

- ★ Feather Touch Capacitance Kybrd.
- ★ 60 Key Standard ASCII
- ★ SOROC Type Screen Attribute Set
- ★ 8 Special Function Keys
- ★ Half Intensity
- ★ 20 Screen Editing Keys

COMPUTER

- ★ XOR S-100 Board Set
- ★ Includes CP/M* 2.2
- ★ Programmable Keyboard Set
- ★ 8 Slot S-100 Bus

S-100-8 System Complete with:

Shugart 801R Subsystem* (#S-1000-22) ... \$2675.00
Shugart 851R Subsystem* (#S-1000-23) ... 2925.00
Qume DT-8 Subsystem* (#S-1000-24) 2950.00
Shugart SA 400 Minis (#S-1000-25) 2350.00
Complete System, No Drives (#S-1000-21) . 1795.00

*Available in Horizontal or Vertical Cabinet

100 MEG! IN YOUR S-100-12*

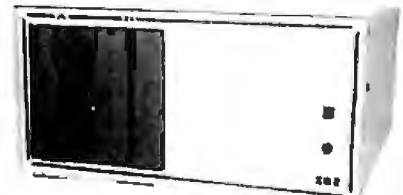

Introducing a major breakthrough in technology...
The removable cartridge disk called the Alpha-
10™. 10 megabytes of removable storage space
(14 meg unformatted) with the speed and reliabili-
ty a Winchester offers. The complete system in-
cludes the XOR Z-80 based 64K board set, the S1-
MOD power supply/mother board, the Alpha-10™
drive (w/ 3 cartridges), sitting alongside a Shugart
851 DS/DD multi-sector floppy disk, CP/M™ 2.2
software and manuals, and we'll even throw in a 6
month parts and labor exclusive warranty.

(#S1000-75) **\$3995.00**

If you already own an S-100-12 w/2 floppies buy
an Alpha-10™ upgrade package. Includes Alpha-
10™ cartridge drive, cartridge control board, S-100
interface board w/all necessary cables, software
and manuals. System price includes 3 10 meg
cartridges. (#S-1000-80) **\$1995.00**

*Extra cartridges available (#M-2000-51). \$50.00
ALPHA-10™ is a product manufactured by IOMEGA™ CORP.

Apple 8" Disk Controller Card \$395.00
ZVX4 Dual Density, Single & Double Sided - Auto Boot
Disk 2 + 2 Single Density Single or Dual Sided

SVA 300.00

Complete line of add on drives for Apple
CALL TOLL FREE FOR PRICES

Ask about our Low Cost MODEM Software
Hayes - MicroModem 100 Ser/Por 110/300 Baud . . . \$275.00
Hayes - Smart Modem 300 Baud Orig/Ans Director. . . \$250.00
NOV. - DCAT 300 Baud Direct Con Ans/Orig. . . 165.00
NOV. - AUTOCAT Auto/Ans/Orig Direct Con. . . 235.00
NOV. - APPLCAT 300/1200 Baud Direct Con. . . 350.00
PMMI - MM103 300/600 Baud (S-100) . . . 359.00

SEE US AT THE WEST COAST COMPUTER FAIRE!

Civic Auditorium Brooks Hall, San Francisco
March 18, 19, 20, 1983 - Booths # 1844 and # 1846
Don't miss out . . . Be sure to call, write or
visit us to get a 1983 Winter/Spring
Catalog

California Digital

Post Office Box 3097 B • Torrance, California 90503

★ FREE ★
 Plastic library case supplied with all
 diskettes purchased from California Digital

\$24.95

Private labeled for California Digital by one of the most
 respected producers of magnetic media. Each diskette
 is certified double density at 40 tracks. To insure
 extended media life all diskettes are manufactured with a
 reinforced hub.
 Each box of diskettes is supplied with a free plastic
 library case
 Soft sector CAL-501, Ten sector CAL-510
 Ten boxes \$22.75 One hundred boxes \$21.50

**5 1/4" DISKETTES
 WITH LIBRARY CASE**

\$26.50

Your Choice
**SCOTCH
 MEMOREX
 VERBATIM**

Single Side Double Density
 Soft Sector 10 Sector 16 Sector

SCOTCH	744D-0	744D-10	744D-16	26.50
MEMOREX	3481	3483	3485	26.50
VERBATIM	525-01	525-10	NA	26.50
MAXELL	MD1	MH1-10	MH1-16	29.85
DYSAN	104/1D	107/1D	NA	45.00

Double Side Double Density

SCOTCH	745-0	745-10	745-16	42.50
VERBATIM	550-01	550-10	NA	42.50
MAXELL	MD2-D	MH2-10D	MH2-16D	45.00
DYSAN	104/2D	107/2D	NA	49.50
DYSAN 96	204/2D	NA	NA	59.50

EIGHT INCH DISKETTES

Single Side Single Density		Single Side Double Density			
SCOTCH	740-0	29.50	SCOTCH	741-0	39.00
MEMOREX	3060	29.50	MEMOREX	3090	35.00
DYSAN	3740/1	39.50	DYSAN	3740/D	57.50

Thirty Two Sector		Double side Double Density			
SCOTCH	740-32	29.50	SCOTCH	743-0	47.50
			MEMOREX	3114	39.50
			DYSAN	3740/2D	65.00

Microswitch
**ASCII
 KEYBOARD**

\$79

Each keyboard contains 81 high reliability Hall Effect keys.
 Outputs seven bit parallel ASCII MIC-81SD5 3 Lbs.

**HITEK
 KEYBOARD**

\$24.95

This Hitek keyboard is the same unit used by Lear Siegler in their model 500
 CRT terminals. The keyboard features 50 unenclosed keys on matrix con-
 tacts (MK-50). Matching numeric cluster with 15 keys is available for \$9.95
 (MK-15). Buy both of these units for only \$29.50 and save \$5.00 (MK-50/15).

MEMORY

16K DYNAMIC	2732 EPROM
1.95	4.95
4116 150ns.	450ns.
64K DYNAMIC	16K STATIC
6.95	4.95
4164 150ns.	6116 200ns.

**2764 EPROM
 SALE \$9.95**

DYNAMIC MEMORY

4027 4K dynamic 250ns	ICM-4027250	1.31	32+	100+
4116 150ns. 16K	ICM-4116150	1.90	1.65	1.75
4116 200ns. 16K	ICM-4116200	1.95	1.85	1.75
4164 150ns. 64K 128 refresh	ICM-4164150	1.75	1.65	1.50
11256 150ns 256K	ICM-41256150	6.95	6.50	5.90

Available March 83

STATIC MEMORY

21L02 200ns 1K static	ICM2-1102200	1.19	1.29	1.15
21L02 450ns 1K static	ICM-21L02450	1.29	1.15	.99
2112 450ns 2K static	ICM-2112450	2.99	2.85	2.75
2114 300ns 1K x 1	ICM-2114300	1.95	1.65	1.75
40114MS 450ns 4K x 1	ICM-4011450	3.49	3.25	2.99
5257 300ns 4K x 1	ICM-5257300	2.50	2.25	1.99
6116 P4200ns 2K x 8	ICM-6116200	4.85	4.60	4.35
6116 P5150ns 2K x 8	ICM-6116150	5.85	5.75	5.60
6167/2167 100ns. 16K x 1 (20 pin)	ICM-6167100	8.95	8.50	7.90

EPROMS

2708 450ns 1K x 8	ICE-2708	1.95	4.75	4.55
2716 450ns 2K x 8	ICE 2716	4.65	4.75	4.55
2716TMS 450ns Tri-voltage	ICE-2716TMS	7.95	7.65	7.25
2732 450ns 4K x 8	ICE-2732	4.95	4.75	4.55
2732350ns 4K x 8	ICE-2732350	8.50	8.00	7.60
2532 450ns 4K x 8	ICE-2532	10.50	9.90	9.50
2764 350ns 8K x 8	ICE-2764	10.65	10.50	9.95
27128350ns 16K x 8	ICE-27128			

Available March 83

CONNECTORS

S-100 Gold \$2.95

DB25P \$2.50

GOLD EDGE CONNECTORS

S-100 .125" centers	each 10+	D" Type	each 10-25
Imax solder .250" rows	\$2.95 \$2.30	DEMI male	\$1.80 \$1.40 \$1.30
Imax wire wrap (T1)	2.95 2.10	D25P female	2.25 2.00 1.80
Sullins H-Hal .250"	4.50 3.50	DA15H female	3.35 3.10 2.90
Sullins H-Hal .140"	4.11 3.00	DA board 2/P	1.60 1.45 1.30
Sullins /Alstar .140"	1.05 1.30	D9 25P male	2.50 2.35 2.15
.155" Centers (standard)		D9 25P female	1.95 2.15 1.85
32/74 Kim Excess	2.50 2.15	D9 board 2/P	1.20 1.00 3.78
32/72 Digital Group S/F	3.05 2.40	DC27S female	4.00 5.75 4.40
39/72 Digital Group W/W	6.00 6.15	DC board 2/P	2.25 2.00 1.75
43/86 Motorola 6809 S/F	6.60 6.15	DC28H male	3.50 3.10 3.75
43/86 Motorola 6809 W/W	7.00 6.65	DC28S female	9.10 8.00 8.00
		DC30 board 2/P	2.60 2.10 2.10

INTEGRATED CIRCUIT SOCKETS

Low Profile	Wire Wrap
each 100+	each 100+
9 pin 3.10 5.00 8.10 5.21	
14 pin .10 .09 .15 .11	
18 pin .12 .11 .10 .15	
18 pin .15 .13 .09 .01	
24 pin .26 .21 .14 .07	
10 pin .42 .40 1.60 1.47	

CONN FRONTS

17-30360	7.00 6.75 3.75
----------	----------------

REBUILT CABLE CONNECTORS

1724 27 disk	3.50 3.10 3.55
1040 TRS-80	3.65 3.05 4.70
2750 4" disk	4.50 5.10 4.90

23" COMPOSITE MONITOR \$159

Ideal monitor for classroom demonstrations.

Ever try gathering a classroom of students around a 12" monitor? Here is your opportunity to purchase a 23" high resolution monitor at a reasonable price.
 These units, except standard composite video signals generated by most personal computers, including the Apple and IBM. Attach it your computer and/or second you are showing data highlights on video screen.
 MOT BV23 3/4 Lbs. Monitors are open frame and for safety should be enclosed Wood grained enclosure for above \$25.00 additional CAL EMC23 1/4 Lbs.



Eight Inch Single Sided

	One	Two	Ten
SHUGART SA801R	\$395	385	375
SIEMENS FDD100-8	259	259	225
TANDON 848-1 SLIMLINE	379	369	359

Eight Inch Double Sided

SHUGART SA851R	525	495	475
QUME DATA TRACK 8	525	495	475
MITSUBISHI M2894-63	485	475	469
OLIVETTI 802/851	369	359	349
TANDON 848-2 SLIMLINE	495	485	475
SHUGART 860 THINLINE	569	549	539

Five Inch Single Sided

SHUGART SA400	215	209	199
TANDON TM 100-1	209	199	195

Five Inch Double Sided

SHUGART SA450	349	329	315
TANDON TM 100-2	295	269	259
TANDON 96TPI TM100-4	369	355	350
OLIVETTI 502 2/3 height	239	225	215

Three Inch Rigid Floppy

HITACHI-AMDEK	call for pricing
---------------	------------------

Five Inch Winchester

SEAGATE 506 6 Megabyte	759	725	695
SEAGATE 512 12 Megabyte	995	960	960
TANDON 603SE 14 Megabyte	995	960	895
WESTERN DYNAX removable	995	960	950

Upon request, all drives are supplied with power connectors and manual

\$750 Eight Inch Subsystem

Two Siemens FDD100-8 disk drives with power supply, 4" exhaust fan complete with all necessary power cables.

Same as above but with:

Shugart 801R MSD2801	1195	Olivetti 802	CAL2802	1250
Shugart 851R MSD2851	1450	Qume DTB	MSD8DT	1450

ECLIPSE 100 \$695

INDUSTRIAL S-100 MAINFRAME

Suitable for hospital and industrial applications. Constructed from 304 brushed stainless steel. Modular 500 watt toroid power supply provides - 8 volts at 30 Amps and +16 volts at 4 Amps. Supplied with standard 18 slot Faraday mother board. Auxiliary switched AC receptacles. The Eclipse 100 can be either table or rack mounted. Provisions for internally mounting a ten megabyte Winchester disk drive.
 The Eclipse 100 is the perfect mainframe to fill the void left by the now defunct TEI Corporation EPS 100 50 lbs.



Shipping: First five pounds \$3.00. Each additional \$.50.
 Foreign orders: 10% shipping. Excess will be refunded.
 California residents add 6 1/2% sales tax. COD's discouraged.
 Open accounts extended to state supported educational institutions
 and companies with a "strong" Dun & Bradstreet.
 Warehouse: 15608 Inglewood Blvd. Visitors by appointment.

TOLL FREE ORDER LINE
(800) 421-5041
TECHNICAL & CALIFORNIA
(213) 679-9001

California Digital

Post Office Box 3097 B • Torrance, California 90503

Super Buy \$239

SIEMENS FDD100-8

8" DISK DRIVE

10 Drives \$209 • 100 Drives \$175

California Digital has recently participated in the purchase of several thousand Siemens FDD 100-8 floppy disk drives. These units are electronically and physically similar to that of the Shugart 801R. Any application that will accept the Shugart will work with the Siemens FDD 100-8. All units are new and shipped in factory sealed boxes. Because of the extremely low price we expect a quick sell out SEA-F1008 17 lbs. Manual and power connectors supplied free upon request. Also available: Two drive subsystem supplied in metal enclosure with power supply and exhaust fan. \$750.00 CAL-2F1008.

MORROW DESIGNS

MICRO DECISION

\$1195

Buy before month end and California Digital will supply, free of any additional cost, 50 Diskettes and a 5 1/4" Flip & File.

- Digital Research 2.2 CP/M
- MicroPro Wordstar
- Electronic Spreadsheet
- NorthStar Basic
- Spelling Checker
- Microsoft Basic 80



Includes \$1800 worth of free software:

The Morrow Micro Decision offers one of the best values in small business computers. Standard features include 64K of RAM, 4MHz Z 80 CPU, two RS232 serial ports, dual density floppy disk controller capable of supporting four disk drives, and a 200 Kilobyte 5 1/4" disk drive. The unit is powered by a low noise switching power supply. The low profile enclosure should blend in to most any office environment. The Micro Decision is delivered complete with CP/M 2.2 as well as Basic 80 and Wordstar. Available options include a second disk drive and a video terminal. MDS-M01 18 lbs.

PRINTERS

ECLIPSE 80FT

\$297

MATRIX PRINTERS

Star/Gemini 10 function tractor 100 char/sec parallel	STR-G10	35900
Star Eclipse 80FT tractor	STR-E80FT	29700
Olivetti 82A serial & parallel 9" paper	OKI-82A	45900
Olivetti 83A serial & parallel 15" paper	OKI-83A	69900
Olivetti 84A serial & parallel 15" paper	OKI-84A	107900
Olivetti 2350 (new) 350 char/sec	OKI-2350	199500
Epson/M80T with graphics tractor & tractor feed	EPS-MX80FT	51900
Epson/M100 with graphics 15" paper	EPS-M1100	63500
NEC 8022A parallel 9" paper	NEC-8022A	48500
Anadex 9500A high speed 15" paper	ADK-9500A	127900
Anadex 9501A high speed with graphics	ADK-9501A	127900
Qualtech 7030 correspondence quality 180 char/sec	QTX-7030	153500
Powerjet 8510 parallel 9" paper	PHO-8510P	49500
Powerjet 8510 serial 9" paper	PHO-8510S	63900
Powerjet II 15" paper	PHO-2P	75000
Printmax F100 high speed printer 300 lines per minute	PTX-F100	159000
Printmax P600 1/3 high speed 600 lines per minute	PTX-P600	615000
Mannesmann Tally 1805 200 char/sec serial	MAN-1805	165000

TERMINALS

Wyse

Amplex Dialogue 80 green screen, two page, function keys APX-080C	795 00
Amplex Dialogue 80 amber screen, two page, function keys APX-080A	795 00
Amplex Dialogue 80 green screen, Selectric keyboard APX-081G	895 00
Amplex Dialogue 81 amber screen, Selectric keyboard APX-081A	895 00
Amplex Touch Term screen command for data entry APX-180	
Wyse horiz & vert split screen, metal case detach keyboard WYS-100	825 00
Televideo 910C simulator 1Y-910C	595 00
Televideo 910 Plus black mouse TVI-910P	595 00
Televideo 925C detachable keyboard, 22 function keys TVI-925	795 00
Televideo 950 graphic char. spm screen 22 function keys TVI-950	195 00
IBM 3101-10 detachable keyboard, green IBM 3101	1 950 00
Zenith Z-19 keyboard 2TH-Z19	765 00
Adds Viewpoint A1 detachable keyboard ADD-VP1	
Adds Viewpoint A2 w/ cursor screen screen ADD-VP2	
Adds Viewpoint A3 emulator ADD-VP3	

S-100 BOARDS

16 BIT MICROPROCESSORS		
GBI-867	8088/8087 Microprocessor board	950 00
GBI-867	8088/8087 dual 8 bit microprocessor	359 00
SEA-806	Sanyo Computer 16 bit micro two board set	65 00
TEC-806	Tecmar Computer 16 bit microprocessor	56 00
LDI-806	Lotus Data Systems Lighting Ltd. card	93 50
WAV-811	Wavebyte Baker 1 with floppy 256K 100 S-100	75 00
AMD-280	Advanced Micro Digital floppy & 64K Teletype FDCI Single board NEC785 controller	750 00
TEL-F001	Televideo 925C Single board NEC785 controller	675 00
8 BIT MICROPROCESSORS		
GBI-280	Godbout 1208 bit CPU 24 bit extended address	250 00
CCS-2810	California Computer 280 microprocessor	275 99
SOS-3200	SOS systems SOS 3200 Z80 microprocessor	275 00
MSA-280	Measurement System 2 80 280 microprocessor	425 01
EAR-280	Earl Electronics 280 with two RS232 ports	395 01
FLOPPY DISK CONTROLLERS		
GBI-DISK1	Godbout Disk One double density REC-765	395 00
GBI-DISK2	Godbout Disk Two double density REC-765	395 00
GBI-DISK3	Godbout Disk Three double density REC-765	395 00
GBI-DISK4	Godbout Disk Four double density REC-765	395 00
GBI-DISK5	Godbout Disk Five double density REC-765	395 00
GBI-DISK6	Godbout Disk Six double density REC-765	395 00
GBI-DISK7	Godbout Disk Seven double density REC-765	395 00
GBI-DISK8	Godbout Disk Eight double density REC-765	395 00
GBI-DISK9	Godbout Disk Nine double density REC-765	395 00
GBI-DISK10	Godbout Disk Ten double density REC-765	395 00
GBI-DISK11	Godbout Disk Eleven double density REC-765	395 00
GBI-DISK12	Godbout Disk Twelve double density REC-765	395 00
GBI-DISK13	Godbout Disk Thirteen double density REC-765	395 00
GBI-DISK14	Godbout Disk Fourteen double density REC-765	395 00
GBI-DISK15	Godbout Disk Fifteen double density REC-765	395 00
GBI-DISK16	Godbout Disk Sixteen double density REC-765	395 00
GBI-DISK17	Godbout Disk Seventeen double density REC-765	395 00
GBI-DISK18	Godbout Disk Eighteen double density REC-765	395 00
GBI-DISK19	Godbout Disk Nineteen double density REC-765	395 00
GBI-DISK20	Godbout Disk Twenty double density REC-765	395 00
GBI-DISK21	Godbout Disk Twenty One double density REC-765	395 00
GBI-DISK22	Godbout Disk Twenty Two double density REC-765	395 00
GBI-DISK23	Godbout Disk Twenty Three double density REC-765	395 00
GBI-DISK24	Godbout Disk Twenty Four double density REC-765	395 00
GBI-DISK25	Godbout Disk Twenty Five double density REC-765	395 00
GBI-DISK26	Godbout Disk Twenty Six double density REC-765	395 00
GBI-DISK27	Godbout Disk Twenty Seven double density REC-765	395 00
GBI-DISK28	Godbout Disk Twenty Eight double density REC-765	395 00
GBI-DISK29	Godbout Disk Twenty Nine double density REC-765	395 00
GBI-DISK30	Godbout Disk Thirty double density REC-765	395 00
GBI-DISK31	Godbout Disk Thirty One double density REC-765	395 00
GBI-DISK32	Godbout Disk Thirty Two double density REC-765	395 00
GBI-DISK33	Godbout Disk Thirty Three double density REC-765	395 00
GBI-DISK34	Godbout Disk Thirty Four double density REC-765	395 00
GBI-DISK35	Godbout Disk Thirty Five double density REC-765	395 00
GBI-DISK36	Godbout Disk Thirty Six double density REC-765	395 00
GBI-DISK37	Godbout Disk Thirty Seven double density REC-765	395 00
GBI-DISK38	Godbout Disk Thirty Eight double density REC-765	395 00
GBI-DISK39	Godbout Disk Thirty Nine double density REC-765	395 00
GBI-DISK40	Godbout Disk Forty double density REC-765	395 00
GBI-DISK41	Godbout Disk Forty One double density REC-765	395 00
GBI-DISK42	Godbout Disk Forty Two double density REC-765	395 00
GBI-DISK43	Godbout Disk Forty Three double density REC-765	395 00
GBI-DISK44	Godbout Disk Forty Four double density REC-765	395 00
GBI-DISK45	Godbout Disk Forty Five double density REC-765	395 00
GBI-DISK46	Godbout Disk Forty Six double density REC-765	395 00
GBI-DISK47	Godbout Disk Forty Seven double density REC-765	395 00
GBI-DISK48	Godbout Disk Forty Eight double density REC-765	395 00
GBI-DISK49	Godbout Disk Forty Nine double density REC-765	395 00
GBI-DISK50	Godbout Disk Fifty double density REC-765	395 00
GBI-DISK51	Godbout Disk Fifty One double density REC-765	395 00
GBI-DISK52	Godbout Disk Fifty Two double density REC-765	395 00
GBI-DISK53	Godbout Disk Fifty Three double density REC-765	395 00
GBI-DISK54	Godbout Disk Fifty Four double density REC-765	395 00
GBI-DISK55	Godbout Disk Fifty Five double density REC-765	395 00
GBI-DISK56	Godbout Disk Fifty Six double density REC-765	395 00
GBI-DISK57	Godbout Disk Fifty Seven double density REC-765	395 00
GBI-DISK58	Godbout Disk Fifty Eight double density REC-765	395 00
GBI-DISK59	Godbout Disk Fifty Nine double density REC-765	395 00
GBI-DISK60	Godbout Disk Sixty double density REC-765	395 00
GBI-DISK61	Godbout Disk Sixty One double density REC-765	395 00
GBI-DISK62	Godbout Disk Sixty Two double density REC-765	395 00
GBI-DISK63	Godbout Disk Sixty Three double density REC-765	395 00
GBI-DISK64	Godbout Disk Sixty Four double density REC-765	395 00
GBI-DISK65	Godbout Disk Sixty Five double density REC-765	395 00
GBI-DISK66	Godbout Disk Sixty Six double density REC-765	395 00
GBI-DISK67	Godbout Disk Sixty Seven double density REC-765	395 00
GBI-DISK68	Godbout Disk Sixty Eight double density REC-765	395 00
GBI-DISK69	Godbout Disk Sixty Nine double density REC-765	395 00
GBI-DISK70	Godbout Disk Seventy double density REC-765	395 00
GBI-DISK71	Godbout Disk Seventy One double density REC-765	395 00
GBI-DISK72	Godbout Disk Seventy Two double density REC-765	395 00
GBI-DISK73	Godbout Disk Seventy Three double density REC-765	395 00
GBI-DISK74	Godbout Disk Seventy Four double density REC-765	395 00
GBI-DISK75	Godbout Disk Seventy Five double density REC-765	395 00
GBI-DISK76	Godbout Disk Seventy Six double density REC-765	395 00
GBI-DISK77	Godbout Disk Seventy Seven double density REC-765	395 00
GBI-DISK78	Godbout Disk Seventy Eight double density REC-765	395 00
GBI-DISK79	Godbout Disk Seventy Nine double density REC-765	395 00
GBI-DISK80	Godbout Disk Eighty double density REC-765	395 00
GBI-DISK81	Godbout Disk Eighty One double density REC-765	395 00
GBI-DISK82	Godbout Disk Eighty Two double density REC-765	395 00
GBI-DISK83	Godbout Disk Eighty Three double density REC-765	395 00
GBI-DISK84	Godbout Disk Eighty Four double density REC-765	395 00
GBI-DISK85	Godbout Disk Eighty Five double density REC-765	395 00
GBI-DISK86	Godbout Disk Eighty Six double density REC-765	395 00
GBI-DISK87	Godbout Disk Eighty Seven double density REC-765	395 00
GBI-DISK88	Godbout Disk Eighty Eight double density REC-765	395 00
GBI-DISK89	Godbout Disk Eighty Nine double density REC-765	395 00
GBI-DISK90	Godbout Disk Ninety double density REC-765	395 00
GBI-DISK91	Godbout Disk Ninety One double density REC-765	395 00
GBI-DISK92	Godbout Disk Ninety Two double density REC-765	395 00
GBI-DISK93	Godbout Disk Ninety Three double density REC-765	395 00
GBI-DISK94	Godbout Disk Ninety Four double density REC-765	395 00
GBI-DISK95	Godbout Disk Ninety Five double density REC-765	395 00
GBI-DISK96	Godbout Disk Ninety Six double density REC-765	395 00
GBI-DISK97	Godbout Disk Ninety Seven double density REC-765	395 00
GBI-DISK98	Godbout Disk Ninety Eight double density REC-765	395 00
GBI-DISK99	Godbout Disk Ninety Nine double density REC-765	395 00
GBI-DISK100	Godbout Disk One hundred double density REC-765	395 00

WORD PROCESSING PRINTERS

NEC 7110 55 char/second, serial interface	NEC-7110	237900
NEC 7230 same as above only parallel interface	NEC-7230	237900
NEC 3510 15 serial	NEC-3510	177500
Dalby 63040 char/sec serial	DBL-630	225000
Bolton HR11 daisywheel	BTH-HR11S	85500
Bolton HR11 daisywheel/serial	BTH-HR11S	89500
Smith Corona TP-1 daisywheel/serial	SCM-TP1S	65900
Starwriter F10 serial	PRO-F10S	117500
Starwriter F10 parallel	PRO-F10P	117500

APPLE 48K Plus \$1089

APPLE BRAND PRODUCTS

APL-48P	Apple Plus 48K RAM	
APL-DSK1	Apple disk with controller card	58000
APL-DSK2	Apple disk without controller card	49500
XTN-G10	Xiten 10 Megabyte Gallium hard disk	1 995 00
XTN-16K	16K RAM card for Apple II	6 900
RAN-APL1	Apple add on disk drive with controller	52500
RAN-APL2	Apple add on drive without controller	39500

256K DYNAMIC MEMORY BOARD

\$495

- 256 Kilobytes of non-volatile dynamic memory
- Operationally transparent using in-house 256K dynamic RAM chips
- Error detection-trap capability
- Individual 16K blocks can be relocated to any boundary within a megabyte of RAM.
- 24 bit addressing and glitchless data capability

The Electronics Digital 256K RAM board represents an entirely new generation of dynamic RAM. It is a 256K dynamic RAM chip that can be programmed to any of the 256K memory locations. It is a 256K dynamic RAM chip that can be programmed to any of the 256K memory locations. It is a 256K dynamic RAM chip that can be programmed to any of the 256K memory locations.

MONITORS

Zenith 2121 green phosphor 12" 40:80 column/writer JVI-1212	11500
EMC 12A green phosphor 15MHz, compass auto EMC-12A	8800
EMC 12EM green phosphor 15MHz, high resolution EMC-12EM	13900
NEC 15500 green phosphor 15" high contrast video NEC-15500	18900
NEC 20760 green phosphor commercial grade composite NEC-1260	12900
Matsushita 21" open frame black/white composite video MGT-EM21	15900
Matsushita 17" open frame black/white composite video MGT-EM17	8900
Canon 17" open frame black/white composite video CAN-17	5900
Canon 15" open frame black/white composite video CAN-15	5900
NEC JC2000 composite color NEC-JC2000	32500
NEC REC monitor NEC-12020M	87500
EMC 13" composite video EMC-1400C	27300
EMC 12" RGB color monitor EMC-1400RGB	32900
EMC color/acc card for Apple II for active RGB EMC-D150	14900
Comex/H480 13" RGB high res. monitor COM-4800	53000
Comex/H480 15" RGB high res. monitor COM-4800	56500
Amtek color 81 composite video AMT-120	34800
Amtek color 82 high res. RGB color monitor AMT-200	73900
Amtek color 83 commercial grade color RGB AMT-300	47500

CALIFORNIA COMPUTER SYSTEMS

Asynchronous Serial Interface	125.00
Centronics Parallel Interface	95.00
Apple Parallel Interface	95.00
12K Rpm/Plom Module	115.00
Calendar/Block Module	95.00
Programmable Timer	95.00
Arithmetic Processor for Apple II plus	319.00

MOUNTAIN COMPUTERS, INC.

CPS Multifunction Card Clock/Calendar	169.00
SuperTalker 50200	149.00
Rpm Plus with Keyboard Filter	69.00
Rem Writer with Spring socket	15.00
A-D/D-A Converter	269.00
X-10 Control Card for BSR system	119.00

MICRO SOFT

Microsoft Z-80 CPU card	24900
Microsoft 16K RAM card	12500

VISTA

Vista 8" controller card	189.00
Vista 16K RAM	289.00
Micro Soft disk drive controller	89.00

FOURTH DIMENSION

Super Drive 35 track Apple add on	329.00
-----------------------------------	--------

SORRENTO VALLEY ASSOC

Single sided, single density controller	26000
Double sided, single density controller	36000
Single or double sided, double density	47500

ADVANCED BUSINESS TECH

ABT-LK576	65.00
-----------	-------

256K DYNAMIC MEMORY BOARD

\$495

• 256 Kilobytes of non-volatile dynamic memory

The Electronics Digital 256K RAM board represents an entirely new generation of dynamic RAM. It is a 256K dynamic RAM chip that can be programmed to any of the 256K memory locations. It is a 256K dynamic RAM chip that can be programmed to any of the 256K memory locations. It is a 256K dynamic RAM chip that can be programmed to any of the 256K memory locations.

Shipping: First five pounds \$3.00. Each additional \$.50. Foreign orders: 10% shipping. Excess will be refunded. California residents add 6 1/2% sales tax. COD's discouraged. Open accounts extended to state supported educational institutions and companies with a "strong" Dun & Bradstreet. Warehouse: 15608 Inglewood Blvd. Visitors by appointment.

TOLL FREE ORDER LINE (800) 421-5041 TECHNICAL & CALIFORNIA (213) 679-9001

7400

*Number of Pins of each I.C. for Easy Socket purchase

MICROPROCESSOR COMPONENTS

Part No.	**Pins	Price	Part No.	**Pins	Price	Part No.	**Pins	Price
SN7400N	14	.19	SN7472N	14	.29	SN74155N	16	.59
SN7401N	14	.19	SN7473N	14	.35	SN74165N	16	.69
SN7402N	14	.25	SN7474N	14	.35	SN74175N	16	.69
SN7403N	14	.25	SN7475N	16	.35	SN74185N	16	.69
SN7404N	14	.25	SN7476N	16	.35	SN74195N	16	.69
SN7405N	14	.25	SN7477N	14	.45	SN74205N	16	.69
SN7406N	14	.29	SN7478N	16	.69	SN74215N	16	.69
SN7407N	14	.29	SN7479N	14	1.19	SN74225N	16	.69
SN7408N	14	.25	SN7480N	16	.59	SN74235N	16	.69
SN7409N	14	.25	SN7481N	16	.59	SN74245N	16	.69
SN7410N	14	.25	SN7482N	16	.59	SN74255N	16	.69
SN7411N	14	.25	SN7483N	16	.59	SN74265N	16	.69
SN7412N	14	.25	SN7484N	14	.69	SN74275N	16	.69
SN7413N	14	.35	SN7485N	16	.59	SN74285N	16	.69
SN7414N	14	.49	SN7486N	14	.35	SN74295N	16	.69
SN7415N	14	.25	SN7487N	14	.35	SN74305N	16	.69
SN7416N	14	.25	SN7488N	14	.35	SN74315N	16	.69
SN7417N	14	.25	SN7489N	14	.69	SN74325N	16	.69
SN7418N	14	.25	SN7490N	14	.69	SN74335N	16	.69
SN7419N	14	.25	SN7491N	14	.69	SN74345N	16	.69
SN7420N	14	.25	SN7492N	14	.69	SN74355N	16	.69
SN7421N	14	.35	SN7493N	14	.69	SN74365N	16	.69
SN7422N	14	.45	SN7494N	16	.25	SN74375N	16	.69
SN7423N	16	.59	SN7495N	14	1.49	SN74385N	16	.69
SN7424N	16	.59	SN7496N	16	.49	SN74395N	16	.69
SN7425N	16	.59	SN7497N	16	.25	SN74405N	16	.69
SN7426N	16	.59	SN7498N	16	.25	SN74415N	16	.69
SN7427N	14	.25	SN7499N	14	.29	SN74425N	16	.69
SN7428N	14	.49	SN7500N	16	.39	SN74435N	16	.69
SN7429N	14	.25	SN7501N	14	1.49	SN74445N	16	.69
SN7430N	14	.25	SN7502N	14	1.49	SN74455N	16	.69
SN7431N	14	.25	SN7503N	14	1.19	SN74465N	16	.69
SN7432N	14	.25	SN7504N	14	1.19	SN74475N	16	.69
SN7433N	14	.25	SN7505N	14	1.19	SN74485N	16	.69
SN7434N	14	.25	SN7506N	14	1.19	SN74495N	16	.69
SN7435N	14	.25	SN7507N	14	1.19	SN74505N	16	.69
SN7436N	14	.25	SN7508N	14	1.19	SN74515N	16	.69
SN7437N	14	.25	SN7509N	14	1.19	SN74525N	16	.69
SN7438N	14	.25	SN7510N	14	1.19	SN74535N	16	.69
SN7439N	14	.25	SN7511N	14	1.19	SN74545N	16	.69
SN7440N	14	.25	SN7512N	14	1.19	SN74555N	16	.69
SN7441N	14	.25	SN7513N	14	1.19	SN74565N	16	.69
SN7442N	14	.25	SN7514N	14	1.19	SN74575N	16	.69
SN7443N	14	.25	SN7515N	14	1.19	SN74585N	16	.69
SN7444N	14	.25	SN7516N	14	1.19	SN74595N	16	.69
SN7445N	14	.25	SN7517N	14	1.19	SN74605N	16	.69
SN7446N	14	.25	SN7518N	14	1.19	SN74615N	16	.69
SN7447N	14	.25	SN7519N	14	1.19	SN74625N	16	.69
SN7448N	14	.25	SN7520N	14	1.19	SN74635N	16	.69
SN7449N	14	.25	SN7521N	14	1.19	SN74645N	16	.69
SN7450N	14	.25	SN7522N	14	1.19	SN74655N	16	.69
SN7451N	14	.25	SN7523N	14	1.19	SN74665N	16	.69
SN7452N	14	.25	SN7524N	14	1.19	SN74675N	16	.69
SN7453N	14	.25	SN7525N	14	1.19	SN74685N	16	.69
SN7454N	14	.25	SN7526N	14	1.19	SN74695N	16	.69
SN7455N	14	.25	SN7527N	14	1.19	SN74705N	16	.69
SN7456N	14	.25	SN7528N	14	1.19	SN74715N	16	.69
SN7457N	14	.25	SN7529N	14	1.19	SN74725N	16	.69
SN7458N	14	.25	SN7530N	14	1.19	SN74735N	16	.69
SN7459N	14	.25	SN7531N	14	1.19	SN74745N	16	.69
SN7460N	14	.25	SN7532N	14	1.19	SN74755N	16	.69
SN7461N	14	.25	SN7533N	14	1.19	SN74765N	16	.69
SN7462N	14	.25	SN7534N	14	1.19	SN74775N	16	.69
SN7463N	14	.25	SN7535N	14	1.19	SN74785N	16	.69
SN7464N	14	.25	SN7536N	14	1.19	SN74795N	16	.69
SN7465N	14	.25	SN7537N	14	1.19	SN74805N	16	.69
SN7466N	14	.25	SN7538N	14	1.19	SN74815N	16	.69
SN7467N	14	.25	SN7539N	14	1.19	SN74825N	16	.69
SN7468N	14	.25	SN7540N	14	1.19	SN74835N	16	.69
SN7469N	14	.25	SN7541N	14	1.19	SN74845N	16	.69
SN7470N	14	.25	SN7542N	14	1.19	SN74855N	16	.69
SN7471N	14	.25	SN7543N	14	1.19	SN74865N	16	.69
SN7472N	14	.25	SN7544N	14	1.19	SN74875N	16	.69
SN7473N	14	.25	SN7545N	14	1.19	SN74885N	16	.69
SN7474N	14	.25	SN7546N	14	1.19	SN74895N	16	.69
SN7475N	14	.25	SN7547N	14	1.19	SN74905N	16	.69
SN7476N	14	.25	SN7548N	14	1.19	SN74915N	16	.69
SN7477N	14	.25	SN7549N	14	1.19	SN74925N	16	.69
SN7478N	14	.25	SN7550N	14	1.19	SN74935N	16	.69
SN7479N	14	.25	SN7551N	14	1.19	SN74945N	16	.69
SN7480N	14	.25	SN7552N	14	1.19	SN74955N	16	.69
SN7481N	14	.25	SN7553N	14	1.19	SN74965N	16	.69
SN7482N	14	.25	SN7554N	14	1.19	SN74975N	16	.69
SN7483N	14	.25	SN7555N	14	1.19	SN74985N	16	.69
SN7484N	14	.25	SN7556N	14	1.19	SN74995N	16	.69
SN7485N	14	.25	SN7557N	14	1.19	SN7500N	16	.69
SN7486N	14	.25	SN7558N	14	1.19			
SN7487N	14	.25	SN7559N	14	1.19			
SN7488N	14	.25	SN7560N	14	1.19			
SN7489N	14	.25	SN7561N	14	1.19			
SN7490N	14	.25	SN7562N	14	1.19			
SN7491N	14	.25	SN7563N	14	1.19			
SN7492N	14	.25	SN7564N	14	1.19			
SN7493N	14	.25	SN7565N	14	1.19			
SN7494N	14	.25	SN7566N	14	1.19			
SN7495N	14	.25	SN7567N	14	1.19			
SN7496N	14	.25	SN7568N	14	1.19			
SN7497N	14	.25	SN7569N	14	1.19			
SN7498N	14	.25	SN7570N	14	1.19			
SN7499N	14	.25	SN7571N	14	1.19			
SN7500N	14	.25	SN7572N	14	1.19			

MICROPROCESSOR CHIPS			DYNAMIC RAMS			
Part No.	**Pins	Price	Part No.	**Pins	Price	
CDP1802	40	CPU	TI103	16	1024x1 (300ns)	.99
CDP1803	40	CPU	TI104	16	4096x1 (300ns)	1.99
10M7901ADC	40	CPU - 8 bit (8080/8085/8088)	4118N-2	16	16.384x1 (200ns)	1.89
MS5552	40	CPU - 16 bit (8086/8088)	4118N-3	16	16.384x1 (200ns)	1.69
MS5553	40	CPU - 16 bit (8086/8088)	4118N-4	16	16.384x1 (200ns)	1.49
MS5554	40	CPU - 16 bit (8086/8088)	4118N-5	16	16.384x1 (200ns)	1.29
MS5555	40	CPU - 16 bit (8086/8088)	4118N-6	16	16.384x1 (200ns)	1.09
MS5556	40	CPU - 16 bit (8086/8088)	4118N-7	16	16.384x1 (200ns)	.89
MS5557	40	CPU - 16 bit (8086/8088)	4118N-8	16	16.384x1 (200ns)	.69
MS5558	40	CPU - 16 bit (8086/8088)	4118N-9	16	16.384x1 (200ns)	.49
MS5559	40	CPU - 16 bit (8086/8088)	4118N-10	16	16.384x1 (200ns)	.29
MS5560	40	CPU - 16 bit (8086/8088)	4118N-11	16	16.384x1 (200ns)	.09
MS5561	40	CPU - 16 bit (8086/8088)	4118N-12	16	16.384x1 (200ns)	.09
MS5562	40	CPU - 16 bit (8086/8088)	4118N-13	16	16.384x1 (200ns)	.09
MS5563	40	CPU - 16 bit (8086/8088)	4118N-14	16	16.384x1 (200ns)	.09
MS5564	40	CPU - 16 bit (8086/8088)	4118N-15	16	16.384x1 (200ns)	.09
MS5565	40	CPU - 16 bit (8086/8088)	4118N-16	16	16.384x1 (200ns)	.09
MS5566	40	CPU - 16 bit (8086/8088)	4118N-17	16	16.384x1 (200ns)	.09
MS5567	40	CPU - 16 bit (8086/8088)	4118N-18	16	16.384x1 (200ns)	.09
MS5568	40	CPU - 16 bit (8086/8088)	4118N-19	16	16.384x1 (200ns)	.09
MS5569	40	CPU - 16 bit (8086/8088)	4118N-20	16	16.384x1 (200ns)	.09
MS5570	40	CPU - 16 bit (8086/8088)	4118N-21	16	16.384x1 (200ns)	.09
MS5571	40	CPU - 16 bit (8086/8088)	4118N-22	16	16.384x1 (200ns)	.09
MS5572	40	CPU - 16 bit (8086/8088)	4118N-23	16	16.384x1 (200ns)	.09
MS5573	40	CPU - 16 bit (8086/8088)	4118N-24	16	16.384x1 (200ns)	.09
MS5574	40	CPU - 16 bit (8086/8088)	4118N-25	16	16.384x1 (200ns)	.09
MS5575	40	CPU - 16 bit (8086/8088)	4118N-26	16	16.384x1 (200ns)	.09
MS5576	40	CPU - 16 bit (8086/8088)	4118N-27	16	16.384x1 (200ns)	.09
MS5577	40	CPU - 16 bit (8086/8088)	4118N-28	16	16.384x1 (200ns)	.09
MS5578	40	CPU - 16 bit (8086/8088)	4118N-29	16	16.384x1 (200ns)	.09
MS5579	40	CPU - 16 bit (8086/8088)	4118N-30	16	16.384x1 (200ns)	.09
MS5580	40	CPU - 16 bit (8086/8088)	4118N-31	16	16.384x1 (200ns)	.09
MS5581	40	CPU - 16 bit (8086/8088)	4118N-32	16	16.384x1 (200ns)	.09
MS5582	40	CPU - 16 bit (8086/8088)	4118N-33	16	16.384x1 (200ns)	.09
MS5583	40	CPU - 16 bit (8086/8088)	4118N-34	16	16.384x1 (200ns)	.09
MS5584	40	CPU - 16 bit (8086/8088)	4118N-35	16	16.384x1 (200ns)	.09
MS5585	40	CPU - 16 bit (8086/8088)	4118N-36	16	16.384x1 (200ns)	.09
MS5586	40	CPU - 16 bit (8086/8088)	4118N-37	16	16.384x1 (200ns)	.09
MS5587	40	CPU - 16 bit (8086/8088)	4118N-38	16	16.384x1 (200ns)	.09
MS5588	40	CPU - 16 bit (8086/8088)	4118N-39	16	16.384x1 (200ns)	.09
MS5589	40	CPU - 16 bit (8086/8088)	4118N-40	16	16.384x1 (200ns)	.09
MS5590	40	CPU - 16 bit (8086/8088)	4118N-41	16	16.384x1 (200ns)	.09
MS5591	40	CPU - 16 bit (8086/8088)	4118N-42	16	16.384x1 (200ns)	.09
MS5592	40	CPU - 16 bit (8086/8088)	4118N-43	16	16.384x1 (200ns)	.09
MS5593	40	CPU - 16 bit (8				

DoKay Computer Products, Inc.

VISIT OUR RETAIL STORE
AND RECEIVE A 5% DISCOUNT!

3250 KELLER STREET, #9 • SANTA CLARA, CA 95050

16K APPLE[®] II RAM CARD

BARE BOARD 14.00
KIT 39.90
ASSEMBLED 45.00

*Apple is a trademark of Apple Computer, Inc.

EPROMS		STATIC RAMS	
1702	1ns	3.00	
2708	450ns	2.99	2101 450ns 1.85
2758	5V 450ns	9.75	2102-1 450ns 1.79
TMS 2516	5V 450ns	5.75	2102L-2 250ns LP 1.55
2716	5V 450ns	3.49	2111 450ns 2.49
2716-1	5V 350ns	7.85	2112 450ns 2.69
TMS 2716	450ns	8.75	2114 450ns 1.75
2532	5V 450ns	7.85	2114 L-3 300ns LP 1.85
2732	5V 450ns	6.49	2114 L-2 200ns LP 1.95
2764	5V 450ns	Call	2147 55ns 8.95
MC 68764	(5V 450ns) (24 pin)	Call	TMS 4044-4 450ns 3.20
			TMS 4044-3 300ns 3.50
			TMS 4044-2 200ns 3.95
			MK 4118 250ns 9.75
			TMM 2016 200ns 5.49
			TMM 2016 150ns 6.49
			TMM 2016 100ns 7.49
			HM6116-4 200ns Call
			HM6116-3 150ns Call
			HM6116-2 120ns Call
			Z-6132 300ns Call

DYNAMIC RAMS

TMS 4027	250ns	2.00
MK 4108	200ns	1.75
MM 5298	250ns	1.75
4116-1	150ns	1.75
4116-2	200ns	1.25
4116-3	250ns	1.15
2118	5V 150ns	Call
MK 4816	5V 300ns	Call
4164-200	5V 200ns	Call
4164-150	5V 150ns	Call

LP = Low Power

INTERFACE

8T26	1.65
8T28	1.95
8T95	.95
8T96	.95
8T97	.95
8T98	.95
DM8131	2.90
DP8304	2.25
DS8836	1.25

RESISTORS

1/4 WATT 5% CARBON FILM	
ALL STANDARD VALUES	
FROM 1 OHM TO 10 MEG OHM	
50 PCS. SAME VALUE	.0200
100 PCS. SAME VALUE	.0150
1000 PCS. SAME VALUE	.0125

6500

1 MHZ	
6502	5.49
6504	6.90
6505	7.65
6507	9.90
6520	4.35
6522	7.95
6532	9.95
6545	19.95
6551	11.75

We Will Beat
Any Competitors'
Prices!

2 MHZ	
6502A	9.45
6522A	10.95
6532A	11.95
6545A	27.95
6551A	11.95

3 MHZ	
6502B	11.95

74LS00 SERIES

74LS00	.24	74LS123	.95	74LS253	.80
74LS01	.24	74LS124	2.90	74LS257	.80
74LS02	.24	74LS125	.95	74LS258	.80
74LS03	.24	74LS126	.79	74LS259	2.80
74LS04	.24	74LS132	.75	74LS260	.60
74LS05	.24	74LS135	.49	74LS266	.49
74LS08	.24	74LS137	.95	74LS273	1.60
74LS10	.24	74LS138	.75	74LS275	3.25
74LS11	.30	74LS139	.75	74LS279	.49
74LS12	.30	74LS145	1.10	74LS280	1.95
74LS13	.40	74LS147	2.20	74LS283	.95
74LS14	.89	74LS148	1.20	74LS290	1.20
74LS15	.30	74LS151	.75	74LS293	1.79
74LS20	.24	74LS153	.75	74LS295	.99
74LS21	.30	74LS154	1.75	74LS298	.99
74LS22	.24	74LS155	.89	74LS324	1.75
74LS26	.30	74LS156	.89	74LS352	1.49
74LS27	.24	74LS157	.75	74LS353	1.49
74LS28	.30	74LS158	.75	74LS363	1.49
74LS30	.24	74LS160	.95	74LS364	1.95
74LS32	.36	74LS161	.95	74LS365	.89
74LS33	.55	74LS162	.95	74LS366	.89
74LS37	.55	74LS163	.95	74LS367	.69
74LS38	.35	74LS164	.95	74LS368	.69
74LS40	.30	74LS165	.95	74LS373	.69
74LS42	.49	74LS166	1.95	74LS374	1.69
74LS47	.75	74LS168	1.69	74LS377	1.40
74LS48	.75	74LS169	1.69	74LS378	1.15
74LS49	.75	74LS170	1.69	74LS379	1.35
74LS51	.30	74LS173	.75	74LS385	1.89
74LS54	.35	74LS174	.89	74LS386	.59
74LS55	.35	74LS175	.89	74LS390	1.79
74LS63	1.20	74LS181	1.99	74LS393	1.79
74LS73	.39	74LS189	9.50	74LS395	1.59
74LS74	.44	74LS190	.89	74LS399	1.59
74LS75	.49	74LS191	.89	74LS424	2.89
74LS76	.39	74LS192	.89	74LS447	.75
74LS78	.49	74LS193	.89	74LS490	1.89
74LS83	.75	74LS194	.89	74LS668	1.65
74LS85	.95	74LS195	.89	74LS669	1.85
74LS86	.39	74LS196	.79	74LS670	2.10
74LS90	.65	74LS197	.79	74LS674	9.50
74LS91	.79	74LS221	1.10	74LS682	2.99
74LS92	.65	74LS240	.95	74LS683	2.39
74LS93	.59	74LS241	.95	74LS684	2.39
74LS95	.79	74LS242	1.79	74LS685	2.39
74LS96	.79	74LS243	1.79	74LS688	2.39
74LS107	.39	74LS244	.95	74LS689	2.39
74LS109	.39	74LS245	1.89		
74LS112	.39	74LS247	.79	81LS95	1.65
74LS113	.39	74LS248	1.20	81LS96	1.65
74LS114	.49	74LS249	.89	81LS97	1.65
74LS122	.45	74LS251	1.25	81LS98	1.65

UARTS

AY5 1014	5.85
AY5 1013	3.90
AY5 2376	10.95
TR 1602	3.90
1M 6402	7.85
1M 6403	8.85

LEDS

Jumbo Red	10/1.00
Jumbo Green	6/1.00
Jumbo Yellow	6/1.00

DIP SWITCHES

4 Position	.85
5 Position	.90
6 Position	.90
7 Position	.90
8 Position	.95

EXAR

XR 2206	3.75
XR 2207	3.75
XR 2208	3.90
XR 2211	5.25
XR 2240	3.25

RCA

CA 3010	.95
CA 3013	1.99
CA 3023	2.75
CA 3035	2.49
CA 3039	1.25
CA 3046	1.25
CA 3053	1.45
CA 3059	2.90
CA 3060	2.90
CA 3065	1.75
CA 3080	1.10
CA 3081	1.65
CA 3082	1.65
CA 3083	1.65
CA 3086	.80
CA 3089	2.90
CA 3130	1.25
CA 3140	1.15
CA 3146	1.75
CA 3160	1.15
CA 3401	.59
CA 3600	3.45

CMOS

4000	.25	4086	.90	74C89	4.50
4001	.30	4093	.90	74C90	1.75
4002	.30	4098	2.49	74C93	1.75
4006	.90	4099	1.90	74C95	1.75
4007	.25	4502	.90	74C107	1.00
4008	.90	1503	.60	74C150	5.75
4009	.45	1508	1.90	74C151	2.25
4010	.45	4510	.90	74C154	3.25
4011	.30	4511	.90	74C157	1.75
4012	.30	4512	.90	74C160	2.00
4013	.45	4514	1.20	74C161	2.00
4014	.90	4515	2.20	74C162	2.00
4015	.90	4516	1.50	74C163	2.00
4016	.45	4518	1.20	74C164	2.00
4017	1.15	4519	1.20	74C165	2.00
4018	.90	4520	1.20	74C173	2.00
4019	.45	4522	1.20	74C174	2.25
4020	.90	4526	1.20	74C175	2.25
4021	.90	4527	1.90	74C192	2.25
4022	1.10	4528	1.20	74C193	2.25
4023	.35	4531	.90	74C195	2.25
4024	.75	4532	1.90	74C200	5.75
4025	.35	4538	1.90	74C221	2.25
4026	1.60	4539	1.90	74C373	2.75
4027	.60	4543	2.70	74C374	2.75
4028	.75	4555	.90	74C901	.80
4029	.90	4556	.90	74C902	.85
4030	.45	4581	1.90	74C903	.85
4034	2.90	4582	1.90	74C905	10.95
4035	.85	4584	.90	74C906	.95
4040	.90	4585	.90	74C907	1.00
4041	1.20			74C908	2.00
4042	.75	80C07	.90	74C909	2.75
4043	.75	80C95	.90	74C910	9.95
4044	.75	80C96	.90	74C911	10.00
4046	.90	80C97	.90	74C912	10.00
4047	.90	80C98	1.15	74C914	1.95
4049	.50			74C915	2.00
4050	.50	74C00	.35	74C918	2.75
4051	.90	74C02	.35	74C920	17.95
4053	.90	74C04	.35	74C921	15.95
4060	1.39	74C08	.35	74C922	5.59
4066	.75	74C10	.35	74C923	5.95
4068	.39	74C14	1.50	74C925	6.75
4069	.30	74C20	.35	74C926	7.95
4070	.35	74C30	.35	74C927	7.95
4071	.30	74C32	.50	74C928	7.95
4072	.30	74C42	1.75	74C929	19.95
4073	.30	74C48	1.20	74C930	19.95
4076	.90	74C73	.65		
4078	.30	74C74	.85	14409	12.90
4081	.30	74C76	.80	14410	12.90
4082	.30	74C83	1.95	14411	11.90
4085	.90	74C85	1.95	14412	12.90
		74C86	.95	14419	4.90

APPLE II USERS DISK DRIVE!

- Includes metal cabinet
- Color matches Apple
- 35 Tracks/single side
- Includes cable
- Use with Apple II Controller

279.00

WITH CONTROLLER CARD - 359.95

APPLE **UPGRADE** **TRS-80**
4116 - 200_{ns}
8/10.00

2.5 MHZ		Z80 SERIES		2.5 MHZ	
Z80-CPU	3.75	Z80A-DMA	25.95	Z80A-DMA	25.95
Z80-PIO	4.95	Z80A-DART	17.95	Z80A-DART	17.95
Z80-CTC	4.95	Z80A-SIO/0	21.95	Z80A-SIO/0	21.95
Z80-DMA	16.95	Z80A-SIO/1	21.95	Z80A-SIO/1	21.95
Z80-DART	14.95	Z80A-SIO/2	21.95	Z80A-SIO/2	21.95
Z80-SIO/0	17.95	Z80A-SIO/9	18.95	Z80A-SIO/9	18.95
Z80-SIO/1	17.95	6.0 MHZ		Z80B-CPU	16.95
Z80-SIO/2	17.95	Z80B-PIO	14.95	Z80B-PIO	14.95
Z80-SIO/9	16.95	Z80B-CTC	14.95	Z80B-CTC	14.95
4.0 MHZ		ZILOG		Z6132	Call
Z80A-CPU	4.95	Z8671	Call	Z8671	Call
Z80A-PIO	4.95				
Z80A-CTC	6.95				

Do Kay Computer Products, Inc.

VISIT OUR RETAIL STORE AND RECEIVE A 5% DISCOUNT!

3250 KELLER STREET, #9 • SANTA CLARA, CA 95050

Diskettes

5 1/4"

ATHANA
SS DD SOFT. . . . 23.95
ATHANA
SS DD SOFT 24.95
ATHANA
DS DD SOFT 31.95

BULK
SS DD SOFT
\$1.85 ea.

LINEAR			
LM301	.32	LM741	.29
LM308	.75	LM747	.75
LM309K	1.25	LM748	.49
LM311	.64	LM1310	2.45
LM317T	1.65	MC1330	1.69
LM317K	1.70	MC1350	1.25
LM318	1.49	MC1358	1.69
LM323K	3.75	LM1414	1.49
LM324	.59	LM1458	.55
LM337K	3.90	LM1488	.95
LM339	.79	LM1489	.95
LM377	2.25	LM1600	2.45
LM380	1.25	LM1889	2.45
LM386	1.00	LM3900	.59
LM555	.38	LM3909	.99
LM556	.65	LM3914	3.70
LM565	.95	LM3915	3.70
LM566	1.45	LM3916	3.70
LM567	.99	75451	.35
LM723	.49	75452	.35
LM733	.95	75453	.35

ORDER TOLL FREE
(800) 538-8800
(800) 848-8008
(CALIFORNIA RESIDENTS)
ALL MERCHANDISE IS 100% GUARANTEED

CLOCK CIRCUITS

MM 5314	4.90
MM 5369	3.90
MM 5375	4.90
MM 58167	8.90
MM 58174	10.95
MSM 5832	6.90

9000 SERIES	MISC.	11 C 90	12.95
9316	.95	3242	6.95
9334	2.39	MC 3470	7.95
9368	3.69	MC 3480	8.95
9401	8.95	ULN 2003	5.95
9601	.69	CA 3146	1.75
9602	1.39	2513-001 up	9.69
96S02	1.79	2513-002 low	9.69

VOLTAGE REGULATORS

7805T	.75	7908T	.85
7808T	.75	7912T	.85
7812T	.75	7915T	.85
7815T	.75	7924T	.95
7824T	.85		
7805K	1.29	7905K	1.39
7812K	1.29	7912K	1.39
7815K	1.29	7915K	1.39
7824K	1.29	7924K	1.39
7905T	.85		

T = TO-220
K = TO-3

CONNECTORS

RS232 Male	3.00
RS232 Female	3.50
RS232 Female Right Angle	4.95
RS232 Hood	1.20
30 pin Edge	2.49
44 pin Edge	2.49
50 pin Edge	2.69
86 pin Edge	3.90
100 pin ST	3.90
100 pin W/W	4.90

CRYSTALS

32.768 KHZ	1.90	5.185	3.90
10 MHZ	4.50	5.7143	3.90
1.8432	4.50	6.5536	3.90
2.0	3.90	8.0	3.00
2.097152	3.90	10.0	3.00
2.4576	3.90	14.31818	3.90
3.2768	3.90	18.0	3.00
3.579545	3.00	18.432	3.00
4.0	3.00	20.0	3.00
5.0	3.00	22.1184	3.00
5.0688	3.90	32.0	3.90

8000

8035	6.95	8239	4.75
8039	7.59	8243	4.75
8080A	3.90	8250	14.90
8085A	7.95	8251	4.50
8088	34.95	8253	8.75
8155	7.75	8253-5	9.75
8156	8.75	8255	4.50
8185	29.00	8255-5	5.20
8741	39.00	8257	6.50
8748	14.95	8259	6.85
8755	29.95	8272	39.00
8202	27.95	8275	29.00
8205	3.45	8278	9.25
8212	1.80	8279-5	9.95
8214	3.75	8282	6.50
8216	1.75	8283	6.50
8224	2.45	8284	5.50
8226	1.80	8286	6.50
8228	4.50	8287	6.50
8237	19.00	8288	25.00
8238	4.75	8289	49.00

Disc Controllers

1771	16.00
1791	27.95
1793	29.95
1795	49.95
1797	49.95
1691	17.95
UPD 765	34.95

6800
1 MHZ

6800	4.75
6802	8.65
6808	8.45
6809	11.95
6809 E	17.95
6810	2.90
6820	3.50
6821	3.50
6828	14.90
6840	7.95
6843	32.95
6844	32.95
6845	16.90
6847	11.95
6850	3.20
6852	3.50
6860	10.90
6862	11.90
6875	6.90
6880	1.80
6883	22.95

IC Sockets

	ST	W/W
8 PIN	.10	.49
14 PIN	.12	.50
16 PIN	.15	.57
18 PIN	.20	.85
20 PIN	.25	.99
22 PIN	.25	1.30
24 PIN	.25	1.40
28 PIN	.35	1.50
40 PIN	.40	1.80

ST = Soldertail
W/W = Wirewrap

2 MHz

68B00	10.00
68B02	21.95
68B09	28.95
68B09 E	29.90
68B10	7.90
68B21	12.00
68B45	34.00
68B50	12.00

8 MHz

68000	95.95
-------	-------

Power Supplies

MOUNTED ON PC BOARD
MANUFACTURED BY CONVER
+5 VOLT 4 AMP
±12 VOLT 1 AMP



34.95



Do Kay Computer Products, Inc.
3250 Keller Street, #9
Santa Clara, CA 95050
(800) 538-8800
Calif. Residents Local Phone
(800) 848-8008 (408) 988-0697



STORE HOURS:
MON-FRI 10:30 A.M.-6:00 P.M.
SAT 10:00 A.M.-3:00 P.M.

TERMS: For shipping include \$2.00 for UPS Ground. \$3.00 for UPS Blue Label Air. \$10.00 minimum order. Bay Area residents add 6% Sales Tax. California residents add 6% Sales Tax. We reserve the right to limit quantities and substitute manufacturer. Prices subject to change without notice. Send SASE for complete list.

ADVANCED COMPUTER PRODUCTS

SEND \$2.00 for 1983 CATALOG

16K Apple™ Ramcard

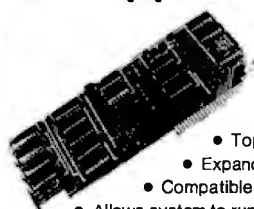

LIST 195
ACP
\$59.95

- Full 1 year warranty
- Top quality—gold fingers
- Expand Apple II 48K to 64K
- Compatible with Z-80 Softcard™
- Allows system to run with CP/M™, PASCAL, DOS 3.3, COBAL, Visicalc, etc.
- Supplied with extra 16K RAM & has (2) LED's

32K STATIC RAM



64K CMOS RAM

S100 (200ns)
Uses 2716's \$299.00
or 6116's
Assembled & Tested \$399.00

- 2 or 4 MHz Expandable Uses 2714's
- 16K 4 MHz Kit \$159.95
- 16K 4 MHz A&T \$217.95
- 32K 4 MHz Kit \$129.95
- 32K 4 MHz A&T \$209.95
- BARE BOARD \$39.95
- BarE Bd w/all parts less mem. \$99.95

MOSTEK 4K RAMS

29¢ ea.
200,000 pieces in stock—priced to move. Same as MK4027 except 1mS refresh. MK4015 4Kx1 RAM

BARE BOARDS

- S-100 Sound Board \$34.95
- 8080A CPU \$4.95
- 32K Static RAM (2114) \$4.95
- 8K EPROM (2708) \$4.95
- 2708/2716 EPROM \$24.95
- ACP P Proto Board \$22.95
- Vector 8800 Proto \$22.20
- Vector 8803 11 slot MB \$29.95
- ACP Extender with connector \$18.95
- 13 Slot Mother Board (WMC) \$32.95
- 9 Slot Mother Board (WMC) \$39.95
- 8 Slot Mother Bd (Expandable) \$29.95
- Floppy PCB (8" SHUGART) \$9.95
- SIO (AYS-8910) Sound Board \$34.95
- Apple Sound Board \$24.95

UV "EPROM" ERASER



Model UVs-11E \$79.95
Holds 4 EPROM's at a time.
Model S-52T \$325.00

STEPPER MOTOR

Operates by applying 12VDC in one direction and then reversing polarity (or square wave). Uses 12VDC. Clock Wise Rotation, Rated 3 RPM at 4 P.P.S. with a 5 degree stepping angle.

ACP PRICE \$495 ea. 10 for \$39.95

4K STATIC RAM

SELL-OFF \$10/\$9.40
Same as TM8404 but designed specifically for Z-80 based systems. This is a full-spec 4Kx1 RAM, 450ns. Order P/Ns 8104-4 while supply lasts.

16K Memory Expansion Kits for Apple/TRS-80

8 pcs 4116 16K \$12.95
200/250ns
Specify computer
CALL FOR VOLUME PRICING

Zilog Z8 CPU with TINY BASIC

Debug prog. \$49.95
Plus 6132 companion quasi-static RAM 29.95

"D" SUB CONNECTORS



Unreal price. DB37 male, DB25 female. Gold PC mount with mounting holes. Mfg. ACP. Specify 25 or 37 pins.
Bd37 \$2.50 DB25 \$1.95

Stepper Motor

USED IN DATA PRODUCTS PRINTER \$19.95 ea.

Astec RF Modulator for COLOR & B/W

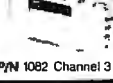

P/N 1082 Channel 3 or 4 \$6.95

CONNECTORS

DB25P (RS232) \$3.25
DB25S Female 3.75
Hood 7.50
Set with Hood, Sale 2214 S/T, KIM 2.85
43/8 S/T, MOT 6.50
50/100 S-100 Connector W/W 4.95
50/100 S-100 Connector S/T 3.95

PARALLEL ALPHA NUMERIC PRINTER

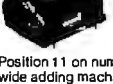

18 Column Printer prints 18 numerical columns plus 3 columns which have math, alpha and other notation. Each wheel has 12 positions with position 12 blank. Position 11 on numerical columns have decimal point or . Utilizes 2.75" wide adding machine tape and a dual color ink ribbon. Input data parallel with four bit BCD comparator circuit (schematic provided). Print rate, 3 lines per second. Operating voltage 22-28VDC with typical cycle time of 340ms. Size 6 1/2" W x 3 1/2" H x 5 1/2" Dp. New. \$9.95 ea. 3/527

MICROPROCESSORS

23001	\$88.00	6008-1	\$14.85	6002P	14.95
23002	88.00	2901	9.90	3036	14.85
23003	8.95	2801A	14.85	8036	9.95
23004	11.85	8001L	4.85	8073A	34.85
F-8 (2800)	16.85	8002	9.85	8746	40.85
8990	16.85	8002A	16.85	8748	40.85
10892	5.75	98100	28.85	8036	9.95
10895	4.75	9800	11.75	9090	40.85
10896	14.95	9800C	19.85	9090C	129.85

RAMS

6116/2016	\$7.95	2147	\$5.99	5290	\$1.99
8254-64K	8.95	411	5.99	5298	1.49
4116-2	1.80	414	4.69	6508	4.50
4116-2	8/12.85	1101	3.99	6518	6.79
2101	3.99	1103	3.99	6561	3.79
2102	7.79	4027	4.65	8904	3.99
2102-2	1.49	4044	3.99	6805	7.99
2102-4	1.29	4050	4.69	9130	8.99
2114	3.49	4060	4.69	9140	8.99
2112	1.49	4066	3.99	93416	6.99
2114	3.49	4115	1.49		
2114L-2	3.25	4200	7.95	93425	6.99
2114L-4	2.29	4202	3.99		
2125	6.99	5280	4.60		

SUPPORT

8155	\$9.95	825958.95	88047	\$22.95	
8156	9.95	8275	18.95	89486	18.95
8202	29.95	8279	9.50	22410N	6.50
8205	2.69	6810	4.75	6520	8.95
8212	2.75	6820	6.50	6522	9.95
8214	4.95	6821	6.50	6530-X	24.95
8216	2.75	6828	10.50	6532	17.95
8224	2.95	6834	16.95	6531	19.95
8226	2.95	6845	22.95	Z80-PIO	6.50
8228	3.95	6847	27.95	Z80A-PIO	9.50
8243	9.50	6850	5.25	Z80-CTC	6.50
8250	14.95	6852	5.25	Z80A-CTC	9.50
8251	6.50	6860	10.95	Z80-DMA	19.95
8253	11.95	6862	10.95	Z80A-DMA	27.95
8255	4.50	6865	5.25	Z80-SIO	24.95
8257	8.50	6880	2.49	Z80A-SIO	29.95

MS PROMS

2764 (8Kx8) TS	\$86.95	2708 (450ns)	\$5.75
2732 (16Kx8) TS	12.95	2702 (600ns)	5.25
2716/2516, SV		1702A	6.75
(2Kx8)TS	7.95	MM6203A0	14.50
TMS2716, SV, 12V	17.95	MM6204Q	9.95
2758, SV, (450ns)	3.50		

HI-TECH

2513-010 (500ppr)	\$9.50	DAC20	\$9.95
2513-004 (9V) Lower	19.95	DAC100	8.95
2513-ADM315V	14.95	8038 Function Generator	4.50
MCM66710ACSI (Shaded)	12.95	MC424 VCO	2.95
MCM66740MatnSymbol	13.95	LM566 VCO	1.95
MCM66750AlphaControl	13.45	XR2206 Function Generator	5.25
1771-01 8" x 8" Millimeter	24.95	TR6028 SV, 12V	9.95
1781 DualPeg	29.95	AT51013 (SV, 12V)	4.95
1791-01 Dual Floppy	26.95	AT51014 (1612 (5-1/4))	6.95
1791-02 Dual Floppy	44.95	AT51015 (1612 (5-1/4))	6.95
179300, DS Floppy	44.95	IM6402	7.95
179700, DS Floppy	44.95	IM6403	8.95
1991 Data Separator	18.95	2350 WSR	9.95
2143 Clock Generator	18.95	18718	24.95
87008 bit Snydy	13.50	MC14411	11.95
8701 10 bit Binary	22.00	4702	14.95
8703 8 bit TS	7.50	MC1941	9.95
9400 VME Freq Conv.	13.25	COM5016	16.95
975379 DIB CCD	13.95	IM58250	19.95
10413 Clock Generator	3.95	AT5-278	13.75
1408L 8 bit	3.95	AT5-3600	13.75
DAC01 016A	5.95	MM5740AC	8.95

SOCKETS

8 pin LP	.16	.15	.14
14 pin LP	.20	.19	.18
18 pin LP	.22	.21	.20
20 pin LP	.24	.23	.22
22 pin LP	.24	.23	.22
24 pin LP	.29	.27	.24
28 pin LP	.38	.37	.36
28 pin LP	.45	.44	.43
40 pin LP	.60	.60	.58

LOW PROFILE SOCKETS (TIN)

1-24	25-49	50-100	
8 pin WW	.55	.54	.49
10 pin WW (Tin)	.65	.63	.58
14 pin WW	.75	.73	.67
16 pin WW	.80	.77	.70
18 pin WW	.95	.90	.81
20 pin WW	1.15	1.08	.99
22 pin WW	1.45	1.35	1.23
24 pin WW	1.35	1.26	1.14
28 pin WW	1.60	1.53	1.38
40 pin WW	2.20	2.09	1.89

3L WIREWRAP SOCKETS (GOLD)

1-24	25-49	50-100	
8 pin CPU	2.95	5027 CRT	\$9.95
8080A CPU	2.95	11C24	6.95
2102 RAM	.75	95H03	2.89
4060 RAM	1.49	MM5320	5.99
8X300 CPU	14.95	9131 RAM	1.99
74S387	1.96	2708 EPROM	4.99
74S122	74S242	74S240	2.90
74S113	72	74S243	2.99
74S114	72	74S249	2.90

SUPER IC CLOSEOUT SPECIALS

ULN2003	2/51.99	2N6121	3/81.00
74LS668	3/11.99	51G 2652	3.95
74LS377	2/11.99	74S287	1.95
4060 RAM	1.49	95H03	2.89
8X300 CPU	14.95	MM5320	5.99
8259	6.95	74173/8710	5/19.99
6581 RAM	2.95	190A CPU	4.95
LM733C	3/11.99	6522	6.95
MC14411	3/11.99	6502 CPU	9.95
		8700A CPU	5.95
		2114	8/14.50
		8700A CPU	2/16.95

* CP/M trademark of Digital Research. Apple trademark of Apple Computer.

LINEAR

78H05K	\$5.95	LM1414N	\$1.90
78M05	1.49	LM1458CN/N	.49
78L05	1.49	LM1585N	.39
LM108AH	2.95	MC1489N	.99
LM300H	.99	LM1496N	.89
LM301CN	.35	LM1556N	1.50
LM304H	1.98	LM1820N	.95
LM305H	1.89	LM1850N	.95
LM305H	3.25	LM1858N	3.10
LM307CN	.29	LM2111N	1.75
LM308CN	.99	LM2900N	.99
LM309K	1.49	LM2910N	2.50
LM310CN	1.25	LM2917N	2.95
LM311D/CN	.89	CA3013T	2.19
LM312H	1.75	CA3016T	1.99
LM3137T	1.70	CA3021T	3.49
LM318CN	1.49	CA3023T	2.99
LM319N/H	1.25	CA3035T	2.75
LM320K-XX*	1.35	CA3039T	1.29
LM320T-XX*	1.39	CA3048N	1.29
LM320H-XX*	2.25	CA3053N	1.49
LM323K	4.95	CA3059N	3.19
LM324N	.95	CA3060N	3.19
LM327K	5.95	CA3062N	4.95
LM338K	6.95	LM3065N	1.49
LM339N	.95	CA3080T	1.29
LM340K-XX*	1.75	CA3081N	1.49
LM3410K-XX*	1.25	CA3082N	1.89
LM3440K-XX*	1.25	CA3083N	1.55
LM3444N	1.95	CA3086N	8.00
LM348N	1.20	CA3089N	2.99
LM359K	5.80	CA3098N	4.49
LM359CN	1.99	CA3097N	1.49
LM360N	1.49	CA3130T	1.30
LM372N	1.85	CA3140T	1.19
LM376N	3.75	CA3146N	2.49
LM377N	2.75	CA3160T	1.19
LM380CN/N	1.25	CA3190N	1.95
LM381N	1.79	CA3141N	.59
LM383T	1.95	MC3423N	.49
LM386N	1.25	MC3460N	3.95
LM387N	1.40	CG3524N	3.95
LM390N	1.95	CA3600N	3.39
NE531V/T	3.75	LM3900N	.59
NE555N	2.75	LM3903N	1.19
NE561T	19.95	LM3909N	.98
NE565N/H	1.25	LM3914N	3.75
NE568V/H	1.75	LM	

4164 64K DYNAMIC \$625
200 NS

TMM2016 2KX8 STATIC \$415
200 NS

ALL MERCHANDISE 100% GUARANTEED!

CALL US FOR VOLUME QUOTES

STATIC RAMS

2101	256 x 4 (450ns)	1.95
5101	256 x 4 (450ns) (cmos)	3.95
2102-1	1024 x 1 (450ns)	.89
2102L-4	1024 x 1 (450ns) (LP)	1.29
2102L-2	1024 x 1 (250ns) (LP)	1.69
2111	256 x 4 (450ns)	2.99
2112	256 x 4 (450ns)	2.99
2114	1024 x 4 (450ns)	8/14.95
2114L-4	1024 x 4 (450ns) (LP)	8/15.25
2114L-3	1024 x 4 (300ns) (LP)	8/15.45
2114L-2	1024 x 4 (200ns) (LP)	8/15.95
2147	4096 x 1 (55ns)	4.95
TMS4044-4	4096 x 1 (450ns)	3.49
TMS4044-3	4096 x 1 (300ns)	3.99
TMS4044-2	4096 x 1 (200ns)	4.49
MK4118	1024 x 8 (250ns)	9.95
TMM2016-200	2048 x 8 (200ns)	4.15
TMM2016-150	2048 x 8 (150ns)	4.95
TMM2016-100	2048 x 8 (100ns)	6.15
HM6116-4	2048 x 8 (200ns) (cmos)	4.95
HM6116-3	2048 x 8 (150ns) (cmos)	5.95
HM6116-2	2048 x 8 (120ns) (cmos)	8.95
HM6116LP-4	2048 x 8 (200ns) (cmos)(LP)	8.95
HM6116LP-3	2048 x 8 (150ns) (cmos)(LP)	8.95
HM6116LP-2	2048 x 8 (120ns) (cmos)(LP)	10.95
Z-6132	4096 x 8 (300ns) (Qstat)	34.95

LP = Low Power Qstat = Quasi-Static

DYNAMIC RAMS

TMS4027	4096 x 1 (250ns)	1.99
UPD411	4096 x 1 (300ns)	3.00
MMS280	4096 x 1 (300ns)	3.00
MK4108	8192 x 1 (200ns)	1.95
MMS298	8192 x 1 (250ns)	1.85
4116-300	16384 x 1 (300ns)	8/11.75
4116-250	16384 x 1 (250ns)	8/11.95
4116-200	16384 x 1 (200ns)	8/13.95
4116-150	16384 x 1 (150ns)	8/15.95
4116-120	16384 x 1 (120ns)	8/29.95
2118	16384 x 1 (150ns) (5v)	4.95
4164-200	65536 x 1 (200ns) (5v)	6.25
4164-150	65536 x 1 (150ns) (5v)	7.25

5V = single 5 volt supply

EPROMS

1702	256 x 8 (1us)	4.50
2708	1024 x 8 (450ns)	3.95
2758	1024 x 8 (450ns)(5v)	5.95
2716	2048 x 8 (450ns)(5v)	3.95
2716-1	2048 x 8 (350ns)(5v)	6.25
TMS2516	2048 x 8 (450ns)(5v)	5.50
TMS2716	2048 x 8 (450ns)	7.95
TMS2532	4096 x 8 (450ns)(5v)	7.95
2732	4096 x 8 (450ns)(5v)	4.95
2732-250	4096 x 8 (250ns)(5v)	12.95
2732-200	4096 x 8 (200ns)(5v)	16.95
2764	8192 x 8 (450ns)(5v)	16.95
2764-250	8192 x 8 (250ns)(5v)	18.95
2764-200	8192 x 8 (200ns)(5v)	24.95
TMS2564	8192 x 8 (450ns)(5v)	24.95
MC68764	8192 x 8 (450ns)(5v)(24 pin)	39.95

5v = Single 5 Volt Supply

EPROM ERASERS

	Timer	Capacity Chip	Intensity (uW/Cm ²)	
PE-14		6	5,200	83.00
PE-14T	X	6	5,200	119.00
PE-24T	X	9	6,700	175.00
PL-265T	X	20	6,700	255.00
PR-125T	X	16	15,000	349.00
PR-320	X	32	15,000	595.00

DISC CONTROLLERS

1771	16.95
1791	29.95
1793	39.95
1795	54.95
1797	54.95
6843	34.95
8272	39.95
UPD765	39.95
1691	18.95
2143	18.95

INTERFACE

8T26	1.69
8T28	2.49
8T95	.99
8T96	.99
8T97	.99
8T98	.99
DM8131	2.95
DP8304	2.29
DS8835	1.99
DS8836	.99

MISC.

3242	7.95
3341	4.95
NC3470	4.95
NC3480	9.00
11C90	13.95
95H90	7.95
2513-001 UP	9.95
2513-002 LOW	9.95

SOUND CHIPS

76477	3.95
76489	8.95
AY3-8910	12.95
MC3340	1.49

CRT CONTROLLERS

6845	14.95
6845	35.95
HD46505SP	15.95
6847	12.25
MC1372	6.95
68047	24.95
8275	29.95
7220	99.95
CRT5027	39.95
CRT5037	49.95
TMS9918A	39.95
DP8350	49.95

BIT-RATE GENERATORS

MC14411	11.95
BR1941	11.95
4702	12.95
COM5016	16.95
COM8116	10.95
MMS307	10.95

UARTS

AY3-1014	6.95
AY5-1013	3.95
AY3-1015	6.95
PT1472	9.95
TR1602	9.95
2350	9.95
2651	8.95
TMS8011	5.95
IM6402	7.95
IM6403	8.95
INS8250	14.95

KEYBOARD CHIPS

AY5-2376	11.95
AY5-3600	11.95

CLOCK CIRCUITS

MMS314	4.95
MMS389	3.95
MMS375	4.95
MMS8167	8.95
MMS8174	11.95
MMS6932	6.95

Z-80 2.5 Mhz

Z80-CPU	3.95
Z80-CTC	5.95
Z80-DART	15.25
Z80-DMA	17.50
Z80-PIO	5.75
Z80-SIO/0	18.50
Z80-SIO/1	18.50
Z80-SIO/2	18.50
Z80-SIO/9	18.95

4.0 Mhz

Z80A-CPU	6.00
Z80A-CTC	8.65
Z80A-DART	18.75
Z80A-DMA	27.50
Z80A-PIO	6.00
Z80A-SIO/0	22.50
Z80A-SIO/1	22.50
Z80A-SIO/2	22.50
Z80A-SIO/9	19.95

6.0 Mhz

Z80B-CPU	17.95
Z80B-CTC	16.50
Z80B-PIO	15.50

ZILOG

Z6132	34.95
Z6671	39.95

CRYSTALS

32.768 khz	1.95
1.0 mhz	4.95
1.8432	4.95
2.0	3.95
2.097152	3.95
2.4576	3.95
3.2768	3.95
3.579535	3.95
4.0	3.95
5.0	3.95
5.0688	3.95
5.185	3.95
5.7143	3.95
6.0	3.95
6.144	3.95
6.5536	3.95
8.0	3.95
10.730635	3.95
14.31818	3.95
15.0	3.95
18.0	3.95
17.430	3.95
18.0	3.95
18.432	3.95
20.0	3.95
22.1184	3.95
32.0	3.95

DATA ACQUISITION

ADC0800	15.66
ADC0804	3.49
ADC0809	4.49
ADC0817	9.95
DAC0800	4.95
DAC0806	1.95
DAC0808	2.85
DAC1020	8.25
DAC1022	5.95
MC1408L6	1.95
MC1408L8	2.95

8000

8035	5.95
8039	6.95
INS-8060	17.95
INS-8073	24.95
8080	3.95
8085	5.95
8085A-2	11.95
8086	29.95
8087	CALL
8088	39.95
8089	89.95
8155	7.95
8156	8.95
8145	29.95
8185-2	39.95
8741	39.95
8748	29.95
8755	32.00

8200

8202	29.95
8203	39.95
8205	3.50
8212	1.80
8214	3.85
8216	1.75
8224	2.25
8226	1.80
8228	3.49
8237	19.95
8238	4.49
8243	4.49
8250	10.95
8251	4.49
8253	6.95
8253-5	7.95
8255	4.49
8255-5	5.25
8257	3.75
8257-5	8.95
8259	6.90
8259-5	7.50
8271	39.95
8272	39.95
8275	29.95
8279	8.95
8279-5	10.00
8282	8.50
8283	6.50
8284	6.50
8286	5.50
8287	6.50
8288	25.00
8289	49.95

FUNCTION GENERATORS

MC4024	3.95
LMS86	1.49
XR2206	3.75
8038	3.95

INTERSIL

ICL7103	9.50
ICL7106	9.95
ICL7107	12.95
ICL7660	2.95
ICL8038	3.95
ICM7207A	5.59
ICM7208	15.95

6800

68000	59.95
6800	4.95
6802	7.95
6808	13.95
6809E	19.95
6809	12.95
6810	2.95
6820	4.95
6821	3.25
6828	14.95
6840	12.95
6843	34.95
6844	25.95
6845	14.95
6847	12.25
6850	3.45
6852	5.75
6860	9.95
6862	11.95
6875	6.95
6880	2.25
6883	24.95
68847	24.95
68488	19.95

6500 1 MHz

6502	5.95
6504	6.95
6505	8.95
6507	9.95
6520	4.35
6522	8.75
6532	11.25
6545	22.55
6551	11.85

2 MHz

6502A	9.95
6522A	11.75
6532A	12.45
6545A	28.55
6551A	12.95

3 MHz

6502B	14.95
-------	-------

EXAR

XR 2206	3.75
XR 2207	3.75
XR 2208	3.75
XR 2211	5.50
XR 2240	3.75

9000 SERIES

9316	1.15
9334	2.25
9368	3.00
9401	9.00
9601	3.00
9602	1.00
96S02	1.00



JDR MICRODEVICES, INC.

1224 S. Bascom Avenue
San Jose, CA 95128
800-538-5000 • 800-662-6279 (CA)
(408) 995-5430 • Telex 171-110

©1982 JDR MICRODEVICES, INC.

— NEW HOURS —
M-W-F, 9-5
T-Th., 9-9 Sat. 11-3
PLEASE USE YOUR CUSTOMER NUMBER WHEN ORDERING

TERMS: For shipping include \$2 for UPS Ground or \$3 for UPS Blue Label Air. Items over 5 pounds require additional shipping charges. Foreign orders, include sufficient amount for shipping. There is a \$1 minimum order. Bay Area and Los Angeles Counties add 6% Sales Tax. Other California residents add 6% Sales Tax. We reserve the right to substitute manufacturer. Not responsible for typographical errors. Prices are subject to change without notice. We will match any competitor's price provided it is not below our cost.

2716 16K EPROMS **\$3.95** EACH

ALL MERCHANDISE 100% GUARANTEED!

2732 32K EPROMS **\$4.95** EACH

CALL US FOR VOLUME QUOTES

74LS00

74LS00	.24	74LS86	.39	74LS169	1.75	74LS323	3.50
74LS01	.25	74LS90	.55	74LS170	1.49	74LS324	1.75
74LS02	.25	74LS91	.89	74LS173	.69	74LS352	1.29
74LS03	.25	74LS92	.55	74LS174	.55	74LS353	1.35
74LS04	.24	74LS93	.55	74LS175	.55	74LS363	1.29
74LS05	.25	74LS95	.75	74LS181	2.15	74LS364	1.95
74LS08	.28	74LS96	.89	74LS189	8.95	74LS365	.49
74LS09	.29	74LS107	.39	74LS190	.89	74LS366	.49
74LS10	.25	74LS109	.39	74LS191	.89	74LS367	.45
74LS11	.35	74LS112	.39	74LS192	.79	74LS368	.45
74LS12	.35	74LS113	.39	74LS193	.79	74LS373	.99
74LS13	.45	74LS114	.39	74LS194	.69	74LS374	.99
74LS14	.59	74LS122	.45	74LS195	.69	74LS377	1.39
74LS15	.35	74LS123	.79	74LS196	.79	74LS378	1.18
74LS20	.25	74LS124	2.90	74LS197	.79	74LS379	1.35
74LS21	.29	74LS125	.49	74LS221	.89	74LS385	1.90
74LS22	.25	74LS126	.49	74LS240	.95	74LS386	.45
74LS26	.29	74LS132	.59	74LS241	.99	74LS390	1.19
74LS27	.29	74LS133	.59	74LS242	.99	74LS393	1.19
74LS28	.35	74LS136	.39	74LS243	.99	74LS395	1.19
74LS30	.25	74LS137	.99	74LS244	.99	74LS399	1.49
74LS32	.29	74LS138	.55	74LS245	1.49	74LS424	2.95
74LS33	.55	74LS139	.55	74LS247	.75	74LS447	.37
74LS37	.35	74LS145	1.20	74LS248	.99	74LS490	1.95
74LS38	.35	74LS147	2.49	74LS249	.99	74LS624	3.99
74LS40	.25	74LS148	1.35	74LS251	.59	74LS668	1.69
74LS42	.49	74LS151	.55	74LS253	.59	74LS669	1.89
74LS47	.75	74LS153	.55	74LS257	.59	74LS670	1.49
74LS48	.75	74LS154	1.90	74LS258	.59	74LS674	9.65
74LS49	.75	74LS155	.69	74LS259	2.75	74LS682	3.20
74LS51	.25	74LS156	.69	74LS260	.59	74LS683	3.20
74LS54	.29	74LS157	.65	74LS266	.55	74LS684	3.20
74LS55	.29	74LS158	.59	74LS273	1.49	74LS685	3.20
74LS63	1.25	74LS160	.69	74LS275	3.35	74LS688	2.40
74LS73	.39	74LS161	.65	74LS279	.49	74LS689	3.20
74LS74	.35	74LS162	.69	74LS280	1.98	74LS783	24.95
74LS75	.39	74LS163	.65	74LS283	.69	81LS95	1.49
74LS76	.39	74LS164	.69	74LS290	.89	81LS96	1.49
74LS78	.49	74LS165	.95	74LS293	.89	81LS97	1.49
74LS83	.60	74LS166	1.95	74LS295	.99	81LS98	1.49
74LS85	.69	74LS168	1.75	74LS298	.89	25LS2521	2.80
				74LS299	1.75	25LS2569	4.25

IC SOCKETS

8 pin ST	1-99	.11
14 pin ST	.15	.12
16 pin ST	.17	.13
18 pin ST	.20	.18
20 pin ST	.29	.27
22 pin ST	.30	.27
24 pin ST	.30	.27
28 pin ST	.40	.32
40 pin ST	.49	.39
64 pin ST	4.25	call
ST = SOLDER TAIL		
8 pin WW	.59	.49
14 pin WW	.69	.52
16 pin WW	.69	.58
18 pin WW	.99	.90
20 pin WW	1.09	.98
22 pin WW	1.39	1.28
24 pin WW	1.49	1.35
28 pin WW	1.69	1.49
40 pin WW	1.99	1.80
WW = WIREWRAP		
16 pin ZIF	6.75	call
24 pin ZIF	9.95	call
28 pin ZIF	10.95	call
ZIF = TEXT TOOL (Zero Insertion Force)		

CONNECTORS

RS232 MALE	2.95
RS232 FEMALE	3.50
RS232 FEMALE	5.25
RIGHT ANGLE	1.25
RS232 HOOD	3.95
S-100 ST	3.95
8-100 WW	4.95

DIP SWITCHES

4 POSITION	.85
5 POSITION	.90
8 POSITION	.90
7 POSITION	.95
8 POSITION	.95

7400

7400	.19	74132	.45
7401	.19	74136	.50
7402	.19	74141	.65
7403	.19	74142	2.95
7404	.19	74143	2.95
7405	.25	74145	.60
7406	.29	74147	1.75
7407	.29	74148	1.20
7408	.24	74150	1.35
7409	.19	74151	.55
7410	.19	74152	.65
7411	.25	74153	.55
7412	.30	74154	1.25
7413	.35	74155	.75
7414	.49	74156	.65
7416	.25	74157	.55
7417	.25	74159	1.65
7420	.19	74160	.85
7421	.35	74161	.69
7422	.35	74162	.85
7423	.29	74163	.69
7425	.29	74164	.85
7426	.29	74165	.85
7427	.29	74166	1.00
7428	.45	74167	2.95
7430	.19	74170	1.65
7432	.29	74172	5.95
7433	.45	74173	.75
7437	.29	74174	.89
7438	.29	74175	.89
7440	.19	74176	.89
7442	.49	74177	.75
7443	.65	74178	1.15
7444	.69	74179	1.75
7445	.69	74180	.75
7446	.69	74181	2.25
7447	.69	74182	.75
7448	.69	74184	2.00
7450	.19	74185	2.00
7451	.23	74186	18.50
7453	.23	74190	1.15
7454	.23	74191	1.15
7460	.23	74192	.79
7470	.35	74193	.79
7472	.29	74194	.85
7473	.34	74195	.85
7474	.33	74196	.79
7475	.45	74197	.75
7476	.35	74198	1.35
7480	.59	74199	1.35
7481	1.10	74221	1.35
7482	.95	74246	1.35
7483	.50	74247	1.25
7485	.59	74248	1.85
7486	.35	74249	1.95
7489	2.15	74251	.75
7490	.35	74259	2.25
7491	.40	74265	1.35
7492	.50	74273	1.95
7493	.35	74276	1.25
7494	.65	74279	.75
7495	.55	74283	2.00
7496	.70	74284	3.75
7497	2.75	74285	3.75
74100	1.75	74290	.95
74107	.30	74293	.75
74109	.45	74298	.85
74110	.45	74351	2.25
74111	.55	74365	.65
74116	1.55	74366	.65
74120	1.20	74367	.65
74121	.29	74368	.65
74122	.45	74376	2.20
74123	.49	74390	1.75
74125	.45	74393	1.35
74126	.45	74425	3.15
74128	.55	74426	.85
		74490	2.55

CMOS

4000	.29	4527	1.95
4001	.25	4528	1.19
4002	.25	4531	.95
4006	.89	4532	1.95
4007	.29	4538	1.95
4008	.95	4539	1.95
4009	.39	4541	2.64
4010	.45	4543	1.19
4011	.25	4553	5.79
4012	.25	4555	.95
4013	.38	4556	.95
4014	.79	4581	1.95
4015	.39	4582	1.95
4016	.39	4584	.75
4017	.69	4585	.75
4018	.79	4702	12.95
4019	.39	74C00	.35
4020	.75	74C02	.35
4021	.79	74C04	.35
4022	.79	74C08	.35
4023	.29	74C10	.35
4024	.65	74C14	.59
4025	.29	74C20	.35
4026	1.65	74C30	.35
4027	.45	74C32	.39
4028	.69	74C42	1.29
4029	.79	74C48	1.99
4030	.39	74C73	.65
4034	1.95	74C74	.65
4035	.85	74C76	.80
4040	.75	74C83	1.95
4041	.75	74C85	1.95
4042	.69	74C86	.39
4043	.85	74C89	4.50
4044	.79	74C90	1.19
4046	.85	74C93	1.75
4047	.95	74C95	.99
4048	.35	74C107	.89
4050	.35	74C150	5.75
4051	.79	74C151	2.25
4053	.79	74C154	3.25
4060	.89	74C157	1.75
4066	.39	74C160	1.19
4068	.39	74C161	1.19
4069	.29	74C162	1.19
4070	.35	74C163	1.19
4071	.29	74C164	1.39
4072	.29	74C165	2.00
4073	.29	74C173	.79
4075	.29	74C174	1.19
4076	.79	74C175	1.19
4078	.29	74C192	1.49
4081	.29	74C193	1.49
4082	.29	74C195	1.39
4085	.95	74C200	5.75
4086	.95	74C221	1.75
4093	.49	74C373	2.45
4098	2.49	74C374	2.45
4099	1.95	74C901	3.95
14409	12.95	74C902	.85
14410	12.95	74C903	.85
14411	11.95	74C905	10.95
14412	12.95	74C906	.95
14419	7.95	74C907	1.00
14433	4.18	74C908	2.00
4502	.95	74C909	2.75
4503	.65	74C911	8.95
4508	1.95	74C912	8.95
4510	.85	74C914	1.95
4511	.85	74C915	1.19
4512	.85	74C918	2.75
4514	1.25	74C920	17.95
4515	1.79	74C921	15.95
4516	1.55	74C922	4.49
4518	.89	74C923	4.95
4519	.39	74C925	5.95
4520	.79	74C926	7.95
4522	1.25	74C928	7.95
4526	1.25	74C929	19.95

Prices Slashed!
74S00

74S00	.32	74S163	1.95
74S02	.35	74S168	3.95
74S03	.35	74S169	3.95
74S04	.35	74S174	.95
74S05	.35	74S175	.95
74S08	.35	74S181	3.95
74S09	.40	74S182	2.95
74S10	.35	74S188	1.95
74S11	.35	74S189	6.95
74S15	.35	74S194	1.49
74S20	.35	74S195	1.49
74S22	.35	74S196	1.49
74S30	.35	74S197	1.49
74S32	.40	74S201	6.95
74S37	.88	74S225	7.95
74S38	.85	74S240	2.20
74S40	.35	74S241	2.20
74S51	.35	74S244	2.20
74S64	.40	74S251	.95
74S65	.40	74S253	.85
74S74	.50	74S257	.95
74S85	1.99	74S258	.95
74S86	.50	74S260	.79
74S112	.50	74S274	19.95
74S113	.50	74S275	19.95
74S114	.55	74S280	

LINEAR

LM301	.34	LM348	.99	NE564	2.95	LM1496	.85
LM301H	.79	LM350K	4.95	LM565	.99	LM1558H	3.10
LM307	.45	LM350T	4.60	LM566	1.49	LM1800	2.37
LM308	.69	LM358	.69	LM567	.89	LM1812	8.25
LM308H	1.15	LM359	1.79	NE570	3.95	LM1830	3.50
LM309H	1.95	LM376	3.75	NE571	2.95	LM1871	5.49
LM309K	1.25	LM377	1.95	NE592	2.75	LM1872	5.49
LM310	1.75	LM378	2.50	LM703	.89	LM1877	3.25
LM311	.64	LM379	4.50	LM709	.59	LM1889	1.95
LM311H	.89	LM380	.89	LM710	.75	LM1896	1.75
LM312H	1.75	LM380N-8	1.10	LM711	.79	LM2877	2.05
LM317K	3.95	LM381	1.60	LM723	.49	LM2878	2.25
LM317T	1.19	LM382	1.60	LM723H	.55	LM2900	.85
LM318	1.49	LM383	1.95	LM733	.98	LM2901	1.00
LM318H	1.59	LM384	1.95	LM741	.35	LM3900	.59
LM319H	1.90	LM386	.89	LM741N-14	.35	LM3905	1.25
LM319	1.25	LM387	1.40	LM741H	.40	LM3909	.98
LM320 (see 7900)	LM389	1.35	LM747	.69	LM3911	2.25	
LM322	1.65	LM390	1.95	LM748	.59	LM3914	3.95
LM322K	4.95	LM392	.69	LM1014	1.19	LM3915	3.95
LM324	.59	LM394H	4.60	LM1303	1.95	LM3916	3.95
LM329	.65	LM399H	5.00	LM1310	1.49	MC4024	3.95
LM331	3.95	NE531	2.95	MC1330	1.69	MC4044	4.50
LM334	1.19	NE536	6.00	MC1349	1.89	RC4136	1.25
LM335	1.40	NE555	.34	MC1350	1.19	RC4151	3.95
LM336	1.75	NE556	.65	MC1358	1.69	LM4250	1.75
LM337K	3.95	NE558	1.50	MC1372	6.95	LM4500	3.25
LM337T	1.95	NE555	.34	LM1414	1.59	LM13080	1.29
LM338K	6.95	NE556	.65	LM1458	.59	LM13600	1.49
LM339	.99	NE558	1.50	LM1488	.69	LM13700	1.49
LM340 (see 7800)	NE561	24.95	LM1489	.69			

H = TO-5 CAN

T = TO-220

K = TO-3

RCA

CA 3023	2.75	CA 3082	1.65
CA 3039	1.29	CA 3083	1.55
CA 3046	1.25	CA 3086	.80
CA 3059	2.90	CA 3089	2.99
CA 3060	2.90	CA 3096	3.49
CA 3065	1.75	CA 3130	1.30
CA 3080	1.10	CA 3140	1.15
CA 3081	1.65	CA 3146	1.85
		CA 3160	1.19

TI

TL494	4.20	75365	1.95
TL496	1.65	75450	.59
TL497	3.25	75451	.39
75107	1.49	75452	.39
75110	1.95	75453	.39
75150	1.95	75454	.39
75154	1.95	75491	.79
75188	1.25	75492	.79
75189	1.25	75493	.89
		75494	.89

BI FET

TL071	.79	TL084	2.19
TL072	1.19	LF347	2.19
TL074	2.19	LF351	.60
TL081	.79	LF353	1.00
TL082	1.19	LF355	1.10
TL083	1.19	LF356	1.10
		LF357	1.40

VOLTAGE REGULATORS

7805T	.89	7905T	.99
7808T	.89	7908T	.99
7812T	.89	7912T	.99
7815T	.89	7915T	.99
7824T	.89	7924T	.99
7805K	1.39	7905K	1.49
7812K	1.39	7912K	1.49
7815K	1.39	7915K	1.49
7824K	1.39	7924K	1.49
78L05	.69	79L05	.79
78L12	.69	79L12	.79
78L15	.69	79L15	.79
78H05K	9.95	LM323K	4.95
78H12K	9.95	UA78540	1.85

T = TO-220 K = TO-3
L = TO-82

DISK DRIVES TANDON

TM100-1	5 1/4" (FOR IBM) SS/DD	229.00
TM100-2	5 1/4" (FOR IBM) DS/DD	295.00

SHUGART

SA 400L	5 1/4" (40 TRACK) SS/DD	199.95
---------	-------------------------	--------

SIEMENS

FD100-8	8" SS/DD (801 REPLACEMENT)	259.00
---------	----------------------------	--------

PERTEC

FD-200	5 1/4" SS/DD	179.95
FN-250	5 1/4" DS/DD	199.95

CABINET FOR 5 1/4" DISK DRIVE

- * COLOR MATCHES APPLE
 - * FITS SHUGART
- SPECIAL — \$29.95**

BYPASS CAPS

.01 UF DISC	100/6.00
.1 UF DISC	100/8.00
.1 UF MONOLITHIC	100/15.00

WE NOW STOCK A COMPLETE LINE OF DISC, ELECTROLYTIC, MONOLITHIC AND TANTALUM CAPACITORS

RESISTORS

1/4 WATT 5% CARBON FILM ALL STANDARD VALUES	
FROM 1 OHM TO 10 MEG OHM	
50 PCS. SAME VALUE	.025 EA.
100 PCS. SAME VALUE	.02 EA.
1000 PCS. SAME VALUE	.015 EA.

RIBBON CABLE

CONTACTS	SINGLE COLOR		COLOR CODED	
	1'	10'	1'	10'
10	.50	4.40	.83	7.30
20	.65	5.70	1.25	11.00
26	.75	6.80	1.32	11.60
34	.98	8.60	1.65	14.50
40	1.32	11.60	1.92	16.80
50	1.38	12.10	2.50	22.00

WE HAVE THE COMPLETE LINE OF IDC AND D-SUBMINIATURE CONNECTORS

WIREWRAP CARDS

FR-4 Epoxy Glass Laminate
With Gold Plated Contact Fingers

S-100 BUSS

P100-1	Bare — No Foil Pads	15.95
P100-2	Horizontal BUSS	22.95
P100-3	Vertical BUSS	22.95
P100-4	Single Foil Pads Per Hole	23.95

APPLE

P500-1	Bare — No Foil Pads	15.95
P500-3	Horizontal BUSS	22.95
P500-4	Single Foil Pads Per Hole	23.95

IBM

IBM-PR	BUSS Lines + Pads	55.00
--------	-------------------	-------

GENERAL PURPOSE

22/44 PIN (.156" SPACING)

P441-3	Vertical BUSS, 4.5" x 6"	13.95
P442-3	Vertical BUSS, 4.5" x 9"	14.95
36/72 PIN (.1" SPACING)		
P721-3	Vertical BUSS, 4.5" x 6"	13.95
P722-3	Vertical BUSS, 4.5" x 9"	14.95

BEST SELLING BOOKS

OSBORNE/MC GRAW-HILL

Apple II User's Guide	16.95
CRT Controller's Handbook	9.95
68000 Assembly Language Programming	16.99
CBASIC User Guide	15.00

SYBEX

Your Your First Computer	8.95
The CP/M Handbook	14.95
The PASCAL Handbook	18.95
Microprocessor Interfacing Techniques	17.95

MICROCOMPUTER HARDWARE HANDBOOK

FROM ELCOMP — \$14.95

Over 800 pages of manufacturers data sheets on most commonly used IC's.

Includes:

- * TTL — 74/74LS and 74F
- * CMOS
- * Voltage Regulators
- * Memory — RAM, ROM, EPROM
- * CPU's — 6800, 6500, Z80, 8080, 8085, 8086/8
- * MPU support & interface — 6800, 6500, Z80, 8200, etc.

JDR MICRODEVICES, INC.

1224 S. Bascom Avenue
San Jose, CA 95128

800-538-5000 • 800-662-6279 (CA)
(408) 995-5430 • Telex 171-110

© 1982 JDR MICRODEVICES, INC.

— NEW HOURS —
M-W-F, 9-5
T-Th., 9-9 Sat. 11-3

PLEASE USE YOUR CUSTOMER NUMBER WHEN ORDERING

TERMS: For shipping include \$2 for UPS Ground or \$3 for UPS Blue Label Air. Items over 5 pounds require additional shipping charges. Foreign orders include sufficient amount for shipping. There is a \$10 minimum order. Bay Area and Los Angeles Counties add 6% Sales Tax. Other California residents add 6% Sales Tax. We reserve the right to substitute manufacturer. Not responsible for typographical errors. Prices are subject to change without notice. We will match or beat any competitor's price provided it is not below our cost.

NEW VIEWMAX 80

A Full Function 80 column card for Apple II* — Compare these features with any other:

- ★ 7x9 dot matrix; Upper and lower case with true descenders
- ★ Soft Video switch
- ★ Inverse video characters
- ★ Shift key support
- ★ Fully compatible with Apple* DOS, CP/M*, PASCAL, and most popular word processors

★ 2 YEAR WARRANTY

\$219⁹⁵

JDR COOLING FAN FOR YOUR APPLE II

- ★ Easy installation — no modification of Apple required
- ★ Eliminates overheating problems
- ★ Switch on front controls fan, Apple, and extra outlet
- ★ Rotron whisper fan is the quietest, most reliable on the market

\$69⁹⁵

OKIDATA PRINTERS

- ★ 120 cps, 9x9 Dot Matrix
- ★ 50% faster than EPSON
- ★ Parallel and Serial interfaces are standard

ML-82A \$479⁵⁰

ML-83A \$699⁹⁵

ML-84 PARALLEL . . . \$1059⁰⁰

CALL FOR PRICES ON 82A TRACTOR OPTION AND 82A, 83A GRAPHICS OPTION. CABLES AND INTERFACE CARDS AVAILABLE

DISK DRIVE

- ★ Fully Apple* compatible
- ★ 35 Track — Will read half tracks!
- ★ Use with our controller (call for price) or with your Apple controller
- ★ Price includes case and cable — ready to plug in
- ★ Attractive cabinet matches Apple drive
- ★ 90-Day Warranty

\$299⁹⁵

JDR 16K RAMCARD

For Apple II*

- ★ Expand your 48K Apple to 64K
- ★ Fully compatible with Apple Language System — Use in place of Apple Language card
- ★ Provides extra memory for Visicalc™
- ★ Run PASCAL, FORTRAN, Integer Basic with appropriate software
- ★ Highest quality card features: gold edge connector, sockets for all IC's

NOW WITH 2 YEAR WARRANTY

ASSEMBLED & TESTED WITH WARRANTY **\$44⁹⁵**

KIT — INCLUDES ALL PARTS & INSTRUCTIONS . . . **\$40⁹⁵**

BARE PC CARD WITH INSTRUCTIONS **\$14⁹⁵**



ORDER TOLL FREE

800-538-5000

800-662-6279

(CALIFORNIA RESIDENTS)

IF YOU CAN FIND A PRICE LOWER ELSEWHERE, LET US KNOW AND WE'LL MEET OR BEAT THEIR PRICE! (SEE TERMS BELOW)

- ★ Computer managed inventory—virtually no back orders!
- ★ Very competitive prices!
- ★ Friendly staff!
- ★ Fast service — most orders shipped within 24 hours!

MONITORS

GREEN PHOSPHOR

NEC JB1201M \$169⁰⁰

ZENITH ZVM-121 \$119⁰⁰

COLOR

AMDEK COLOR 1 \$335⁰⁰

5 1/4" DISKETTES

ATHANA SS SD SOFT . . . 24.95

MEMOREX SS SD SOFT 26.95

VERBATIM SS DD SOFT 29.95

VERBATIM 10 SECT. HARD 29.95

NASHUA

TOP QUALITY — LOW PRICE

Single Sided, Single Density

Soft Sectors with Hub Ring

\$19.95 BOX OF 10

NEWPORT PROSTICK

- ★ Professional Quality Atari-Type Joystick
- ★ **Extremely Rugged** — Actual Arcade game Joystick
- ★ All parts are replaceable
- ★ **6 Month Warranty**

\$31⁰⁰ EA \$59⁹⁵ PR

POWER SUPPLY \$39⁹⁵

MOUNTED ON PC BOARD
MANUFACTURED BY CONVER

+5 VOLT 4 AMP
±12 VOLT 1 AMP

**SPECIAL THANKS TO
MARC AND AL FOR
THEIR HARD WORK
AND DEDICATION**



Palomar: first word in savings, final word for service!

Depend on Palomar for great backup:
(1) Expert technical advice. (2) Fast
response on orders. (3) In-house
service. (4) Guaranteed satisfaction.

Many items are not listed. Please call our 800 number if
you don't see what you're looking for.

FRANKLIN SPECIAL

Save 28%

Franklin Ace 1000* \$1,330.00
TEAC Super 5 Disk Drive
with Controller 495.00
Gemini 10 499.00
Genie Graphics Card .. 159.00

Taxan 12"
Green Screen 169.00
Diskettes 35.00
Diskette Case 5.00
\$2,692.00

*Add \$200 for Apple II/48K

NOW—\$1,945⁰⁰

PRINTERS

COMREX
Comriter CR-1CCALL
Tractor Feed89.00

EPSON
ASAP 2K Serial59.00
Comrex 4K Buffer139.00
Microbuffer-16K Parall139.00
Microbuffer-8K Serial139.00

NEC
3510 RO Serial1515.00
3520 KSR Serial2100.00
3530 RO Parallel1750.00
3550 RO IBM1880.00
7710 RO Serial2465.00
7730 RO Parallel2465.00
8023-A Dot Matrix549.00
Bi-Directional Tractor (3500)230.00
Cut Sheet Guide (3500)90.00
Envelope Handler (3500)270.00
Horizontal Tractor (7700)150.00
Bi-Directional Tractor (7700)345.00
Friction Attachment (7700)35.00

NOVELL
image 800999.00

OKIDATA
Microline 82-A519.00
Microline 83-A775.00
Microline 84-S1250.00
Microline 84-P1150.00
2K Parallel Interface129.00
Forms Tractor (82-A)55.00

OLYMPIA
ES 100 KRO999.00
ES 100799.00
Serial/Parallel Interfac250.00
CCS Apple Serial Card ..135.00

SMITH CORON
TP-1649.00

STAR :S
Gemini 10CALL
Gemini 15CALL

TEC
PMC 8510 Parallel475.00
ITOH 8510-A Parallel499.00
ITOH 8510-A Serial650.00
ITOH 1550 Parallel750.00
ITOH 1550 Serial789.00
ITOH F-10-401535.00
ITOH F-10-551875.00

MODEMS

HAYES
Micromodem II (Apple II)299.00
Micromodem II With Terminal
Program315.00
Micromodem 100 (S-100) ..349.00
Smartmodem (RS-232)225.00
Chronograph (RS-232)195.00
Terminal Program75.00

UDS
103 LP Direct175.00
103 JLP Auto /209.00
202 SLP 1200 I255.00
212 LP ..469.00

NOVATION
CAT (Acoustic)149.00
D-CAT165.00
Auto CAT215.00
212 Auto599.00
Apple CAT299.00
212 Apple615.00
Expansion35.00
Handset27.00
Firmware27.00

Order Toll-Free!

SUPPLIES

PRIN
Comrex18.00
NEC (Thin)14.95
.....30.00

VERBA
5 1/4" SSDD3.25
5 1/4" DSDD5.00
5 1/4" SSSD ..



APPLE

HARDWARE

Apple II Plus	CALL
ALS Z Card	219.00
ALS Z Card, with Supercalc	369.00
CCS IEEE Card	175.00
CCS Analog/Digital Card	105.00
CCS 12K ROM/PROM Module	109.00
CCS Programmable Timer	105.00
Comrex Clock Card	69.00
CPS Multitaction Card	179.00
Echo II Speech Synthesizer	175.00
EDP AC Surge Protector	49.00
EDP EMI-RFI Filter	39.00
Expansion II & Ports With Speaker	55.00
Hayes Micromodem II	299.00
Microbuffer II 16K	219.00
Microbuffer II 32K	245.00
Microsoft 260Softcard	265.00
Microtek 15K Ram Card	79.00
Microtek Parallel Printer Card	69.00
Microtek Graphics Card	109.00
Microtek Graphics Card-16K	165.00
Mountain Computer Romwriter	145.00
Mountain Computer Romwriter Plus (32K)	179.00
MPC Serial Printer Card	89.00
M & R Super Fan	40.00
Novation Apple Card	299.00
Novation Expansion Module	35.00
Novation Handset	150.00
Numeric Key Pad	150.00
Paymer Lower Case Adapters	29.00
Old Rev 1/4	19.00
New (Rev 7)	13.00
STB 64K Expansion Card	238.00
STB 128K Memory Card	399.00
System Save-Fan/Outlets/Switch	79.00
TG Game Paddles	29.00
TG Joy Sticks	45.00
TG Select-A-Port	45.00
Video 80 Column Card	279.00
Video Enhancer II (Rev 7)	125.00
Vindex Function Strip	65.00

DISK DRIVES

Corona 5MB Winchester	CALL
Corona 10MB Winchester	CALL
Disk II With Controller Card	CALL
Microsci ADS With Controller Card	375.00
Microsci Controller Card	99.00
Rana Disk Drive	359.00
Rana Controller	109.00
TEAC Super 5 Disc Drive	299.00
TEAC Super 5 Controller Card	89.00

SOFTWARE

BUSINESS	
d Base II	539.00
Five Home Accountant	55.00
Sensible Speller	99.00
PFS	99.00
PFS Report	89.00
PFS Graph	99.00
Super Calc	235.00
D & Master	179.00
D & Master Utility Pak #1	79.00
D & Master Utility Pak #2	79.00
VisiCalc	205.00
Desktop Plan II	249.00
VisiTrend/Plot	249.00
VisiTerm	85.00
VisiDraw	205.00
VisiFile	205.00
VisiSchedule	249.00
Letter Perfect	109.00
Data Perfect	75.00
Smartest 40-56/70	99.00

PERSONAL & HOME

Algebra I	29.00
Algebra II	29.00
CompuMath Arith Skm	39.00
CompuSpell (Reg Data Disk)	21.00
CompRead	21.00
S A T Word Attack Skit	39.00

SYSTEMS & UTILITIES

Apple Mechanic	21.00
DDS Bios	18.00
Utility City	21.00
S A M	99.00
Apple Soft Compiler	135.00
Basic Compiler	299.00
The Artist	59.00
Zoom Graphics	35.00

GAMES

Temple of Apschai	29.00
Dalesstones of Ryn	15.00
Morric's Tower	19.00
Rescue at Regal	21.00
Intro 3-Pak (Ryn, Moric, Rigel)	39.00
Dush, Cuzble and Chomp	21.00
Dragon's Eye	19.00
Chop Letter	25.00
Apple Panic	21.00
Arcade Machine	35.00
Star Blazer	25.00
Serpentine	25.00
Rasler Blaster	21.00
Deadline	35.00
Starcross	29.00
Zork I	29.00
Zork II	29.00
Zork III	29.00
Snack Attack	21.00
Pigs	15.00
Castle Wolfenstein	21.00
Robot Wars	29.00
Three Mile Island	29.00
Frogger	25.00
Canon Ball Blitz	25.00
Warg Destroyer	21.00
Audex	21.00
Autobahn	21.00
Samhly	25.00
Beer Run	21.00
Borg	21.00
Cops & Robbers	25.00



PERSONAL COMPUTERS

ALTOS		
ACS 8000-2	3199.00	
ACS 8000-15	4399.00	
APPLE		
Apple II Plus	CALL	
Disk II D.O.S. 3	CALL	
Disk II	CALL	
BASIS		
108-0003 (64K)	1895.00	
108-0004 (128K)	1995.00	
FRANKLIN		
ACE 1000 (64K)	CALL	
ACE 10, Disk Drive	CALL	
OSBORNE		
Osborne I Portable, Includes \$200 Extras	1795.00	
KAYCOMP		
Kaypro Portable, Includes \$250 Extras	1795.00	
TELEVIDEO		
TS 802	3119.00	
TS 806	5735.00	
TS 816	10365.00	

Palomar offers a complete selection of Apple Hardware and Software.

IBM

HARDWARE

IBM PC	CALL
Amdek Color II RGB Monitor	799.00
Amdek 3' Dual Disk Drive	785.00
Corona 5MB Winchester	CALL
Corona 10MB Winchester	CALL
M & R SuperMod/5	59.00
Percom Add On Disk Drive (Dual)	450.00
PMC Disk Drive	199.00
STB I/O Printer Interface (4 Ports)	225.00
STB 64K I/O Memory Card	479.00
Tandon TM 100-1 Disk Drive	219.00
Tandon TM 100-2 Disk Drive	299.00
TG Joysticks	49.00
Tech Adam & Eve Paddles	29.00
64K Kit (9 64K x 1 Chips)	119.00
64K RAM Card	199.00

SOFTWARE

BUSINESS	
d Base II	499.00
Denver Accounting System	549.00
Easy Filer	295.00
Easy Planner	145.00
Easy Writer II	259.00
VisiCalc	205.00
HOME & PERSONAL	
The Home Accountant +	109.00
Money Decisions	145.00
Mathmagic	65.00
Graphmagic	65.00
GAMES	
Temple of Apschai	29.00
Zork III	29.00
Galactic Attack	29.00

Palomar is pledged to your satisfaction.

S-100 HARDWARE

Tandon TM 100-1 Disk Drive	219.00
Tandon TM 100-2 Disk Drive	299.00
CCS Disk Controller/CPM 2.2	375.00
CCS 16K Static Ram Module	259.00
CCS 32K Static Ram Module	439.00
CCS 2 Serial Port + 2Parallel	315.00
Comrex Clock Card	119.00
Hayes Micromodem 100	349.00

CP/M SOFTWARE

CCS CP/M Control Program 2.2	129.00
CCS CP/M Macro Assembler	79.00
CCS CP/M Symb. Instr. Debug	65.00
CCS CP/M Text Formatter	65.00
Hayes Terminal Program (8")	22.00
Microsoft Fortran 80 (8")	385.00
Microsoft Basic Compiler (8")	299.00
Microsoft Basic 80 (8")	269.00



ACCESSORIES

CABLES CENTRONICS	
Centronics/Centronics	25.00
Centronics/Atari	30.00
Centronics/IBM	30.00
Centronics/Osborne	30.00
Centronics/S-100	30.00
Centronics/TRS I, III	30.00

RS-232	
4 Wire, M/M,M/F-10 FT	18.00
9 Wire, M/M,M/F-10 FT	20.00
12 Wire, M/M,M/F-10 FT	21.00
25 Wire, M/M,M/F-10 FT	25.00
MANY MORE CABLES AVAILABLE	CALL
OUR 800#:	

MONITORS

COMREX		
CR 5500-12" Green	155.00	
CR 6500-13" Composite	315.00	
CR 6600-13" RGB	429.00	
AMDEK		
Video 300-12" Green	165.00	
Color I -13" Color Composite	365.00	
Color II -Hi Res. RGB	799.00	
Color III -Lo Res. RGB	469.00	
RGB Apple II Card	165.00	
U.S.I.		
9" Green Screen	119.00	
9" Amber Screen	155.00	
12" Green Screen	155.00	
12" Amber Screen	175.00	
TAXAN		
KG 12N-12" Green	CALL	
KA 12N-12" Amber	CALL	
RGB Vision I-12" RGB	CALL	
RGB Vision II-12" RGB	CALL	

Palomar makes buying easy ...  

ORDER TOLL-FREE! Call
800-237-3333
 In California call 800-338-5555

Telex 697120-150

TERMS OF SALE: Cash, Check, money order, bank wire transfer, credit card, or purchase orders from qualified firms and institutions. Please include telephone number with order and expiration date on credit card orders. California residents add 6% sales tax. Advertised prices are for prepaid orders F.O.B. shipping point. Add 3% or \$3.00 minimum for shipping in the U.S. Pricing and availability subject to change without notice. Address written orders to:

910-105 W. San Marcos Blvd., Dept. B-2, San Marcos, CA 92069

PALOMAR

COMPUTER PRODUCTS

THERE ARE NO BETTER BOARDS — THERE ARE NO BETTER PRICES!

CompuPro FROM PRIORITY ONE ELECTRONICS

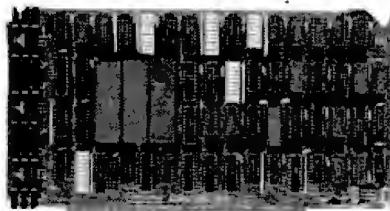

**CPU BOARDS
CO-PROCESSOR 8086/8087**

16 bit 8 or 10 MHz 8086 CPU with sockets for 8087 and 80130

Part No.	Description	List Price	Our Price
BNGBT186A	A&T 8MHz 8086 only	\$695.00	\$624.89
BNGBT186C	CSC 10MHz 8086 only	\$850.00	\$764.89
BNGBT186A87	A&T with 8087 option	\$995.00	\$925.00
BNGBT186C87	CSC with 8087 option*	\$1150.00	\$1065.00

(816) DUAL PROCESSOR 8085-8088

6 or 8 MHz provides true 16 Bit Power with a standard 8 bit S-100 bus

BNGBT1612A	A&T 6MHz	\$425.00	\$398.89
BNGBT1612C	CSC 6/8 MHz	\$525.00	\$497.89

68K - 68000 16 BIT CPU

16 bit 8 or 10 MHz on-board sockets for 2716, 2732, or 2764 EPROMs for up to 8K x 16 of memory

BNGBT184A	A&T 8MHz	\$695.00	\$625.00
BNGBT184C	CSC 10MHz	\$850.00	\$765.00

FORTH OPERATING SYSTEM FOR 68K CPU

Requires a Disk 1, 64K of CompuPro memory, and an INTERFACER 1 or 4.

BNGBT68K0S	FORTH operating system		\$200.00
------------	------------------------	--	-----------------

CPUZ - Z80D CPU NOW 6MHz!

3/6 MHz Z80D CPU with 24 Bit Addressing. FASTEST Z80 CPU AVAILABLE!

BNGBT160A	3/6 MHz A&T	\$295.00	\$279.89
BNGBT160C	3/6 MHz CSC	\$395.00	\$374.89



*When 2 or more 8" disk drives are purchased with Disk 1 Controller.

DISK CONTROLLERS

DISK 1 FLOPPY CONTROLLER - OUR BEST!
Fast DMA, Soft Sector, Controls Up To Four 8" or 5 1/4" Single or Double Density Drives.

BNPDB171ACPM	A&T w/CPM 2.2 & BIOS	\$670.00	\$495.00
		*When purchased with two 8" disk drives only.	\$450.00
BNPDB171CCPM	CSC w/CPM 2.2 & BIOS	\$770.00	\$595.00
BNGBT171A	Disk 1 Controller A & T	\$495.00	\$449.89
BNGBT171C	Disk 1 Controller CSC	\$595.00	\$550.00
BNGBTCPM80	CP/M 2.2 for Z80/8085 w/manual & BIOS 8" S/D disk.	\$174.89	
BNGBTCPM85	CP/M 2.2 for 8086 w/manuals & BIOS 8" S/D disk.	\$299.89	

**DISK 2/SELECTOR CHANNEL
HARD DISK CONTROLLER**

Fast DMA 2 board set, controls 4 Shugart 4000 series or Fujitsu 2310 type drives. Includes CP/M 2.2.

BNGBT177A	Assembled & Tested	\$795.00	\$750.00
BNGBT177C	CSC	\$895.00	\$850.00

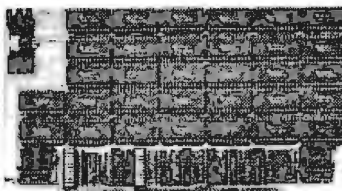

CMOS RAM SALE!

RAM 17 - 64K CMOS STATIC RAM

12 MHz. RAM 17.2 Watt. DMA Compatible 24 Bit Addressing

Part No.	Description	List Price	Our Price
BNGBT17A	64K A&T 10MHz		\$319.00
BNGBT175A64	64K A&T 12MHz	\$599.00	\$549.89
BNGBT175C64	64K CSC 12MHz	\$699.00	\$650.00

RAM 16 - 32K x 16 BIT CMOS STATIC RAM

8 and/or 16 Bit
(816) 12 MHz. RAM 16, 32K x 16 or 64K x 8 IEEE/696 16 Bit 2 Wait, 24 Bit Addressing

BNGBT16A	64K A&T 10MHz		\$349.00
BNGBT160A	64K A&T 12MHz	\$650.00	\$598.89
BNGBT160C	64K CSC 12MHz	\$750.00	\$698.89

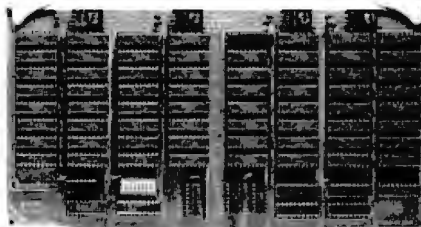

NEW! RAM 21 - 128K STATIC RAM

(816) RAM 21 12MHz, 128K x 8 or 64K x 16 IEEE/696 8 or 16 bit, 1.2 Amps, 24 Bit Addressing

BNGBT190A	128K A&T	\$1350.00	\$1225.00
BNGBT190C	128K CSC	\$1450.00	\$1375.00

**M-DRIVE SOLID STATE DISK DRIVE,
3500% FASTER!!**

Not really, but the next best thing for CompuPro 8085/88 Users. Call for Details on M-Drive. M-Drive requires a 6MHz CPU 8085/88 dual processor, Disk 1 DMA disk controller and System Support 1 Multifunction Board.

BNGBTMD128KA	128K of A&T memory & M-Drive Software	\$1100.00
BNGBTMD128KC	128K of CSC memory & M-Drive Software	\$1300.00
BNGBTMD256KA	256K of A&T memory & M-Drive Software	\$2395.00
BNGBTMD256KC	256K of CSC memory & M-Drive Software	\$2785.00

M-DRIVE/H HARDWARE LOGICAL DISK SYSTEM

Interlaces through two I/O ports, and runs at 10MHz. IEEE 696 compatible. Requires any CompuPro CPU and a Disk 1. Each board contains 512K of fast, low power (900mA) RAM, with parity checking.

BNGBT197A	M-DRIVE/H w/software, A&T	\$1895.00	\$1775.00
BNGBT197C	M-DRIVE/H w/software, CSC	\$2095.00	\$1950.00

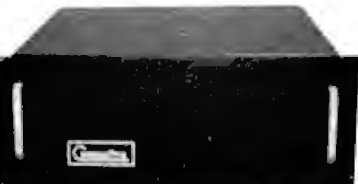

S-100 MAINFRAME

110V 60Hz CVT Mainframe uses famous 20 slot CompuPro Motherboard (55 lbs.)

BNGBTENC20RM	20 Slot Rackmount	\$895.00	\$825.00
BNGBTENC200K	20 Slot Desk Top	\$825.00	\$760.00

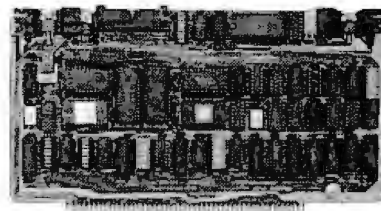

I/O BOARDS

SYSTEM SUPPORT 1 MULTIFUNCTION BOARD

Serial port (software prog. baud), 4K EPROM or RAM provision, 15 levels of interrupt, real time clock, optional math processor

Part No.	Description	List Price	Our Price
BNGBT162A	Assembled & Tested	\$395.00	\$359.89
BNGBT162C	CSC	\$495.00	\$459.89
BNGBT6231	Math Chip		\$195.00
BNGBT8232	Math Chip		\$195.00
BNGBT162AM1	A&T w/8231 Math Chip		\$490.00
BNGBT162CM1	CSC w/8231 Math Chip		\$654.89
BNGBT162AM2	A&T w/8232 Math Chip		\$490.00
BNGBT162CM2	CSC w/8232 Math Chip		\$654.89

MPX CHANNEL BOARD

I/O Multiplexer, using 8085A-2 CPU on board w/4K RAM

BNGBT166A4	Assembled & Tested	\$495.00	\$444.89
BNGBT166C4	CSC	\$595.00	\$534.89

With 16K RAM

BNGBT166A16	Assembled & Tested	\$649.00	\$584.89
BNGBT166C16	CSC	\$749.00	\$674.89

INTERFACER 1

Two Serial I/O

BNGBT133A	Assembled & Tested	\$249.00	\$218.89
BNGBT133C	CSC	\$324.00	\$288.89

INTERFACER 2

Three parallel, one serial I/O board

BNGBT150A	Assembled & Tested	\$249.00	\$218.89
BNGBT150C	CSC	\$324.00	\$289.89

INTERFACER 3

Eight-channel multi-user serial I/O board

BNGBT1748A	Assembled & Tested	\$699.00	\$628.89
BNGBT1748C	CSC 200 hr. 8 port	\$849.00	\$748.89
BNGBT1745A	Assembled & Tested	\$599.00	\$558.89
BNGBT1745C	CSC 200 hr. 5 port	\$699.00	\$628.89



INTERFACER 4

Three Serial, 1 Parallel, 1 Centronics Parallel

BNGBT187A	Assembled & Tested	\$395.00	\$314.89
BNGBT187C	CSC	\$495.00	\$414.89

SPECTRUM COLOR GRAPHICS

Color Graphics board with Parallel I/O

BNGBT144A	Assembled & Tested	\$299.00	\$285.00
BNGBT144C	CSC	\$395.00	\$375.00

S-100 MOTHERBOARDS

Active termination, 6-12-20 Slot

BNGBT153A	A&T 6 slot, 2 lbs.	\$140.00	\$125.00
BNGBT153C	CSC 6 slot, 2 lbs.	\$190.00	\$155.00
BNGBT154A	A&T 12 slot, 3 lbs.	\$175.00	\$155.00
BNGBT154C	CSC 12 slot, 3 lbs.	\$240.00	\$220.00
BNGBT155A	A&T 20 slot, 4 lbs.	\$265.00	\$235.00
BNGBT155C	CSC 20 slot, 4 lbs.	\$340.00	\$310.00

PRIORITY ONE ELECTRONICS

CompuPro 10 MHz 64KBytes S-100 STATIC RAM - ULTRA LOW POWER - ONLY 2 WATTS ASSEMBLED & TESTED - ONE YEAR WARRANTY **\$299***

UNBELIEVABLE! While the rest of the industry struggles to attain 6MHz, CompuPro has effortlessly jumped from 10 to 12MHz. The power consumption (400mA; 2 Watts) is still the lowest in spite of running nearly twice as fast. Priority One Electronics has purchased the remainder of CompuPro's 10MHz boards and are offering them at these unprecedented prices.

- Extremely low power consumption (2 watts typical)
- Flawlessly handles any DMA device per IEEE 696 specifications
- Single +5 Volt operation (requires no other supply voltages)
- Switch-Selectable choice of 24 address lines conforming to IEEE 696/S-100 extended addressing
- 2K windows, individually selectable at E000, E800, F000, and F800 permits use with older memory-mapped disk controllers or ROM (i.e. Morrow, NorthStar)
- Any 16K block may be disabled; dip switch selectable 2K disable from XE000 - FFFF in 2K increments
- Switch Selectable PHANTOM disable



RAM 17
SALE PRICE: **\$319.00 ea.**
List Price: \$599.00
*2 or More: **\$299.00 ea.**
BNGBTRAM17 Assembled & Tested

- Board addressable as one 64 K x 8 or 32 K x 16 block. DIP switch selectable on any 64K boundary
- Extremely low power consumption (2 watts typical)
- Meets or exceeds all IEEE 696/S-100 specifications
- Flawlessly handles any DMA device per IEEE 696 specifications
- Single +5 Volt operation (requires no other supply voltages)
- 24 bit addressing; conforms to IEEE 696 specifications
- 8 or 16 bit data transfer dependant on SXTRQ. Conforms with IEEE 696 timing requirements for XTRQ and SIXTN

RAM 16



RAM 16
SALE PRICE: **\$349.00 ea.**
List Price: \$650.00
2 or More: **\$325.00 ea.**
BNGBTRAM16 Assembled & Tested

CompuPro™

NEW 16 BIT 12 USER SYSTEM 816/D



SAVE OVER \$4000.00 ON SYSTEM & TERMINAL!

The System 816/D is a high performance, multi-user, multi-tasking 16-bit system, with the power needed for involved applications such as software development. This is the preferred system for business, industrial or scientific environments. In addition, the 816/D delivers spooling (simultaneous printing and editing) to further increase productivity.

- 10MHz 16 bit 8086 CPU with 80130 operating system firmware component
- 512K bytes of low power RAM
- 1 megabyte of M-DRIVE/H high speed solid state logical disk system
- Fast DMA floppy controller with 2 double sided 8" disk drives; 2.4 megabytes of storage
- 20 slot desk top S-100 enclosure
- 12 serial interlaces
- 1 parallel, 1 Centronics parallel interface

Software: CP/M-86, MP/M-86, SuperCalc
Convenience features: clock/calendar, interrupt controllers; interval timers, and co-processor and Operating System Firmware option. This System 816/D is priced at \$13,995.00, a savings of over \$3,000 if all of the components were purchased separately.

Part No.	Description	Price
BNGBTYS81600A	Multiuser 16 bit desk top system A&T	\$13,995.00
BNGBTYS81600C	Multiuser 16 bit desk top system CSC	\$15,995.00
BNGBTYS81600A21	Same as above with RAM 21s, A&T	\$14,395.00
BNGBTYS81600C21	Same as above with RAM 21s, CSC	\$16,395.00

OASIS 16 SYSTEM 816/016

All the hardware mentioned with the System 816/D with the DASIS 16 Operating System and utilities instead of CP/M-86, MP/M-86, and SuperCalc.

BNGBTYS81600A	Multiuser 16 bit desk top system A&T	\$13,995.00
BNGBTYS81600C	Multiuser 16 bit desk top system CSC	\$15,995.00
BNGBTYS81600A21	Same as above with RAM 21s, A&T	\$14,395.00
BNGBTYS81600C21	Same as above with RAM 21s, CSC	\$16,395.00

VISUAL 330 \$1.00!!

With the purchase of any CompuPro System D

AN ADDITIONAL SAVINGS VALUE OF: **\$1049.00**

VSL330GN Specifications in column at right

VISUAL 330 AND 300

SORRY TELEVIDEO,



THIS IS THE NEW STANDARD

The microprocessor-based VISUAL 330 combines VISUAL ergonomic elegance with selectable emulations of the DEC VT52*, Data General 0200, Lear Siegler ADM-3A, and Hazeltel 1500 terminals.

Specifications	VISUAL 330	VISUAL 300	TeleVideo 950
ANSI X3.64 Specified	NO	STD	NO
Solid State Keyboard	STD	STD	NO
Programmable Non-volatile Function Keys	STD	STD	NO
Video Attributes Require No Display Space	STD	STD	NO
Smooth Scroll, Slow Scroll and Jump Scroll	STD	STD	NO
Non Volatile Set-up Modes, "Menu" Style	STD	STD	NO
Block Graphics	STD	STD	NO
Sculptured Keycaps, Matted for Low Glare	STD	STD	NO
Programmable Non Volatile Columnar Tabbing	STD	STD	NO
Choice of Typomatic/Non-Typomatic Keyboard	STD	STD	NO
14" Screen	OPT	OPT	NO
N-Key Rollover	STD	STD	NO
CR New Line Mode	STD	STD	NO
Tilt and Swivel CRT	STD	STD	NO
User Programmable Non-Volatile Answerback, 32 Codes	STD	STD	NO
Screen Brightness Control from Keyboard	STD	STD	NO
XDN/XOFF Flow Control, Split for Xmitter and Receiver	STD	STD	NO

List Price Our Price 2 or More

BNVSL330GN	Green Screen 12"	\$1200.00	\$1050.00	\$ 995.00
BNVSL33014GN	Green Screen 14"	\$1250.00	\$1095.00	\$1050.00

The VSL300 contains all of the same specifications as the 330 but with no multi-emulation capabilities. The VSL300 is ANSI X3.64 compatible

BNVSL300GN	Green Screen 12"	\$1200.00	\$1050.00	\$ 995.00
BNVSL30014GN	Green Screen 14"	\$1250.00	\$1095.00	\$1050.00

LOW COST DAISYWRITER 2000 WITH 40 CPS EFFECTIVE SPEED AND 48K BUFFER!

ONLY \$1495.00!!



The SLMDW2000 may just be the best dollar value in a letter quality printer on the market today. Features include:

- Effective printing speed raised from 16cps to 40cps by the intelligent interface
- 48K buffer memory
- Daisyplot Graphics
- Printwheel cassettes available in 12 styles and 15 languages
- Standard IBM ribbon cartridges
- MTBF of 4000 hours at 25% duty cycle

This printer is DIP switch selectable for its personality protocols. This eliminates the need to replace a printer when the computer system is expanded, modified or adding additional printers that must be compatible with existing hardware and software. Included among the protocols that can be emulated are:

- NEC 5510 • DIABLO 630 • QUME Sprint 9
- IBM Personal Computer • ATARI (Centronics 737)

INTERFACES:
• RS232C and Current Loop • Centronics type parallel interface
• IEEE/488 All are DIP switch selectable

SPECIAL FEATURES:
• 280 CPU • 12K ROM • Standard 48K Buffer • 16 Software or hardware selectable baud rates 50 - 19.2K baud • Micro-coded alarm differentiates error conditions with pulse combinations • Intelligent bidirectional printing with logic seeking • Complete word processing features, standard • Complete self test • Auto reprint up to 255 times
• Auto clear error - printer automatically resumes printing upon correction of ribbon, paper or cover open conditions • Proportional spacing • Supports Automatic justification • Complete Vector plotting routines • Sheet feeder mode - allows easy interface to most mechanical sheet feeders • Quiet - 60db • Front panel forms control • Universal power supply 115/220V 50/60Hz

Part No.	Description	List Price	Our Price
BNSLMDW2000	Printer with 48K buffer	\$1595.00	\$1495.00
BNSLMDWVFT	Vertical Form Tfactor		\$ 125.00

Pre-configured cables are available. Please call for price and part number.

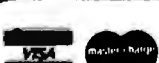

PRIORITY ONE ELECTRONICS

9161 DEERING AVE • CHATSWORTH, CA 91311

ORDER TOLL FREE (800) 423-5922 - CA, AK, HI CALL (213) 709-5111

Terms. U.S. VISA M.C. BAC. Check Money Order, U.S. Funds Only. CA residents add 6 1/2% Sale Tax. MINIMUM PREPAID ORDER \$15.00. Include MINIMUM SHIPPING & HANDLING OF \$3.00 for the first 3 lbs, plus 40¢ for each additional pound. Orders over 50 lbs. sent freight collect. Just in case, please include your phone number. Prices subject to change without notice. We will do our best to maintain prices through February, 1983. Credit Card orders will be charged appropriate freight. If you haven't received your Winter '83 Engineering Selection Guide, send \$1.00 for your copy today! Sale prices for prepaid orders only.



*International
Instrumentation
Incorporated*

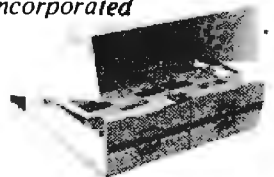

- Positive Pressure Filter Cooling
- Power Supply 4A@+5V, 3A@+24V 1A@-5V
- Each output is individually fused
- Hinged top for easy access
- Heavy non-flex .090 aluminum base
- Modular power connectors

BUY DRIVES AND CABINET TOGETHER AND SAVE!!

DUAL 8" SIEMENS FDD1008, DUAL 8" CABINET POWER SUPPLY AND INTERNAL POWER CABLES
IF BOUGHT SEPARATELY: \$910.00

PRICED AT: \$750.00

BNPDBIISIE

ENVIRONMENT MONITOR PANEL

Temperature and voltage monitor with visual and audible alarm for overtemp condition. Direct Digital Readout of Internal temperature in °C on standard DVM

- BNHIFDE002 CABINET ONLY (Sh. Wt. 38 lbs.) \$295.00
- BNPDBIISIEEM 2-Drives, Cabinet & disk environment monitor \$775.00
- BNHIFDE002EM Cabinet only with disk environment monitor \$375.00
- BNPGCS0M18E18E Dual Internal Data Cable \$31.15
- BNPGCS0S60S External Data Cable \$19.77

**SIEMENS FDD100-8
8" FLOPPY DISK DRIVE
SINGLE SIDED, DOUBLE DENSITY
SHUGART 801R COMPATIBLE**

90 DAY WARRANTY!

ONCE AGAIN YOU RECEIVE THE BENEFIT OF OUR UNEQUALLED PURCHASING POWER!



1 \$265.00
2-9 \$249.00
10+ \$225.00

DEM INQUIRIES INVITED
(Include \$7.00 per drive for shipping)

BNSIEFDD1008

ORDER NOW AND SAVE!

S-100 DUAL 8" SUBSYSTEM

- | | | | |
|--------------|--|---|------------------|
| BNGCS2422A | S-100 Disk Controller with CP/M 2.2 | 1 | \$399.00 |
| BNSIEF001008 | Siemens Double Density 8" drive | 2 | \$498.00 |
| BNHIFDE002 | Dual Horizontal Cabinet with Power Supply and Data Cable | 1 | \$295.00 |
| | | | \$ 35.00 |
| | | | \$1227.00 |



SAVE \$232.00!!

\$995.00
(include \$30.00 for shipping)

DON'T MISS OUT!

Order No. **BNPDBSIESUB1**

OUR BEST DRIVES WITH THE BEST CABINET!!

MITSUBISHI ELECTRIC



**Better Than QUME!
Better Than SHUGART!**

8" Double-sided, double-density, interchangeable with QUME & Shugart
BNMFTM289483 Shipping Weight 16 lbs. \$450.00
BNMFTM289483M Manual \$ 10.00
2 or More: \$435.00 each



INTERNATIONAL INSTRUMENTATION, INC.

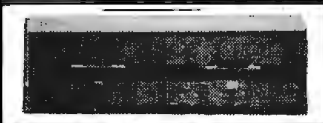

DUAL 8" FLOPPY DRIVE CABINET

- Positive Pressure Filter Cooling
- Power Supply 4A@+5V, 3A@+24V 1A@-5V
- Each output is individually fused
- Hinged top for easy access
- Heavy non-flex .090 aluminum base
- Modular power connectors

TWO MITSUBISHI 8" DRIVES DOUBLE SIDED DOUBLE DENSITY AND CABINET TOGETHER!!!

\$1150.00

BNPDBMIFDE
BNPDBMIFDEEM* Same as above with disk environment monitor \$1230.00
DRIVES AND CABINET SHIPPED SEPARATELY

Tandon



8-INCH THIN LINE

Exactly one-half the height of any other model proprietary, high-resolution, read-write heads patented by Tandon
D.C. only operation - no A.C. required
Industry standard interface

Three millisecond track-to-track access time (9 lbs.)

BNTNDTM8481 Single Sided: \$380.00 2 or more: \$370.00 ea.

BNTNDTM8482 Double Sided: \$495.00 2 or more: \$485.00 ea.

TANDON 5 1/4" DRIVES

BNTNDTM1001 Single Sided, 250KB (5 lbs.) \$220.00 ea.

2 or More: \$200.00 each

BNTNDTM1002 Double Sided, 500KB \$295.00 ea.

2 or More: \$270.00 each

BNTNDTM1003 Single Sided, 500KB \$295.00 ea.

2 or More: \$270.00 each

BNTNDTM1004 Double Sided, 1000KB \$395.00 ea.

2 or More: \$375.00 each

DUAL THIN LINE CABINET by JMR

- Fan cooled
- 24V @ 4 A/5A
- 5V @ 2A
- Scratch resistant.

Baked Enamel Finish

List Price Our Price

BNJMRTL C Cabinet & Power Supply \$200.00 \$180.00
(Shipping Weight 12 lbs.)

BUY THE CABINET AND DRIVES TOGETHER:

BNPDBJMRATN01 w/two TNDTM8481s (30 lbs.) \$920.00

BNPDBJMRATN02 w/two TNDTM8482s (30 lbs.) \$1150.00
Includes Power Cables

5 1/4" DISK DRIVE CABINETS

BNJMRT1 C5 JMR Single 5 1/4" Drive Cabinet \$ 79.00

(5V @ 1A, 12V @ 1.5A) Sh. Wt. 5 lbs.

BNVIS9802 Vista Dual 5 1/4" Drive Cabinet \$110.00

(+5V @ 2A, 12V@3A) Sh. Wt. 9 lbs.

VISUAL 50

- Low profile detached keyboard features sculptured keys with matte finish
- Screen tilts and swivels
- 80 x 24 display with 25th status line
- 7 x 9 dot matrix with full decoders
- RS-232 Serial interface w/auxiliary RS-232 port
- 128 Character ASCII set and 31 character line drawing set



INTRODUCTORY OFFER!!

BNVLS05BW Non-glare Black & White List: \$695.00 Our Price: \$650.00
BNVLS06N P31 greensdisplay List: \$750.00 Our Price: \$685.00
(Shipping Weight 37 lbs.)



NEW LOW PRICES!

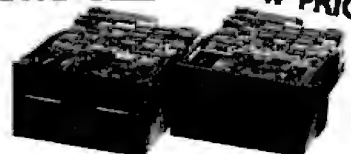

5 1/4" DISK DRIVES

BNMPI151* Single-Sided Double-Density 48 TPI \$200.00

BNMPI152* Double-Sided Double-Density 48 TPI \$270.00

BNMPI191* Single-Sided Double-Density 96 TPI \$275.00

BNMPI192* Double-Sided Double-Density 96 TPI \$400.00

Replace "" when order, with "m" for MPI style bezel, or "s" for Shugart style bezel. (Shipping weight: 5 lbs.)

2" HIGH 8" DISK DRIVES

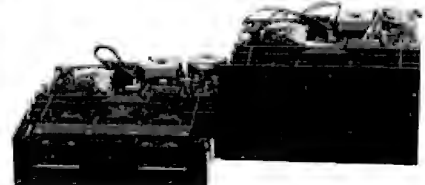

The first 2" high 8" disk drive allows for mounting under the keyboard on CRT, etc.

NO AC Required +5V +24VDC only
FAST 3 msec track to track!

BNMPI41M 1/2 High 1 side double-density \$380.00

BNMPI42M 1/2 High 2 side double-density \$460.00

BNMPI41S Full height 1 side single drive, dble-density \$380.00

BNMPI42S Full height 2 sided single drive, dble-density \$460.00

BNMPI41D Full height 1 side dual drive, dble-density \$760.00

BNMPI42D Full height 2 sided dual drive, dble-density \$920.00

(Shipping Weight: 11 lbs. per drive)

PRIORITY ONE ELECTRONICS

5" DISKETTES

SOFT SECTOR
40 TRACK SINGLE SIDED
DOUBLE DENSITY WITH
HUB REINFORCING RINGS

Package of 10: **\$19.95**

BONUS!

FREE!! KASSETTE 10
LIBRARY CASE WITH
PACKAGE OF 10 DISKETTES

A \$4.25 VALUE!! BNPRIS500 (Shipping Weight: 2 lbs.)

BNPRIS80 package of 80, less Library Case **\$120.00**



EIA/RS232 WALL PLATES

(Does not include connectors)

BN111WPDB251 Single punched

4/\$10.00

BN111WPDB252 Dual Punched

4/\$12.00

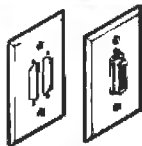

RS-232 "D" SUB-MINIATURE CONNECTORS

1-9 10-24 25-99 100-UP

BNCN00R25P	25 Pin Male	\$2.75	\$2.50	\$2.25	\$1.95
BNCN00R25S	25 Pin Female	\$4.00	\$3.50	\$3.25	\$3.00
BNCN00S1212	1 Pc. Grey Hood	\$1.65	\$1.40	\$1.25	\$1.15
BNCN0P25H	2 Pc. Grey Hood	\$1.50	\$1.25	\$1.10	\$1.00
BNCN00S1226	2 Pc. Black Hood	\$1.75	\$1.50	\$1.35	\$1.20
BNCN0020418	Hardware set 2/Pr.	\$1.00	\$.80	\$.70	\$.60

TEXAS INSTRUMENTS

16 PIN GOLD AND TIN DIP SOLDER TAIL SOCKETS

	TIN	GOLD
QTY	BNTI516LP	BNTI616LP
50	\$ 8.00	\$ 10.00
1000	\$ 60.00	\$ 80.00
4500	\$225.00	\$315.00

1200 BAUD AUTO-DIAL HAYES SMARTMODEM COMPATIBLE



U.S. ROBOTICS
MODEMS

\$495.00

The AUTO DIAL 212A Modem is a direct connect 0-300 or 1200 baud modem capable of dialing and calling for you. The AUTO DIAL 212A is compatible in function to the UC Hayes SMARTMODEM™.

Part No.	Description	List	SALE Price
BNUSRADIAL212A	0-300, 1200 baud dialing modem	\$599.00	\$495.00



ACOUSTIC MODEM

The PHONE LINK Modem is a 300 baud RS232 compatible acoustic modem capable of operating as either an answer or originate modem. It is BELL 103/113 compatible and will accept most standard phone handsets.

BNUSRPLNK	0-300 Baud acoustic modem	\$149.00	\$129.00
-----------	---------------------------	----------	----------

MICRO LINK DIRECT CONNECT MODEMS

BNUSRMLNK300	0-300 baud direct connect	\$179.00	\$159.00
BNUSRMLNK1200	1200 baud direct connect	\$449.00	\$399.00

AUTO LINK DIRECT CONNECT AUTO ANSWER MODEMS

BNUSRALNK300	0-300 baud auto/direct connect	\$219.00	\$195.00
BNUSRALNK1200	1200 baud auto/direct connect	\$499.00	\$449.00
BNUSRALNK212A	0-300, 1200 baud auto/direct	\$549.00	\$475.00

Specs	USRADIAL212A	USRADIAL1200	USRADIAL1200	USRADIAL300	USRADIAL300	USRPLNK
1200 Baud	X	X	X	X		
0-300 Baud	X	X	X	X	X	X
Auto Dial	X					
(Hayes Smartmodem compatible)						
Auto Answer	X	X	X	X		
Auto Mode Select	X			X	X	
DTR Override	X	X	X	X	X	X
RS232 plus 2B3 reversible	X	X	X	X	X	X
LED Indicators:	X	X	X	X	X	X
Carrier Detect	X	X	X	X	X	X
Analog Loopback	X	X	X	X	X	X
Self Test						
Send Data	X	X	X	X	X	X
Receive Data	X	X	X	X	X	X
Terminal Ready	X	X	X	X		
Off Hook	X	X	X	X		
Answer Mode	X	X	X	X		
Ring Indicate				X		
High Speed	X	X				

COMPLETE CompuPro SYSTEMS

FREE SUPERCALC-86! FREE dBASEII!!

AND A TELEVIDEO 910 TERMINAL FOR ONLY \$1.00!

SYSTEM 816/A

ENTRY LEVEL SINGLE-USER SYSTEM

System 816/A is an excellent choice for an entry level, single user system that's designed with future expansion in mind. 816/A includes Interlacer 4 (three serial I/O ports, parallel port, and Centronics/Epson-style port), two RAM 17s for 128K of fast, static memory, and System Support 1 (clock calendar, RAM/ROM/match processor options, RS-232C serial port, interrupt controllers, interval timers, and more), and Ashton-Tate's dBase Junior™, an upgradeable subset of their popular dBase II data base management software. This combination of components means superb computing today with an option for future expansion — all the way up to a multi-user system. System 816/A is priced at \$5495.00, a savings of over \$1000.00 compared to all components purchased separately.

BNGBTSYS816ADA Single User System Desk Top, A&T **\$5495.00**

BNGBTSYS816ADC Single User System Desk Top, 200 hr. Burn-in **\$6345.00**

BNTLV910 TeleVideo 910 Black & White w/purchase of above system **\$1.00**

DATAGARD™ SGL WABER LINE MONITOR POWER CONDITIONERS

Before you plug in your computer, you'd better consider how you are going to insure or protect your investment from unwanted electrical pollution.

DG115 SERIES SINGLE STAGE SPIKE PROTECTION

Part No.	Description	Wt.	List	SALE
BNWBROG115P	Wall unit plug in	2 lbs.	\$49.95	\$34.95
BNWBROG115S	6 outlet strip w/SW<	3 lbs.	\$61.95	\$42.00

DG315 SERIES

3 STAGE SPIKE FILTER AND FOUR STAGE NOISE FILTER

BNWBROG315P	Wall unit plug in	2 lbs.	\$153.95	\$99.95
BNWBROG315S	6 outlet strip w/SW<	3 lbs.	\$193.95	\$119.95
BNWBROG315R	6 outlet racksw/SW<	8 lbs.	\$193.00	\$119.95



Z-80 BEGINNER KIT Z80 CPU - 2 S-100 EXPANSION SLOTS

- Z80 CPU
- 2 S-100 slots for expansion
- Wire wrap area for custom circuitry
- On board keyboard and display
- Cassette interface for mass storage
- 2K RAM included
- 4K ROM (not included)
- RS232 port 300-19.2K baud
- Comes with ZBUG Monitor on ROM with SID driver routines
- TINY BASIC available

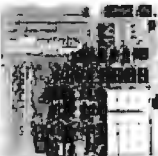

BNQTCZ80BEGA

LIST PRICE: \$400.00

SALE PRICE:

\$340.00

(Shipping weight 4 lbs.)

TINY BASIC ROM:

BNQTCBASIC \$25.00

LOWEST COST PRINTER AVAILABLE \$229.00

THIS IS NOT A TYPOGRAPHICAL ERROR!



AXIOM
AXIOM CORPORATION

For More
Details,
See Page 215
of the January
Issue of BYTE.

- 5 x 7 Dot Matrix • Parallel Interface (Centronics) • Tractor Feed • Dot Addressable Graphics • Up to 3-Part Paper • Self Test • One Year Warranty • 30 CPS 80 Column Unidirectional • Uses Regular Paper

BNAXMGP100A (Shipping Weight 11 lbs.)

List Price: \$389.00 **\$229.00**



PRIORITY ONE ELECTRONICS

9161 DEERING AVE • CHATSWORTH, CA 91311

ORDER TOLL FREE (800) 423-5922 - CA, AK, HI CALL (213) 709-5111

Terms: U.S. WSA, M.C., B.A.C., Check, Money Order, U.S. Funds Only. CA residents add 6.25% Sales Tax. MINIMUM PREPAID ORDER \$15.00. Include MINIMUM SHIPPING & HANDLING of \$3.00 for the first 3 lbs., plus 40¢ for each additional pound. Orders over 50 lbs. sent freight collect. Just in case, please include your phone number. Prices subject to change without notice. We will do our best to maintain prices through February, 1983. Credit Card orders will be charged appropriate freight. If you haven't received your Winter '83 Engineering Selection guide, send \$1.00 for your copy today! Sale prices for prepaid orders only.



HITACHI DUAL TRACE OSCILLOSCOPES

ALL HITACHI DUAL TRACE SCOPES ARE SHIPPED COMPLETE WITH 2 PROBES AND INSTRUCTION MANUAL.

V-353F

35 MHz DELAYED SWEEP

- Single time base delay sweep • rectangular CRT with internal graticule
- High sensitivity 1mv/div (7MHz)
- Large dynamic range of 8 div to full bandwidth • CH1 output • Built-in signal delay line

BNNH1V353F List: \$949.00

SALE: \$799.00

V-203F

20 MHz DELAYED SWEEP

- Single time basedelay sweep • High sensitivity 1mv/div (5MHz) • Full TV triggering • X-Y operation • CH1 Output • High reliability, MTBF 20,000 hours

BNNH1V203F List: \$749.00

SALE: \$625.00

V-302F

30 MHz DUAL TRACE

- High sensitivity 1mv/div (5 MHz) • Full TV Triggering • X-Y operation • CH1 Output • Built-in signal delay line
- High reliability, MTBF 20,000 hours

BNNH1V302F List: \$799.00

SALE: \$699.00

V-352F 35 MHz DUAL TRACE

Same as V352F except without delayed sweep.

BNNH1V352F List: \$895.00 **SALE: \$749.00**

V-202F 20 MHz DUAL TRACE

Same as V203F except without delayed sweep.

BNNH1V202F List: \$695.00 **SALE: \$575.00**

V-152F 15 MHz DUAL TRACE

Same as V302F except without delay line and only 15MHz.

BNNH1V152F List: \$595.00 **SALE: \$495.00**

64K IEEE/S-100 DYNAMIC RAM



2 or 4MHz BANK SELECTABLE

- 2 or 4 MHz operation • Designed to IEEE proposed S-100 bus standards
- Supports IMSAI-type front panels • Operates with either an 8080 or Z-80 based S-100 system providing processor transparent refreshes with both
- Bank-select system allows system memory expansion • Bank-select port's address is jumper selectable • Any 16 K block can be made bank-independent
- All 64 K can be made bank-enabled on power-on and reset
- Fully buffered address and data lines • Configuration as a 16K, 32K or 48K board without the removal of RAMs
- Fail-safe refresh circuitry for extended Wait States • Board configuration with reliable, easy to configure Berg jumpers
- Supports DMA • Jumper-selectable Phantom input • Assembled & Tested • All ICs in sockets • Uses Popular 4116 RAMs • Full factory warranty.

REGULAR LIST PRICE IS \$375.00

YOU SAVE AN INCREDIBLE \$176.00!!

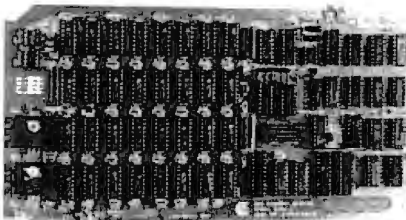

\$199.00

BNCCS20653 (Sh. Wt. 2 lbs.)

COMPARE PRICES!

ADDS

Applied Digital Data Systems Inc.

SALE!
\$525.00

VIEWPOINT 3A+- ADDS

Detachable keyboard, RS232 interface and auxiliary port. 80 x 24 display with 5 x 7 dot matrix, tilttable 12" green screen.

BNA00VPR Sh. Wt. 30 lbs. List: \$699.00 **OUR PRICE: \$525.00**

S-100 BOARDS

SSM

Part No.	Description	List	Our Price
BNSSMPB1A	2708/2716 Programmer & EPROM	\$265.00	\$219.89
BNSSMI05A	I/O5 Input/Output	\$329.00	\$289.89
BNSSMI08A	I/O8 Eight Serial I/O	\$550.00	\$489.89
BNSSMI04A	2 Parallel, 2 Serial I/O	\$290.00	\$249.89
BNSSMV3A24	80 x 24 Video Board	\$499.00	\$440.00

DUAL

BNDULCPU6800D	68000 S-100 CPU	\$895.00	\$850.00
BNDULMEM256K	256K Dynamic Memory Card	\$1295.00	\$1230.00
BNDULMEM32K	32K CMOS Memory Card	\$660.00	\$660.00
BNDULEPROM32	2716 EPROM Board	\$295.00	\$280.00
BNDULSI04DMA	SI04-DMA	\$695.00	\$650.00

QT COMPUTER

BNTQTCB08EGA	Z80A SBC Beginner Kit A&T	\$400.00	\$360.00
BNTQCS024A	S-100 SBC A&T	\$325.00	\$295.00
BNTQCCSA	Clock Calendar	\$165.00	\$150.00

CALIFORNIA COMPUTER

BNCCS2010A	Z80A CPU w/RS232	\$325.00	\$289.89
BNCCS271001	4 Port Serial I/O	\$325.00	\$310.00
BNCCS271901	2 Serial, 2 Centronics Par.	\$360.00	\$345.00
BNCCS272001	4 Port Parallel I/O	\$275.00	\$265.00
BNCCS273001	6 Port Serial I/O	\$550.00	\$525.00
BNCCS2422A	Floppy disk controller w/CP/M	\$425.00	\$399.00

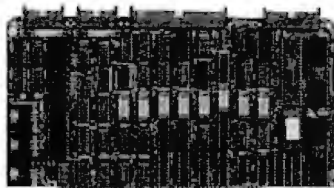
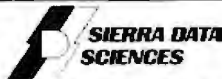

MICROPOLIS™

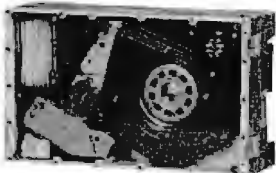

BEST OF BOTH WORLDS! PERFORMANCE AND LOW COST!

- Z80A 4MHz CPU • 64K RAM • 2 Serial RS-232 Ports • Floppy Disk Interface Controls Four 8" or 5 1/4" Drives • 35 Mbytes of mass storage • CP/M 2.2 with the Sierra Data Menu Driven BIOS
- Winchester Hard Disk Adaptor • Disk Drive Power Supply and Cabinet • Drive Data Cable • S-100 IEEE Compatible.

PACKAGE CONTAINS:

- BNSOSSBC SBC Computer \$850.00
- BNSOSHD1 Hard Disk Cont. \$150.00
- BNSOSWHMCP Disk Cab & P.S \$495.00
- BNMCP12231 35 Mbyte Hard Disk \$3595.00
- BNSOSCPM CP/M 2.2 w/BIOS \$150.00

TOTAL PACKAGE PRICE:

\$4795.00

SAVE \$445.00!!

BNPDBS0MCP

(Shipped in 5 boxes, total Sh. Wt: 81 lbs.)

COEX 80 F/T LOW COST, DOT MATRIX PRINTER!



- 80 cps • 10, 12 or 16.5 cpi • 3 selectable line spacing • Vertical format control • Centronics parallel or RS232 serial interface • Use a standard Underwood spooled ribbon • Friction and tractor feed.

	List Price	Our Price
BNCOX80FT Parallel int.	\$399.00	\$329.00
BNCOX80FTSER Serial int.	\$399.00	\$329.00

List Price: \$399.00

SALE PRICE:

\$329.00

(Shipping Weight 21 lbs.)

PRIORITY ONE ELECTRONICS

9161 DEERING AVE • CHATSWORTH, CA 91311

ORDER TOLL FREE (800) 423-5922 - CA, AK, HI CALL (213) 709-5111

Terms: U.S. VISA, MC, BAC, Check, Money Order, U.S. Funds Only. CA residents add 6 1/2% Sales Tax. MINIMUM PREPAID ORDER \$15.00. Include MINIMUM SHIPPING & HANDLING of \$3.00 for the first 3 lbs. plus 40¢ for each additional pound. Orders over 50 lbs. sent freight collect. Just in case, please include your phone number. Prices subject to change without notice. We will do our best to maintain prices through February, 1983. Credit Card orders will be charged appropriate freight. If you haven't received your Winter '83 Engineering Selection guide, send \$1.00 for your copy today! Sale prices for prepaid orders only.

Vista SOLO

Introducing Solo, a new cost-effective solution to Apple Disk Storage, offering all the capabilities of the standard Apple Disk II at a fraction of the cost!

APPLE DISK DRIVE

- Totally Apple II compatible
- Cost effective
- 35 track drive
- 143K bytes of storage
- 120 day warranty

\$269.00

List Price SALE

BNVIS3101 Apple drive add-on \$299.00 **\$269.00**

VISTA 3101 DISK DRIVE WITH APPLE II CONTROLLER

BNVIS311 Drive with controller \$379.00 **\$349.00**
(Shipping Weight 6 lbs.)

Unclassified Ads

FOR SALE: Sinclair ZX81 computer complete with 16K memory module and Financial Program package, used for only one week. \$110. Joe Bryan, 1607 Limestone Court, Montgomery, AL 36117, (205) 272-0754.

FOR SALE: IBM Selectric terminal from the IBM Saber system converted to an uppercase and lowercase printer. \$200 buys printer, interface and driver for H-8, driver listing, and schematics needed to interface to other microcomputers. Tom Golway, (212) 735-2935, Monday through Friday between 9:30 a.m.—4:30 p.m.

FOR SALE: Heathkit H-14 printer with 40, 80, 96, and 132 columns. Selectable bps rate 110, 9600. Letter quality. RS-232C interface. \$290. Jim Brooks, 3343 Grand River Dr., Grand Rapids, MI 49505, (616) 363-2660.

WANTED: Hardware information, service manuals, circuit diagrams, etc., for aging Wang 2200B computer; any or all peripherals and any information concerning add-on ROMs. Am also interested in reasonably priced peripherals for same. Will gladly pay for photocopies, etc., but please contact me first to avoid duplication. Phil Sutherland, POB 177, Nedlands, Western Australia 6009, or phone international + 61 9 386 4859 during office hours here (0100 to 0900 GMT).

FOR SALE: North Star floating-point board. Unused, due to incompatibility with FORTRAN compiler. Lists at \$399, will sell for \$250 or best offer. Mike Modest, 12651 Windward Ave., Los Angeles, CA 90066, (213) 397-4836.

WANTED: Your help bringing microcomputing awareness to rural Minnesotans. East Central Regional Library (ECRL) Computer Fund raises funds to place microcomputers and educational software in rural libraries for use by general public free of charge. Send tax-deductible contributions to ECRL Computer Fund, Attn: D. L. Deye MD, Cambridge Clinic, 626 South West 7th Ave., Cambridge, MN 55008.

FOR SALE: Apple Silentype thermal printer with interface card and connecting cable. Driven by little old lady to church on Sundays. Excellent condition. Free with purchase: one well-used but interpretable manual. Asking \$425 US funds. Response guaranteed. Erik Sea, 22 Edgar Dr., London, Ontario, N6G 1K1 Canada.

FOR SALE: 54 disks of games! Complete personal collection of over 1,000 arcade, adventure, educational, space, etc. Will sell only as a unit for \$850. One of a kind. E. Abrams, 6400 Hayes St., Hollywood, FL 33024, (305) 987-6889.

FOR SALE: New TRS-80 Model III with 48K, two disk drives, serial port, Script Word Processor and parallel cable; best offer. Spectrum Soft Sector 5 1/4-inch floppy disks, excellent quality; they will work in Apple, TRS-80, and many others: \$2.50 each plus sufficient first-class postage. J. Browning, 3616 Crest SE, Albuquerque, NM 87108.

WANTED: Apple II with 16K of memory or Osborne I personal computer in exchange for full tax write-off. A professional, fully registered, nonprofit theatre needs a small business computer for budget planning and control needs. Word processing and printing capabilities are not essential. Your donation is tax-deductible. David Lemos, Producing Director, San Jose Repertory Company, POB 9584, San Jose, CA 95157, (408) 294-7572.

ATARI USERS: I am currently interested in hearing from other Atari users around the states to start a users group and put out a newsletter. If you have anything to contribute to the first issue please send it to me. I am also looking for software to trade. John Conley, 11 Sunnyside Rd., Scotia, NY 12202.

FOR SALE: Attention homebrewers! I am selling many ICs and other components. Most of these ICs are memory, LSI interface, and many 7400 TTL, also some 4000 CMOS. All at low prices and guaranteed. Most are new and unused. Send SASE for a list and prices. Kevin Lovelace, 5500 Sonora Dr., North Little Rock, AR 72118.

FOR SALE: Eaton LRC 7000+ printer with manual, three new ribbons, and cable. Excellent condition. \$150. John C. Daoust, 1103A East 23rd St., Texarkana, AR 75502, (501) 774-1340 after 5 p.m.

FOR SALE: Lobo Model 1850 hard disk for Apple II Plus computer. Includes in one package: 10-megabyte fixed 8-inch disk, 1.2-megabyte 8-inch floppy disk, power supply, and controller card. Brand-new condition, 6 months remaining on factory warranty: \$3000. Ray Krauss, 3478 East Jamison Ave., Littleton, CO 80122, (303) 694-1931.

FOR TRADE: Software for Timex and/or Sinclair computers with 16K RAM. I have a collection of games and utilities which I would be interested in swapping for programs of equal value. They are available on cassette or in listing form. Chris Collins, 485 Willowtree Dr., Melbourne, FL 32935.

WANTED: Manual for TDLXitan text editor. Will pay cost of duplicating. Lloyd Larson, 38236 Sheridan Rd., Waukegan, IL 60087, (312) 244-4943, evenings: 882-3777, days.

FOR SALE: DEC M8059-KF 128K-word (16 bit with parity) memory card for Q-bus (LSI-1). Brand new in original box; manufactured April 1982. DEC list price: \$2834 with 12-month delivery. Uses Hitachi 4164s. Asking \$2000, price negotiable. Michael Blyler, Georgia Tech Box 32380, Atlanta, GA 30332, (404) 874-4987.

FOR SALE: New multi-user North Star Horizon with 256K bytes of memory, 18-megabyte hard disk, one quad drive, one HSI0 board, and processor. Reasonably priced below wholesale. Drop a card with quote and I will call you. A. I., 74 Lincoln St., Jersey City, NJ 07307, (201) 659-0836.

FOR SALE: Exidy Sorcerer 32K, 8K BASIC pak, several games, computer instruction book, and BASIC instruction book: \$550 or best offer. Development pak: \$60. 64K Netronics memory board without memory (4116): \$100. Heathkit ET-3400 trainer and course: \$195. Would consider trade on any of the above for 8-inch disk drives or CP/M software. Nelson Lewis, 1005 Don Rovin Ln., Farmington, NM 87401, (505) 325-5426 evenings.

WANTED: CP/M software. Well-established nonprofit corporation seeks tax-deductible contributions of new and used CP/M software. Will furnish certified receipts. Philadelphia Festival Chorus, Suite 4310, 1500 Locust St., Philadelphia, PA 19102.

FOR SALE: Ball transistor-transistor logic 12-inch black-and-white monitors, little use, ready to plug into Osborne I. Money back if not fully satisfied: \$125 (\$130 with manual and schematic) plus UPS shipping charges. Also, I want a biorhythm program on 5 1/4-inch floppy disk for CP/M operating system. Lew Yeager, 728 Seventh St., Marietta OH 45750, (614) 373-6501.

FOR SALE: Heath H-89 with single 5 1/4-inch floppy disk and H-14 printer; best offer. Xerox dual 8-inch single-sided disk drives, new: \$1395. Sencore CB-42 analyst; best offer. Sams CB-1 through CB-125; best offer. Heathkit SB-300 and SB-401 complete with manuals; best offer. Stan Stevens, RR4 Box 26, Iowa City, IA 52240, (319) 354-9726.

WANTED: Collecting Apple II Plus one-line programs (up to five-liners) including utilities, graphic/sound routines, or illustrations of useful addresses in the Apple. If you wish a listing in return, please send a SASE with your one-liner or include a dollar (without a one-liner) to cover printing costs. James A. Sullivan, 2309 Glenn Court, Charlottesville, VA 22901.

FOR SALE: Two teletype Model 43 keyboard/printer, dot-matrix terminals, 30 cps RS-232C in mint condition, \$450 each. Also, Millennium universal in-circuit emulator with 6800 personality card, \$1500 (originally \$7000). Ralph Guditz, 1951 Colony St., Mountain View, CA 94043, (415) 960-3462 after 10 p.m. PT.

WANTED: TRS-80 Model I/III—compatible software to swap. I have a large library of programs to trade for anything ranging from utilities to arcade games. Send a list of your programs or a cassette or disk of your better programs and I will promptly return the same. Ron Katcher, 13843 North 51st St., Scottsdale, AZ 85254, (602) 996-5454.

FOR SALE: Ohio Scientific C4P Series 2, BK RAM and BK ROM; color graphics. Includes full schematics and instruction manuals. Used less than 500 hours. Paid \$1600 for computer and Amdek color monitor. \$1250 firm. I will pay shipping. Orpheus Allison, POB 387, Mapleton, ME 04757.

FOR SALE: 48K Apple II Plus computer with radio-frequency modulator and tape recorder. Lots of software plus all manuals and demonstration programs: \$900. Geoff Emerson, 3 Spaulding Court, Saugerties, NY 12477, (914) 246-9770.

FOR SALE: OSI C1P with 8K RAM, 32/64 video modification, new ROMs, RS-232C port, dual joysticks, and sound port. Good condition: \$375 or best offer. Also, Micro Communication Corp. digital tape drive and nine 50-foot tapes (similar to Exatron Stringy/Floppy); barely touched: \$125. Send SASE. Michael McInerney, 75 Coachman Dr., Penfield, NY 14526.

FOR SALE: Cromemco Z-2 with dual 8-inch floppy disks, 128K bytes of memory, digital-to-analog and TV Dazzler boards, two joysticks, SOROC IO 120 terminal, and GE Terminator 300 printer. Software: FORTRAN, assembly, Database, Word Processing, BASIC, Dazzler games and graphics, LISP, and Ratfor. Originally \$8000, asking \$3600. P. Baum, 11410 Lombardy Lane, Sunny-mead, CA 92388.

WANTED: Broken or unwanted computers, printers, and other peripherals. I am a high school student, but will pay for shipping and handling. Greg Ham, 4048 Southwest 8th St., Plantation, FL 33317, (305) 792-4204.

FOR TRADE: One or more new Xerox 820 computer systems with dual 8-inch disk drives (retail \$3900 each) and/or one or more Xerox #400 Teletipers (retail \$1695 each). We need three letter-quality printers of 40 cps or better; also a teletype display and keyboard; and/or a hard-disk system to link with our Altos 8000 processor. Call if you are interested in bargaining! Mary Lombardi, 547 Mission Vineyard Rd., San Juan Bautista, CA 95045, (408) 623-4576.

FOR SALE: PET 2001 with 24K bytes of memory (8K plus 16K expansion). Can insert additional 16K in memory-expansion board. Commodore 2040 dual-disk drive. One built-in cassette drive and added full-sized keyboard. All manuals included: \$975. Neil Omvedt, 3036 Asbury St., Roseville, MN 55113, (612) 633-5743.

FOR SALE: Apple III including black-and-white monitor and additional disk drive. Also, Pascal, Visicalc, and Business BASIC software packages. Less than one year old and in perfect condition. \$4000. R. Michael Tague, 200 Don Allen Rd., Louisville, KY 40207, (502) 895-4508.

WANTED: User manual, schematics, etc., for CompuTime CT-100-1 calculator and digital clock S-100 board. I will pay reasonable reproduction and mailing costs. Jim Wolfe, POB 6601, Torrance, CA 90504, (213) 376-2931.

FOR SALE: NEC 12-inch monitor and Microsoft 16K RAM card, unused, new: \$100 each or best offer. A. Morton, 1340 Laffer Ave., Akron, OH 44305, (216) 784-9697.

UNCLASSIFIED POLICY: Readers who have computer equipment to buy, sell, or trade or who are requesting or giving advice may send a notice to BYTE for inclusion in the Unclassified Ads section. To be considered for publication, an advertisement must be non-commercial (individuals or bona fide computer clubs only), typed double-spaced on plain white paper, contain 75 words or fewer, and include complete name and address. This service is free of charge; notices are printed once only as space permits. Your confirmation of placement is appearance in an issue of BYTE as we engage in no correspondence. Please allow at least three months for your ad to appear. Send your notices to Unclassified Ads, BYTE/McGraw-Hill, POB 372, Hancock, NH 03449.

Unclassified Ads

FOR SALE: Ohio Scientific Challenger 4P color computer. Excellent condition with Quasar solid-state black-and-white converted TV monitor and cassette recorder. Includes all manuals and OSI home-taped programs: \$550 or best offer. Barry Sitek, 140 Morriside Ave., Park Ridge, NJ 07656, (201) 391-6015.

ADVICE NEEDED: I have an 8085-based homebrew and I would like to implement a BASIC interpreter. I will buy or swap parts or ideas. I have many homebrew microcomputer circuits. B. Shaffe, 98 Onieda Ave., Centereach, NY 11720.

FOR SALE: TRS-80 Model III 48K with disk drive: \$1550, only 4 months old. Leave a message and I will call back. Robert Linza, (713) 332-7480.

FOR SALE: 3-year-old TRS-80 with four disk drives, high-speed daisy-wheel printer with optional tractorfeed, RS-232C, uppercase and lowercase adapter, data separator, 64K Omikron Mapper with CP/M. Excellent condition. Software includes Scripsit, Script, Chertext, NEWDOS, NEWDOS-80, TRSDOS, CP/M-2.2, C-BASIC, MBASIC-80, Wordstar, BASIC Compiler, TDAM, Sort-Merge, AIDS III, and much more. New cost was \$11,000 asking \$4675. Tom Hamilton, 1998 Collingswood Rd., Columbus, OH 43221, (614) 488-7771.

FOR SALE: S-100 boards in working condition: 16K North Star RAM for \$225. 16K Memory Merchant static RAM for \$150. 16K CCS Model 2116C static RAM for \$225. Morrow Switchboard for \$200. SSM 104-2 parallel, 2 serial I/O for \$225. R. E. Clark, 712 South Ninth, Memphis, TX 79245, (806) 259-2232 after 8 p.m.

WANTED: Wang 2200 SVP-8B, MB DSDD disk, two MB fixed disks, 2236 DE interactive terminal, and 2235 matrix printer. Joe Showers, 1315 North Union St., Wilmington, DE 19806, (302) 655-6224, collect during day.

WANTED: Used S-100 computer for college student. I will accept any excess you have: drives, mainframe, memory, etc. I will send my 5-year-old stamp collection as a donation toward a running disk system. Call before sending. Tom Knox, POW 111305, Nashville, TN 37211, (615) 333-3627 after 5 p.m.

FOR SALE: Two 5 1/4-inch Shugart Model SA400 disk drives together in case with power supply; includes cables, manual, and dustcover: \$360. Also, one SEA-16 16K-byte memory board for KIM, SYM, AIM, or any KIM-4 bus machine: \$100. Both in mint condition. Tim J. Ingham, 2540 College Ave. #302, Berkeley, CA 94704, (415) 548-5370.

WANTED: Any learning information appreciated as I have access to a Hewlett-Packard 2647A and a SWT 6800 System with flex. Trying to learn while in prison. Stafford B. Bright, POB AE-1146, San Luis Obispo, CA 93409.

FOR SALE: KIM system: KIM-1: \$80, RCA keyboard: \$50, TVT-6 video board: \$25, TRS-80 video monitor: \$40, Econoram II-A BK RAM: \$80, Trendcom 100 printer with Apple interface: \$225. Complete computer system up and running, with all technical manuals. Tiny BASIC, assembler, and much additional software: \$400. Will sell all or part. Joel Aycocock, POB 209, Kula, HI 96790, (808) 244-9108 [work].

WANTED: Used, working S-100 or multibus mainframe with motherboard and power supply, with or without cards. Also need wire-wrap boards for the above. David Langmann, 2900 Connecticut Ave. NW, Washington, DC 20008.

FOR SALE: Teletype Model 43 KSR, sprocket feed, with (internal) 16K-byte Edge Technology Inc. Telebuffer-43 ASR. Excellent condition: \$1300. F. T. Grover, B201 Hamilton Spring Court, Bethesda, MD 20817, (301) 365-0969.

FOR SALE: Word processor: Addressograph 425 with full-page 54-by-80 green monitor; letter-perfect Come daisy-wheel printer and tractorfeed; dual 8-inch drive. Complete with mail merge, sort, select and arithmetic options, 150 floppy disks, and manual. Excellent condition. New \$9000, will sacrifice for \$4200. Soaring Bear, 2509 North Campbell, Tucson, AZ 85719, (602) 432-3081.

FOR SALE: Complete set of BYTE magazines. Over 80 issues from premier 1975 issue to latest issue (August 1976 missing). \$210 postpaid. Greg Aharonian, 307 Willow Ave., Ithaca, NY 14850, (607) 256-4940.

WANTED: Graduate student wishes to correspond with anyone interested in cognitive sciences. Looking for exchange of techniques, ideas, and opinions on topics such as artificial intelligence, languages (LISP, Logo, Planner, etc.), and psychology. I have background in psychology and programming. Conrad Sanford, 135 State St. 768-360, Auburn, NY 13021.

FOR TRADE: Apple owners! Send me a list of your software programs and I will send you mine. I am especially interested in recreational software. Please include a SASE. T. I. Chienroi, POB 855, Islington, MA 02090.

FOR SALE: Hewlett-Packard HP 41-C calculator, card reader, four memory modules, math and stat modules, and several application books: \$425. Dr. Alan Grant, 530 44th St., Brooklyn, NY 11220, (212) 436-1714.

FOR SALE: Software for the Apple II Plus. The Comptroller, General Business System, AIR, AIP, and G/L. Nate Brown, (717) 822-6184.

FOR SALE: Exidy Sorcerer 32K-byte computer with BASIC ROM cartridge. Excellent condition, in original carton, with manuals, schematics, and two years of newsletter issues: \$590. Multibus interface for above, makes it Multibus Master: \$80 with cable. Intel 8086 University Kit, all the Integrated Circuits required to build an 8086 system (includes monitor in ROM), unused: \$90. Robot parts: two Sio-Syn 5.5V, 3.25-inch diameter, 50-ounce-inch torque stepper motors and platform for the above made of 1/2-inch machined aluminum: \$95. Bill Georgiou, 6661 Berkshire Terrace #31, Goleta, CA 93117.

FOR SALE: Back issues of BYTE, August 1977 to December 1980. David Yost, 13329 Pearl Rd., Strongsville, OH 44136, (216) 238-0644 after noon.

BOMB

BYTE's Ongoing Monitor Box

Article #	Page	Article	Author(s)
1	33	The Lisa Computer System	Williams
2	54	Build a Handheld LCD Terminal	Ciarcia
3	68	Apple's Enhanced Computer: The Apple IIe	Moore
4	90	An Interview with Wayne Rosing, Bruce Daniels, and Larry Tesler	Morgan, Williams, Lemmons
5	118	The Enhanced VIC-20, Part 1: Adding a Reset Switch	Swank
6	130	The World of Standards	Card, Prigge, Walkowicz, Hill
7	146	Welcome to the Standards Jungle	Witten
8	182	A Proposed Floppy-Disk Format Standard	Card
9	194	The Proposed ANSI BASIC Standard	Anderson
10	203	NAPLPS: A New Standard for Text and Graphics, Part 1: Introduction, History, and Structure	Fleming, Frezza
11	256	Realizing Graphics Standards for Microcomputers	Langhorst, Clarkson
12	272	The IEEE Standard for the S-100 Bus	Garetz
13	302	The Scribble Text Processor	Kern
14	314	Problem Oriented Language, Part 3: Assembling the Modules	Finger
15	347	User's Column: Confessions, Pascal Prime, Wescon, and Perfect Writer	Pournelle
16	366	LDOS Utilities	Danieliuk
17	392	Shape-Table Graphics for the TRS-80	Rollins
18	452	Passing Untyped Parameters in UGSD Pascal	Willner
19	458	A Terminal Program for the TRS-80 Model III	James

MPX a Winner

Readers of the November BYTE voted overwhelmingly for Steve Ciarcia's "Build the Circuit Cellar MPX-16 Computer System, Part 1." Ciarcia will receive the \$100 first-place award for his project on designing an 8088-based system than can run any peripheral device designed to be installed in the IBM Personal Computer. Second place goes to Peter Sørensen for "Tronic Imagery," in which he described the development of the computer-generated graphics in the movie Tron. He will receive \$50. Third place goes to Jerry Pournelle for his User's Column "Terminals, Keyboards, and How Software Piracy Will Bring Profits to Its Victims."

Reader Service

Inquiry No.	Page No.	Inquiry No.	Page No.	Inquiry No.	Page No.	Inquiry No.	Page No.
1	47th STREET COMPUTER 481	88	COMPUADD 482	175	FORTECH SYSTEMS 496	262	MICRO PRO INT'L. 174, 175
2	800 SOFTWARE 195	90	COMPUPRO/GODBOUT 105	176	FOX & GELLER INC. 307	264	MICRO SCI 93
3	A.S.T.RESEARCH 168, 169		COMPUPRO/GODBOUT 430, 431	177	FRANKLIN COMP.CORP. 125	266	MICRO WEST 417
4	AB COMPUTERS 475	93	COMPUSERVE 71	325	FROBCO 480	267	MICRO WORKS, THE 206
5	ABACUS DATA INC. 81	345	COMPUSHACK 202	179	G-H COMPUTER SYS. 484	269	MICROCOMP.BUSN.IND. 222, 223
6	ACTIVE ELECTRONICS 415	346	COMPUSHACK 260	180	GARDEN OF EDEN COMP. 494	271	MICRODYNAMICS 488
7	ADDMASTER CORP. 492	94	COMPUSOFT PUBL.-B 108	181	GENERAL SOFTWARE INC. 375	272	MICROHOUSE 12, 13
8	ADISA CORP. 496	95	COMPUTER APPARATUS 500	182	GENIE COMPUTER CORP. 66, 67	273	MICROPERIPH.CORP.THE 488
9	ADV.COMP.PROD. 512, 513	96	COMPUTER CHANNEL 500	464	GENSTAR REI 460	274	MICROPROCESSORS UNLTD. 496
10	ADV.DIGITAL CORP. 255	97	COMPUTER COMPNTS.UNLTD. 360	183	GIFFORD COMP. SYS. 275	275	MICROSOFT 263
149	ADV.LOGIC SYSTEMS 311	98	COMPUTER DISC. OF AM. 298	183	G&G ENGINEERING 275	276	MICROSTUF. INC. 287
11	ADV.SYS.CONCEPTS 478	99	COMPUTER DISCOUNT PROD. 477	185	GILTRONIX INC. 480	277	MICROTECH EXPORTS 297
12	AEGIS SYSTEMS 467	455	COMPUTER EXCHANGE 136, 137	187	GLOUCESTER COMP. BUS C 486	278	MICROWARE 488
13	AFTERTHOUGHT ENG. 486	456	COMPUTER EXCHANGE 136, 137	188	GTEK INC. 50	279	MILLER MICROCOMP.SERV. 288
*	ALF PRODUCTS, INC. 393	457	COMPUTER EXCHANGE 136, 137	189	HAL SOFTWARE BROKERS 436	280	MINI MICRO MART 219
14	ALL ELECTRONICS CORP. 494	103	COMPUTER FURN.&ACCS. 266	190	HANDWELL CORP. 463	281	MINI MICRO MART 234
15	ALPHA BYTE COMP.PROD. 52, 53	104	COMPUTER INNOVATIONS 28	191	HARPER & ROW 356	282	MINI MICRO MART 483
16	ALPHA BYTE COMP.PROD. 293	105	COMPUTER LEARNING TREE 214	192	HAYDEN BOOK CO. 363	283	MINOLTA CORP. 353
17	ALPHA BYTE COMP.PROD. 327	114	COMPUTER LINE 300, 301	194	HAYES MICROCOMP.PROD. 112, 113	284	MK RESEARCH 490
18	ALPHA SOFTWARE 123	115	COMPUTER LINE 317	195	HEATH COMPANY 96, 97	285	MONARCHY ENG.INC. 478
19	ALTOS COMP.SYS. 336, 337	106	COMPUTER MAIL ORDER 376, 377		HEWLETT-PACKARD 180, 181	286	MONITOR DYNAMICS 486
20	AMDEK CORP. 231	107	COMPUTER PERIPH., INC. 173	196	HEWLETT-PACKARD 344, 345	287	MONROE SYS.FOR BUSN. 397
21	AMER.SMALL BUSN.COMP. 451	108	COMPUTER PLUS 415	*	HILTON HOTEL CORP. 319	288	MOORE BUSN.FORMS 362
22	AMER.SQUARE COMP. 147	109	COMPUTER SOLUTIONS 139	197	HOFFMAN COMP. PROD. 484	290	MOUNTAIN VIEW PRESS 389
23	AMERICAN COMPUTER PROD. 437	110	COMPUTER SOURCE INT'L. 126	198	HONOR SYS.SOFTWARE 496	291	MPI 15
452	ANCIE LABS 415	111	COMPUTER SPLCTIES. 218	199	HUMAN SOFT 385	292	MUSYS 44
24	APOGEE INC. 494	*	COMPUTER WAREHOUSE 343	200	I.T.M. 102	293	NEBS 437
25	APPARAT INC. 207	474	COMPUTERS & MORE 459	200	IBM CORP. 312, 313	294	NEC HOME ELECTR.USA 153
26	APPLE COMPUTER INC. 240, 241	112	COMPUTERS WHOLESALE 133	201	IBM INSTRUMENTS, INC. 116, 117	295	NEC INFORMATION SYS. 63
27	APPLEWARE, INC. 480	113	COMPUTERWARE 248, 249	202	IBS CORPORATION 357	296	NEC INFORMATION SYS. 76, 77, 78, 79
*	APPLIED CREATIVE TECH., INC. 24	116	COMPUTING 259	203	IDS INTERNATIONAL 185	300	NEC INFORMATION SYS. 225
28	APPLIED MICROSYSTEMS 183	117	CONCURRENT CORP. 84	204	INCOMM 443	*	NETRONICS 497
29	APPLIED SOFTWARE TECH. 277	118	CONNECTICUT MICRO COMP. 254	206	INCOMM 465	301	NETWORK CONSULTING CORP. 166
31	ARK MICROSYSTEMS 492	89	CONSOLINK CORP. 9	207	INFOSCRIBE 16	302	NORTH HILLS CORP. 482
32	ARTIFICIAL INT'L.RESPCH. 482	119	CONSUMER COMP. 188, 189	208	INSIGHT ENTERPRISES 490	303	NORTH HILLS CORP. 492
33	ASHTON-TATE 200, 201	121	CONTROL DATA 128, 129	209	INSTITUTE -SCTF.ANALYSIS 478	304	NORTHWEST INSTR.SYS. 215
34	ASHTON-TATE 250	122	CORTEX RESEARCH CORP. 494	210	INTEGRAND 278	476	NOVATION 270
35	ASPEN SFTW.CO. 114	123	COST PLUS COMP. 494	212	INTELLIGENT ARTEFACTS 411	477	NOVATION 271
36	ATARI 445	*	COUGAR M.T. SOFTWARE 456, 459	213	INTERACTIVE STRUCT. 247		NRI SCHOOLS ELECTR. DIV. 401
37	ATLANTIC CABINET CORP. 480	124	CPU SHOP, THE 499	214	INTERTEC DATA SYS. 11	305	OASIS SYSTEMS 338
38	ATLANTIS COMP.SERV. 484	125	CREATIVITY UNLTD. 494	215	IPEX INT'L. 126	306	OKIDATA CORP. 213
39	ATSUKO COMPUTING INT'L. 490	126	CROMEMCO CI, 1	470	IRONSIDES 109	307	OMEGA SALES CO. 253
40	AUTOCONTROL INC. 326	127	CROMEMCO 2	216	J.C.SYSTEMS 152	308	OPTRONICS TECH 86
41	AUTOMATED EQUIPMNT. 205	129	CSCS 494	217	JADE COMP.PROD. 501	309	ORANGE MICRO 165
42	AVOCET 395	130	CUESTA SYSTEMS 463	218	JADE COMP.PROD. 502, 503	310	ORANGE MICRO 187
43	B&B ELECTR. 488	131	CUSTOM COMP.TECH. 453	219	JAMECO ELECTR. 508, 509	311	ORGANIZATIONAL MANAGEMENT SYS. 486
44	BASF SYSTEMS 47	*	CYBERNETICS INC. 73	220	JDR MICRODEVICES 514, 515	312	ORTHOCODE GROUP 58
45	BAUSCH & LOMB INSTR.SYS. 119	133	CYCLONE SOFTWARE 490	221	JDR MICRODEVICES 516, 517	313	ORYX SOFTWARE 365
46	BAUSCH & LOMB INSTR.SYS. 119	*	DMA 387	222	JRT SYSTEMS 88, 89	*	OWENS ASSOC. 18
47	BAY TECHNICAL ASSOC. 464	134	DAMAN 480	223	JVB ELECTRONICS 480	316	P.R.I.C.E. 484
48	BAZ ELECTRONICS 496	135	DATA ACCESS CORP. 120	224	K.R. & R. 490	317	PACIFIC COMP. 306
*	BELL, JOHN ENGR. 491	136	DATA ACQUISITIONS SYS. 85	225	KADAK PRODUCTS 349	318	PACIFIC EXCHANGES 462, 478, 482, 486, 488, 490, 494
50	BHRT 149	137	DATA BASED SOLUTIONS 140	226	KEY TRONICS CORP. 305	326	PALOMAR COMP.EQUIP. 518, 519
51	BISON PROD INC. 299	139	DATA EXCHANGE 484	227	LABORATORY MICROSYS. 488	327	PAN AMERICAN ELEC. INC. 413
52	BISON PROD INC. 299	211	DATA MAIL 411	228	LAWSON LABS 492	328	PANASONIC H.H.C. 144, 145
53	BISON PROD INC. 299	140	DATA ROYAL INC. 359	229	LEADING EDGE PROD. CI11	*	PEEK 478
54	BISON PROD INC. 299	141	DATA SOURCE SYS.CORP. 405	231	LIFEBOAT ASSOC. 413	330	PERCOM DATA 7
55	BISON PROD INC. 299	142	DATASMITH 388	232	LOGICAL DEVICES 440	331	PERIPHERAL MARKETING INC. 492
56	BLAT RESRCH. & DEVELOP. 244	143	DATASOUTH COMP.CORP. 17	233	LOGICAL MICROCOMPUTER 46	332	PERIPHERALS UNLTD. 346
57	BOTTOM LINE, THE 211	144	DATASOUTH COMP.CORP. 199	465	LOGIC PRGM. ASSOC. 460	333	PERSONAL COMP.SYS. 335
58	BPI SYSTEMS 91	145	DIGITAL DIMENSIONS 148	236	LYBEN COMP.SYS. 488	334	PERSONAL COMPUTER AGE 246
59	BRIDGE COMPUTER 496	*	DIGITAL EQUIPMNT.CORP. 290, 291	237	LYBEN COMP.SYS. 326	335	PERSONAL SYS.TECHN. 45
60	BUNKER-RAMO 420	146	DIGITAL MARKETING 6	240	LYCO COMPUTER 383	336	PHASER 161
61	BUSINESS SOLUTIONS 388	147	DIGITAL RESEARCH 49	241	MACROTECH INT'L. 265	337	PICKLES & TROUT 196
*	BYTE BOOK CLUB 449	148	DIGITAL RESEARCH 143	242	MAILCOMP INC. 333	338	PION INC. 216
*	BYTE BACK ISSUES 342	149	DIGITAL RESEARCH 311	243	MANX SOFTWARE 94	339	POPCOM 230
63	BYTE INDUSTRIES 438	*	DIGITAL RESEARCH COMP. 479	522	MARCEY, INC. 379	340	PRACTICAL PERIPH. 22, 23
*	BYTE PUBL. INC. 216	15	DISCOUNT SOFTWARE 171	523	MARCEY, INC. 379	479	PRINCETON GRAPHIC SYS. 135
64	BYTEK COMP. SYS. 435	15	DOKAY COMP.PROD. INC. 510, 511	245	MARTIN MARIETTA CORP. 309	341	PRIORITY ONE 217
65	BYTEWRITER 26	*	DOW JONES SOFTWARE 177	245	MARYMAC INDUSTRIES 374	342	PRIORITY ONE 520, 521, 522, 523, 524
66	C-SYSTEMS 480	153	DUAL SYS.CONTROL CORP. 155	245	MARTIN MARIETTA CORP. 309	347	PROFESSIONAL DATA SYS. 285
67	CAB-TEK, INC. 413	154	DYSAN CORP. 328, 329	245	MARYMAC INDUSTRIES 374	348	PROFESSIONAL DATA SYS. 322
68	CALIF. DATA CORP. 482	156	E/Z ASSOC. 478	247	MC NEILL 466	349	PROGRAMMERS SFTW. EX. 8
*	CALIF. DIGITAL 506, 507	230	EASTERN ENTERPRISES 445	*	MC GRAW-HILL CONTN. EDU. CTR. 192, 193	350	PURCHASING AGENT, THE 160
*	CALIF.MICRO.COMP. 435	158	ECONOMY PERIPHERALS 478	248	MEDIA DISTRIBUTING 228	525	Q.T./GOLDEN WEST 267
70	CDEX CORP. 19	159	ECOSOFT 451	249	MEDIA DISTRIBUTING 229	352	QUADRAM CORP. 269
71	CDR SYSTEMS 484	160	EDGE MICROSYSTEMS 482	250	MEDIISOFT 488	353	QUADRAM CORP. 280, 281
72	CHECK-MATE 436	161	E.M.S. 230	251	MEGA CO. 126	354	QUARK ENGINEERING 101
73	CHECKS-TO-GO 150	162	E.M.S. 486	252	MEMORY MERCHANT 111	356	QUASAR DATA PROD.INC. 121
74	CHIPS & DALE 463	163	ELECTROSONICS 326	253	METAMORPHIC SYS.INC. 107	442	QUBIE DISTRIBUTORS 59
75	CHRISLIN INDUSTRIES 221	165	ELLIS COMPUTING 179	254	MFJ ENTERPRISES INC. 296	443	QUBIE DISTRIBUTORS 295
76	CMA 48	166	EMERGING TECH.CONSLT. 131	255	MICRO AGE COMP.STORE 268	357	QUEST ELECTR. 485
242	COGITATE 484	167	EMERGY AIR FREIGHT 321	256	MICRO BUSN.WORLD 330	358	QUEST RESEARCH INC. 482
77	COLONIAL DATA SERV. 282	*	EMPIRICAL RESRCH.GRP. 154	257	MICRO INK, INC. 486	359	QUEST CORP. 98, 99
471	COLORADO CHIPS 492	161	E.M.S. 230	258	MICRO MANAGEMENT SYS. 382	361	R.C.ELECTRONICS 198
78	COLUMBIA DATA PROD. 103	162	E.M.S. 486	259	MICRO MANIA 394	362	RACET COMPUTES LTD. 421
79	COLUMBIA NATIONAL 352	169	ENERCOMP 236	265	MICRO MART 126	364	RADIO SHACK CIV
80	COMMUNICATIONS ELECTR. 493	170	ENGINEERING SPECIALTIES 478	260	MICRO MIDWEST 478	365	RANA SYSTEMS 30, 31
81	COMMUNICATIONS ELECTR. 495	171	EPSON AMERICA 232, 233	261	MICRO MINT 399	366	RCA 141
82	COMP.ELECTR.SUPPLY.SVC. 251	172	ESSEX PUBLISHING 420	468	MICRO MINT 461	368	RCA SYSTEMS 87
83	COMPONENTS EXPRESS 409	173	EXPOTEK 190			369	RED BARON COMP.PROD. 156, 157
84	COMPONENTS EXPRESS.451	268	EXTENDED PROCESSING 492			370	RICKERDATA 462
86	COMPUADD 482	463	FINER PROGRAM 460			363	R.K.S. INC. 439
87	COMPUADD 482	174	FORMULA INT'L. 407			458	ROKLAN SOFTWARE 32

To get further information on the products advertised in BYTE, fill out the reader service card with your name and address. Then circle the appropriate numbers for the advertisers you select from the list. Add a 20-cent stamp to the card, then drop it in the mail. Not only do you gain information, but our advertisers are encouraged to use the marketplace provided by BYTE. This helps us bring you a bigger BYTE. The index is provided as an additional service by the publisher, who assumes no liability for errors or omissions. *Correspond directly with company.

Reader Service

Inquiry No.	Page No.	Inquiry No.	Page No.	Inquiry No.	Page No.	Inquiry No.	Page No.
454	SCION CORP 5	394	* SPERRY UNIVAC 426, 427	413	* TEXAS COMP.SYS. 245	433	WASHINGTON COMP.SERV. 489
379	SCOTIA SOFTWARE 100	395	STANDARD & POORS 274	414	TEXPRINT 126	*	WESTICO INC. 239
*	SCOTTSDALE SYSTEMS 315	396	STEMMOS LTD. 298	414	THINKER'S SOFT INC. 110	*	WESTINGHOUSE/LIGHTING DIV. 403
392	S D SYSTEMS 208, 209	395	STREET ELECTR. CORP. 20	415	TIMESHARING DEV. INC. 292	*	WESTINGHOUSE ELECTR.CORP.
380	SECTOR SYSTEMS 490	396	SUNNY INT'L. 488	416	TNW CORP. 132		INSERT 64A
381	SEIKOSHA CORP. 451	397	SUNTRONICS 487	417	TOSHIBA AMERICA INC. 361	435	WHOLESALE SUPPLIERS 480
382	SIERRA DATA SCIENCES 29	398	SUPERSOFT 163	418	TRAKTOR 381	436	WILD HARE COMP.SYS. 355
472	SIERRA DATA SCIENCES 323	399	SYSTEMED 484	419	TRISTAR DATA SYS. 304	437	WIN/MILL RESEARCH INC. 490
478	SIGEN CORP. 244	400	TALLGRASS TECH. 106	419	TSK ELECTR.CORP. 279	438	WINTEK CORP. 486
383	SLR 494	401	TARBELL ELECTR. 237	466	U.S. EXCHANGE 461	440	WINTERHALTER & ASSOC. 429
384	SLUDER 429	526	TATUM LABS 496	420	U.S. MICRO SALES 504, 505	441	WORDTECH SYSTEMS 453
385	SOFTCORP INT'L. 92	402	TAYCO BUSINESS FORMS 462	422	U.S. ROBOTICS 104	444	X COMP 61
386	SOFTTECH MICROSYS. 191	403	TECH-DATA CORP. 480	423	UNIFIED SOFTWARE SYS. 488	445	XEROX EDUCATION PUBL. 95
387	SOFTQUEST 294	404	TECH-DATA CORP. 486	424	VECTOR ELECTR. 457	461	YANG ELECTRONIC 490
388	SOFTWARE BANC 83	*	TECHNICAL SYS.CONSLTNS. 243	426	VECTRIX 289	462	YANG ELECTRONIC 492
473	SOFTWARE MANAGEMENT GROUP INC. 459		TECMAR INC. 115		VERBATIM CORP. 197		
467	SOFTWARE PUBLISHERS 461		TEKSYM CORP. 494	42	VIDEX 21		
390	SOFTWARE TECHNIQUE 484		TEKTRONIX INC. 27		VISICORP INC. 273		
*	SOLID STATE SALES 362	408	TELECON SYSTEMS 310	428	VISUAL TECH.INC. 167		
393	SONICS MICRO SYS. 351	409	TELETEK 51	429	VOTRAX 424		
*	SOURCE EDP 324, 325	410	TERCER MEDIO 303	431	VYNET CORP. 350		
		411	TERMINALS TERRIFIC 386	432	WASHINGTON COMP.SERV. 438		

*Correspond directly with company.

National Advertising Sales Representatives:

Northeast (617) 444-3946
ME, NH, VT, MA, CT, RI, DE, MD,
VA, WV, OK, TX, Upstate NY,
Eastern Canada

Hajar Associates
280 Hillside Ave.
Needham Heights, MA 02194

Mid Atlantic (201) 741-7744
NY, NYC, NJ, PA

Hajar Associates
321 Broad St.
Red Bank, NJ 07701

Southeast (305) 628-3525
NC, SC, GA, FL, AL, MS, TN,
KY, LA

Hajar Associates
Diplomat Bldg.
5400 Diplomat Circle
Suite 205
Orlando, FL 32810

Midwest (312) 966-0160
MN, WI, MI, IA, IL, IN, OH,
MO, NE, KS, ND, SD, AR

Hajar Associates
5225 Old Orchard Rd.
Suite 50
Skokie, IL 60076

Northwest (415) 964-0706
AK, HI, WA, OR, ID, MT, WY,
Northern California, Nevada Except
Las Vegas, Western Canada

Hajar Associates
1000 Elwell Ct.
Suite 124
Palo Alto, CA 94303

Southwest (714) 540-3554
UT, CO, AZ, NM, Las Vegas,
Southern California

Hajar Associates
3303 Harbor Blvd.
Suite H-4A
Costa Mesa, CA 92626

European Advertising Sales Representatives:

Mrs. Marla Sarmento
Pedro Telxelra 8, Off. 320
Iberia Mart 1
Madrid 4, Spain
45 52 891

Mr. Andrew Karnig
Andrew Karnig & Associates
Kungsholmsgatan 10
112 27 Stockholm, Sweden
08 51 68 70

Mr. Hans Csokor
Publmedia
Reisnerstrasse 61
A-1037 Vienna, Austria

Mrs. Gurit Gepner
McGraw-Hill Publishing Co.
115 Yosephthal St.
Bat Yam, Israel
866 561 321 39

Mr. Fritz Krusebecker
McGraw-Hill Publishing Co.
Liebigstrasse 27C
D-6000 Frankfurt/Main 1
West Germany
72 01 81

Mr. Michael Sales
McGraw-Hill Publishing Co.
17 rue Georges Bizet
F 75116 Paris
France
720 33 42

Mr. Simon Smith
McGraw-Hill Publishing Co.
34 Dover St.
London W1X 3RA
England
01 493 1451

Mr. Elio Gonzaga
McGraw-Hill Publishing Co.
Via Baracchini 1
20123 Milan, Italy
86 90 617

Far East/Pacific
Seavex Ltd.
05-49/50 Tanglin Shopping Center
19 Tanglin Rd. Singapore 1024
Republic of Singapore

Seavex, Ltd.
Room 102, Yu Yuet Lal Bldg.
43-55 Wyndham St. Central
Hong Kong

BYTE READER SERVICE



FEBRUARY 1983
4123

For fastest service transfer mailer label from wrapper to coupon provided at the right. Requests cannot be honored unless zip code is given. This card valid for 90 days only.

NOTE—If label is missing or defaced fill out coupon carefully—**PLEASE PRINT**—this is the only way to get requested material to you.

Name _____

(Title) _____ (Company) _____

Address _____

City _____ State _____ Zip _____

1	21	41	61	81	101	121	141	161	181	201	221	241	261	281	301	321	341	361	381	401	421	441	461	481	501	521	541	561	581	601	621	641	661	681
2	22	42	62	82	102	122	142	162	182	202	222	242	262	282	302	322	342	362	382	402	422	442	462	482	502	522	542	562	582	602	622	642	662	682
3	23	43	63	83	103	123	143	163	183	203	223	243	263	283	303	323	343	363	383	403	423	443	463	483	503	523	543	563	583	603	623	643	663	683
4	24	44	64	84	104	124	144	164	184	204	224	244	264	284	304	324	344	364	384	404	424	444	464	484	504	524	544	564	584	604	624	644	664	684
5	25	45	65	85	105	125	145	165	185	205	225	245	265	285	305	325	345	365	385	405	425	445	465	485	505	525	545	565	585	605	625	645	665	685
6	26	46	66	86	106	126	146	166	186	206	226	246	266	286	306	326	346	366	386	406	426	446	466	486	506	526	546	566	586	606	626	646	666	686
7	27	47	67	87	107	127	147	167	187	207	227	247	267	287	307	327	347	367	387	407	427	447	467	487	507	527	547	567	587	607	627	647	667	687
8	28	48	68	88	108	128	148	168	188	208	228	248	268	288	308	328	348	368	388	408	428	448	468	488	508	528	548	568	588	608	628	648	668	688
9	29	49	69	89	109	129	149	169	189	209	229	249	269	289	309	329	349	369	389	409	429	449	469	489	509	529	549	569	589	609	629	649	669	689
10	30	50	70	90	110	130	150	170	190	210	230	250	270	290	310	330	350	370	390	410	430	450	470	490	510	530	550	570	590	610	630	650	670	690
11	31	51	71	91	111	131	151	171	191	211	231	251	271	291	311	331	351	371	391	411	431	451	471	491	511	531	551	571	591	611	631	651	671	691
12	32	52	72	92	112	132	152	172	192	212	232	252	272	292	312	332	352	372	392	412	432	452	472	492	512	532	552	572	592	612	632	652	672	692
13	33	53	73	93	113	133	153	173	193	213	233	253	273	293	313	333	353	373	393	413	433	453	473	493	513	533	553	573	593	613	633	653	673	693
14	34	54	74	94	114	134	154	174	194	214	234	254	274	294	314	334	354	374	394	414	434	454	474	494	514	534	554	574	594	614	634	654	674	694
15	35	55	75	95	115	135	155	175	195	215	235	255	275	295	315	335	355	375	395	415	435	455	475	495	515	535	555	575	595	615	635	655	675	695
16	36	56	76	96	116	136	156	176	196	216	236	256	276	296	316	336	356	376	396	416	436	456	476	496	516	536	556	576	596	616	636	656	676	696
17	37	57	77	97	117	137	157	177	197	217	237	257	277	297	317	337	357	377	397	417	437	457	477	497	517	537	557	577	597	617	637	657	677	697
18	38	58	78	98	118	138	158	178	198	218	238	258	278	298	318	338	358	378	398	418	438	458	478	498	518	538	558	578	598	618	638	658	678	698
19	39	59	79	99	119	139	159	179	199	219	239	259	279	299	319	339	359	379	399	419	439	459	479	499	519	539	559	579	599	619	639	659	679	699
20	40	60	80	100	120	140	160	180	200	220	240	260	280	300	320	340	360	380	400	420	440	460	480	500	520	540	560	580	600	620	640	660	680	700

BYTE'S BOMB

is your direct line to the editor's desk. Each month, the authors of the two top-rated articles receive bonuses based on your evaluation. First look at the list of this month's articles and corresponding article numbers (located in the unclassified ads section on the page preceding the Reader Service list), then rate each article you've read as **Excellent**, **Good**, **Fair**, or **Poor**, based on your overall impression of the article, by circling the appropriate number in each column below. Your feedback helps to produce the best possible magazine each month.

Article No.	1	2	3	4	5	6	7	8	9	10	11	12	13	14	15	16	17	18	19	20	21	22	23	24	25
Excellent	801	805	809	813	817	821	825	829	833	837	841	845	849	853	857	861	865	869	873	877	881	885	889	893	897
Good	802	806	810	814	818	822	826	830	834	838	842	846	850	854	858	862	866	870	874	878	882	886	890	894	898
Fair	803	807	811	815	819	823	827	831	835	839	843	847	851	855	859	863	867	871	875	879	883	887	891	895	899
Poor	804	808	812	816	820	824	828	832	836	840	844	848	852	856	860	864	868	872	876	880	884	888	892	896	900

Comments _____

BYTE READER SERVICE



FEBRUARY 1983
4123

For fastest service transfer mailer label from wrapper to coupon provided at the right. Requests cannot be honored unless zip code is given. This card valid for 90 days only.

NOTE—If label is missing or defaced fill out coupon carefully—**PLEASE PRINT**—this is the only way to get requested material to you.

Name _____

(Title) _____ (Company) _____

Address _____

City _____ State _____ Zip _____

1	21	41	61	81	101	121	141	161	181	201	221	241	261	281	301	321	341	361	381	401	421	441	461	481	501	521	541	561	581	601	621	641	661	681
2	22	42	62	82	102	122	142	162	182	202	222	242	262	282	302	322	342	362	382	402	422	442	462	482	502	522	542	562	582	602	622	642	662	682
3	23	43	63	83	103	123	143	163	183	203	223	243	263	283	303	323	343	363	383	403	423	443	463	483	503	523	543	563	583	603	623	643	663	683
4	24	44	64	84	104	124	144	164	184	204	224	244	264	284	304	324	344	364	384	404	424	444	464	484	504	524	544	564	584	604	624	644	664	684
5	25	45	65	85	105	125	145	165	185	205	225	245	265	285	305	325	345	365	385	405	425	445	465	485	505	525	545	565	585	605	625	645	665	685
6	26	46	66	86	106	126	146	166	186	206	226	246	266	286	306	326	346	366	386	406	426	446	466	486	506	526	546	566	586	606	626	646	666	686
7	27	47	67	87	107	127	147	167	187	207	227	247	267	287	307	327	347	367	387	407	427	447	467	487	507	527	547	567	587	607	627	647	667	687
8	28	48	68	88	108	128	148	168	188	208	228	248	268	288	308	328	348	368	388	408	428	448	468	488	508	528	548	568	588	608	628	648	668	688
9	29	49	69	89	109	129	149	169	189	209	229	249	269	289	309	329	349	369	389	409	429	449	469	489	509	529	549	569	589	609	629	649	669	689
10	30	50	70	90	110	130	150	170	190	210	230	250	270	290	310	330	350	370	390	410	430	450	470	490	510	530	550	570	590	610	630	650	670	690
11	31	51	71	91	111	131	151	171	191	211	231	251	271	291	311	331	351	371	391	411	431	451	471	491	511	531	551	571	591	611	631	651	671	691
12	32	52	72	92	112	132	152	172	192	212	232	252	272	292	312	332	352	372	392	412	432	452	472	492	512	532	552	572	592	612	632	652	672	692
13	33	53	73	93	113	133	153	173	193	213	233	253	273	293	313	333	353	373	393	413	433	453	473	493	513	533	553	573	593	613	633	653	673	693
14	34	54	74	94	114	134	154	174	194	214	234	254	274	294	314	334	354	374	394	414	434	454	474	494	514	534	554	574	594	614	634	654	674	694
15	35	55	75	95	115	135	155	175	195	215	235	255	275	295	315	335	355	375	395	415	435	455	475	495	515	535	555	575	595	615	635	655	675	695
16	36	56	76	96	116	136	156	176	196	216	236	256	276	296	316	336	356	376	396	416	436	456	476	496	516	536	556	576	596	616	636	656	676	696

PLACE
STAMP
HERE

BYTE

READER SERVICE
PO BOX 298
DALTON, MA 01226
USA

PLACE
STAMP
HERE

BYTE

READER SERVICE
PO BOX 298
DALTON, MA 01226
USA

BYTE

SUBSCRIPTIONS



4123

For a subscription to BYTE, please complete this card.

Name _____

Address _____

City _____

State _____ Zip _____ Country _____

Card No. _____

Expiration date _____

Four digits above name—Master Charge only _____

Signature _____ Date _____

Please allow eight weeks for processing. Thank you.

- | | | |
|----------------------------------|-------------------------------|-------------------------------|
| <input type="checkbox"/> 1 year | <input type="checkbox"/> \$21 | <input type="checkbox"/> \$23 |
| <input type="checkbox"/> 2 years | <input type="checkbox"/> \$38 | <input type="checkbox"/> \$42 |
| <input type="checkbox"/> 3 years | <input type="checkbox"/> \$55 | <input type="checkbox"/> \$61 |

- \$53 Europe (air delivery) payment enclosed
 \$37 Elsewhere (surface mail) payment enclosed
 (Air mail rates available upon request)

Please remit in US funds drawn on a US bank. Thank you.

- Check enclosed (**Bonus:** [North America only] one EXTRA issue—receive 13 issues for the price of 12)



- Bill me (North America only)

BYTE

SUBSCRIPTIONS



4123

For a subscription to BYTE, please complete this card.

Name _____

Address _____

State _____ Zip _____ Country _____

Card No. _____

Expiration date _____

Four digits above name—Master Charge only _____

Signature _____ Date _____

Please allow eight weeks for processing. Thank you.

- | | | |
|----------------------------------|-------------------------------|-------------------------------|
| <input type="checkbox"/> 1 year | <input type="checkbox"/> \$21 | <input type="checkbox"/> \$23 |
| <input type="checkbox"/> 2 years | <input type="checkbox"/> \$38 | <input type="checkbox"/> \$42 |
| <input type="checkbox"/> 3 years | <input type="checkbox"/> \$55 | <input type="checkbox"/> \$61 |

- \$53 Europe (air delivery) payment enclosed
 \$37 Elsewhere (surface mail) payment enclosed
 (Air mail rates available upon request)

Please remit in US funds drawn on a US bank. Thank you.

- Check enclosed (**Bonus:** [North America only] one EXTRA issue—receive 13 issues for the price of 12)

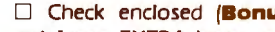

- Bill me (North America only)

*Note our special offer!
 Send cash with your order
 and receive 13 issues
 for the price of 12 for
 each year you subscribe.
 (North America only, please.)*

Don't Miss An Issue!

Have BYTE delivered to your door.

Each month BYTE will bring you the latest in microcomputer technology.

DISCOVER and IMPLEMENT new ideas. Don't miss the original information presented in the pages of BYTE.

With BYTE you'll always be among the first to know about the important breakthroughs, worthwhile new equipment, and innovative projects in the world of computing.

CHALLENGE US to deliver the very best ideas in microcomputers and advanced technology to you. Return the attached card today!

Subscribe to BYTE—the world's leading computer magazine.

PLACE
STAMP
HERE

BYTE SUBSCRIPTIONS
PO Box 590
Martinsville NJ 08836
USA

PLACE
STAMP
HERE

BYTE SUBSCRIPTIONS
PO Box 590
Martinsville NJ 08836
USA

THE LEADING EDGE IN PRINTERS

ONE GREAT LINE. ONE GREAT WARRANTY.

Finally, there's one full family of printers that covers every business or word processing application—all from C. Itoh, a company known for packing more product into less price; and all distributed exclusively by Leading Edge, a company known for searching out and providing that very thing. Which means that one call to one source can get you any printer, any time you need it, for any purpose. All backed by a full years' warranty from Leading Edge. (Try *that* on any other line of printers.)

THE PRO'S.

The Prowriters: business printers—and more. The “more” is a dot-matrix process with more dots. It gives you denser, correspondence quality copy (as opposed to business quality copy, which looks like a bad job of spray-painting).

Prowriter: 120 cps. 80 columns dot matrix compressable to 136. 10" carriage. Parallel or serial interface.

Prowriter 2: Same as Prowriter, except 15" carriage allows full 136 columns in normal print mode. Parallel or serial interface.



THE STAR.

The Starwriter F-10. In short (or more precisely, in a sleek 6" high, 30-pound unit), it gives you more of just about everything—except bulk and noise—than any other printer in its price range. It's a 40 cps letter-quality daisy-wheel with a bunch of built-in functions to simplify and speed up word processing. It plugs into almost any micro on the market, serial or parallel.



THE MASTER.

The Printmaster F-10. Does all the same good stuff as the Starwriter except, at 55 cps, the Master does it faster.

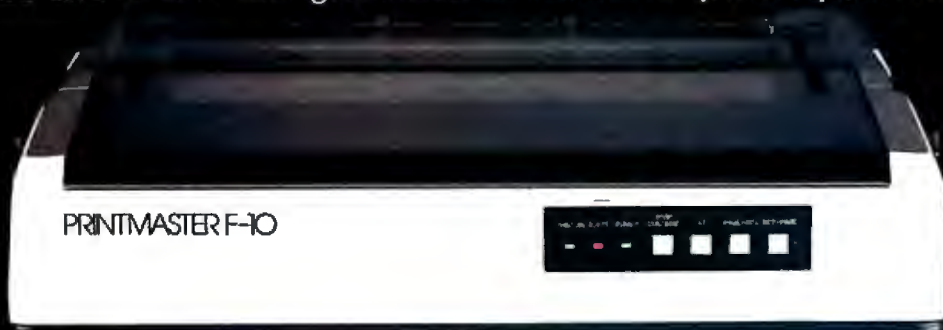

Distributed Exclusively by Leading Edge Products, Inc., 225 Turnpike Street, Canton, Massachusetts 02021.
Call: toll-free 1-800-343-6833; or in Massachusetts call collect (617) 828-8150. Telex 951-624.

Circle 229 on Inquiry card

Sale! Radio Shack Color Computer Disk Drives Now Cut 25%

1st Drive

Save \$150
Reg. 599.00
Cat. No. 26-3022
449⁰⁰

2nd, 3rd, 4th Drives

Save \$100
Reg. 399.00
26-3022
299⁰⁰ Each



If you think your Extended BASIC TRS-80® Color Computer is a great little computer (and everybody who owns one does!), just wait until you add one or more disk drives to it.

These 35-track, 5¹/₄" double-density drives will give you the high-level performance you want from your Color Computer. Each drive puts over 156K of on-line data and program storage right at your fingertips. And you can chain up to four drives together for a total of more than 626K.

Yet all that extra storage is available at an access speed that you just can't get from a cassette recorder—a seek time of 30 milliseconds (track to track) and a data transfer rate of 250 bits per second.

Best of all, our Color Disk Drives are easy to install. Just plug the controller Program Pak™ into your ROM port and you're all set. It uses only about 2K of RAM, too. And you can upgrade your TRS-80 Standard Color Computer to use disk drives with our Extended Basic ROM Kit (26-3018, \$99, plus installation charge).

New Low Prices on Color Computers!

All Are \$100 Less Than Last Year!

16K Standard BASIC Color Computer (26-3004). Now only \$299.95.

16K Extended BASIC Color Computer (26-3002). Now only \$399.95.

32K Extended BASIC Color Computer (26-3002). Now only \$549.95.

See the complete line of TRS-80 Color Computers, disk drives, programs and accessories at your nearby Radio Shack Computer Center, store or participating dealer—where complete color disk systems start at only \$848.95. But hurry—this sale ends Feb. 28, 1983.

Radio Shack®

The biggest name in little computers®
A DIVISION OF TANDY CORPORATION

Retail prices may vary at individual stores and dealers. All prices are less TV.
Reference pricing from Radio Shack Computer Catalog RSC-8.

Circle 364 on inquiry card.