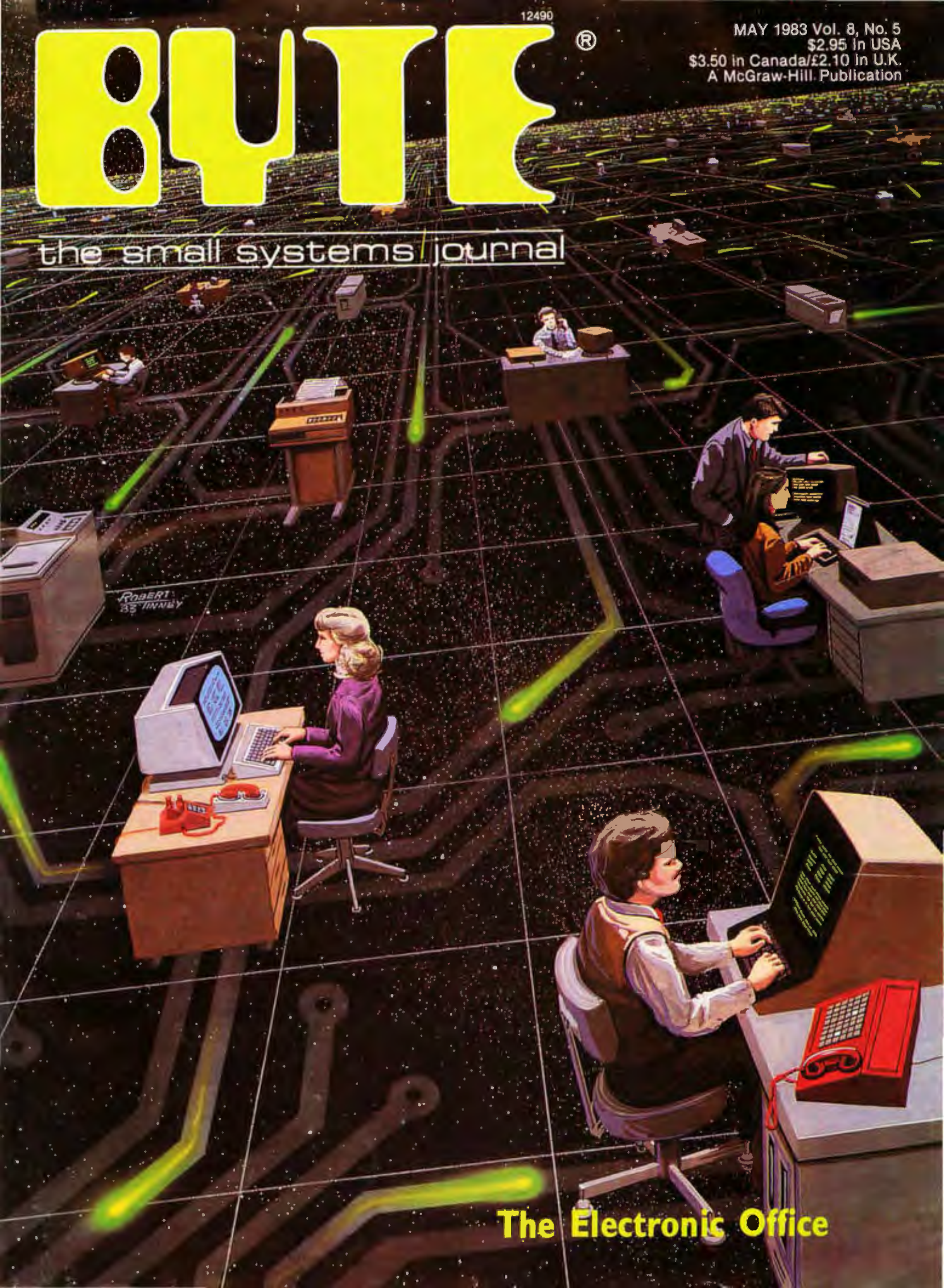


# BYTE<sup>®</sup>

MAY 1983 Vol. 8, No. 5  
\$2.95 in USA  
\$3.50 in Canada/£2.10 in U.K.  
A McGraw-Hill Publication

the small systems journal



ROBERT  
B. TINKLEY

The Electronic Office





# Inside Apple

Apple Computer Inc., 20525 Mariani Avenue, Cupertino, California 95014

Vol. 1 No. 2

For the authorized Apple dealer nearest you, call 800-538-9696 (800-662-9238 in California.)

## Fruitful Connections.

There are more people in more places making more accessories and peripherals for Apples than for any other personal computer in the world.

Thanks to those people — in hundreds of independent companies — you can make the humblest 1978 Apple II turn tricks that are still on IBM's Wish List for 1984.

But now we're coming out with our very own line of peripherals and accessories for Apple® Personal Computers.

For two very good reasons.

First, compatibility. We've created a totally kluge-free family of products designed to take full advantage of all the advantages built into every Apple.

Second, service and support.



Now the same kindly dealer who keeps your Apple PC in the pink can do the same competent job for your Apple hard-disk and your Apple daisywheel printer.

So if you're looking to expand the capabilities of your Apple II or III, remember:

Now you can add Apples to Apples.

## A joy to behold.

The new Apple Joystick II is the ultimate hand control device for the Apple II.

Why is it such a joy to use?

With two firing buttons, it's the first ambidextrous joystick — just as comfortable for lefties as righties.

Of course, it gives you 360° cursor control (not just 8-way like some game-oriented devices) and full X/Y coordinate control.

And the Joystick II contains high-quality components and switches tested to over 1,000,000 life cycles.

Which makes it a thing of beauty. And a joystick forever.



## Gutenberg would be proud.

Old Faithful Silentype® has now been joined by New Faithfuls, the Apple Dot Matrix Printer and the Apple Letter Quality Printer.

So now, whatever your budget and your needs, you can hook your Apple to a printer that's specifically designed to take advantage of all the features built into your Apple. With no compromises.

The 7x9 Apple Dot Matrix Printer is redefining "correspondence quality" with exceptional legibility.

With 144x160 dots per square inch, it can also create high resolution graphics.

The Apple Letter Quality Printer, which gets the words out about 33% faster than other daisywheel printers in its price range, also offers graphics capabilities. See your authorized Apple dealer for more information and demonstrations. Because, unfortunately, all the news fit to print simply doesn't fit.







## Up the creek without a paddle?

Or lost in space? Or down in the dungeons?

Whatever your games, you'll be happy to know that someone has finally come out with game paddles built to hold up under blistering fire. Without giving you blisters.

Apple Hand Controller II game paddles were designed with one recent discovery in mind:

People playing games get excited and can squeeze very, very hard.

So we made the cases extra rugged. We used switches tested to 3,000,000 life cycles. We shaped them for holding hands and placed the firing button on the right rear side for maximum comfort.

So you'll never miss a shot.

## A storehouse of knowledge.

If you work with so much data or so many programs that you find yourself shuffling diskettes constantly, you should take a look at Apple's ProFile™, the personal mass storage system for the Apple III Personal Computer.

This Winchester-based 5-megabyte hard disk can handle as much data as 35 floppies. Even more important for some, it can access that data about 10-times faster than a standard floppy drive.

So now your Apple III can handle jobs once reserved for computers costing thousands more.

As for quality

and reliability, you need only store one word of wisdom:  
Apple.



## Launching pad for numeric data.

Good tidings for crunchers of numerous numbers:

Apple now offers a numeric keypad that's electronically and aesthetically compatible with the Apple II Personal Computer. So you can enter numeric data faster than ever before.

The Apple Numeric Keypad II has a standard calculator-style layout. Appropriate,

because unlike some other keypads, it can actually function as a calculator.

The four function keys to the left of the numeric pad should be of special interest to people who use VisiCalc®. Because they let you zip around your work sheet more easily than ever, adding and deleting entries.

With one hand tied behind your back.





# How to buy a computer by the numbers.

Introducing the Cromemco C-10 Personal Computer. Only \$1785, including software, and you get more professional features and performance for the price than with any other personal computer on the market. We've got the numbers to prove it.

The C-10 starts with a high-resolution 12" CRT that displays 25 lines with a full 80 characters on each line. Inside is a high-speed Z-80A microprocessor and 64K bytes of on-board memory. Then there's a detached, easy-to-use keyboard and a 5¼" disk drive with an exceptionally large 390K capacity. That's the C-10, and you won't find another ready-to-use personal computer that offers you more.

But hardware can't work alone. That's why every C-10 includes software—word processing, financial spread sheet, investment planning and BASIC. Hard-working, CP/M<sup>®</sup>-based software that meets your everyday needs. Software that could cost over \$1000 some-

where else. FREE with the C-10. There's really nothing else to buy.

But the C-10's numbers tell only part of the story. What they don't say is that Cromemco is already known for some of the most reliable business and scientific computers in the industry. And now for the first time, this technology is available in a personal computer.

One last number. Call **800 538-8157 x929** for the name of your nearest Cromemco dealer, or to request literature. In California call 800 672-3470 x929. Or write Cromemco, Inc., 280 Bernardo Avenue, P.O. Box 7400, Mountain View, CA 94039. In Europe, write Cromemco A/S, Vesterbrogade 1C, 1620 Copenhagen, Denmark.

CP/M<sup>®</sup> is a registered trademark of Digital Research, Inc. All Cromemco products are serviced by TRW.



**Cromemco**  
Tomorrow's computers today

Circle 142 on Inquiry card.





### Features

- 38** *The Osborne Executive and the Executive II* by Jerry Pournelle / Adam Osborne's second and third machines come with more standard equipment, offer more options, and have a slightly larger video screen than the Osborne I
- 49** *Build an RS-232C Code-Activated Switch* by Steve Garcia / This device will let you switch between several peripherals connected to one serial port.
- 59** *The Electronic Office* by Pamela A. Clark / A short introduction to our theme articles
- 60** *Local Area Networks* by Harry Saal / The proliferation of office communication systems makes standardization all the more imperative.
- 104** *The Movable Conference* by Irving A. Lerch / Computer-moderated conferencing is not bound by time and geographic restrictions and is sure to change the structure of the executive business meeting
- 124** *Electronic Publishing: The New Newsletter* by Arthur S. Bechhoefer / How a newsletter evolved from its traditional format to a computer-accessed, interactive investment advisory service.
- 154** *Achieving Greater White-Collar Productivity In the New Office* by Randy J. Goldfield / The conversion to automated tools in an office must address many issues, especially human factors.
- 203** *Full Use of the Epson MX-80 Under Wordstar* by Neil G. Wallace / How to upgrade Version 3.2 of Wordstar to use more of the capabilities of the Epson MX-80 equipped with Grafrax-Plus.
- 232** *Stalking the East-Asian Microcomputer* by Phil Lemmons / The author chronicles his five-nation tour and reports on the state of microcomputing in East Asia as revealed by attending six electronics trade shows.
- 236** *The Japanese Microcomputer Marketplace* by Kurt Veggeberg / A short report on the current state of microcomputing in Japan
- 242** *An Inexpensive Letter-Quality Printer* by Stuart Brown / If low cost and letter quality are two of your priorities for a printer, consider this interface between a personal computer and the Olivetti Praxis 30
- 266** *BYTE West Coast: Ferment In Silicon Valley* by Phil Lemmons / Profiles of four start-up companies suggest the dynamism of the region and illustrate several ways in which firms get started.
- 272** *NAPLPS: A New Standard for Text and Graphics, Part 4: More Advanced Features and Conclusions* by Jim Fleming / A standard way to encode color mapping and animation, closing with some predictions on how NAPLPS will be used by personal computers.
- 286** *Better Software Manuals* by Dana Sohr / The quality of a product's companion documentation could make or break a sale. Tips on what constitutes a good manual.
- 298** *User's Column: Ulterior Motives, Lobo, Buying Your First Computer, JRT Update* by Jerry Pournelle / Our resident critic takes his first look at Modula 2
- 331** *The Enhanced VIC-20, Part 4: Connecting Serial RS-232C Peripherals to the VIC's TTL Port* by Joel Swank / The last in this VIC series discusses port connections
- 342** *Design Philosophy Behind Motorola's MC68000, Part 2: Data-movement, Arithmetic, and Logic Instructions* by Thomas W. Starnes / A look at the capabilities of the MC68000's instruction set
- 368** *Building a Hard-Disk Interface for an S-100 System, Part 3: Software* by Andrew C. Cruce and Scott A. Alexander / How to alter the CP/M operating system so that it will accommodate a Winchester disk drive and controller

- 402** *Using IBM's Marvelous Keyboard* by David B. Glasco and Murray Sargent III / It's a fairly simple procedure to change IBM's keyboard to the Dvorak layout, or even use the keyboard with other computers and software.
- 418** *Strongly Typed Languages* by Earl E. McCoy / Ada, Pascal, and other new languages let you define your own data types.
- 438** *The Ins and Outs of the TRS-80 Color Computer* by Colin J. Stearman / Find out how the Color Computer interfaces with the outside world.
- 452** *A Conceptual Approach to Real-Time Programming* by Craig R. Wyss / You can use various real-time programming techniques to turn a lazy computer into a real worker.
- 474** *Regression Fitting to Economic Indexes* by Dr. John R. Merrill / An Apple II program can help determine base rates of inflation through analysis of the Consumer Price Index
- 482** *Sorting Algorithms for Microcomputers* by Terry Barron and George Diehr / Programmer ingenuity and search of the existing literature can significantly improve sort performance

### Reviews

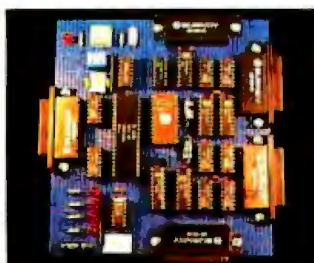
- 14** *Little Big Computer, The TRS-80 Model 100 Portable Computer* by Rich Malloy
- 82** *The Fortune 32:16 Business Computer* by Steven H. Barry
- 134** *What a Concept! A View of the Corvus Computer* by Curtis Feigel
- 176** *Word Tools for the IBM Personal Computer* by Richard S. Shuford
- 220** *A Comparison of Five Database Management Programs* by Jack L. Abbott
- 263** *Painter Power* by Chris Pappas and William H. Murray
- 426** *Solarsoft* by Winslow H. Fuller

### Nucleus

- 6** Editorial: Disenchantment with Detroit
- 8** Letters
- 326** Book Review: Microprocessor Systems, Interfacing and Applications
- 494** BYTELINES
- 499** Event Queue
- 509** Software Received
- 513** Books Received
- 515** Ask BYTE
- 521** Clubs and Newsletters
- 524** What's New?
- 589** Unclassified Ads
- 590** BOMB, BOMB Results
- 591** Reader Service



Page 38



Page 49



Page 232



Page 263



#### Editor in Chief

Lawrence J. Curran

#### Managing Editor

Pamela A. Clark

#### Senior Editor

Gregg Williams

#### Technical Editors

Richard S. Shulford, Curtis P. Feigel, Stanley Wszola, Arthur A. Little, Richard Malloy, Bruce Roberts, Philip Lemmons, West Coast Editor: Steve Ciarcia, Mark Dahmke, Consulting Editors: Jan Swanson, Drafting Editor

#### Copy Editors

Beverly Cronin, Chief; Faith Hanson, Warren Williamson, Anthony J. Lockwood, Hilary Selby Polk, Elizabeth Kepner, Nancy Hayes, Margaret Cook, Junior Copy Editor

#### Assistants

Faith Kluntz, Beverly Jackson, Lisa Jo Steiner

#### Production

David R. Anderson, Assoc. Director; Jan Muller, Virginia Reardon, Michael J. Lonsky, Sherry McCarthy, Chief Typographer; Debi Fredericks, Donna Sweeney, Valene Horn

#### Advertising

Deborah Porter, Supervisor; Marion Carlson, Rob Hannings, Vicki Reynolds, Cathy A. R. Drew, Lisa Wozmak, Patricia Akerley, Reader Service Coordinator; Wai Chiu Li, Advertising/Production Coordinator; Linda J. Sweeney

#### Circulation

Gregory Spitzfaden, Manager; Andrew Jackson, Asst. Manager; Agnes E. Perry, Barbara Varnum, Louise Menegus, Jennifer Price, Sheila A. Bamford, James Bingham, Dealer Sales, Deborah J. Cadwell, Asst. Linda Ryan

#### Marketing Communications

Horace T. Howland, Director; Wilbur S. Watson, Coordinator; Timothy W. Taussig, Graphic Arts Manager; Michele P. Verville, Research Manager

#### Business Manager

Daniel Rodrigues

#### Controller's Office

Kenneth A. King, Asst. Controller; Mary E. Fluhr, Acct. & D/P Mgr.; Karen Burgess, Jeanne Cilley, Linda Fluhr, Vicki Bennett, L. Bradley Browne, Vern Rockwell

#### Traffic

N. Scott Gagnon, Manager; Scott Jackson

#### Receptionist

Jeanann Waters

#### Personnel/Office Manager

Cheryl A. Hurd

#### Publisher

Gene W. Simpson, John E. Hayes, Associate Publisher/Production Director; Dons R. Gamble, Publisher's Assistant

Officers of McGraw-Hill Publications Company: John G. Wrede, President; Executive Vice President: Paul F. McPherson; Senior Vice President-Editorial: Ralph R. Schulz; Vice Presidents: Kemp Anderson, Business Systems Development; Shel F. Asen, Manufacturing; Harry L. Brown, Special Markets; James E. Hackett, Controller; Eric B. Herr, Planning and Development; H. John Sweger, Jr., Marketing; Officers of the Corporation: Harold W. McGraw Jr., Chairman and Chief Executive Officer; Joseph L. Dionne, President and Chief Operating Officer; Robert N. Landes, Senior Vice President and Secretary; Ralph J. Webb, Treasurer



## In This Issue

The complete and integrated electronic office is still a few years away. Yet with each new product that computerizes an individual task or an entire procedure, we move one step closer to the day when paper shuffling is just a memory. Someday, as Robert Tinney suggests in his cover painting, workers at all levels will electronically communicate with the aid of the mighty micro-processor. In "Local Area Networks" Harry Saal discusses the need for standardizing communication protocols for physically separated equipment, such as personal computers, mainframes, printers, and disk drives. Steven Barry describes "The Fortune 32:16 Business Computer," a multiuser, multitasking system that runs enhanced Unix. In "The Movable Conference" Irving A. Lerch reports on computer-moderated conferencing, and in a companion piece, "Electronic Publishing: The New Newsletter," Arthur S. Bechhoefer talks about how a traditional newsletter became a computer-accessed interactive investment advisory service. We have reviews of Radio Shack's new Model 100 portable computer and of two versions of a new computer from Osborne, the Executive and the Executive II. In "Stalking the East-Asian Microcomputer," Phil Lemmons chronicles his five-nation tour of the Far East. Steve Ciarcia's project is to "Build an RS-232C Code-Activated Switch." Plus our regular features and more reviews.

BYTE is published monthly by McGraw-Hill, Inc., with offices at 70 Main St., Peterborough NH 03458, phone (603) 924-9281. Office hours: Mon-Thur 8:30 AM - 4:30 PM, Friday 8:30 AM - Noon, Eastern Time. Address subscriptions, change of address, USPS Form 3579, and fulfillment questions to BYTE Subscriptions, POB 590, Martinsville NJ 08836. Second class postage paid at Peterborough, N.H. 03458 and additional mailing offices USPS Publication No. 528890 [ISSN 0360-5280]. Postage Paid at Winnipeg, Manitoba. Registration number 9321. Subscriptions are \$21 for one year, \$38 for two years, and \$55 for three years in the USA and its possessions in Canada and Mexico, \$23 for one year, \$42 for two years, \$61 for three years \$53 for one year air delivery to Europe, 17,100 yen for one year surface delivery to Japan, \$37 surface delivery elsewhere. Air delivery to selected areas at additional rates upon request. Single copy price is \$2.95 in the USA and its possessions, \$3.50 in Canada and Mexico, \$4.50 in Europe, and \$5.00 elsewhere. Foreign subscriptions and sales should be remitted in United States funds drawn on a US bank. Printed in United States of America.

Address all editorial correspondence to the editor at BYTE, POB 372, Hancock NH 03449. Unacceptable manuscripts will be returned if accompanied by sufficient first class postage. Not responsible for lost manuscripts or photos. Opinions expressed by the authors are not necessarily those of BYTE. Entire contents copyright © 1983 by BYTE Publications Inc. All rights reserved. Where necessary, permission is granted by the copyright owner for libraries and others registered with the Copyright Clearance Center (CCC) to photocopy any article herein for the base fee of \$1.00 per copy of the article or item plus 25 cents per page. Payment should be sent directly to the CCC, 21 Congress St., Salem MA 01970. Copying done for other than personal or internal reference use without the permission of McGraw-Hill is prohibited. Requests for special permission or bulk orders should be addressed to the publisher.

BYTE® is available in microform from University Microfilms International, 300 N Zeeb Rd., Dept PR, Ann Arbor MI 48106 USA or 18 Bedford Row, Dept PR, London WC1R 4EJ England.

Subscription questions or problems should be addressed to:

BYTE Subscriber Service  
P.O. Box 328  
Hancock, NH 03449







## Add Multi-Transparency Color Graphics to Your S-100 or Multibus System

The system builder's best choice for color graphics is a CS5000 color system from SCION. Its basic component is MicroAngelo<sup>®</sup>, the single board graphics display computer that has revolutionized monochrome display capability with low cost 512x480 pixel graphics resolution and 40 line by 85 character text capacity.

When MicroAngelo boards are combined, they create high resolution color graphics that have a unique advantage. The displayed image is a combination of transparencies. So you can add, modify or delete images by transparency rather than as an entire image.

SCION's Series CS5000 builds an image with up to 8 bit planes, each generated by a MicroAngelo board. You select the assignment of those bit planes to transparencies. Each transparency can display  $2^n - 1$  colors where  $n$  is the number of bit planes it uses... 2 bit planes would make a three color transparency, 8 bit planes would make a 255 color transparency. Once each transparency has been defined, your host can work with it independently, generating and modifying its graphics and text without interacting with the others. The independent transparencies are combined by the Color Mixer board which also assigns one of 16.8 million possible colors to each color of each transparency.



Your computer talks to the SCION Color System in SCREENWARE<sup>™</sup>, SCION's high level display firmware language. SCREENWARE commands are used by the computer in each MicroAngelo bit plane to generate graphics and text primitives. User interface is made simple with prompted system set-up using SCION's ColorPak.

MicroAngelo based color graphics systems are easy to use. Just plug the boards into your Multibus or S-100 host. Or use the freestanding work station configuration with its RS-232 interface. In each case, you get high resolution color graphics for such a low price you can't afford to design your own.

**Think SCION for your graphics display needs. Think MicroAngelo. Call us at (703) 476-6100.**

System shown is a Model CS5050S  
\*A trademark of Intel Corp.

# SCION

**if the image is important.**

12310 Pinecrest Rd./Reston, VA 22091  
(703) 476-6100 TWX: 710-833-0684

For S-100 circle 402 on inquiry card, For Multibus circle 405 on inquiry card.



## DATEBOOK IS FOR YOU



Datebook™ is an appointment scheduling program for doctors, dentists, attorneys and other professionals.

Using DATEBOOK to maintain appointments will increase office productivity by saving you or your secretary time and frustration.

DATEBOOK can schedule appointments for up to 27 different doctors, lawyers or rooms. It will search for openings that fit time of day, day of week and/or day of year constraints. Three appointment schedules are displayed on the screen at a time. Appointments are made, modified or cancelled easily. Copies of day's appointments can be printed quickly.

If you are a busy professional with time at a premium, let DATEBOOK start working for you.

DATEBOOK is \$295 and requires 56K RAM and CP/M®. Also available for CP/M-86™, Apple Pascal and UCSD Pascal™. DATEBOOK is available in many popular microcomputer formats.

**DIGITAL MARKETING**  
DIGITAL MARKETING



DIGITAL MARKETING CORPORATION

(800) 826-2222

3833 BOUTVARD CIRCLE • WALNUT CREEK • CA 94598  
(415) 947-1888 • TELEX 17-1852 (DIGMKTG WNC)

Datebook is a trademark of Organic Software.  
CP/M is a registered trademark of Digital Research, Inc.  
CP/M-86 is a trademark of Digital Research, Inc.  
UCSD Pascal is a trademark of Regents of University of California.

## Editorial

# Disenchantment with Detroit

*Lawrence J. Curran, Editor in Chief*

Signs abound that a long recession—the first to seriously affect computer manufacturers—is just about over. Anticipating upturns in demand, steel and auto makers have been recalling some employees laid off months ago. Declining oil prices cheer economists even as OPEC members gnash their teeth. Consumer prices have stabilized generally, and some economic forecasters don't expect them to rise again until the second half of the year. Amid these upbeat indicators, however, there is clear evidence that the U.S. economy may never again be able to rely on such former bellwether industries as steel and autos. Millions of American consumers are disenchanted with Detroit because they believe U.S. auto makers no longer produce the type of product they want.

A recent editorial in the *Wall Street Journal* cited studies that quantify the disenchantment. In that editorial, John Schnapp, vice-president of Harbridge House, a Boston consulting firm, reported that of the buyers of U.S. subcompact cars surveyed recently only 22 percent were completely satisfied with their autos; 41 percent of the buyers of comparable import vehicles expressed complete satisfaction. Schnapp said further that U.S. auto buyers believe that Detroit has failed to deliver on three of their foremost needs—acceptable purchase prices, fuel consumption, and maintenance costs. The editorial concludes, among other things, that “the unlikelihood of a reconciliation between Detroit and the consumer will, unfortunately, dampen the prospects for a strong and broad-based recovery” from the recession.

We agree with Schnapp, but what does all this have to do with computers? We think that the U.S. computer industry can supplant the auto industry as an economic bulwark, especially if the management of computer companies heeds the lessons of Detroit. Simply stated, Detroit fell out of favor with part of the American-car-buying public because Americans no longer believe that U.S. auto manufacturers can satisfy their need for reliable, economical transportation.

As this nation shifts from a smokestack-based economy to a high-technology-based economy, computer manufacturers will face a similar consumer challenge. Both domestic and foreign suppliers have the opportunity now to discern what buyers need and follow through on delivery. Those suppliers who don't consider consumer wants and needs in terms of economy and reliability will see that opportunity slip away. ■



# ONE



Special Introductory Prices:  
5 meg — \$1595.  
15 meg — \$2495.  
10 meg — \$1995.  
20 meg — \$2995.

# FOR ALL

## E • IBM-PC • APPLE II • TRS-80 • R

Percom Data Corporation has one hard disk drive system for just about ALL personal computers . . . including of course . . . IBM®-PC, APPLE® II, and TRS-80®. Percom Data's innovations with 5¼" Winchester technology mean that for most personal computers . . . having a reliable hard disk system is as easy as hooking up a cable.

A Percom Data PHD™ will interface with your present system . . . and your future system . . . so if you do change computers, you can still keep your most important investment . . . your Percom Data Hard Disk Drive.

Because Percom Data helped create the industry standards of today . . . new designs in software and hardware will make your selection of a Percom Data Hard Disk Drive pay off tomorrow through system compatibility.

A Percom Data PHD works to capacity because we take the time to correctly develop interface software to your computer which leaves no performance holes for you to fall into. Percom Data knows software functionality is the key to hardware performance.

Today, Percom Data PHD supports a variety of software to match your computer:

**IBM®-PC, PC DOS™ 1.1 OR 1.0**

**CP/M-86®, CONCURRENT CP/M-86™**

**APPLE®, DOS 3.3, CP/M™**

**TRS-80® MODELS III & I, DOPLUS, LDOS**

IMAGINE . . . Percom Data Winchester 5¼" technology . . . for today's computers . . . and tomorrow's.

To receive an informational booklet describing Percom Hard Disk Systems, or to determine if we have a system for your computer call our **Hard-Line Hot-Line at 1-800-527-1222.**

We will also give you the name of a nearby authorized Percom Data Dealer. Dealer inquiries are welcome.

**PERCOM DATA**  
CORPORATION

## Expanding Your Peripheral Vision

DRIVES • NETWORKS • SOFTWARE

(214) 340-7081 • 1-800-527-1222 • TELEX: 73-0401 (PERCOM)

IBM is a registered trademark of International Business Machines. APPLE is a registered trademark of Apple Computer, Inc.  
TRS-80 is a registered trademark of Tandy Radio Shack Corp. PHD is a registered trademark of Percom Data Corporation.  
COPYRIGHT 1983 PERCOM DATA CORPORATION



## Spreadsheet Programs Help to Simulate Digital Logic

I enjoyed Robert McDermott's "Simulation of Simple Digital Logic through a Computer-Aided Design System" (January 1983 BYTE, page 396). However, exactly the same results can be achieved with considerably less effort using the built-in Boolean functions of one of the popular electronic spreadsheet programs. I have not seen this application of these versatile programs described elsewhere in print.

As in McDermott's article, complex digital structures such as D or JK flip-flops can be built up out of gates, simulated by Boolean expressions. Once a library of these structures is built up, the spreadsheet program can store them, and they can be moved about and replicated to form more elaborate structures. Used this way, spreadsheet programs have the same limitations as McDermott's program: modest size and no way to handle hardware considerations such as gate propagation delay. In addition, care must be taken with feedback loops. However, for the casual user, simulating digital logic with one of these popular programs is far easier than adapting and validating McDermott's program.

Stephen R. Troy  
717 Cottonwood Dr.  
Severna Park, MD 21146

## Better Software Through Engineering

Allow me to congratulate Daniel Ross on his excellent (succinct) letter (February 1983 BYTE, page 26). I agree with him completely when he contests Jerry Pournelle's defense of software hacking.

Having spent many years hacking away at my own codes and those of my fellow hackers and watching in embarrassment the inevitable and untimely crashes of those programs, I learned painfully that hacking creates programs that are at best unreadable and at worst unreliable. The (mal)practice is so prevalent and its results so uniformly bad that software maintenance costs are astronomical, and most people have come to assume that all programs have bugs. In fact, widespread hacking undermines the technical and

ethical advancement of the software industry.

It is my contention that there will never be a credible software-engineering profession until we can guarantee the performance of our programs the same way a structural engineer guarantees that his bridge will stand. A hallmark of a professional is his legal responsibility for his product. Just as we can sue the physician for malpractice, we can sue the professional engineer if his bridge falls down. Has anyone ever tried to sue a programmer whose program did not work?

It has been my repeated experience that the only programmers who can guarantee that their codes will work are those who are skilled and disciplined enough to engineer their software. Using rigorous and systematic techniques to complement their creativity, these programmers work hard to produce a professional-quality program, a correct program, a program that can be reviewed by other professionals as well as coded in a reliable and maintainable fashion. When the profession climbs out of the mud, these people are the ones who will be able to take full, legal responsibility for the work they do. The hackers will have to find another way to make a living.

Robert B. Dial  
Comsis Corporation  
Wheaton, MD 20902

## Benchmark Surprise

In the November 1982 BYTE LINES column (see "Latest 32-Bit Microprocessor News," page 542), it was reported that someone at Berkeley had run benchmarks on several 16- and/or 32-bit microprocessors and then rated them, with a DEC VAX (what model?) being a 1.00.

Surely Intel Corporation's iAPX-432 can do better than 0.05, when the 8-MHz Motorola 68000 got a 0.6, even if the 432 was running at half the speed of the 68000. Even the 8086 at 5 MHz got into the tenths.

Thanks for the great magazine; I'll keep my subscription going forever at this rate. Tell Steve Ciarcia not to forget his MPX-16 after these first three articles; we'll be wanting more. How about a special graphics terminal, based on one of the new high-resolution chips, that could

be plugged into the MPX-16's (or IBM Personal Computer's) peripheral slots?

Rex E. Felsman  
PSC #2 Box 13508  
APO San Francisco, CA 96367

## The Sieve Revisited

We read with great interest the January 1983 BYTE article by Jim Gilbreath and Gary Gilbreath, "Eratosthenes Revisited: Once More Through the Sieve" (page 283). Of particular interest to us was the inclusion of an APL solution. We recognized that this APL was of a nonstandard syntax. Typically (per the APL of STSC, I. P. Sharp and Associates, and the ANSI APL Standards Committee), within a statement, interpretation occurs from right to left; but when there are multiple statements per line (statements are separated by the 'o' symbol), these statements are considered for interpretation from left to right. The published APL solution required right-to-left line execution.

We transposed the published APL as follows:

```
▽ THEIRAPRIME N
[1] B←I+1 ⋄ PTR←Np0
[2] L1:PR←(←PTR)/IN
[3] →(N<B×B+PR[I←I+1])/END
[4] ST:PTR←PTR▽(Bp0),B+Np,B+Np1⊕B†
[5] →L1
[6] END:PR
▽
```

We were then able to give it a try on The Upjohn Company's IBM 3081 running I. P. Sharp and Associates' Spring 1982 release of APL under the IBM MVS operating system. A couple of full runs yielded processor times of around 256 milliseconds for an N of the first 8191 integers. After looking at the resulting list of primes we noticed a few nonprimes; obviously 8190 is not prime, nor are the more subtle 8133 (79 × 103), 8159 (41 × 199), and 8189 (19 × 431).

The above results put us into a debug mode, but as is often the case, debugging turns into a rewrite. We would thus like to submit an alternate APL solution that we believe rivals (beats) the best of the compiled or interpretive languages for speed of execution and memory requirement:



# Smart. Buy.

For outstanding performance and unsurpassed value in a microprocessor-based CRT, the smart money is on the TTX-3000.

The TTX-3000 is a wizard when it comes to performance. Built-in editing permits fast, simple manipulation of text and data input. Ten dedicated function keys speed terminal operation. The 24-line, 80-character-wide display also features a 25th status line for rapid verification of communication mode.

The TTX-3000 offers a remarkable selection

of visual attributes, including blink, blank, underscore, reverse video on a per-character basis, and much more. And, with its 128 ASCII character set—including 32 displayable control codes—the TTX-3000 is compatible

with many micro, mini, and large mainframe computers.

The price? Only \$599, suggested list.

To find out more about the impressive TTX-3000 smart terminal, write or call us right now. It's the smartest move you'll ever make.



## TTX<sup>™</sup>

Teletex Communication Corporation  
3420 East Third Avenue  
Foster City, California 94404  
415/341-1300 TX: 349420

Circle 446 on Inquiry card.



```

v OURPRIME N
[1] P+NpB+1 # NS+L0.5+N#0.5
[2] L1-.(NS(B+B+(B+P)11)+L2
[3] P+P*(Bp1),B+Np-(-B)+1 # IL1
[4] L2 pP+P/1N
v
    
```

When we set our function loose on the first 8191 integers it required around 57 milliseconds to find all primes (approximating the time required for the first 10 iterations would thus be  $57 \times 10 + 57 = 22$  milliseconds). Artificially stopping our solution at 10 iterations (rather than letting it stop at the square root of N, the largest integer) produced processor times around 30 milliseconds.

Our solution reduces the execution time by:

1. working primarily with a bit string, N bits long, rather than the entire list of N integers. This reduces both the execution time and the memory requirement (note: we were able to search the list of primes up to 792353 in only 300,000 bytes of work space, including space taken up by the program).
2. working with more efficient and fewer bit-string generators and primitives, and
3. taking the square root of the ending integer (used to test end of iteration) only once before the loop rather than taking the square of each newly found integer.

We hope that we have saved the name of APL by showing that although it is an interpretive language (and our processor time represents both interpretation and execution time), it can produce a fast, memory-efficient, and succinct solution. One additional benefit is the flexibility of this solution—without modification (or recompiling, linking, or loading) it may be used to locate primes in variable lists of integers from 1 to N where  $N \leq 792353$ .

Michael C. Rowe, Ph.D.  
 Donald F. Stoneburner, Ph.D.  
 The Upjohn Company  
 7000 Portage Rd.  
 Kalamazoo, MI 49001

You might like to add the following data to your prime-number benchmark database (see the September 1981 BYTE, page 180, and the January 1983 BYTE, page 283). I ran the Sieve of Eratosthenes program on the Apple II in Micromotion

FORTH (200 seconds) and Marx C tailored for Apple DOS (400 seconds). On a Data General MV/8000, using FORTRAN 77, I got a benchmark time of 2.2 seconds.

The Marx version of C that I used employs a p-code interpreter.

John Figueras  
 65 Steele Rd.  
 Victor, NY 14564

### BCD Conversion Better by a Bit

I am a programmer specializing (for the moment) in Apples and working mostly in assembly language, and I find the machine-code program examples in your magazine a fascinating source of entertainment. I always look forward to the chance to analyze them. However, I found a few irregularities in listing 1 of Pat Coghlan and George White's "Another Binary to BCD Conversion Routine" (January 1983 BYTE, page 387). Unless the user has some code located at hexadecimal 1003, line 1440 (JMP \$1003) should be changed.

The use of indirect indexed addressing would have eliminated the need for the use of location hexadecimal 56 in lines 1740 and 1750. Line 1750 could have been replaced with ADC (BCD),Y and line 1740 could have been eliminated. This would also save two clock cycles per iteration. Also, the comments in lines 2040 and 2050 state that the incoming carry will be added to the entire BCD (binary-coded decimal) field.

The incoming carry is the most significant bit from the last state of the binary field. However, the PBCD routine (lines 2070 through 2140) deals with only the least significant byte of the BCD field. Furthermore, on the first call to this subroutine, the BCD field is cleared to zeros, and for all other calls the BCD field has just been added to itself. This means that the BCD field will be either zero or an even number, and in either case the least significant bit will be zero.

Because the maximum value added to the BCD field by this routine is one and the least significant bit is always zero, no carry is ever possible. The BCC (branch on carry clear) following the add will always be taken. This causes the BPL (branch on sign flag equals zero) in line 2130 to be always bypassed. I have implemented this routine with the indirect

indexed addressing in line 1750 and with lines 2120 and 2130 deleted, and the routine still seems to work accurately.

Carl Haddick  
 Rte. 1, Box 215  
 Mexia, Texas 76667

### Apples and Fords

In the letters column of the February 1983 BYTE (see page 24), Fred K. Fox draws an analogy between the Model T Ford and the microprocessors of today. I found an automotive approach relevant to the Apple IIe and Lisa computers reviewed in that issue.

Apple's Jobs and Wozniak (like Henry Ford) detected a huge, untapped market and produced a general-purpose machine. With little competition, it swept the field. As the public got used to the new machine, however, people began to develop more focused ideas about what they wanted from it. Other makers brought out models designed to deliver specific packages of features to specific market segments, at prices tailored to the market.

But Ford and Apple misread the resulting erosion of their markets as a need to incorporate the specific features of their competitors into their "universal" machines. Hence Ford tinkered with the Tin Lizzie, and Apple came up with the Apple II Plus and now the Apple IIe. But still, when most people look at the market, there always seems to be a specialized machine that delivers features a little better suited to their specific needs, and/or at a little better price. The machine that sets out to be a jack-of-all-trades winds up being the master of none.

Lisa, on the other hand, seems analogous to the DeLorean. Both were designed as "machines of the future," embodying all sorts of bells and whistles that technophiles had been daydreaming about for some time. Most people agree that they're mighty fine machines, with features that it would sure be nice to have. Then they look at the price. After picking their jaws up off the showroom floor, they decide that they can somehow live another few years without those features, and go buy some other model.

Erwin S. Strauss  
 9850 Fairfax Square #232  
 Fairfax, VA 22031 ■





# TOUGH TO OUTGROW

It's no surprise so many businesses today are using our CompuStar<sup>®</sup> multi-user microcomputer. All sorts of businesses, those at the top and those on the way, know that only CompuStar can give them the big system performance they'll need as they grow. And they know that *only* CompuStar can deliver that performance at a fraction of the cost of most other systems.

CompuStar<sup>®</sup> solves the small business computer dilemma. It's ideal for those first time business users who need only single-user capability. But it's also perfect when those small businesses grow into large corporations. That's because CompuStar is *truly* expandable... all the way up to 255 workstations, each with its own processor and internal computer memory. And that means fast, fast response, even when many users are on-line at the same time.

Whether you're a small business with big plans or a big business with an eye for economy, CompuStar<sup>®</sup> has the performance and versatility that's tough to outgrow... the price/performance ratio that's impossible to beat!

## STANDARD FEATURES

- 350K/750K/1.5 MB workstation disk capacities
- 64K RAM and twin processors in each workstation
- An easy-to-read 12-inch non-glare screen
- Operator convenience features—numeric keypad and visual text highlighting
- Microsoft<sup>®</sup> Basic
- CP/M<sup>†</sup> operating software
- Truly multi-user and multi-processor

## STORAGE OPTIONS

- 10 MB—compact, low-cost and tabletop
- 96 MB—80 fixed and 16 removable megabytes
- 144 MB—reliable, rugged Winchester storage

CompuStar<sup>®</sup> is built and backed by the company that's been in the microcomputer business as long as microcomputers have been in business. Would you trust your business to anything less? CompuStar<sup>®</sup>. Tough to beat. Tough to outgrow!

Microsoft is a trademark of Microsoft Corp.  
†Registered trademark of Digital Research.

**INTERTEC  
DATA  
SYSTEMS<sup>®</sup>**

CORPORATE HEADQUARTERS: 2300 BROAD RIVER ROAD • COLUMBIA, SOUTH CAROLINA 29210 • (803) 798-9100 • TWX 810-666-2115



# MICROHOUSE

## NEW LOWER PRICES!

We made business computing affordable.

### WORDPROCESSING

<b>WORDSTAR</b> .....	<b>MICROPRO</b>	<b>\$279</b>
MAILMERGE .....		149
SPELLSTAR .....		149
FINAL WORD .....		199
<b>MATH*</b> .....	<b>FORCE II</b>	<b>\$89</b>
<b>SUPERWRITER</b> .....	<b>SORCIM</b>	<b>\$249</b>
SPELLGUARD .....		129
<b>VISIWORD</b> .....	<b>VISICORP</b>	<b>CALL!</b>
<b>VISISPELL</b> .....		<b>CALL!</b>
<b>PERFECT WRITER</b> .....	<b>PERFECT SOFTWARE</b>	<b>\$199</b>
PERFECT SPELLER .....		139
<b>WORD HANDLER</b> .....	<b>SILICON VALLEY</b>	<b>\$139</b>
LIST HANDLER .....		69
<b>VOLKSWRITER</b> .....	<b>LIFETREE</b>	<b>\$155</b>
<b>T/MAKER III</b> .....	<b>T/MAKER</b>	<b>\$199</b>

### LANGUAGES

<b>APPLESOFT COMPILER</b> .....	<b>MICROSOFT</b>	<b>\$129</b>
ALDS .....		99
BASIC COMPILER .....		289
BASIC INTERPRETER .....		259
EDIT 80 .....		89
FORTRAN 80 COMPILER .....		149
FORTRAN 80 COMPILER .....		349
COBOL COMPILER .....		549
COBOL COMPILER .....		528
MACRO ASSEMBLER .....		199
MULISP / MUSTAR .....		149
MULISP / MUSTAR .....		189
MUMATH / MUSIMP .....		189
<b>ADA</b> .....	<b>SUPERSOFT</b>	<b>\$189</b>
<b>C COMPILER</b> .....		<b>159</b>
FORTRAN .....		239
FORTH .....		129
LISP .....		99
RATFOR .....		69

### APPLE HARDWARE

<b>MICROSOFT PREMIUM PACK</b> .....	<b>MICROSOFT</b>	<b>\$489</b>
280 CARD .....		249
MICROSOFT 280 CARD / VIDEX VIDEOTERM .....		499
MICROSOFT 16K RAM .....		74
<b>MULTI I/O</b> .....	<b>MOUNTAIN</b>	<b>178</b>
<b>SUPERFAN</b> .....	<b>M&amp;R</b>	<b>39</b>
<b>ELITE I</b> .....	<b>RANA</b>	<b>\$299</b>
CONTROLLER FOR ELITE I .....		99
ELITE I PLUS .....		395
ELITE II .....		465
ELITE II PLUS .....		539
ELITE III .....		599
<b>ENHANCER II</b> .....	<b>VIDEX</b>	<b>\$129</b>
SOFTSWITCH .....		29
VIDEOTERM .....		269
FUNCTION STRIP .....		68
VIDEOTERM / SOFTSWITCH .....		295
VIDEOTERM / SOFTSWITCH / INVERSECHIP .....		299

### COMPUTERS

<b>IMS</b> .....	<b>CALL!</b>
<b>CALIFORNIA COMPUTER SYSTEM</b> .....	<b>CALL!</b>
<b>MORROW MICRODECISION</b> .....	<b>CALL!</b>

### MEDIA

<b>5" SINGLE SIDED</b> .....	<b>MAXELL</b>	<b>\$31</b>
<b>5" DOUBLE SIDED</b> .....		<b>48</b>
<b>8" SINGLE SIDED</b> .....		<b>49</b>
<b>8" DOUBLE SIDE</b> .....		<b>49</b>
MAXELLS ARE BOTH SINGLE AND DOUBLE DENSITY AND COME WITH A LIFETIME WARRANTY.		
<b>5" 5SSD</b> .....	<b>ELEPHANT</b>	<b>\$22</b>
<b>5" DSDD</b> .....		<b>50</b>

### FINANCIAL / BUSINESS

<b>SUPERCALC</b> .....	<b>SORCIM</b>	<b>\$189</b>
<b>SUPERCALC II</b> .....		<b>219</b>
<b>VISICALC</b> .....	<b>VISICORP</b>	<b>\$179</b>
<b>VISICALC APPLE IIE</b> .....		<b>179</b>
<b>VISICALC BUSINESS FORECASTING</b> .....		<b>89</b>
<b>VISICALC ADVANCED</b> .....		<b>CALL!</b>
<b>VISISCHEDULE</b> .....		<b>228</b>
<b>VISITREND / PLOT</b> .....		<b>228</b>
<b>DESKTOP PLAN</b> .....		<b>179</b>
<b>DESKTOP PLAN</b> .....		<b>228</b>
<b>BOTTOM LINE STRATEGIST</b> .....	<b>ASHTON TATE</b>	<b>279</b>
<b>HOME ACCOUNTANT</b> .....	<b>CONTINENTAL</b>	<b>\$59</b>
<b>HOME ACCOUNTANT PLUS</b> .....		<b>109</b>
<b>FILING, CATALOGING AND MAILING</b> .....	<b>APPLE</b>	<b>69</b>
<b>FCM IBM</b> .....		<b>99</b>
<b>TAX ADVANTAGE</b> .....		<b>42</b>
<b>ACCOUNTS RECEIVABLE</b> .....		<b>169</b>
<b>ACCOUNTS PAYABLE</b> .....		<b>169</b>
<b>GENERAL LEDGER</b> .....		<b>169</b>
<b>PAYROLL</b> .....		<b>169</b>
<b>PROPERTY MANAGEMENT</b> .....		<b>458</b>
<b>PERFECT CALC</b> .....	<b>PERFECT SOFTWARE</b>	<b>\$139</b>
<b>SCRATCHPAD</b> .....	<b>SUPERSOFT</b>	<b>\$199</b>
<b>MONEY DECISIONS</b> .....	<b>EAGLE</b>	<b>\$99</b>
<b>ACCOUNTING SERIES</b> .....	<b>PEACHTREE</b>	<b>CALL!</b>

### PRINTERS, ETC.

<b>PROWRITER (P)</b> .....	<b>C. ITOH</b>	<b>\$399</b>
<b>PROWRITER (S)</b> .....		<b>579</b>
<b>PROWRITER II (P)</b> .....		<b>689</b>
<b>PROWRITER II (S)</b> .....		<b>739</b>
<b>F-10 (P)</b> .....		<b>1379</b>
<b>F-10 (S)</b> .....		<b>1379</b>
<b>F-10 TRACTOR OPT.</b> .....		<b>229</b>
<b>GX-100P</b> .....		<b>250</b>
6 MONTHS WARRANTY. MICROHOUSE IS AN AUTHORIZED C. ITOH REPAIR CENTER.		
<b>MICROPRISM</b> .....	<b>IDS</b>	<b>\$679</b>
<b>PRISM 80 / SPRINT</b> .....		<b>999</b>
<b>PRISM 132 / SPRINT</b> .....		<b>1279</b>
<b>GRAPHICS OPTION</b> .....		<b>89</b>
<b>SHEET FEEDER</b> .....		<b>139</b>
<b>COLOR OPTION</b> .....		<b>339</b>
<b>GEMINI 10</b> .....	<b>GEMINI</b>	<b>\$399</b>
<b>GEMINI 15</b> .....		<b>529</b>
<b>MICROFAZER 16K P-P</b> .....	<b>QUADRAM</b>	<b>\$159</b>
<b>32K P-P</b> .....		<b>189</b>
<b>64K P-P</b> .....		<b>239</b>
<b>8K P-P</b> .....		<b>189</b>
<b>128K P-P</b> .....		<b>349</b>
<b>256K P-P</b> .....		<b>699</b>
MANY OTHERS AVAILABLE—CALL FOR PRICES		
<b>77-10 SRO</b> .....	<b>NEC</b>	<b>\$2499</b>
<b>77-30 PRO</b> .....		<b>2499</b>
<b>35-10 SRO</b> .....		<b>1595</b>
<b>35-50 RO</b> .....		<b>2099</b>
<b>35-50 SHEET FEEDER</b> .....		<b>989</b>
<b>35-50 TRACTOR</b> .....		<b>239</b>
<b>MICROLINE 80</b> .....	<b>OKIDATA</b>	<b>\$359</b>
<b>MICROLINE 82A</b> .....		<b>439</b>
<b>MICROLINE 83A</b> .....		<b>679</b>
<b>MICROLINE 84P</b> .....		<b>1159</b>
<b>MICROLINE 92</b> .....		<b>549</b>
<b>MICROLINE 93</b> .....		<b>989</b>
<b>TRACTOR FOR 80 &amp; 82</b> .....		<b>239</b>
<b>TP-1</b> .....	<b>SMITH-CORONA</b>	<b>\$599</b>
<b>TRACTOR FOR TP-1</b> .....		<b>139</b>
<b>PKASSO</b> .....	<b>INTERACTIVE STRUCTURES</b>	<b>\$135</b>
<b>KASSO PRISM COLOR</b> .....		<b>155</b>
<b>MICROBUFFER II (P) 32K</b> .....	<b>PRACTICAL PERIPHERALS</b>	<b>229</b>
<b>GRAPPLER PLUS</b> .....	<b>ORANGE MICRO</b>	<b>\$123</b>

### DATABASE / GRAPHICS

<b>1-2-3</b> .....	<b>LOTUS</b>	<b>CALL!</b>
<b>INFOSTAR</b> .....	<b>MICROPRO</b>	<b>\$279</b>
<b>DATASAR</b> .....		<b>165</b>
<b>REPORTSTAR</b> .....		<b>219</b>
<b>SUPERSORT</b> .....		<b>149</b>
<b>DBASE II / ZIP</b> .....	<b>ASHTON TATE</b>	<b>\$489</b>
<b>QUICKCODE</b> .....	<b>FOX &amp; GELLER</b>	<b>\$219</b>
<b>DUTIL</b> .....		<b>68</b>
<b>D GRAPH</b> .....		<b>219</b>
<b>TIM III</b> .....	<b>INNOVATIVE</b>	<b>\$359</b>
<b>FAST GRAPHS</b> .....		<b>189</b>
<b>THE ANSWER</b> .....	<b>NORTH AMERICAN</b>	<b>\$228</b>
<b>PERFECT FILER</b> .....	<b>PERFECT SOFTWARE</b>	<b>\$199</b>
<b>MATHEMAGIC</b> .....	<b>ISM</b>	<b>\$69</b>
<b>GRAPHMAGIC</b> .....		<b>69</b>
<b>MATHEMAGIC / GRAPHMAGIC</b> .....		<b>99</b>
<b>THE CREATOR FOR IBM</b> .....	<b>SOFTWARE TECHNOLOGY</b>	<b>224</b>
<b>THE CREATOR FOR APPLE</b> .....		<b>149</b>
<b>VISIDEX</b> .....	<b>VISICORP</b>	<b>\$179</b>
<b>VISIFILE</b> .....		<b>228</b>
<b>VISIPILOT</b> .....		<b>159</b>
<b>VISILINK</b> .....		<b>184</b>

### COMMUNICATIONS

<b>CROSSTALK</b> .....	<b>MICROSTUFF</b>	<b>\$119</b>
<b>VISITERM</b> .....	<b>VISICORP</b>	<b>\$79</b>
<b>SMARTMODEM</b> .....	<b>HAYES</b>	<b>214</b>
<b>SMARTMODEM 1200</b> .....		<b>549</b>
<b>MICROMODEM II</b> .....		<b>279</b>
<b>MICROMODEM II W/ TERMINAL</b> .....		<b>343</b>
<b>SMARTMODEM / CROSSTALK</b> .....		<b>329</b>
<b>SMARTMODEM 1200 / CROSSTALK</b> .....		<b>659</b>
<b>J-CAT</b> .....	<b>NOVATION</b>	<b>\$129</b>
<b>SMARTCAT 300</b> .....		<b>199</b>
<b>SMARTCAT 1200</b> .....		<b>489</b>

### MONITORS

<b>COLOR I</b> .....	<b>AMDEK</b>	<b>\$329</b>
<b>COLOR II</b> .....		<b>739</b>
<b>COLOR III</b> .....		<b>429</b>
<b>APPLE RGB INT.</b> .....		<b>149</b>
<b>VIDEO 300</b> .....		<b>149</b>
<b>VIDEO 300 AMBER</b> .....		<b>169</b>
<b>VIDEO 310</b> .....		<b>179</b>
<b>VIDEO 310 AMBER</b> .....		<b>179</b>
<b>COLOR IV</b> .....		<b>1099</b>
<b>12" GREEN</b> .....	<b>NEC</b>	<b>149</b>
<b>12" COLOR</b> .....		<b>249</b>
<b>12" GREEN HI RES.</b> .....		<b>174</b>
<b>12" RGB COLOR</b> .....		<b>859</b>

### IBM HARDWARE

<b>QUADBOARD 64K</b> .....	<b>QUADRAM</b>	<b>\$459</b>
<b>QUADBOARD 128K</b> .....		<b>599</b>
<b>QUADBOARD 192L</b> .....		<b>699</b>
<b>QUADBOARD 256K</b> .....		<b>779</b>
<b>SERIAL ADAPTER</b> .....		<b>84</b>
<b>PARALLEL PRINTER INT.</b> .....		<b>119</b>
<b>64K MEMORY UPGRADE</b> .....		<b>129</b>
<b>64K RAMCARD</b> .....	<b>MICROSOFT</b>	<b>259</b>
<b>128K RAMCARD</b> .....		<b>389</b>
<b>192K RAMCARD</b> .....		<b>519</b>
<b>256K RAMCARD</b> .....		<b>659</b>
<b>SINGLE SIDED</b> .....	<b>TANDON</b>	<b>195</b>
<b>DOUBLE SIDED</b> .....		<b>249</b>

Call Toll-Free: 1-800-523-9511

In Pennsylvania: 1-215-868-8219



# BUSINESS SOFTWARE FOR LESS.

## PEACHTEXT 5000

THE NEW GENERATION WORDPROCESSOR FEATURING **PROOFREADER** (SPELLING), **RANDOM HOUSE THESAURUS**, **PEACHCALC**, DATA LIST MANAGER, ALL IN ONE & ALL FOR A GREAT PRICE. CALL FOR ADDITIONAL FEATURES.

LIST PRICE: \$395.00

## PEACHTREE SOFTWARE

MICROHOUSE PRICE: **\$249.00**

## INFOSTAR

Micropro's Database Management System not only combines the already renowned features of Datasort and Supersort but also features a report generator. This means you can enter, sort, retrieve, organize, and print data quickly and easily...and with no need to program! But that's not all...you can edit your reports with Wordstar.

LIST PRICE: \$495.00

MICROHOUSE PRICE: **\$279.00**

## dBASE II / ZIP

A powerful, yet easy-to-use data management system. In constructing and manipulating numeric and character information files, you CREATE databases, APPEND new data, UPDATE, MODIFY and REPLACE fields, records and entire data bases. Its special feature allows you to SORT, EDIT, or DISPLAY a database directly from the keyboard, or program menus and programs to support your specific applications.

LIST PRICE: \$700.00

## ASHTON-TATE

MICROHOUSE PRICE: **\$529.00**

## ACCOUNTING PLUS

A field proven, fully-integrated accounting system offering eight modules, all operating on both CP/M and MP/M. Available modules include General Ledger, Accounts Receivable, Sales Order Entry, Accounts Payable, Purchase Order Entry, Inventory, Payroll, and Point of Sale. Accounting Plus II for Apple II.

## SYSTEMS PLUS, INC.

CALL FOR CONFIGURATION AND PRICING!

## MEDICAL MANAGER

The MEDICAL MANAGER is a powerful office management tool for running all the accounting functions of today's medical office. This menu driven program can maintain multiple doctor practices, generate all financial reports, allow automatic third party insurance billing and has password protection for data security. Every medical practice should have this valuable program.

LIST PRICE: \$3500.00

MICROHOUSE PRICE: **CALL!**

## MEMORY SHIFT

With MEMORY SHIFT you assign specific amounts of memory to 9 partitions or screens all of which can contain a different program. Say you're typing a document in a wordprocessor and you'd like to include some calculations. Simply push a key and call up screen 6 which contains your spreadsheet. Do your calculations and automatically incorporate them into your document. IT'S LIKE HAVING 9 IBM'S IN ONE. CALL MICROHOUSE FOR MORE INFORMATION!

## NORTH AMERICAN BUSINESS SYSTEMS, INC.

MICROHOUSE PRICE: **\$95.00**

CP/M is a registered trademark of Digital Research Inc., IBM is a registered trademark of International Business Machines, Apple is a registered trademark of Apple Computers. Prices may vary with different formats. Not all programs are available for all formats. All prices and specifications are subject to change without notice. Please call or write for specifics.

DEALERS INQUIRIES WELCOME

FOR TECHNICAL SUPPORT CALL 215-868-4133.

## SPECIAL PACKAGES \$\$

	COMBINED LIST PRICE	MICROHOUSE PRICE
WORDSTAR / MAILMERGE / SPELLSTAR	\$945.00	<b>\$444.00</b>
WORDSTAR / MAILMERGE	695.00	<b>349.00</b>
WORDSTAR / MAILMERGE / INFOSTAR	1190.00	<b>589.00</b>
dBASE II / DUTIL	799.00	<b>555.00</b>
dBASE II / DUTIL / QUICKCODE	1094.00	<b>679.00</b>
dBASE II / QUICKCODE	995.00	<b>599.00</b>
GRAPHMAGIC / VISICALC	339.00	<b>249.00</b>
WORDHANDLER / LISTHANDLER	289.00	<b>199.00</b>
FASTGRAPH / VISICALC	545.00	<b>345.00</b>

# MICROHOUSE



Your Micro-Computer People!

1444 Linden St./P.O. Box 499, Dept. 201, Bethlehem, PA 18016

Circle 306 on inquiry card.



## Little Big Computer

### The TRS-80 Model 100 Portable Computer

Rich Malloy, Technical Editor

Way back in 1977, Radio Shack introduced the TRS-80 Microcomputer System, a computer we now know as the Model I. It was not the first microcomputer to become available, but it was one of the first *complete* computer systems to be offered to the general public. The Model I subsequently spawned a whole line of microcomputers. The familiar gray-and-black motif became a standard feature of small businesses all over the country, and *Radio Shack* became one of the country's leading computer manufacturers. Now, six years after the Model I, Radio Shack releases the TRS-80 Model 100 (see photo 1), which by its small size, its off-white color, and its easy-to-use features seems to signal a new direction for the Texas company, a direction that may prove to be as significant as that of the original Model I.

In brief, the Model 100 is a big computer in a little package. It features a large (8-line by 40-character) LCD (liquid-crystal display), a standard-size keyboard, a low-power version of the 8085 microprocessor, 32K bytes of ROM (read-only memory), 8 to 32K bytes of RAM (random-access read/write memory), and a cassette interface. It also includes a built-in direct-connect modem with auto-dial and auto-log-on capabilities, an RS-232C serial port, a parallel printer port, a real-time clock/calendar, and even an interface for a bar-code reader. And that's just the hardware. The built-in software includes an easy-to-use text editor, a Microsoft BASIC interpreter, a communications program for the modem, and an address-book and appointment-schedule program. This all comes in a box that weighs less than 4 pounds and is smaller

than the manual for the Model I. The price ranges from \$799 to \$1134, depending on the amount of memory you need. Overall, this is a well-designed, integrated machine that should prove to be very useful to a large number of people.

The Model 100 is not perfect for everyone, however. Serious hardware hackers will be frustrated by the inability to swap boards. Software enthusiasts will want more RAM and some disk storage. And professional writers will need a larger display and a lot more memory. Taken in its own context, however, the Model 100 is an extremely successful design. It should be quite useful for three groups: businesspeople who need a portable workstation, advanced computer users who need a portable terminal for their main system, and



Photo 1: The TRS-80 Model 100 Portable Computer.



# Test drive our mouse.

It's no secret. This is certainly "The Year of the Mouse."

And the uproar is justified.

This "see and point" interface is the most natural, powerful and efficient way to interact with your computer.

And Mouse Systems' optical PC Mouse, now available with software support for the IBM PC, is easily the best of its breed; easily the best at making your computer user-friendly.

## Grasp The Future of PC Technology

Slide our PC Mouse across its deskpad. It's optical. There are no moving parts. Your cursor instantly moves across your CRT in response.

No other device gives you such total, accurate control over cursor positioning.

The ergonomically designed PC Mouse is so smooth and natural in its movements, you'll soon be using it almost subconsciously.

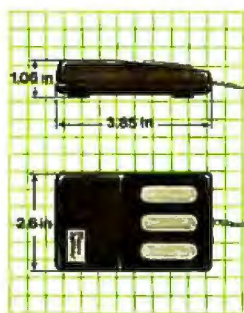
Your attention can thus remain on the screen and not on the keyboard, and your concentration will be increased dramatically.

PC Mouse lets you use this new freedom to take full advantage of today's "visual" software products.

(For a truly enlightening experience, ask your dealer to demo PC Mouse with IBM's Personal Editor.)

## PC Mouse vs. The Keyboard

Named Mini/Micro's most significant new product of 1982, PC Mouse lets you bypass your keyboard



*Slim, compact size allows brisk moves in any direction.*



for instant menu selection and function activation.

And PC Mouse requires no changes in your existing software. All cursor-related functions in Wordstar, VisiCalc, and other popular programs are replaced by the mouse.

In one darting stroke, you eliminate the pondering and second-guessing of typing complicated command codes.

For systems designers and OEM's PC Mouse's potential is staggering.

## Simplicity, Itself

Just attach the PC Mouse to your PC's RS-232 port.

Each of the three buttons is user-programmable, giving you nine different functions at your fingertips.

And our software compatibility assures instant system integration and simple start up.

## Get It Now

PC Mouse is immediately available for \$332.00 including control software and all necessary hardware for your IBM PC.

For ambitious software developers, the optional \$40.00 MouseWindow™ software package includes routines to do high resolution graphics and "pop-up" windows.

An OEM version of PC Mouse can also be supplied in quantity now, configured to your custom specifications.

For more details see your dealer, or contact Mouse Systems at 2336H Walsh Avenue, Santa Clara, CA 95051. Telephone (408) 988-0211 or Telex 467848.



*PC Mouse keeps your attention on your data, not on your keyboard.*

# Mouse Systems

Making Computers User Friendly.

Circle 317 on Inquiry card.



Photo 2: A close-up of the liquid-crystal display of the Model 100. The display size is 8 lines by 40 characters (64 by 240 pixels).

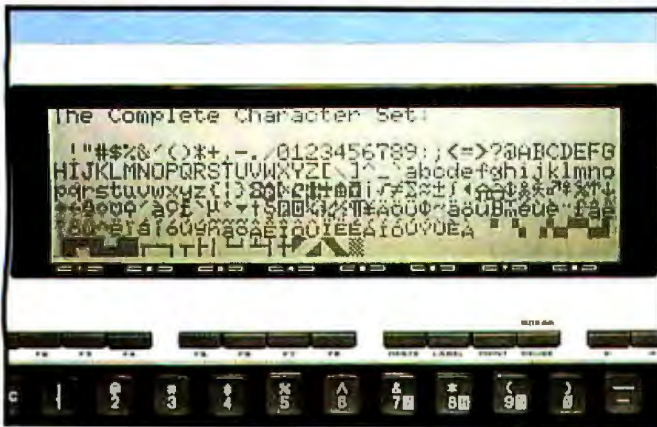


Photo 3: The complete character set of the Model 100.



Photo 4: The Model 100's keyboard.

novices who want to experiment with a useful, powerful computer for a fairly modest cost.

### Physical Dimensions

Because desk space tends to get crowded and briefcases rapidly fill, the size of a portable computer is a key factor. As for the Model 100, if you can make space for a standard 3-ring binder, you have more than enough room for this machine. The dimensions are 11 $\frac{1}{8}$  by 8 $\frac{3}{4}$  by 2 inches, similar to the Epson HX-20. The weight is 3 pounds, 14 ounces.

The computer's case is off-white, a color that is becoming popular with Radio Shack. The top of the unit shows the display, a low-battery indicator, and the keyboard. On the right side are an on/off switch, a dial for adjusting the LCD's brightness, and an AC adapter connector. On the left side are the bar-code-reader connector and two switches for the modem (direct/acoustic and originate/

answer). The rear panel contains the phone connector, the cassette connector, a printer connector, an RS-232C connector, and a well-protected Reset button. The bottom of the unit features the battery compartment, a compartment for an expansion ROM module and an external bus connector, and a RAM power switch (to be turned off only when the machine will not be used for an extended period).

### The Display

The first thing you notice about the Model 100, besides its size, is the LCD shown in photo 2. The Model 100 can display 8 lines of 40 characters each. That's a little less than half of the typical home computer screen. It also can display graphics with a resolution of 240 by 64 pixels. Each character is composed of a 5- by 7-pixel area. Lowercase descenders on letters such as p and q make use of the row of pixels below the character area that is normally used to separate lines. The bottom line of charac-



**EXTRA****EXTRA**

# S-100 World News

MACROTECH International Corporation

22133 Cohasset Street, Canoga Park, California 91303 • 213-887-5737



Image achieved by DGS' CAT 1600 Series color video graphic workstation. Picture courtesy of Digital Graphic Systems, Inc. See story below.

## GRAPHICS: NOW MAX-IMIZED

CANOGA PARK—March 30, 1983—The decreasing costs and increasing density of memory made possible the present boom in digital graphics. Graphic systems designers are now able to take another major step with the introduction of MAX-M, a one megabyte memory board for \$1983. As large size system memory and multi-megabyte Virtual Disk, MAX-M opens up major new low cost implementations.



Wayne Maw, Director of R&D for RGB Dynamics, Salt Lake City, Utah, reports, "My application is dependent on speed. With the Macrotech dynamic board, I have the needed speed." The RGB system is a Z80-based,

high resolution color directory system for shopping malls, due for April release.

Empirical Research Group of Kent, Washington, creates a state-of-the-art high resolution color video graphics system by integrating their fast 68000 computer, Macrotech system memory, and the color video image processor from Digital Graphic Systems, Inc., Palo Alto, California. Radcliffe Goddard of Digital Graphics states, "High speed image processing requires large system memory to provide instantaneous display frame paging."

The demand for MAX-M by the graphics industry was nearly instantaneous following the initial Macrotech announcement. ■

## MAX—256K to 1M S-100 Memory

CANOGA PARK—March 30, 1983—Mike Pelkey, Macrotech International president, today released details of the revolutionary MAX line of S-100 memory boards. Pelkey stated: "IEEE-696 now has a new standard for dynamic memory. The MAX product line offers 256K to 1M, at a price that ranges down to less than \$0.00023 per bit." Pelkey continued, "The MI product line now includes our ultra fast (70 ns) 128K static memory, with battery backup capability, plus the 150 ns dynamic memories—in every 128K step from 256K through 1M (1024K) bytes, and add-on kits to permit field upgrade of sizes."

The extreme density of the MAX family is made possible through the use of proprietary PALs (programmable array logic). Also stated as available for add-on to any size MAX is

Macrotech's popular M<sup>3</sup> memory mapping architecture. M<sup>3</sup> permits the 16-bit address space of an 8-bit processor to be dynamically mapped in 4K pages into as much as 16 megabytes of physical memory.

Parity error detection and 8/16 bit data transfer capabilities are provided as standard on the MAX series memory board. ■

## Software for M<sup>3</sup> Available

BURBANK—March 30, 1983—"M<sup>3</sup> bank switching for 8-bit processors is much more useful with the new creative systems programs," states Dan West of Westcom Systems Inc. MP/M II\* disk intensive applications are greatly improved with the new Virtual Disk routines now available through Macrotech OEM's and dealers for their M<sup>3</sup> memory boards.

Westcom Systems, as the software consulting firm for Macrotech, has also provided subroutine listings to easily incorporate M<sup>3</sup> mapping into the new CP/M 3.0\* (CP/M Plus\*) Bios module. The advantages of CP/M 3.0\* with disk buffering, hashed directories, and user program expansion go hand in hand with Macrotech's flexible "bank switched" memory capabilities.

**All Macrotech software and manuals are available through Dan West's CompuServe account #70250,102. Leave comments/questions as E-Mail.**

These new techniques can combine the above features with custom needs of the future, such as printer buffering, multi-page display and memory-intensive graphics displays.

The software listings are included in the Macrotech memory board manuals and are optionally available on 8" diskettes. ■

### PRICE INDEX

	SIZE	P/N	PRICE
<b>Static Memory</b>	128K	128-ST	\$1232
<b>Dynamic Memory</b>	256K	MAX-256	\$1108
<b>24-bit</b>	384K	MAX-384	1292
<b>Addressing</b>	512K	MAX-512	1847
	768K	MAX-768	1815
	896K	MAX-896	1899
	1M	MAX-M	1983

With 16-bit M<sup>3</sup> Addressing option, add \$91

	FROM/TO	P/N	PRICE
<b>Upgrade Kits</b>	256K/384K	MKT-2/3	\$ 192
	256K/512K	MKT-2/5	892
	256K/768K	MKT-2/7	876
	256K/896K	MKT-2/8	987
	256K/1M	MKT-2/M	1060
	384K/512K	MKT-3/5	600
	384K/768K	MKT-3/7	784
	384K/896K	MKT-3/8	876
	384K/1M	MKT-3/M	968
	512K/768K	MKT-5/7	284
	512K/896K	MKT-5/8	376
	512K/1M	MKT-5/M	468
	768K/896K	MKT-7/8	192
	768K/1M	MKT-7/M	284
	896K/1M	MKT-8/M	192
<b>M<sup>3</sup> option</b>		MKT-M3	121

<b>Software (provided on 8" disk)</b>			
Virtual Disk for MP/M II* and CP/M 2.2,			
CP/M 3.0* Bios modules,			
CP/M memory tests			
			\$ 25
<b>Manuals (sold separately)</b>			
128/ST			\$ 15
MAX Technical Manual			15



## At a Glance

### Name

TRS-80 Model 100 Portable Computer

### Manufacturer

Radio Shack  
One Tandy Center  
Forth Worth, TX 76102

### Uses

Portable word processing, programming, and telecommunications

### Dimensions

11½ by 8½ by 2 inches  
(3 pounds, 14 ounces)

### Features

8-line by 40-character liquid-crystal display, full-size, full-travel keyboard, 8085 microprocessor, 32K bytes of ROM, 8K to 32K bytes of RAM, cassette interface, built-in direct-connect modem, RS-232C interface, parallel printer interface, real-time clock/calendar, bar-code-reader interface, and piezoelectric tone generator

### Software

Text editor, BASIC interpreter, communications program, address-book program, and appointment-calendar program

### Documentation

Reference manual: 200 pages, spiral-bound  
Pocket manual: 40 pages

### Price

8K bytes RAM: \$799  
24K bytes RAM: \$999  
32K bytes RAM: \$1134

### Options

Phone connector (\$19.95), printer cable (\$14.95), cassette cable (\$5.95), and acoustic adapter for modem (approximately \$50, to be available 3rd quarter 1983)

machines, and fortunately such tables do not occur frequently in general correspondence.

The large size of the characters and the nonflickering quality of the LCD caused me much less eyestrain than the usual cathode-ray tube display.

## The Keyboard

The second most obvious thing about the Model 100 is its full-size keyboard (see photo 4). While the display is obviously limited by the small size of the unit, the keyboard exhibits few signs of compromise. In fact, it is one

---

**While the Model 100's display was obviously limited by the small size of the unit, the keyboard exhibits few signs of compromise.**

---

of the nicest keyboards I've used on any machine, large or small.

Most of the keys are in the standard Selectric-style arrangement. The Backspace, Control, and Return keys are in their usual places. The cursor control keys are located just above the Backspace key and are arranged in a horizontal row (L-R-U-D). This cursor key arrangement is fairly common, but I much prefer a diamond arrangement for these keys.

The keyboard is controlled by its own microprocessor, and it has a good type-ahead buffer. No matter how fast I typed, no characters were dropped. Key repeat is also provided.

Special shift keys marked Code and Graph allow you to key in all 256 of the Model 100's characters directly from the keyboard.

Twelve function keys are located above the main keyboard. Four of these are permanently marked and have constant functions in all the application programs that come with the machine. "Paste" works as a Block Insert key; "Label" turns the line of function key labels on and off; "Print" is used to print either the contents of the display or an entire file; and "Break/Pause" either terminates or temporarily halts execution of a process, depending on whether the key is cap shifted or not.

The other eight function keys are programmable and are not permanently labeled although they tend to have the same function in each application program. This is a good design feature. As mentioned previously, the bottom line of the display can be used as a label for these keys. Unfortunately, the labels do not line up exactly with the keys. These keys also have interrupt capabilities that could be put to use by advanced computer users.

A "Num" key converts some of the keys into a slanted numeric keypad. Because I'm not a numeric touch-typist, I couldn't test how easy this strange configuration would be to work with. If a numeric keypad is important to you, I suggest you test this keypad in the store to see if you can work with it.

ters can be used either as part of the display or as a line of labels for eight function keys.

The full 96-character ASCII (American National Standard Code for Information Interchange) set can be displayed along with 128 extra foreign and graphics symbols (see photo 3). Some of these graphics symbols are non-standard and cannot be printed on Radio Shack printers. Reverse video characters are available, but apparently not through BASIC.

The screen contrast is fairly good, but decreases quickly as you move away from an optimum viewing angle of about 60 degrees from the horizontal. Contrast can be adjusted with a dial on the right side of the machine. I had no problem reading the display whether it was on a desk or on my lap. The LCD does tend to reflect ceiling lights, however, and this could be a problem in certain offices. Placing the unit on your lap should solve this problem somewhat.

As in most displays, scrolling is done line by line, rather than pixel by pixel (smooth scrolled). The display seems a little slower than most video displays, but not objectionably so. Although the display is smaller than the typical home display—and a great deal smaller than the typical 80 by 24 office display—I grew accustomed to it fairly easily. It is a very good size for menus. The main problem occurs with tabular material wider than 40 columns. But tables tend to be a problem on all



**When you're looking for  
a heavyweight performer  
at a low price,  
IBC outweighs the competition.**



**IBC MIDDi CADET™**

Maximum Users	9
Disk Storage	20 MB
Memory	256 KB **
CPU Speed	6 MHz
Benchmark (Elapsed time)	1:44 Minutes*
List Price	\$7495.00



**ALTOS™ ACS 8000-10**

Maximum Users	4
Disk Storage	10 MB
Memory	208 KB
CPU Speed	4 MHz
Benchmark (Elapsed time)	5:03 Minutes*
List Price	\$7995.00

The IBC MIDDi Cadet is better, faster and less expensive than the ALTOS ACS-8000-10 and others. That's why we call it the heavyweight performer.

Because the MIDDi is completely software compatible with ALTOS, ONYX™, Dynabyte™ and others using CP/M™ 2.2, MP/M™ II or OASIS™, you can transport your applications software to the MIDDi without modification. So why not take the benchmark test yourself.

If you are an OEM, system integrator, multiple end user, or dealer for any of our competitors, send a copy of your application program to IBC. We will run your software on the MIDDi without modification and give you the elapsed time in minutes. You be the judge. If it really is faster than your current hardware and it is, then you owe it to yourself and your customers to switch to IBC.

So remember! When you want a heavyweight performer at a low price, contact:

OUTSIDE THE USA

**IBC** / Integrated Business Computers

21592 Marilla Street  
Chatsworth, CA 91311  
(213) 882-9007 TELEX NO. 215349

WITHIN THE USA

**IBC** / DISTR. BUTION

4185 Harrison Blvd., Suite 301  
Ogden, UTAH 84403  
(801) 621-2294

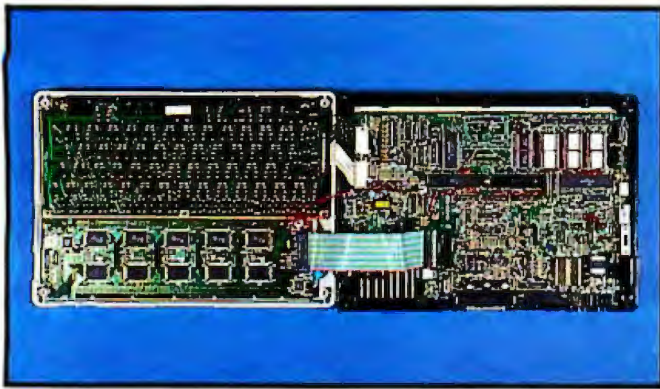
\*Four users under OASIS

\*\* Upgradeable to 512 K Bytes

ALTOS is a trademark of ALTOS Computer Systems, ONYX is a trademark of Onyx Systems, Inc. DYNABYTE is a trademark of Dynabyte Business Computers, CP/M & MP/M are trademarks of Digital Research, and OASIS is a trademark of Phase One Systems.







**Photo 5:** Inside the Model 100. On the right side are the undersides of the liquid-crystal display (top) and keyboard (bottom). The left side shows the main circuitry. The modem circuitry is in the upper left-hand corner. The random-access memory is in the lower left-hand corner. The 80C85 microprocessor is in the central part of the left side.

One slight problem with the keyboard is the sound each key makes. It's not a click exactly; it's more like a pop—a quite audible pop. In fact, a plane full of business executives typing on these machines might drown out the engine noise. That, of course, is an exaggeration, but the key-popping may cause a slight problem in quiet places such as libraries. Admittedly this is a small complaint, but if I were Radio Shack I would investigate putting some type of sound-dampener under the keys.

## Processor

The Model 100 uses the 80C85 microprocessor chip, a low-power CMOS (complementary metal-oxide semiconductor) version of the 8085, which is a well-respected member of the 8080 family. The clock speed for the microprocessor is 2.4 MHz. One of the advantages of the 8085 is its extensive interrupt capabilities, which, as we will see later, are well exploited by the Model 100's BASIC interpreter.

## Memory

Each Model 100 contains 32K bytes of ROM. This is used to store a small menu-based operating system and five application programs. As for RAM, you have a choice of 8, 16, 24, or 32K bytes. The 8K-byte RAM machine sells for \$799. Each additional 8K bytes of RAM costs \$120 plus a \$15 installation charge. Thus, a 24K-byte machine should cost \$799 plus \$240 plus \$15, or \$1054. Radio Shack, however, is offering a special price for the 24K-byte machine of \$999—a savings of \$55. A full 32K-byte machine should then cost \$135 more, or \$1134.

The RAM is of the low-power CMOS type, and it is protected by its own power supply. This memory is powered at all times, whether the machine is on or off. Even after main battery failure, memory power continues for 8 to 32 days. There are apparently only three ways to wipe out the contents of memory: letting the batteries run down and not replacing them for a long time, initiating a cold start or Reset, or turning off the memory power switch on the bottom of the machine (which should be done only when the machine will not be used for an extended period of time).

As on most 8-bit processor machines, the maximum addressable memory space is 64K bytes. The memory appears to be allocated as follows: the bottom 32K bytes of memory (addresses 0 through 31999) are taken up by the ROM. The first 8K bytes of RAM fills the top 8K bytes of memory. Each additional 8K bytes of RAM is installed in the next highest 8K bytes of memory. The topmost part of the first 8K bytes of RAM is used by the computer's operating system for display memory and to store pointers for the BASIC programs and document files. These files are stored in the lowest part of RAM. The part of RAM between the pointers at the top and the files at the bottom can then be used for new files or for arrays for the BASIC programs. With a 32K-byte RAM machine, you have 29.6K bytes of RAM free; with the 8K-byte RAM machine, you have only 5.1K bytes of RAM free.

Future ROM modules for the ROM expansion socket will occupy the same address space as the built-in 32K-byte ROM. You will then be able to switch between the two banks of ROM available.

Some advanced users may feel limited with only 32K bytes of RAM. But programs such as the text editor reside outside of the precious RAM area. Also, the display eats up very little RAM. The result is that you can use almost the entire RAM area for document storage.

# SNA X.25

**Systems Strategies/Communications Division**  
Specialists in Data Communications Software

225 West 34th Street  
New York, New York 10001  
(212) 279-8400

- Custom software to allow your product to interface networks and emulate other vendors equipment
- Software that is installed and currently being utilized by computer and terminal manufacturers on Zilog Z-80, Z8000, Intel 8086, etc.
- Product oriented communications software compatible with SNA, X.25, BSC for product developers to insure timely, cost effective marketplace entry
- Close contact with your engineers to adapt our software to your hardware
- Software in 'C', Pascal and Assembler
- Microcomputer systems development



# OPEN YOUR APPLE TO A WORLD OF COMMUNICATION

*Videx' new PSIO Dual Function Interface Card gives you a whole new world of communication... with a whole new ease of operation.*

The PSIO allows you to use a printer (parallel output) and a modem (serial I/O port) simultaneously, through use of just one card! But best of all, the PSIO makes communicating through either method worlds easier than it's ever been before.

The PSIO lets you choose from among an unmatched range of software-selectable options, including variable baud rate selection, form width, form length, auto linefeed, linefeed mask, Xon/Xoff protocol, lowercase masking, shift wire mod support, duplex mode, parity, data format, video echo mode and a slot echo mode.

**PSIO** can also open up new worlds for graphics, since it can reproduce your picture on any graphics printer. Rotate your picture, enlarge it, change it as you wish.

Once you've chosen your options, the PSIO's highly sophisticated NOVDRAM (non-volatile RAM) will remember and permanently save them. That means you won't have to give the same configurations over and over again... your PSIO will do it for you. And if you want to *change* those configurations, you can do it through software instead of through the confusing array of switches that other cards use.

The PSIO will work with any printer/modem you now happen to own... and it will work with any printer/modem you happen to purchase in the future. Adaptable? Definitely!

The PSIO is completely compatible with BASIC, Pascal and CP/M® systems.

*The PSIO from Videx...how in the world can you do without it?!*





The machine I used had 32K bytes of RAM, and after about 25 hours of typing notes and running BASIC programs, I still had about 16K bytes of RAM left. Even with the 24K-byte machine, I think I would probably run out of batteries or things to write about before I ran out of memory.

I enjoyed using this type of protected RAM. It was a pleasure knowing that I did not immediately have to save everything and that whatever I put into memory would stay there until I deleted it. Still, on this or any other machine, irreplaceable files should be backed up.

## Power Supply

For a portable computer that depends on RAM for data storage, the power supply is a crucial issue. On the Model 100, power is supplied by four AA batteries or by the optional AC adapter. Operating life of the batteries is about 20 hours. This time can be shortened if excessive use is made of the various interfaces (modem, cassette, printer, RS-232C). Because these interfaces will probably be used primarily within reach of an AC socket, this power drain should not be a big problem. The low-battery indicator lights when 20 minutes of battery power are left. I used the machine for about 15 hours, making extensive use of the printer and cassette interfaces, before the low-battery indicator went on. And then the machine continued for another hour and a half before it finally died. That seems to be ample warning to get more batteries.

The Model 100's volatile memory is protected by its own power supply, a separate nicad (nickel-cadmium) battery that is continually recharged by the main batteries or by the AC adapter. When the main batteries fail, the nicad battery will continue to power the memory for an extended period of time, depending on the amount of RAM you have. With 8K bytes of RAM, you have 32 days before the memory is lost. Even with 32K bytes, you still have 8 days to get new batteries.

## Modem

In keeping with its portable nature, the Model 100 was given extensive communications capability. A key element in this design is its built-in direct-connect modem. All you need is the optional phone connector (\$19.95) and you can plug into any standard modular phone jack. If a modular phone jack is not available, you can use an optional acoustic adapter with any regular phone.

The modem is a standard Bell 103-compatible version with a transmission rate of 300 bps (bits per second). *Auto-dialing* capability is also included. However, it can dial only in the *pulse* mode, like a standard rotary-dial telephone. Radio Shack says it would have liked to add *tone-dialing* capability, but it was not available on low-power CMOS chips. If you have a private telephone system that can handle only tone-dialing, you will have to dial manually. The pulse dialing rate, by the way, can be set at either 10 or 20 pulses per second.

You have the option of using several serial communications parameters: the word length can be either 6, 7, or 8 bits. Parity can be handled in one of four ways: Ignore, Even, Odd, or No parity. The number of stop bits can be either 1 or 2. And the pause/continue protocol frequently indicated as XON/XOFF or <Ctl S>/<Ctl Q> can be enabled or disabled.

The Model 100's modem in combination with its ROM-based communications program presents a quite powerful package. The only thing I might want to have added is auto-answer capability, but this might not be a cost-effective option. After all, a portable machine like this will probably not be in one place long enough to receive phone calls.

## RS-232C Interface

The Model 100 also has an RS-232C serial connector for connecting to serial printers, other computers, or high-speed (1200-bps) modems. This interface uses the same circuitry as the modem, and all communications parameters for the modem will likewise affect the RS-232C connector. Unlike the modem, however, the RS-232C port has a wide range of transmission rates: from 75 to 19,200 bps.

## Parallel Printer Interface

For connections to most printers, the Model 100 has a parallel printer port. This takes the form of a 26-pin, dual-row connector on the rear panel of the machine. An optional connector cable converts this to a standard

# NO NONSENSE PRICES.

Find the best advertised price in this magazine on software, hardware, and peripherals then call TOLL FREE

# 1-800-922-9200\*

and we will beat it.

We carry all lines of software and hardware for APPLE, IBM, CP/M and other major brands.

## Mason Computers

Suite 1, 977 S. Santa Fe Ave., Vista, CA 92083

\*Outside CA. Order line only HOURS 9AM - 8PM PST

1-619-726-7784 (Technical assistance) (CA orders subtract \$2.00 on orders over \$200.00)

TERMS Cash/check (please include Drivers License No. & telephone no.), VISA, MASTER CHARGE. Call us for UPS shipping charge. ALL PRICES ARE MAIL ORDER ONLY. SHOWROOM PRICES DIFFER CA residents add 6% sales tax. All prices and availability subject to change.





## BOXED IN THE CORNER BY YOUR SMALL BUSINESS COMPUTER?

The trouble with many of today's better known small business computers is they box you into a *single user system*. So after your big initial investment, you still have a single user system. You always will.

Now there's the Zeus 4 from OSM Computers. *The Zeus 4 is the first multi-user, multi-processor micro at single user prices.* The Zeus 4 is less than one cubic foot and weighs 24.6 pounds.

Yet, it's like four separate, powerful small business computers in one. It allows up to four users to share a common data base or work independently. Each has his own CPU, 64K of RAM and I/O ports. That means greater operator independence, more processor power and greater reliability.

You needn't worry about running out of storage capacity either. The Zeus 4 comes with a built-in hard disk, so users share up to 19MB of storage, about twice as much as most other multi-user systems.

You'll enjoy maximum flexibility in software applications too, because Zeus 4's MUSE operating system runs programs compatible with CP/M. Plus MUSE provides extensive file management functions typically found only on mini computers.

Here's another big advantage: The Zeus 4 is

designed for low maintenance, low down-time. Its four modules snap in and out with a few minutes work. So if repairs are ever needed, modules are simply replaced through OSM's limited warranty program.

Maybe the best thing is that you can buy the powerful and expandable Zeus 4 for \$4,595 (\$6,595 fully configured for four users).

The Zeus 4 from OSM, the latest in a family of powerful, multi-user small business computers. It's the little box that lets you grow without boxing you in.

To find out more,  
call (800) 538-5120  
or (415) 961-8680 in  
California or write to  
OSM Computer Corporation,  
665 Clyde Avenue, Mountain  
View, CA 94043.



# OSM

**Computers. Your power to expand.**

CP/M is a registered trademark of Digital Research, Inc.  
Zeus 4 and MUSE are trademarks of OSM Computer Corporation.  
© 1983 OSM Computers.

Circle 345 on inquiry card.



Centronics-type plug. I was surprised they didn't put a standard Centronics jack on the machine itself.

The Print key prints out through this interface. I connected the Model 100 to a Radio Shack Lineprinter VIII and it worked without any problem, except for a few of the Model 100's nonstandard graphics symbols that could not be printed.

### Cassette Interface

Besides uploading and downloading files over the telephone lines, you can also store files on a cassette. The Model 100's cassette interface stores information at the rate of 1500 bps. This translates to about 20 seconds for a 150-word letter. When you load files from the cassette, the Model 100 lets you hear the bit stream. Because this is not the most pleasant of sounds, you can turn this feature off with a BASIC command.

### Other Features

The Model 100 has several other features worth mention. A real-time clock/calendar indicates the time of day, the date, and even the day of the week. A piezoelectric sound generator functions as a speaker and allows you to generate musical notes without using too much power. An automatic power-off feature is also included. After 10 minutes of not being used, the machine turns itself off to save battery power. This time interval can be lengthened or shortened or it can be disabled.

### Options

Perhaps the most valuable option is the phone connector cable. This cable, which sells for \$19.95, allows you to insert the Model 100 between a standard modular phone and its phone jack. The cable package also includes automatic log-on sequences for Compuserve and the Dow Jones News/Retrieval services, plus membership in these services and one hour's free time on each. That's quite a bit for \$20.

The cassette cable comes free with the optional Radio Shack cassette recorder or can be purchased separately for \$5.95. The printer cable for connecting a printer to the Model 100's parallel port costs \$14.95.

For people who may not have access to a modular phone jack (as in certain hotel rooms or in phone booths), Radio Shack will be offering an acoustic adapter that consists of two cups that fit onto a regular telephone handset. This should be available some time this summer for about \$50.

The bar-code reader is designed to work with a Hewlett-Packard bar-code wand. Software for this option will probably be available at some future time.

The Model 100 also allows for options that have not yet been announced. On the bottom of the machine is a compartment for a 32K-byte ROM module. We can only speculate about what type of software Radio Shack will put on such a chip (a mini-spreadsheet program?). Also in this compartment is a 40-pin external bus connector. Radio Shack is not telling, but this would seem to be perfect for adding storage devices or a larger display.

### Software


It has frequently been said that you should buy a machine not for its hardware but for its software. Microsoft, the designer of the Model 100's software, really took that maxim to heart. On top of the impressive collection of hardware that makes up the Model 100 is an equally impressive collection of software. This is one computer you can start using immediately; you won't have to wait six months to a year for the software to be developed.

Not only are the various software packages extensive, easy to use, and of fairly good quality, but they also work well with each other and are all crammed into just 32K bytes of ROM. Of course, judging software is a subjective task, but if you keep in mind the design goal of the machine—an easy-to-use portable workstation—I'm sure you'll agree that this goal has been reached and then some.

When the machine is turned on, a simple operating system is engaged and the system's main menu appears. This shows the time, the date, the amount of free memory available, and a list of all the files in memory. The five built-in application programs are listed with no filename extension. Document files all have the extension ".DO"; BASIC programs have the extension ".BA".

Choosing a particular file to work with is easy. You simply move the cursor over that file name and press Return. If a document or BASIC program is chosen, the

**DEVELOPMENT HARDWARE/SOFTWARE  
GTEK MODEL 7128 EPROM PROGRAMMER**



- Microprocessor based intelligence for ease of use and interface. You send the data, the 7128 takes care of the rest.
- RS-232 interface and ASCII data formats make the 7128 compatible with virtually any computer with an RS-232 serial interface port.
- Auto-select baud rate.
- Use with or without handshaking. Bidirectional Xon/Xoff supported. CTS/DTR supported.
- Devices supported as of DEC 82, NMOS, NMOS, CMOS, EEPROM, MPU's
 

2758	2508	27C16	5213	8748
2718	2516	27C32	X2816	8749
2732	2532	C6716	48016	8741
2732A	2584	27C64		8742
2784	68766			8751
27128	8755			8755
- Read pin compatible ROMs also.
- Automatic use of proper program voltage based on type selected.
- Menu driven program type selection, no personality modules required. 140 pin devices require adapter)
- INTEL, Motorola and MCS-96. Hex formats. Split facility for 16 bit data-paths. Read, program, and formatted list commands also.
- Interrupt driven type ahead, program and verify real time while sending data.
- Program single bytes, block, or whole eprom.
- Intelligent diagnostics discern between eprom which is bad and one which merely needs erasing.
- Verify erasure and compare commands.
- Busy light indicates when power is being applied to program socket.
- Completes with TEXTTOOL zero insertion force socket and integral 120 VAC power supply. (240 VAC/50HZ available also)
- High Performance/Cost ratio.
  - Model 7128 PRICE \$389.00 •••

**MODEL 7128 SOCKET ADAPTERS**  
 MODEL 481 allows programming of 8748, 8749, 8741, 8742 single chip processors. Price \$98.00

MODEL 511 allows programming the 8751, Intel's high powered single chip processor. Price \$174.00

MODEL 755 allows programming the 8755 EPROM/I/O chip Price \$135.00

MODEL 7128/24 - budget version of the 7128. Supports 24 pin parts thru 32K only. Upgradable to full 7128 capacity. Price \$289.00

Non-expandable, very low cost models available for specific devices.  
 MODEL 7128-L1 for 2716 only \$149.00  
 MODEL 7128-L2 for 2732 only \$179.00

Also available from stock:  
 Eprom Erasers UVP model DE-4 . . . \$78.00  
 Avocet Systems Cross Assemblers \$200.00  
 RS-232 Cable Assemblies . . . . . \$26.00  
 Programmable Devices . . . . . call  
 Complete development systems . . . \$3240.00

**Post Office Box 289  
Waveland, Mississippi 39576  
(601) 487-8048**

**GTEK INC.**



ERGONOMICALLY DESIGNED  
SECURELY TOGETHER



Model #001 in English Oak  
with IBM Personal Computer  
and Printer.



Model #002 in Walnut with  
DEC Rainbow 100.



Model #001 in English Oak  
with Texas Instruments  
Professional Computer.



Model #002 in Almond with  
IBM Displaywriter and Printer.

**SECURITY:** The Compucart is the first computer workstation to provide security for both the hardware and software. Simply return the keyboard to the closed position, close the doors and roll down the double walled tambour door and one key locks it all up.

**ERGONOMICS:** The keyboard and the focal distance to the display are adjustable to suit the individual needs of each user. The user simply places the work directly behind the keyboard and in front of the display in the normal line of sight virtually eliminating unnecessary reach and head/neck movement. Even the pitch of the work is adjustable. With the Compucart you need not compromise your comfort.

**MOBILITY:** Since the Compucart is on four twin wheel casters, you may move the computer/terminal from place to place to take advantage of the multi-tasking abilities of the hardware. With its compact size (requires 4 sq. ft. floorspace) the Compucart fits into any existing environment, allowing you to use the computer in places that you thought just didn't have the room.

**MORE INFORMATION:** Give us a call toll free at 800/237-9024 or ask your computer or office furniture dealer to call for you. We have the only computer workstation that will keep it all securely together for you.

# COMPUCART®



text editor or BASIC interpreter, respectively, is automatically invoked. Typical operating-system functions such as file deleting are handled in BASIC.

When you finish with a particular file or program, you press one of the function keys marked Menu. This closes your file and returns you to the main menu again. Having the complete list of files appear on each warm boot, as it were, is a particularly good idea. It makes the system extremely easy to use and would save time on any operating system.

The five application programs included as standard equipment are the following: a text editor (TEXT), a BASIC interpreter (BASIC), a communications program (TELCOM), an address-book program (ADDRSS), and an appointment-calendar program (SCHEDL). These programs work well with each other. TEXT can be used to edit BASIC programs or the data files used by TELCOM, ADDRSS, and SCHEDL. Also, TELCOM and ADDRSS share the same data file.

### The Text Editor

TEXT will probably be the most used program on the Model 100. It is a full-fledged character-oriented editor (i.e., not a line editor) with word-wrapping, so that words are not broken mercilessly at the end of those 40-character lines. Owing to its compactness, it lacks many of the features found on large packages such as Wordstar or Perfect Writer, but it is well designed, simple to learn, and fairly powerful.

TEXT contains only the most needed functions of a word processor, but makes up for this shortage of functions by making those it has as easy to use as possible. These functions are Insert, Delete, Search (Find), Copy a block, Delete a block (Cut), Insert a block (Paste), Save on cassette, Load from cassette, Print, and Cancel any operation (Break). Note the use of familiar names such as Cut and Paste.

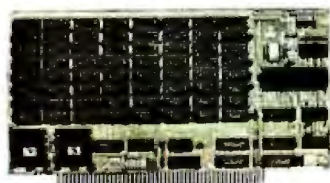
Using TEXT is simple. To create a file, you merely choose TEXT in the main menu. Because it's already in memory, TEXT "loads" in an instant and asks for a file-name for your new file. After that everything you enter becomes part of that file. All controls are handled by function keys. You don't have to remember any control key combinations. For those who prefer them, however, each function key has a corresponding control key combination. Of course, if your text will later be used by another word processor, you can embed the necessary commands into your text.

An interesting thing about TEXT is that it is always in the Insert mode. In other words, you can't "write over" anything you've already written. You must insert the new material and delete the old or vice versa. This took a little while to get used to, but it actually makes a lot of sense and saves time. Most of the editing I do is either inserting or deleting, and this makes the first of the two a bit easier.

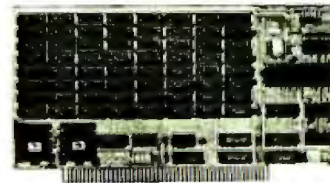
As I said earlier, some functions had to be left out, but some of these are quite useful. Perhaps they can be handled by small BASIC utilities. For example, a Search and Replace function could probably be handled by a short BASIC routine. Also, an indication of the file length (which is quite important on a machine with a small display) might be provided by a short BASIC word-counter.

Lastly, the Print function allows you to print either the whole document file or just the contents of the display. It will print in whatever line length you want, and the lines will be word-wrapped. The only problem is you can't set the left margin. Again, a short BASIC routine could probably handle this also.

To test the performance of TEXT, I tried a little text-editing benchmark. I timed how long it would take to retrieve a 150-word letter, change the date, the addressee, the address, and the salutation, and then store the new



**Worldwide Computer Solutions**  
**We sell SemiDisk**  
**for S-100 IBM PC,**  
**TRS-80 Mod. 2, Kaypro II,**  
**Osborne, Xerox 820 & Heath H-89**



Computing has entered a new era: The SemiDisk era! No longer are you tied down by the speed of floppies or winchesters. Your computer can operate many times faster with a SemiDisk. And with our self installing software it couldn't be easier. Just plug in and hold on! No kidding! Special pricing: From \$995 to \$1595 for 512K Byte and \$2195 for 1 meg Byte.

**Specifications:**

**TYPE:** Semiconductor Disk Emulator—for Z80, 8080 (optional 8586)

**CAPACITY:** 512K or 1Mb

**POWER REQUIREMENTS:** 0.6A (512K) 0.9A (1Mb)

**BATTERY BACKUP:** 10-12V Unreg. (optional)

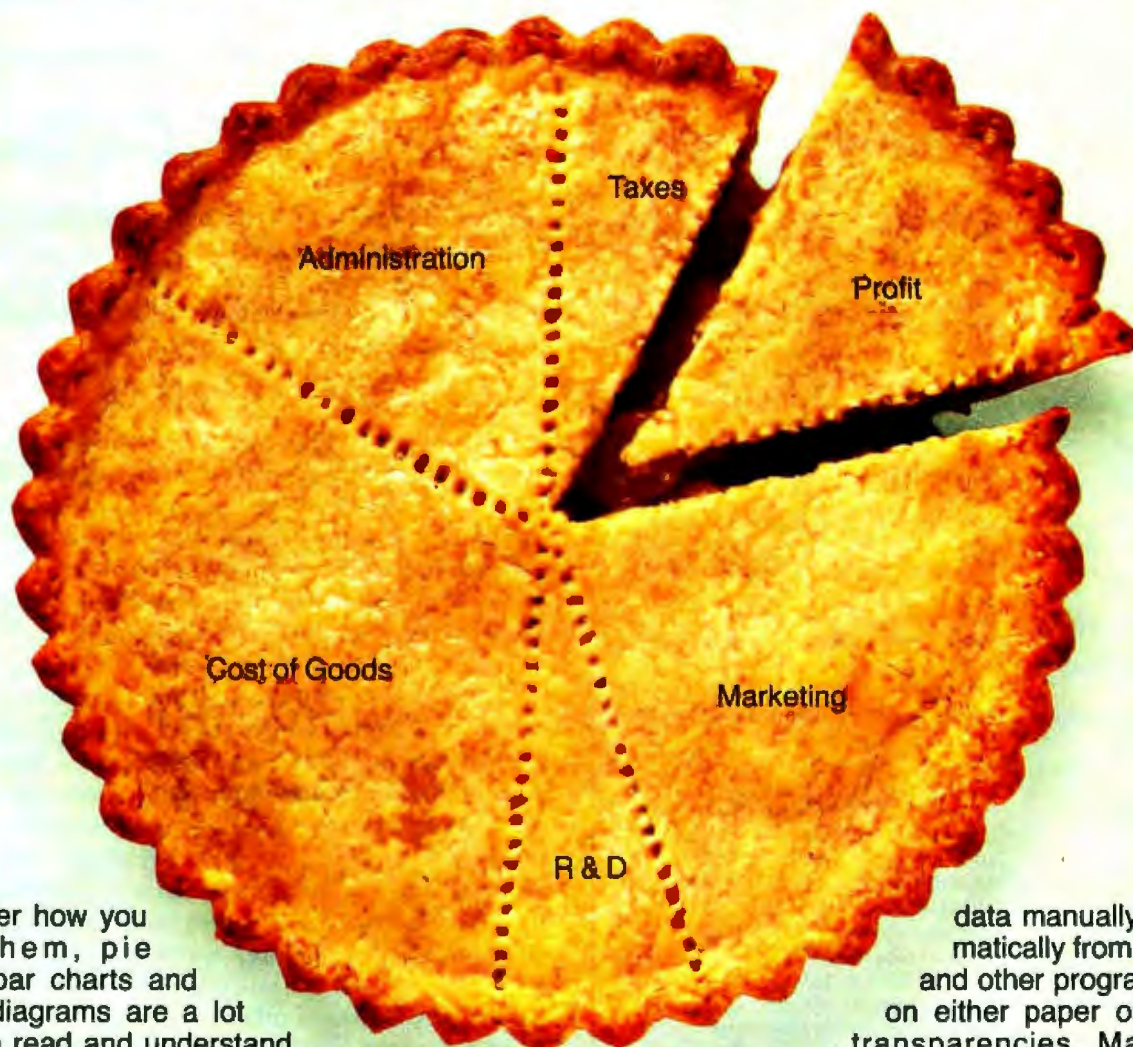
**RAM available (500 piece min.) Call**

**Dealers Wanted**

**For information contact:**  
Computer Solutions Worldwide  
Robert Pinkham  
P.O. Box 931  
Hillsboro, OR 97123  
(503) 640-5665



# With Chart-Master,<sup>TM</sup> creating quality graphics is as easy as apple pie.



No matter how you slice them, pie charts, bar charts and scatter diagrams are a lot easier to read and understand than rows and columns of numbers.

Now you can create colorful business graphics anytime you need them, with an easy-to-use Chart-Master graphics software program. A program that works with Hewlett-Packard plotters and your IBM® or Apple® personal computer.



Values printed at data points; both left and right Y-axis scales; floating legends & bars; both horizontal & vertical formats; exploded pie sections.

Just enter your data, choose a chart format, preview the chart on your screen, and Chart-Master will automatically create a beautiful, presentation-quality chart. In seconds.

There's more to Chart-Master than simplicity. Incredible power and sophistication. You can enter

data manually or automatically from Visicalc® and other programs. Print on either paper or acetate transparencies. Make your charts any size, anywhere on the page.

Have your text appear in attractive print-quality type. Choose from sophisticated formats that include percentage bars, stock price (High/Low/Close) and area charts.

Power and ease-of-use. That's why Chart-Master is in daily use at major corporations like GE, Eastman Kodak, Exxon, Union Carbide, GM, AT&T, DuPont, 3M, Citibank, Motorola, Proctor & Gamble and GTE.

The retail price of Chart-Master is \$375. For a complete information kit and name of your nearest dealer, contact Decision Resources, Inc., 21 Bridge Square, Westport, CT 06880. (203) 222-1974.

**Decision Resources**  
Software Designed for Decision Makers

Visicalc is a trademark of VisiCorp. Apple is a trademark of Apple Computer Inc. IBM is a trademark of International Business Machines Corporation. Circle 159 on inquiry card.



CLOAD?	Verifies a previous cassette load
CLOADM	Loads a machine-language program from cassette
COM ON/OFF/STOP	Enables/disables communications interrupt
CSAVEM	Saves a machine-language program on cassette
CSRLIN	Returns vertical cursor position
DATE\$	Represents the current date (MM/DD/YY)
DAYS	Represents the day of the week (e.g., Fri)
EDIT	Invokes text editor
ERL	Gets line number of error
ERR	Returns error-code number
FIX	Truncates real numbers
HIMEM	Returns high-memory address
INP	Inputs data from a port
INPUT\$(N)	Inputs N characters from keyboard
INPUT\$(N,F)	Inputs string of length N from file numbered F
INSTR	Searches for a given string
IPL	Defines program to run on power-up
KEY	Defines function key as string
KEY LIST	Lists current functions of function keys
KEY ON/OFF/STOP	Enables/disables function-key interrupts
LCOPY	Copies screen to printer
LINE INPUT	Inputs string from keyboard
LPOS	Returns the current position of printer head
MAXFILES	Represents the maximum number of open files
MAXRAM	Returns the maximum amount of RAM available
MDM ON/OFF/STOP	Enables/disables modem interrupt
MENU	Closes files and returns to main menu
ON COM GOSUB	Defines routine to handle RS-232C interrupt
ON KEY GOSUB	Defines routine to handle function-key interrupt
ON MDM GOSUB	Defines routine to handle modem interrupt
ON TIMES\$ GOSUB	Defines routine to handle clock interrupt
OPEN	Opens file and sets logical file number
OUT	Outputs a byte to processor port
POS	Returns horizontal screen position
POWER	Sets automatic power-down period
POWER CONT	Disables auto power-down feature
POWER OFF	Turns off machine
PRESET	Turns off pixel in display
PSET	Turns on pixel in display
RESUME	Resumes execution after error
SCREEN	Turns on/off function-key label line
SOUND	Generates a tone
SOUND ON/OFF	Enables/disables beep when carrier signal comes on telephone line
SPACES	Defines a string of spaces
STRING\$	Defines a repetitive string of a given character
TIMES	Represents the time of day (HH:MM:SS)
TIMES ON/OFF/STOP	Enables/disables time interrupt
VARPTR	Returns memory address of a given variable

**Table 1:** Some selected commands found on the Model 100's version of Microsoft BASIC.

letter. My average time on TEXT was about twice as long as it is when I use Magic Wand, the word processor on my 4-MHz, Z80-based office machine, with which I am quite familiar. Undoubtedly, some of this time difference is due to my inexperience with the portable unit; and some of it is due to the fact that TEXT is always in Insert

mode, and thus simple write-over corrections require twice as many keystrokes; but a large portion of the difference is due to the slowness of the Model 100's LCD versus the 9600-bps display on my office machine. Subjectively, however, the Model 100 "seemed" faster than my office machine because it did not need extra time to load the text editor and the document file from the disk and later store the document on disk and reload CP/M (do a warm boot).

This illustrates a nice feature of the Model 100. You don't have to wait for the disk drives or for the display tube to warm up. You can take the machine out of your desk drawer, turn it on, and be writing a memo in about 2 seconds.

Overall, I found TEXT to be a good product. It seems perfectly designed for the Model 100, almost like a hand in a glove. Even the novice user should be able to write a short letter on it in about an hour, and there aren't many word processors you can say that about.

## BASIC

For the Model 100's BASIC interpreter, Radio Shack has again gone to its traditional source—Microsoft BASIC. Of course, a few commands are missing on the Model 100 version of MBASIC, but several more have been added to take advantage of the interrupt capabilities of the 8085 processor, and it is well integrated with the Model 100's other application programs.

Table 1 describes some selected commands. Of particular note are the interrupt-handling commands, which can work with the modem, the clock, the RS-232C port, and the function keys. For example, in a long program you can insert a routine to handle an interrupt from one of the function keys. Then, whenever that function key is pressed, control is automatically transferred to that routine. The program does not have to continually check the function keys to see if they have been pressed.

As mentioned before, some commands such as WHILE...WEND are missing, but these can be replaced with combinations of other commands.

As for performance, I timed the BASIC interpreter with the Eratosthenes Sieve benchmark described in the January issue of BYTE on page 283. The Model 100 took 2820 seconds for 10 iterations of the routine. Compare this with 2880 seconds for BASIC on the TRS-80 Model III, 2806 seconds for Applesoft BASIC on the Apple II, and 1950 seconds for BASIC on the IBM PC.

Like the other application programs, the BASIC interpreter is integrated with the text editor. The result is that you can edit your BASIC programs in two ways: either by using the common line-oriented approach or by using TEXT. To use the latter method, you merely type TEXT while in BASIC and your program will be translated into ASCII and TEXT will be invoked. When you leave TEXT, your program will be translated back into its normal tokenized form. Long programs can require a few seconds for these translations to occur.

The Model 100's BASIC is also well integrated with the machine itself. Every hardware port and interface seems



# If you stick with timesharing after reading this ad, you haven't read this ad.

Typically, financial planning on a timesharing service runs \$2,000 a month and more. Month after month after month.

And it doesn't take a spreadsheet to figure that as a \$24,000-a-year-after-year expense.

## The incredibly cheap alternative.

The Financial Planner™ from Ashton-Tate can stop this cash drain once and for all.

You pay \$700—one time—for the Planner. And handle your financial planning quickly, easily and completely on your microcomputer.

Without having to share your time or your money with anyone.

## A forecaster's dream come true.

The Financial Planner has enough depth to solve the most complex business problems you can foresee, yet can be used almost intuitively.

The Planner automatically performs calculations on individual items, rows, columns and entire models. Understands conditional logic. Solves simultaneous equations. Computes Present Value and Internal Rate of Return. Reads and writes dBASE II™ files. And much, much more.

But you use abbreviated names, not mysterious formulas. And you communicate with the computer in the English-like vocabulary of FPL™ (Financial Planning Language), so you can easily set up your budgeting and evaluation models.

Editing and report-writing are an integral part of the package, and you can preview results on the screen, then produce presentation-quality financial reports directly.

And when you have your models and reports just right, you can automate them so even your President can run them.

With the Planner, you produce P & L forecasts and financial consolidations in minutes. Explore



“what if” alternatives. Analyze new business ventures and mergers. Plan real estate acquisition and development. And fine tune operations until you reach the financial objectives you've set.

It's one of the most comprehensive business tools available on any computer. All for a fraction of what you've been spending on timesharing services to do the same things.

## For the ardent skeptics.

It may sound too good to be true, but you can check out the Financial Planner with no financial risk.

Run through a hands-on demo at your nearest computer or software store. Then take a package home and use it for 30 days on your IBM PC or CP/M microcomputer. If it's not everything we said it was, just return it and you'll get your money back.

For the name of your nearest dealer, contact Ashton-Tate at 10150 West Jefferson Boulevard, Culver City, CA 90230. Or better yet, call (213) 204-5570 today.

Time's a-wasting.

**The  
Financial  
Planner™**

ASHTON · TATE 



Leader  
of the  
Pack



**5 1/4" \$189\***

SINGLE SIDE  
DOUBLE DENSITY  
48 TPI W/WHUB RING  
2 YEAR WARRANTY

**8" \$195\***

SINGLE SIDE  
SINGLE DENSITY  
2 YEAR WARRANTY

**5 1/4" \$219\***

SINGLE SIDE  
DOUBLE DENSITY  
48 TPI W/WHUB RING

LIFETIME WARRANTY  
LIBRARY CASE FREE  
WITH EACH 100 FLEXDISKS  
LIMITED AVAILABILITY

**8" \$229\***

SINGLE SIDE  
SINGLE DENSITY

LIFETIME WARRANTY  
LIBRARY CASE FREE  
WITH EACH 100 FLEXDISKS  
LIMITED AVAILABILITY

**5 1/4" \$319\***

DOUBLE SIDE  
DOUBLE DENSITY  
48 TPI W/WHUB RING

LIFETIME WARRANTY  
LIBRARY CASE FREE  
WITH EACH 100 FLEXDISKS  
LIMITED AVAILABILITY

**8" \$249\***

SINGLE SIDE  
DOUBLE DENSITY

LIFETIME WARRANTY  
LIBRARY CASE FREE  
WITH EACH 100 FLEXDISKS  
LIMITED AVAILABILITY

- Minimum order 10
  - Packed 10 hours of 10 minutes with sleeves and labels
  - Quantity Discounts - 100 deduct 5%, 1,000 deduct 7%, 5,000 deduct 10%
  - Add \$5.00 per case 5 1/4", \$7.00 per case 8" (case of 100)
- For shipping and handling Continental U.S.A., U.P.S. ground

VINYL STORAGE PAGES  
5 1/4" or 8" 10/35

SNAP-IT POWER CENTER  
Turn one outlet into six  
• Shock-safe  
• Unbreakable  
• 15 Amp Circuit Breaker  
• Lighted On-Off Switch \$19.95

DISK DRIVE HEAD  
CLEANING KITS

Prevents head  
crashes and  
ensures error-free  
operation  
5 1/4" or 8" \$18.00

HARDHOLE DISK PROTECTORS

Reinforcing rings  
of tough mylar  
protect disk hole  
edge from damage  
Applicators  
Hardhole Range (50)

8FD 6-10 CASSETTES... 10/57

(All cassettes include tape and labels)  
Get 8 cassettes, C-10  
Sonic and Cassette/O  
Library Album  
as illustrated,  
for only \$9

LIBRARY CASES

8" Kase-ette/10 \$2.99  
5 1/4" Kase-ette/10 \$2.49

We also stock at PAR (A/T/C) we print

MADELL 3M OPTAO  
WADASH OPDS  
Program, Tape, Data Cartridges  
Data Cassettes, and Disk Packs

\*Written purchase orders accepted from government agencies and well rated firms for net 30 day billing. \* International orders accepted with a 15.00 surcharge for handling, plus shipping charges. \* C.O.D. requires a 10% deposit. \* We accept Visa, MasterCard, Money Order, and Certified checks. \* Checks require bank clearance. \* All shipments F.O.B. San Diego. \* Minimum shipping and handling 2.00, minimum order 10.00. \* California residents add 6% sales tax. Prices and terms subject to change without notice. \* All sales subject to availability, acceptance, and verification. \* All sales are final. \* Satisfaction guaranteed or full refund.

We also offer printer ribbons, printwheels, type elements, equipment covers, power consoles, paper supplies, storage and filing equipment, furniture and many other accessories for word and data processing systems. Write for our free catalog.

Orders Only  
800-854-1555

Information  
619-268-3537

Modem Hotline (Anytime)  
619-268-4488  
Exclusive Monthly Specials

**ABC**  
DATA PRODUCTS  
(FORMERLY ABM)

ITT TELEX 4992217  
8868 CLAIREMONT MESA BLVD  
SAN DIEGO, CALIFORNIA 92123

to be accessible from BASIC. Overall, this version of BASIC is fairly comprehensive and pretty fast for a portable machine.

## TELCOM

In order to take advantage of the built-in modem, Radio Shack has provided the Model 100 with a built-in communications program, and a fairly powerful one at that.

With this program, you can automatically dial a database and execute the required log-on procedures. Once online, you simply press a function key to upload any of your document files onto the database or download a file onto your Model 100. Other function keys let you "echo" your communications to a printer or change from the full-duplex mode to half-duplex.

In the event a database sends you more than eight lines of text at once, Radio Shack has even supplied a function key that lets you refer back to the previous eight lines.

The upload routine includes a very important feature that, surprisingly, is frequently missing from communications software packages. When you upload a document, TELCOM will automatically format it to any line length that your database requires. This is important because some systems cannot handle lines that are longer than a certain length.

The TELCOM program can even be used as an auto-dialer for voice communication.

I found TELCOM a bit harder to use than TEXT or BASIC. The auto-dial and auto-log-on routines use special notation, which is a little hard to remember. Of course, auto-log-on procedures tend to be difficult to encode on any system. Fortunately, Radio Shack will help things by including auto-log-on procedures for both Compuserve and Dow Jones with its optional phone connector. Once these procedures are properly encoded on the Model 100, data communications become easy. In fact, some Radio Shack executives have their log-on procedures for Dow Jones set up so that all they have to do is turn the machine on, press a few keys, and a few seconds later the latest price of Tandy stock appears on their display.

## ADDRSS and SCHEDL

Two simple programs are provided that can turn the Model 100 into an electronic address book and appointment calendar. ADDRSS can be used to store names, phone numbers, and addresses in a special file called "ADRS.DO", which is also used by TELCOM. Once the data has been stored in this file, you can use a function key marked Find to locate, for example, all records containing the string "Bill" or "Fort Worth." Upper-case/lowercase distinctions are disregarded.

SCHEDL works similarly to ADDRSS except that it uses dates and times rather than names and addresses. It stores this data in a file named "NOTE.DO". Using the Find key, you can quickly locate all records you've entered for a given date or time or all appointments you've made with a certain person.



# Don't let price get in the way of owning a quality printer.

Adding a printer to your computer makes sense. But deciding which printer to add can be tricky. Do you settle for a printer with limited functions and an inexpensive price tag or buy a more versatile printer that costs more than your computer? Neither choice makes sense.

Here's a refreshing option—the new, compact STX-80 printer from Star Micronics. It's the under \$200 printer that's whisper-quiet, prints 60 cps and is ready to run with most popular personal computers.

The STX-80 has deluxe features you would

expect in higher priced models. It prints a full 80 columns of crisp, attractive characters with true descenders, foreign language characters and special symbols. It offers both finely detailed dot-addressable graphics and block graphics.

And, of course, the STX-80 comes with Star Micronics' 180 day warranty (90 days on the print element).

The STX-80 thermal printer from Star Micronics. It combines high performance with a very low price. So now, there is nothing in the way of owning a quality printer.

\*Manufacturer's suggested retail price.



**star**<sup>TM</sup>  
MICRONICS • INC

**THE POWER BEHIND THE PRINTED WORD.**  
Computer Peripherals Division, 1120 Empire Central Place,  
Suite 216, Dallas, TX 75247 (214) 631-8560



## The new STX-80 printer for only \$199.\*



ADDRSS is pretty handy because it shares its data file with TELCOM. SCHEDL seems somewhat limited by contrast. It would have been nice if Radio Shack had incorporated the clock/calendar into it, but I imagine ROM space must have gotten pretty scarce by the time SCHEDL was added. Again, you could probably write a simple BASIC program to do this. For example, it could check the clock/calendar, then check each record of the NOTE.DO file, and sound some type of alarm when the two coincide. Such a program could automatically tell you when you have an appointment and with whom.

### Possible Applications

With all this hardware and software, the Model 100 is well suited for a large number of applications. It should be a great tool for writers, programmers, businesspeople, and students. With the bar-code reader, it could even be used at the local supermarket. The Model 100 looks very flexible. It should be interesting to watch applications for it develop.

### Limitations

As good as the Model 100 is, it does have certain limitations.

One is the lack of convenient mass storage. There will be times when you wish you could quickly load and store large documents or programs. Looking at the external bus connector on the bottom of the machine, I wouldn't

be surprised if Radio Shack already has a mass-storage device in the works. My guess is either a thin-line 5¼-inch floppy disk or a large disk-simulating CMOS RAM module. Of course, 3½-inch floppies and bubble memory are also possibilities.

Another limitation is the display. Although it is of a useful size, it could be a hindrance, for example, in spreadsheet programs. Again, looking at that bus connector, I've got a feeling some type of video display is on someone's drawing board. Also, as LCDs get larger and larger, I wonder if 16-line by 80-character displays are that far down the road.

A small dot-matrix printer would be a useful accessory for the Model 100. Something on the order of the new briefcase-size typewriter from Brother would be handy.

We're completely in the dark as to what that extra ROM socket might be used for. The best bet is a mini-spreadsheet program. But I wouldn't be surprised if some type of disk operating system were in the works, or even some games. I'm sure Radio Shack will think of something.

Speaking of games, the bit-mapped graphics of the LCD and the interrupt capabilities of the machine might lend themselves nicely to possible game applications.

### Documentation

The Model 100 comes with two manuals; a large 200-page spiral-bound manual and a small pocket-size

**NEW**

# Systems II Ex

## Turningpoint Series

- General Ledger
- Accounts Receivable
- Payroll
- Accounts Payable
- Inventory
- Data Base

A totally integrated accounting system featuring Departmental P & L, Budget Reporting and P.O.S., Check Writing, Invoices and Statements, Job Costing and Client Billing also available.

Standard features such as: check writing for payroll and payables. Receivables prints invoices and statements. Available on floppy or hard disk. Compatible with the APPLE® II and ACE 1000.

See your dealer today or contact:

**Westware**

2455 S.W. 4th Ave.  
Ontario, OR 97914 (503) 881-1477

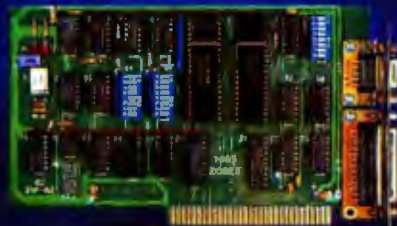
APPLE® is a registered trademark of Apple Computer and ACE 1000 is a trademark of Franklin Computer®



# S-100 AND IBM PC

COMPATIBLE PRODUCTS BY

# ZOBEX



2 SERIAL PORT \$165



\* 20MB HARD DISK \$1995



256K RAM \$335



64K DYNAMIC RAM



ZOBEX MULTIUSER COMPUTER



HOST ADAPTER FOR WD 100X



DD DMA FLOPPY DISK CONTROLLER



Z80A WITH 7 I/O PORTS



CLOCK, SERIAL I/O, IEEE 488

For the past five years, ZOBEX has brought you the most reliable S-100 products available. In answer to the overwhelming demands of the rapidly growing market for microprocessors and their peripherals, we have enlarged our inventory. You can now get expansion products for your IBM PC from ZOBEX. Our 12 or 20 MByte Hard Disk Subsystem, 256K RAM, and Serial I/O boards reflect the same excellent quality and efficiency which our S-100 products demonstrate. Our confidence in

our designs and craftsmanship allow us to back up these products with warranties of six months up to one year.

Today's technology has enabled microprocessors to attain the same level of speed and sophistication already achieved by the larger computers and ZOBEX has the experience to provide you with the most advanced micros and add-on products the industry has to offer. Top quality and low pricing make all ZOBEX products a valuable investment, so when you buy a ZOBEX expandable 8 or 16 bit

microcomputer, you are assured of getting the most for your money.

Call or write to:

®

7343-J Ronson Rd.  
San Diego, CA. 92111  
(619) 571-6971

\* For DEC additional Concurrent CP/M Hard Disk version available for IBM PC

ZOBEX IS A TRADEMARK OF ZOBEX CORPORATION

IBM IS A TRADEMARK OF INTERNATIONAL BUSINESS MACHINES CORP.

CONCURRENT CP/M IS A TRADEMARK OF DIGITAL RES. INC.



# The Best In Price, Selection and Delivery

## Professional Quality

Call Now TOLL FREE

**800-368-3404**

(In VA, Call Collect 703-237-8695)

AMPEX • INTERTEC • TEXAS INSTRUMENTS • GENERAL DATA  
COMM. • ANDERSON JACOBSON • C. ITOH • QUME • BEEHIVE •  
DATASOUTH • DIABLO • CENTRONICS • NEC • PRENTICE

### MICROS

#### INTERTEC SUPERBRAIN II

64K DD	ONLY \$1895
64K QD	ONLY \$2295
64K SD (96TPI)	ONLY \$2695

\*Includes M/Soft BASIC

DDS-10 Meg (Hard Disk)	ONLY \$1195
---------------------------	-------------

DYNABYTE ..... Call

### PRINTERS

High Speed Line Printers..CALL

NEC	
7710 Ser	\$2089
7715	\$2089
7730 Par	\$2089
7720	\$2449
7725	\$2495
Std. Tractor 77xx	\$ 199
3510	\$1390
3530	\$1390
3550 (IBM)	\$1869
3515	\$1395

DATASOUTH ..... Call

### DIABLO

620-SPI	\$ 949
630-R102/147	\$1949
630 ECS	\$2369
630-R155	\$1745
*(for IBM P.C., Apple II, TRS-80)	
630-K104 (KSR)	\$2385

### QUME

Sprint 9/45 FP	\$1794
Sprint 9/55 FP	\$2119
Sprint 9/55 FP/XMEM	\$2186
Sprint 9/55 LP/XMEM	\$2094
Sprint 11/40-PLUS	\$1449
Bi-Dir. Forms Tractor	\$ 199

CENTRONICS:122 (P) ..... \$ 699

### TERMINALS

AMPEX	
D80	\$ 699
BEEHIVE (SMART DISPLAY)	
DMS	Call
DM5A	Call
DM310 (3101 Emulator)	Call
DM 3270 (3270 Emulator)	Call
Protocol Converter	Call
QUME	
QVT-102	\$ 594
QVT-103	\$ 739
C. ITOH	
CIT 101	\$1350
CIT 161 (64 Colors)	Call
TEXAS INSTRUMENTS	
745 Standard	\$1172

In addition, we can make EIA RS 232 or RS 449 cables to your order, and supply you with ribbons, printer stands, print wheels, thinblades for all printers listed. And many, many more items. CALL NOW.

All items shipped freight collect either motor freight or UPS unless otherwise specified. All prices already include 3% cash discount. Purchase with credit card does not include discount. Virginia residents, add 4% Sales Tax. For fastest delivery send certified check, money order or bank-wire transfer. Sorry, no C.O.D. orders. All equipment is in factory cartons with manufacturers warranty (honored at our depot). Prices subject to change without notice. Most items in stock.



## TERMINALS TERRIFIC

Terminals Terrific, Inc., P.O. Box 216, Merrifield, VA 22116  
Phone: 800-368-3404 (In VA, Call Collect 703-237-8695)

40-page booklet. The first chapter of the large manual explains how to get the system up and running in as short a time as possible. Later chapters describe each application program in great detail. Several appendixes contain various technical information.

The pocket manual is meant to be the one you take along on trips. It contains much the same information as in the first chapter, plus most of the technical information from the appendixes, in the large manual. I would have liked a reference card with all the application program commands on it, but most of these commands are fairly intuitive anyway. The pocket manual seems like a good compromise between a large, comprehensive manual and a short, incomplete reference card.

The manuals are well written. A novice user should be able to get the text editor working without too much trouble. BASIC and TELCOM may present some problems. Novices might find an introductory book on BASIC helpful. Although the TELCOM section may not be as easy as that for TEXT, it does not seem to be any harder than the databases you will be connecting to.

In addition to the ROM-based application programs, Radio Shack also includes some useful BASIC programs in its manual. For example, one of these will alphabetically sort all the records in your ADRS.DO file.

### Summary

The TRS-80 Model 100 is an amazing machine. In one fell swoop, Radio Shack seems to have bypassed the "electronic cottage" and brought us the "electronic shopping bag."

Just out of curiosity I added up what it would roughly cost to buy the separate elements that make up the Model 100, that is, if you could buy them separately. There's the display, the keyboard, the processor, the memory, the modem, the RS-232C interface, the parallel printer interface, the clock/calendar, the cassette interface, the bar-code-reader interface, the text editor, the BASIC interpreter, the communications program, and the address-book and appointment-calendar programs. My rough estimate comes to about \$1500, and that doesn't include the tremendous amount of time you would have to spend getting all these things to work together. No matter what your feelings are about the software or the size of the memory or display, I think you'll agree that, at \$999 for a 24K-byte RAM machine, the Model 100 is a pretty good bargain.

A few weeks ago a short note on the Model 100 was leaked by the *Wall Street Journal*. Rumor has it that at least one person saw this note, promptly ran down to the local Radio Shack store, and placed an \$800 deposit in a very surprised salesperson's hands.

Radio Shack could probably make money issuing just a mediocre portable computer. Instead, it produced an exceptional machine. The designers of this machine—including Bill Walters of Radio Shack, Bill Gates of Microsoft, and several others at both companies—should be congratulated. And I have a feeling they will be—the way to the bank. ■



# WOW! LOOK WHAT XCOMP HAS ON SALE!



Don't be caught on the outside looking in!

XCOMP has 8MB and 16MB Hard Disk Subsystems available at incredible savings! Do what thousands of purchasers have done over the past 7 years with us . . . improve your computer's performance with a Hard Disk Subsystem from XCOMP at Corporate Prices!

If you have ever even thought of purchasing a Hard Disk Subsystem for your company's computer in order to drastically improve its performance, then think XCOMP. Not only will you look like a hero, but take a look at the reason's why:

- The savings in time alone will more than pay for your purchase within weeks!
- There is absolutely no maintenance required with XCOMP's Hard Disk Subsystem!
- The system can be used on many types of computers by simply changing adapters! (IBM, Apple, KAY-PRO, OSBORNE, NEC and others.)
- You'll continuously receive professional advice from XCOMP!
- You'll receive direct XCOMP service!
- Buy **without risk**, because you'll receive a full **One Year Warranty!**

To find out more how you can become the company hero, call or write XCOMP for more information. We'll answer **all** of your questions **before** you decide to buy!

At XCOMP, we'll help you increase your company's potential by keeping your nose into new business technology.

This way, we also prevent your boss from getting his nose bent out of shape.

**\$1595.**

(8MB Hard Disk Subsystem Quantity 2 \$1895. Quantity 1)

**\$1895.**

(16MB Hard Disk Subsystem. Quantity 2 \$2195. Quantity 1)



7566 Trade Street/San Diego, CA 92121 (619) 271-8730

**YES!** I want an XCOMP Fixed Hard Disk Subsystem, but I have a few questions first. Please call.  Please send \_\_\_\_\_ Fixed Hard Disk Subsystems at \$\_\_\_\_\_ each. (See price.) I have a \_\_\_\_\_ Computer.  **8MB**  **16MB.**

Please send COD. I will pay COD with Cashier's Check.

Please charge my American Express Card.

# \_\_\_\_\_ Exp \_\_\_\_\_

Name \_\_\_\_\_

Company \_\_\_\_\_

Address \_\_\_\_\_

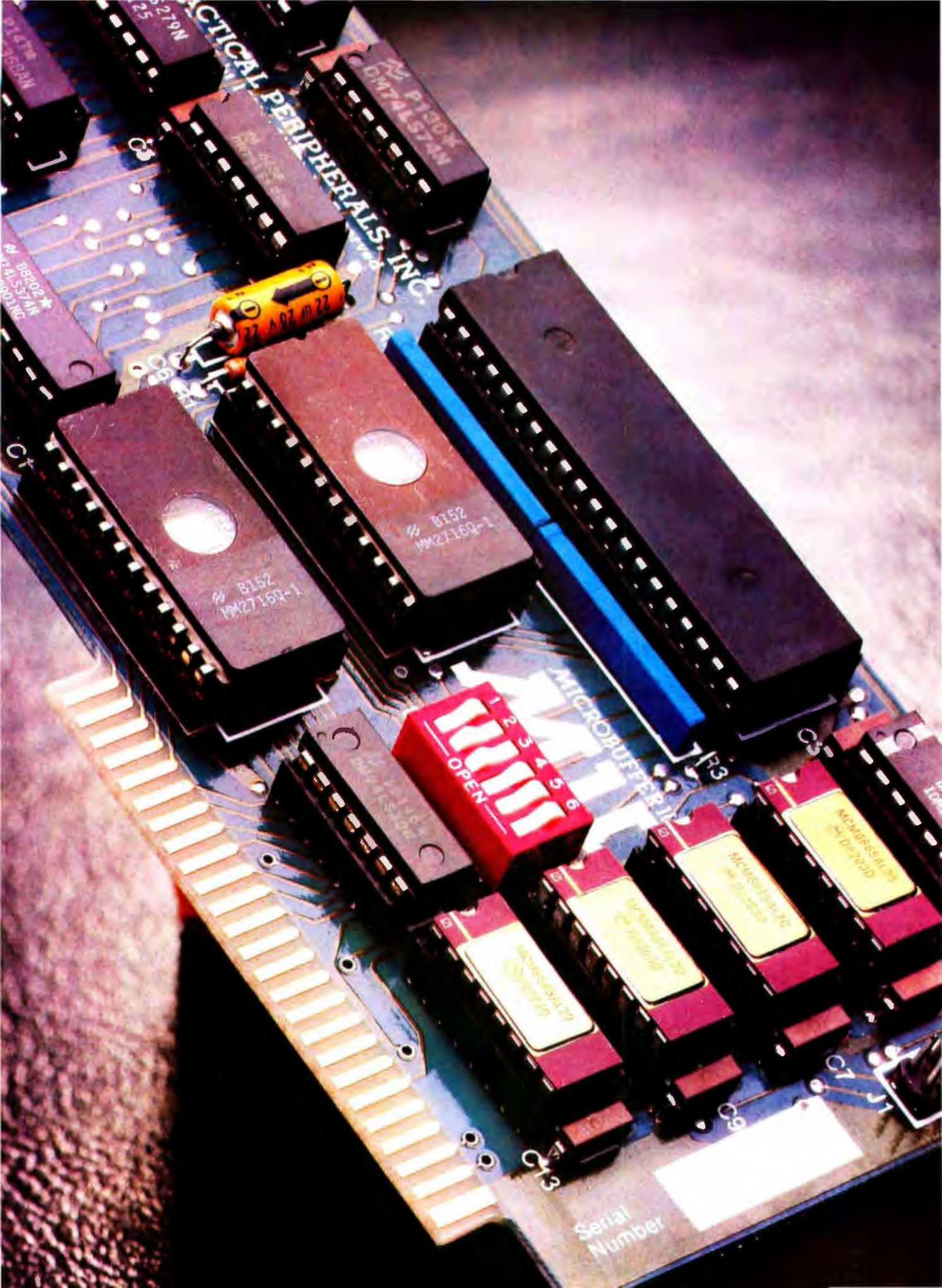
City \_\_\_\_\_ State \_\_\_\_\_ Zip \_\_\_\_\_ Phone \_\_\_\_\_

Calif. residents add 6% sales tax American Express Card customers call 1-(619) 271-8730.



Circle 492 on Inquiry card.





ACTICAL PERIPHERALS, INC.

8152  
WA27169-1

1 2 3 4 5 6  
OPEN

MICROBUFFER 1

MICROBUFFER 2

MICROBUFFER 3

Serial Number



# YOU WILL NEVER AGAIN HAVE TO WASTE TIME WAITING FOR YOUR PRINTER.

## **MICROBUFFER ALLOWS YOU TO PRINT AND PROCESS SIMULTANEOUSLY.**

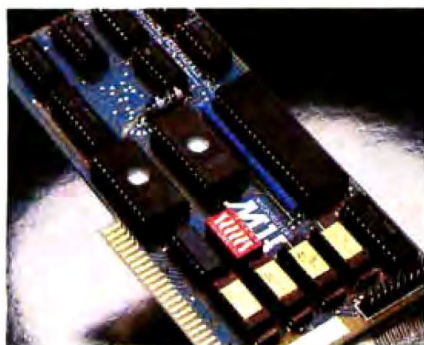
Microbuffer will instantly increase your efficiency — and eliminate the frustration of waiting for your slowpoke printer.

Now you can simply dump your printing data directly to Microbuffer and *continue processing*.

Microbuffer accepts the data as fast as your computer can send. It stores the data in its own memory buffer, then takes control of your printer.

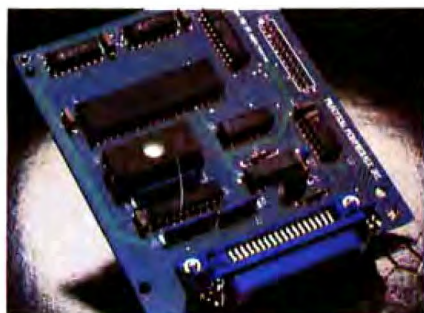
## **THERE IS A MICROBUFFER FOR ANY COMPUTER/PRINTER COMBINATION.**

Whatever your system, there is a specific Microbuffer designed to accommodate it.



FOR APPLE II COMPUTERS, Microbuffer II features on-board firmware for text formatting and advanced graphics dump routines. Both serial and parallel versions

have a power-efficient low-consumption design. Special functions include Basic listing formatter, self-test, buffer zap, and transparent and maintain modes. The 16K model is priced at \$259 and the 32K, at \$299.



FOR EPSON PRINTERS, Microbuffer/E comes in two serial versions — 8K or 16K (upgradable to 32K) — and two parallel versions — 16K or 32K (upgradable to 64K). The serial buffer supports both hardware handshaking and XON-XOFF software handshaking at baud rates up to 19,200. Both interfaces are compatible with standard Epson commands, including GRAFTRAX-80 and GRAFTRAX-80+. Prices range from \$159 to \$279.



ALL OTHER COMPUTER/PRINTER COMBINATIONS are served by the stand-alone Microbuffer In-line.

The serial stand-alone will support different input and output baud rates and different handshake protocol. Both serial and parallel versions are available in a 32K model at \$299 or 64K for \$349. Either can be user-upgraded to a total of 256K with 64K add-ons — just \$179 each.

## **SIMPLE TO INSTALL.**

Microbuffer II is slot-independent. It slips directly inside the Apple II in any slot except zero.

Microbuffer/E mounts easily inside the existing auxiliary slot directly inside the Epson printer.

The stand-alone Microbuffer is installed in-line between virtually any computer and any printer.

## **MICROBUFFER FROM PRACTICAL PERIPHERALS.**

So what are you waiting for? Write to us for more information or ask your dealer for a demonstration.

When you see how much freedom Microbuffer will allow, you'll understand why it's so silly to be without one.

PRACTICAL PERIPHERALS, INC.™  
31245 LA BAYA DRIVE  
WESTLAKE VILLAGE, CA 91362  
(213) 991-8200

Circle 365 on Inquiry card.



## The Osborne Executive and Executive II Adam Osborne's Improved Portable Computers

---

Jerry Pournelle  
c/o BYTE Publications  
POB 372  
Hancock, NH 03449

---

When the Osborne 1 burst on the scene there was plenty of speculation. Would it survive? Would people buy it despite the small screen and generally unaesthetic appearance?

It didn't take long for those questions to be answered. The Osborne 1 is now one of the top-selling personal computers and is identified with the idea of a "portable computer." Osborne Computer Corporation also pioneered the concept of including software worth more than the cost of the machine.

Osborne's second and third computers have been the subject of even more speculation, but this time people at Osborne feel that they've done it right. The Osborne Executive features a larger, 7-inch screen with 24 lines of 80 characters each, two thin double-density disk drives, 128K bytes of memory, both CP/M Plus and the UCSD p-System operating systems, and all the previously available software plus a new database management system, Personal Pearl. The Executive II has all of the above features and an 8088 coprocessor board with 128K bytes of its own memory, high-resolution monochrome graphics, both the MSDOS and CP/M-86 operating systems, and the ability to run IBM Personal Computer programs. If that isn't enough, there are still more options.

### Adam Osborne and the Osborne 1

I saw my first Osborne 1 computer when it was introduced at the West Coast Computer Faire two years ago. It's hard to remember just how radical an innovation the Osborne 1 was: a full Z80-based computer with the CP/M operating system, 64K bytes of memory, two 5¼-inch disk drives, a 5-inch screen with 24 lines of 52 characters each, a detachable keyboard, an RS-232C serial port and a parallel port, and plenty of software, all in one package for \$1795. The programs given away with the machine were some of the microcomputer industry's best: Wordstar, the top-selling word-processing program; Supercalc, a Visicalc-like electronic spreadsheet; Microsoft BASIC, the standard BASIC; and CBASIC, a better business BASIC.

It looked like a natural—if Adam Osborne could produce the machines, and if the public

would buy them.

Those issues weren't in doubt for long. The public had been waiting for an affordable, easy-to-use, business-quality computer. As the Osborne advertisements said, it was inevitable. The Osborne 1 soon had a major chunk of the market all to itself.

There followed a number of product improvements. An external video monitor was optional, for those who



Photo 1: The Osborne Executive with a 7-inch amber screen, two half-height disk drives, and the input/output connectors across the bottom front of the computer.





# Reach out and byte someone!



Your desk-top computer system is only a beginning — plug a low-cost UDS modem into the RS-232 port and a whole new world of communications opens up!

UDS modems add a new dimension to personal computers. For professional use, a modem permits two-way, hard-copy communication between home office and branches or among the branches themselves. Electronic mail becomes a reality. Sales, cost and inventory updates can be sent over ordinary telephone lines at economical, after-hours rates.

When you use your computer for personal applications, the modem allows you to access up-to-date market information, receive news and weather summaries, check airline schedules or even electronically scan out-of-town newspapers. Long-distance game playing and computer-age personal correspondence become instant realities.

The wide range of UDS modems includes one that fits your requirement perfectly. Top of the line is the micro-processor-based 212 A/D which communicates at 0-300 or 1200 bps, stores and automatically dials up to five 30-digit numbers and includes a complete prompting menu and full

automatic test capabilities. Yet, with all these features, it costs only \$745.

At the other extreme is the \$145 103 LP, offering simultaneous two-way communications at 0-300 bps without an AC power cord. This unit siphons operating energy directly from the telephone line!

In between is a large variety of units — many of them in the LP no-power-supply design and all fully FCC certified for direct connection to the telephone system.

Don't be a computer hermit — treat your system to a UDS modem; then you can reach out and byte someone! For details, contact your favorite computer dealer or Universal Data Systems, 5000 Bradford Drive, Huntsville, AL 35805. Telephone 205/837-8100.

 Universal Data Systems



**MOTOROLA INC.**  
Information Systems Group

Circle 470 on Inquiry card.



## At a Glance

### Product Name

The Osborne Executive

### Manufacturer

Osborne Computer Corporation  
26538 Danti Court  
Hayward, CA 94545

### Price

\$2495

### Components

Size: width 20½ inches, depth 13 inches, height 9 inches

Weight: 28 pounds

Electrical needs: 120 or 230 volts AC, 50 or 60 Hz

Processor: 4-MHz Z80A

Memory: 128K bytes of user RAM

Display: 7-inch amber monitor; 24-line by 80-character memory-mapped screen, two sets of 128 characters; 8- by 10-dot character grid; writable character font: 12-bit display memory allows blinking, dim, underlined, reversed characters and/or alternate character set for each character

Keyboard: 69 keys for text and data entry, 12-key numeric keypad, 10 programmable function keys, 4 cursor control keys, redefinable keyboard layout, automatic repeat on all keys, detachable keyboard with coiled cable

Disk Drives: two half-height double-density 5¼-inch floppy-disk drives with 204K-byte storage capacity each, can read Osborne 1, IBM PC, DEC VT-180, Xerox 821, UCSD p-System, and Cromemco disk formats

Input/Output: two RS-232C serial ports for a modem and a printer, one parallel port configurable for IEEE 488 or Centronics-style accessories

### Software Included

CP/M Plus (Digital Research) and UCSD p-System run-time (Softech Microsystems) operating systems, Wordstar (Micropro), Supercalc (Sorcim), MBASIC interpreter (Microsoft), CBASIC semi-compiler (Digital Research), and Personal Pearl (a database management program)

### Options

300-bps direct-connect modem, battery pack

### Alternate Configuration

Executive II with the standard features above plus the following: Coprocessor board with 4-MHz Intel 8088 microprocessor and 128K bytes of RAM expandable to 256K bytes, 640- by 200-dot high-resolution monochrome graphics, MSDOS (Microsoft) and CP/M-86 (Digital Research) operating systems, IBM Personal Computer compatibility, connector to external expansion bus  
Price: \$3195

didn't care for the tiny screen. A stylish redesigned case switched ugly-duckling brown for corporate blue and gray. Optional double-density disks offered 204K bytes instead of 102K bytes per disk, and the capability to read a wide variety of 5¼-inch disk formats was featured. An 80-column or 104-column screen format could be added. A modem and external battery pack were available. More software was bundled in; a copy of the popular database management program dBASE II was given away if you bought an Osborne 1 during the Christmas sales season. One particularly interesting accessory was the Start-Pack, a combination of flip charts, documents, and audio-cassette tapes that enable a rank beginner to turn on the Osborne 1 and learn to use it in hours. (I know that one works, because we tested it on my Boy Scout Computer Merit Badge class.)

Even with the improvements, the increased competition in the small computer field indicated that enhancements to the Osborne 1 wouldn't be enough; a more powerful computer was needed. Osborne had two logical choices: keep the size constant and add capabilities, or keep the capabilities constant and make the machine smaller.

Osborne chose the first route, and the Osborne Executive is the result.

### The Executive

The Executive shares the same case and colors as the newer Osborne 1. It weighs 28 pounds, making it more transportable than portable; that is, it's too heavy for most people to carry around with them wherever they go. The first noticeable difference from the Osborne 1 is the screen, which is 7 inches across and amber in color.

The character set is excellent, and with the larger screen each 8- by 10-dot character cell is very readable. An external video screen is provided for, but most users won't need one.

The designers gave the display system a lot of thought. Each character on the 24 by 80 memory-mapped screen has 12 bits of display memory to select blinking, dim, underlining, reverse video, and/or the alternate character set for each 7-bit ASCII (American National Standard Code for Information Interchange) character. Also, the entire display can be reversed to black on amber instead of amber on black. There are two sets of 128 characters, so an alternate character set could easily be defined to be italic, boldface, or even graphics characters. This feature is called a "writable character font" and has many visual possibilities. It's possible to have up to 256 different characters on the display, and you can define each character if you like. Default character sets are loaded from the disk into screen memory when the system is turned on or reset.

The 128 characters in the first character set are the same as the Osborne 1's with its 31 simple graphics characters. The alternate character set with an additional 128 characters will probably be TRS-80-style block graphics and possibly some Greek characters. A font-editor utility is supplied with the system to create your own characters.

The flexible terminal emulation program allows the Executive's keyboard and screen to imitate nearly any standard terminal. Although the Executive uses the same screen and cursor control codes as the Televideo 912 terminal, it can be made to act like the 10 to 15 other terminals in this program's menu.

The improved keyboard with its 69 keys and 12-key



# The MultiMode Printer with The Magnificent Fonts



## MultiMode Printer Offers Flexibility

## . . . At a Sensible Price

"Flexibility" means instantaneous call up of any of this trend-setting machine's many features whether for *word processing*, *data processing*, *graphics* or *forms generation*. Using either of the two built in interfaces, an external keyboard or downloading from your computer, you can program the Qantex Model 7030 to do more.

Compare the "Beauty" of our printed letters for the word processing fonts which include Cubic, Trend, Spokesman, Courier, Italics, Script, OCR-A, APL, Scientific plus *downloaded* fonts from your computer. Draft copy modes include 8 resident fonts — U.S., U.K., German, French, Spanish, Swedish, Finnish, Norwegian and Danish.

Other features include high resolution graphics — 144 x 144, single pass and double pass word processing, and 180 cps data processing modes and user defined formats.

Operator initiated, the MultiMode printer provides a complete printed status report of operating parameters and diagnostics.

For more information, or a demo, call us about the new Qantex Model 7030 MultiMode Printer.

 north atlantic  
**Qantex**

60 Plant Avenue, Hauppauge, NY 11788  
(516) 582-6060 (800) 645-5292

See us at  
Comdex W6240

Circle 382 on inquiry card.

## The "Beautiful" Font





numeric keypad still doesn't have keys for the entire set of ASCII characters, but as with the present Osborne 1, combinations of keys will produce characters such as the curly braces ({} ) and the tilde (~). However, the entire keyboard is software programmable to let you devise and install any keyboard layout you want. There are also 10 user-programmable function keys (control-0 through control-9) and four fixed-function keys (the cursor keys).

The slim-line disk drives to the left of the video screen are another striking feature of the new Osborne Executive. These half-height 5¼-inch disk drives are double-density but only single-sided. The company has been unable to find portable double-sided drives that meet its requirements of reliability and price. Storing information in the Osborne double-density format allows for 204K bytes on a disk.

Meanwhile, the Executive reads a wide variety of disk formats including, naturally, single- and double-density disks from the Osborne 1, but also formats as diverse as the IBM Personal Computer, DEC VT-180, Xerox 821, UCSD p-System, and Cromemco mini-disk.

The standard Executive uses a Z80A microprocessor running at 4 MHz and comes with 128K bytes of RAM (random-access read/write memory) plus 10K bytes of internally-used memory for power-on diagnostics, I/O drivers, and a scratch-pad area. A Zilog SIO chip provides two serial ports where the Osborne 1 had only one. The input/output is now sent to ports instead of being memory-mapped. The standard operating system will be

CP/M Version 3.0, also known as CP/M Plus, but the UCSD p-System run-time operating system will be provided as well. (The UCSD Pascal language is extra.) The additional memory beyond the 64K bytes addressable by the Z80 microprocessor is managed by CP/M Plus to allow, for example, larger disk-buffer areas for significantly faster operation. A clock keeps track of the time and date, but only while the power is turned on. A small fan cools the computer.

The connectors and controls on the front of the machine are the two RS-232C serial ports (typically for a modem and printer), a parallel port that can be configured for either IEEE-488 or Centronics-style use, video brightness and contrast, external video, the reset button, an RCA jack for composite video output (so you don't need an adapter), and the blue power switch. The grill on the right front hides the power supply.

You won't see a battery-power connector on the front of the machine because Osborne plans to offer an optional battery pack with a 12-volt DC to 220-volt DC converter that the Executive's power cord can plug directly into. The connector for the converter plugs into the battery pack or your car's cigarette lighter. (Running the car while the computer is plugged in is not recommended due to voltage spikes.) Jumpers on the back of the Executive allow overseas use of the machine with international voltages.

Another available option is a small 300-bps (bits per second) direct-connect modem that slides into the slot,

# NEW!

## Aztec C II

- generates FAST 6502 code for APPLE, ATARI, and COMMODORE

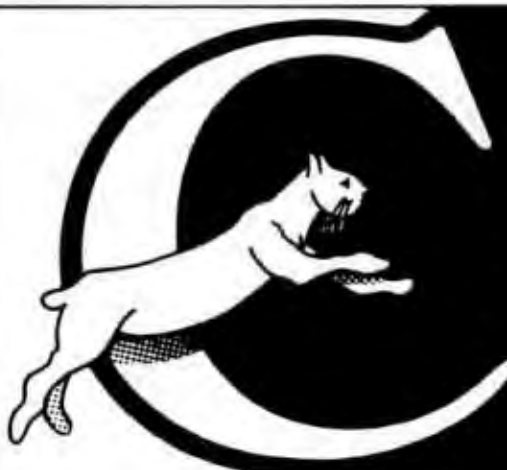
## Aztec C86

- PC DOS, MSDOS, CP/M-86

## CROSS COMPILERS

- PDP 11, 8088/8086, 8080/Z80, 6502

## PORTABLE SOFTWARE APPLE CP/M IBM



# Leap into a new dimension with Aztec C!

### C COMPILERS — COMMON FEATURES:

- UNIX VER 7 compatibility • standard float, double, and long support • run time library with full I/O and source • fast compilation and execution • full language • cross compilers available

AZTEC C II CP/M (MP/M) \$199

- produces relocatable 8080 source code • assembler and linker supplied • M80 interface • SID/ Z80 debugger interface • library utility • APPLE requires 280 and 16K card

AZTEC C II APPLE DOS \$199

- produces fast relocatable 6502 source code • relocating assembler supplied • APPLE SHELL • VED editor • library and other utilities • requires 16K card

AZTEC C86 IBM PC MSDOS CP/M-86 \$249

- produces relocatable 8086/8086 source code • assembler and linker supplied

ORDER BY PHONE OR BY MAIL — Specify products and disk format — Manuals only \$30

## MANX

software systems

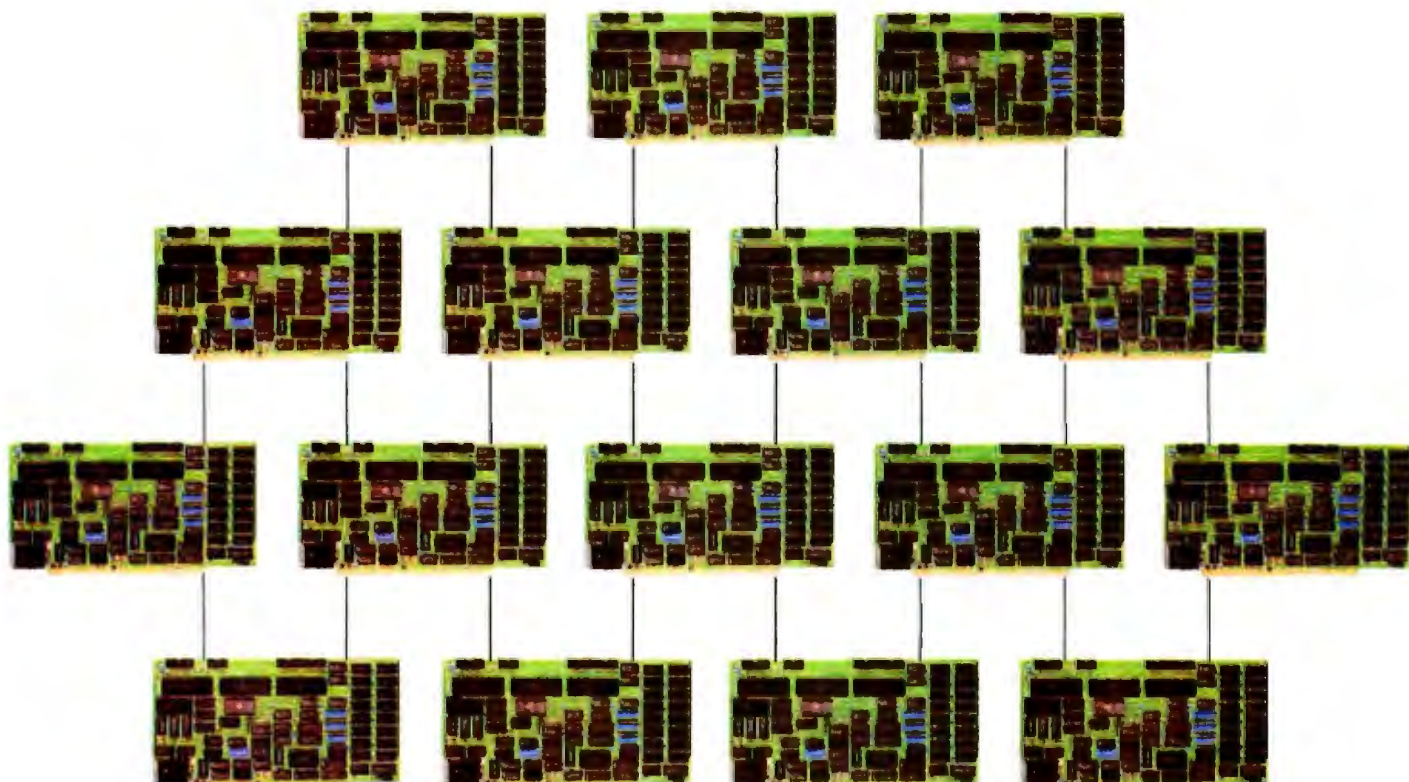
Box 55, Shrewsbury, N.J. 07701 (201) 780-4004



CP/M FORMATS: 8" STD, HEATH, APPLE, OSBORNE, NORTHSTAR OUTSIDE USA — Add \$10  
In N.J. add 6% sales tax



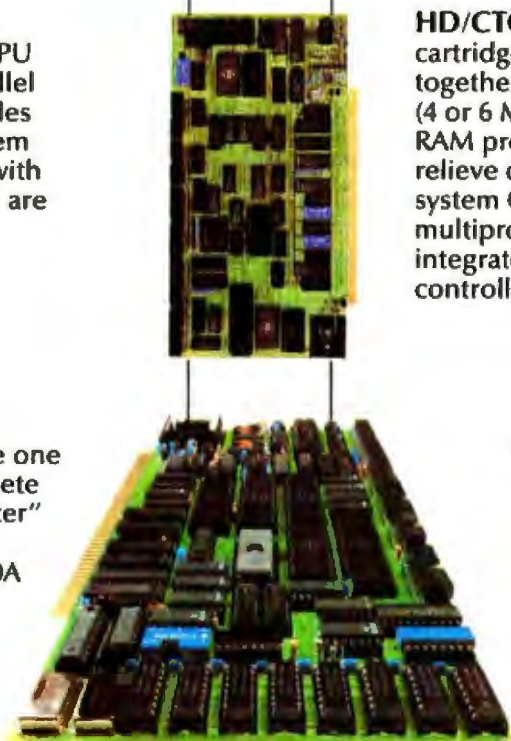
# Now Our Family Tree Is Complete



**SBC-1 (Above)** A multiprocessing slave board computer with Z-80 CPU (4 or 6 MHz), 2 serial ports, 2 parallel ports, and up to 128K RAM. Provides unique 2K FIFO buffering for system block data transfers. When used with TurboDOS or MDZ/OS the results are phenomenal!

**HD/CTC (Left)** A hard disk and cartridge tape controller combined together on one board! A Z-80 CPU (4 or 6 MHz); 16K ROM, and up to 8K RAM provide intelligence required to relieve disk I/O burden from host system CPU. Round out your multiprocessing system with an integrated mass storage/backup controller.

**Systemmaster® (Right)** The ultimate one board computer; use it as a complete single-user system or as the "master" in a multi-processing network environment. Complete with Z-80A CPU, 2 serial and 2 parallel ports, floppy controller, DMA, real time clock, and Teletek's advanced CP/M BIOS. Also supports MP/M-II, MDZ/OS, and TurboDOS.



## TELETEK

9767F Business Park Drive  
Sacramento, CA 95827  
(916) 361-1777  
Telex #4991834  
Answer back-Teletek

Circle 445 on inquiry card.

## Your Single Source Family of S-100 Products.



normally used for storing disks, below the disk drives. A short cable leads to the DB-25 connector directly below (labeled "Modem"). The power for the modem comes from one of the connector's pins. The modem option is intended to help make the Executive a full computer, capable of communications and nearly any job a microcomputer can do.

The software package with the Executive includes the standard items Osborne offers (Wordstar, Supercalc, MBASIC, and CBASIC), the two operating systems (CP/M Plus and UCSD p-System), and some other goodies like Personal Pearl, a database management package.

Osborne is focusing on office productivity tools and will be offering three synchronous communications packages to make communications with the company mainframe or minicomputer easier. The first package is for IBM 3270 terminal emulation; the second has IBM 3780, 2780, and 3741 protocols; the third is for the X.25 protocol. Site licenses for each package will cost about \$1000 but will allow you to use the programs on a number of Executives at one location.

### The Executive II

Interestingly, the designers made provisions for the Executive to become an IBM Personal Computer work-alike. The Executive II is an upgraded Executive with a piggyback coprocessor board inside that contains a 16-bit Intel 8088 microprocessor and 128K bytes of memory for its use and provides 640- by 200-dot monochrome graphics. With this board, the machine should be able to run most IBM PC applications programs.

The MSDOS and CP/M-86 operating systems come with the Executive II, so IBM compatibility is assured at the operating-system, disk-format, and monochrome-graphics levels. As long as programs for the IBM PC don't use special knowledge of the IBM hardware, they should run fine on the Executive II. However, the Ex-

ecutive II does not copy the IBM PC input/output structure exactly.

The IBM Personal Computer disk format is directly supported by MSDOS on the Executive II, so you can just slip in a disk for the PC and run the programs or read the data. Osborne does not offer any 16-bit programs for the Executive II other than the operating systems. You can buy programs in the IBM PC disk format from existing software distributors and computer stores.

One incompatibility in the system is that you can't share memory between the different processors; they each have their own 128K bytes of RAM. However, the Z80 does handle input/output when the 8088 is in control.

You can expand the memory for the 8088 up to 256K bytes simply by filling the rest of the sockets on the coprocessor board with 64K-bit RAM chips. For real memory expandability, just wait until 256K-bit RAM chips become economical. The coprocessor board has a jumper for operation with these chips to give you 1 megabyte of memory in your portable Executive II. If you want color or other IBM accessories, the coprocessor board has a connector for an IBM-compatible expansion bus like the Tecmar PC-Mate.

"When we announce the Executive," Adam Osborne says, "we'll have several thousand in distributors' warehouses. Customers will be able to buy our machines as soon as they've heard about them." You will have to wait a month after the Executive's introduction for the Executive II to be available. A few months later, you will be able to upgrade an Executive into the Executive II when production settles down. Also, the price on the upgrade has not been set.

I didn't get to play with the machines very long, but I liked everything I saw. At \$2495 and \$3195, the Osborne Executive and Executive II are going to be major contenders in the microcomputer market, and not just among the portables, either. ■

The Ultimate A/B Switches

Instant Computer Flexibility

EPSON

PMI

A B

Our commercial quality A/B Switches install quickly and operate efficiently. Elegant, low profile, brushed aluminum cases are tip and slide resistant. The safest, most convenient method of transferring printers, modems, computer ports and other serial or parallel devices. Reliable computer grade printed circuit board construction. Full 5 year limited warranty, made in USA.

	Model 220-\$129 (shown)	Model 225-\$149 (not shown)	Model 236-\$169 (not shown)
#Lines Switched	20	25	36
Compatibility	RS-232C Serial*CCITT V.24	RS-232C Serial or IBM PC™ Parallel	Centronics™ Parallel
Size	1 1/8" h x 7 1/4" w x 5 3/4" d	2" h x 9" w x 6" d	2" h x 9" w x 6" d
Connectors	3 female 25 pin D-Subminiature	3 female 25 pin D-Subminiature	3 female 36 pin Centronics™
Availability	Immediate	June '83	June '83

\*Pins 2 & 12 24 pin 1 bussed, pin 11 tied to pin 19

Call us for the easy way to make your system more capable instantly. Order direct (201) 227-8411 by VISA or MasterCard. Add \$5 postage and handling per order. N.J. residents add 8% sales tax. PMI, 16 Passaic Ave., Fairfield, N.J. 07006

**PMI**

OEM/Dealer inquiries welcome



# IBM® + GENIE™ = Solution

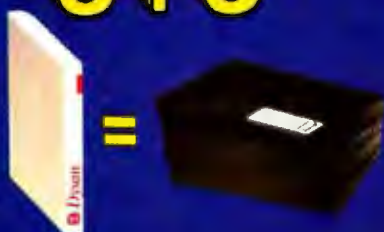
## 5.25" Fixed/Removable Winchester Cartridge Drives For The IBM Personal Computer



**\$3995.00**

- 10 MEGABYTES OF ON-LINE STORAGE
- FILE SIZES TO 5 MEGABYTES
- 5 MEGABYTES BACK-UP IN TWO MINUTES
- CARTRIDGE INTERCHANGEABILITY

**5+5™**



### • THE GENIE CARTRIDGE DRIVE

A revolutionary new 10 Megabyte Hard Disk Drive that includes a 5 Megabyte removable hard disk cartridge. The cartridge drive system simply plugs into your computer, and includes all necessary software and hardware. Genie Drives are compatible with most popular software, and each cartridge replaces over 30 double-density floppy disks.

### • 5.25" REMOVABLE CARTRIDGE

(Proposed ANSI Standard). Imagine, 5 Megabytes in the palm of your hand. These small Winchester cartridges are only .75 inches thick and 5.50 inches square. The disk itself is completely sealed from the outside and all its hazards by a sliding door that opens only once the cartridge is firmly seated inside the drive. Long term availability of this cartridge is assured by its adoption by several well known manufacturers including Dysan, and Memorex, the world leader in computer mass storage media.

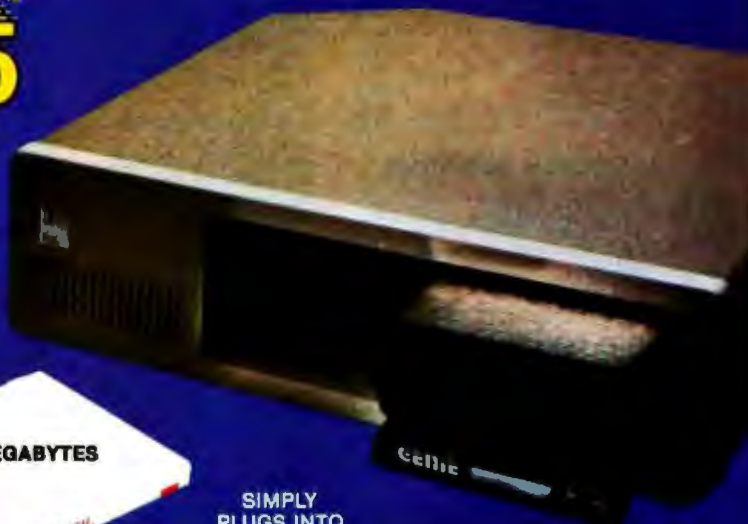


**\$2695.00**

- 5 MEGABYTES OF ON-LINE STORAGE
- FILE SIZES TO 5 MEGABYTES

**X5™**

GENIE SYSTEMS ARE EXPANDABLE UP TO 160 MEGABYTES



SIMPLY PLUGS INTO YOUR I.B.M.

**\$2295.00**



**5-10-15-20**

TALK ABOUT USER FRIENDLY...  
3Com (Etherlink™ Compatible)

- Automatic Install (Genie Custom BIOS)
- Comprehensive menu driven utility package
- Intermix different operating systems on disk or cartridge
- Assign to any drive codes from A thru H;
- Choice of volume sizes
- Give your virtual volumes 16 character names
- Assign command allows you to assign 8 virtual drives on line at any one time
- Show command allows instantaneous viewing of all virtual drives on line
- Help command displays syntax for all new commands
- User can back up to or from any model Genie Drive
- File sizes 5-20 megabytes, dependent upon drive type.

- Automatic recovery system
- Easy back-up in minutes
- Cartridges have 16 character names
- System status screen messages
- Allows you to run with up to four floppy disk drives
- System expandable to eight drives using only one slot in your IBM PC
- Built-in error detection and correction
- No preventative maintenance required
- Power-on self test
- Create turnkey systems
- Ultra hi-speed DMA data transfers
- Comes complete with all necessary software and hardware
- Operating systems supported: IBM DOS CPM-86® CONCURRENT CPM-86®; UCSD® P System; QUNIX™

- 5 MEGABYTES  
**\$2295.00**
- 10 MEGABYTES  
**\$2595.00**
- 15 MEGABYTES  
**\$2895.00**
- 20 MEGABYTES  
**\$3195.00**



Manufacturer's suggested retail price. Includes all required components.  
CPM-86 and Concurrent CPM-86 is a registered trademark of Digital Research.  
IBM is a registered trademark of IBM Corporation.  
Dysan is a registered trademark of Dysan Corporation.  
UCSD P System is a registered trademark of University of California San Diego.  
QUNIX is a registered trademark of Quantum Software System, Inc.  
Etherlink is a registered trademark of 3Com Corporation.  
Ethernet is a registered trademark of Xerox Corporation.  
Memorex is a registered trademark of Memorex Corporation.

AVAILABLE AT YOUR LOCAL COMPUTER DEALER

**GENIE COMPUTER CORPORATION**

31131 Via Colinas #607 • Westlake Village, CA 91362 • (213) 991-6210 • TLX 658233 (GENIE USA)



# Give us a call and it's on its way.

Our inventory is so huge, we've probably got just what you want in stock. We'll ship it out right now. At the right price.

## 16K RAM KITS.....13.95

Set of 8 NEC 4116 200 ns. Guaranteed one year.  
FOR IBM-PC, set of 9..... 15.75

## DISKETTES

### ALPHA DISKS.....21.95

Single sided, certified Double Density 40 Tracks,  
with Hub-ring. Box of 10. Guaranteed one year.

### SCOTCH 3M

S.S.O.DEN 40 TRK..... 23.50  
D.S.O.DEN 40 TRK..... 36.50

### VERBATIM DATALIFE

MD 525-01, 10, 16..... 26.50  
MD 550-01, 10, 16..... 44.50  
MD 557-01, 10, 16..... 45.60  
MD 577-01, 10, 16..... 34.80  
FD 32 or 34-9000..... 36.00  
FD 32 or 34-8000..... 45.60  
FD 34-4001..... 46.60

## DISKETTE STORAGE

5 1/4" PLASTIC LIBRARY CASE..... 2.50  
8" PLASTIC LIBRARY CASE..... 3.50  
PLASTIC STORAGE BINDER w/ Inserts..... 9.95  
PROTECTOR 5 1/4" (50 Disk Capacity)..... 21.95  
PROTECTOR 8" (50 Disk Capacity)..... 24.95  
DISK BANK 5 1/4"..... 5.95  
DISK BANK 8"..... 6.95

## NEC PERSONAL COMPUTERS

Call Alpha Byte for our low NEC prices.

## ALTOS COMPUTER SYSTEMS

Call Alpha Byte for our low Altos prices.

## ATARI

See Apple & Atari Software

SIGNALMAN MODEM..... 85.00  
ATARI 800 (48K)..... \$CALL  
ATARI 400 (16K)..... \$CALL  
ATARI 1200..... \$CALL  
ATARI 810 DISK DRIVE..... 445.00  
ATARI 850 INTERFACE..... 169.00  
IN-HOME KEYBOARD ATARI 400..... 107.00  
ATARI 410 PROGRAM RECORDER..... 75.00  
EPSON CABLE..... 35.00  
JOYSTICK CONTROLLER..... 10.00  
PADDLE CONTROLLERS..... 17.50  
STAR RAIDERS..... 32.00  
DUNKY KONG..... \$CALL  
GALAXIAN..... 32.00  
DEFENDER..... 32.00  
PACMAN..... 32.00  
CENTIPEDE..... 32.00  
TAX ADVANTAGE..... 38.97  
FILE MANAGER 800..... 79.16  
VISICALC..... 189.00  
HOME ACCOUNTANT..... 59.97  
WICO TRACKBALL..... 59.00

## INTEC PERIPHERALS RAM MODULES

48K FOR ATARI 400..... 145.00  
32K FOR ATARI 800..... 87.00

## PRINTERS

STAR MICRONICS GEMINI 10..... \$CALL  
STAR MICRONICS GEMINI 15..... \$CALL  
RIBBONS FOR MX-80..... 8.95  
RIBBONS FOR MX-100..... 24.00  
C-ITOH F-10 40 CPS PARALLEL..... 1390.00  
C-ITOH F-10 40 CPS SERIAL..... 1390.00  
C-ITOH F-10 55 CPS PARALLEL..... 1639.00  
C-ITOH F-10 55 CPS SERIAL..... 1639.00  
C-ITOH PROWRITER PARALLEL..... 410.00  
C-ITOH PROWRITER SERIAL..... 590.00  
C-ITOH PROWRITER II PARALLEL..... 715.00  
C-ITOH PROWRITER II SERIAL..... 767.00  
EPSON MX-80 W/GRAFTRAX PLUS..... \$CALL  
NEW! EPSON FX-80..... \$CALL  
EPSON MX-100 W/GRAFTRAX PLUS..... \$CALL  
EPSON GRAFTRAX PLUS..... 60.00  
COMREX CR-1 PARALLEL..... 799.00  
COMREX CR-1 SERIAL..... 829.00  
COMREX TRACTOR FEED..... 109.00  
NEC 8023A..... 485.00  
NEC SPINWRITER 3530 P. RD..... 1995.00  
NEC SPINWRITER 7710 S. RD..... 2545.00  
NEC SPINWRITER 7730 P. RD..... 2545.00  
NEC SPINWRITER 7700 D SELLUM..... 2795.00  
NEC SPINWRITER 3500 SELLUM..... 2295.00  
OKIDATA MICROLINE 82A..... 460.00  
OKIDATA MICROLINE 83A..... 700.00  
OKIDATA MICROLINE 84..... 1170.00  
OKIGRAPH 82..... 49.95  
OKIGRAPH 83..... 49.95  
MICROBUFFER IN-LINE 32K..... 299.00  
MICROBUFFER IN-LINE 64K..... 349.00  
MICROBUFFER 64K EXPANSION MOD..... 179.00

## BOOKS

THE CUSTOM APPLE..... 24.95  
BASIC BETTER & FASTER DEMO DISK..... 18.00  
THE CUSTOM TRS-80..... 24.95  
MICROSOFT BASIC FASTER & BETTER..... 24.95  
CUSTOM I/O MACHINE LANGUAGE..... 24.95  
TRS-80 DISK & MYSTERIES..... 16.95  
MICROSOFT BASIC & DECODED..... 24.95

## APPLE HARDWARE

SUPER 5 SLIMLINE DRIVE w/ Controller..... 375.00  
QUENTIN APPLEDATE DRIVE..... 258.00  
SUPER CLOCK II..... 129.00  
VERSA WRITER DIGITIZER..... 259.00  
ABT APPLE KEYPAD..... 119.00  
SOFTCARD PREMIUM SYSTEM..... 517.00  
MICROSOFT 2-80 SOFTCARD..... 249.00  
MICROSOFT RAMCARD..... 79.00  
VIDEO 80x24 VIDEO CARD..... 260.00  
VIDEO KEYBOARD ENHANCER II..... 129.00  
VIDEO FUNCTION STRIP..... 74.00  
M & R SUPERTERM 80x24 VIDEO BD..... 315.00  
M & R COOLING FAN..... 44.95  
M & R UNIVERSAL MOD..... 54.95  
T/G JOYSTICK..... 44.95  
T/G PADDLE..... 29.95  
T/G SELECT-A-PORT..... 54.95  
T/G TRACKBALL..... 47.50  
KRAFT JOYSTICK..... 48.00  
VERSA E-Z PORT..... 21.95  
THE MILL-PASCAL SPEED UP..... 270.00  
PROMETHEUS VERSACARD..... 165.00  
MICROBUFFER II 16K W/GRAPHICS..... 259.00  
MICROBUFFER II 32K W/GRAPHICS..... 299.00  
SUPERFAN II..... 82.00

SUPERFAN II W/ZENER..... 84.50  
RANA CONTROLLER..... 104.00  
RANA DRIVE ELITE I..... 335.00  
SNAPSHOT..... 119.00  
GRAPPLER+..... 145.00  
7710A ASYNCHRON. SER. INTERFACE..... 149.00  
7712A SYNCHRON SER. INTERFACE..... 159.00  
7742A CALENDAR CLOCK..... 99.00  
7728A CENTRONICS INTERFACE..... 105.00  
VISTA VISION 80-80 COL. CARD..... 259.00  
VISTA 8" DISK DRIVE CONTROLLER..... 549.00

## MONITORS

USI AMBER 9"..... 145.00  
USI AMBER 12"..... 160.00  
NEC 12" GREEN MONITOR..... 169.00  
NEC 12" COLOR MONITOR..... 399.00  
BMC GREEN MONITOR..... 89.00  
AMDEK COLOR I..... 365.00  
AMDEK RGB COLOR II..... 774.00  
AMDEK RGB INTERFACE..... 169.00  
TAXAN RGB..... 359.00  
TAXAN 12" AMBER..... 125.00

## MOUNTAIN HARDWARE

CPS MULTIFUNCTION BOARD..... 154.00  
ROMPLUS W/ KEYBOARD FILTER..... 165.00  
ROMPLUS W/D KEYBOARD FILTER..... 125.00  
KEYBOARD FILTER ROM..... 49.00  
COPYROM..... 49.00  
MUSIC SYSTEM..... 369.00  
ROMWRITER..... 149.00  
MICROSOFT CHASSIS..... 580.00  
RAMPLUS 32K..... 160.00

## S-100 HARDWARE

### CALIFORNIA COMPUTER SYSTEMS

2200A MAINFRAME..... 459.00  
2085C 64K DYNAMIC RAM..... 539.00  
2422 DISK CONT. & CP/M®..... 359.00  
2710 4 SERIAL I/O..... 279.00  
2719 2 SERIAL / 2 PARALLEL I/O..... 289.00  
2720 4 PARALLEL I/O..... 219.00  
2810 Z-80 CPU..... 259.00

### QT PRODUCTS

MF+DDR..... 682.00  
MF+DD12..... 716.00

### COMREX

"THE TIMEPIECE" S-100 CLOCK..... 125.00

## MODEMS

NOVATION J-CAT..... 125.00  
NOVATION SMARTCAT 212..... 499.00  
NOVATION SMARTCAT..... 209.00  
NOVATION D-CAT (1200 Baud)..... 619.00  
NOVATION APPLE-CAT (300 Baud)..... 310.00  
NOVATION APPLE-CAT (1200 Baud)..... 605.00  
UDS 212 LP (1200 Baud)..... 429.00  
UDS 103 JLP AUTO ANS..... 209.00  
HAYES MICROMODEM II..... 289.00  
MICROMODEM W/ TERMINAL PKG..... 309.00  
HAYES 100 MODEM (S-100)..... 325.00  
HAYES SMART MODEM (300 Baud)..... 227.00

HAYES SMART MODEM (1200 Baud)..... 540.00  
HAYES CHRONOGRAPH..... 199.00  
SIGNALMAN MODEM W/RS-232C..... 85.00

## TERMINALS

HAZELTINE ESPRIT..... 510.00  
VISUAL-50 GREEN..... 690.00  
TELEVIDEO 910..... 630.00

## TRS-80 MOD I HARDWARE

PERCOM DATA SEPARATOR..... 27.00  
PERCOM DOUBLER II W/DOS 3.4..... 159.00  
4 DRIVE CONTROLLER P/S..... 259.00  
TANDON 40 TRK DISK DRIVE W/P.S..... 289.00  
LNW DOUBLER W/DOSPLUS 3.3..... 138.00  
LNW 5/8 DOUBLER W/DOSPLUS 3.4..... 181.00  
LNW EXPANSION INTERFACE..... 350.00

## IBM HARDWARE

SEATTLE 64K RAM+..... 355.00  
QUADBOARD 64K..... 430.00  
64K MEMORY UPGRADE..... 80.00  
APPARAT COMBO BOARD..... 175.00

## ALPHA BYTE IBM MEMORY EXPANSION BOARDS

256K W/RS-232C..... 349.00  
256K W/RS-232C & SUPERCALC..... 529.00  
512K W/RS-232C..... 579.00  
512K W/RS-232C & SUPERCALC..... 749.00

## IBM DISK DRIVES

Alpha Byte's add-on drive kits for the IBM-PC --  
each kit includes installation instructions.  
Tandon TM100-1 Single head 40 trk..... 195.00  
Tandon TM100-2 Double head 40 trk..... 262.50

## ISOLATORS

ISO-1 3-SOCKET..... 49.95  
ISO-2 6-SOCKET..... 49.95

## BARE DRIVES

### TANDON 5 1/4 INCH

100-1 SINGLE HEAD 40 TRK..... 195.00  
100-2 DUAL HEAD 40 TRK..... 262.50  
100-3 SINGLE HEAD 80 TRK..... 250.00  
100-4 DUAL HEAD 80 TRK..... 369.00

### TANDON THINLINE 8 INCH

848-1 SINGLE SIDE..... 379.00  
848-2 DUAL SIDE..... 490.00

## MICROSOFT

### APPLE

FORTRAN®..... 150.00  
BASIC COMPILER\*..... 296.00  
COBOL®..... 550.00  
Z-60 SOFTCARD..... 249.00  
RAMCARD..... 79.00  
TYPING TUTOR II..... 17.95  
OLYMPIC DECATHLOW..... 24.95  
TASC APPLESOFT COMPILER..... 125.00  
ALDS..... 95.00  
MULTIPLAN NATIVE OR CP/M..... 209.00  
PREMIUM PAK..... 517.00



## MICRO PRO

### APPLE CP/M®

WORDSTAR*1	279.00
SUPERSORT*1	179.00
MAILMERGE*1	174.00
DATASTAR*1	207.00
SPELLSTAR*1	174.00
CALCSTAR*1	109.00

## TRS-80 GAMES

Specify MOD I or III

DEADLINE	38.00
STARCRSS	31.16
FROGGER	16.45
FLITE SIMULATOR	28.31

Call for more TRS-80 games.

## TRS-80 SOFTWARE

NEWDOS/80 2.0 MOD I,III	139.00
LAZY WRITER MOD I,II	165.00
PROSOFT NEWSWSCRIPT MOD I,III w/labels	109.00
SPECIAL DELIVERY MOD I,III	119.00
X-TRA SPECIAL DELIVERY MOD I,III	199.00
TRACKCESS MOD I	24.95
OMNITERM SMART TERM.MOD I,III	89.95
MICROSOFT BASIC COMP. FOR MOD I,III	165.00
LDOS 5.1 MOD I,III	119.00

## IBM SOFTWARE

MULTIPLAN	209.00
INFOSTAR	279.00
HOWARD SOFT TAX PREP	209.00
YOLKSWRITER V 1.2	145.00
WRITE ON	90.00
EASYWRITER II	247.00
EASY SPELLER	149.00
EASY FILE	285.00
HOME ACCOUNTANT +	105.00
FIRST CLASS MAIL	85.00
SUPERCALC	179.00
WORDSTAR	279.00
MAILMERGE	174.00
DATASTAR	207.00
SPELLSTAR	174.00
SUPERSORT	179.00
d BASE II	429.00
THE WORD PLUS	117.00
T.I.M.	379.00
JFORMAT	39.00
MOVE IT	109.00
THE TAX MANAGER	188.00
VISICALC / 256K	189.00
VISITREND / VISIPLLOT	235.00
VISIDEX	192.00
VISIFILE	249.00
VISISCHEDULE	229.00
VERSA WRITER GRAPHICS TABLETS	270.00
CONCURRENT CP/M® 86	315.00
GRAPHICS HARD COPY SYSTEM	19.50

Call for additional IBM software prices

## IBM GAME SOFTWARE

ZORK I, II, III	28.00
WIZARDRY	46.75
STARCROSS	28.00
DEADLINE	35.00
GALAXY	19.50
MIDWAY CAMPAIGN	17.00
THE WARP FACTOR	31.16
LOST COLONY	23.36
CONQUEST	23.36
GALACTIC ATTACK	25.00
APPLE PANIC	23.61
TEMPLE OF ASPHAL	34.95
CROSSFIRE	24.95
FROGGER	27.26
M'SOFT FLIGHT SIMULATOR	38.95

If you don't see the software you want, call. Our software stock is constantly expanding.

## APPLE SOFTWARE

HOWARD SOFT TAX PREP	189.00
MAGIC WINDOW II	117.00
MAGIC WINDOW	79.00
MAGIC WORDS	59.00
MAGIC MAILER	59.00
DB MASTER	169.00
DB MASTER UTILITY PACK I OR II	69.00
DATA CAPTURE 4.0/80	59.95
PFS. GRAPH	89.95

PFS (NEW) PERSONAL FILING SYSTEM	85.00
PFS: REPORT	79.00
Z-TERM*	89.95
Z-TERM PRO*	129.95
ASCII EXPRESS PRO.	98.00
EASY WRITER-PRO	136.00
EASY MAILER-PRO	117.00
BEAGLE BROTHERS UTILITY CITY	23.00
APPLE MECHANIC	23.00
TIP DESK #1	15.95
BEAGLE BAG	23.00
SUPER TEXT 40/56/77	97.50
LISA 2.5	59.95

DATASTAR	207.00
SPELLSTAR	174.00
CALCSTAR	169.00

## MICROSOFT

MULTIPLAN	209.00
BASIC 80	249.00
BASIC COMPILER	299.00
FORTRAN 80	359.00
COBOL 80	585.00
MACRO 80	156.00
mu MATH/mu SIMP	200.00
mu LISP/mu STAR	165.00

COSMO MISSION	23.36
WIZARDRY	37.95
NIGHT OF DIAMONDS	27.26
STARBLAZER	24.95
CRISIS MOUNTAIN	26.32
EVOLUTION	33.80

## SIRIUS SOFTWARE

SPACE EGGS	23.36
GORGON	31.16
SNEAKERS	23.36
PHANTOMS FIVE	22.00
BANDITS	25.00

## EDU-WARE

PERCEPTION PKG	19.95
COMPU-MATH: ARITHMETIC	39.95
COMPU-SPELL (REQ. DATA DISK)	24.95
COMPU-SPELL DATA DISKS 4-8, ea.	17.95
RENDEZVOUS	28.50

## ON-LINE SYSTEMS

ULTIMA II	42.00
MISSILE DEFENSE	27.26
LUNAR LEEPER	23.36
TIME ZONE	77.96
CRANSTON MANOR	25.95
CANNON BALL BLITZ	25.95

## MUSE SOFTWARE

ROBOT WARS	32.95
THREE MILE ISLAND	31.61
A.B.M.	19.46

# 1983 Word Processor Special

FRANKLIN ACE 1000	1395.00
FRANKLIN ACE SYSTEM DISK DRIVE W/ CONT.	539.00
ACE WRITER WORD PROCESSOR	129.00

EPSON MX-80	645.00
B.M.C. GREEN	129.00
SCOTCH 3M DISKETTES	44.00
APPLE TO EPSON INTERFACE & CABLE	129.00

~~\$3910~~

Now \$1983

\*\* FRANKLIN 1200.....CALL \*\*

This system may be modified to your needs. Call for special price quote.

TRANSCEND II	115.00
SCREENWRITER II	99.00
DICTIONARY	79.00
GENERAL MANAGER	179.00

## CONTINENTAL SOFTWARE

G/L	165.00
A/R	165.00
A/P	165.00
PAYROLL	165.00
PROPERTY MGMT	325.00
THE HOME ACCOUNTANT	59.95
F.C.M. w/term letter	75.00
TAX ADVANTAGE	45.00

## VISICORP

DESKTOP PLAN II	189.00
VISIPLLOT	158.00
VISITREND/VISIPLLOT	229.00
VISIDEX	189.00
VISITERM	79.00
VISICALC	189.00
VISIFILES	189.00
VISISCHEDULE	229.00

## CP/M® SOFTWARE

We carry CP/M® software in all popular disk formats — Northstar, Televideo, and Heath/Zenith formatted programs in stock! Call for availability and price. Most software also available on IBM.

THE WORD PLUS	117.00
d BASE II	429.00
QUICKCODE	230.00
DUTIL	91.00
SUPERCALC	189.00
SPELLGUARD	230.00
P & T CP/M® MOD 2 & 16 TRS-80	175.00
PASCAL Z	349.00
PASCAL/M Z-80 OR 8080	295.00

## DIGITAL RESEARCH

MAC	82.00
ZSID	92.00
PASCAL MT+ W/ SSP	429.00
PL/1-80	439.00
C BASIC 2	109.00

## SUPERSOFT

DIAGNOSTIC II	89.00
'C'COMPILER	179.00
RATFOR	89.00
FORTRAN	239.00
DISK DOCTOR	78.00

## MICROPRO

WORDSTAR	279.00
SUPERSORT	179.00
MAILMERGE	174.00

## APPLE & ATARI GAMES

ZAXXON	31.16
BRODERBUND	
APPLE PANIC	23.61
MIDNIGHT MAGIC	27.26
CHDLIFTER	27.20

## AUTOMATED SIMULATIONS

INVASION ORION	20.95
STAR WARRIOR	31.35
CRUSH, CRUMBLE AND CHOMP	24.95
TEMPLE OF APSHAL	31.35
HELLFIRE WARRIOR	31.35
RESCUE AT RIGEL	23.36

## ON-LINE SYSTEMS

WIZARD AND PRINCESS	27.26
SOFT PORN ADVENTURE	23.36
THRESHOLD	31.16
JAW BREAKER	23.36
CROSSFIRE	24.95
ULYSSES & GOLDEN FLEECE	25.95
FROGGER	24.50

## INFOCOM

ZORK I,II,III	28.00
STARCROSS	28.00
DEADLINE	35.00

## EDU-WARE

COMPU-READ	24.95
COMPU-MATH FRACTIONS	34.95
COMPU-MATH DECIMALS	34.95

## MORE GREAT APPLE GAMES

DARK CRYSTAL	31.61
TUBEWAY	27.26
ARCADE MACHINE	44.38
TUES. MORNING QUARTERBACK	25.95
THE SPACE VIKINGS	38.50
COMPUTER QUARTERBACK	31.16
SEA FOX	24.00
THE SHATTERED ALLIANCE	49.95
POOL 1.5	27.26
ULTIMA	31.16
RASTER BLASTER	23.36
FLIGHT SIMULATOR	26.61
INTERNATIONAL GRAND PRIX	25.95
SARGON II	28.95
MASK OF THE SUN	31.16
A.E.	23.72
PINBALL SUBLOGIC	24.50
SNACK ATTACK	23.36
BUDGEBO PINBALL CONST SET	31.61
THIEF	24.95
THE WARP FACTOR	31.16

To order or for information call

In Chicago:

(312) 454-1236

In New York:

(212) 509-1923

In Los Angeles:

(213) 706-0333

In Dallas:

(214) 744-4251

By Modem:

(213) 991-1604

CALL OUR MODEM LINE FOR WEEKLY SPECIALS.

# Alpha Byte

## COMPUTER PRODUCTS

31245 LA BAYA DRIVE  
WESTLAKE VILLAGE, CA 91362

**Satisfaction Assurance** — Your satisfaction is assured by our 30 day moneyback guarantee on all hardware products we sell. No refunds after 30 days. All manufacturers' warranties are supported. Defective software will be replaced free during the first 30 days; however, no refunds or exchanges on software. Proof of purchase required. All returns must be authorized in advance. How To Order — All orders must be paid prior to shipment. Order by phone or by mail. Use Visa, M/C, check or COD. COD limit \$300. Shipping charges: Visa, M/C orders = actual shipping costs. Prepaid orders add \$3 (under 25lbs.) or \$5 (over 25lbs.) COD's use prepaid rates and add \$4 surcharge. Foreign, FPO and APO orders add 15% of order total. Calif. orders add 6% sales tax, L.A. County add 6 1/2% sales tax. Prices quoted are subject to product availability and may change without notice.



# Powerful CP/M Software.

For Apple, Osborne, Xerox, Kaypro, North Star, SuperBrain, Heath/Zenith, and others.

Now only **\$29.95** each!

## NEVADA COBOL

was \$199.95 now only **\$29.95.**

When we introduced Nevada COBOL in 1979, it was loaded with innovations. Today's Edition 2 is even better!

- Extremely Compact. You can compile and execute up to 2500 statements in 32K RAM, 4000 statements in 48K, etc.
- It's based upon the ANSI-74 standards with level 2 features such as compound conditionals and full CALL CANCEL.
- You can distribute your object programs royalty FREE!
- You get a diskette, 153-page manual with lots of examples and 16 complete COBOL source code programs.

Also available: COBOL Application Packages, Book 1 \$9.95

## NEVADA PILOT

was \$149.95 now only **\$29.95.**

- Perfect for industrial training, office training, drill and testing, virtually all programmed instruction, word puzzle games, and data entry facilitated by prompts.
- John Starkweather, Ph.D., the inventor of the PILOT language, has added many new features to Nevada PILOT. There are commands to drive optional equipment such as Video Tape Recorders. There's a built-in full-screen text editor, and much more.
- Meets all PILOT-73 standards for full compatibility with older versions.
- You get a diskette, 114-page manual and ten useful sample programs.
- See Review in *Microcomputing*, January 1983, page 158.

## NEVADA FORTRAN

was \$199.95 now only **\$29.95.**

- Based on ANSI-66 standards with some 1977 level features.
- IF . . THEN . . ELSE constructs.
- A very nice TRACE style debugging.
- 150 English language error messages.
- You get a diskette, 174 pages of Documentation and five sample programs. Requires 48K RAM.

## NEVADA EDIT

was \$119.95 now only **\$29.95.**

- High quality text editing for micros!
- A character-oriented full-screen video display text editor designed specifically to create COBOL, BASIC and FORTRAN programs.
- Completely customizable tab stops, default file type, keyboard control key layout and CRT by menu selection.
- The diskette comes with an easy to read manual.

To make our software available to even more micro users, we've slashed our prices. What's more, we're offering a money back guarantee. If for any reason you're not completely satisfied, just return the package—in good condition with the sealed diskette unopened—within 30 days and we'll refund your money completely.

This is a limited time offer, so order yours today!

**Shipping/handling fees.** Add \$4.00 for first package and \$2.00 each additional package. OVERSEAS Add \$15.00 for first package and \$5.00 each additional package. Checks must be in U.S. funds and drawn on a U.S. bank!

Trademarks: CP/M, Digital Research; TRS-80, Tandy Corp.; TeleVideo, TeleVideo Systems, Inc.; Apple II, Apple Computer Inc.; Osborne 1, Osborne Computer Corp.; Xerox 820, Xerox Corp.; Kaypro, Non-Linear Sys.; Heath/Zenith, Heath Co.; IBM, International Business Machine, Corp. © 1983 Ellis Computing

MAIL TODAY! To: Ellis Computing  
3917 Noriega St.  
San Francisco, CA 94122  
(415) 753-0186



ELLIS COMPUTING

The CP/M-80 Operating Systems and 32K RAM are required.

Indicate diskette format:

- 8"  SSSD (Standard IBM 3740 format)
- 5¼"  Apple CP/M  Osborne
- North Star DD  North Star SD
- TRS-80 Mod I (4200 hex)  TRS-80 Mod I/Mapper
- Heath, Hard Sector  Heath, Soft Sector
- Micropolis Mod II  Superbrain DD DOS 3.X (512 byte sectors)
- Xerox 820 (Kaypro)  TeleVideo

Indicate software packages:  COBOL  PILOT  
 FORTRAN  EDIT

Send my order for \_\_\_\_\_ packages @ \$29.95 each Total \_\_\_\_\_  
COBOL Applications Package @ \$9.95 each Total \_\_\_\_\_

Check enclosed In CA add sales tax \_\_\_\_\_  
Shipping/handling \_\_\_\_\_

MasterCard  VISA TOTAL \_\_\_\_\_

# \_\_\_\_\_ Exp. Date \_\_\_\_\_

Signature \_\_\_\_\_

Ship to:  
Name \_\_\_\_\_

Street \_\_\_\_\_

City/ST/Zip \_\_\_\_\_

Country \_\_\_\_\_



## Build an RS-232C Code-Activated Switch

*This device will let you switch between several peripherals connected to one serial port.*

---

Steve Ciarcia  
POB 582  
Glastonbury, CT 06033

---

Do you ever find yourself probing through a mass of tangled cables behind your computer? If your computer is like mine, you probably have only one serial port, to which you have to connect both a printer and modem. Of course, whenever you want to use a different peripheral, you have to unplug one and plug in the other.

The variety of peripheral devices necessary to gain full use of a personal computer can create a connection jam at the serial port. Many small computer systems have two I/O (input/output) ports intended to support a printer and modem. Usually the port intended for connection to the printer is a parallel port (although many printers require a serial port), while a serial port (perhaps called a "communications port") is provided for connection to a modem. For the typical user, this may be adequate.

Some of us, however, aren't typical users; we have more than one printer and one modem attached to our computer, or our printer uses a serial interface, not a parallel one. I have three serial printers and two modems, all of which I must connect to my workhorse computer system through a single RS-232C serial port. (It's not that my computer is a small configuration: it has eight parallel ports in addition to the one serial port. It's just that every new peripheral device I buy seems to be serially interfaced, and I can't fit any more serial ports inside the already crowded enclosure.

Recently, while juggling three cables and leaning over the computer, I began to wish for an easier way to switch between devices. I wondered if I could just put together a little box containing a multiple-pole rotary switch wired to a few DB-25 connectors as a workable compromise. But then I thought of a possible better solution as I remembered something I had seen in a catalog of data-communication products: a device called a code-activated switch.

### Functional Analysis

The function we need here is the ability to multiplex—switch between as needed—several peripheral devices

connected to a single I/O channel. A *communications multiplexer* performs this function. In essence, this device forms a bridge in the communication link between the master device (usually the host computer's I/O port) and one of several slave devices; transfer of data can proceed in either direction over this bridge. The physical linking of the input and output can be accomplished either mechanically or electronically.

### Two Approaches to Switching

The simplest possible device for the purpose is a four-position mechanical switch box. Available commercially for about \$150, a DB-25 switch box allows you to select one of four peripherals for output by turning a four-position multipole rotary switch. This manually activated switch is most frequently used where the peripherals, computer, and operator are in close proximity. Its major advantage is its relative low cost.

Unfortunately, mechanical switches are subject to deterioration from the elements and, of course, require a human operator to function. Harsh environments call for fully electronic switches. In situations where the communicating devices are at great distances from the computer, some

---

Copyright © 1983 Steven A. Ciarcia.  
All rights reserved.

---

---

Z8 is a trademark of Zilog Inc.  
Special thanks to Bill Curlew for his  
Z8-programming expertise.

---



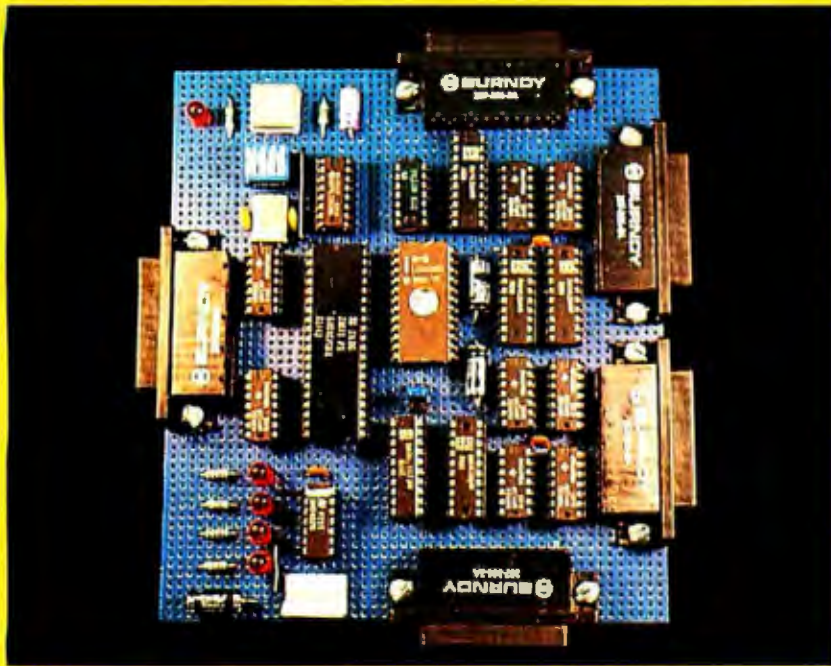


Photo 1: Prototype of the Micromux four-channel code-activated switch, built around a Zilog Z8 single-chip microcomputer.

form of remote-controlled switch must be used. An ordinary electrical relay can provide remote control, but the greatest flexibility and reliability are obtained from a fully electronic, software-controlled, code-activated peripheral-device switch. Let's look at some of the possibilities.

### Electronic Switches

Figure 1a is a simple block diagram of a four-channel electronic RS-232C multiplexer switch. The master input on the left side is intended to be connected to a computer's I/O port and the four channels on the right side are intended to be connected to four peripheral devices. (In the following discussion, the assumption will be that data is being transmitted by the master device to one of the slave devices, although data can also move in the other direction.)

On the left side of the electronic multiplexer, the input serial data from the master device (the computer) is converted from RS-232C

(1a)

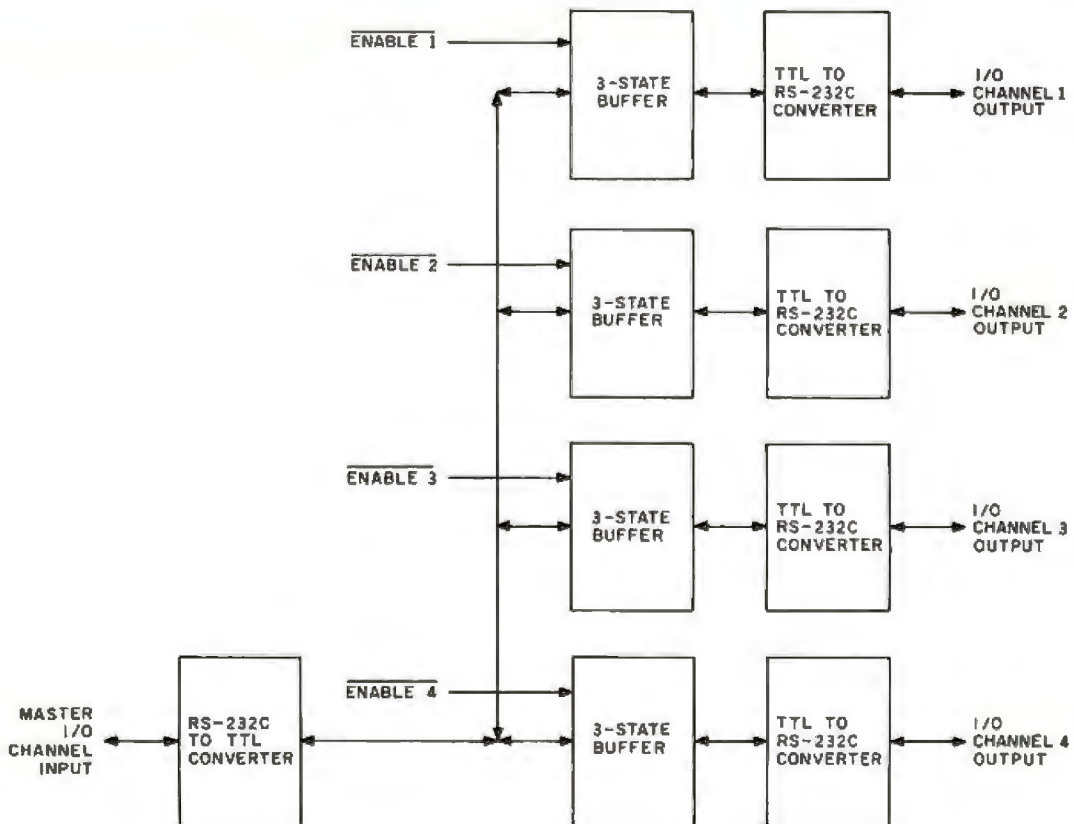


Figure 1a: Block diagram of a four-channel peripheral switch for RS-232C serial communication, which may be controlled via wired remote activation or code activation.







(1c)

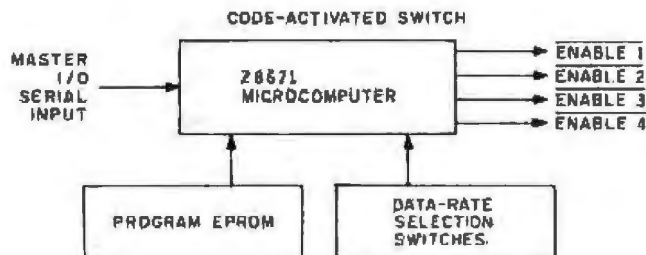


Figure 1c: Functional diagram of a Z8671 microcomputer chip (variant of a Zilog Z8) as it would be used to control a four-channel code-activated peripheral switch.

by the Z8671 to control the four-channel switch are shown in figure 1c.

Much of the hardware and many of the software subroutines required for the task are built into the Z8671 already. This Zilog product contains 256 bytes of RAM (random-access read/write memory), a serial port, two counter/timers, two parallel ports, and a 2K-byte tiny-BASIC (BASIC/Debug) interpreter within a single integrated-circuit package. Combined with a type-2716 EPROM (erasable programmable read-only memory) and a data-rate-selection switch, the five-chip Z8-BASIC Microcomputer system can be easily programmed to monitor RS-232C serial communications and switch channels on cue. The control program can be written in either BASIC or assembled machine language, as you will see.

Figure 2 on page 53 is the schematic diagram of the Micromux. IC1 is the Z8671. Its serial input line (SI) is tied directly to the data input of the master input channel (RD). Four of the Z8671's port-2 output lines serve as the enable inputs to the three-state signal buffers. The program that controls the computer and analyzes the data transmissions has been written into the 2716 EPROM, IC2. IC3 is an 8-bit latch which holds the 8 low-order address bits (from the Z8's multiplexed outputs) during memory and I/O operations. IC5 is configured as a memory-mapped address decoder that enables IC4 when any address over hexadecimal C000 is accessed.

The data rate is selected by the switch settings on the input of IC4. When the system is powered up, these

data-rate switches are read (as memory location hexadecimal FFFE) and used to set a counter/timer that divides the signal from the 7.3728-MHz crystal. The data rates that may be thus selected include 110, 150, 300, 1200, 2400, 4800, and 9600 bps (bits per second).

The integrated circuits IC6 through IC9 are type-74LS244 three-state signal buffers. Nothing flows through them unless their active-low enable lines, pins 1 and 19, are at logic 0. IC18 is a type-7407 buffer/driver, which lights one of four LEDs (light-emitting diodes) to show the enabled channel.

RS-232C drivers and receivers are provided, appearing in the schematic as IC10 through IC17. I chose to use only the six most frequently used RS-232C communication signals in this circuit. If you need additional signals, then you'll have to include more three-state signal buffers and driver/receivers. Conversely, if you need only Received Data and Transmitted Data (pins 2 and 3), then you'll need fewer chips in your code-activated switch. (Six signals—Received Data, Transmitted Data, Clear to Send, Ready to Send, Data Set Ready, and Data Terminal Ready—were as many as I was willing to wire by hand.)

### Programming the Micromux

The Z8671 can be programmed in either tiny BASIC or assembly language. The primary difference is speed. With the Z8671 set to receive data at 9600 bps, only a machine-language program would execute fast enough to digest the data and make control decisions at that rate. But for slower data rates where there is more

Number	Type	+5V	GND	-12V	+12V
IC1	Z8671	1	11		
IC2	2716/32	24	12		
IC3	74LS373	20	10		
IC4	74LS367	16	8		
IC5	74LS10	14	7		
IC6	74LS244	20	10		
IC7	MC1489	14	7		
IC8	MC1488	7	1	14	
IC9	7407	14	7		

Table 1: Power connections for the integrated circuits of figure 2.

time for the processor to react, using BASIC makes the programming task easier.

For a multiplexer to switch quickly between four different output channels, four distinct character codes are required. These codes can be single ASCII (American National Standard Code for Information Interchange) characters such as the letters A, B, C, and D or sequences of characters such as "\$%&1", "\$%&2", "\$%&3", and "\$%&4". However, because the code-activated switch relies upon the data stream to contain its control codes, it's important that the channel-activation codes be different from any character sequences appearing in the data transmissions, or false channel selection may occur. Obviously, we would not choose the letter A as a practical selection code in most applications, so we choose some multicharacter sequence that would be unlikely to appear. For instance, you would probably never need to print the sequence "\$%&1", and it could be used to designate a switch to a printer connected to output channel 1. Similarly, "\$%&4" would enable channel 4.

Because the sequence-recognition time is dependent on the code length, an alternative is to use single *non-printing* characters such as Control-A or Control-D. A single-character switch-control code is recognized faster than a three- or four-character code. When using a machine-language program running at 8 MHz the difference is hardly significant, but in BASIC the difference could be considerable.

### Micromux Control in BASIC

At this point, let's look at how the



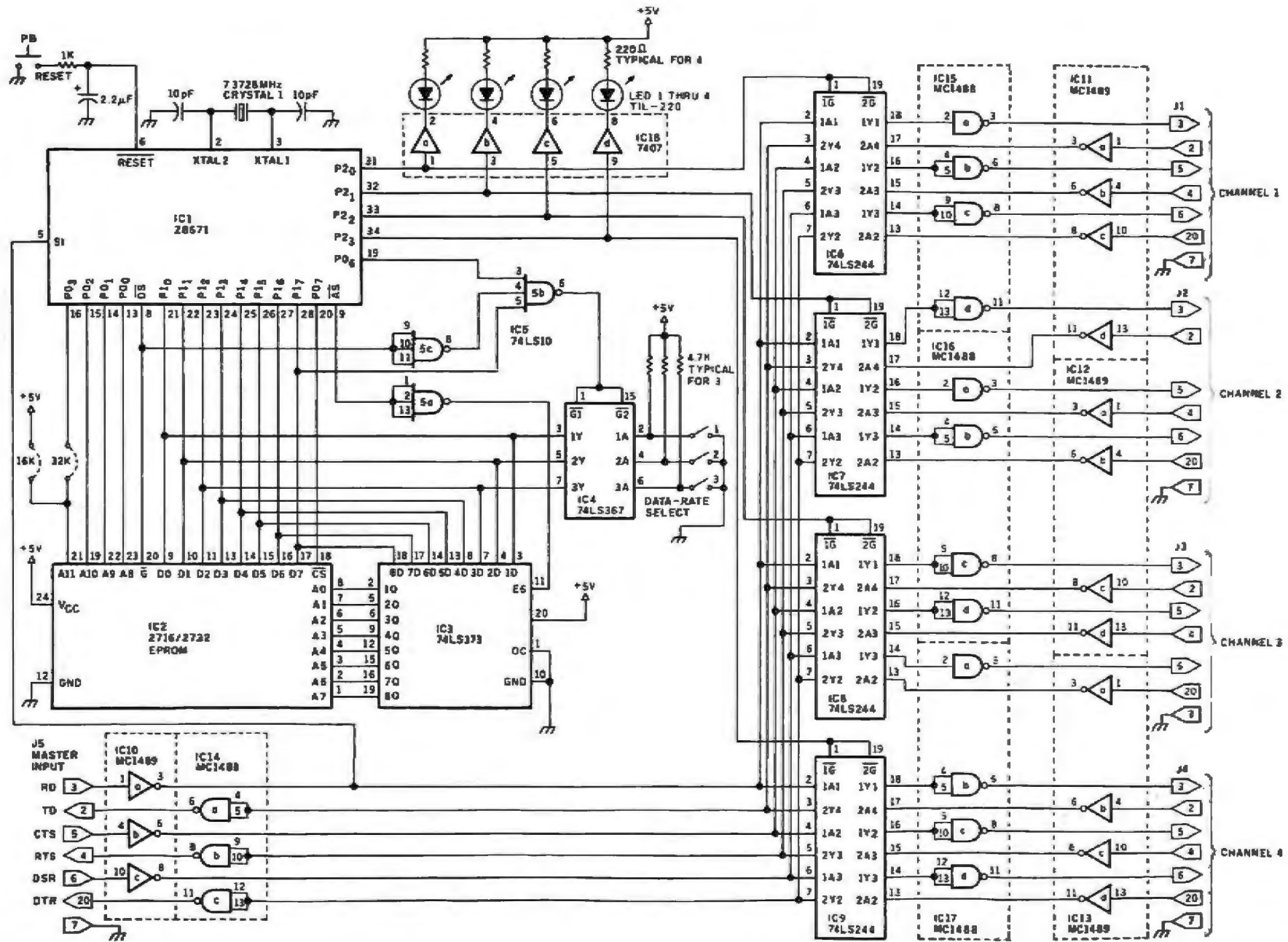


Figure 2: Schematic diagram of the Micromux prototype four-channel code-activated switch. This design uses a Z8671 as a controller to monitor codes embedded in the transmitted data and activate the appropriate signal buffer for the channel. Only the six

most used RS-232C signals are wired here; the addition of more buffer chips would allow switching of more RS-232C signals. Power connections are shown in table 1 on page 52.



Micromux might function with the Z8671 programmed in BASIC.

First, assuming that the switch is to be used only with printers and modems that use printable ASCII characters and commonly used control codes (Return, Backspace, Delete, etc.), I chose the four non-printing characters Control-A, Control-B, Control-C, and Control-D to select the four output channels. For example, when the program sees a Control-C, it activates the enable line to the three-state signal buffer for

channel 3.

Figure 3 is a flowchart of a control program written for the Z8-BASIC/Debug interpreter that obeys this convention. The program is seven lines long, as follows:

```

10 @246=0 : @2=255
20 X=@240 : IF X>4 THEN 20
30 IF X=1 THEN @2=254 : GOTO 20
40 IF X=2 THEN @2=253 : GOTO 20
50 IF X=3 THEN @2=251 : GOTO 20
60 IF X=4 THEN @2=247 : GOTO 20
70 GOTO 10
  
```

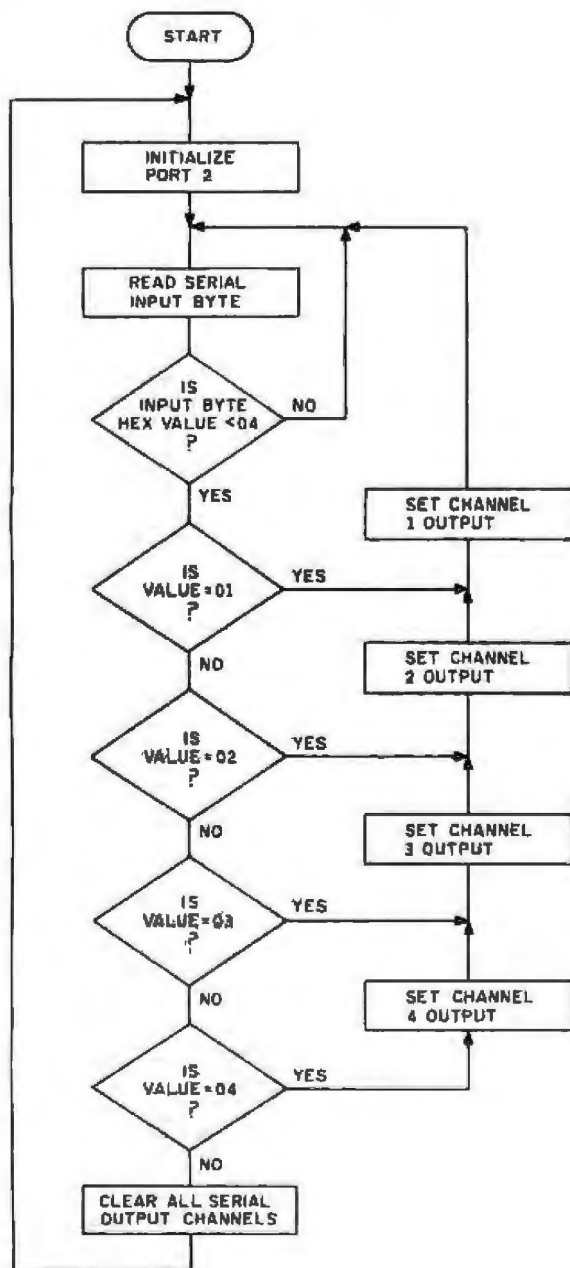


Figure 3: Flowchart of a Z8-BASIC/Debug program to control the four-channel code-activated switch at low data rates.

Line 10 configures port 2 for output and sets all enable lines to a logic 1 (not activated). Line 20 examines the serial input register of the Z8 and checks to see if its value is greater than 4. The only ASCII characters with values of 4 or less are the select codes mentioned above plus Control-@. Lines 30 through 60 set the output of the Z8's port 2 according to the control convention or, if a Control-@ is read, to disable all output channels. If the character coming in over the serial input line is not one of these control characters (that is, if its value is greater than 4), the character is sent on to the current output channel (if any), and the port is read again.

Because the read-and-analyze routine is a single program line which returns to itself, it operates fairly fast. The Z8 can be set for any of the 7 common data rates between 110 and 9600 bps. If the multiplexer channel is set before the transmission starts, or if the control code is the very last character in a particular message, then the data rate is irrelevant to the proper functioning of the program. It is only when the control code is embedded in a significant character stream that speed of execution is a consideration.

Regardless of the data rate, about 40 ms (milliseconds) are required to analyze a serial character using this program. As long as a delay of 40 ms is allotted after any of the 5 control codes is sent, the code-activated switch will respond properly. Another possibility is to put several of the same control codes in series so that the program will catch at least one of them.

### Machine-Language Control

For the hasty folk who like to send and switch data at 9600 bps, we have to use a machine-language program. A flowchart of such a program is shown in figure 4 on page 55. The increased processing speed using machine language allows us to use more characters in the switch-control code sequence and lessens the likelihood of confusion with data passing through the switch.



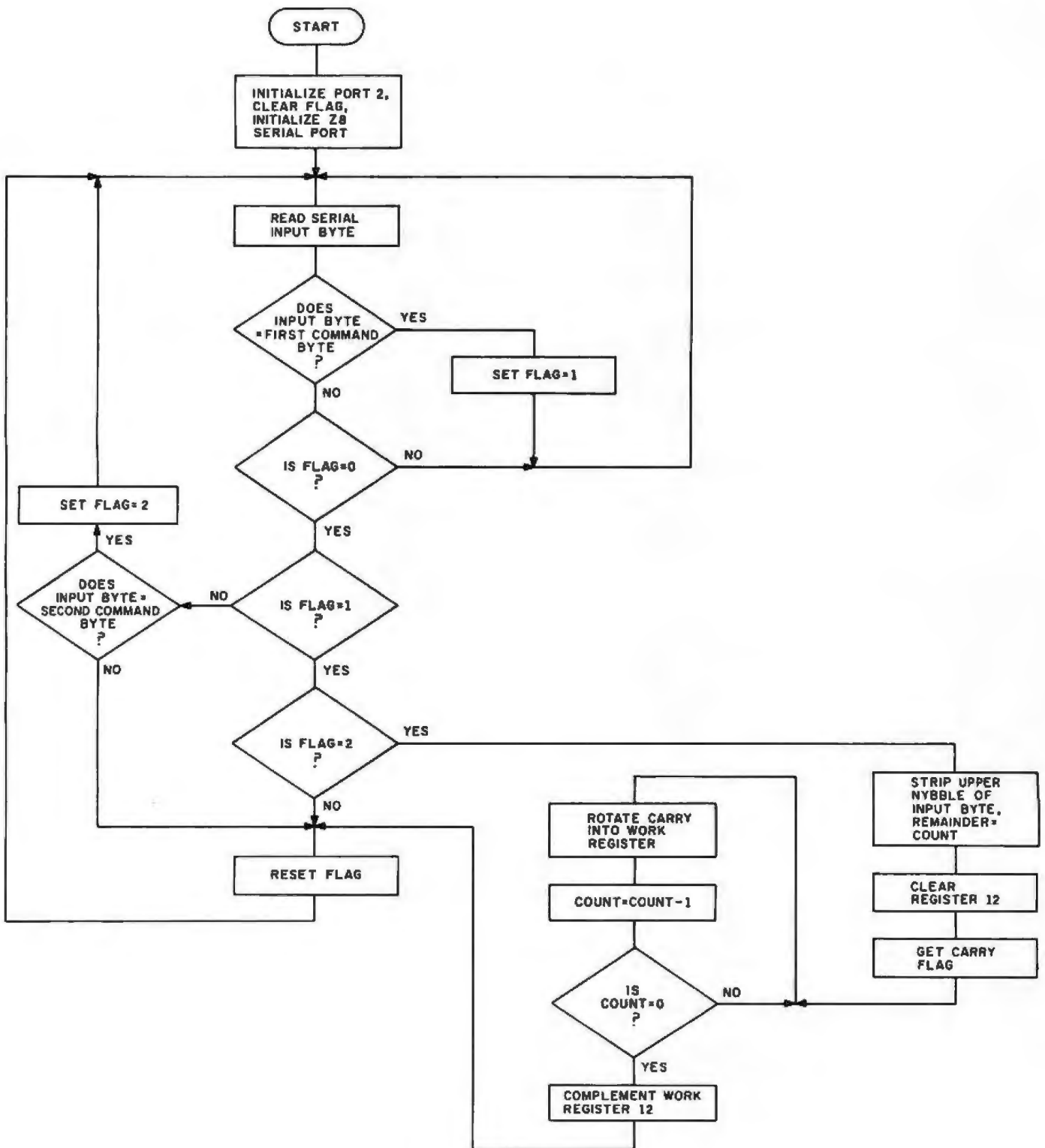


Figure 4: Flowchart of a Z8 machine-language program that can control the code-activated switch at data rates up to 9600 bps.



# 100%

CERTIFIED ERROR FREE

SENTINEL  
DISKETTES

Guaranteed  
when properly  
used to  
Read, Write  
Error-Free as long  
as you  
own them.

Sentinel Computer Products, Division of Packaging Industries G

## QUALITY YOU MAY NEVER NEED. But it costs no more!

The expert technicians who produce and monitor the quality of our diskettes have developed new state-of-the-art technology using equipment we design and build ourselves, unlike any other diskette maker. That's why our burnishing method uses a unique, dual-sided technique which provides an advanced degree of surface smoothness, the key to consistent high quality



SENTINEL®

performance. In addition, a superior, high quality lubricant assuring extra long life and a quality control program which includes certifying every Sentinel Diskette are reasons we can offer you the industry's most exacting guarantee. For unsurpassed information security, choose Sentinel brand, and ask your dealer about the new 2-PACK in a resealable storage case.

The Professional's Diskette — Ideal for Personal Use.

Sentinel Computer Products, Division of Packaging Industries Group, Inc.,  
Hyannis, MA 02601 Tel: 617-775-5220

The final program, shown as assembly code in listing 1, uses many subroutines already available in the Z8671's ROM and requires only 88 bytes. It is designed to use a two-character control-sequence-recognition code, followed by a channel number. (I decided not to use unprintable control codes in this example, but any ASCII characters can be used.) The complete sequence is "@lx", where x is a value from 1 to 4. The code sequence "@l3", for example, would direct the output of the Micromux to channel 3, while the sequence "@l1" would send the output to channel 1. One handy feature of the read-and-analyze routine is that only the 4 low-order bits of the third character in the sequence are used. This allows us to use one of the Control-A, -B, -C, or -D output-selection characters (as used in the BASIC program) as the third character in the sequence in place of the digit.

Because the program of listing 1 runs entirely in machine language, channel changes may occur at any point in the transmission, at any of the available transmission speeds. If you plan on using this program with a printer attached to one of the output channels, you may want to change the "@l" part of the sequence to two nonprinting characters. Simply substitute two ASCII codes of your choice in the program.

### In Conclusion

The primary purpose of this article is to present something the average computer hobbyist can successfully build and use. However, if you are an industrious programmer with a lot of experience, you might want to add some additional features, such as storing input in a memory buffer, trapping control-code sequences (which would filter the switching codes out of the data flowing to the output channels), and party-line communication (where data is sent to more than one output channel). Of course, all of these additions would have involved more complex hardware and software.

In my own case, the Micromux



# QUADRAM™ INAUGURATES THE MERGER OF APPLE AND IBM

## Use Apple software in your IBM PC and XT

Who said you can't mix Apples and IBMs? Innovation by Quadram makes it possible with Quadlink™. A simulated Apple computer on a revolutionary new enhancement board. With Quadlink use Apple software in IBM Personal Computers and XTs.

That means most programs designed for the Apple II, Apple II Plus or Apple IIe—including all the educational software and games—are now compatible with the IBM PC. IBM's sophisticated business capabilities and Apple's educational and entertainment options both in one computer with Quadlink by Quadram.

## Easy to use

Quadlink is a board that plugs inside the IBM PC. After it's installed, you're in business. It's like having an Apple 64K computer inside your IBM.

Don't convert or re-format any diskettes. Load the Apple software into the IBM PC and key in one command. That puts you in the Apple

mode. And you're ready to go. When ready to switch back, just press a different key. It's that simple.

## Keep the extras

Of course, Quadlink allows use of all IBM enhancements while running Apple software. That means printers, buffers, monitors and more.

When using a monitor with Quadlink there's no plugging and unplugging cables. And Apple programs will appear on an IBM Monochrome or color monitor just as clearly as on Apple's own screen. Even while working with Apple's high resolution color graphics, quality won't be diminished.

## Explore your options

Quadlink, essentially a simulated Apple computer, comes standard with 64K memory. Requiring only one expansion slot, it offers a parallel port designed to operate most printers and parallel devices. A serial port for connecting modems, printers and other serial accessories. And a game port for a variety of entertainment options. And

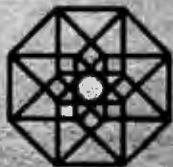
it's both IBM and Apple compatible. There's nothing like Quadlink. And nothing like reliable Quadram Quality to stand behind it.

## Beyond the limits

Quadlink by Quadram opens a whole new world of possibilities for IBM PC owners. There's no reason for software limitations any longer. If you like what IBM has to offer but hesitate to give up Apple's educational programs or games, explore Quadlink. And get the best of both worlds.

Quadram Corporation is a division of Intelligent Systems, for over a decade an innovator in personal computer enhancements and color graphics computer peripherals. Quadram products are available only at authorized dealers worldwide.

Visit one and ask for a demonstration of Quadlink by Quadram. Check on our other enhancements too, including Quadboard, the original multifunction board for the IBM PC. We think you'll like what we've discovered.



**QUADRAM**  
CORPORATION  
An Intelligent Systems Company

4357 Park Drive / Norcross, Ga. 30093 / (404) 922-6666  
TWX 910-788-4915 (QUADRAM 10CRS)



didn't end up attached to a printer. I'm using the prototype, consisting mostly of a modified Z8-BASIC Microcomputer, to communicate with four other Z8 boards that per-

form specific control and security assignments, none of which I had previously deemed important enough to merit tying up four separate serial ports.

Now, of course, I need another code-activated switch for the printers and modems, but I'm not enthusiastic about hand-wiring another one. So if The Micromint decides to make an improved version of the Micromux, I'll take the first one off the assembly line. ■

**Listing 1: Machine-language program for the Z8671 to control the code-activated switch at data rates up to 9600 bps.**

```

1000          0000 ;
1000          0020 ;
1000          0030 ; MULTIPLEXER SWITCHING PROGRAM FOR THE
1000          0040 ; Z800 Z8 MICROPROCESSOR, P/N 43511 WITH
1000          0050 ; ON-BOARD BASIC/DEBUG ROM
1000          0060 ;
1000          0070 ; READ A TWO BYTE CODE AND THEN SET THE
1000          0080 ; PORT 2 CONTROL BITS AS REQUIRED BY
1000          0090 ; THE THIRD (DATA) BYTE.
1000          0100 ;
1000          0110 ; USES ROM CALL TO READ BYTES ON THE SERIAL
1000          0120 ; PORT OF THE Z-8 COMPUTER BOARD.
1000          0130 ;
1000          0140 ; TO CHANGE CONTROL BYTES, STORE FIRST COMMAND
1000          0150 ; AT 1041H, SECOND COMMAND AT 1055H. YOU MUST
1000          0160 ; USE DIFFERENT CODES FOR CMD1 AND CMD2, DUE TO THE
1000          0170 ; UNCONDITIONAL FLAG SET AFTER THE "FIRST" LABEL.
1000          0180 ;
1000          0190 ;
1000          0200 ; FIRST SET THE FIRST ROM BYTES TO 0FFH. THESE ARE THE
1000          0210 ; INTERRUPT VECTORS, AND ARE UNUSED BY THIS PROGRAM.
1000          0220 ;
1000          0230 ;
1000          0240 FILL EQU 1020H
1000          0250 DB 0FFH,0FFH,0FFH,0FFH,0FFH,0FFH,0FFH,0FFH
1000          0260 DB 0FFH,0FFH,0FFH,0FFH,0FFH,0FFH,0FFH,0FFH
1000          0270 DB 0FFH,0FFH,0FFH,0FFH,0FFH,0FFH,0FFH,0FFH
1000          0280 DB 0FFH,0FFH,0FFH,0FFH,0FFH,0FFH,0FFH,0FFH
1000          0290 ;
1000          0300 ;
1000          0310 BASIC ORG 1020H ; PLACE A BASIC LINE AT 1020H
1000          0320 DB 00,010,'00 001030',00,0FFH,0FFH,0FFH
1000          0330 ;
1000          0340 ;
1000          0350 MULTI ORG 1030H
1000          0360 LD 246,00 ; SET UP PORT 2 AS OUTPUT
1000          0370 LD 297,00C1H ; 7 BITS, ODD PARITY, 1 STOP, PORT 2 P
1000          0380 LD 2,00FFH ; SHUT DOWN ALL I/O AT START
1000          0390 LD 30H,00 ; SET FLAG TO 0
1000          0400 ;
1000          0410 ;
1000          0420 CHAND CALL 0035H ; GET A BYTE FROM THE SERIAL PORT
1000          0430 CP 13H,0C4D1 ; IS THIS THE FIRST COMMAND CODE ?
1000          0440 JR Z,FIRST ; YES, DO SET FLAG
1000          0450 CP 30H,00 ; IS FLAG 0 ?
1000          0460 JR NZ,PART2 ; NO, TEST FLAG SOME MORE
1000          0470 FIRST LD 30H,01 ; SET FLAG TO 1
1000          0480 JR CHAND ; AND GO BACK TO LINE
1000          0490 PART2 CP 30H,01 ; IS FLAG A 1 ?
1000          0500 JR NZ,PART3 ; NO, CHECK LAST POSSIBLE FLAG SET
1000          0510 CP 13H,0C4D2 ; YES. IS THIS COMMAND BYTE 2 ?
1000          0520 JR NZ,RESET ; NO, FALSE ALARM. RESET FLAG BYTE
1000          0530 LD 30H,02 ; YES, UPDATE FLAG
1000          0540 JR CHAND ; AND GO BACK TO LINE
1000          0550 PART3 CP 30H,02 ; IS FLAG A 2 ?
1000          0560 JR NZ,RESET ; NO. FALSE ALARM. RESET FLAG BYTE
1000          0570 CLR 12H ; CLEAR REG 12H
1000          0580 SCF ; SET CARRY FLAG
1000          0590 AND 13H,00FFH ; MASK OFF H.O. BYTE OF DATA
1000          0600 LOOP RLC 12H ; ROTATE BIT ONCE.
1000          0610 DEC 13H ; COUNT=COUNT-1
1000          0620 JR NZ,LOOP
1000          0630 COM 12H ; COMPLEMENT BECAUSE 0 = ENABLE TO CI
1000          0640 LD 2,12H ; WRITE BIT TO THE MUX CONTROL PORT
1000          0650 RESET LD 30H,00 ; RESET COMMAND FLAG
1000          0660 JR CHAND ; AND GO BACK TO LINE
1000          0670 ;
1000          0680 ;
1000          0690 CMD1 EQU '0'
1000          0700 CMD2 EQU '1'
1000          0710 ;
1000          0720 ZZZZ END

```

**SYMBOL TABLE**

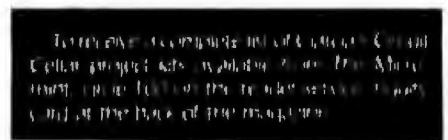
BASIC	1020	CHAND	103C	CMD1	0040	CMD2	0321	FILL	1000
FIRST	1049	LOOP	1068	MULTI	1030	PART2	109E	PART3	1050
RESET	1073	ZZZZ	1078						

**Next Month:**

*New developments in technology have prompted yet another speech-synthesis project, this one using adaptive differential pulse-code modulation.*

**Reference**

1. Ciarcia, Steve. "Build a Z8-Based Control Computer with BASIC, Part 1," July 1981 BYTE, page 38. Part 2, August 1981 BYTE, page 50. Reprinted in Ciarcia's *Circuit Cellar, Volume III*. Peterborough, NH: BYTE Books, 1982.



**Editor's Note:** Steve often refers to previous *Circuit Cellar* articles as reference material for each month's current article. Most of these past articles are available in reprint books from **BYTE Books, McGraw-Hill Book Company, POB 400, Hightstown, NJ 08250.**

Ciarcia's *Circuit Cellar, Volume I* covers articles that appeared in *BYTE* from September 1977 through November 1978. Ciarcia's *Circuit Cellar, Volume II* contains articles from December 1978 through June 1980. Ciarcia's *Circuit Cellar, Volume III* contains the articles that were published from July 1980 through December 1981.

*If you would like to put together a code-activated switch from off-the-shelf components, you could configure powerful hardware using the new Z8-BASIC System-Controller board (which contains RAM, EPROM, and a Z8671 on board) and a few Z8-BASIC Serial Expansion boards. For information about availability and prices of the Z8671 or other Z8-BASIC board products, contact The Micromint Inc., 561 Willow Ave., Cedarhurst, NY 11596, (800) 645-3479.*



# The Electronic Office

by Pamela A. Clark, Managing Editor

The term electronic office has been overused to the point where one might believe that the complete electronic office does in fact exist. Nothing could be farther from the truth. While many office tasks are indeed automated—dedicated-function machines share data and a few peripherals—you could hardly say the electronic office is in full bloom. The current level of electronic office automation represents only a very small number of the myriad functions within an entire organization that could benefit from the speed and efficiency of the microprocessor. Companies strongly committed to implementing the electronic office will find the task complicated by the very nature of the change, as well as by confusion in the marketplace.

In the words of Marshall McLuhan, the medium is the message, and electronic transfer of information will profoundly affect the structure and management of an organization. If information is power, then distributed information means distributed power—a new and threatening concept for many companies. Management by divisional competition and conflict must give way to cooperative management as information is shared rather than controlled. Technological advances always create changes in staff hierarchy, performance standards, and human relations. Organization charts may soon reflect more tenets of communication theory than management theory as the organizational functions become inextricably linked to information management. The answer to the fundamental question, "Who has the authority to make changes in a shared database?" could restructure an entire corporation and postpone its electronic birth for a number of years.

The delayed emergence of the electronic office can also be traced to confusing signals from the technical



arena. Traditional mainframe vendors tout powerful dedicated systems, but can't deliver the stand-alone features of a workstation, a situation that only perpetuates centralized resources and information. PBX vendors provide excellent low-speed voice and data local networks to channel information throughout a building, but have only recently begun to supplement this with terminals and software. The proliferation of microcomputers increases the impetus for change, but system incompatibility hinders electronic reorganization. The usefulness of integrated software packages remains limited by general-purpose designs aimed at large markets.

Organizations in search of electronic nirvana must still look to multiple vendors for discrete components. Rapid technological changes and the accompanying lag in industry standards combine to sustain that situation and keep the complete, integrated electronic office from realization. However, the entrance of industry giants AT&T and IBM brings a powerful new pressure on the market. These heavyweights have the necessary resources to tackle the many disciplines embodied in the electronic office. The level of technical integration required for a fully functional system is colossal. While the electronic office promoted by these giants may not be as innovative as current speculation would have it, it will be integrated. And if the electronic office is to become a reality, harmony must be the bottom line.

Our theme articles, beginning on page 60, are as diverse and discrete as components in the electronic office. Networks, individual computer systems, and software applications all play an important role in today's office. However, the total electronic office remains only a vision on the horizon ■



# Local Area Networks

## An Update on Microcomputers in the Office

*The boom in office communication systems is creating a pressing need for standardization.*

---

Harry Saal  
Nestar Systems Inc.  
2585 East Bayshore Rd.  
Palo Alto, CA 94303

---

The ideal state of computing—in which any computer or office device can communicate with any other device—is still on the horizon. But sharing information between physically separated personal computers, corporate computers, expensive printers, and disk drives is becoming more feasible and desirable every working day.

Often the information that managers would like to analyze with their electronic spreadsheet programs is ready and waiting on databases on the company mainframe computer, waiting for an easy communications link to the workspace in the managers' desktop computers. Electronic mail will help usher in a new era of office productivity, improving intercompany communications and ending vicious circles of returning calls to people who've returned your calls, etc.

Systems of computers and peripherals linked together in adjacent offices and buildings, or *local area networks* (LANs), will bring about complete office automation and standardize computer interconnections. But we're not quite there, yet.

Office computers are no longer de-

signed for the exclusive use of computer professionals; from senior management to the receptionist, employees are expected to use computers as standard parts of the office environment. Everyone from a trained analyst to a temporary secretary now needs to have access to information in databases and process it electronically.

In business, a wide spectrum of individuals must share information; rarely is true personal data encountered in corporate situations. One person might enter the basic data, another will edit or modify it, and a third will produce reports or graphic displays from it. Information is typically supplied by many sources but must be merged, managed, and distributed to be useful. Also, because information is a valuable resource, it must be protected from malicious or accidental misuse.

Traditional multiuser computer systems, whether mainframe or mini-computer, are not well suited to this new type of automated applications. Conventional systems require large centralized facilities, inaccessible to the user. They require costly support staffs. Maintenance problems make it difficult to justify new development, resulting in today's widespread applications backlog.

Conventional systems also lack the responsiveness, ease of use, and user orientation of the newer desktop systems. They are designed for a more sophisticated, trained user, thereby limiting their usefulness for the far broader class of new computer users.

This unsatisfactory state of affairs, contrasted with the benefits of friendly, fast, and economical personal computing, is spurring current desktop computer development.

### The Communications Requirement

Although often separated by distance, allied users must work together cooperatively. On different floors, in different buildings, or in different states and countries, fellow workers must exchange information. For them, communications are no longer a luxury; they are essential and growing daily in importance.

Two recent developments, local area networking and personal computing, provide a way to address the needs of this new class of computer users; *community microcomputing* is the merger of these two technologies.

Community microcomputing enables a community of users to share information that resides on common peripherals. Users share common programs and data as well as exper-

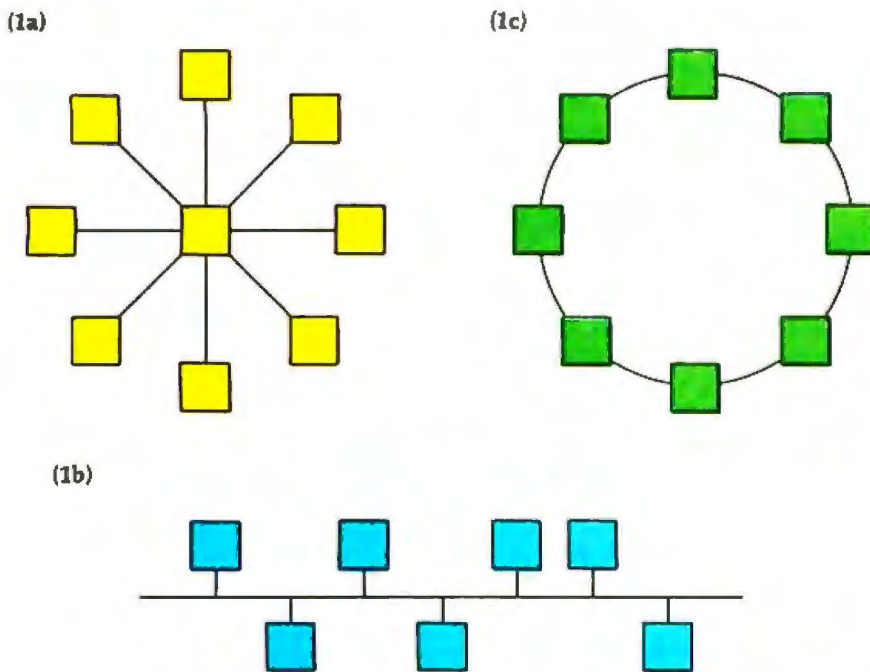
---

#### About the Author

Harry Saal is the president of Nestar Systems Inc.

---





**Figure 1:** Popular network configurations. The star network (1a) is the most common of the early network types (such as the telephone system) and relies on the central node for control of operations. Bus configuration (1b), as used on the Ethernet and by cable television, allows nodes to be added or removed without impairing the network. The ring network (1c) circulates all messages in one direction and may pass tokens to specify which node may transmit; a failure of any node may interrupt network operation.

sive, high-quality equipment such as printers and disks. Individuals connected to a community micro-computing system have their own dedicated personal computers as well as support environments for communications and for sharing of peripherals and information. Familiar personal computers, serving as desktop workstations, provide a non-threatening setting that enhances the effectiveness of professional and clerical workers. These personal workstations are open-ended, multifunction tools that make possible word processing, data manipulation, graphics, and sending electronic messages.

### Attributes of a LAN

Local area networks are a specialized part of the larger class of communications networks. They undertake the job of intercomputer communications within geographically limited distances in a very reliable and cost-effective way. Conventional long-haul (telephone) lines and satellite systems are optimized for the

transmission of analog or digital data over thousands of miles. Local area networks are optimized for use in the office or factory, over distances of hundreds to many thousands of feet.

Local area networks typically are bounded by speed as well as distance, running several hundred thousand bits per second to as many as tens of millions of bits per second.

Speed and distance, however, are not the only two design considerations of a local area network. LANs operate with digital data and exhibit high reliability of communications over the distances specified. A system of error detection must be added to the digital information to ensure that even a rare error will be detected. Additionally, an error-correcting mechanism is needed to ensure that the correct data is retransmitted.

To accomplish retransmission, data is split into groups or packets. Each packet contains information regarding its source and destination. Most local area network schemes permit a special form of addressing referred to as *broadcasting*, whereby

a station may send a packet that is destined for all stations connected to the local area net. *Multicasting* is similar; however, in multicasting the targeted stations are a subset of the totality of connected stations.

Typically, within the data packet, there are various acknowledgments, additional information concerning the sequencing of packets, network addresses, etc. This information is used to provide more sophisticated services to the programs running on the workstations than services simply based on a "point-to-point" transmission medium. Such sophisticated services include routing, distinguishing which programs on a particular machine are addressed, and identifying character sets and protocols in use.

The error-recovery schemes used in local area networks generally make it possible to add a new station to a functioning communications network without disrupting ongoing operations. This possibility results from several factors: First, the act of connecting (or disconnecting) a new station to the actual network medium causes some momentary interference and errors. But the basic design of the network accommodates such errors automatically, by retransmitting the information. Second, because local area networks are designed as fully distributed systems, there is no central station or master list of stations that must be updated in order for the system to continue functioning. This updating of station information takes place dynamically as the system runs. In more conventional communications schemes, it is generally necessary to stop the system and take some global action in order to add or delete a network node.

### Network Topologies

The form of the physical connection of stations to the communications medium generally falls into one of three main categories: star, bus, or ring form (see figure 1).

Telephone systems are the best example of the star configuration, or topology. Each instrument is connected via cable to the central office where the switching is done between

stations. To talk to your next-door neighbor, the information must flow to a *main switching point*, where it is processed by an exchange, then back to the house next door.

Few examples of the star topology used in local area networks exist, other than the private-branch-exchange (PBX) telephone system, due to the problems encountered by having a specialized piece of equipment to service all the stations at the ends of the lines. In computer systems, the services to be performed by the switch are likely to become more complex over time. This may require more than one piece of equipment, which makes it more difficult to arrange the equipment in a star configuration rather than in a bus or ring topology.

The star topology seems most suitable to a PBX-type system in which the main service requirement is data-switching from point to point. The data speed requirements are generally nominal (less than 50K bits per second), and the wiring exists in millions of offices. This type of network works efficiently when fairly powerful multiuser systems are connected to it, thus providing the computing power for low-speed intelligent terminal devices. With many of the existing telephone systems manufacturers preparing to introduce this type of network, it could well dominate in the future.

The bus topology usually involves one long central spine of cable to which each of the nodes is connected. Nodes may connect directly, or as in many cases, they may be connected via a *cluster box*, which provides for multiple station connections. By connecting several cluster boxes, you obtain a treelike structure of interconnected cables, or a "star of stars." This configuration still remains a bus in the sense that stations can still communicate directly without the need of an intermediary station.

Bus schemes are sometimes found with two cables running to each station; one cable receives while the other transmits. In this case, all the transmitters are connected together via a bus that runs to a special *head-end retransmitter*. This retransmitter

takes the signals, amplifies them, and broadcasts them on the receive cable to which all stations listen. Most community antenna television (CATV) systems work in this fashion. This system implies that stations cannot directly talk to each other but only via the intermediate amplifier. In this scheme, it is essential to make the head-end retransmitter extremely reliable, so that it is not the weak link in the network. Using this scheme adds significantly to the basic system cost; this is practical if the network is servicing a unit larger than an individual office, such as a complete building.

A ring can be thought of as a bus that is closed back on itself. The ring topology does not have the flexibility that bus structures have, yet it forces more regularity into the system, thereby assisting in error-diagnostic and repair capabilities. In ring systems, the information circulates (clockwise or counterclockwise), and it is possible to implement a scheme whereby a station can check to see if the data transmitted was received or not. This is done by looking at control information that is inserted or modified by the receiving station and passed around the ring, sometimes followed by a token.

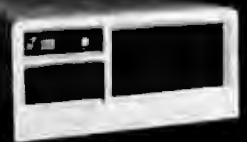
One proposed ring system uses a pair of counter-rotating rings to circulate information. This system permits a nonfunctioning station to be isolated while all the other stations are still interconnected. On the other hand, adding or deleting a station from a ring system is more complex than with either the star or bus approach. The process typically disrupts the closure of the ring for significant periods of time during which the system is not operational.

### Standards

The office is one of the most heterogeneous of all data-processing environments. Typically, companies have already acquired an assortment of word processors, small computer systems, and telephone exchange equipment and may be using outside timesharing services. Since one of the goals of a local area network is to facilitate the intercomputer com-

## Now Attractive Industrial Quality Mainframes Enclosures as low as \$200

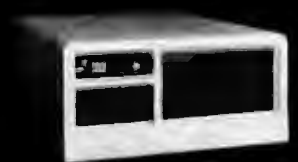
Dual LED Display  
Shock Mounted 6 Slot  
Motherboard/ Card Cage  
PS-101 Power Supply  
Power & Reset Switches, A/C Filter,  
Fan, Etc.



**SDS-S100-SL**  
8" Floppy Drive Enclosure/System  
Special Lift Out Drive Rack  
Fits all Regular and Slim-Line 8" Drives  
Also Will Support 5-1/4" Hard Disk



**SDS-S100-MFL**  
5-1/4" Floppy and/or Hard Drive  
Enclosure/System



**SDS-MF2 SDS-MIC**  
12 Slot S100 Computer Chassis or  
8" Hard Disk Cabinet



**PS-101 Power Supply**  
This solid supply gives you the capability of running any variety of 8" floppy or 5-1/4" floppy or hard disk drive as well as provides power for a full S100-Buss Motherboard.

Regulated:	Unregulated:
8V @ 8 amp	+16V @ 1 amp
+5V @ 5 amp	-16V @ 1 amp
+12V @ 5 amp	
+24V @ 5 amp	
-5 or -12V @ 1 amp	

**SIERRA DATA SCIENCES**  
Fresno, California/  
Product Support Division  
25700 First Street, Westlake, Ohio 44145  
(216) 892-1800 TELEX: 980131 WDMR





# On the Threshold of 8-Bit Hyperspeed



At 8MHz, Sierra Data Sciences' new Z80 single-board computers are the first—and the fastest—microcomputers in their class.


Under CP/M™ they perform like single user minis. Teamed with networking TurboDOS™ their 16-bit-buss-transfers amaze the demanding 16-bit multiuser world. And at Sierra Data's production-oriented price, they bring an ever-expanding universe of CP/M compatible software into a whole new realm of price/performance reality.

Solve your need for speed. Only a reliable manufacturer with Sierra Data's undisputed technical lead and established reputation for support can deliver these features—all on board our new slave/satellite single-board computers:

- Meets IEEE 696/S-100 Standards • Z80H (8MHz) Z80B (6MHz), or Z80A (4MHz).
- 64K/128K\*/256K\*/512K\* bank-selectable RAM in 4K incre-

- ments • High speed integer or Floating-point math chip\* • 2 Serial ports • 2 Parallel ports • 4 Counter timers • 4K CMOS cache buffer, buss addressable in 16-bit or 8-bit increments • 4K/8K/16K EPROM • Operates under Sierra Data supported CP/M 2.2\*\*, CP/M 3.0\*\* and TurboDOS 1.2\*\*

Make Sierra Data the heart of your advanced system or discover one of Sierra Data's cost-effective, turnkey systems. Sierra Data's single or multiuser 20M byte hard disk system with 8 inch slimline floppy-disk backup is shown above. Other popular configurations are shown on the previous page. Ask for Sierra Data's product catalog today.



HARDWARE  
SOFTWARE



**SIERRA DATA SCIENCES**

Fresno, California/  
Product Support Division  
25700 First St., Westlake, Ohio 44145  
(216) 892-1800 TELEX: 980131 WDMR

\*Optional

\*\*TurboDOS is a Registered Trademark of Software 2000 Inc.

\*\*CPM is a Registered Trademark of Digital Research



# CAST BETTER, FASTER SPELLS WITH OUR CI-C86 C COMPILER



Weave  
a spell with  
the CI-C86 C Compiler,  
especially designed for use with:

- CPM86 and MPM86
- MS-DOS
- IBM Personal
- IBM Displaywriter
- DEC Rainbow
- Victor 9000
- Sirius
- NEC APC
- Zenith 2100
- Lomas 8086
- Altos 8600
- Compupro 86/87
- Seattle
- Eagle
- Columbia 1600
- And Many More

CI puts all the magic of C at your fingertips with all of K&R, a full support library, 8087 support and much more.

**Merlin would approve!**

Disk and documentation \$395.  
Overseas airmail \$20.

For further information, please contact:



**Computer Innovations, Inc.**  
75 Pine Street  
Lincroft, New Jersey 07738  
Telephone: (201) 530-0995



munications within the office, it is very attractive to imagine a local area network that can connect together a variety of equipment, present and future.

The equipment must be compatible on many levels to accomplish this interconnection. Practically speaking, most vendors rely on the lack of interchangeability to prevent their customers from rushing off to the competition, and they do not actively publish specifications that enable easy substitution. Very often commonality comes about in informal ways, in which a number of vendors play follow the leader, otherwise known as being IBM-compatible! But the world of communications is one domain in which the need for information interchange requires more than casual attention to standards.

## The ISO Reference Model

The International Standards Organization (ISO) established a framework for standardizing communications systems, called the Open System Interconnection (or OSI) Model. The OSI architecture defines seven layers of communications protocols, with specific functions isolated at each level. The purpose of layered protocols is severalfold: one significant advantage is that differing lower-level implementation details can be hidden, while compatibility can still be achieved at the higher levels. This permits considerable variation in the basic electrical technology, while retaining the fundamental information flow between systems.

Level 7 is the Application Level, which handles the utility aspects of network usage. Issues such as the identification of users, selection of services, or global network access are dealt with by Level 7. Typical programs at this level are file transfer programs, terminal-to-terminal emulation capabilities, and electronic message programs. At this level, tasks are performed; all the lower levels are there to support applications.

Level 6 is the Presentation Level, which handles the conversion of data

C86 and CI-C86 are trademarks of Computer Innovations, Inc.  
CPM and MPM are trademarks of Digital Research  
MS-DOS is a trademark of Microsoft  
IBM is a trademark of International Business Machines  
DEC is a trademark of Digital Equipment Corp.





# The Professional's Editor for Program Development Word Processing Source Code Translations

Widely acclaimed as an editor, VEDIT has evolved to be much more. Only VEDIT offers the combination of a versatile full screen editor integrated with a powerful command language. For the first time you'll be able to perform complex, yet useful, text manipulations that are virtually impossible with other editors or word processors. Plus, its customizability and hardware support ensure that VEDIT will be perfectly matched to your individual needs and to any microcomputer you are ever likely to own.

With two modes of operation, VEDIT never compromises its speed or ease of use for its power and sophistication. As one reviewer (Bradford Thompson, BYTE) wrote: 'If this review gives you an appetite for simplicity while editing, then VEDIT is well worth considering.' Its command language, based on TECO, is virtually a text oriented programming language, allowing command macros to be created, loaded and saved on disk. Yet its simplicity allows even a novice to perform tasks beyond the capabilities of any word processor.

VEDIT cuts programming time in half - with multiple file handling, macro capability and special features for Pascal, PL/1, 'C', Cobol, Assembler and other languages. And it can help with source code translations (example ZILOG to/from INTEL translator macros are included). A complete line of translators will be available by the year's end.

Word processing is a snap with word wrap, paragraph and print functions. Command macros free you from tedious search/replace operations. Hundreds of search/replace on dozens of files can be performed by VEDIT without waiting or intervening.

VEDIT easily configures to your favorite keyboard layout. Use any function or cursor keys you wish. It optimally supports nearly every 8080, Z80 and 8086 computer.

Go ahead and expect a lot from VEDIT. Its performance and our support will satisfy your most exacting needs.

To order, please specify your 8080, Z80 or 8086 microcomputer, operating system and disk format.

## COMPARE VEDIT'S FEATURES

- True Full Screen Editing
- Horizontal scrolling
- Edit files one disk in length
- Automatic Disk Buffering
- Compact (only 16K) and Fast
- Display of line and column #
- Set/Goto text markers
- 'Undo' key to restore line
- Automatic Indent/Undent
- Adjustable Tab positions
- Repeat function key
- Text Move and Copy
- 10 Scratchpad Buffers
- Load/Save buffers on disk
- Powerful command macros
- Directory display
- Edit additional (small) files simultaneously
- Insert another disk file
- Unlimited file handling
- Recovery from 'Full Disk'
- Change disks while editing
- Word wrap, format paragraph
- Simple Printing
- 150 page indexed manual
- Startup command file
- Menu driven installation
- Program CRT function keys
- Support newest CRT terminals
- Support smart CRT functions
- Flexible Memory Mapped support
- Customizable keyboard layout

IBM PC, Displaywriter<sup>®</sup> Zenith Z100 and Z89<sup>®</sup> NEC APC<sup>®</sup> DEC Rainbow and VT180<sup>®</sup> Televideo 802 TRS-80 I, II and 16<sup>®</sup> Xerox 820<sup>®</sup> Apple II Softcard<sup>®</sup> SuperBrain<sup>®</sup> NorthStar MP/M<sup>®</sup> CP/M-86<sup>®</sup> MP/M-86<sup>®</sup> Concurrent CP/M-86<sup>®</sup> Cromix<sup>®</sup> Turbo DOS<sup>®</sup> MSDOS<sup>®</sup> PCDOS<sup>®</sup>

VEDIT - Disk and Manual  
8080, Z80 or IBM PC .....\$150  
CP/M-86 or MSDOS .....\$195  
Manual only .....\$18



CP/M and MP/M are registered trademarks of Digital Research Inc. Apple II is a registered trademark of Apple Computer, Inc. MS-DOS and Softcard are trademarks of Microsoft. TRS-80 is a trademark of Tandy Corporation. IBM is a trademark of International Business Machines.

**CompuView**  
PRODUCTS, INC.



from one format to another. This involves the packing and unpacking of data, changes in character set, expansion of graphics commands, and encryption.

Level 5 is the Session Level, in which the establishment and termination of streams of data from station to station are handled. Level 5 is typically responsible for mapping network-oriented addresses into more logical process or port names on the local workstation.

Level 4 is the Transport Level, which manages a lower level of connection than the Session Level and handles the connections needed to deal with messages that exceed the maximum packet size of the network. Making a reliable end-to-end connection across an imperfect basic network is done by Level 4. Error control, sequence checking, handling of duplicate packets, flow control, and multiplexing issues are the main concerns of this level.

Level 3 is called the Network Level. It deals with the routing of informa-

tion from node to node via intermediate nodes and stations. This is often not required on the local network itself due to the broadcast nature of the information exchange, or because of direct addressing provided by the network hardware. Interconnections between more than one LAN, however, require a functional Level 3.

Level 2 is referred to as the Data-Link Level. The data-link deals with the actual packets themselves and provides for the addition or removal of header and framing information surrounding the actual data contents. These headers provide for timing signals, error-detection checksums, and station addresses for hardware recognition. It is the data-link level that incorporates the access strategy for sharing the basic cable among many stations: for example, whether it is a round-robin protocol, controlled token-passing, or a probabilistic contention scheme.

Level 1 is the Physical Level, which defines the electrical and mechanical

characteristics of the network. The particular signaling scheme used, modulation techniques, frequencies, and voltages employed are all specified at this level.

See table 1 for an idea of how the major microcomputer networks fit into the ISO framework.

### Adoption of Standards

Clearly a need exists for some level of electrical compatibility at which a standard connector, standard signaling levels, etc., are used to successfully build fully integrated office systems that directly link together disparate office equipment. The most attention has been on the layers that deal with these issues, namely, Levels 1 and 2. This attention should result in the availability of standard components that a variety of manufacturers can use, thus reducing the cost to the consumer. This attention also follows the industry's tendency to feel that once the hardware is compatible, the software "can always be fixed later." It is interesting to note that this

## The Most Promising Duet For An Orchestra.

**Our duet is perfect for a single user system.**

**The same duet performs even better in a multi-user orchestra.**

### MCM ★ 80:

S-100 Single Board Computer ■ Single or multi processor capability ■ Programmable master or slave selection ■ Redundant processor manipulation ■ 4MHz Z80A or 6MHz Z80B CPU ■ 64K RAM and 2K EPROM with monitor ■ 2 serial, 2 parallel, 4 timer ports ■ Bi-directional inter-processor channel ■ Dual mode serial ports interface ■ Multi-layer PCB construction.

**\$495.** Circle 510 on Inquiry card.



### DCM ★ 80:

S-100 Disk Controller Module ■ 8" and/or 5¼" floppy disk controller ■ SASI (ANSI, SCSI) hard disk host adapter ■ Single and double density, single and double side ■ Software implementation on CP/M 2.2 and TurboDOS

TM of Digital Research, Inc.  
TM of Software 2000, Inc.

**\$345.**



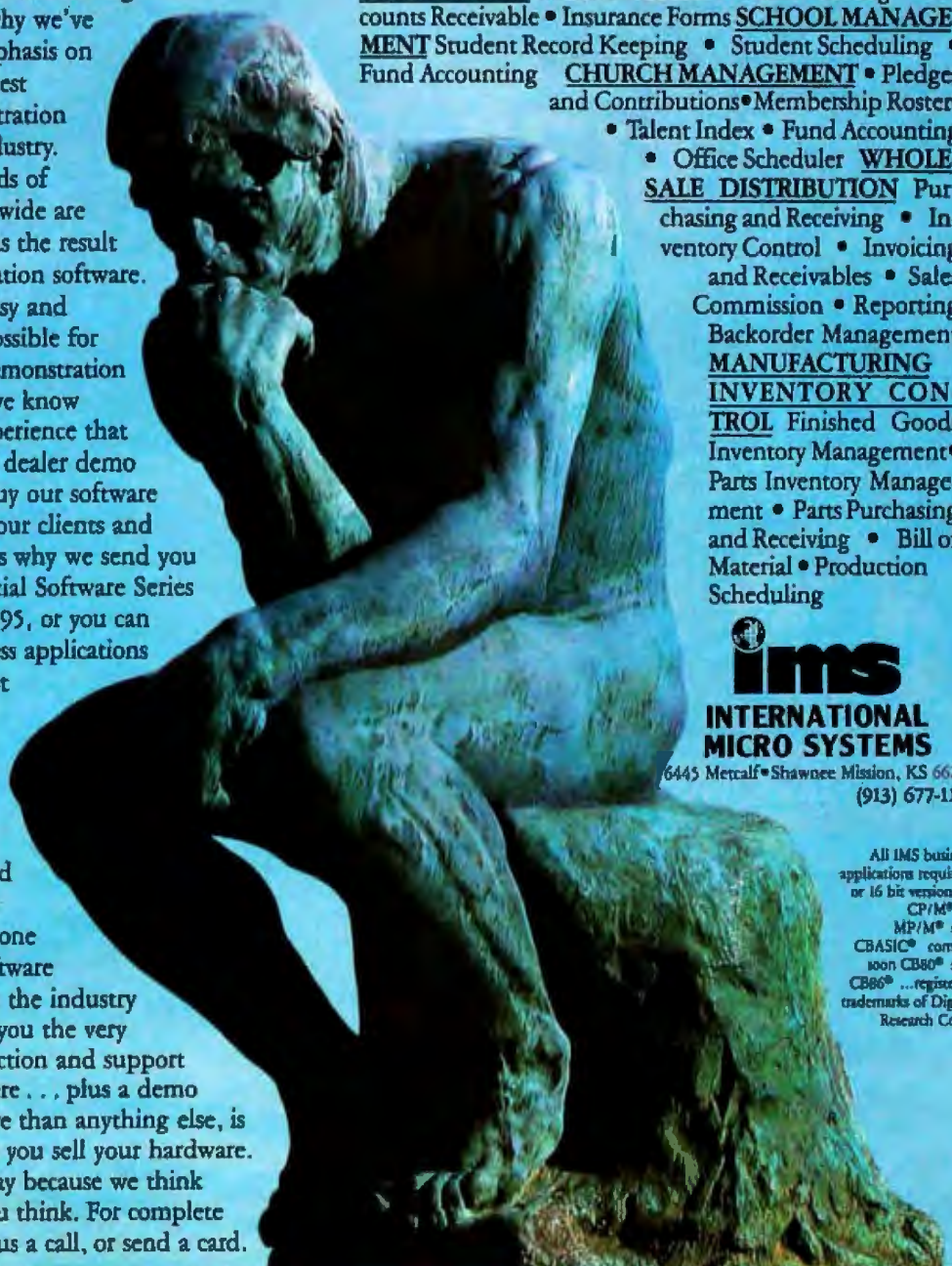
**JC SYSTEMS**

1075 Hiawatha Ct.  
Fremont, CA 94538  
408-945-0318  
TWX#910-381-7041



# JUST THINK...DEALER DEMO SOFTWARE FOR ONLY \$295

We think you think the same way we think . . . that the best way to sell hardware is by demonstrating what it will do. That's why we've put so much emphasis on developing the best software demonstration system in the industry. Literally thousands of computers worldwide are now being sold as the result of our demonstration software. We make it as easy and inexpensive as possible for you to get our demonstration system because we know from years of experience that after you see our dealer demo package you'll buy our software . . . and so will your clients and customers. That's why we send you our entire Financial Software Series demo for only \$295, or you can get all the business applications listed here for just \$595. And both packages include valuable promotional materials designed to help you close the sale. We are one of the largest software manufacturers in the industry because we give you the very best quality, selection and support available anywhere . . . plus a demo system that, more than anything else, is designed to help you sell your hardware. We did it that way because we think we know how you think. For complete details, just give us a call, or send a card.



**FINANCIAL** General Ledger • Accounts Payable • Accounts Receivable • Payroll • Cash Receipts/Disbursements • Job Costing • Inventory Control • Order Entry/Invoicing **MEDICAL/DENTAL** Office Scheduler • Patient Billing • Accounts Receivable • Insurance Forms **SCHOOL MANAGEMENT** Student Record Keeping • Student Scheduling • Fund Accounting **CHURCH MANAGEMENT** Pledges and Contributions • Membership Rosters • Talent Index • Fund Accounting • Office Scheduler **WHOLESALE DISTRIBUTION** Purchasing and Receiving • Inventory Control • Invoicing and Receivables • Sales Commission • Reporting Backorder Management **MANUFACTURING INVENTORY CONTROL** Finished Goods Inventory Management • Parts Inventory Management • Parts Purchasing and Receiving • Bill of Material • Production Scheduling



**INTERNATIONAL MICRO SYSTEMS**

6445 Metcalf • Shawnee Mission, KS 66202  
(913) 677-1137

All IMS business applications require 8 or 16 bit versions of CP/M® or MP/M® and CBASIC® coming soon CB80® and CB86® ...registered trademarks of Digital Research Corp.



# Compute While You the Buffer that

Your computer is a real whiz when it comes to time. Like you, it works fast. But most printers don't. Most printers are slow. If you ever have to wait for your printer you are wasting time. Valuable time.

But with Microfazer, there's no more waiting.

Microfazer is the print buffer that frees your computer. That lets it work fast. That helps you work faster, too.



any data processing environment, it's truly the "any computer any printer" buffer. With models for any data transmission need. Serial or parallel. Or to interface incompatible devices. And

there's always the traditional Quadram Quality.

The assurance you are getting the finest buffer available.

**MICROFAZER REMEMBERS IT ALL.** Microfazer stores data from your computer in its own memory, then sends it to the printer at a rate the printer can handle. And Microfazer can be expanded at any time to meet all your future requirements.

The print buffer that offers 512K of memory - a full half-megabyte - Microfazer can handle any buffer task.

Word Processing.  
Accounting.  
Graphics.

## THE "ANY COMPUTER ANY PRINTER" BUFFER

Microfazer goes with anything. Printers. Plotters.

Even  
modems.  
Perfect  
for



Available at retail stores worldwide.



# Print with Microfazer,<sup>™</sup> Remembers It All.

You name it.

So stop worrying about losing vital data because you run out of buffer space. Whatever the job—no matter *what* the size—Microfazer remembers it all.

## BUT MICROFAZER REMEMBERS MORE...

Microfazer remembers to give you the hardware features you're looking for in a print buffer. Features that include a Ready LED, manual Reset and Pause/Copy buttons. And Microfazer comes in a variety of convenient sizes. To

stand alone or stack with other peripherals. To snap onto the back of the popular Epson printer. There's even a model that plugs inside an Epson!



## AND PRICED RIGHT, TOO

And with Microfazer you don't have to wait because of price. Parallel to parallel versions start at \$159 (8K), serial to parallel and parallel



Special version for attaching directly to the popular Epson printer.

to serial versions start at \$199 (8K with cable), and serial to serial versions start at \$229 (8K with power supply).

Available in models from 8K to 512K.

So stop waiting on your printer. Compute while you print with Microfazer. You'll never have to wait again.



MICROFAZER.  
THE PRINT BUFFER.  
THAT REMEMBERS IT ALL.



**QUADRAM**  
CORPORATION  
A Division of Intelligent Systems.

4357 Park Drive / Norcross, Ga. 30093 / (404) 923-6666  
TWX 810-766-4915 (QUADRAM NCRS)

Circle 384 on Inquiry card.



Local Area Networks in the ISO Reference Model

Level					
7 Application	Constellation; password entry, disk backup, and diagnostics	Constellation; password entry, disk backup, and diagnostics	electronic mail, virtual disks, file transfer	electronic mail, print spooler, 3270 emulation	text, graphics, and print formatting; electronic mail
6 Presentation	Constellation	Constellation	PLAN 4000	3COM	Xerox Network Systems Courier
5 Session	Constellation	Constellation	PLAN 4000	3COM	Xerox Network Systems
4 Transport		Omninet	Xerox Network Systems	Xerox Network Systems	Xerox Network Systems
3 Network		Omninet	Xerox Network Systems	Xerox Network Systems	Xerox Network Systems
2 DataLink	polled (switched)	Motorola ADLC (CSMA/CA)	ARCnet	Ethernet	Ethernet
1 Physical	parallel 34-wire flat cable	RS-422A twisted-pair cable	ARCnet	Ethernet	Ethernet
Vendors	Corvus Multiplexer	Corvus Omnet	Nestar PLAN 4000	3COM Ether series	Xerox

Table 1: Microcomputer local area networks in the levels defined by the International Standards Organization reference model. The ISO model provides only a framework not a standard. Most network systems (like Ethernet) implement only a few of the layers.

type of standardization argument actually runs contrary to the purpose of the OSI model; the OSI model attempts to preserve compatibility across applications by permitting variation in the lower levels as long as they are fully shielded from the higher-level programs.

IEEE 802

A great deal of attention has been focused on the activities of the IEEE (Institute of Electrical and Electronics Engineers) 802 Committee. While de facto follow-the-leader-style standardization may be the dominant trend, official standards processes are important in the communications world. Hence, all the major computer manufacturers have participated actively in the IEEE standards work on local area networks.

A curious state of affairs has developed in the IEEE 802 Committee. After substantial initial activity, the Committee finally recognized the impossibility of adopting only one standard that would satisfy the variations in speed, distance, reliability,

cabling, etc., required by the computer industry. Rather than to give up entirely, the current plan is to have a series of alternatives, each with several options. However, even this strange and indecisive proposal compares favorably to what is essentially anarchy in the current choice of product offerings.

The IEEE 802 standards are split into three main areas: (1) 802-3, a carrier-sense multiple-access with collision detection (CSMA/CD) system, based on the design of the Ethernet system; (2) 802-4, a token-passing bus network, and (3) 802-5, a token-passing ring network. The latter is especially interesting to industry observers since IBM is its strongest advocate in committee and public technical discussions. Each of these fundamentally different schemes has at least three or four alternatives, which vary such parameters as data rate, transmission medium, distance traversed, and modulation and encoding techniques used. For example, within the token ring scheme, there are four variations of speed (1, 4, 10, and 20 million bits per second) using

two different types of cable (150-ohm twinax, or a bundle of three lines of 75-ohm coax).

It is likely that the American standards for the lowest levels will be adopted during 1983. The years of work that went into the standardization process thus far are a portent of even more complex activity needed to standardize at the higher levels of networking protocols. Some companies, like Xerox, have published the standards they have adopted for their own products, and this encourages other companies to do the same. The National Bureau of Standards has proposed a series of higher-level protocols for the transport level and electronic messaging.

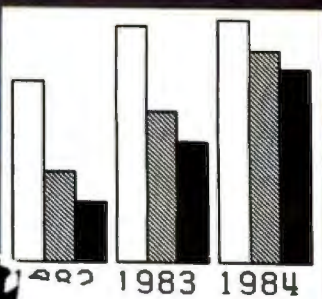
For users of networked office systems, this is an unfortunate state of affairs since they are primarily interested in the Application Level. Users want to move information from system to system, have it shared between machines with different internal hardware, and be able to display graphs on a variety of screens with different qualities and features. No doubt this capability is the ultimate goal of



Starts now at \$775.

The ultimate under \$1000 printing machine.

**DEALER BUSINESS BOOSTER 1983**  
Authorized dealers get maximum margin on demonstrator.  
CALL 800-426-4944



The one machine solution to every application.

For word processing, plotting and just plain printing.

Save the expense of a costly daisy wheel. Eliminate the limited capability of cheap matrix printers. And get plotting in the process!! Get the all new, advanced MT 160 multifunctional micro printer. You'll be amazed that such a small printer can house so much horsepower.

Capability? You name it, this printer's got it. A resident Report Package puts you in the Word Processing world... letter quality characters, proportional spacing, margin justification, auto centering. A resident Graphics Package

lets you plot whatever your micro wants to portray. The standard print mode lets you generate reports fast—speeds up to 200 lines per minute. Also, print eight different resident character widths.

There's more. Clip-on paper handling attachments let you use fan-fold forms, letterhead, cut sheets or continuous roll paper. The control panel has a "menu select" for machine configuration. When you look under the hood, you'll see what is meant by "solid construction." And the MT 160 is

plug compatible to your micro.

Tally has the printers for today that you won't outgrow tomorrow. Mannesmann Tally, 8301 South 180th Street, Kent, Washington 98032. Phone (206) 251-5524.

**MANNESMANN TALLY**

Computer printers manufactured in the U.S. and Europe for world wide markets.

**IN DISTRIBUTION NOW!**

**WEST**  
Anacomp  
(206) 881-1113  
Byte Industries  
(415) 783-8272  
Paragon Sales  
(408) 263-9510

PGI Distribution  
(802) 967-1421  
Waybern  
(714) 554-4520  
Western Micro Systems  
(408) 725-1660  
Acorn Data Products  
(303) 779-8644

**CENTRAL**  
Information Systems  
(312) 228-5480  
D. L. MacNeil, Inc.  
(312) 952-8300  
Sysprint  
(214) 669-3666  
Tek-Aids  
(312) 870-7400

**EAST**  
Computermaxx  
(904) 878-4121  
Digital Solutions  
(404) 955-4488  
Micro Distributors  
(201) 468-6450  
Hansen & Hughes  
(201) 652-7055  
CPI  
(315) 478-6664

Tech Data  
(813) 577-2794  
US Plus  
(203) 234-0444  
Mannesmann Tally Canada  
(416) 661-9783  
Nation-wide  
Hall-Mark Electronics  
(214) 343-5000  
Kierulff Electronics  
(2213) 725-0325

Circle 274 on inquiry card.



standards activities for LANs, yet the prospects for resolution appear to be years away.

Office systems buyers should, therefore, not anticipate that a local area network will make it possible for their IBM Displaywriter to talk to their Wangwriter and then to their CP/M machine without the addition of special programs and services to make it possible. Similarly, the adoption of electrical standards, whether by official committee or de facto

adoption, does not solve the fundamental difficulties inherent in handling a variety of computers, with different operating systems, languages, and databases. Local area networks expose these problems to the harsh light of day; they are not responsible for having caused them.

### Cost and Acceptance in the Office

For a wide range of applications, community microcomputing solu-

tions are far more economical than conventional multiuser *minicomputer* approaches. Community networks are less expensive to purchase and, due to lower overhead, less expensive to operate. Fitting easily within existing office environments, community networks are less expensive to install than dedicated computer facilities.

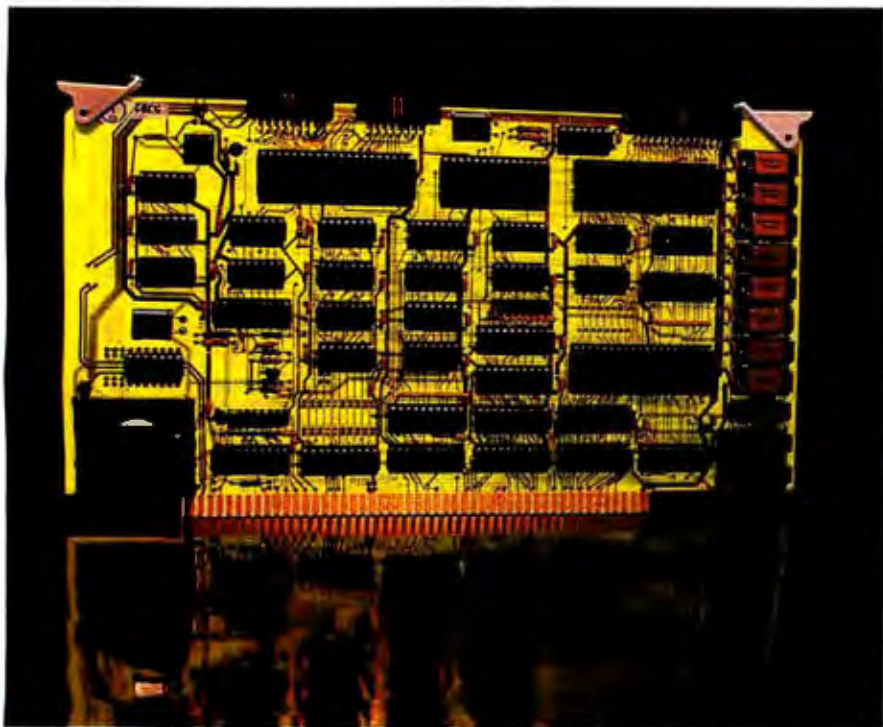
More than price alone separates the personal computer local area network solution from traditional computing systems. To achieve productivity gains, workers must accept a system rather than resist it. Using familiar personal computers as workstations significantly aids in that acceptance. If a LAN functions transparently, the users see the network as an extension of their own personal environment rather than as a complex distributed data-processing system in which they feel like mere "nodes." The users feel that they are controlling their environment, not being controlled by it. This feeling of control and individuality by the user is the single most important difference between traditional systems and community microcomputing systems.

This article does not attempt to completely survey the available local area network hardware and software for personal computers in office applications. Instead, I will try to give several particular illustrative examples and let the interested readers follow up directly with their local computer vendor or by study of the references.

First, let's look at some of the microcomputer vendors who have gone ahead and designed their own proprietary networks for their own machines.

### Proprietary Networks

Apple Computer Inc. recently announced a network for Apple products but has not delivered actual hardware and software or complete details on it yet. Applenet is described as a 1-megabit-per-second network, connecting as many as 128 stations over at most 2000 feet. It uses a twinax cable, which runs between a series of transformer-coupled boxes that permit as many as four stations to tap in at a time to the main bus. A



## Leading Edge Z-80, S100 Distributed Processing. \$475.00

Memory transfer rates of 517Kbytes/second, direct memory access, memory mapping and host to slave requests via interrupt control make the CPS-MX fast. And easy to integrate. Fully compatible with TURBOdos™, Intercontinental Micro System's slaves are available in four versions: synchronous or asynchronous serial port, 4Mhz or 6Mhz. The choice is yours. The CPS-MX also allows the bus master to utilize slave memory at the user's discretion. The slave then acts as a 64K RAM card.

The CPS-MX is also easy to integrate with Intercontinental's full line of S100 products: CPZ-48000 SBC single board computer with 64K on board RAM, 4 I/O

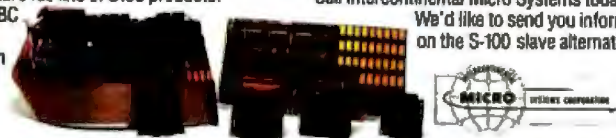
channels, memory management, on board floppy controller, DMA and vectored priority interrupts; and 256K bank selectable or contiguous memory.

A complete line of personality boards allow easy interface to anything from a floppy to a winchester, including modems and printers, and don't take up any S-100 bus space.

Best of all is the price. The CPS-MX starts at \$475.00. That's right, up to 65% less than what you have been paying for products that may not measure up.

Call Intercontinental Micro Systems today.

We'd like to send you information on the S-100 slave alternative.



1733 South Douglass Road, Suite E, Anaheim, California 92806 (714) 978-9758 Telex: 678401-TAB-IRIN

TURBOdos is a trademark of Software 2000 Inc.



# INNOVATIONS IN WINCHESTER SUBSYSTEMS!



## TALLGRASS AND YOUR IBM® PC

Tallgrass Technologies is the industry leader in Winchester HardFile™ and streaming tape subsystems for the IBM® PC. Fortune 500 corporations, banks, governmental agencies, and small businesses throughout the world depend on Tallgrass HardFile subsystems for their mass storage and backup requirements.

Tallgrass offers formatted capacities from 6.25 Mb to 70 Mb with integral streaming tape back-up. Our proprietary disk/tape controller with integral 10K track buffer optimizes read/write activity and, coupled with our DMA host interface, offers high performance previously unavailable with 5 1/4" disk systems.

### WHAT ABOUT DATA INTEGRITY?

Tallgrass offers backup on ANSI standard 5/4" tape cartridges, instead of the usual floppies, video cassettes, or low-capacity removable Winchester devices. The Tallgrass 12.5 Mb formatted Hardfile can back itself up on a \$39.95 data cartridge in less than 10 minutes!

Circle 437 on inquiry card.

All Tallgrass Hardfiles are equipped with a dedicated landing zone where the read/write heads land. This protects against incidental damage and data loss during power-downs and transportation.

### TALLGRASS IS UNSURPASSED

We've done our homework in engineering and building a reliable HardFile subsystem with remarkable performance and convenient backup for the most stringent on-line mass storage and off-line archival requirements.

From \$3095 including integral tape backup. Available from COMPUTERLAND® and other participating computer dealers.

*Exclusive Canadian Distributor:*  
Micro-Ware™  
440 Phillip St.  
Waterloo, Ontario N2L 5R9  
(519) 884-4690

*Exclusive European Distributor:*  
CPS Computer Group, Ltd.  
Birmingham,  
England B27 6L3H  
(021) 7073866



**Tallgrass  
Technologies**  
Corporation

11667 W. 90th, Overland Park, KS 66214, (913) 492-6002  
TWX: 215406 TBYT



spokesperson stated that Apple expects the networking hardware to sell for less than \$500 per station and be available at the end of 1983. Although the network was announced as part of the new Lisa computer, Apple stated that Appletalk will also be available for the Apple II and III machines. No details were given on the kinds of hardware or software services that will be made available with Appletalk.

Altos Computer Systems introduced its own Altosnet during 1982. This system can connect together as many as 32 stations at a data rate of 800K bits per second. Each system attachment costs \$295. Currently, Altosnet appears to be available only for the interconnection of more than one Altos multiuser (Xenix) system to another. It cannot be used to network independent single-user personal computers at this time.

Digital Microsystems has been one of the pioneers in this field, providing the Hinet system. It connects as many as 32 users at 500K bits per second, by a maximum of 1000 feet of multi-wire ribbon cable. Digital Microsystems has recently introduced a series of special workstations, specifically for use on its network, which do not incorporate local disks. This is one of the first network-only workstations available in the microcomputer world.

North Star Computers provides the Northnet system for its Advantage microcomputer. This system supports CP/M-only applications and permits the sharing of resources in a 4000-foot end-to-end network. The network runs at 1 megabit per second and costs approximately \$400 per station.

Cromemco Inc. provides its own C-Net, which is a twinax-cabled system running at 500K bits per second. It costs more than \$1000 per user if an interface is dedicated to each workstation but drops to less than \$500 if shared among 5 or more users.

Vector Graphic developed its LINC (local interactive network communications) system, which is a token-passing network, running at 750K bits per second, over two twisted-pair cables. As many as 16 stations can be connected over a

2000-foot distance, at a cost of about \$750 per station. An enhanced version of CP/M is provided for network access.

### **Nonproprietary Networks**

Only a few networks were developed by a computer vendor and then subsequently adopted by a number of other companies for their own use. There are three prime candidate networks in this area: the Corvus Omninet, Xerox Ethernet, and Datapoint ARCnet (attached resource computer network).

The Omninet system is designed for educational and small-business markets. As many as 64 stations can be connected to a 1000-foot cable. Repeaters can be used to extend the cable length to as many as 4000 feet.

---

## **The three prime candidates for standard networks are the Corvus Omninet, Xerox Ethernet, and the Datapoint ARCnet.**

---

Omninet transmits data at 1 megabit per second, and a variety of micro-computer interfaces is available from Corvus Systems Inc. The interfaces range in cost from about \$500 to \$750. Corvus has worked with several computer vendors and licensed the technical details to them for use with their own offerings. Some examples of these companies are Dictaphone, Onyx, NCR, and Texas Instruments. Corvus also offers the simpler Multiplexer that shares time on the peripherals and uses the same high-level Constellation software that Omninet does. Corvus now manufactures its own office workstation, known as the Concept, which comes with a network interface as a standard feature.

Xerox Corporation has developed and licensed its own networking system, Ethernet, with the support of Intel, Digital Equipment Corporation, and many other manufacturers. Ethernet communicates at 10 megabits per second and can connect as many as 1024 stations attached to a

series of segments that span as much as 7600 feet. Each station is given a unique 48-bit address, and Xerox provides a means of coordinating addresses and protocols on a worldwide basis. The Ethernet scheme provides the technical basis for one of the three IEEE committee standards. Due to the very early availability of the technical details from Xerox, Ethernet achieved a large measure of de facto acceptance prior to any formal adoption. Xerox has also released many of the details of the higher-level protocols, the Xerox Network Systems, that it uses throughout its network products; this, too, has led to significant de facto standardization to date.

Due to Ethernet's high performance and tight technical specifications, Ethernet controllers have been more expensive than other offerings. The recent production of custom very large scale integration (VLSI) chips has lessened the disparity, and the 3COM Corporation has introduced an Ethernet controller for the IBM PC, with a price of \$950 per station. The 3COM Corporation also offers a shared hard disk, Ethershare (\$11,500), and software packages to use with it. Etherprint (\$750) enables several users to share printers, and an electronic mail package, Ethermail (\$1500), provides sophisticated office communication for as many as 1024 users. The 3COM Corporation has agreed to provide Ethernet controller cards to Apple for use in all Apple's personal computers, including the Lisa, and also supplies controllers on an original equipment manufacturer (OEM) basis to companies such as Altos Computers and Digital Equipment Corporation.

Datapoint Corporation introduced its ARCnet system for linking together its own series of office equipment products beginning in 1977. Since then the product has expanded and, due to the thousands of systems being sold, was reduced to VLSI circuitry early. These circuits are available without any licensing fees or restrictions from their manufacturers, which is a more open stance than that taken with the previous two systems. ARCnet communicates at 2.5 mega-



# Tek's most successful scope series ever: At \$1200-\$1450, it's easy to see why!

**Wide-range vertical sensitivity:** Scale factors from 100 V/div (10X probe) to 2 mV/div (1X probe). Accurate to  $\pm 3\%$ . Ac or dc coupling.

**Two high-sensitivity channels:** dc to 60 MHz bandwidth from 10 V/div to 20 mV/div; extended sensitivity of 2 mV/div at  $\pm 50$  MHz.

**Sweep speeds:** from 0.5 s to 50 ns. To 5 ns/div with X10 magnification.

**Delayed sweep measurements:** Accurate to  $\pm 3\%$  with single time-base 2213; to  $\pm 1.5\%$  with dual time-base 2215.

**Complete trigger system.** Includes TV field, normal, vertical mode, and automatic; internal, external and line sources; variable holdoff.

**Probes included.** High-performance, positive attachment 10-14 pF and 60 MHz at the probe tip.



In 30 years of Tektronix oscilloscope leadership, no other scopes have recorded the immediate popular appeal of the Tek 2200 Series. The Tek 2213 and 2215 are unapproachable for the performance and reliability they offer at a surprisingly affordable price.

There's no compromise with Tektronix quality: The low cost is the result of a new design concept that cut mechanical parts by 65%. Cut cabling by 90%. Virtually eliminated board electrical connectors. And eliminated the need for a cooling fan.

Yet performance is written all over the front panels. There's the bandwidth for digital and analog circuits. The sensitivity for low signal measurements. The sweep speeds for fast logic families. And delayed sweep for fast, accurate timing measurements.

**The cost: \$1200\* for the 2213. \$1450\* for the dual time base 2215.**

You can order, or obtain more information, through the Tektronix National Marketing Center, where technical personnel can answer your questions and expedite delivery. Your direct order includes

probes, operating manuals, 15-day return policy and full Tektronix warranty.

For quantity purchases, please contact your local Tektronix sales representative.

**Order toll free:  
1-800-426-2200  
Extension 54**

In Oregon call collect:  
(503) 627-9000 Ext. 54

\*Price F.O.B. Beaverton, OR. Price subject to change



# The next generation ISAAC/Apple



## Important advances in the proven lab computer.

Apple is the world's most popular personal computer. Now the ISAAC/Apple is the world's most flexible, most accessible, most useable laboratory computer system.

More than a thousand ISAAC/Apple Laboratory Computer Systems are already at work, handling hundreds of applications in laboratory, electronic test and process control environments. Now this enormously successful system has been significantly improved.

To begin with, the system uses either the Apple II Plus or the new Apple IIe, with improvements like expanded 64K memory, easier-to-use keyboard, and enhanced operating system. Then there are new ISAAC enhancements: expanded software, new hardware and new flexibility.

### Softening a hard job.

Your work is demanding enough already. You shouldn't have to struggle with software. So ISAAC's LabSoft extended BASIC has been made even more powerful with no sacrifice in ease-of-use, and convenient new utilities and application programs have been added. For example, there's a new high-speed data acquisition utility and a program that makes formatting graphs a breeze.

Then there are menu-driven "no programming" software packages for thermocouple data logging (DATA-TEXT) and chromatography data handling (CHROMATEXT), and software for communications to host or other personal computers.

No software anywhere works better in the lab. And, of course, no other software offers you the important advantage of Cyborg professionals ready to assist you in configuring and supporting the best system for your individual application.

### Hardware that makes getting started easy.

The new modular ISAAC Model 41A now joins the full-featured Model 91A in Cyborg's line. When you choose the 41A, you can buy only the components your specific application requires, meaning entry-level prices are lower—as low as \$4,000 including the Apple IIe. You can then add expansion modules—A/D, D/A, Binary I/O and more—as you grow.

Then there's the new Data-Mem Card, a 147K memory buffer. It frees more of the Apple's internal memory for your programs and data. And there's a remote input system for pre-amplification of signals from thermocouples (K, J, T and others),

RTDs, strain gauges, instruments and any other digital or analog signal. It can handle just one instrument or as many as 256 channels, at distances up to 50 feet.

## ISAAC

### Your laboratory solution.

The computer's impact on the laboratory is no longer a matter of conjecture. Everywhere, computers are bringing new speed, accuracy, and ease of use to data handling and storage.

And now Cyborg, the recognized leader in personal laboratory computer systems, introduces a new generation ISAAC/Apple system, adding flexibility, affordability and even more computer power.

If you want more from your instruments or sensor-based systems, you should have ISAAC/Apple working for you.

And the very first step in that direction is to find out more. Call, write or check the reader service number below, and we'll rush you information that can bring your laboratory into the computer age.

55 Chapel Street, Newton, MA 02158, (617) 964-9020, (800) 343-4494

# Cyborg<sup>®</sup>

Apple is a registered trademark of Apple Computer, Inc. Cyborg is a registered trademark of Cyborg Corporation. Chromatext, Datatext and LabSoft are trademarks of Cyborg Corporation.

Circle 145 on Inquiry card.



bits per second, and as many as 255 stations, as far as 4 miles apart, can be connected at a time. ARCnet is a bus-oriented system, i.e., any station can communicate to any other without intervention. But the electrical connection is made (every 2000 feet) through a starlike amplifying and isolating device; thus the physical topology resembles a star or treelike form. The form of access control used is a token-passing scheme, which is a ringlike logical connection.

The issue of installed cabling may be critical in decisions about adopting a network, as was pointed out in the discussion about PBXs earlier in the article. ARCnet uses the standard IBM 3270 coaxial and connectors for its cabling scheme, thus taking advantage of the wealth of field experience and quantity of installed cable (more than 1 million offices). Rather than costing about \$1000 per station, as in Ethernet, ARCnet interfaces range from \$400 to \$600.

ARCnet has been adopted by two other companies to date in the micro-computer arena. Tandy Corporation announced that it will provide ARCnet capability for its Model II and Model 16 products. Tandy will provide a series of shared disk systems and the necessary software for office use.

Nestar Systems provides its PLAN (Personal Local Area Network) 4000 series products, which use ARCnet for their electrical network interconnection. Nestar chose to adopt another de facto standard at the same time, namely, the Xerox Network System (XNS) protocols (Levels 3 to 5), which are used by many Ethernet implementations. This permits the eventual easy interconnection between ARCnet and Ethernet for Nestar products, as well as the use of many XNS-based software products in an ARCnet hardware base.

Nestar's PLAN 4000 system interconnects IBM PC, Apple II, and Apple III workstations. Software is provided to permit each of these machines to operate in one of several different local-operating-system environments, rather than restricting the user to one particular choice. This may be important in permitting users

to select their environment based on the available application software, and not the other way around.

Nestar, like Xerox and Datapoint, provides a fairly complete set of surrounding hardware and software offerings to add to the basic networking equipment. This includes such capabilities as sharing disks, printers, a multitude of mainframe communications packages, electronic mail, etc.

### Who's Missing?

The overview here is partial. Undoubtedly by the time this article is in print, there will have been significant changes in the networking industry. In particular, the offerings from IBM have not yet been unveiled. Once done, we can expect to see many companies shift swiftly in its direction.

The crucial question has to do with activities in the operating system and application software arena. Will we see true embedding of network primitives in the operating systems produced by such companies as Microsoft, Digital Research, and Softech Microsystems? (Digital Research has introduced the CP/NET system, but it has not been an outstanding success as measured by the number of networking companies that prefer to develop their own network-based CP/M support.) And which programs will take advantage of the multiuser database aspects of networks? Will the vendors of software packages trust the security and protection mechanisms of microcomputer-based local area networks? Who will sell networking systems—local computer retailers or specialty houses that work only in selected vertical markets?

### Summary

Local area networking of personal computers in the office is a complex subject. The number of solutions offered are bewildering to purchasers of such systems, and it looks as if the product proliferation will continue for some time before any true coalescence occurs. Standardization is a slow process, and the real problems have yet to be addressed. At this time, users need to work closely with



## Get the total picture.

Improve your present computer system with a high-resolution color monitor from NEC.

For superior color and clarity, you can hardly do better than NEC's JC-1212 Color Monitor. Use it to get a better picture on your present system or a truly first-rate picture with a complete NEC computer system. The JC-1212 is compatible with Apple II, Apple II+, Atari 800 and 400\*, VIC 20\*, and others, including NEC's own NEC TREK (PC-6000).

Compare these specs with your present monitor:

12-inch diagonal screen

90-degree deflection

Polarity Sync. negative

15.75 kHz x 60 Hz scanning frequency

40-character, 25-line display

Resolution of 250 lines at center

\*Special interface required



Productivity at your fingertips

# NEC

NEC Home Electronics (U.S.A.), Inc.

Personal Computer Division

1401 Estes Avenue

Elk Grove Village, IL 60007

(312) 228-5900

Nippon Electric Co., Ltd., Tokyo, Japan



# Your computer's telephone.

# Hayes

Phil: Just got the word from Gary. Increased our share by 6%. If trend holds, we'll pass competition by third quarter.

To all reps: Price changes on following items effective immediately:  
NO-10-11A, 10-11A, 10-A1.

Welcome to TELEMAIL! Your last access was Tuesday, May 3, 1983 11:07 a.m. CHECK these bulletin boards: TELEMAL...TELESOFT...



system, they allow you to communicate over ordinary phone lines with computers and terminals anywhere in America. But any modem will send and receive data.

A Hayes Smartmodem also dials, answers and disconnects calls. Automatically. And it does this without going through the telephone receiver, a design feature that makes it far superior to acoustic coupler modems.

**Choose your speed, choose your price.** Hayes Smartmodems are available at two different speeds and price levels. The lower-priced Smartmodem 300 is ideal for local data swaps and communicates at 300 bps.

For longer distances and larger volumes, Smartmodem 1200 operates at 1200 bps or up to 300 bps, with a built-in selector that automatically detects transmission speeds.

Both modems work with rotary dials, Touch-Tone\* and key-set systems. We've even included an audio speaker and indicator lights so you can monitor the communica-

tions process. Smartmodem 1200 has an additional indicator light that detects high-speed transmission. And, unlike many modems, both Smartmodems operate at full or half duplex, for compatibility with most time-sharing systems.

**At Hayes, all of these "extras" are standard.** We've built our reputation on superior quality. Excellent documentation. A limited two-year warranty. And a wide range of software support. Including our own hot-selling Smartcom II™ communications software for the IBM\*\* PC, making Smartmodem 300 and 1200 even easier for you to use.

See your computer dealer today for a demonstration.

Then break out of isolation. Get a Hayes telephone for your computer.

Hayes Microcomputer Products, Inc., 5923 Peachtree Industrial Blvd., Norcross, Georgia 30092. 404/449-8791.



Smartcom II is a trademark of Hayes Microcomputer Products, Inc.

\*TM American Telephone & Telegraph  
\*\*IBM is a registered trademark of International Business Machines, Corp.  
©1983 Hayes Microcomputer Products, Inc.  
Sold only in the U.S.A.

Circle 212 on inquiry card.

A personal computer without communications, is like a car without gasoline. It can't go anywhere.

It needs a special telephone (called a modem), to get you communicating with other computers. Across the city. Or the entire country.

Whether you're swapping programs with friends or club members. Working at home and sending reports to the office. Or taking advantage of a wealth of information from any of the networks or information utilities. Telecomputing greatly expands the world of your personal computer.

**And Hayes provides the communications link.** Smartmodem 300, and the faster Smartmodem 1200, work with any computer with an RS-232C I/O port. Plugging your computer directly into the phone



those vendors and their representatives who are well trained, knowledgeable, and dedicated to the field of networking. It is not as simple as plugging in a card, much as one would plug in a printer interface or memory expansion board. In spite of the complexity, personal computer local area networks are being used for some truly exciting applications, but, for the moment, they are not available as off-the-shelf products. Community microcomputing, the merger of personal computers and local area networking, is becoming a standard offering of most microcomputer vendors, but only a few have recognized the advantages of adopting standards and have avoided

the pitfalls of the invent-your-own approach. True office local area networking is still a dream to be fulfilled. ■

#### References

1. Davis, George R., ed. *The Local Network Handbook*. New York: McGraw-Hill, 1982.
2. Saal, Harry J. "Local Area Networks: Possibilities for Personal Computers." *BYTE*, October 1981, pages 92-112.
3. Shotwell, Robyn. *The Local Computer Network Vendor List*. San Francisco: Shotwell and Associates, 1982.
4. Thurber, Kenneth. *The LocalNetter Designer's Handbook*. Minneapolis, MN: Architecture Technology Corporation, 1982.
5. Wolfberg, N.E., ed. *The Ethernet Handbook*. San Francisco: Shotwell and Associates, 1982.

Vendor	Product	EXO Corporation 1265 Montecito Ave. Mountain View, CA 94043 (415) 969-8624	EXO/NET
Action Computer Enterprises Inc. 55 West Del Mar Blvd. Pasadena, CA 91105 (213) 793-2440	DPC/NET	Nestar Systems Inc. 2585 East Bayshore Rd. Palo Alto, CA 94303 (415) 493-2223	PLAN 4000
Apple Computer Inc. 20525 Mariani Ave. Cupertino, CA 95014 (408) 996-1010	Applenet	North Star Computers Inc. 14440 Catalina St. San Leandro, CA 94577 (415) 375-8500	Northnet
Altos Computer Systems 2360 Bering Dr. San Jose, CA 95131 (408) 946-6700	Altosnet	Tandy Corporation 1800 One Tandy Center Fort Worth, TX 76102 (817) 390-3300	ARCnet
Corvus Systems Inc. 2029 O'Toole Ave. San Jose, CA 95131 (408) 946-7700	Omninet, Multiplexer	3COM Corporation 1390 Shorebird Way Mountain View, CA 94043 (415) 961-9602	Etherseries
Cromemco Inc. 280 Bernardo Ave. Mountain View, CA 94040 (415) 964-7400	C-Net	Tri-Data 505 East Middlefield Rd. Mountain View, CA 94043 (415) 969-3700	NNET
Datapoint Corporation 9725 Datapoint Dr. San Antonio, TX 78284 (512) 699-7151	ARCnet	Vector Graphic Inc. 500 North Ventu Park Rd. Thousand Oaks, CA 91320 (805) 499-5831	LINC
Digital Microsystems 1840 Embarcadero Oakland, CA 94606 (415) 532-3686	Hinet	Xerox Office Systems Division 1341 West Mockingbird Lane Dallas, TX 75247 (214) 689-6000	Ethernet



## Read the fine print.

**Improve the output of your present system with a dot-matrix printer from NEC.**

For good-looking copy in a hurry, it's hard to beat NEC's hard-working PC-8023A. This is a bi-directional 100 CPS, 80-column printer that can operate in a compressed-print mode to yield 132 columns. Special 2K buffer holds a page of data, so the unit can print while you're typing in something else. Compatible with a wide range of computers, from Apple\* to Zenith\*\*.

Compare these features with your present printer:

#### Tractor and friction feed

**Complete ASCII characters plus Greek, math, and graphic characters**

**Elite, pica, compressed print, proportional spacing, subscript and superscript**

**Standard parallel Centronics interface, serial optional**

**Prints clear original and up to three copies simultaneously**

\*Special cables may be necessary. Contact your local NEC Home Electronics dealer



**Productivity at your fingertips**

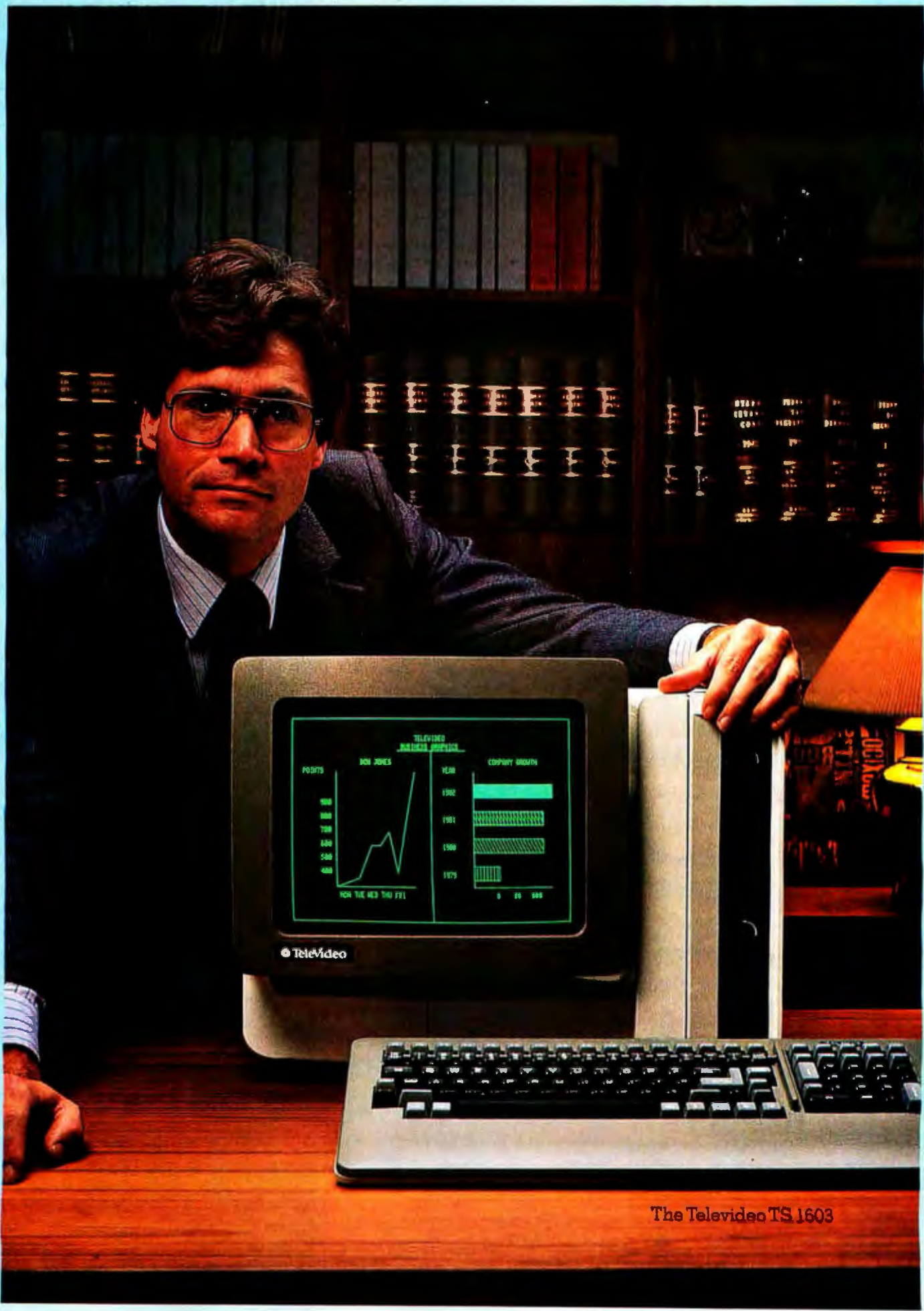
# NEC

**NEC Home Electronics (U.S.A.), Inc.  
Personal Computer Division**

1401 Estes Avenue  
Elk Grove Village, IL 60007  
(312) 228-5900

Nippon Electric Co., Ltd., Tokyo, Japan





The TeleVideo TS 1603



# "I chose TeleVideo's Personal Computer for all the things IBM left out."

I didn't choose TeleVideo because it's \$1,000 less than IBM\*. It was because TeleVideo thought of everything.

To begin with, my TeleVideo has twice as much storage capacity as IBM, even with the extra cost IBM disk drive. I can use that extra capacity.

My TeleVideo came with a big 14" screen that's easier to read, and it tilts for the extra comfort that's so important when you use a computer as much as I do. With IBM, you pay more for a smaller 12" screen that doesn't tilt at all.

Another thing I like. TeleVideo's keyboard is so lightweight and comfortable my fingers hardly know they're working. IBM's keyboard? It's a little behind the times.

TeleVideo also gave me the choice of popular CP/M® or MS-DOS® operating systems—FREE—so I can pick from thousands of proven software programs. You can get the same option from IBM, but you have to pay for the privilege.

Last but not least, TeleVideo's network capabilities give me a real growth path

for the future, linking up to sixteen computers in one powerful network. You can't get that from IBM.

So before you choose any personal computer, do like I did and compare. You'll see that TeleVideo gives you a lot more computer for a lot less money. And you'll buy TeleVideo because they didn't leave anything out.

For more information, write TeleVideo Systems, Inc., 1170 Morse Ave., Sunnyvale, CA 94086, call toll-free 800-538-1780 (In California call 800-672-3470 Ext. 945), call one of our authorized distributors or dealers, or contact one of our regional sales offices, listed below.

Northeast Region, 617-369-9370

Eastern Region, 703-556-7764

Southeast Region, 404-447-1231

Midwest Region, 312-969-0112

South Central Region, 214-258-6776

Northwest Region, 408-745-7760


Southwest Region, 714-752-9488

European Sales (Holland), (31) 075-7461

UK/Scandinavia Sales, (44) 0908-668-778

TeleVideo Systems are fully serviced nationwide by TRW

\*Based on manufacturer's suggested retail prices for comparably equipped computer

 **TeleVideo Systems, Inc.**

Circle 448 on inquiry card.



## The Fortune 32:16 Business Computer

*A multiuser, multitasking system that runs enhanced Unix.*

---

Steven H. Barry  
Systems Research Laboratories Inc.  
6231 Leesburg Pike, Suite 300  
Falls Church, VA 22044

---

The Fortune 32:16 has garnered its share of publicity as the first well-integrated Unix-based computing system for about \$5000. "Under \$10,000" might be more accurate, but at any rate the system has several unique and interesting features. User-friendly, the Fortune is directed at the first-time business computer user. In this review I'll describe the system's features, cost, performance, and product support and take a look at the For:Word word-processing program.

### An Overview

The basic Fortune 32:16 is housed in three cabinets—the processor unit, the keyboard, and the video display unit (see photo 1). The processor unit contains a Motorola 68000 microprocessor that runs at 6 MHz, 256K bytes of memory (expandable to 1 megabyte of main memory), and a video-display controller board. The system can presently support a four-port serial-terminal controller and a microprocessor-based intelligent-terminal controller. In the future it will support these peripheral controllers as well: an optional storage-module disk interface, a parallel device interface, a high-resolution graphics board, and an Ethernet local-area network board. A console keyboard and video interface are standard, as is an RS-232C serial interface, which is often used for a serial printer.

The unit also contains a programmable-array logic IC (integrated circuit) and PROM (programmable read-only memory) used for loading the operating system,

---

### About the Author

*Dr. Barry is a senior scientist with Systems Research Laboratories Inc. working on state-of-the-art personal workstations.*

---



**Photo 1:** Fortune's 32:16 computer system. The processor unit and keyboard and video display for a single user are shown.

software-security and operating-system parameter tables (parts of which can be modified by the user), and magnetic-disk storage controllers and drives.

The detachable console keyboard is connected to the front of the processor unit by a 4-foot coiled cord with a modular jack. The keyboard is a close cousin of the one found on Wang Laboratories' word-processing systems, but it has a total of 99 keys, including a 15-key numeric keypad. These are well arranged and color-coded. A Help key provides access to online help pages at nearly any stage of operation. Sixteen programmable function keys, which are used by Fortune-supplied application programs, are available for user-developed programs. The keyboard provides adjustable auditory feedback, good tactile feedback, and two speeds of automatic repeat when a key is held down.



# TECMAR'S GRAPHICS MASTER.™

It adds graphics to your IBM Monochrome Display, or 16 high-resolution colors to your color monitor!



**Now your IBM-PC can run monochrome or color displays with remarkably enhanced graphics... and all from this one multi-function board — no other video board needed!**

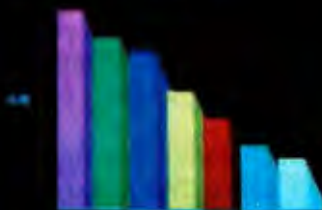
With your IBM Monochrome Display, the Graphics Master™ board gives you truly high resolution graphics, allowing 640 horizontal x 350 vertical pixel display.

With other monochrome display screens you can obtain even higher resolutions — up to 640 H x 480 V, with full-page 80-character x 60-line text display.

With a color monitor, it extends your color graphics to 640 horizontal x 400 vertical 16-color interlaced display.

Graphics Master™ accepts external sync, so you can add labeling to images. You can overlay characters or other computer-generated images on a video picture using the PC-Mate™ Video Cassette Recorder Controller.

This remarkable new board fully supports all IBM advanced BASIC color graphics functions.



For further information about our Graphics Master™ and the largest line of options available anywhere for the IBM Personal

Computer, call or write for the latest catalog of PC-Mate™ peripherals from Tecmar.

## TECMAR

The Next Step

Personal Computer Products Division  
23610 Mercantille Road  
Cleveland, Ohio 44122  
Phone 216-364-7410/Telex 241735



## At a Glance

### Name

Fortune 32:16 computer system

### Manufacturer

Fortune Systems Corporation  
300 Harbor Blvd.  
Belmont, CA 94002  
(415) 593-9000

### Price (suggested retail)

Single floppy-disk-based, single-user system: \$4995  
Dual floppy-disk-based, single-user system: \$5990  
5-megabyte hard disk, one floppy disk, single-user system: \$8990  
10-megabyte hard disk, one floppy disk, single-user system: \$9990  
20-megabyte hard disk, one floppy disk, single-user system: \$10,990

### Dimensions

Processor unit: 5.8 by 13.9 by 22.3 inches, 30 pounds  
Console video display: 12.9 by 13.7 by 12.3 inches, 12 pounds, connected to rear of the processor unit with a 4-foot coiled cord with a modular jack.  
Keyboard: 2.2 by 6.3 by 22.3 inches, 6 pounds, connected to the front of the system unit by a 4-foot coiled cord with modular jack.

### Description

Fortune 32:16 computer: Motorola 68000 microprocessor, 6-MHz system clock. Minimum 256K bytes of memory, 1.0-megabyte maximum. Five memory slots (one for error checking and correction board), five I/O option slots. Standard interfaces: disk control, video terminal control board, serial line printer RS-232C, and console keyboard and display, 99-key, detached, color-coded, business-style keyboard with numeric keypad, 16 function keys, Help and Cancel/Delete keys. 12-inch green-phosphor display with 80-column by 24-row display format, 9-by 20-dot-matrix character cell, with tilt and swivel mount.

### Disk Storage

One or two disk options housed within the system unit. Hard disks: 5-, 10-, or 20-megabyte stepper-motor head positioner drives (approx. 75 ms average access time). Floppy disks: 800K-byte capacity, 96 tracks per inch, double sided. Additional disk storage in expansion cabinet: \$750\* (holds up to two devices). Additional 5-megabyte disk: \$1995. Additional 10-megabyte disk: \$2995. Additional 20-megabyte disk: \$3995.

### Magnetic Tape Cartridge

20-megabyte cartridge-tape drive with integral controller in expansion cabinet: \$3550\*. May be ordered with a disk drive (see above for prices).

### Operating System

Unix, version 7 with Fortune, University of California, Berkeley, and a small number of System III enhancements. Multiuser capabilities are available for \$495. The Fortune-developed user interface (i.e., shell) as well as the Unix pseudostandard Bourne shell are available to the user. Standard Unix file-system structure allows essentially unlimited nesting of user directories. Fortune has implemented file, page, and record locking features. File system and software integrity checking is executed at start-up and shut-down.

### Software

Business-accounting software available. Order processing and inventory control: \$595\*. Accounts receivable: \$595. Purchase orders: \$395. Accounts payable: \$595. Payroll: \$595. General ledger: \$395. For:Word: \$495. For:Word Plus: \$795\*. Idol database-management system: \$595\*. Multiplan spreadsheet: \$295. Business BASIC: \$295. C language, FORTRAN-77, and Pascal\*: \$495 each. Two types of COBOL—Type 1: \$495 runtime environment, \$795 compiler. Type 2: unpriced at this time. Fortune operating system development tools: \$495.

\* Denotes items that are near release or planned for release at this writing.

The separate 12-inch (diagonal measure) video monitor has a green-phosphor screen with medium persistence and displays 80 columns by 24 rows. Characters are formed in a 9 by 20 pixel (picture element) cell. A set of up to 288 different characters can be displayed, including a subset of the AT&T videotex character set. The display's several video attributes include blink, inverse video, and bright fields.

The monitor is mounted on a sturdy, but too low, pedestal that permits easy tilt and swivel adjustments. The video display is connected to the rear of the processor unit by a 4-foot coiled cord and a modular jack.

The Fortune 32:16 comes with three hard-disk storage options: the disk controller can handle up to four 5-, 10-, or 20-megabyte disk drives. All hard-disk configurations come with a single 5¼-inch double-sided double-density 96-track-per-inch (800K-byte) floppy-disk drive. The floppy-disk drive is used for backup and for removable storage of data and programs. All software releases are on floppy disks. The processor's cabinet can accommodate only two such mass-storage devices. An optional disk cabinet will be available to house additional hard- or floppy-disk drives or a 20-megabyte cartridge-tape unit.

Depending on the user's needs, the system software, languages, and application programs may consume between 3.0 and 6.2 megabytes of disk storage. Thus a business with multiple users would be wise not to consider a system with less than 10 megabytes of hard-disk storage. Memory is also an important resource in Unix systems; it makes good sense to provide plenty of RAM (random-access read/write memory) to avoid excessive swapping to the disk.

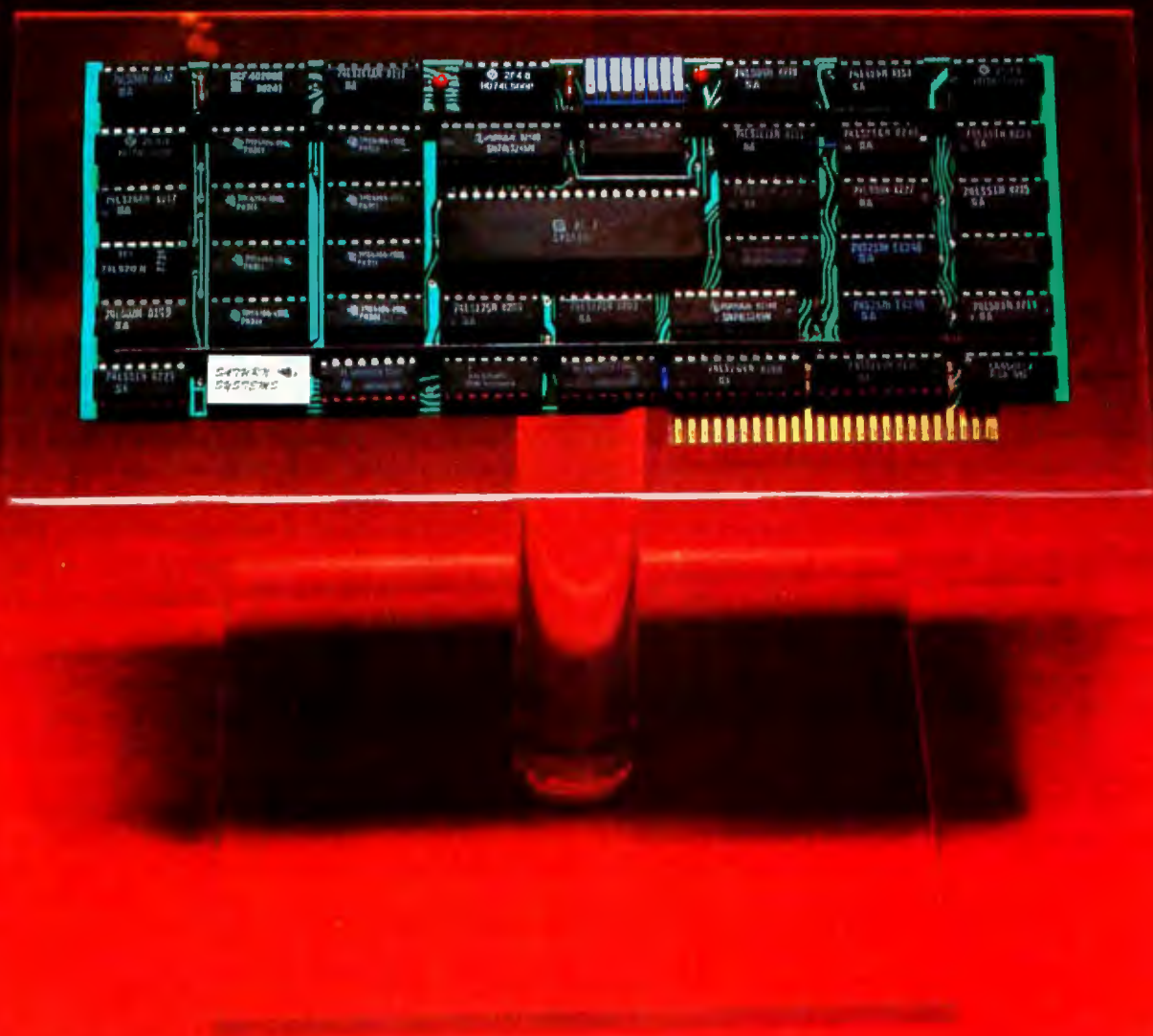
### Cost

A practical small multiuser configuration would be what Fortune Systems Corp. calls a System 10 (it has a 10-megabyte hard disk with the system keyboard and video monitor, one 800K-byte floppy disk, and 512K bytes of memory) and a four-port serial communications interface. Together with the multiuser-system software upgrade, this configuration will cost \$11,980—that's without terminals or application software. The lowest-cost hard-disk-based single-user system is \$7990 (a promotional price, \$1795 less than list price), including the system keyboard and display, a 5-megabyte hard disk, the For:Word word-processing package (soon to be



# ANNOUNCING THE ACCELERATOR II™

Make your Apple® II run 3.6 times faster with VisiCalc™, DB Master®, Applesoft, Apple Fortran, Pascal, and much more! Eliminate those long delays in recalculating VisiCalc models, etc. Just plug in the Accelerator II, and make your Apple one of the most powerful microcomputers available.



The Accelerator II: Based on a fast 6502 processor with 64K of high-speed memory. Includes built-in fast Language card. Hardware compatible with all standard peripherals. Transparent operation with Apple II software. Special pre-boot diskette included to run Applesoft, PASCAL, and Integer Basic from high-speed RAM. Suggested retail price: \$599.

**SATURN SYSTEMS** inc.

P. O. Box 8050  
Ann Arbor, Michigan 48107  
(313) 973-8422



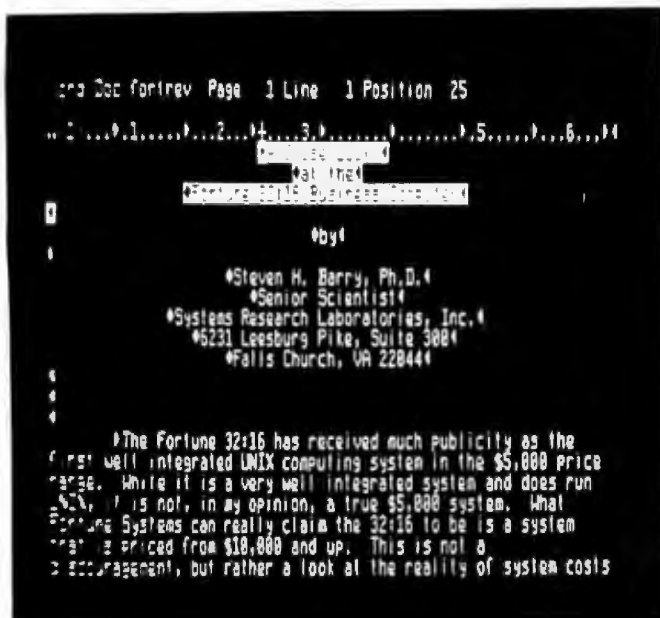


Photo 2: Editing sample text with For:Word. Note the status line at the top of the screen; it shows what page is being worked on, where the cursor is positioned, and where the tabs are.

dubbed Fortune:Word, to avoid legal hassles with another company), and a certificate for the advanced (but as yet unavailable) For:Word Plus. Programming languages, programmers' "tools," screen-oriented editors, communications software, and application programs such as accounting and graphics are all available for extra cost (see "At a Glance"). Single-user floppy-disk-based minimum systems have been announced at \$4995 and \$5990 for one or two floppy-disk drives, respectively, but neither system is presently available. I have not used a floppy-disk-based Fortune system, so I won't comment on its utility and performance. But I will note that "standard" Unix uses both disk and memory aggressively. Based on my experience with other Unix systems and with several popular but less sophisticated and flexible floppy-disk-based CP/M systems, I am pessimistic about the performance of a floppy-disk-based Unix system.

### Fortune Word Processing

One of the Fortune 32:16's most attractive features is the application software now available or planned for the near future. Word processing in particular is often cited as important for a small-computer user. The For:Word package is a close copy of the excellent Wang Laboratories system. Where differences can be found, they are either enhancements, trivial, or due to a bug. The Wang system is nearly bug-free (we have one in our office, and it was a major factor in our choice of the Fortune 32:16). The Fortune program is not bug-ridden, but it is recognizably new.

In general, the Fortune word processor compares favorably with popular alternatives for personal com-

puters. The extensive use of labeled function keys makes learning and using the system far easier than other popular programs such as Wordstar. For:Word, like Wang's editing system, is an early approach to a what-you-see-is-what-you-get word processor.

Wordstar does a better job with word wrap, pagination, and line-by-line justification on the screen, but For:Word's printer justification is better. For:Word also does a much better job with printing, hyphenation, formatting, searches, tabulation, and advanced features. Extensive use of screen attributes makes bold print and underlines quite clear. For:Word doesn't handle superscripts and subscripts as well; the material to be half-line shifted is surrounded with vertical arrows. That's much better than Wordstar, but it doesn't make things as nice as a true what-you-see-is-what-you-get system such as the Xerox 8010 Star word processor or Apple's Lisa.

Printing on the For:Word is accomplished by a post-processor that takes, in our application, from 10 to 40 seconds, depending on file length and system loading to execute before printing begins. On the Wang system, printing starts almost instantaneously.

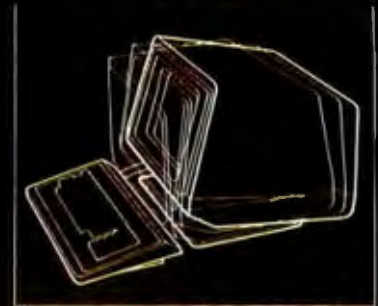
While the word processor is generally excellent, a few areas need improvement. These include line-by-line justification on the screen at text-entry time, printer-code conversion at text-entry time (to avoid long printer waits), word wrap keyed to a hard hyphen (currently done only at word breaks), the ability to start pagination or hyphenation passes at any arbitrary point in the text, and continuation of format settings (e.g., the Indent feature that keeps a block of text indented until the first hard carriage return is encountered) across page boundaries. Some of these features, such as line-by-line justification, would not look exactly like what you see on the printed page because the Fortune (and Wang) screens are character-oriented rather than bit-mapped (bit-mapped screens can be used to show microspacing on the screen). Some of these features and several others are slated for the For:Word Plus package, which is due out by the second quarter of 1983.

The word-processing screen (see photo 2) is headed by a status line that tells you the document name, the current page, line, and column, and the cursor mode. The cursor mode is the amount of material through which the cursor will move with a press of the left or right cursor-motion keys. There are five cursor-motion modes: word, line, sentence, paragraph, and page. Below the status line is the format line, which is used to control vertical line spacing (no space, quarter spacing, half spacing, single spacing, a space and a half, double spacing, and triple spacing are available). The format page also controls tab stops and line length and provides a visual indication of cursor position on a line. The text area is bounded at its bottom by a double dashed line and the words Document End.

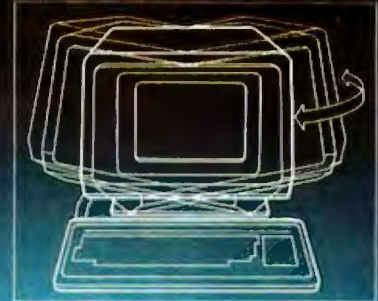
Overall document format standards are set in what is called a *prototype document*. Default settings such as line length, tabs, line spacing, and page length as well as



# VISUAL presents ergonomic elegance and high performance in a low-cost terminal.



Tilt: 10° forward, 15° backward



Swivel: 270°

VISUAL 50 and VISUAL 55 represent a new approach in low-cost terminals. Although they cost drastically less, they offer features you expect only from the high priced units.

For example, the enclosure is ergonomically designed in lightweight plastic and can easily be swiveled and tilted for maximum operator comfort. A detached keyboard, smooth scroll, large 7x9 dot matrix characters and non-glare screen are a few of the many human engineering features normally offered only on much higher priced terminals.

Another distinctive feature of the VISUAL 50 and VISUAL 55 is their emulation capability. Both terminals are code-for-code compatible with the Hazeltine Esprit, ADDS Viewpoint, Lear Siegler ADM-3A and DEC VT-52. In addition, the VISUAL 55 offers emulations of the Hazeltine 1500 and VISUAL 210. Menu-driven set-up modes in non-volatile memory allow easy selection of terminal parameters.

And you're not limited to mere emulation. As the chart shows, the VISUAL 50 and 55 have features and versatility the older, less powerful low-cost terminals simply cannot match.

The VISUAL 55 extends the VISUAL 50 performance by adding 12 user-programmable function keys, extended editing features and selectable scrolling regions.

Both terminals are UL listed and exceed FCC Class A requirements and U.S. Government standards for X-ray emissions.

Call or write for full details.

## FEATURE COMPARISON CHART

FEATURE	VISUAL 50/55	Hazeltine Esprit	ADDS Viewpoint	Lear Siegler ADM-5	TeleVideo 910
Tilt and Swivel	YES	NO	NO	NO	NO
Detached Keyboard	YES	NO	YES	NO	NO
N-Key Rollover	YES	NO	YES	NO	NO
Audible Key Click	YES	YES	NO	NO	NO
Menu Set-Up Mode	YES	NO	NO	NO	NO
Status Line	YES	NO	NO	NO	NO
Full 5 Attribute Selection	YES	NO	NO	NO	YES
Smooth Scroll	YES	NO	NO	NO	NO
Line Drawing Character Set	YES	NO	NO	NO	NO
Block Mode	YES	YES	NO	NO	YES
Insert/Delete Line	YES	YES	NO	NO	YES
Bi-Directional Aux Port	YES	YES	NO	YES	NO
Columnar Tabbing	YES	YES	NO	NO	YES
Independent RCV/TX Rates	YES	NO	NO	NO	NO
Answerback User Programmable	YES	NO	NO	OPT.	NO

Service available in principal cities through Sorbus Service, Division of Management Assistance, Inc.

Circle 477 on Inquiry card.

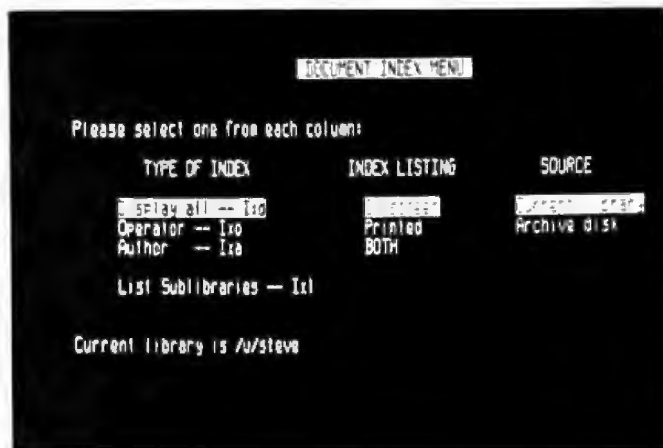
**See for yourself**

Visual Technology Incorporated  
540 Main Street, Tewksbury, MA 01876  
Telephone (617) 851-5000. Telex 951-539

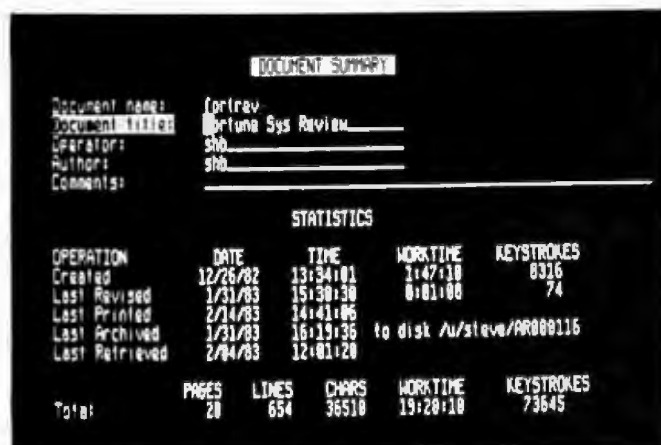




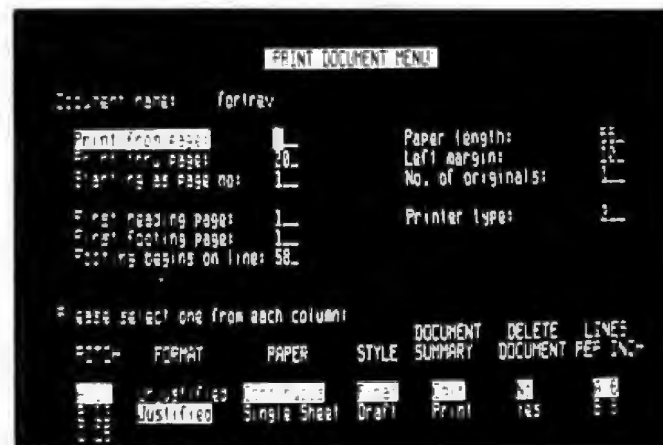
(3a)



(3b)



(3c)



(3d)

Photo 3: Some of the menus found in the Fortune's word-processing system. The menus are the main word-processing menu (3a), the document index menu (3b), the document summary (3c), and the document printing menu (3d).

default print options are set in this document. Each subsequent use of For:Word is initialized with these default settings.

Text entry begins at line one on a page and continues for as many lines as you want to enter. Pagination is done either manually or in a pagination pass at the end of the text-entry process. (It makes sense to define pages manually as you go along because several functions, such as Insert and Delete, trigger a line-by-line text-rearrangement process that works on a page at a time. "Pages" that are hundreds of lines long take a long time to rearrange.) A Go to Page function makes access to any selected page easy. Each page of the final output has a place for a header and a footer, which are specified by separate pages in the prototype document. Prototype documents offer considerably more format capability than is available with Wordstar.

Human-factors engineering was less a consideration when Wang created its word processor. As a result, some aspects of the generally good user interface are annoying or awkward. For:Word has improved on Wang by making processes and manipulations more explicit (see photo 3), but in some areas the user can still be easily confused.

One such area is in the exit process after editing is complete. To exit the word processor text-entry mode, you press the Cancel/Delete key. An "End of Edit?" message appears at the right side of the status line. Pressing the Execute key confirms that editing is done. After pressing Execute, the following menu appears:

END OF EDIT	
Cancel	erases the changes
Execute	saves the changes
Return	goes back to the editing screen

The correct choice looks easy, but in practice many users find the Cancel, Execute, Execute sequence, at first, counterintuitive. You only have to enter Cancel, Execute, Cancel once to appreciate the awkwardness of the whole process. There is no way to retrieve the buffer after such errors.

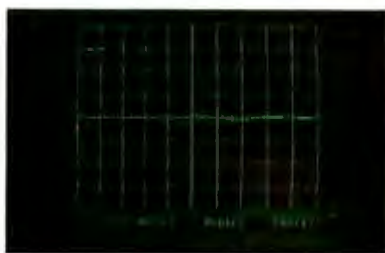
The HASCI (Human Applications Standard Computer Interface) keyboard, developed for and implemented on the Epson QX-10 computer, solves this problem by providing a Save key. The prerelease example of For:Word Plus that I saw improves on the current state of affairs



# From the inventors of the first personal computer-controlled, fully programmable digital oscilloscope, come two more instruments destined to make waves.



allows you to build complex waveforms by defining them mathematically or constructing them from



previously stored waveform segments. aSource generated waveforms have 12-bit resolution and record lengths up to 4096.

## *aGEN*

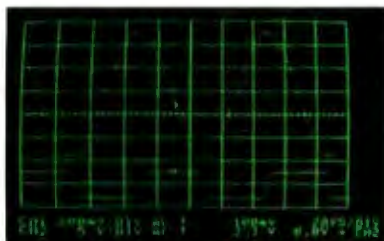
The aGen transforms the Apple II or IIE into a fully programmable 0.5Hz to 5MHz function generator that can generate all classic waveforms—sine, square, triangle, ramp and pulse.



Continuous, triggered, gated and n-burst modes, along with variable symmetry, amplitude and frequency modulation, combine to make aGen a full-featured, flexible signal source.

## *aSCOPE*

aScope completes the loop. From its residence in the Apple II or IIE aScope provides you with a dual



channel programmable 50MHz digital memory oscilloscope with standard operating software that includes

waveform disk storage and retrieval, hard copy output, waveform digital voltmeter, and waveform averaging.

## *THE REAL BEAUTY OF THE SYSTEM.*

Each of these personal instruments by itself is a versatile, cost-effective programmable instrument.

But used in combination they form an incredibly efficient, high-performance stimulus/acquisition system. A closed-loop system with which you can acquire information via the aScope and analyze it with



your Apple-resident BASIC or assembly language program. The program can then control the stimulus instrument (aSource or aGen) based on the analysis. And characterization, calibration and test results can be displayed according to your needs. Total cost of these capabilities (including the personal computer, monitor and disk drive)? Less than \$4,000.

So now you can allocate less time to setting up tests and wading through data. And more to the most important part of your work. Developing solutions.

For more information, including a demo disk or live demonstration, contact us for the name of the NWIS representative in your area.

PERSONAL INSTRUMENTS.  
BRINGING YOU CLOSER.



**NORTHWEST INSTRUMENT SYSTEMS, INC.**  
P. O. Box 1309, Beaverton, Oregon 97075  
800-547-4445, (503) 297-1434

Personal instrumentation. It's a whole new wave in test and measurement systems.

First, Northwest Instrument Systems introduced the Model 85 aScope™. Now it's joined by the aSource™ Arbitrary Waveform Generator and the aGen™ Programmable Function Generator. Result? The world's first personal computer-based, closed-loop waveform stimulus/acquisition system. A system designed for user-interaction. With easy-to-learn menu-driven set-ups. Single keystroke standard commands. And the ability to address customized applications via co-resident programs.

Yet, for all their features, each of these instruments sells for under \$1,000; a tremendous price/performance breakthrough achieved by making these instruments peripherals to a personal computer, not stand-alone products linked to an instrument controller.

## *aSOURCE*

NWIS's aSource converts the Apple II or IIE into a fully programmable arbitrary waveform generator.

Its unique Waveform Editor™



and some other things as well.

Placement of certain options on menu screens is another source of confusion. To access document directories, you select Index on the main For:Word menu. But documents are placed in and retrieved from archives and libraries by selecting Filing on the main menu. Thus to retrieve a document from an archive you must look it up using Index, use the Cancel key twice to return to the main menu, and enter two levels of menu before you can use the name you remember from Index in order to retrieve the file. Providing an index function within the Filing menu choice would be a simple matter.

In summary, the For:Word word-processing package is a professional system that both secretarial and managerial personnel can use. The system is easy to learn, designed with users in mind, and very flexible. While the package is not complicated, its flexibility is a drawback in certain situations, as is the lack of advanced person-computer design features. Because For:Word emulates the Wang system, the most widely used word processor in the U.S., these criticisms actually apply to that as well.

For:Word has a number of bugs, and Fortune has assured me that a future version of the software will address them. Fortunately, none of these bugs stands in the way of the word processor's usefulness. Until the bugs are out, however, a list would help users to circumvent the worst of these problems. Because Fortune communicates with its customers only through its dealers, the company


misses useful feedback from the field and users miss many of the company's tips and cautions.

### Applications Software

Other software, available now or in the near future, includes a complete Business Accounting System with related applications such as order processing and inventory control along with a coordinated business graphics package, Multiplan spreadsheet software, Pascal, FORTRAN-77, two types of COBOL (one of which is a high-intermediate level), programmers' tools, Idol database-management software, Sequitur database-management software (third-party software known to work on the machine, but unsupported and without the company's blessing), general-purpose graphics, a very extended BASIC, a set of filters said to convert code written in other BASICs to the Fortune language (these include Applesoft, MBASIC, CBASIC, and TRS-80 BASIC), the C programming language, and the For:Word Plus advanced word processor.

The Fortune 32:16's operating system itself is scheduled for an update around mid-year for all users. Selected users have access to an interim upgrade of the operating system. The new version, in combination with replacing some ICs on the disk controller board and the upgrade to For:Word Plus, will make the system much quicker, I'm told. Our dealer will make each of these improvements at no additional cost. The disk-controller upgrade, on the other hand, is being done for all Fortune users. Fortune

## DSTD-764 Single Board Microprocessor System with STD Bus Expansion Capability



- \* Floppy Disk Controller — 8" and 5 1/4" SS/DD and DS/DD
- \* Winchester Host Adaptor
- DC Power Connector
- Brown Out Detection Logic
- \* Status Switch & LED's
- Baud Rate Generator
- \* RS422 Channel
- \* RS232C Channel
- \* Optional Features
  - 2-RS232C Channels
  - 2-8 Bit Parallel Ports

- Timing and Control
- DMA Controller
- Z80(A) Microprocessor
- Byte-wide Sockets
- \* Video Display Controller Port
- STD BUS Expansion
- \* STD BUS Interface Logic
- 64K Bytes DRAM with Parity

**ADDITIONAL OPTIONS**

- Expansion Card Cage
- Video Display Controller (24 x 80)
- CP/M 2.2 with enhanced BIOS

**Our Newly Packaged DSTD-764 comes complete with:**

- 1 Flat Cable — Floppy
- 1 Twisted Pair Cable — Console
- 1 Eight Inch Floppy Disk with CPM (8" Shugart SS/DD)

**For immediate off the shelf delivery contact:**

Intercomp Inc.  
Chicago, (312) 843 2040

Payment by Visa, MasterCard or COD

# \$980.00

U.S.

**dy-4 SYSTEMS INC.**

888 Lady Ellen Place  
Ottawa, Ontario, Canada  
K1Z 3M1  
(613) 728-3711





Inter-Department Memo  
 Re: Quadram's Quadchrome Color monitor

Dear Larry,

**Fantastic!** That's the way we feel about Quadchrome, it's the **best** color monitor we've ever seen...perfect for all our graphic needs. But that's not all. Quadchrome's high resolution makes it **ideal** for word processing, too. Quadchrome does it all. Quadchrome by Quadram is simply wonderful.

Best Regards,

John

QUADRAM

# QUADCHROME™ BY QUADRAM™

## THE QUALITY SPEAKS FOR ITSELF

Quadchrome by Quadram is the first and only monitor your IBM PC may ever need. No matter what you may be doing now or years from now. Color graphics. Business applications. Word processing. Quadchrome does it *all*. And does it perfectly.



### Brilliantly Designed for Brilliant Color

Quadchrome is an RGB color monitor designed to deliver up to 690 by 480 resolution, with 80 characters by 25 lines. That's high resolution for a high quality screen image. But what Quadchrome really delivers is color. Up to 16 different colors at once. Bold, brilliant color. Just what you need to add that extra flair to all your graphic work. To add that extra punch at your next business presentation.

### A Quality Word Processing Monitor, Too

But Quadchrome is more than just a great color monitor. *Much* more. Quadchrome's resolution is so

sharp, so clear, it's perfect for all your business needs. Word processing. Accounting. You name it. And Quadchrome is both FCC and UL approved.

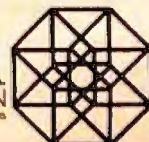
So get the monitor that's all monitors. The quality speaks for itself.

Available at retail stores worldwide.



**Quadchrome,  
 All The Monitor  
 You'll Ever Need.**

**QUADRAM**  
 CORPORATION  
 A Division of Intelligent Systems



4357 Park Drive / Norcross, Ga. 30093 / (404) 923-8686  
 TWX 810-766-4915 (QUADRAM NCRS)

Circle 508 on Inquiry card.



has recommended that the dealers upgrade the operating system for only those customers who "need" it now. I suspect this policy will return to haunt both the dealers and Fortune, if only in the short run. Supporting one version of mass-distributed software is difficult enough, but it will be a nightmare to support two versions until the second and universal release is made.

Fortune would do well to consider providing a software-maintenance service that automatically updates subscribers' software twice a year, supplies revisions to manuals (and any new manuals that are published for the customers' licensed software), and offers hints and tips to the users. Digital Equipment Corporation has done just that very successfully, after a slow and awkwardly administered start. Such a service would keep all users at the same revision level, reduce bugs in the field, keep the customers happy, and enhance the company's image.

### Performance

If you're accustomed to 64K-byte dual-floppy-disk-based CP/M (or similar) systems, you'll be appalled at the amount of disk and memory resources Unix systems use. Note, however, that combined program and data memory sizes totaling as much as 880K bytes may be selected on the Fortune system. The user environment, whether it's within the excellent Fortune-supplied menu-driven shell or within the more standard Bourne shell, is much more flexible than CP/M's command processor, and the operating system services are light-years ahead of

CP/M's. I will describe some of these advantages in detail below. It's important to keep in mind that the Fortune has a multiuser, multitasking operating system; each user (up to a practical maximum of 12) can run multiple processes simultaneously.

A system on the order of the 64K-byte one described above is the practical minimum for multiuser business applications. In addition to the components described, the system must have terminals and a printer. We use three Fortune Intelligent Workstations along with an NEC (Nippon Electric Company) 7725 letter-quality (55 characters per second) printer. That leaves one serial port available on this configuration for telephone or modem access. Our system is used for two widely disparate types of work; our analysts spend most of their time using For:Word, while the programmers spend most of their time editing, compiling, and testing programs written in one of several languages.

Under most circumstances, the system performs at an acceptable level. Things tend to slow down quite a bit when several users are in For:Word (a lot of "character banging" goes on in this program; for each character typed, about 20 are sent from the computer to the terminal) or when they try to access the disk at the same time or during the execution of a program compilation. System response should improve when a four-port, microprocessor-controlled serial interface replaces the "dumb" unit we are now using. Another 256K bytes of memory should also make things better. Fortune notes that the universal release of an operating-system upgrade (version 2.0) at mid-year will also improve performance.

A word about response degradation is in order. All disk-based multitasking timesharing systems have the same weakness: the average access time for a disk is thousands of times slower than it is for semiconductor memory. Small-business systems usually have relatively limited amounts of memory, compared to the amount that current system and users' tasks and data require.

System tasks called daemons (British for demons) are called from the disk and executed periodically to do housekeeping chores. The process of moving inactive tasks to the disk or making room in memory for large tasks whose turn it is to run is called *swapping*. The disk is used to minimize the amount of semiconductor memory the system requires and achieves an acceptable compromise between service and cost. The swapping overhead of a system, if excessive, can cause response to become very slow, even though the processor may be idle most of the time.

Generally, delays are particularly noticeable in time-sharing systems when the same hard-disk drive is used for systems software, swapping, and user directories. Delays are aggravated by low-performance disk hardware (such as floppy disks, whose average access time is in the 250 to 500 milliseconds range) and by stepper-motor head-positioners on hard-disk drives (about 75 ms). There is a consensus in the Unix community about the performance improvements to be gained from high-speed disks (about 35 ms average access time), optimal placement of direc-

## PROGRAMMERS FLIGHT SIMULATOR Apple II Plus DOS 3.3 48K



This total IFR System disk features gobs of menu selectable flight programs each with breath taking realistic picture graphics, moving scenery, airport approaches, holding patterns and much much more.

\$50.00 At your Computer Store or direct from  
Visa Mastercard

Programmers Software  
2110 N. 2nd Street  
Cabot, Arkansas 72023  
(501) 843-2988



# JOIN OUR REVOLUTION

# DISC LESS

The Disc-less revolution can make speed, flexibility and productivity an off-the-shelf reality for you, today.

The IEEE Disc-Less System eliminates systems dependence on floppy discs. In the most hostile industrial environments the IEEE 8/16 bit Disc-less system makes Data Acquisition, Process Control, Energy Management and other real time applications easy, low-cost tasks to accomplish.

A staff of industrial process control experts are ready to assist in your applications.

Here are just a few of the "real world" applications now being delivered.



1. Ultra-fast 8/16 bit Disc-less Cache Network: The Disc-Less Network utilizes "Ram-Disc" technology as on-line CACHE memory allowing data transfer from the 2 Mbit/sec. Baseband network directly to the Ram-Disc. The direct transfer enables continuous system operation while online or downtime loading large volumes of data. PRICE \$6995



2. The 8/16 bit Disc-less systems and popular WORD PROCESSING software in ROM provide for the fastest and most flexible system WORKSTATION available today. The Disc-less system eliminates time consuming disc accesses in that system software is available in ROM. Text editing, document recall and search and replace are accomplished in seconds. PRICE \$7995



3. The true flexibility of the Disc-less Approach is demonstrated in the user configurable 8/16 bit Disc-Less system. Sort, compile and assembly tasks are cut in half because no disc accesses are required. The Rom-Disc loads simple and complex software systems in microseconds. The actual loading of CP/M from ROM is accomplished in 1/60 sec. As a development system the Disc-Less operation increases productivity by at least 200%. PRICE \$5995



4. The integration of Disc-Less technology in the POWERFUL 8/16 BIT ZENITH Z-100 provides multi-compiler speed and compiling power at 1/23 1/2 MIN MICRO-COMPUTER PRICES. An optional 5-1/4" Bubble-Disc made the hardware competition obsolete in compiling. PRICE \$6999

FOR DEVELOPMENT, ENGINEERING, BUSINESS GRAPHICS, WORD PROCESSING YOUR DOLLAR CAN NOT BUY MORE. WE GUARANTEE IT.

## INDUSTRIAL QUALITY IEEE S-100

### SIERRA DATA SCIENCES

#### Single Board Computer SDC-100

• 4 MHz Z-80A Processor • Z-80 DART with 2 RS-232 channels • ZPIO I/O with 2 PARALLEL ports • NEC 765 floppy controller to support 4 1/2 inch or 4 5/8 inch drives • 64K byte system ram • 2732 Eprom for up to 4K user Prom • Supports Master-Slave operation • CP/M, MP/M, TurboDos compatible • IEEE 696 compatible PRICE \$650

#### Single Board Slave SDC-100S

• Z-80A 4MHz processor • Zilos DART for 2 RS-232 channels • 4 parallel ports; 2 thru connectors, 2 thru bus • 64K onboard ram • 4 2732 EPROM with EPROM programmer onboard • Software controlled RESET inhibit • CP/M, MP/M, TurboDos compatible • IEEE 696 compatible PRICE \$650

Four port RS-232 serial I/O PRICE \$270

RS-232 Multiplexer switchboard PRICE \$295

### ADVANCED DIGITAL CORPORATION

#### Super Quad Single Board Computer

• Z-80A CPU • 64K byte BANK SELECT ram with extended addressing • Double density floppy controller both 5 1/4 AND 8 INCH • 2 parallel and 2 serial ports with INTEL-LIGENT HARD DISC INTERFACE • 2 OR 4K monitor with EPROM • CP/M, MP/M, TurboDos compatible • IEEE 696 compatible PRICE \$675

#### Super Slave Single Board Computer

• Z-80A CPU • 64K OR 128K byte system ram with Parity • Interrupt controller onboard • 2 parallel and 4 serial ports • 2 OR 4K byte EPROM • Programmable baud rate generator • 1 year warranty • CP/M, MP/M, TurboDos compatible • IEEE 696 compatible PRICE \$650

#### Hard Disc Controller HDC-1001

• One slot S-100 hard disc controller • Built in data separator • Up to 5MEG/BIT sec data rate • 256 sector addressing range • CRC generation/verification on ID fields • ECC generation/correction on data fields • Automatic retries on all errors • Automatic restore and reseek on seek errors • 32 bit computer generated polynomial • Complete documentation • ONE YEAR WARRANTY • IEEE 696 compatible PRICE \$425

HDC-1001 with a 5 MEG byte hard disc \$1800.

HDC-1001 with a 20 MEG byte hard disc \$2000.

### S.D. SYSTEMS

#### SBC-300 Single Board Computer

• Z-80B CPU • Supports independently vectored interrupts, 8 maskable and 1 NON maskable • Auto start to any 16K boundary • Supports Master-Slave operation • IEEE 696 compatible • Supports full 24 bit addressing onboard and bus memory • 64K byte onboard ram. EXPANDABLE TO 128K BYTES • 2 full duplex RS-232 channels ASYNC, SYNC, HDLF • SASI interface for TAPE, DISC and OTHER DEVICES • IEEE 696 compatible PRICE \$750

#### Ram-Disc

• The Ram-Disc eliminates S-100 systems dependence on floppy drives • The Solid state Ram-Disc is compatible with operating systems disc commands • Expandable to 1 Mbyte • Enhance your systems performance by the implementation of the real time Ram-Disc • IEEE 696 compatible PRICE \$1095

#### Rom-Disc

• The Rom-Disc is the companion product to the Ram-Disc in that the Rom-Disc is a solid state program load device • The installation of operating systems, intermediate level languages, graphics drivers and applications software allow systems to load simple and complex software in micro-seconds • IEEE 696 compatible PRICE \$289

### STANDARD DATA

#### Bubble-Disc

• The Bubble-Disc is the perfect non-volatile storage device for the S-100 Disc-Less system • At 256K bytes the Bubble-Disc offers fast, PERMANENT local storage in any data processing environment • Process control, energy management, data acquisition and real time applications no longer require disc drives for local storage • Expandable to a full 1Mbyte • IEEE 696 compatible PRICE \$1775

#### Network Controller

• The 2mbit/sec. S-100 network controller is fully compatible with all the S-100 IEEE boards listed • CSMA and guaranteed message service insure accurate data transmission • Baseband/Broadband/Fiber optic compatibility make designing a LAN easy and cost effective • Full compatibility with the IBM PC, the Multibus, Apple computers and the S-100 bus provide flexibility necessary to upgrade existing and future networks to real world use • IEEE 696 compatible PRICE \$950

### SONICS MICRO SYSTEMS

A SUBSIDIARY OF



SONICS IS STANDARD

### STANDARD DATA CORP.

1500 NW 82nd ST., SUITE 508 FT. LAUDERDALE, FL 33309

1-800-327-5587

In Florida: 305-776-7177

DEALER INQUIRIES WELCOME

Se habla Español

COMPUTER:	STANDARD DATA	IBM PERSONAL COMPUTER	DEC RAINBOW 100	WANG PROFESSIONAL COMPUTER	RADIO SHACK TRS-80 MODEL 16	APPLE III
8/16 BIT CPU	8/16	8/16	8/16	8/16	8/16	8/16
RAM	64K	64K	64K	64K	64K	64K
ROM	128K	128K	128K	128K	128K	128K
8/16 BIT OPERATOR NETWORK READY	Yes	No	No	No	No	No
EXPANSION SLOTS:	Five 2-100 (IBM compatible)	Five (IBM compatible)	Two	One	One	One
I/O PORTS	4	4	4	4	4	4
PRICE	\$40 x 925	\$40 x 100 (2 colors) \$20 x 300 (4 colors)	\$50 x 240	**	\$40 x 800 (IBM compatible) NOT AVAILABLE	\$40 x 800
OPERATING SYSTEMS	CP/M 2.2 2.0 MS-DOS 2.0	CP/M-85 IBM-DOS (MS-DOS) MS-D 1.1 system	OS/2 MS-DOS	OS/2 MS-DOS	OS/2 MS-DOS	OS/2 MS-DOS

Information current as of 7/7/82.

\*External disk storage available soon

\*\*Information not available at this time.

Circle 421 on inquiry card.



tories and swap tracks (a feature said to be in Fortune's operating system version 2.0) on at least two disk drives to minimize disk arm movement, the use of overlapped disk seeks, separation of systems software from user directories, and separation of high disk-load users from low disk-load users. The use of only one hard-disk drive on a timeshared system can affect response time when relatively small memory is available. This is true for all timesharing systems, especially those that, like Unix, allow users to execute multiple tasks concurrently.

### Product Support

Fortune has a Software Service WATs telephone number for its dealers. Users report problems to the dealers, who attempt to fix them with their own resources or query the software hotline. Because both Unix and Fortune are new to most of the dealers handling the 32:16, they often have to resort to Fortune's dealer-support system.

---

## Because the Fortune 32:16 computer is directed at first-time business-computer users, dealers need to know about and be able to support the application software.

---

Our dealer, Kramer Systems International in Silver Spring, Maryland, seems to be learning to support this product fairly quickly. The company has perceived the need to provide Unix expertise and dealer support that is more comprehensive than what many microcomputer vendors offer.

Fortune offers its dealers training courses in hardware, operating-system software, and supporting the applications software. Our installation was completed relatively early in the dealer training cycle, before some of the support that's now routine became available. The Fortune 32:16's commercial success seems to be driving the dealers toward better service and, inevitably, away from a willingness to discount. Because the system is directed at the first-time business-computer user, dealers are required to know about and support the application software.

A lot of software is available now, and more is constantly becoming available. The software and manuals I've reviewed seem to be solid, flexible, and nontrivial products. The programs are well debugged at the surface level, and as a whole my impression is that this is good first-release software. Remarkably good, in fact, for an industry that routinely uses its first customers as a final test and inspection department. The software manuals are outstanding for novices, but too superficial for people who know their way around systems and software.

An effective dealer has to invest significant training in both technical and sales staffs to support the depth and range of products to be offered. A financially solid, com-

mitted, and technically qualified dealer is a valuable facet of the overall decision to use the Fortune 32:16 in a business environment. As always, it's wise to give some serious thought to the purchase contract, installation support, and maintenance before you purchase any system. Despite a marketing focus on the first-time business-user, the Fortune has (or will have) the tools to support software development on a small scale. The thought of twelve sophisticated programmers working simultaneously on a 32:16 boggles the mind, but for environments in which word processing and packaged applications constitute 80 percent of the system's use, ample resources are available. Here, too, even if you're a Unix expert, good dealer support is highly desirable (if for no other reason than as an information conduit between you and the support people at Fortune, who will not speak to you directly).

### The Unix Operating System

Unix, a multitasking operating system developed at Bell Laboratories, has been both praised and damned. Experienced users find it a superb software-development environment. Often, however, a user must navigate through a complex and branching structure to find a particular file. The Unix file structure is much like a branching tree; the top of the structure is called the *root* but is referred to as / (slash) when addressing that directory.

Like other directories, / is a file, and like all directory files it contains disk address pointers to executable binary files, binary object files (the results of the compilation process or the assembler process), data files, and other directories. The user looks at a directory listing and sees the names of these files, not the pointer value.

A typical Unix file of whatever type has an owner and a set of read/write/execute permissions for other users (naturally, nonexecutable files, such as ASCII text files, can't have an execute permission). By Unix convention, most files and all commands are styled with lowercase characters.

Unix also appears to have a perverse and pervasive unwritten rule requiring all commands be abbreviated to the point of unintelligibility. For example, to get to a file belonging to a user called "george," you use a command like this: `cd /usr/george`. The command `cd` changes your current directory to the one specified after the `cd` command—in this case, the directory `george` that is itself contained in the user directory. The first / refers to the root, where everything starts; `usr` refers to the directory in which all user directories are kept, the second / is merely a separator, and `george` is the target directory. (On the Fortune Unix system, user directories are kept in `u` instead of `usr`.)

To execute a program or command, you must first have permission. Then you only need to type the name of the pathway that leads to that program.

The file-system structure enables you to organize files by subject, project, month, or whatever is convenient. Each category name is used as a directory name. Subdivisions of the category can be used as the names for





# Now you can upgrade from 8-bit to 16-bit without creating a lot of bad memories.



Introducing Board 8/16 from Octagon.

Plug it into your S-100 bus and it's ready. Ready to come right up. Ready to execute both the Z80\* and the 8088 instruction sets. Ready to run both CP/M 86\* and CP/M 80\* software. Ready to deliver all the advantages of true 16-bit power.

Its floppy disc controller is ready to run up to four 5¼" or 8" floppies. In any combination. At the same time. And you can transfer files back and forth between them.

And when you buy either Concurrent CP/M 86\* or MP/M 86\* from Octagon, Board 8/16 is ready to run any CP/M 86\* or CP/M 80\* programs. Simultaneously.

Board 8/16 is not only ready to boot the operating system from disk, its 8K monitor also contains many useful debugging features. Memory test. Memory dump. Memory search. Plus all the disk interface software you need for almost any operating system.

Board 8/16 takes only one expansion slot—yet it takes the place of up to five boards.

So if you're ready to upgrade

to 16-bit, but you're not ready to scrap all your 8-bit software, get ready for Board 8/16. Order today.

- Dual processors: 4MHz NSC-800 (executes full Z80\* instruction set) and 8MHz 8088.
- Concurrent CP/M 86\* or MP/M 86\* from Octagon includes CP/M 80\* emulator and auto-select bios.
- Intel 8272 floppy disk controller with 24-bit DMA.
- 8K PROM monitor boots operating system.
- Two serial ports (baud rate software-selectable up to 19.2K bauds.)
- Interrupt controller with eight vectored interrupts.
- Fixed-frequency real-time clock interrupt for multi-user dispatching.
- Optional 8087 math co-processor.
- IEEE-696 S-100 compatible.

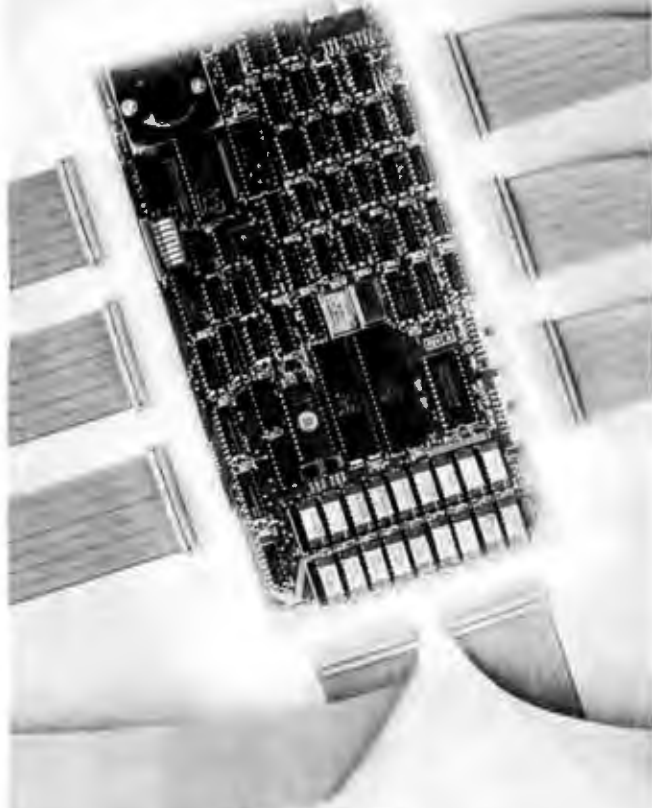
Name	_____
Address	_____
City	_____ State _____
Zip	_____ Company _____
Title	_____
Acct #	_____ Exp. _____
<input type="checkbox"/> Visa	<input type="checkbox"/> MC <input type="checkbox"/> Check enclosed
<input type="checkbox"/> Board 8/16	\$895
<input type="checkbox"/> Concurrent CP/M 86*	\$195 (Save \$155)
<input type="checkbox"/> MP/M 86*	\$495 (Save \$155)
<input type="checkbox"/> More Information	
<small>Calif. residents add 6½%. Operating systems not sold without board. *Z80 is a trademark of Zilog. CP/M 86, CP/M 80 and MP/M 86 are trademarks of Digital Research.</small>	
<small>OEM inquiries invited.</small>	



151 Bernal Avenue, Suite 5  
San Jose, CA 95119  
408/225-2700



# When one terminal is not enough



## Add a MuSYS Slave!

Expand your Z80A/S-100 based micros with MuSYS slaves and TurboDOS\*. Our NET/82 slave board has everything you need for another station: Z80A CPU, up to 128K bytes of RAM, two serial ports, a priority interrupt controller, memory parity checking, and many other features. There isn't a more cost-effective way to add complete, hardware-isolated network slaves to your system. And TurboDOS makes it even better. It's faster than CP/M®\* for systems functions, supports larger files (134 MB) and disks (1048 MB), and unlike CP/NET\* it's compatible with nearly all 2.2 applications software. Many features which are optional, extra-cost, or not available at all in CP/M are standard with TurboDOS. Call today for all the details. Generous dealer/OEM discounts available.

\*TurboDOS is a trademark of Software 2000, Inc.; CP/M and CP/NET are trademarks of Digital Research, Inc.; NET/82 is a trademark of MuSYS Corp.

**MUSYS**  
CORP.  
Specialists in Multi-user Microsystems

1752 B Langley  
Irvine, CA 92714  
(714) 862-7387  
TWX: 910-695-1967  
CABLE: MUSYSIRIN

subdirectories if you find that useful. These features are very nice, but the result is that it takes a lot of disk-head motions to accomplish a file access and execute the program. It's also very easy to forget where things are stored if you are new to Unix, the project, or have been doing other things for a while. Moreover, this structure does not promote good housekeeping habits; because all directories and subdirectories must be empty before they may be deleted, it becomes a chore to find all of your useless files and delete them, move those you want to keep, and then delete each of the subdirectories in ascending order until you are done. Because of this tedium, users need to be cajoled into releasing unneeded disk space before the disk is completely jammed with useless files. The floppy-disk drive can be used to provide a copy of files that might be useful but are not needed for current work.

Unix enables each user to execute a number of tasks—called processes—concurrently. This can be very useful; you can start compiling a program and immediately begin editing another program module. You can run a "spooler" program in *background mode* that would immediately send to another computer, via a modem attached to another terminal port, any material placed into a specific directory—just the thing for making sure that time-critical reports generated by a team of people reach their destination as soon as possible. Simultaneous printing and editing is supported, as is printer queuing.

Programs can *pipe* results to another program waiting to receive them. Thus it is possible to use several modular service programs in various combinations to create new services. One example is the program called *more*. Long directory listings can easily zip right by your eyes on a terminal operating at 9600 or 19,200 bits per second. The directory listing can be piped to *more*, which will catch the output of the listing and display it 24 lines at a time, at your command.

Yes, it would be easy to modify *ls*, the directory lister, to display 24 lines at a time, but then you'd have a program that makes assumptions about the terminal on which it is working. This is completely foreign to the Unix philosophy, which encourages portability and machine independence. Unix uses a file named *termcap* to define the individual characteristics of numerous terminals, thus making programs like *more* device independent. You can also use *more* to provide screen buffering for many other tasks—something that a custom-modified *ls* couldn't do. Such applications might include looking at a long file of data produced by a program or browsing through text files. You would use the *cat* command to catenate a file (i.e., dump it) to the default output device (i.e., the terminal), but you would pipe the result of *cat* to *more* for screen buffering. Unix contains many programs that can be used as commands or used in combinations by piping the results of one to another.

Unix has many unique and useful features. Even an experienced user of other systems will find Unix a strange and somewhat intimidating environment at first. Many of the commands have very terse and not very descriptive





## This Programming professional deserves a lot more from his personal computer.

He's earned it. As a seasoned professional, he's learned to master some of the world's most advanced programming tools. Tools specially designed to meet the everyday demands of programming experts.

But as the owner of a personal computer, he's come to expect less. Less performance. Less sophistication. And less flexibility.

### Why should programming a personal computer be any different?

Prior to the announcement of micro/SPF™ development software, experienced programmers felt programming a personal computer was a lot like playing with a toy. You couldn't take it seriously.

But today, there's micro/SPF™ a solution to elementary program editing tools now offered with most micro-computers.

With micro/SPF™ you get the same procedures and commands experienced programmers are accustomed to using at work. By mimicking features found in

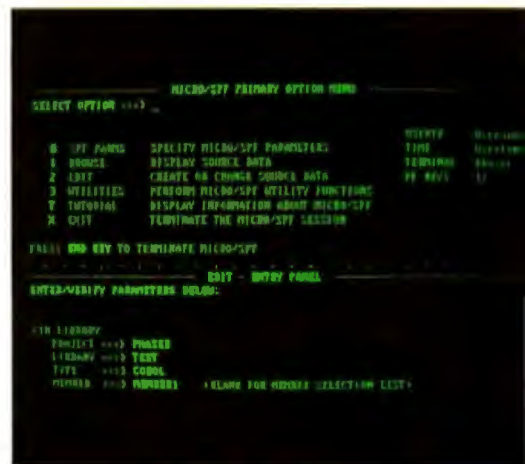
standard SPF software, micro/SPF™ provides all the sophisticated utilities programming professionals expect.

### Programming experts can take advantage of skills they've spent years perfecting.

Now, for the first time, mainframe software is available for personal computers. SPF screens are fully reproduced in logical sequence and each screen is formatted identical to those found in the SPF system.

In addition, micro/SPF™ comes equipped with the same primary and line commands, tutorial messages and program editor (with program function keys) experienced programmers are used to.

Programming professionals who've spent years perfecting the art of writing sophisticated code deserve to work with state-of-the-art tools, not toys. Find out how micro/SPF™ can help you do work-compatible programming on your personal computer today!



**PHASER**

PHASER SYSTEMS, INC. 50 WEST BROKAW ROAD  
SAN JOSE, CA 95110



## Fortune Global Menu

(Fortune Applications and Languages)

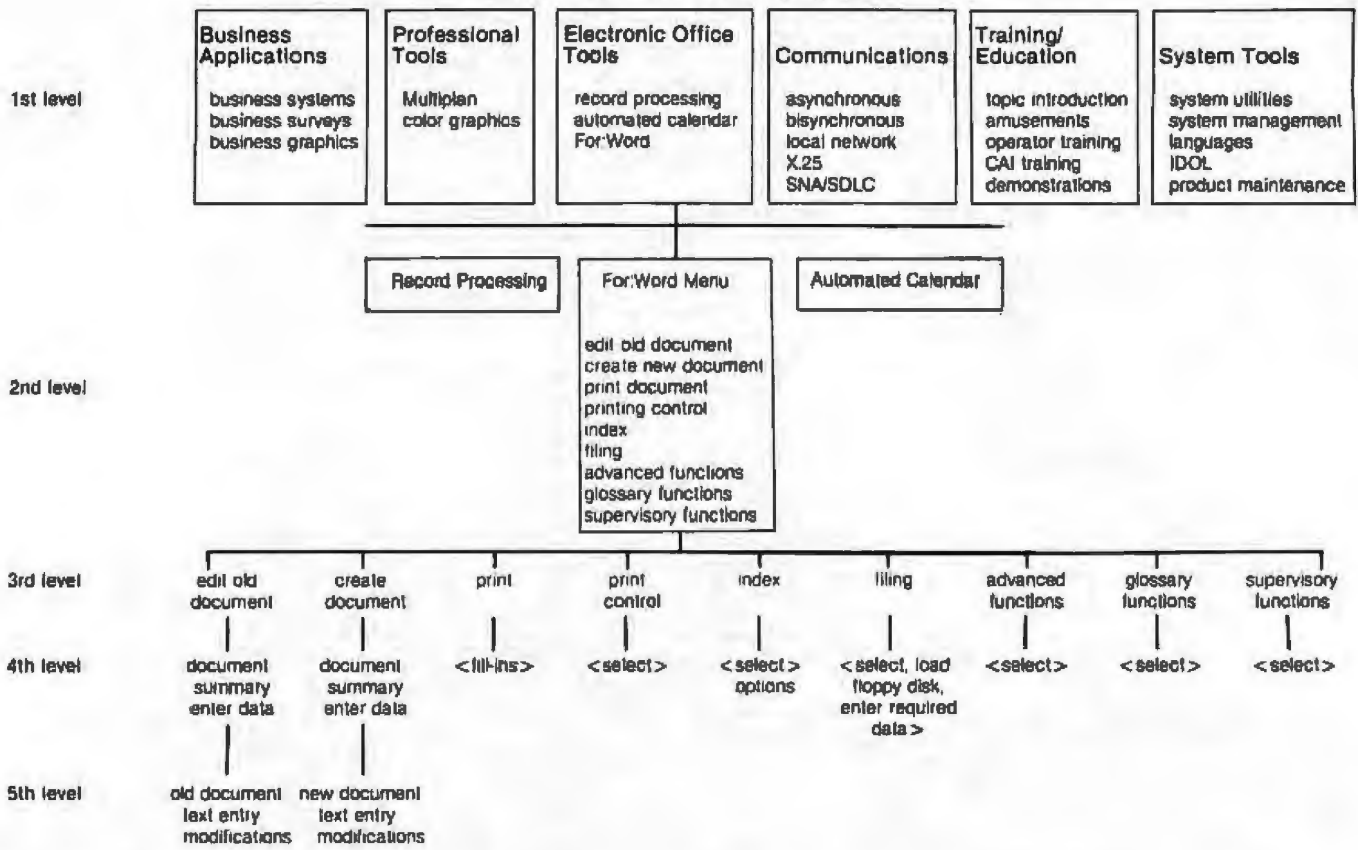


Figure 1: The Fortune Global Menu. Each of the six applications in the first level is followed by a list of available software.

names. For example, cp copies files, nroff is a text formatter, and cc calls the C compiler, while cb calls a C beautifier (a program that formats a C program for easy reading and good style). There is a very fussy syntax checker for the C language, called lint. The program as calls the assembler for the host machine, and df gives you statistics on the amount of free disk space available, but diff is used to compare the contents of files or directories. Literally hundreds of such commands are available in standard Unix when using the Bourne shell. These commands, together with an environment that makes group programming or other group efforts easy to organize and efficient to monitor, make Unix a very useful system for those who are willing to do the requisite apprenticeship.

Unfortunately (no pun intended), Fortune does not currently supply any Unix documentation with its system and supplies only a relatively minuscule amount of documentation with the C programming language package. I bought a set of manuals for \$91 from the University of California at Berkeley, whose version of Unix is the current model for the Fortune operating system. Due to the terse and sometimes irregular syntax of commands, the large number of commands, the potential for disaster if you misuse a command (Unix assumes that you know what you're doing), and the industry-wide

lack of Unix documentation for the casual user, many consider the standard shell inappropriate for the average business environment. Luck is on our side, however, because Unix has an answer.

Unix allows the use of many different shells. In fact, each user can have his own shell. The standard shell even lets you program within it to create new commands out of old ones. Thus there's a strong foundation on which you can build a shell that is more appropriate for an office environment. Fortune Systems is one of the companies that has done this.

The Fortune shell is menu-oriented. You sign on to the system by turning on your terminal and typing your name and password in response to screen prompts. If the name and password correspond to entries authorized on the system, you can progress to the Fortune Global Menu (or to the Bourne shell, if your account specifies this option). The Fortune Global Menu has six areas: business applications, professional tools, electronic office tools, communications, training/education, and system tools. Each of these areas has a list of available software.

Figure 1 and photo 4 show the global menu. Note that some entries are brighter than others. The brighter entries signify software options installed on the machine. To select an option, you can use the Return key, which will



# DOING WELL.

What does it take to move up in the world?  
CompuPro has made quite a reputation by adopting a few simple principles:

1) You've got to do a little extra — like provide more memory, run 8 and 16 bit software, use rugged all-metal enclosures, and offer all the other extras that spell performance.

2) You have to be reliable. If our products were iffy, we'd offer a 90-day warranty, like the other guys. But you get 365 days from CompuPro because we have four times the confidence.

3) You have to take on bigger challenges willingly. Even our single-user systems can expand easily to multi-user status, acquire more power, or take advantage of new technology.

4) You've got to keep the boss happy. And she'll be plenty sour if her computer has to be shipped to the factory for repairs. CompuPro offers on-site service contracts in all 50 states, plus Canada.

5) You need a wide-reaching intellect. Our systems run the vast library of more than 3,000 CP/M® programs, and meet the popular IEEE 696/5-100 hardware standard.

6) Use a CompuPro. (We do.)

Call (415) 562-0636 for the location of your nearest  
Full Service CompuPro System Center.

**CompuPro**

CompuPro, a Godbout company, Box 2355, Oakland Airport, CA 94614  
Circle 498 on Inquiry card.





(4a)



(4b)



(4c)

Photo 4: Global system menus and submenus. The global menu (4a) is the root for all access to the Fortune's operating system; also shown are the system utilities menu (4b) and the system management menu (4c).

move the cursor through the menu selections sequentially, use the cursor keys to select the application, or type the entry number of the desired option (e.g., e1, or E1 for For:Word), followed by pressing the Execute key.

The options within each application are also menu-oriented. Thus it is possible to get three or four menus deep into an application before you can execute a function. This procedure treats the new or infrequent user very gently, but it can be tedious for users who are familiar with their applications.

Menus are also a very slow way to use computer systems. Fortune has provided mechanisms that alleviate some of these lengthy navigations of the system menus, but these commands do not yield complete access to all options. For example, you can go to any previously created document from the Document Index display

without climbing and descending a set of menus. Although it is slow and occasionally confusing, the Fortune menu shell and the menu approach to applications are generally very well thought out. Few areas have been neglected, and those are sufficiently technical in nature that the user might well use the standard Unix shell for them.

You can access the Bourne shell whenever you are being asked for a Global Menu choice by typing an exclamation point followed by the desired Unix command. The command is executed and you are returned to the menu shell at its completion.

### Summary

The Fortune 32:16 computer offers an outstanding business-operating environment with a reasonably good technical development environment. The system is well designed and easy to use. Dealer support is advised if you're not expert at fending for yourself in complex systems environments. The Fortune operating environment does not encourage tinkering with the inner workings of the operating system, but if you're technically inclined you'll have a good time with the system.

The major marketing consideration that distinguishes this system from the large number of similar systems on the market is its optional gentle user interface and the wide range of very high quality application software available now or planned for the near future.

Some systems are better adapted to highly technical environments, to the use of industry-standard interface cards (e.g., STD bus or Multibus), and to real-time applications. Fortune Systems has, however, created one of the better systems currently available for business use and for technical efforts that do not require all of the nitty-gritty of standard Unix, the pleasures of the Programmers' and Writers' Workbench modifications to Unix, or the flexibility of systems designed for laboratory environments. Given the technical orientation of the bulk of offerings in the Unix marketplace today, Fortune Systems has chosen the harder row to hoe and has done it very well. ■



# THE NEW DAS SERIES 500 FOR THE IBM PC:



## THE DATA ACQUISITION & CONTROL SYSTEM YOU SHOULD CONSIDER OVER A MINI. EVEN IF MONEY IS NO OBJECT.

Let's say you have enough money to buy nearly any data acquisition and control system you might want. What will you choose?

If sheer power is your main requirement, you might choose an expensive minicomputer system. But, then again, you might just as well choose the new DAS Series 500.

Simply plug the Series 500 into any off-the-shelf IBM Personal Computer and you'll have up to 336 channels of analog input, 60 channels of analog output and 192 channels of digital I/O (even AC/DC device control). And with measurement speeds as high as 25,000 analog data points per second, and true 12 or 14 bit precision, you'll have enough power and accuracy for the most demanding applications.

If you need flexibility, you'll want to compare other, more costly systems to the fully modular Series 500. It comes supported by an extensive library of integrated plug-in modules that let you custom tailor almost any

combination of inputs and outputs, digital or analog. And do so almost instantly.

So the Series 500 is ideal for hundreds of applications in product test, process control and energy management; in psychology, biology, analytical chemistry and neuroscience.

If ease of use is high on your list, consider this: Only the Series 500 comes equipped with the advanced, integrated Soft500 software package. With it, you can set up, collect, store, control, display and analyze, all with a few simple BASIC commands.

In fact, Soft500 makes programming so easy, you can be up and running with your Series 500 the same day you get it. Even if you're not a computer expert.

Now compare advanced features. Like exclusive foreground/background software architecture that lets you analyze data while you collect it. Like the real-time clock/calendar and precision interval timer.

Or the tremendous range of signal conditioning options, including software selected gain and offset, amplification from millivolt levels, and provision for direct connection of thermocouples, strain gauges and RTDs.

These are features you might not get elsewhere, no matter how much money you spend. But then, why spend all that money?

Because for less than \$6000 you get both the advanced capabilities of the DAS Series 500, plus an IBM PC<sup>®</sup> (which incidentally, you can still use to do all the other things a PC does so well).

For complete information on the DAS Series 500 data acquisition and control system, write to us at Data Acquisition Systems, Inc., 349 Congress Street, Boston, Massachusetts 02210. Or call us at 617-423-7691.

IBM PC purchased separately. Also available for the Apple II, IBM PS/2 & Apple II are registered trademarks.





Shown are IBM-PC\* compatible programs. The Columbia MPC runs MS-DOS\* plus six other operating systems.



# THE COLUMBIA MPC WORKS WITH A WORLD OF SOFTWARE. \$3,000 WORTH COMES FREE WITH THE SYSTEM.

**World Headquarters:**  
8990 Route 108  
Columbia, MD 21045  
(301) 992-3400  
TWX 710-862-1891

**West Coast:**  
3901 MacArthur Blvd.  
Suite 211  
Newport Beach, CA 92663  
(714) 752-5245  
Telex 277778

**Europe:**  
Limitenstr. 94  
4050 Moenchengladbach 2  
West Germany  
Phone 02161-33159  
Telex 852452

**Call our distributor nearest you.**

Access Systems  
Wellesley, MA  
(617) 237-7743

Advanced Management  
Systems  
Aurora, CO  
(303) 752-2972

Central Microcomputer  
Distributors  
Montreal, Quebec, Canada  
(514) 849-7533

N.I.D.I. (National Instru-  
ment Distribution Inc.)  
Dayton, OH  
(513) 435-4503

RPC Electronics  
Cleveland, OH  
(216) 461-2280

RPC Electronics  
Pittsburgh, PA  
(412) 782-3770

Distributors in Australia, Austria, Belgium, Colombia, Denmark, Hong Kong, Israel, Italy, Malaysia, Netherlands-Antilles, Norway, Portugal, Spain, Sweden, Switzerland, United Kingdom, Venezuela.





Today, the Columbia MPC takes on hundreds of IBM-PC compatible software programs and IBM-PC add-ons or peripherals.

What's more, six other Columbia-supported operating systems are available — CP/M-80; CP/M-86; Concurrent CP/M-86; MP/M-86\* (OASIS-16\* and XENIX\* available soon) — stretching the Columbia MPC's software compatibility beyond any other personal computer.

**Farther, faster, for far less.**

The Columbia MPC is shipped with fully supported software that will save you \$3,000. Included is the entire self-teaching Perfect Software™ family: Perfect Writer,™ a word processor; Perfect Speller,™ a 50,000 word dictionary; Perfect Filer,™ a data

base manager; and Perfect Calc,™ a financial calculation system.

In addition you get MS-DOS, CP/M-86, Macro/86 Assembler, BASICA,™ Asynchronous Communications Support, Diagnostics and the Columbia Tutor program. This means your Columbia MPC is up and running right out of the box. Space Commanders and Fast Graphs show off the Columbia MPC's full-color graphics.

**Way out front in value and performance.**

With a list price of \$3,995 — including 128K RAM, 640K in dual disk drives, 8 IBM-PC compatible expansion slots, 2 serial and 1 parallel I/O, IBM-PC compatible keyboard, and color graphics monitor controller — the Columbia MPC is

ready to go. And a complete 12MB hard disk system lists for \$5,995 — software included! B/W or color monitors and printers optional.

**Made in U.S.A. — supported worldwide.**

All Columbia hardware and software are backed by the "Call for Columbia" national service program. So, call us or our distributor for the dealer nearest you — and start looking at the Columbia MPC. It'll show you a whole new world of performance and value.



Commerical Computer Sales  
Atlanta, GA  
(404) 256-9190

Empire Micro Products  
Rochester, NY  
(716) 626-3660

MP Systems  
Dallas, TX  
(214) 385-8885

Mid Tech Associates  
Desoto, KS  
(913) 441-6565

Mid Tech Associates  
Florissant, MO  
(314) 837-5200

Mytec, Inc.  
Sanford, FL  
(305) 321-2301

Renaissance Technology  
Corp.  
Concord, CA  
(415) 676-5757

Southeastern Data  
Products  
Lynchburg, VA  
(804) 237-6286

Tek-Aids Industries  
Arlington Heights, IL  
(312) 870-7401

Tele-Terminals  
Brooklyn Park, MN  
(612) 328-3072

Waybern Corporation  
Garden Grove, CA  
(714) 554-4520

Perfect Software, Perfect Writer, Perfect Speller, Perfect Filer, and Perfect Calc are trademarks of Perfect Software, Inc. IBM is a trademark of International Business Machines. CP/M and MP/M are registered trademarks of Digital Research, Inc. OASIS is a trademark of Phase One. MS-DOS and XENIX are trademarks of MICROSOFT.

Circle 101 on inquiry card.



# The Movable Conference

*A report on a revolutionary new communications medium:  
computer-moderated conferencing.*

During the eighteenth Egyptian dynasty, about 3500 years ago, a royal scribe named Amenophis, son of Hapu, rose to great prominence. He was such an accomplished communicator that the pharaoh appointed him both hereditary prince and master of ceremonies of the feast of Amun, a position rivaling that of the high priests of Karnak, the great temple city of upper Egypt.

Since that time, the princes of communication have always aspired to power but have rarely achieved the deified status of Hapu's remarkable son. In 1970, however, an experiment in information science started a movement that, as this decade matures, will extend and transform this most fundamental of human activities and may confer unprecedented power on a new generation of electronic messengers.

Consider the ways we usually communicate (talking, writing, and gesturing) and how we enhance that communication (telephone, gatherings, print, video, signs, radio, etc.). Such exchanges are limited by the environment, by the need for synchrony in time and place for dialog to occur.

The most desirable form of com-

---

## About the Author

*Irving A. Lerch, a professor of medical physics at the New York University School of Medicine has published numerous articles on the impact of science and technology on society.*

---

---

Irving A. Lerch  
New York University Medical Center  
Division of Radiation Oncology  
566 First Ave.  
New York, NY 10016

---

munication is the face-to-face meeting. But face-to-face meetings are unstructured, weighed down with social conventions based on rank, subject to misunderstandings, and vulnerable to information loss. If needed data is not immediately available during the meeting, many decisions will be delayed until some time after the conclusion of the conference. Meeting planners must have exquisite foresight if everything is to run smoothly. If numerous participants are located in different cities, the travel and accommodation costs can be excessive and the meeting cut short, often before anything useful is accomplished. With the computer as communications device, however, the bonds of synchrony can be cut. A conference can now "move" in terms of both time and place to each participant of that conference.

Indeed, the most apparent difference between computer-moderated conferences and face-to-face meetings is in the temporal relationship of the exchanges. In a computer conference, messages are forwarded in time until a participant reads them and replies. Participants may review the proceedings, respond to specific messages, enter new information, ask questions of any participant, or acquire data at any time, day or night. And because

each participant needs only a normal telephone line or leased communications line to connect a terminal to a central host computer, the interchange is independent of place as well as time.

In addition, because the computer maintains an accessible record of all transactions, memoranda and synopses are unnecessary; the final documentation can simply be edited from the computer memory. Add a feature for privacy to protect proprietary exchanges, and the system begins to develop a useful shape.

To a limited degree, we already have a measure of this power. The telephone enables us to contact people anywhere, at almost any time, and to carry on group conversations. We can even use the telephone to transmit printed and graphic information. But such teleconferencing must be conducted in the heat of the here and now, and the spoken word is fragile and notoriously elusive. What is obvious to one participant may be opaque to another. Some people may require more time to digest a certain piece of information. Much information is invariably lost.

Thus the conventional ways we exchange information are somewhat limited. But all of this is about to change in a way so fundamental, so profound, that the processes of collating and synthesizing information will cease to exist as separate activities divorced from communication.



# Keep Your Computer Healthy...

with the Industry Standard in System Maintenance Programs.



## Diagnostics II

Diagnostics II is the finest set of system maintenance routines available for microcomputers. It thoroughly checks all five areas of your computer system, pinpointing hardware problems to help keep your computer in perfect working order.

The areas of your computer which are tested include:  
Memory, Printer, Terminal, Disk, and CPU

In addition to being extremely thorough, every test in Diagnostics II is also "submit"-able. The output of the tests can be logged to disk for later review.

(Requires 32K CP/M\*)

Diagnostics II: \$125

Manual only: \$ 40

## Disk Doctor

Disk Doctor automatically recovers otherwise unrecoverable information from "crashed" diskettes. It also un-erases files.

Maybe it was a lightning storm, static from the rug, or just too late at night to be working. Whatever the cause, when the diskette "crashes" or a file is accidentally erased, valuable data or programs can be permanently lost.

Disk Doctor was designed to recover this "lost" information. It consists of five wards, each performing a specific recovery operation.

- Ward A: Verifies diskettes and locks out bad sectors
- Ward B: Places copyable information from a "crashed" file in a good file.
- Ward C: Copies diskettes without stopping for bad sectors.
- Ward D: Un-erases files.
- Ward E: Displays a directory of recoverable erased files

Disk Doctor was not designed for use with double sided or hard disks.

Circle 436 on inquiry card.

(Requires 48K CP/M\*, two drives for complete operation)

Disk Doctor: \$100

Manual only: \$ 30

Available from fine dealers everywhere, or directly from SuperSoft.

*Japanese Distribution:*

ASR Corporation International  
3-23-8, Nishi-Shimbashi, Minato-Ku  
Tokyo 105, Japan  
Tel. (03) 437-5371, Telex 0242-2723

*European Agent:*

Micro Technology Ltd.  
51 The Pantiles,  
Tunbridge Wells, Kent, England TN2 5TH  
Tel. 0892-45433 Telex: 95441 Micro-G

Diagnostics II available for virtually all CP/M\*, CP/M-86\*, and MS DOS compatible systems.

Disk Doctor available for virtually all CP/M\*, and CP/M-86\* compatible systems.

CP/M\* and CP/M-86\* are registered trademarks of Digital Research.

# SuperSoft®

FIRST IN SOFTWARE TECHNOLOGY P.O.Box 1628 Champaign, IL 61820 (217) 359-2112 Telex 270365



## EMISARI

In 1970, the White House Office of Emergency Preparedness (OEP) was given the responsibility of administering President Nixon's wage-price freeze. To accomplish this difficult task, the OEP put into use the first electronic conferencing system, the Emergency Management Information System and Reference Index (EMISARI). The following quote from *The Network Nation* by Starr Roxanne Hiltz and Murray Turoff

(Addison-Wesley Publishing Company, 1978) describes how EMISARI supervised information flow:

*The ten regional offices of OEP needed to be able to generate and share timely and useful data on . . . the wage-price freeze. The regional offices had to respond to requests and inquiries from the public in a way that was consistent with the initial guidelines and emerging modifications and inter-*

*pretations. The central OEP management had to make sure that policy interpretation was consistent from region to region. . . .*

*The primary innovation in EMISARI was the ability to set up alternative communication forms, such as collections of numeric estimates, tables of numbers, and situation report forms, and have these assigned as a permanent responsibility to some member of the communication group who would supply the information on a regular basis. . . . All this was under the control of a human monitor who could tailor the communication structure and the responsibilities as a function of the problem at any time.*

As you might imagine, the advent of this unique, computer-moderated conferencing system was accompanied by a great deal of discord between the OEP establishment and the outsiders who invented EMISARI. The story of this conflict, recounted by Hiltz and Turoff (one of the designers of EMISARI) in their book, illustrates the friction generated when control over information changes hands. In spite of this difficulty, however, the concept of computer-moderated conferencing has been employed in a number of communications systems.

### From New Guinea to the Electronic Cottage

A few years ago, the multinational Bechtel Corporation approached its telecommunications group with a problem: how could a team of employees scattered across several time zones and continents maintain effective communications? The great geographical dispersion made it clear that only a messaging service would work, yet the traditional methods were inadequate to sustain technical dialog among the 10 to 12 people in a team. Bechtel solved the problem by subscribing to Infomedia's Notepad system, developed by one of the premier innovators in the field, Jacques Vallee.

An early Bechtel project using Notepad was centered at a Nevada molybdenum mine with no telephone access. In order for the site manager

# Excellence Acknowledged.



#### Some people demand the best.

Superior quality at superior value identifies the "best" products, and the best in Apple II<sup>®</sup>-compatible drives is the Micro-Sci line of 5 1/4" floppy disk drives and subsystems.

Business people needing storage, reliability and fast access have been impressed with Micro-Sci's A40 system since we introduced it back in 1979. For a lower list price than the Apple Disk II<sup>™</sup>'s, the A40 offers 20Kb more capacity, faster access time and greater data reliability.

The Micro-Sci A70 drive combines quick access and high reliability with a full 286Kb storage capability.

The newest member of Micro-Sci's Apple II-compatible family, the A2, is a direct replacement for the Disk II,

featuring total compatibility at a lower cost. Better still, you can mix our A2 drive and controller with their drive and controller for complete freedom of interchangeability.

And Micro-Sci's controller includes operating features like jumper-selectable 3.2 and 3.3 DOS.

#### Give yourself the privilege.

Micro-Sci delivers the most in quality, reliability and performance. So when you consider additional drives or a disk subsystem for your Apple II, indulge yourself in the Micro-Sci alternative.

See our complete product line today at a dealer near you.

**(SPECIAL NOTE TO APPLE III<sup>®</sup> USERS: Micro-Sci also offers a full range of Apple III-compatible drives. Ask your local dealer for details.)**

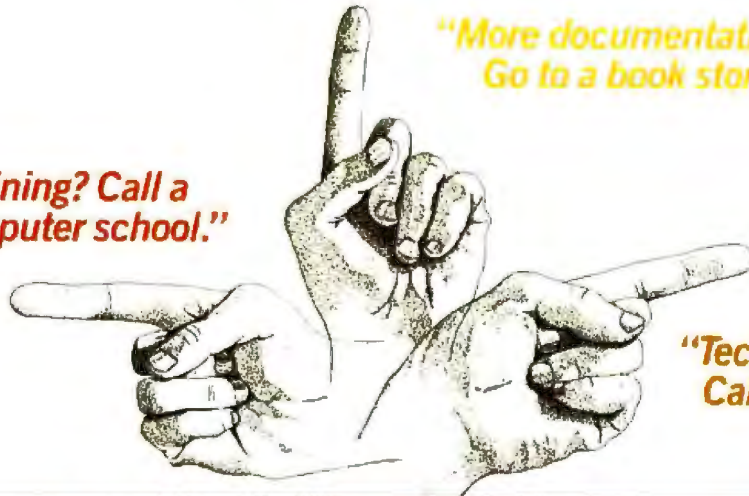
**μ-SCI**  
**MICRO-SCI**

Micro-Sci is a Division of Standun Controls, Inc.  
2158 SOUTH HATHAWAY STREET • SANTA ANA, CALIFORNIA 92705 • 714/662-2801 • TELEX: 910-346-6738  
International Dealer Inquiries... IMC International Markets Corp. Telephone 714/730-0963 • Telex: 277782-ROBY UR

\* Apple, Apple II, Apple III and Disk II are registered trademarks of Apple Computer, Inc.



**"Training? Call a computer school."**



**"More documentation? Go to a book store."**

**"Technical support? Call the publisher."**

## **Interested in dBASE II™ or 1-2-3™? Beware The Dreaded Finger Pointers!**

Sound familiar? Does your dealer turn into a "finger pointer" when you need help?

At SoftwareBanc we offer a complete system that doesn't stop when your software is delivered.

### **Careful Product Selection**

Do you get bewildered by the endless lists of software you find in most ads? Let us be your quality control department.

We only sell the best programs on the market. After a thorough evaluation we chose dBASE II™ for data processing, and 1-2-3™ for financial management.

Our complete line of add-on products help you to continue to get the most from your software.

### **Expert Technical Support**

When you buy software from us, you can rest assured that help is only a phone call away. Just call us at (617) 641-1235 for all the free support you need.

### **Free dBASE II™ User's Guide**

We don't send you somewhere else to learn more about a product we sell. Order dBASE II™ from us, and you'll receive a free copy of our dBASE II™ User's Guide. You can also buy the User's Guide first for only \$29, and then receive a full credit when you buy dBASE II.™

### **Free 1-2-3™ Utility**

Receive 1-2-3 TRANS free with your purchase of 1-2-3.™ 1-2-3 TRANS is a menu driven program that will quickly and easily transfer files from dBASE II™ to 1-2-3™ and back again.

### **1-2-3™ & dBASE II™ Classes**

Want more in-depth information about dBASE II™ or 1-2-3™? Attend a SoftwareBanc seminar near you. Each session runs from 9 to 5, and costs \$175.

**Los Angeles**  
July 18-22  
**Washington, D.C.**  
Aug. 29-Sept. 2

**Anchorage**  
August  
**New York City**  
September

### **Prices You Can Afford**

1-2-3™	.....Call for price*
dBASE II™	.....\$479
ABSTAT	.....\$379
dBASE II™ User's Guide	.....\$29
DBPlus™	.....\$95
dGRAPH	.....\$199
dUTIL	.....\$69
dNAMES	.....\$109
QUICKCODE	.....\$199

\*Only available for IBM PC with MS-DOS.

### **Free Catalog**

If you want to learn more about SoftwareBanc, call or write for our free product catalog.

### **SoftwareBanc**

661 Massachusetts Avenue  
Arlington, Mass. 02174

To order call: (800) 451-2502  
(617) 641-1241 in Mass.

For technical support call:  
(617) 641-1235

1-2-3 is a registered trademark of Lotus Development Corporation/dBASE II is a registered trademark of Ashton-Tate, Inc.

Payment may be made by: MasterCard, Visa, check, C.O.D., money order. Mass. residents please add 5% sales tax. Add \$5.00 for shipping and handling.





to communicate with a central office in San Francisco, he was given a portable terminal. Each evening he jumped into his jeep, drove to the nearest town, and telephoned Informedia's computer in San Bruno, California, to receive updates on engineering and management messages and details concerning orders and shipments. The system was also successful in managing gold and silver mines in Idaho and Canada and in supporting a nine-month project in

the Beluga oil fields in Alaska.

The most spectacular Bechtel conferencing project involves a mining operation in Ok Tedi, a remote province 400 miles from the coast in Papua New Guinea. Altogether, several teams had to be coordinated between New Guinea, Australia, and a central office in Los Angeles.

Ironically, Bechtel does not use conferencing for its internal corporate communications. As is true for many organizations, messaging is accom-

plished by using switching networks, electronic mail, and similar systems. This may change as computer conferencing is exploited to relieve working groups of the need for extensive travel and real-time discussions.

Two other computer-moderated conferencing systems, Confer and EIES (Electronic Information Exchange System), serve the needs of specialized study groups and business clients who "meet" online to develop documentation, examine specific problems, exchange data, and communicate with allied organizations. The Army's Delta Force, a network of consultants and Department of Defense specialists, uses Confer to examine future needs and organizational requirements. (See "Electronic Publishing" by Arthur Bechhoefer, page 124, for an account of another interesting application of Confer.)

EIES has been the site of professional-society committee deliberations such as those of the Instrument Society of America. Also, 10 hepatitis experts used EIES to organize a new database, the Hepatitis Knowledge Base, for the American Library of Medicine. The Hepatitis Knowledge Base is now available for downloading into physicians' microcomputers. In addition, Starr Roxanne Hiltz, coauthor of *The Network Nation* and sociologist studying acceptance of the new telecommunications technologies, has employed EIES to present online courses such as Telecommunications in the Future.

In 1978, a conference was organized on EIES, called Politechs, that included federal laboratories, state legislatures, local governments, public-interest groups, technical professional societies, and the White House. The conference was dedicated to promoting exchanges on the impact of science and technology on public policy. As a result of this conference, proposals have been made that aim at developing permanent interchanges for various departments of the federal government.

After the Three Mile Island incident in 1979, the nuclear industry responded by founding an Institute of Nuclear Power Operators that uses Notepad to tie together each utility

## VistaDaVinci GREAT INNOVATORS



15th century renaissance man, Leonardo Da Vinci, contributed an inexhaustible collection of inventions and ideas to solve the world's problems. These ideas were centuries ahead of their time. The studies on this page deal with experiments in optics.

Like Leonardo, Vista Computer is answering many of today's complex computer storage problems. The Vista V1200 is a great solution to IBMPC storage. Mass storage for your IBMPC Computer has always been a problem. On one hand, there were the exotic, expensive hard disks with no cost efficient means of backup. On the other hand, the IBMPC floppy drive lacked the speed and storage demanded by today's professionals.

Vista's V1200 offers both at an incredibly attractive price. The removable VistaPak cartridges offer 6 Megabytes of removable storage each and can be backed up like a floppy.

Now hard disk storage can be yours with the added capability of interchangeable media. The V1200 eliminates the worries

of head crashes, drive alignments, lost data, or backup with a new application of field-proven floppy technology.

The VistaPak cartridges hold 6MB of formatted data each. The removable cartridge allows you to keep duplicates of your valuable data as well as to keep separate packs for your accounting, word processing, spreadsheet and other applications. No other storage device offers more in flexibility and capability.

- Microprocessor controlled, self-formatting drive • DMA Controller • Removable Data Cartridges • Includes VistaPak cartridge • Vista 120 Day Warranty • MS-DOS compatible • Controller accommodates V1200 as well as your 5.25" and 8MB 5.25" Drives.

Contact Your Local Vista Dealer or Call our Vista Hotline.

**Vista** COMPUTER COMPANY, INC.

1317 East Edinger / Santa Ana, CA 92705  
(714) 953-0525 / (800) 854-8012

#### Distributors

California: Santa III Technology (714) 957-7644 / 1488 17101 St  
Texas: R. J. Systems (214) 354-0805  
Florida: Digital, Inc. (407) 345-3300  
Illinois: Computer & Electronics (312) 570-8800  
Iowa: Lakeside Technology Plus (319) 988-4111

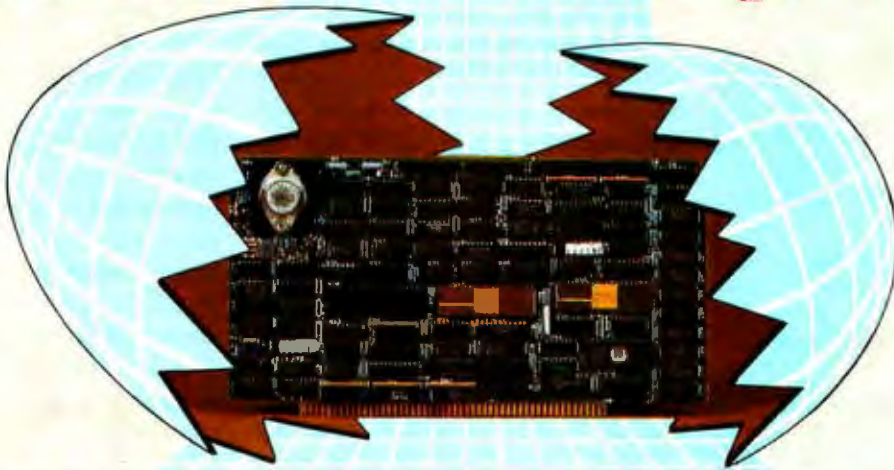


Vista V1200

TM Apple II is a registered trademark of Apple Computer, Inc.



# Incubation Complete



## A Third Generation is Born

### SBC 300

(Pictured above)

A Z80 based microcomputer board with memory and I/O functions

- Fully complies with IEEE 696 Standard
- 4/6/8 MHz Z80 A/B/H\*
- Supports CP/M® Plus
- Operates as bus master/slave for multi-user, multi-processor architecture.
- 64K on board memory, dual ported, parity checked
- 2 serial ports, 1 full SASi port
- All I/O drivers on board
- Memory management
- Full 24 bit address capability
- 3-16 bit CTC's



### ExpandoRAM IV—Random access memory board utilizing 64K or 256K NMOS RAM chips

- Fully complies with IEEE 696 Standard
- 256K capacity with 64K chips
- 1024K capacity with 256K chips
- Error checking and correction (2 bit detection, 1 bit correction)
- On board refresh
- Supports both 8 and 16 bit data transfers
- 24 bit addressing



### SD300—A new series of compact yet expandable S-100 microcomputers.

- Compact size approximately 4" x 14" x 17"
- 6 Slot motherboard
- Rugged metal enclosure
- Supports up to 5 users

**OEM Version:** Designed for ease of integration and maximum flexibility

- Z80 CPU
- 256K RAM
- Versafloppy II with free CP/M Plus™

**Diskless Version:** An ideal high performance system for disk intensive applications. Eliminates disk wait states for spread sheets, spelling checkers, and network operation. Utilizes SD Systems RAM Disk and ROM Disk modules.

### VFW-3: A single board controller for floppy and Winchester disk drives:

- Fully complies with IEEE 696 Standard • Free copy of CP/M Plus™ included • Up to 4 floppies and three Winchester drives may be controlled by VFW-3 • Data transfers to and from board under DMA or programmed I/O control • Supports 24 bit address space.

### CP/M Plus™, high performance single user operating system.

- CP/M® 2.2, compatible—no modification! • When used with SDSystems 256K memory board speeds are up to 7 times faster than CP/M® 2.2. • High performance file system • MP/M® II file password protection • Time and date stamps on files • Support for 1 to 16 banks of RAM • Support for 1 to 16 drives of up to 512 MB each • Easy to use system utilities with HELP facility • Powerful batch facility • Sophisticated programmer utilities.

### RAM Disk 256: A solid state disk emulator that greatly increases system performance by eliminating disk waits in disk intensive applications. Excellent for spreadsheets, spelling checkers and software development.

- 256K capacity • 1 mb total bus capacity • CP/M® 2.2, PLUS™ compatible • I/O port addresses user selectable • Storage locations addressed by on board 20 bit counter • On board refresh.

### ROM Disk 128: An EPROM board that replaces a floppy disk drive for the purposes of booting CP/M and loading application programs.

- Provides non volatile, permanent storage of programs and data • Utilizes 2732 or 2764 EPROMS, (16 max) • 128K capacity per board • 512K system capacity • Use with SDSystems RAM disk to configure a stand alone or network diskless system • CP/M Plus™ available in eproms • Serial port provided.

CP/M® 2.2 and CP/M Plus™ are registered trademarks of Digital Research, Inc. \*Z80 product of Zilog Corp

# SDSYSTEMS

A Syntech Company

10111 Miller Road • Dallas, Texas • (214) 340-0303 • TLX-682 9016

Circle 407 on inquiry card.



### **Communitree: A Microcomputer-Based Conferencing System**

*An organization in San Francisco called the Communitree Group has developed a computer conferencing system for the Apple II. Designed as an alternative to the many computer bulletin boards around the nation, this system provides a relatively simple messaging structure capable of supporting complex branching communications—hence the name Communitree. In operation, you simply dial the system as you would any other bulletin board. You then obtain a list of parent conferences that can be accessed with a simple READ command. If the selected conference contains a subconference structure, the titles of the branch conferences will be displayed. You may browse as with more elaborate systems and enter messages with a simple line editor. Only the system operator has the power to delete or shift messages. Help files assist novices in learning the system's features.*

*This design is similar to The Source's Participate in that it provides a message-branching structure. Communitree is much more primitive, however, because machine limitations restrict the resources available to users, but the system's simplicity makes it easy to learn and very suitable for restricted applications.*

*To run the conferencing software, you must have an Apple II with 48K bytes of RAM (random-access read/write memory) and two disk drives. This will support a maximum of 320 fifty-line messages. The system deletes notes that are not current, and it can easily handle up to 35 users per day if it is kept online 24 hours per day. The Communitree Group also intends to develop software for other personal computers such as the IBM Personal Computer.*

*The source code is written in FORTH, and the cost of the program and manuals is \$150.*

*Additional information may be obtained from the Communitree Group, Suite 207-3002, 470 Castro St., San Francisco, CA 94114.*

with consultants, vendors, and numerous organizations.

Participate, a conferencing system that has recently appeared on The Source, has facilitated conferencing among disparate groups. These

groups can subsequently organize themselves into communities.

An interesting example of the synthesis achieved in such a structure is the *electure*, a project designed and implemented by a group of approximately 20 participants within a three-month period. Jim Rutt, while serving as manager of Product Development for The Source, started with a concept developed by David Hughes, an early exploiter of computer telecommunications as a teaching tool, and suggested that Participate provide popular electronic lectures or "electures." A conference was started in which the members examined the scope, organization, and operation of an electure.

Despite the fact that many key members of the conference were periodically absent for extended periods, the group was first able to define the mechanism and procedures that were needed and then put the first electure online. The "electurer" was Starr Roxanne Hiltz, and the subject was the computer revolution—how the "electronic cottage" is changing the home. It appeared in seven segments, each segment followed by a ballot and a separate discussion conference. The electure became a powerful model for colloquia, seminars, electronic publishing, and structured telecommunications.

### **Where the Conferences Are**

As of this writing, approximately a dozen commercial conferencing services are available in the United States. Some of these are run on central computers and can be accessed by terminals or microcomputers via packet-switching networks such as Tymnet and Telenet. Some can be licensed for use on a private mainframe computer. Most of these services are summarized in table 1. In addition, there is even a computer-moderated conferencing system that runs on a microcomputer.

It is difficult to compare the various conferencing systems because many were designed with different tasks in mind. This has led to certain structural and operational quirks peculiar to each one. However, because some features are shared,

there are undeniable family resemblances.

All systems are designed to facilitate many-to-many communications. Participate differs somewhat in that it was designed to accommodate what has been referred to as "inquiry networking." Users of Participate may branch off a main conference and develop their own subconferences, usually based on an inquiry generated in the trunk discussion. This multiple-branching capability is analogous to the organization of subcommittees in a plenary session. The subcommittees are established to examine specific topics and then report back to the full committee. This structure facilitates the problem-solving aspect of conferencing.

Of course, any system that provides such opportunities for multiple-branched conferencing must also supply the user with means to maintain access and control. This requires a more complex set of instructions that can frustrate the unsophisticated subscriber. Initially, users may have difficulty knowing where they are within the conference hierarchy. Most computer conferencing systems have limited branching capabilities and use as simple a procedure as possible in order to achieve user-friendliness.

This does not mean that such systems are simple—far from it. EIES furnishes elaborate subdivisions for specialized information transfers, such as an electronic marketplace for buying and selling information and a "paper fair," a repository of research documents. Participate relies on its branching capability, which users must learn in order to tailor the system to their own needs.

Perhaps the most elaborate system is Augment, which gives the subscriber maximum control over all textual operations, from processing to multicolor page composition. Such a system requires a high degree of user knowledge and skill.

Com, the Swedish entry, has an extremely flexible structure that enables participants to track related messages via the links that interconnect them as a discussion grows. A single command is all that is needed to trace the



# North Star solutions are simple and powerful.

Not everyone needs a small business computer as powerful and fully-featured as a North Star. The North Star ADVANTAGE and HORIZON® micro-computer systems are built for those who demand a great deal more... of themselves as well as the vital tools they select for office automation.

## Powerful

Putting a North Star system through its paces is like high-speed driving in a luxury sports car: instant response to user commands, with a feeling of untapped resources within. Your North Star system has the power to get you through the fast curves of business and over towering peaks in workload. North Star outperforms the industry in single-user, multi-user and now in office network systems.

## Simple

Advanced software engineering has harnessed the power of the HORIZON and ADVANTAGE, so that achieving your results is as simple as a Sunday drive. Concise user commands instruct the computer to work the way you want it to.

And, we keep it simple everywhere: service, system expansion, and even custom software.

## Solutions

North Star systems are designed to get you from A to B as effectively as possible. The

designed-in harmony of our word processing, planning, accounting and other applications permits faster solutions and a broader range of possible accomplishments.

And no solution is complete until it is in presentation form. North Star graphics concisely present your results in charts, graphs and graphic figures.

Discover North Star's simply powerful solutions at one of over 1000 computer stores or systems houses. Call 800-447-4700 for the location nearest you, or write North Star Computers, Inc., 14440 Catalina Street, San Leandro, CA 94577.

**NorthStar**<sup>TM</sup>  
Simply powerful solutions.



**See us at NCC, Booth -W6358.**

The North Star logo, tagline and HORIZON are either trademarks or registered trademarks of North Star Computers, Inc. © 1983.

Systems serviced nationwide by MAI/Sorbus Service Division.

Circle 331 on inquiry card.



System	Availability	Connect Costs	Processor
<i>Participate</i> Participation Systems Inc. 43 Myrtle Terrace Winchester, MA 01890	The Source; may be licensed	\$20.75 to \$5.75/hour; closed user group: \$5000; licensing cost: \$10,000 to \$60,000	Prime computers
<i>EIES</i> Electronic Information Exchange System New Jersey Institute of Technology 323 High St. Newark, NJ 07102	Telenet, Univet, or direct dial	\$75/month; group accounts: \$200/month plus \$10/month per user plus \$8/hour	Perkin-Elmer 3230
<i>Notepad</i> Infomedia 801 Trager Ave., Suite 275 San Bruno, CA 94066	Tymnet; may be licensed	\$10/hour average; closed user group: \$1000/user plus \$60/hour; licensing fee: \$35,000	DEC-20 with TOPS-20 operating system
<i>Confer</i> Advertel Communications 2067 Ascot Ann Arbor, MI 48103	Telenet	\$19/hour average	Amdahl 580
<i>Hub</i> Institute for the Future 2740 Sand Hill Rd. Menlo Park, CA 94025	Uninet; may be licensed	\$30 to \$40/hour; licensing fee: \$40,000	DEC-20 with TOPS-20 operating system
<i>Com</i> Swedish National Defense Research Institute Stockholm University Computing Center Box 27322 S-10254 Stockholm Sweden	no subscription service; may be licensed	purchase cost: \$14,000 (\$7000 for universities); leasing cost: \$4000/year (\$2000/year for universities)	DEC-10; DEC-20
<i>Genie</i> Data Dynamics POB 5517 Portland, OR 97228	no subscription service; may be rented or licensed	rental cost: \$15,000/3 months; licensing costs: \$35,000	CDC Cyber 175; DEC VAX-11/780
<i>MTX</i> Matrix Transaction Exchange Cross Information Co. 934 Pearl Mall, Suite B Boulder, CO 80302	Telenet; may be licensed	\$50 fee plus \$25/hour; leasing costs: \$1000/month and up	DEC systems
<i>Augment</i> Tymshare 20705 Valley Green Drive Cupertino, CA 95014	Tymnet; may be licensed	\$14 to \$18/hour; licensing cost depends on implementation	DEC-20 with TOPS-20 operating system

**Table 1:** A list of commercial computer-moderated conferencing systems available today. Most of these systems can be accessed with either a microcomputer or a terminal. In addition, the software for some of these systems can be licensed for operation on a mainframe computer.

complex branches of an involved discussion.

### Computer Resources

One of the main advantages of computer-moderated conferencing is the ease with which you can access other very useful computer resources such as text editors, databases, and so

on. Obviously you need an editor to process text that you will enter into conference discussions, and databases, programs, graphics packages, and instructional texts are all significant enhancements.

This support may be achieved by one of three strategies: putting the resources on the conferencing com-

puter, accessing a separate resource computer over a network link, or implementing these resources directly on the user's microcomputer. In this last case, the conference computer may append one user's resource for the benefit of other users, although this is not the most important feature of such an arrangement. Obviously,





**3M**  
diskettes  
Box of 10 5 1/4 inch

SS,DD,RH  
single side  
double density

# Reliable.

## You can count on 3M diskettes. Day after day.

Just like the sun, you can rely on 3M diskettes every day. At 3M, reliability is built into every diskette. We've been in the computer media business for over 30 years. And we've never settled in. We're constantly improving and perfecting our product line, from computer tape and data cartridges to floppy disks.

3M diskettes are made at 3M. That way, we have complete control over the entire manufacturing process. And you can have complete confidence in the reliability of every 3M diskette you buy.

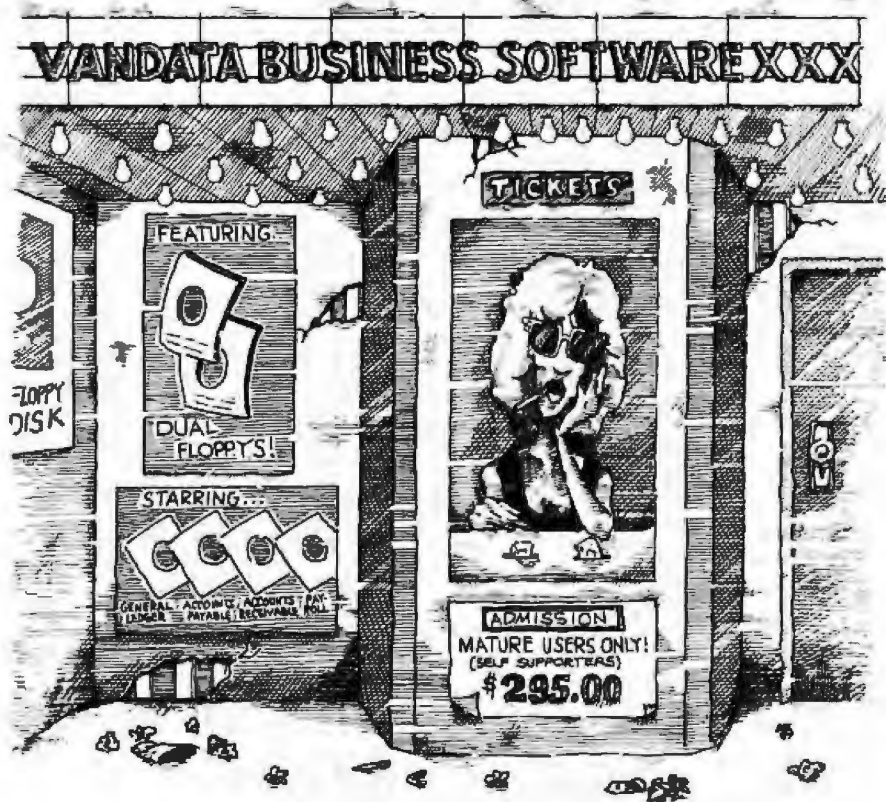
Look in the Yellow Pages under Computer Supplies and Parts for the 3M distributor nearest you. In Canada, write 3M Canada, Inc., London, Ontario. If it's worth remembering, it's worth 3M diskettes.



3M hears you...



# FOR MATURE USERS ONLY.



If you're a dealer, OEM, or fairly knowledgeable end user, Vandata has an incredible deal for you — the Vandata Business Software Package. The package includes: General Ledger, Accounts Payable, Accounts Receivable and Payroll with Cost Accounting, plus our custom installation program. **All for only \$295.**

Why so low? Because a mature user doesn't need support. That drastically cuts our costs. And yours.

And if you're a software dealer, you can resell Vandata Business Software without paying royalties. The Vandata business package is the best-debugged, easiest-to-install enhanced Osborne-based system on the market. It's well worth up to \$995 with your support to end users.

Minimum requirements are 48K RAM, CP/M™, or CDOS, CBASIC2™, a CRT and a 132-column printer. The package is available on most CP/M disk formats. Our installation manual is included and the Osborne/McGraw-Hill application manuals are available separately.

Why pay for support you don't need? Order the Vandata Business Software Package. **Call toll free: 1-800-426-5248.**

## VANDATA

17544 Midvale Ave. N., Suite 107,  
Seattle, WA 98133.  
In Washington call (206) 542-7611  
VISA or MasterCard accepted.

line costs may be minimized if you can access these editing and programming resources offline. (I'll discuss this further in the following section).

IES uses a microprocessor to dial out through Telenet to specific resources such as the New Jersey Educational Computing Network, which provides software packages for data analysis.

Designers of the Hub conferencing system from the Institute for the Future (IFF) decided to support four basic activities: graphics, programming, documenting, and balloting. Upon conclusion of the developmental and testing phase of the system, Hubert Lipinski and Richard Adler of IFF concluded that a more general method of achieving user-mediated access to resources is through a programmable microcomputer, so that connection to the conference computer and the resource computer could occur simultaneously.

Participate, as implemented on The Source, relies on the resources of the host computers in McLean, Virginia. These include various compilers; mathematical, statistical, and financial packages; and management modeling programs. The procedure for accessing these resources is complicated, however: the data must be processed outside the conference, the result placed into a file, and the file transferred into the conference.

### Microcomputers as Terminals

As mentioned previously, you can reduce online charges by using a microcomputer (or intelligent terminal) capable of supporting text processing and a wide variety of communications tasks. A long document can be composed offline, edited, and then transmitted to the conference. Conversely, documents can be downloaded and read at leisure. And for the corporate executive with a hectic schedule or the computer hobbyist with little money, the microcomputer can wait until an appropriate time (say, after midnight when the network rates are lowest), dial into the conference, upload documents, download messages, and inform its user of the transactions the next day.



# LET THE "ANGEL"™ DO THE WAITING .....

Two RS 232C Connectors for serial input and output

6 Leds to indicate power, transmission and reception status, buffer activities, page number, etc.

SKIP and REPRINT provide independent page controls to reprint portions of documentation

40 Pin Expansion Bus available for future expansion

COPY provides convenient one key operation for single copy or multi-copy of text

3 externally accessible Dip Switches for baudrate, device type, and parallel and serial selections. Selections can be made without losing buffer



Function keys extend the useful commands to more than 10, including: hex-dump, memory test, remote loading, etc.

8 easy-to-operate membrane key switches

Independent PAUSE and HOLD controls to suspend transmission and reception

Two 20 Pin Edge Connectors for parallel input and output

Connect an "ANGEL" between your computer and your printer, and let the "ANGEL" do the waiting ....

Your valuable computer spends 95% of its time waiting for the printer to catch up...and while the computer waits, the payroll continues.

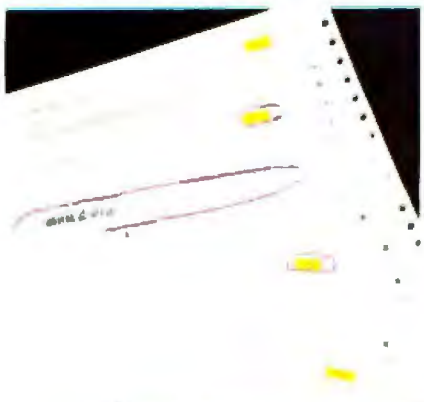
The computer sends data to the "ANGEL" at speeds up to 19.2K baud. The "ANGEL" stores data and sends it to the printer at a speed the printer can handle, and your computer is free to continue working without interruption.

#### A USER WRITES:

"I tried the "ANGEL" with my Altos system connected to an Epson MX-100, both set at 9600 baud. Without the "ANGEL" it takes 30 minutes to print 210 doctors' requisition forms. With the "ANGEL" installed, my computer is free after 90 seconds."

With "ANGEL'S" self diagnostics and memory test, the entire system thoroughly checks itself every time you power up.

PAGE REPRINT is another unique feature. EXAMPLE: You are printing a 32 page report, and the paper jams at page 11. Reset the printer to the top of the form, press PAGE REPRINT, and resume printing at the top of page 11. Want to restart two pages back? Press PAGE REPRINT twice, and you resume at page 10.



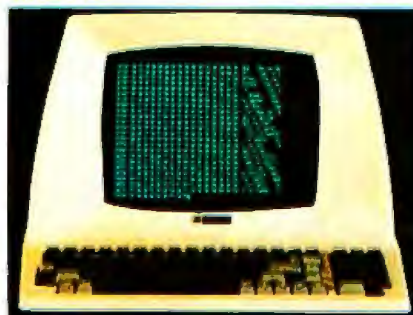
PAGE REPRINT

...And think of these other possibilities: HEX DUMP. Display or printout every bit of data your computer sends out to the printer in an easy-to-read Hexidecimal and ASCII format. A must for your programmer. Pause and Hold for real time programs. Page skip for selective printing. What a waste to print the entire documentation if you only need part of it.

Simple external switch settings, let the "ANGEL" accept either RS-232 serial or Centronics parallel data and can output either/or in any combination, (S-S,S-P,P-S,P-P). The "ANGEL" is compatible with almost all Micro-Computers, and can be installed by anyone in minutes. Switches are clearly marked for ease of operation, and a concise, USER FRIENDLY operator reference card is included with each unit.

The "ANGEL" has a full one year limited warranty.

**THE "ANGEL" WILL NEVER KEEP YOU WAITING!**



HEX DUMP

"ANGEL" is compatible with almost all Micro-Computers, including IBM, Apple, TRS-80, Vector Graphic, NorthStar, Altos, Xerox, Heath, Zenith, NEC, DEC, etc., with RS-232 serial, Hardware Handshaking, or Centronics compatible parallel interface. The manufacturer reserves the right to change the product specification.

The chart shown here illustrates the features of the "ANGEL" compared to other buffer devices. When compared with the "ANGEL", the others just don't measure up. Sorry guys.

Feature	ANGEL	MICRO FAZER **	SPOOLER	MICRO BUFFER D1/P1	SOOPER SPOOLER SERIAL **
Price	295.00	330.00	319.00 w/o serial	349.00	603.00
Memory Size	64K	64K	64K	64K	62K
Max Baud Rate	19.2K	?	N/A	19.2K	?
Serial-Parallel	Yes	*	No	*	*
Parallel-Serial	Yes	*	No	*	*
Parallel-Parallel	Yes	*	No	*	*
Serial-Serial	Yes	Yes	No	Yes	Yes
Copy	Yes	Yes	No	Yes	No
Reset/Clear	Yes	Yes	No	Yes	Yes
Pause/Hold	Yes	No	No	Yes	No
Page Skip	Yes	No	No	No	No
Page Reprint	Yes	No	No	No	No
Continuous Copy	Yes	?	No	?	No
Self-Diagnostics	Yes	?	?	?	?
Hex-Dump	Yes	No	No	No	No

\* Can only be configured for one of the four Modes.  
\*\* Information based on available specifications from manufacturer's advertisement as of December, 1982.  
Micro-Fazer TM of Quadram Corp.  
Sooper Spooler TM of CompuLink Corp.

#### TO ORDER:

CALL TOLL FREE 1-800-323-3304  
OR SEND CHECK OR MONEY  
ORDER TO LIGO RESEARCH

Please rush me ( ) "ANGEL(S)" @ \$295.00 each

Sub total \_\_\_\_\_  
ILLINOIS ONLY Add 6% U.S. sales tax \_\_\_\_\_  
Delivery charge \$4.00 \_\_\_\_\_  
**TOTAL** \_\_\_\_\_

Charge my ( ) VISA ( ) MASTERCARD  
MY ACCT. # IS \_\_\_\_\_  
EXPIRATION DATE \_\_\_\_\_



The essential capabilities for a microcomputer communications software package are the following:

- to provide a *transparent talk* utility that relegates the microcomputer to the "dumb" role of inputting key strokes and displaying information sent back by the host
- to record into mass storage all information received in the talk mode
- to upload files to the host computer in the talk mode
- to upload files with a "stop-and-wait" protocol so that large files may be uploaded without exceeding the buffer capacity of the recipient machine (for example, a microcomputer might upload a file until the host machine sends a wait signal—a Control-S on most keyboards—and will resume uploading when the host sends a continue signal—usually a Control-Q)
- to divert incoming data to a printer if hard copy is needed

Many other capabilities are useful,

and much depends on such factors as the data-transmission rate. With slow data transmission, the stop-and-wait protocol is usually not needed. If accuracy is essential, such as when sending binary or numerical data, asynchronous transmission may not be satisfactory.

Existing communications software packages for linking personal computers to such popular subscription facilities as Compuserve and The Source have rather limited capabilities. In contrast to this are the proprietary networks (e.g., Ethernet, Wangnet, and SDnet) developed by office equipment manufacturers for in-house electronic mail, Telex operations, the sharing of peripherals, and other telecommunications.

Recently microcomputer software designers have begun integrating packages for text editing and formatting, database management, and asynchronous communications all into a single system. One such system, MIST (Microcomputer Information Support Tools), was

developed by Peter and Trudy Johnson-Lenz and is available from New Era Technologies for licensing on microcomputers using the CP/M 2.0 operating system (MIST requires 56K bytes of volatile memory and two 250K-byte floppy disks).

Ultimately, multitasking multiuser operating systems running on the new generation of microprocessors will enable conferees to access many discussions, databases, and computer resources simultaneously. Without question, this will elevate telecommunications into a new realm about which we can only speculate.

### An Example: Participate

The best way to give you a good idea of how computer-moderated conferencing works is to show you an example of transactions with Participate on The Source. Getting into Participate is somewhat easy. After logging onto The Source and requesting command mode, all I have to do is type "PARTICIPATE." My terminal should then respond by displaying the following:

```
[PARTI Version 3.08]
Welcome to PARTICIPATE on the
Source, IRVING!
"PARTICIPATE" AND "PARTI" are
trademarks of Participation Systems Inc.
5 waiting notes.
```

Read, Scan, Batch, Cancel or Hold?

When a Source user asks for Participate, the conferencing computer automatically checks its memory to see if the account number is registered and what conferences the customer has access to. In this case, the computer recognizes me as "IRVING." It is more than a name, it is an address to which others can send messages and information. Note that I have five messages waiting for me. If I simply type "Read," I will be asked to respond to them one by one. By batching them together, I can decide what to do at the conclusion. These notes may be conference notes, readable by members of the conference, or they may be addressed to me alone or to groups of respondents.

Let's say I am involved with the engineering section at a computer man-

# BYTEWRITER®

## DAISY WHEEL PRINTER

- Full Olivetti typewriter warranty
- U.L. Listed



**\$695**  
plus shipping

### FEATURES

- Typewriter operation with nothing to disconnect
- 10, 12 or 15 characters per inch switch selectable
- Portable with carrying case
- Entire interface mounted internally in the Olivetti Praxis 30 typewriter
- Underlining
- Cables available for most computers
- Service from Olivetti dealers
- Centronics compatible parallel input
- Built in self test
- Cartridge ribbon
- 2nd keyboard switch selectable.

## BYTEWRITER

125 NORTHVIEW RD., ITHACA, N.Y. 14850  
(607) 272-1132



# ZERO TO MULTIPLAN™ IN 5.2 MINUTES.

## FINANCE OR ACCOUNTING WORKSHEETS FAST.

**SELLING AND ADMINISTRATIVE - BASIC INFORMATION**

Enter company name: **MICROSOFT FURNITURE**

Enter project name: **BUDGET PLAN FINANCE**

Enter report name: **SALES-ADMINISTRATIVE EXPENSES**

Enter optional budget period: **Q183**

COMMAND: Example Help Load Print Quit Review Save

Enter maximum: **Print tab to view recommended box** Expert System: maximum

Gentlemen, start your computers.

**Time: 0**

**SELLING AND ADMINISTRATIVE - INTERVAL SELECTION**

Monthly:

Quarterly:

Annually:

Other:

COMMAND: Example Help Load Print Quit Review Save

Type in: **Example Help Load Print Quit Review Save**

Print tab to view recommended box Expert System: maximum

Select budget intervals.

**Time: 0.5**

**SALES REVENUE**

Enter sales revenue for each quarter:

1st Qtr 1983 \$ 2500000

2nd Qtr 1983 \$ 2600000

3rd Qtr 1983 \$ 2500000

4th Qtr 1983 \$ 2000000

COMMAND: Example Help Load Print Quit Review Save

Enter maximum: **Print tab to view recommended box** Expert System: maximum

Enter sales revenue.

**Time: 1.0**

**VARIABLE SELLING EXPENSES - EXPENSES INCLUDED**

Enter cost of company by typing in new category number you find. If highlighted categories show you and a check, delete name or replace them with your own preferred categories.

Variable Selling Expenses: 1 Commission

Variable Selling Expenses: 2 Other

Variable Selling Expenses: 3

Variable Selling Expenses: 4

Variable Selling Expenses: 5

Variable Selling Expenses: 6

Variable Selling Expenses: 7

Variable Selling Expenses: 8

Variable Selling Expenses: 9

Variable Selling Expenses: 10

Variable Selling Expenses: 11

COMMAND: Example Help Load Print Quit Review Save

Select option of type command editor

Print tab to view recommended box Expert System: maximum

Enter selling expenses.

**Time: 1.5**

**BUDGET PLANNING - SALES-ADMINISTRATIVE EXPENSES**

	1983	1st Qtr 1983	2nd Qtr 1983
1 SALES REVENUE	7 960 000	2 500 000	2 600 000
2 VARIABLE SELLING EXPENSES	1 200	30 000	30 000
3 Commission	1 200	30 000	30 000
4 Other			
5			
6			
7			
8			
9			
10			
11			
12			
13			
14			
15			
16			
17			
18			
19			
20			
21			
22			
23			
24			
25			
26			
27			
28			
29			
30			
31			
32			
33			
34			
35			
36			
37			
38			
39			
40			
41			
42			
43			
44			
45			
46			
47			
48			
49			
50			
51			
52			
53			
54			
55			
56			
57			
58			
59			
60			
61			
62			
63			
64			
65			
66			
67			
68			
69			
70			
71			
72			
73			
74			
75			
76			
77			
78			
79			
80			
81			
82			
83			
84			
85			
86			
87			
88			
89			
90			
91			
92			
93			
94			
95			
96			
97			
98			
99			
100			

COMMAND: Alpha Blank Copy Delete Exit Format Query Help Insert

Enter Max: **Print tab to view recommended box** Expert System: maximum

Select option of type command editor

Print tab to view recommended box Expert System: maximum

Your sales budget on the Multiplan electronic worksheet - in record time.

**Time: 5.2**

and build financial or accounting worksheets tailored to your specific needs. In minutes.

You won't have to worry about developing formulas or formatting screens to build your Multiplan worksheets. Because the expert systems literally do it for you.

For example, the Multi-Tool Budget expert system creates seven inter-related

Multiplan worksheets for a total budget planning and control environment.

What's more, each system is developed by experts: business professionals and leading authorities in finance and accounting.

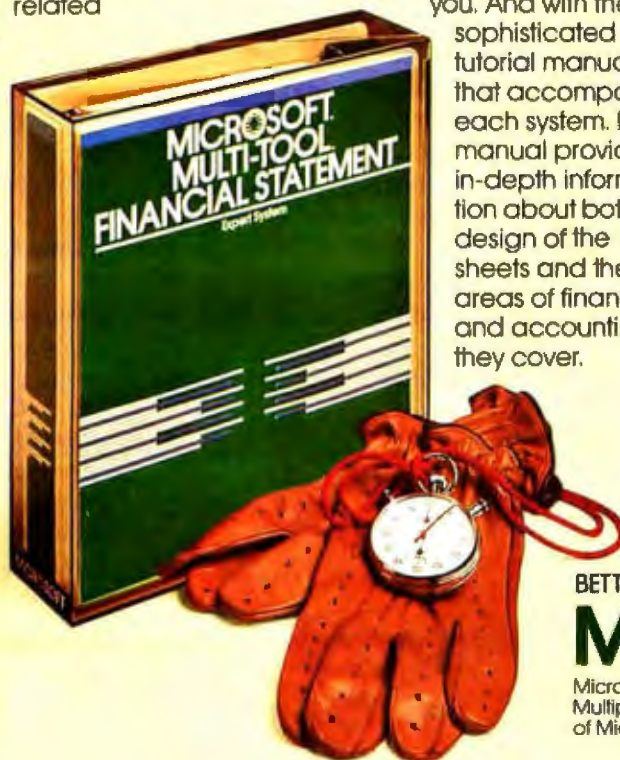
You'll benefit from their knowledge immediately, through the powerful worksheets each Multi-Tool expert system builds for you. And with the sophisticated tutorial manuals that accompany each system. Each manual provides in-depth information about both the design of the worksheets and the areas of finance and accounting they cover.

The result: a tailored electronic worksheet that helps you make high quality decisions.

That's just what you'd expect from Microsoft. The people who let you concentrate on your business rather than on your computer.

Ask your computer dealer to let you test drive the new Multi-Tool expert systems. Better tools that help you put your business in first place.

**THE MULTI-TOOL EXPERT SYSTEMS. A POWERFUL ADDITION TO THE MULTIPLAN ELECTRONIC WORKSHEET.** Available now: The Multi-Tool Budget expert system. The Multi-Tool Financial Statement expert system.



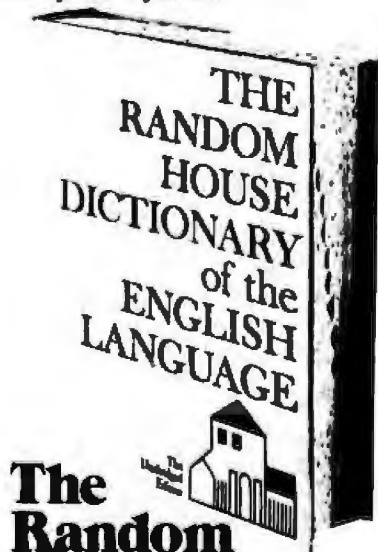
BETTER TOOLS FOR MICROCOMPUTERS  
**MICROSOFT™**

Microsoft is a registered trademark, and Multi-Tool, Multiplan and the Microsoft logo are trademarks of Microsoft Corporation.



# Less for Your Money

If you do word processing on your personal computer, you probably know that there are many programs for sale to help you with your spelling. But the biggest spelling error you'll ever make is paying too much for your spelling correction software. The Random House ProofReader gives you less for your money — less trouble, that is, and fewer spelling errors. The Random House ProofReader is based on the world famous Random House Dictionary. It contains up to 80,000 words, depending on your disk capacity. You can add new words with the touch of a key. It shows you the error and the sentence it's in. It instantly suggests corrections. It even rechecks your corrections. And it costs half as much as other programs with far less power. The Random House ProofReader is compatible with all CP/M 2.2<sup>®</sup>, MS-DOS<sup>®</sup> and IBM Personal Computer<sup>®</sup> systems.



**The Random House ProofReader \$50**

For orders or information, see your local dealer or call 505-281-3371. Master card and VISA accepted. Or write Random House ProofReader, Box 339-B, Tijeras, NM 87059. Please enclose \$50 and specify your computer model, disk size and memory.

Random House and the house design are registered trademarks of Random House, Inc. CP/M is a registered trademark of Digital Research, Inc. IBM and IBM Personal Computer are registered trademarks of International Business Machines, Inc. MS-DOS is a registered trademark of Microsoft, Inc.

ufacturing company, and I have been using a conference on engineering to keep in touch with everyone. The following message illustrates a typical exchange:

"NEW PRODUCTS" Conference 83.34 HENRY, about "THE MANUFACTURE OF PORTABLE PRINTERS." (answers: 5) THUR, 01/27 13:35 (254 characters)

The decision has been made to design and produce portable printers. The product is to be on the market by the middle of next year. All members of the engineering staff are to begin their preliminary discussions in this conference.

Join to receive future answers?

This message alerts me to the fact that on Thursday, January 27, another conference participant, HENRY, organized a new conference called "NEW PRODUCTS"—the 34th conference of 1983 (83.34)—about the manufacture of portable printers, and that there are already five responses in the conference discussion. I can find out who has already joined and what the topics of the discussions are, or I can join for a while, participate in the discussion, and then leave or quit the conference. Once I leave, however, I will no longer automatically receive notification of new discussion entries each time I log onto the computer.

Let's say I want to start my own conference, "JOINT," to establish communication between the engineering department and the marketing department to help market portable printers. To do this I type "Write" or simply "W" in response to the computer prompt, "Disposition for NEW PRODUCTS?" At this point, I can write my message in a special editable workspace—the scratch pad—set aside by the conference computer.

This is to notify all members of the engineering staff that a joint marketing-engineering conference called "JOINT" Conference has been organized to coordinate activities. A preliminary market survey indicates that there are three manufacturers of portable printers with high inventories. Design failures may have been the largest factor contributing to their lack of sales, and it will be

necessary to determine what was responsible for their poor performance.

The above message will be automatically appended to the "NEW PRODUCTS" Conference. At this juncture, I may use the editable workspace to organize the "JOINT" conference. As members of the engineering staff log onto the computer, they will be informed of my message concerning the "JOINT" conference and given the opportunity to join and participate.

This kind of communication system gives everyone the choice to enter, abstain, or simply monitor all goings-on. Only the moderator—the discussion editor—has the power to restrict membership, delete, or modify what has been recorded in the conference. It makes no difference whether HENRY and I are separated by a few feet or 10,000 miles, by seconds or days.

## The Computer as Publisher

Some large corporations, primarily those involved in computer technology, have begun to experiment with automated conferencing as a tool to facilitate their developmental work. The Massachusetts Institute of Technology's Center for Information Systems Research has been using Participate to run a conferencing project for a number of corporations. The MIT program has been particularly successful in using Participate to organize meetings and to explore specific conference topics. Notepad was used to organize the Spring 1982 Office Automation show in San Francisco.

In the past, a major meeting required careful planning and volumes of communication, but when the preparatory work is handled in a computer conference, the content and scope of a meeting are easily developed. Computer conferencing cannot substitute completely for all meetings, of course, but it can greatly increase the productivity of meetings when they do take place. Such conferencing also includes a democratizing feature: the organization is open to criticism and discussion among all conferees.

This immediately points to a poten-





# Some people drive fine German machines to work. Some people drive them once they arrive.

The tradition of high quality, high performance German craftsmanship and engineering is legend. And while we most often see that tradition in action on America's streets and highways, it is in America's business offices that its future holds the most promise.

The BASIS 108 is the proof.

This powerful small business computer passes higher-priced competitors with ease. Its dual processors — for CP/M® and Apple II® compatibility — open up the largest library of microcomputer software and plug-in peripherals available today.

This unique combination also provides compatibility with other popular languages, including Pascal™ and LOGO™.

The detached keyboard is a work of art and practicality. Lightweight and low profile, it features a full one-meter cord for comfortable operation on your desk — or your lap. There's a full 128-key ASCII character set. Fifteen user-definable function keys that can provide access to 60 distinct functions. A nine-key cursor control block. And a convenient eighteen-key numeric pad. For special applications, you can also custom map the keyboard with a simple exchange of ROMs.

And there's more. RGB and composite NTSC or PAL video. Keyboard-selectable 80- or 40- column display.

High resolution color graphics. Parallel and serial printer interfaces. Easily accessible outboard I/O connectors. Six Apple II-compatible card slots for peripherals expansion. Even a two-inch alarm or music speaker.

The BASIS chassis is cast aluminum, eliminating heat and RFI interference problems. And there's plenty of room for internal expansion to include hard disk drives and other peripherals.

The BASIS 108. Microcomputing's "Best Of Both Worlds." German craftsmanship and American business savvy. CP/M-based business computing and Apple II-based personal computing. High performance and a surprisingly low cost. The BASIS 108. A computing machine finely tuned to handle the fast tracks of business today.

Call your BASIS dealer for a test drive.



**BASIS**  
INCORPORATED

5435 Scotts Valley Drive  
Scotts Valley, CA 95066  
(408) 438-5804 TWX: 910-598-4512

CP/M® is a registered trademark of Digital Research, Inc. Apple II® is a registered trademark of Apple Computer, Inc. Pascal™ is a trademark of the Regents of the University of California at San Diego. LOGO™ is a trademark of Logo Computer Systems, Inc.

Circle 58 on inquiry card.



tially important new application. Computer conferencing may be ideally suited to filling certain gaps in publishing. Consider this: with a computer terminal connected to a network, the user has potential access to thousands of information libraries or databases—from the New York Times Consumer Data Base to the Library of Congress Card File. There is no substantial publisher of data that does not put at least part of its information into computer storage. Some commercial information services such as Dialog, a subsidiary of Lockheed, have access to over 45 million records in more than 120 databases on business, science, medicine, technology, the humanities, and politics.

The computer facilitates the search for meaningful information by providing highly selective search strategies. It is no longer true that the proliferation of information is threatening to deluge us with meaningless drivel. The problem is the opposite. Information is not being produced fast enough.

Particularly troublesome is the fact that some scientific and medical articles take a year or more after submission to a journal before emerging in print. Also, the processing of economic statistics can be excruciatingly slow. Such delays are not acceptable. We need more informa-

tion faster if we are to be able to correlate and organize the diverse pieces necessary to make coherent and prompt decisions.

One exciting solution is for scientific societies to supplement their publishing operations with computerized conferences in which information exchanges can be conducted and subjected to the critical scrutiny of their members. Specialized research groups can also conduct exchanges, partially in public or wholly in private, in order to accelerate the interchange of ideas and data. Ongoing dialogs can be developed and nurtured along diverse, interdisciplinary lines, merging with specialists in different groups when necessary.

### The Collective Intelligence

The marriage of cable television with computer technology has already led to a limited form of mass conferencing in certain test markets. On the Qube system in Ohio, subscribers can respond to inquiries, participate in votes, play games, and obtain information through a communications link with their cable service.

In the future—especially as videotex services become more popular—electronic mail, commercial transactions, conferences, magazine abstracts, local reports, and public-interest announcements will be

integrated into our daily routine.

How the institutions of our society—business, government, universities, laboratories—will be changed by this technology is difficult to assess. The process of communicating creates new information: new designs for equipment, solutions to marketing problems, the synthesis of scientific and technical knowledge, the testing of hypotheses, the hard work of whittling fact from the raw material surrounding it. And the more people communicate, the more new information will become available. Once expressed, an idea will become part of a percolating turbulence of thought, criticism, and judgment—a collective intelligence,

There will be dangers, however. Information vendors may assume tremendous power; no antitrust laws govern the management of ideas. The great institutions may acquire even greater authority, and a suffocating superclass might emerge to stifle the innovations of the future. Privacy may be difficult to maintain, and privileged information may become the prey of unscrupulous individuals and institutions.

What we gain, however, will be more than what we hazard losing. We will live with a wealth of ideas, in a firmament of information as enormous as the whole of human knowledge. ■

## ENHANCE YOUR COLOR COMPUTER WITH THESE GREAT PRODUCTS!

### MACRO-80c DISK BASED EDITOR/ASSEMBLER

This is a powerful macro assembler, screen oriented editor and machine language monitor. It features local labels, conditional assembly, printer formatting and cross reference listings. Assemble multiple files. Program comes on Radio Shack compatible disk with extensive documentation. Price: \$99.95

### MICROTEXT COMMUNICATIONS

Make your computer an intelligent printing terminal with off-line storage! Use Microtext for timesharing interactions, printing what is received as it is received and saving text to cassette. and more! Price: \$59.95

### PI80C PARALLEL PRINTER INTERFACE

Use a parallel printer with your Color Computer! Serial-Parallel converter plugs into the serial port and allows use of Centronics-compatible printers. You supply the printer cable. Price: \$69.95

### THE MICRO WORKS COLOR FORTH

Color Forth is easier to learn than assembly language, executes in less time than Basic and is faster to program in than Basic. Rompack comes with 112-page manual containing glossary of system-specific words, full standard FIG glossary and complete source. A fascinating language designed for the Color Computer! Price: \$109.95

### SDS-80C SOFTWARE DEVELOPMENT SYSTEM

SDS-80C is a Rompack containing a complete editor, assembler and monitor. It allows the user to write, assemble and debug assembly language programs with no reloading, object patching or other hassles. Supports full 6809 instruction set. Price: \$89.95

### BOC DISASSEMBLER

Runs on the Color Computer and generates your own source listing of the Basic interpreter ROM. Documentation includes useful ROM entry points, complete memory map, I/O hardware details and more. Cassette requires 16K system. Price: \$49.95

GAMES: Star Blaster ★ Pac Attack ★ Berserk ★ Cave Hunter ★ Starfire ★ Astro Blast ★ Starship Chameleon ★  
Adventure: Black Sanctum ★ Adventure Calixto Island ★

THE  
**MICRO  
WORKS**

Also Available: Machine Language Monitor Books Memory Upgrade Kits  
Parts and Services Call or write for more information

California Residents add 6% Tax  
**Master Charge/Visa and  
COD Accepted**

P.O. BOX 1110 DEL MAR, CA 92014 619-942-2400



# THE BEST PRICED 256K RAM CARD ONLY HAS 64K.



Compatible with the new XT

**BUT YOU CAN GET  
ANOTHER 192K  
ANY TIME.**

Apparat's RAM Card, priced at \$149, is the most economical way to add memory to your IBM/PC today. And have the ability to add-on tomorrow.

The RAM Card, with sockets for up to 256K bytes of RAM with parity, gives you an additional 64K of RAM for your IBM. As the price of RAM chips comes down further or your needs go up, you can add to it easily. Additional RAM is available today at \$64 per



64K increments if you need it now. If not, wait and buy it in the future. Apparat's 64K RAM Card gives you memory and economy. The RAM Card also comes with SDRIVE, enabling RAM memory to be directly accessed as if it were disk memory. And if you

use Apparat's COMBO Card you can have three additional functions; parallel printer, RS232 async communications and clock calendar. The COMBO Card is now priced at just \$169. The RAM Card and COMBO Card are compatible with IBM/PC DOS 2.0 to let you use the newest IBM operating system and both carry a one year warranty.

For the dealer nearest you call 800/525-7674 or write Apparat Inc., 4401 S. Tamarac Parkway, Denver, Colorado 80237, 303/741-1778.

IBM PC is a trademark of IBM

 **Apparat, Inc.**

Circle 31 on Inquiry card.





**YOUR PROGRAM HERE**





# The best software for the IBM Personal Computer. Could it be yours?

Attention, all programmers. Here's a chance to reach the top.

If you've written software that's completed and runs on the IBM Personal Computer, we could be interested in publishing it.

(We also could be interested if it runs on *another* computer. If we select your software, we'll ask you to adapt it to our system.)

But be advised.

Our expectations are great.

Because the software we publish must be good enough to complement IBM Personal Computer hardware. In fact, the more you take advantage of all our hardware capabilities (see the box at right), the more interested in your software we become.

Think about incorporating color graphics into your program, for example.

Use sound. Consider the power of our keyboard and remember to utilize the ten programmable function keys.

In all cases, we're interested in "friendly" software—with emphasis on quality and wide appeal. Programs with the greatest chance of being published must be easy to use, offer a better way to accomplish a task and provide something special to the user.

What kinds of programs? All kinds.

Education. Entertainment. Personal finance. Data management. Self improvement. Games. Communications. And yes, business.

We select programs that will make the IBM Personal Computer an even more useful tool for modern times.

## IBM PERSONAL COMPUTER SPECIFICATIONS

<b>User Memory</b> 64K-640K bytes	<b>Display Screens</b> Color or monochrome High-resolution 80 characters x 25 lines Upper and lower case	<b>Permanent Memory (ROM)</b> 40K bytes
<b>Microprocessor</b> 16-bit, 8088	<b>Operating Systems</b> DOS, UCSD p-System, CP/M-86†	<b>Color/Graphics</b> <i>Text mode:</i> 16 colors 256 characters and symbols in ROM
<b>Auxiliary Memory</b> 2 optional internal diskette drives, 5¼" 160KB/180KB or 320KB/360KB per diskette	<b>Languages</b> BASIC, Pascal, FORTRAN, MACHO Assembler, COBOL.	<i>Graphics mode:</i> 4-color resolution: 320h x 200v Black & white resolution: 640h x 200v Simultaneous graphics & text capability
<b>Keyboard</b> 83 keys, 6 ft. cord attaches to system unit 10 function keys 10-key numeric pad	<b>Printer</b> All-points-addressable graphics capability Bidirectional 80 characters/second 18 character styles 9 x 9 character matrix	<b>Communications</b> RS-232-C interface SDLC, Asynchronous, Bynchronous protocols Up to 9600 bits per second
<b>Diagnostics</b> Power-on self testing Parity checking		

So, if you think your software is the best, consider submitting it. If it's accepted, we'll take care of the publishing, the marketing and the distribution. All you have to do is reap the benefits of our new royalty terms. And you're free to market your program elsewhere *at any time* even if you license it to us.

We're offering the ladder. Think about taking the first step.

For information on how to submit your program, write: IBM Personal Computer,

External Submissions,  
Dept. 765 PC, Armonk,  
New York 10504.



## The IBM Personal Computer A tool for modern times

For more information on where to buy the IBM Personal Computer, call 800-447-4700. In Alaska or Hawaii, 800-447-0890. †UCSD p-System is a trademark of the Regents of the University of California. CP/M-86 is a trademark of Digital Research, Inc.



# Electronic Publishing

## The New Newsletter

*How a traditional newsletter became a computer-accessed, interactive investment advisory service.*

Computer conferencing is gaining popularity as a solution to the time and place restrictions of conventional business meetings; however, the techniques involved readily lend themselves to other uses. Through the example of the Independent Investors Forum (IIF) I'll show how such conferencing techniques can be applied to the field of newsletter publishing to develop an information service that is highly receptive to the needs of its audience.

Not long ago I found the opportunity to publish a small newsletter for stock market investors. In designing this publication, I had two principal objectives. First, the publication would have to be profitable, even though it would probably circulate to fewer than 500 subscribers. Spreading investment advice to a larger au-

---

Arthur S. Bechhoefer  
Independent Investors Forum  
1640 Argonne Place, NW  
Washington, DC 20009

---

dience, as is done in many newsletters and most notably on public television's *Wall Street Week*, destroys the value of the advice: too many people act on it before you get a chance.

Second, because I wanted the publication's information to help individuals make investment decisions that best meet their own needs, people ought to have some input into the editorial process. They should be able to question the research staff, offer their own opinions, and ask other subscribers what they think. (In practice on the IIF, not only does this dialogue produce better decisions, it keeps our research staff honest. That's why we tell our clients, "Our advice is questionable.")

This second objective presented me with an interesting new application for my personal computer. Originally I had intended to use it simply as a word processor to produce clean copy suitable for a biweekly newsletter. But even a computer novice like me could see at a glance the advantages of a computerized investment service over traditional market

advisory letters. The major benefit, of course, is the elimination of the time needed for preparing hard copy and mailing it to subscribers. Investment advice often loses its value rapidly. Timing of purchases and sales is critical, especially for the small investor. With a computer and communications equipment, you can get all the information instantly.

An electronic mail or bulletin board system would be one way to meet this need for rapid communication. But the problem with these systems is that the user often likes to refer back to certain articles and to skip over other articles entirely. The user needs to be able to sort through the entire data file quickly to minimize connect-time costs and to avoid eyestrain from looking at a video display that, in the case of most home systems, is pretty unsophisticated.

Compared with hard copy, the average home computer terminal leaves a lot to be desired. There are no fancy type styles, no photos, and very limited graphics. Everything merely scrolls up a phosphor monitor that displays at best only 80 columns of text. How much of that can you take before you get bleary-eyed or just plain bored? We had a hunch, confirmed by subsequent research,

---

#### Editor's Note:

For more information on computer-moderated conferencing, see the article entitled "The Movable Conference," by Irving Lerch, also in this issue on page 104.

---

#### About the Author

Arthur Bechhoefer has a doctoral degree in Urban and Regional Planning from the University of Michigan. He is the director of the Independent Investors Forum, the first commercial application of computer conferencing techniques to newsletter publishing.

---



# Tiny BASIC MICROCOMPUTERS TRANSWAVE'S K-8073 SERIES

The "ENGINEER'S" computer is available in three powerful versions offering real-time Tiny BASIC.



**\$684<sup>00</sup>**

\*24K BYTE SINGLE UNIT



## K-8073B XCALIBUR

**Low Cost—Powerful/Versatile  
Rapid Implementation of Control Programs**

In its price range, the NEW Transwave K-8073B, "XCALIBUR," is the computer for the engineer or technician. Rapidly implemented, the "XCALIBUR" can be up and running sophisticated applications of measurement and control in hours instead of weeks or months. Transwave has added many important features to its original Tiny BASIC K-8073. Memory has been expanded to 24K byte of RAM with 16K battery backup. An additional 8K byte is available for HI RES color video and is contiguous to the first 16K RAM. EPROM is increased to 16K with an on-board programmer. The "XCALIBUR" comes in a heavy-duty extruded aluminum housing with a 16-key data input keyboard and 8-digit, real-time display. A constantly expanding EPROM software library allows fast implementation of many industrial control applications.

\*Supplied with 16K EPROM, 6K RAM, 2.5K ROM.

With full memory—\$992—16K EPROM, 24K RAM.

### Expanded Features:

- INS-8073 XMOS\* 8MHZ or 4 MHZ Tiny BASIC microinterpreter.
- Extended memory—24K RAM battery backup, 16K EPROM w/on-board programmer.
- Color video generator for full HI RES graphics/text.
- RS-232 w/printer handshake.
- Real-time clock—yr., mo., wk., day, hr., sec. w/interrupt.
- Socketed RAM: 2K or the new 8K 6264LP.
- Buffered ADD/DATA/CONTROL LINES.
- ART/RC Master, for single wire data I/O of 128 "Slaves."
- 8-digit status display w/16-key data input keyboard.
- New interlocking extruded aluminum metal housing for industrial use.

\*When available from NSC.

## K-8073A

**The Satellite Tiny BASIC Computer  
Features:**

- INS 8073 microinterpreter MPU
- On-board, real-time clock
- RS-232 communications
- Color video generator w/graphics
- Up to 40K RAM/EPROM memory
- Battery backup for RTC & RAM
- ART/RC communications link
- Extruded aluminum module

For stand-alone control applications, the K-8073A provides a low-cost alternative. After software has been developed, the small K-8073 module can be installed just about anywhere. As a satellite, the K-8073A can report or receive instructions from a host computer.

24K BYTE SINGLE UNIT **\$478<sup>00</sup>**



K-8073A



K-8073

## K-8073

**The Original Board Level Tiny BASIC  
Computer**

**Features:**

- INS 8073 MPU w/Tiny BASIC language
- STD (modified) bus
- On-board, real-time clock
- On-board EPROM (2716) programmer
- 1K byte local RAM
- 8K byte EPROM
- PPI—three 8-bit programmable I/O
- RS-232 communications
- ART/RC for single wire I/O to 128 "Slaves"
- Auto start capability
- Accessories:
  - Dual voltage power supply
  - 8K RAM board
  - 16K memory board (RAM or EPROM)
  - A/D module
  - TRIAC output
  - Assembler/disassembler

SINGLE UNIT **\$388<sup>00</sup>**



**TRANSWAVE CORPORATION**

Cedar Valley - Box 489  
Vanderbilt, PA 15486  
(412) 628-6370

For orders and information only:  
(800) 245-6843/Telex 902992



# LISP

For The  
**IBM**  
Personal Computer

THE PREMIER LANGUAGE  
OF ARTIFICIAL INTELLIGENCE  
AVAILABLE  
FOR YOUR IBM PC

► **DATA TYPES**

Unlimited Precision Integers  
Floating Point Numbers  
Character Strings  
Multidimensional Arrays  
Files  
Machine Language Functions

► **MEMORY MANAGEMENT**

Dynamic Allocation  
Compacting Garbage Collector  
Full Memory Space Supported

► **FUNCTION TYPES**

Call-By-Name/Call-By-Value  
Fixed/Variable Number Of  
Arguments  
Macros  
Machine Language/Interpreted  
Over 150 Primitive Functions

► **IO SUPPORT**

Multiple Display Windows  
Cursor Control  
All Function Keys Supported  
Read And Splice Macros  
Disk Files

► **POWERFUL ERROR  
RECOVERY**

► **8087 SUPPORT**

► **LISP LIBRARY**

Editor And Formatter  
Package Support  
Debugging Functions  
.OBJ File Loader

► **RUNS UNDER PC-DOS**

## IQLISP

from

∫ *q* **Integral Quality**

P. O. Box 31970  
SEATTLE, WA 98103-0070  
(206) 527-2918

5¼ diskette and manual 125.00  
manual only 25.00

(Wash. State residents add sales tax)  
VISA and Mastercard Accepted

### "Listening in" on the Independent Investors Forum

The following is an edited series of responses on the IIF. Note that although the item was originally dated June 1982, a participant was able to join in November and get an update.

Item 1 08:56 Jun14/82 20 lines  
Arthur Bechhoefer  
June Recommendations—  
Fruits of Labor

Despite the poor functioning of the economy, there are STILL some stocks worth considering. For June, I continue to recommend high technology stocks in markets that are growing steadily or that have at least cyclical growth potential.

As I noted last month, my two choices continue to be Apple Computer, because of a better than 30 percent growth in the personal computer market, and Cherry Electrical Products, a manufacturer of micro-switches, computer keyboards, and "dedicated" semiconductor circuits for cameras, smoke alarms, and other control apparatus.

You're certainly big on fruit. How about meat and potatoes?

The only item along that line I recommend is Prime Computer, which unlike its two main competitors—Digital and Data General—continues to post profit gains from quarter to quarter and has had recent purchases

of its stock by officers and directors. . . .

#### Six Discussion Responses

- 1) Howard Finney: How do you feel about DEC overall?
- 2) Art Bechhoefer: Last May, as reported by the Securities and Exchange Commission, five of Digital's officers sold roughly 10 percent of their stock holdings at prices ranging from \$76 to \$81. With the stock currently about \$84, I think I'd go along with the insiders and sell too, if I owned it.
- 3) Peter Hollidge: Art, it's now November. Do you still feel the same about Apple?
- 4) Art Bechhoefer: Peter, yes, basically I feel the same way. See item 31 for an update. I tend to think that the market as a whole is too high right now (November 3) but remember that Apple has been lower relatively speaking, due to Steven Jobs' having sold a bundle of shares to finance a music extravaganza last August.
- 5) Carolyn Allen: Art—it was Steve Wozniak who blew a bundle on the US festival.
- 6) Art Bechhoefer: Right you are. Anyway, same difference. A lot of stock went on the market and kept Apple prices artificially low. This was coupled with skepticism in the investment community concerning lack of a new computer to update the Apple II.

that the limit was something like 4 minutes for an article and not more than 10 or 15 minutes for an entire session, including the time to sign on, request the information, read it, and decide on subsequent action.

If we examine these constraints in terms of what they mean for stock market advice, we find that our research articles could cover only basic points—the main reasons behind our buy, hold, or sell recommendations. But the user might be left with quite a few unanswered questions concerning the research data as well as other possible investment alternatives. This suggests that some method for requesting more information, such as two-way communica-

tion, is essential in electronic publishing.

Two-way communication provides a basis for dialogue and thus enhances information transfer and learning. What is true for scientists, engineers, or any other professionals, applies equally to those providing investment advice: no one has perfect information. No one has a monopoly on expertise. Some people specialize in one area, some in another. A well-formed investment decision is the product of all the best available information, given the constraints of time and cost. Dialogue speeds the transfer of information and thus makes learning and decision making more efficient.

To facilitate two-way communica-



# The new COMPAQ Portable Computer. IBM compatibility to go.

**S**imple, isn't it? The COMPAQ™ Portable Computer can do what the IBM® Personal Computer does. To go.

It runs all the popular programs written for the IBM. It works with the same printers and other peripherals. It even accepts the same optional expansion electronics that give it additional capabilities and functionality.

There's really only one big difference. The COMPAQ Computer is designed to travel.

Carry the COMPAQ Computer from office to office. Carry it home on the weekend. Or take it on business trips.

If you're a consultant, take it to your client's office.

If you use a portable typewriter, you can use the COMPAQ Computer as a portable word processor instead.

If your company already uses the IBM Personal Computer, add the COMPAQ

you'd probably need to buy an additional display screen because the built-in screen is too small for certain tasks, like word processing. The COMPAQ Computer's display screen is nine inches diagonally, big enough for any job, and it shows a full 80 characters across. And the built-in display offers high-resolution graphics and text characters on the same screen.

The bottom line is this. The COMPAQ Computer is the first uncompromising portable computer. It delivers all the advantages of portability

In the standard configuration, the COMPAQ Computer has three open slots for functional expansion electronics as your needs and applications grow. It accepts standard network and communications interfaces including ETHERNET™ and OMNINET™.

If you're considering a personal computer, there's a new question you need to ask yourself. Why buy a com-



Portable as a mobile unit that can use the same programs, the same data disks, and even the same user manuals.

There are more programs available for the COMPAQ Computer than for any other portable. More, in fact, than for most non-portables. You can buy them in hundreds of computer stores nationwide, and they run as is, right off the shelf.

With most other portables

without trading off any computing power capability. And what do those advantages

cost?

Nothing.

The COMPAQ Portable sells for hundreds less than a comparably equipped IBM or APPLE® III. Standard features include 128K bytes of internal memory and a 320K-byte disk drive, both of which are extra-cost options on the IBM. Memory and additional disk drive upgrades are available options to double those capacities.

puter that isn't portable? For more information on the COMPAQ Portable Computer and the location of the Authorized Dealer nearest you, write us. COMPAQ Computer Corporation, 12330 Perry Road, Houston, Texas 77070. Or call 1-800-231-9966.

© 1983 COMPAQ Computer Corporation  
IBM® is a registered trademark of International Business Machines Corporation.  
ETHERNET™ is a trademark of Xerox Corporation.  
OMNINET™ is a trademark of Corvus Systems.  
Apple® is a registered trademark of Apple Computer, Inc.  
COMPAQ™ is a trademark of COMPAQ Computer Corporation.



## COMPAQ™

PORTABLE COMPUTER

The most computer you can carry Circle 105 on inquiry card.



# Will This Happen to You?

NOT IF YOU BUY YOUR PRINTER FROM... THE

# Printer

STORE

SERVICE, COMPUTER AND SOFTWARE COMPATIBILITY, and LOW PRICE, are among the many factors to consider when purchasing a printer. At the **PRINTER STORE** we specialize in printers, so our trained professional staff can help you choose the right printer for your personal and business needs. When you buy a printer from us you can be assured that your purchase will also include:

- ★ FULL FACTORY AUTHORIZED SERVICE
- ★ FREE TECHNICAL CONSULTATION
- ★ FULL AFTER SALE SUPPORT

## DOT MATRIX PRINTERS

**EPSON SERIES**  
 FX 80 ..... \$ CALL  
 MX 100 ..... \$ CALL

**OKIDATA SERIES**  
 82 A ..... \$380  
 83 A ..... \$685  
 92 A ..... \$ CALL  
 93 A ..... \$ CALL  
 84 (parallel) ..... \$ CALL

**C. ITOH SERIES**  
 8510 Prowriter ..... \$395  
 Prowriter II ..... \$ CALL

**IDS SERIES**  
 Microprism 480 ..... \$ CALL  
 Prism 80 ..... \$ CALL  
 Prism 132 ..... \$ CALL

**GEMINI SERIES**  
 Gemini 10 ..... \$339  
 Gemini 15 ..... \$ CALL

**NEC 8023** ..... \$ CALL  
**Toshiba P 1350** ..... \$1750

## LETTER QUALITY PRINTERS

**BROTHER SERIES**  
 HR-1 (parallel) ..... \$815  
 HR-1 (serial) ..... \$ CALL

**COMREX SERIES**  
 CR-1 (parallel) ..... \$ CALL  
 CR-1 (serial) ..... \$ CALL

**Transtar 130** ..... \$785

**C. ITOH SERIES**  
 F-10 40 CPS ..... \$ CALL  
 F-10 55 CPS ..... \$ CALL

**Daisywriter** ..... \$ CALL

**NEC SERIES**  
 3510 ..... \$1575  
 3530 ..... \$1850  
 3550 ..... \$ CALL  
 7710 ..... \$2425  
 7720 ..... \$2900  
 7730 ..... \$2400

**SCM-TPI** ..... \$585

**Micro Buffer** ..... \$ CALL  
**Grappler+** ..... \$ CALL  
**Apple Dumping** ..... \$ CALL

We carry a full line of Cables and Accessories

Call (213) 470-1888 and ask us about...

### PHONE REBATE

We are so confident of our LOW PRICES and SUPPORT that we are going to ask you to make the initial investment by calling us. In return when you buy your printer from us we will rebate the cost of your call and deduct it from your invoice.

THE

# Printer

STORE 2357 Westwood Blvd., L.A., CA 90064

The Printer Store 1983

**HOW TO ORDER:** Our phone lines are open from 8 a.m. to 6 p.m. PST Monday-Friday. We accept VISA MASTERCARD (at no extra charge) personal checks (take two weeks to clear) C.O.D.'s accepted. Same-day shipment on orders placed before 1 p.m. Manufacturer's warranty applicable on all equipment. Prices subject to change.

tion, I chose a computer conferencing system available on the Michigan Merit network. The system, known as Confer II, runs on an IBM 3081 or Amdahl equivalent and is accessed from any of five network host computers via GTE's Telenet network or leased outside lines. Confer II has a number of features that, while not unique, are eminently well suited to electronic publishing:

- The computer conference organizer (editor) can easily create agenda categories for the different types of information that will be presented. The agenda is similar to a table of contents in a magazine.

- The user (reader) always has a chance to respond, discard, or pass on each item (research article) presented. The user can select the latest items and literally throw away the rest, or just read summaries or items dealing only with certain subjects (stocks, industries, investment strategies, and so forth).

- The ability to respond at any time, either openly for all participants or privately for selected individuals, means that the more timid participants don't get shouted down or brushed aside. Conversely, the more assertive participants soon learn that long responses cost more. In some ways these features actually improve the quality of dialogue beyond what might occur in a real-time teleconference or face-to-face meeting. In the context of a publication, it is far livelier than a standard Letters to the Editor column.

- The focus of the conferencing system is on making decisions, not just sharing information. The system software encourages users to contribute information, suggest topics for future research, vote on the conference agenda, or express their preference for particular investment alternatives.

The net effect of these features from the organizer's (i.e., editor's) point of view is to have at one's fingertips a vast amount of feedback, making it possible to provide what the users want, not what the organizer or editor *thinks* they want. From the



# 5000 IS "The Desktop Mainframe"



## The Most Versatile Integrated System Available! — Without Compromise.

From the crystal clear monitor with a true typist keyboard to the high performance switching power supply—an engineered solution—the 5000IS system is designed to be an economical single-user system (basic system price is \$3,295) which is easily field expandable to be the master of a four-user system.

Now you can have hi-density floppies, 19 megabyte Winchester with true error detection and correction, extended RAM memory, and various

peripheral controllers. Up to four users may be supported by the 5000IS, with each user having a dedicated microprocessor, 64K of memory and two serial I/O channels.

With this flexibility you can configure the highest performance, lowest cost multiuser/multiprocessing system available. A four-user IS system gives you higher performance at a lower cost than comparable systems configured with personal computers or other single-user micros!

For complete information and specifications on the 5000 IS plus the location of your nearby IMS International dealer, call or write today!

(714) 978-6966 or (702) 883-7611

**IMS**  
INTERNATIONAL

We Build Computers As If Your Business Depended On Them.

2800 Lockheed Way  
Carson City, NV 89701  
Telex: 910 365 8051

IMS INTERNATIONAL DISTRIBUTORS:  
Argentina  
Australasia  
Austria

Canada  
Chile  
Ecuador

France  
Greece  
Hong Kong

India  
Israel  
Italy

Korea  
Malaysia  
Mexico

Netherlands  
New Zealand  
Philippines

So. Africa  
Singapore  
Spain

Sweden  
Switzerland  
United Arab Emirates

United Kingdom  
U.S.A.  
West Germany



point of view of the researcher, it puts an end to the notion that there are only a few experts whose words are infallible.

As for the users, our information indicates that they prefer spending no more than 15 or 20 minutes online per session. They sign on mostly during weekends or holidays, thereby reducing their connect-time costs by about 10 percent. Also, if they have appropriately equipped personal computers, they can download items from the host system and store them on disk. The items can then be read at the users' leisure, and connect time will be reduced. Similarly, users can prepare messages on their personal computers before going online, and then quickly upload the messages into the host system, saving even more time.

Although users of the Independent Investors Forum have some difficulty mastering the numerous system commands at first, their capabilities improve quite rapidly, as evidenced by the accuracy and appearance of their

responses and other communications. When troubles occur—and they do—the user can call us by telephone. We have a technical advisor who provides advice either over the telephone or online. We also have a tutorial to make the system easier for beginners. A professional conference facilitator helps everyone participate actively, and a monthly user's guide provides technical tips and research articles more suitable for hard copy. Nearly all users who initially selected a 60-day trial membership have converted subsequently to a full year.

In the future, we hope to expand this form of electronic communication by publishing other journals and newsletters for those who need to keep up on what is happening in their field now, not three months from now. Also, because of this system's low cost in comparison with on-site meetings or video conferencing, it would probably be useful for maintaining contact between various divisions or field offices in a corporation. Or it could be used for conducting

training seminars without disrupting anyone's work schedule or straining a limited travel budget. All in all, computer conferencing should have a fairly significant impact not only on the way we gather information, but also on the way we work. ■

#### Accessing the IIF

*The Independent Investors Forum can be accessed by any microcomputer or terminal equipped with a modem and an appropriate communications software package such as ASCII Express "The Professional" from Southwestern Data Systems (POB 582, Santee, CA 92071; (714) 562-3670) or Crosstalk from Microstuf Inc. (1845 The Exchange, Suite 140, Atlanta, GA 30339; (404) 952-0267). Communication is available at either 300 or 1200 bits per second. A one-year membership in IIF costs \$300, plus telephone connect charges (\$19 per hour, average). A 60-day trial membership costs \$125 and includes 3¼ hours connect time. Membership and telephone charges may be tax-deductible as investment expenses.*

Circle 468 on inquiry card.

## Introducing automatic dialing, 300/1200 baud for \$599\*

- 300/1200 Baud—Bell 103/113/212 compatible
- Auto Dial—compatible, Hayes dialing protocol
- Full or Half duplex
- Audio Monitor signals busy line, no-answer, etc.
- Two year limited warranty

Our newest modem does all this with 3 LSI chips—about one seventh of the usual integrated circuits. Its simplicity, an achievement of advanced microprocessor design, promises two major benefits. The first is outstanding reliability—that stands to reason. The second is a cost low enough to inspire skepticism. Be skeptical: shrewd comparisons may save you \$100 or more.

Intelligent design also makes this modem uncommonly easy to use. Lights and switches let you test and correct installations without technical experience—including some that require special interfaces or rewiring with most modems.

The shrewd modem. If it's not at your dealer's yet, write or call for complete specifications.

\*Suggested list for model 212A Auto Dial.



**U.S. ROBOTICS INC.**  
1123 WEST WASHINGTON BOULEVARD  
CHICAGO, ILLINOIS 60607 (312) 733-0497





# SOFTKITS

Softkits contain complete, ready-to-run programs. The programs are modular, menu-driven and written in BASIC. They come fully-documented with listings, theory, equations and operating instructions. Use them as-is or modify and combine for custom applications. Softkit disks are copyable.

## Graphic Software for Micros

This complete graphics self-teaching guide will show you how to write your own 2 and 3 dimensional graphics software quickly and easily.

Contains 61 programs arranged in a tutorial manner. Learn how to create 2D and 3D shapes, translate, rotate, scale, stretch, clip, remove hidden lines, shade, create perspective views, calculate and plot surface intersections, and produce animations effects. Applications to science, education and business.

Math level is kept to a minimum and new concept are explained as they are used.

Named "The Best Book on Microcomputer Graphics" by Creative Computing magazine.

□ Manual with Disk(Apple) or Tape(TRS-80 Color Computer): \$45

## Data Plotting Software for Micros

This softkit contains a system of 18 complete programs which process and display data: pie charts, bar charts, stock market charts, histograms, 3D views of surfaces, log plots, curve fitting, data management, histograms and statistical analysis.

Programs are modular, menu driven, written in BASIC, fully explained and keyed to theory. They are listed in the book alongside theory and equations. Use as-is or modify to best suit your own applications.

Four data base management programs are included. These create x, x-y, x-y-z and stock market data files and store them on disk. Plotting programs read the data files and carry out sorting, statistical analyses and plot results.

Features include automatic scaling, axis marking and numbering, auto replot when data changes, and a special program called LABELER which places text and symbols over graphics using a moving cursor.

□ Manual with Disk(Apple or IBMpc) or Tape(TRS-80 Color Computer): \$48

## Engineering Software for Micros

This softkit contains 25 fully-documented programs for computer-aided design and analysis on micros. They will show you how to write modern CAD software or they can be used as-is for professional engineering work.

Emphasis is on combining computer graphics with engineering problem solving. Programs are included to interactively create engineering drawings, store them on disk, recall, update, merge, add physical properties such as resistance, thermal capacity and density, and rotate in 3 dimensions to produce isometric views.

After being stored on disk, the drawings are recalled by applications programs which perform mechanisms simulation, heat transfer, matrix operations and optimization using Monte Carlo techniques. Programs are also included for Fourier Series and Transforms. These graphically display spectra alongside waveforms.

All programs are menu driven, written in BASIC and fully documented and keyed to theory and equations.

□ Manual with Disk(Apple or IBM): \$48

## IBMpc Graphics

This softkit is a self-teaching guide that will show you how to write your own 2 and 3 dimensional graphics software on the IBMpc, quickly and easily.

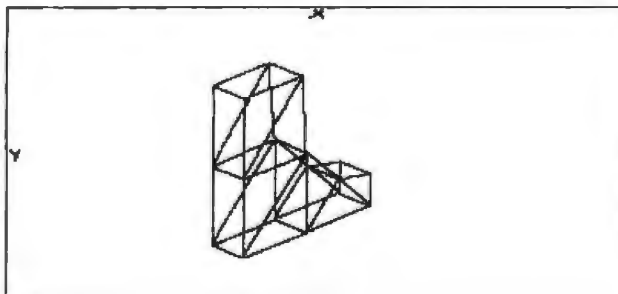
Learn how to create 2D and 3D shapes, translate, rotate, scale, stretch, clip, remove hidden lines, shade, create perspective views, calculate and plot surface intersections, produce animations effects, store graphics on disk.

Applications to science, education and business included. Also covers hardware needed for PC graphics, use of the PC's special graphics enhancements, and how to separate text from graphic on the PC's screen.

Contains 61 programs arranged in a tutorial manner leading from one step to the next. Math level is kept to a minimum and new concept are explained as they are used.

Much of this softkit is based on the popular *Graphic Software for Microcomputers* by B.J. Korites which was named "The Best Book on Microcomputer Graphics" by Creative Computing magazine.

□ Manual with Disk(IBMpc): \$45



## Structural Analysis Software for Micros

These 11 programs will enable you to carry out sophisticated structural analyses on your micro. They are modular, fully documented and ready to run.

You will be able to create a finite element mesh on the screen, rotate it in 3 dimensions, and store it on disk. Then recall the mesh from disk, recall a file of material properties and carry out a 3d truss or frame analysis. Shape of a deflected truss may be plotted over the original shape.

Other programs analyze trusses with large deflections and non-linear material properties. These use an incremental solution strategy. Also included are programs which calculate combined stresses and properties of beam cross sections.

Analyses use the modern "direct stiffness" method.

This system of programs is patterned after large-computer structural analysis systems such as ADINA and SAPP, but reduced in scale for micros. They were written by B. J. Korites, PhD, former CAD/CAM consultant to the Arthur D. Little Company.

□ Manual with Disk(Apple or IBMpc): \$85

To order, send check drawn on US bank, money order in US funds, Visa or Mastercard number with expiration date to KERN PUBLICATIONS, 190 Duck Hill Road, P.O. Box 1029B, Duxbury, Massachusetts 02332. Add \$2 per book 4th class postage in US and Canada, \$4 1st class or UPS in US; \$4.50 1st class Canada; \$12 air Europe and Central America; \$18 air elsewhere.

Call (617)934-0445 for faster delivery.

**KERN**  
PUBLICATIONS



# OUR PRICES, SELECTION AND SAME-DAY SHIPPING MAKE US COMPETITIVE.

## Red Baron. Home of the Nation's

### NEC 8023/DMP-85

Outstanding Graphics, Print Quality & Performance



144 x 160 dots/inch • Proportional spacing • Lower case descenders • N x 9 dot matrix • 8 character sizes • 5 unique alphabets • Greek character set • Graphic symbols • 100 CPS print speed • Bi-directional, logic-seeking • Adjustable tractors • Single-sheet friction feed • Vertical & horizontal tabbing

**\$Call**

### IDS Prism 80/132

Affordable Color, Speed



200 CPS • Bi-directional, logic-seeking • 24 x 9 dot matrix • Lowercase descenders • 8 character sizes • 80-132 columns • Proportional spacing • Text justification • Optional color and dot resolution graphics

Prism 80 . . . . . Base List \$1,299 **\$Call**  
Prism 132 . . . . . Base List \$1,499 **\$Call**

### The Epson Series

High-Quality Printers at a Low Price.



160 CPS • Dot graphics • Proportional spacing • Downloadable character sets • 10 and 12 CPI • Super/subscripting • Underlining • Reverse line feed

Epson FX series . . . . . **\$Call**

Full Line of Epson Accessories

### Smith-Corona TP-1

Daisy Wheel Printer For Under \$900



Letter quality • Standard serial or parallel data interface • Drop-in ribbon • 144 WPM • Various fonts available • Loads paper like typewriter • Handles single sheets for forms

Smith-Corona TP-1 . . . . . List \$895 **\$Call**

### Brothers HR-1 Daisy Wheel

Perfect for quality, quiet word processing.



• 16 CPS • Prints up to 6 copies • Bi-directional • Cloth or carbon quick-change cassette ribbon • Quiet, efficient operation for word processing

Brothers HR-1  
Parallel . . . . . List \$1,100 **\$Call**  
Serial . . . . . List \$1,200 **\$Call**

### Star Micronics Gemini 10/15



120 x 144 dot graphics • 100 CPS • 2.3K buffer • 2K User programmable ROM • Underlining • Super/subscripts • Friction feed and adjustable tractors

Gemini 10 . . . . .  
Gemini 15 . . . . .

**Lowest Priced Dot Matrix**

### Anadex Silent Scribe

The Quiet Serial Matrix Printer



Up to 500 CPS • Dot addressable graphics • Parallel and serial interfaces standard • Switch selectable protocol • Cartridge ribbon • Foreign character sets • Underlining • 1.5k to 12k buffer • Correspondence quality print

	List	Discount
Anadex DP-9501A . . . . .	\$1,725	<b>\$1,325</b>
Anadex DP-9620A . . . . .	\$1,845	<b>\$1,475</b>
Anadex WP-8000 (w/Tractor) . . . . .	\$3,450	<b>\$2,900</b>

### Televideo CRT's

Price, Performance & Reliability



	List	Discount
910 . . . . .	\$ 699	<b>\$575</b>
925 . . . . .	\$ 995	<b>\$730</b>
950 . . . . .	\$1195	<b>\$945</b>
970 . . . . .	\$1495	<b>\$Call</b>

### Monitors

Crisp, Clear, Compatible



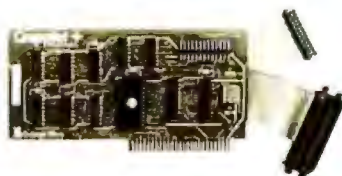
Amdex  
Video 300, green . . . . . List \$249 **\$Call**  
Color I . . . . . List \$499 **for low prices**



# OUR PEOPLE MAKE US EXPERTS.

## Largest Computer Printer Inventory.

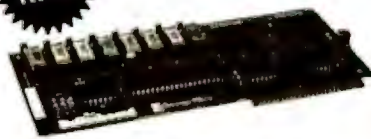
### The Grappler+™ Apple® Graphics Interface



- Graphic and text screen dumps • Dual Hi-Res Graphics • Printer selector dip switch • Apple III compatible • Inverse graphics • Emphasized graphics • Double size picture • 90° Rotation • Center graphics • Works with Pascal and CPM® • Optional bufferboard available

**Grappler + . . . . . \$175**  
\* Requires software driver  
Apple is a registered Trademark of Apple, Inc.

### The Bufferboard™ For Apples and Printers



**Take your existing printer interface—and buffer it!**

- Versions for Grappler+, Apple interface, Epson interface, and others • Comes standard with 16K buffer • Expandable to 32K and 64K • Includes interface docking cable

**The Bufferboard . . . . . \$175**

### IDS Microprism 480 Prints like a daisy, priced like a matrix!



- Correspondence quality in a single pass • Dual speed 75, 110CPS • Proportional spacing • Bi-directional, logic-seeking • Platen Pin or pressure feed • 24 x 9 dot matrix • 10, 12, 16, 8 characters per inch • Double width characters

**IDS Microprism 480 . . . .List \$799 \$Call**



### Customer Benefit Package

1. Free Expert Consultation.
2. Technical Staff. Even your most involved questions get quick, helpful answers from our staff of printer technicians.
3. Free Catalog. Get your informative catalog with printer comparison chart and print samples today.
4. Warranty. The manufacturer's warranty where applicable.
5. Same-Day Shipping.
6. Free MasterCard and Visa.
7. We Stock What We Sell. We make every effort to keep a large stock of our advertised products.
8. APO/FPO Orders Welcome.

### NEW! The Okidata Series Microline 92 & 93



- 160/200CPS • Correspondence quality • Proportional spacing • Enhanced, emphasized and expanded characters • 10, 12 and 17 pitch • Super/subscripts • Underlining • Okigraph dot graphics • Alternate downline loadable character set

**Okidata 92 . . . . .List \$ 699**  
**Okidata 93 (w/ Tractor)List \$1249**  
**Okidata 84 (Parallel) . .List \$1395 \$Call**

### Other Quality Printers at Red Baron

**NEC Spinwriter RO**  
Serial Parallel 7710 . . . . . \$3055 **\$2,425**  
Serial 3510 . . . . . \$1895 **\$1,600**  
**Toshiba P-1350 . . . . . \$2195 \$Call**

### Interface Equipment Complete Stock of Options, Cables and Accessories

**CCS APPLE SERIAL Interface & Cable . . \$150**  
**SIGNALMAN MODEM . . . . . \$Call**  
**HAYES MICROMODEM II . . . . . \$300**  
**COMPLETE STOCK OF EPSON**  
**ACCESSORIES . . . . . \$Call**  
**CUSTOM PRINTER CABLES FOR**  
Apple, Atari, IBM, TRS-80 (all models). \$Call  
**PRINTER STANDS: Large . . . . . \$ 99**  
Small . . . . . \$ 25  
**PRINTER RIBBONS—Most Types . . . . \$Call**

### Here's How To Order:

Phone orders are welcome; same-day shipment on orders placed before 11:00 a.m. Free use of MasterCard and Visa. COD's accepted. Personal checks require 2 weeks clearance. Manufacturer's warranty included on all equipment. Prices subject to revision.

### Call For Free Catalog:

**(800) 854-8275**  
**CA, AK, HI (714) 779-2779**



Circle 392 on inquiry card.

4501 E. Eisenhower Circle, Anaheim, CA 92807



## What a Concept!

### A View of the Corvus Computer

Curtis Feigel, Technical Editor

To call the Corvus Concept a microcomputer is to miss the point. The 68000-based Concept is a complete system for automating the modern office. Not merely a workstation or a personal computer (although it can be either), the Concept consists of software and hardware modules designed to work together in an office environment.

Getting personal computers to perform useful functions has always been a challenge for designers and programmers. Heretofore, we have had a variety of off-the-shelf solutions to the problems of financial planning, text editing, and communications. Until now, however, if you wanted a spreadsheet that worked with a word pro-

cessor that worked with a local-area network, you needed to buy each item separately, then modify all three so they would work together. Corvus has done this job for you by combining these functions in one easy-to-use package.

The Concept, which uses a Motorola 68000 microprocessor running at 8 MHz, comes standard with both 256K bytes of memory (expandable to 512K bytes) and an Omninet local-area-network interface. In addition to its two serial ports, the Concept has four I/O (input/output) expansion slots that accept Apple II peripheral cards. The machine features a bit-mapped video display in a full-



**Photo 1:** Two Concepts linked to a 6-megabyte hard-disk drive (center) via an Omninet local-area network. An 8-inch thin-line floppy-disk drive (right) is connected to a controller board installed in the Apple II-compatible expansion bus of the Concept on the right. The video display on the right is set up in the portrait format, almost the exact size and shape of a sheet of paper. The monitor on the left has been rotated 90 degrees for viewing in the landscape format.



NOW AVAILABLE ON THE APPLE LISA™ under XENIX

# ACCOUNTING SOFTWARE FROM OPEN SYSTEMS GETS YOU UP AND RUNNING... FAST.

Looking for on-track accounting solutions to increase your company profits? Look to the software champion...

## The SOFTWARE FITNESS PROGRAM.

Our competition can't come close. Since 1974, we've built a track record as the pacesetter supplier of comprehensive, interactive accounting solutions for more than 30,000 customers worldwide in 200 different types of businesses. Wholesalers... distributors... manufacturers... job shops... retailers... accounting firms... businesses like yours.



the industry. Our products include training disks and owner manuals that'll put even a computer novice at ease. And, whatever your accounting needs, we've got the most advanced software you can buy—one that's designed to become more powerful as your business grows.

Anyone familiar with book-keeping can get up and running with

## The SOFTWARE FITNESS PROGRAM.

We run on more than 50 of the best known computers in

**If your bottom line is your top priority, today and tomorrow, we've got solutions.** Ask for a demonstration from your local computer dealer.

**Dealer inquiries are invited.**



# OPEN SYSTEMS INC.

430 Oak Grove Minneapolis, MN 55403  
(812) 870-3515 TWX 910 576 1743

Circle 340 on Inquiry card.





## At a Glance

### Product

Corvus Concept

### Manufacturer

Corvus Systems Inc.  
2029 O'Toole Ave.  
San Jose, CA 95131  
(408) 946-7700

### Components

**Processor Unit:** 8-MHz Motorola 68000 microprocessor; 256K bytes of memory; two RS-232C serial ports; Omninet local-area network; four Apple II-compatible expansion slots  
height: 4 3/8 inches  
width: 16 7/8 inches  
depth: 15 1/8 inches  
weight: 28 lbs

**Display:** 14-inch (diagonal measure) high-resolution black-and-white video monitor; 8 1/2 by 11 1/2 viewing surface; tilt and swivel mounting on top of processor unit; monitor can be rotated 90 degrees to provide either portrait (545 by 639 pixels, 63 lines of 90 characters) or landscape (707 by 479 pixels, 47 lines of 117 characters) aspect ratio  
height: 15 inches  
width: 13 1/2 inches  
depth: 14 inches  
weight: 36 lbs

**Keyboard:** standard typewriter layout with numeric keypad and 10 software-definable function keys; detached from processor unit with 9-foot coiled cord  
height: 3 3/8 inches  
width: 16 7/8 inches  
depth: 8 inches  
weight: 6 lbs

### Cost

\$4995 (\$5995 for 512K bytes of memory)

### Hardware Options

**Hard-Disk Drive:** choice of 6-, 10-, or 20-megabyte-capacity drives (one required); can interface to single workstation via I/O-expansion controller board or to multiple workstations via Omninet network interface  
height: 5 3/4 inches  
width: 12 inches

depth: 15 1/5 inches

weight: 18 lbs

cost: 6-megabyte \$2495

10-megabyte \$3495

20-megabyte \$4495

### Mirror Unit:

Installs between hard-disk drive and user-supplied video-cassette recorder; backup times are approximately 1.8 minutes per megabyte

height: 3 1/4 inches

width: 7 1/2 inches

depth: 13 1/8 inches

weight: 10 lbs

cost: \$790

**Floppy-Disk Drive:** Tandon thin-line 8-inch floppy-disk drive in external case that interfaces to processor via I/O-expansion controller and 50-conductor ribbon cable

height: 10 1/4 inches

width: 4 3/4 inches

depth: 16 inches

weight: 14 lbs

cost: \$1500

### Software

**Operating System:** CCOS (Corvus Concept Operating System), designed specifically for the Concept, accepts most commands from the keyboard's special-function keys (cost included in package price)

**Languages:** FORTRAN-77 compiler cost: \$445

Pascal compiler included with floppy-disk drive

**Applications:** EdWord text editor accepts most commands from the keyboard's special-function keys

cost: included with floppy-disk drive

LogiCalc spreadsheet program accepts most commands from the keyboard's special-function keys

cost: \$195

CP/M emulator imitates Intel 8080 microprocessor running CP/M; allows mass storage on hard disk and is capable of accessing IBM 3740-format single-density 8-inch floppy disks

cost: \$295

page format. It also includes a detached keyboard whose 10 function keys match the software-generated menus. Thin-line 8-inch floppy-disk drives are available. A required hard-disk subsystem and optional companion video-tape interface can connect to the unit or to the Omninet network for access by more than one Concept (see photo 1).

Because the 68000 microprocessor is relatively new and independent vendor software for the Concept is far from abundant, Corvus supplies two of the most important programs: the LogiCalc spreadsheet program and the EdWord word processor. The company also provides two

high-level languages, Pascal and FORTRAN, as well as a CP/M emulator.

## The Workstation Approach

Its designers intended the Concept to be an individual workstation operating within a local-area network. With this arrangement, each user receives the full resources of a computer, but can also share both information and peripheral devices. The networked computer offers some attractive cost advantages and allows several people to work simultaneously on the same task.



# KEY TRONIC POLISHES THE APPLE II\* KEYBOARD



Eleven Function Keys  
Streamline Multiple  
Key Operations

Full Shifting Capability

Keys in Familiar  
Typewriter Locations

Numeric Pad

10 Foot Cable  
For Portability

Enhance your APPLE II\* Computer System with a Key Tronic keyboard peripheral. This detached, low-profile keyboard is plug-compatible with the existing keyboard socket of the Apple II. It also features reliable microprocessor electronics, solid-state capacitance switches, and positive tactile feedback.

Come see us at NCC, Booth #W6270.

Price: \$298.00, includes shipping & handling.  
To Order Model KB-200 Call Toll Free  
1-800-262-6006 (8am-4pm Pacific Standard Time).  
Warranty information may be obtained, free of  
charge, by writing to the address below.



**key tronic**

THE RESPONSIVE KEYBOARD COMPANY

DEPT. E1 • P.O. BOX 14687 • SPOKANE, WASHINGTON 99214 USA

\*Apple II is a registered trademark of Apple Computer, Inc.

## AUTHORIZED DISTRIBUTORS:

CJ SALES  
San Francisco, CA, (415) 941-6892  
DIGITAL ENTRY SYSTEMS, INC.  
Boston, MA, (617) 899-6111  
COMPUTER-MATE, INC.  
Dallas, TX, (214) 669-9370

COMPONENTS UNLIMITED  
Lynchburg, VA, (804) 237-6286  
J C SALES COMPANY  
Los Angeles, CA, (213) 340-6136  
SSE PRODUCTS, INC.  
Elmont, NY, (516) 872-9001  
PERIPHERAL SUPPORT, INC.  
Chicago, IL, (312) 593-5900

## CANADA: FUTURE ELECTRONICS, INC.

Montreal, Quebec (514) 694-7716  
Ottawa, Ontario (613) 820-8313  
Toronto, Ontario (416) 663-5563  
Calgary, Alberta (403) 259-6408  
Vancouver, B.C. (604) 438-5545





Photo 2: The keyboard features 10 function keys (F1 through F10) above the standard QWERTY layout.



Photo 3: The character editor allows the user to customize and redesign the displayed characters.

A second feature of the Concept workstation is the absence of individual mass storage. Whenever a system must process large amounts of data, hard-disk drives are a necessity. Because these drives are expensive, providing one for each user can be too costly. For this reason, the Concept allows several users to share a single hard disk.

Corvus also realizes that the office market contains many potential users who know little about using computers. All the bundled software programs—including the operating system, spreadsheet, and text editor—focus on people who want to use a computer with their work, but who don't want to solve puzzles to make that happen. In fact, the software menus make it possible for a computer novice to use either the spreadsheet or text editor with less than an hour of tutoring.

### Fingers and Keys

The Concept detachable keyboard has 91 keys in a standard typewriter layout with additional function keys and a calculator pad. In addition to the standard features, you get three keys labeled Fast, Alternate, and Command. Although any key will automatically repeat when held down for more than one-half second, pressing the Fast key simultaneously increases the repetition rate. The Alternate key works like the Control key in special applications.

Across the top of the keyboard are the special-function keys, arranged in two groups of five (see photo 2). These keys correspond to menu selections appearing at the bottom of the display screen. The Command key allows you to toggle between menu selections when more than 10 functions are available for a particular application. The function keys also let you select additional menus. After a bit of practice, your speed with the function keys can become quite impressive because they make it un-

necessary for you to memorize and type a complex command. Additionally, the Concept's keyboard buffer lets you rapidly enter commands, while the machine continues to execute them in order. If you forget what a function can do, pressing the Help key and then a function key produces a description of the second key's function.

### A New Look

If the Concept's keyboard is a good idea, the video display is an amazing one. It sits atop the processor cabinet secured by a swivel joint that lets you tilt and pivot it as you wish. In its vertical position, which is great for text editing, the screen contains 90 columns by 63 lines in a display about the size of a sheet of notebook paper. You can also unlock the display, rotate it 90 degrees, and secure it in the holder to get a display of 117 columns by 47 lines, which works well with the spreadsheet. Besides the option of two display modes, the Concept offers both white-on-black and black-on-white characters. You have a choice of supplied type fonts and can also create your own character sets. A large blank matrix lets you redefine characters using a process similar to painting (see photo 3).

The video display also divides into windows or rectangles of user-defined ratio and size. Each window becomes an independent display area with its own attributes, providing the user with a powerful and convenient feature. In a window you can show text in any font, display black or white characters, and scroll the text independently of the rest of the display. For example, you could use EdWord to write a report while creating a separate window of information from a LogiCalc model.

### Under the Hood

Considering all the functions that the Concept provides, the hardware formula is simple: combine the



# CONGRATULATIONS.

## YOUR VISICALC™ JUST DOUBLED IN VALUE.

**New Super Expander Plus™ pre-boot  
for Ramex-128™ board upgrades any  
Apple II™ 16-sector VisiCalc™ to look  
like the Advanced Version.**

SUPER EXPANDER PLUS keeps all your existing VisiCalc facilities, and adds variable column width, global formatting of numbers, negative numbers in brackets, password protection, new format commands, tabbed fields, the works. It even supports an 80-column card if one is present.

If 136K is enough, you can get all these features with just one Ramex-128 board. But SUPER EXPANDER PLUS supports two Ramex-128K cards to give you an incredible 255K VisiCalc File, and dumps the whole model back and forth to floppies in less than 40 seconds.

There's simply no other memory-expansion/software combination



# SUPER EXPANDER PLUS™

that even comes close. All the others give you less memory, take longer to load and save (as much as fifteen minutes longer), and cost more for what you get. You've got to see it to believe it. Quick! Call your dealer.

Ramex-128 card, just \$499.  
SUPER EXPANDER PLUS,  
just \$125.

  
OMEGA MICROWARE, INC.™

222 SO. RIVERSIDE PLAZA  
CHICAGO, IL 60606  
312-648-4844

MasterCard and Visa holders order  
toll-free 1-800-835-2246

Following our long-established Omega MicroWare policy, present Super Expander-40 and -80 owners may upgrade for the price difference only. Phone our office for details.

Apple is a registered trademark of Apple Computer, Inc. VisiCalc is a registered trademark of VisiCorp, Inc. Super Expander Plus, Ramex-128, and Omega MicroWare are trademarks of Omega MicroWare, Inc.

© 1983 Omega MicroWare, Inc.



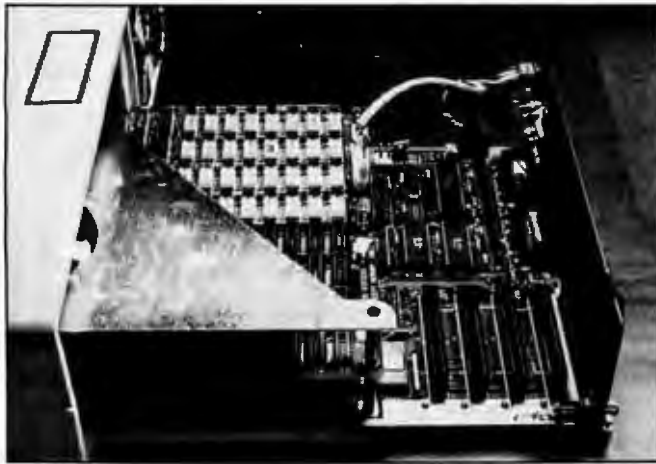


Photo 4: The drawer containing the Apple II-compatible expansion connectors.

#### Dispatcher Functions

ClrWindow	Clears the current window, leaving cursor in upper left corner
Const II	Runs the Constellation II utilities; produces its submenu
CP/M	Runs the CP/M emulator
CreWindow	Allows creation of windows on the video display
EdWord	Runs the word processor; produces its submenu
ExecFile	Executes a file of commands
FileMgr	Runs utilities for maintenance of files; produces its submenu
Help	Produces a help message for any function label
LogICalc	Runs the spreadsheet program; produces its submenu
ListVol	Lists all volumes online or names of all files on a disk volume
MountMgr	Runs utilities for mounting disk volumes; produces its submenu
Restart	Causes the system to be completely reloaded from disk
RevBackgnd	Reverses the background color of the current window
SetWindow	Assigns one window as the current window
SetVol	Used to select which volume is to be current
SystemMgr	Runs utilities for setting system attributes; produces its submenu
WindowMgr	Provides functions for setting window characteristics; produces its submenu

Table 1: The Concept's functions are accessed via a series of menus beginning with the Dispatcher level.

16/32-bit architecture of the 68000 with a large amount of RAM (random-access read/write memory). Most of the flexibility and many of the special features of this system result from this combination of power and memory. For instance, the microprocessor positions each of the screen's 350,000 pixels, which allows you a variety of display options such as windows and programmable character sets.

Access to the outside world comes from an Omninet

local-area-network interface and the capability to use Apple II peripheral cards. The Omninet network provides users with one of the best-defined network standards in the marketplace and provides the convenience of local communication and rapid data-transfer rates necessary to many business applications. By duplicating the Apple II expansion bus, the Concept can take advantage of the hundreds of expansion boards already on the market (see photo 4). In addition, Corvus did not forget the need for local I/O devices and provides two RS-232C serial ports for connection to a printer and modem.

#### Software Details

The Concept uses menu-driven software that appears to the user as a single hierarchical system. From the operating system to the lowliest editing command, all functions are menu items. At any point, your options are obvious and you can easily move to the previous or following menu. The first menu of available functions, the Dispatcher level, presents all the major software features (see table 1). This level, similar to the operating system in other computers, gives you a choice of four menus: File Manager, Window Manager, System Manager, and running programs. Selecting any of these options produces a submenu of choices, and some of those choices produce still further menus.

File Manager becomes a frequent choice because the Concept requires that you divide the hard-disk storage into separate volumes to limit information access to particular users. While the size may vary, each volume has a name and a directory, much like a floppy disk. When you

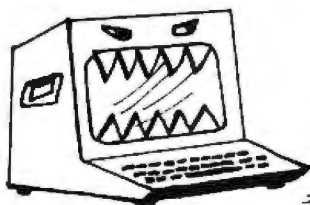
#### File Manager Functions

ClrWindow	Clears the current window, leaving cursor in upper left corner
ConcFile	Concatenates files
CreWindow	Allows creation of windows on the video display
Crunch	Reclaims unused disk space within a volume
CopyFile	Copies disk files
DletFile	Erases disk files
DletTemp	Erases a temporary disk file from a volume
Exit	Returns to previous menu
Help	Produces a help message for any function label
ListFile	Lists the contents of a text file
MakeFile	Creates a disk file
MountMgr	Runs utilities for mounting disk volumes; produces its submenu
RevBkgnd	Reverses the background color of the current window
Rnamfile	Changes the name of a disk file
SetWindow	Assigns one window as the current window
SetVol	Used to select which volume is to be current
Spool	Sends output to a temporary disk file from which it may be read and printed elsewhere on the network

Table 2: Disk-file-management functions are available through the File Manager menu.

# Thoughtware™ tames your CP/M™ system for just \$49.95

*CLIP™, our Command Line Interpretive Program, makes your system more efficient than ever before. CLIP replaces the interactive portion of CP/M with a user friendly "shell". CLIP is sophisticated enough to satisfy the entire spectrum of needs from the novice to the most expert programmer.*



## Command Files

Command sequences that you use often can be placed in a command file. From then on you'll never type the commands again, since typing the name of the file will execute the commands as if you typed them by hand. These files can ask questions and perform different tasks depending on the answers received. In addition, a special command file can begin working whenever your computer is turned on.

## All input text can be edited.

Once CLIP is in control, entry of text into ANY program can be edited as if you were using a word processor. The single keystrokes that you use to edit the text can be defined to be similar to your existing word processor. CLIP also remembers your previously entered line, and it can be retrived with only one keystroke.

## Built-in file editor

Clip contains a simple editor for editing command files, programs, or data files. English-like commands simplify any editing task.

## Automatic file searching

With file searching you can keep files that are frequently accessed in a common place. CLIP will find them when requested by a program or command file, no matter which disk or user number you are currently at. This can save precious disk and directory space.

## Help Files

Extensive on-line help is available for each of the 50+ commands in CLIP. You can also add your own help files to customize your working environment.

## Built in calculator.

CLIP has a built in 16-bit calculator with the functions: +, -, \*, /, remainder, AND, OR, XOR, and NOT. The calculator has 10 memory registers and works in any base from 2 to 16.

Circle 454 on inquiry card.

## A Unix™ like environment with I/O redirection and pipes.

With CLIP you can direct screen output from any program to a file for later viewing or printing. CLIP can also take any program's input from a file instead of the keyboard. "Pipes" force the output from one program into the input of another automatically.

## Sophisticated command language with over 50 commands.

CLIP is a state-of-the-art command language that includes:

- Conditional command execution with IF, THEN, ELSE, and ELSEIF and ENDIF commands up to 64 nested levels.
- Command files (or macros) with looping capabilities and conditional termination. Macros can use other macros. Extensive argument extraction capabilities can extract values and switch options off of a command line.
- The ability to trace command file execution.
- Commands that can OPEN, CLOSE, READ and WRITE files.
- Ten alphanumeric registers that can store command lines, filenames, file input, or anything you desire.
- Multiple commands per line.
- A copy command that can copy files between disks and user numbers.

## Buy CLIP and get 50% off our software tools. Just \$25.00!

We have a collection of 10 software tools that make difficult tasks easy.

- BC - Binary file comparison
- SC - Source file comparison
- SR - Search for a pattern in a file
- SRT - Simple in memory sorter
- DMP - Hex file dumper with ASCII
- BFE - Binary file editor
- XC - Extract columns from a file
- XW - Extract words from a file
- WC - Counts words, lines, and bytes
- HC - Horizontal file concatenate

## Also get 50% off our file encryption program. Just \$25.00.

If you have more than one person accessing your computer, then you need our file encryption program. This program won't stop the KGB, but it will stop others from seeing sensitive data. A twelve-character password gives you all the protection you need. For just \$25.00, you can't afford to be without it.

## ORDERING INFORMATION:

**Order HOT LINE: 8-5 MST  
1-800-821-6010 / (AZ 327-4305)**

CLIP \$49.95  
Tools \$49.95 (\$25.00 with CLIP)  
Encryption \$49.95 (\$25.00 with CLIP)

CLIP user's manual can be purchased separately for \$25.00

CLIP, the tools, and the file encryption program have been designed for the Z80™ microprocessor, running CP/M version 2.2. Distribution is on standard 8-inch SS/SD floppies.

Visa and Mastercard accepted.  
No COD's, please.

Send check or money order to:

**Thoughtware, Inc.**  
P.O. Box 41436  
Tucson, AZ 85717

Please add \$3.50 shipping for all orders.  
AZ residents please add 6% sales tax.  
Prices are subject to change.

CP/M - TM Digital Research, Unix - TM Bell Labs, Z80 - TM Zilog Inc. Thoughtware and CLIP - TM of Thoughtware Inc.

# Thoughtware



# PC-1 Powerline Controller

Puts Bidirectional A.C.  
carrier communications  
in your APPLE II

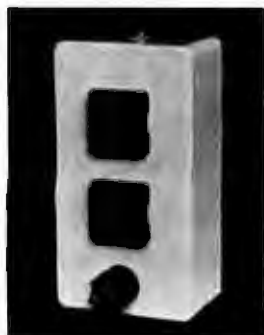
- Operates up to 256 Leviton/BSR remote control devices
- Receives input communications from Leviton/BSR transmitters
- On board real time clock
- Worldwide compatibility (50/60 Hz)
- Easy installation and operation

PC-1 is available for \$285.00  
Dealer inquiries invited



**BI-COMM SYSTEMS**

10 Warkon Industrial Court, Saint Paul, MN 55117 (612) 481-0775



## Protect your computer against Voltage Surge

Protect your computer system from damage or disruption from sudden spurts of excess voltage—from lightning or flickering fluorescent lights. This Voltage Surge Protector plugs into any wall outlet. Dissipates up to 600,000 watts. Prevents downtime, lost data, circuit damage, service calls. You save valuable time and money. And Pryor Corporation guarantees your satisfaction.

### **PRYOR** Computer Supplies Catalog

PHONE TOLL FREE 800-558-6866, or send coupon

Pryor Catalog Sales Corporation  
8785 North Port Washington Road  
P.O. Box 17829, Milwaukee, Wisconsin 53217

BT 583

Send \_\_\_\_\_ Voltage Surge Protectors (two outlet) Order No. 526-105 at \$89.50 ea.

Check enclosed  Bill me Total \$ \_\_\_\_\_

Send a FREE copy of the Pryor Computer and Word Processing Supplies Catalog

Name \_\_\_\_\_

Company \_\_\_\_\_

Address \_\_\_\_\_

City \_\_\_\_\_ State \_\_\_\_\_ Zip \_\_\_\_\_

Phone \_\_\_\_\_ Signature \_\_\_\_\_

#### Window Manager Functions

ClrWindow	Clears the current window, leaving cursor in upper left corner
CreWindow	Allows creation of windows on the video display
DelWindow	Deletes the current window
Exit	Returns to previous menu
Help	Produces a help message for any function label
LdDispCh	Loads character set and assigns to display
LdKybdCh	Loads character set and assigns to keyboard
RevBkgnd	Reverses background color of current window
ScrlMode	Allows text to be scrolled by line or page
SetWindow	Assigns one window as the current window
TestPrtn	Displays test pattern on screen

#### System Manager Functions

AsgnDrv	Assigns a peripheral driver to a logical device
DrvVran	Displays attributes of currently available drivers
EdChrSet	Allows user to create or alter character sets
Exit	Returns to previous menu
Help	Produces a help message for any function label
SetDate	Sets the system calendar
SetPrntr	Assigns printer characteristics
SetTime	Sets the system clock

**Table 3:** The Window Manager and System Manager menus allow you to choose from a variety of functions.

turn on the Concept, your current or active volume is System (named /CCSYS), and you use the File Manager option to make any other volume your current volume (see table 2).

Using the Window Manager option, you can create, manipulate, and display up to 17 windows on the Concept's screen. The user moves, clears, scrolls, and deletes windows, which are limited only by their rectangular shape and their need to fit within the Concept's display. Various utility programs available from the System Manager menu allow you to select the I/O drivers, specify printing parameters, and edit the character set. In addition, other utilities let you format floppy disks, automatically load a floppy disk, and execute a printer spooler. The Concept's printer spooler lets you send output to a special volume named /PIPES, and when the network's printer is available, that stored output is printed (see table 3).

When you decide to run a program, the EdWord text editor may be your first stop. If it weren't for its Undo and Redo features, EdWord would be just another unremarkable text editor (see photo 5). The service provided by this combination of features is essentially a "flight recording" of your editing progress. If you blunder and delete a hefty section of an important report, the Undo feature restores the text to its preedited condition.

# Introducing The Pied Piper™



## The Portable Computer that leads your business exactly where you want to go...

Meet The Pied Piper and enjoy the convenience of the office wherever you go. Do your work wherever you are. Send documents back to the office over the phone.

The Pied Piper is completely portable, about the size of a slim briefcase, and weighs only 12½ lbs.

But it is loaded with features. The Pied Piper is faster and has twice the data storage capacity of much larger personal computers.

With the Pied Piper you have superb word processing capability with spelling checker. Spreadsheets for business projections. Data base management.

Everything you could want.

And its astonishingly low cost includes the most advanced business software programs—worth \$1700 if purchased at regular retail prices.

The Pied Piper comes with CP/M\*, plus its own unique



set of CP/M-compatible utilities. It has a standard typewriter keyboard and full 80-column display capability. It organizes mass mailings, creates invoices, prints labels, writes standard or "boilerplate" letters from the file.

The Pied Piper lets you talk to data banks, e.g. Dow Jones News/Retrieval\* or The Source, or your own corporate computer and database system.

Try The Pied Piper. If your computer store doesn't have it, call us and we'll send you the name of your nearest dealer.

In California call toll free: 800 772-3545, ext. 576; elsewhere call 800 227-1617, ext. 576.

**Pied Piper Specifications.** Z-80A, 4MHz, CP/M2.2, 64K, 784K mini floppy (formatted), Perfect Software, full 80x24 video format, Pied Piper Utilities, expandable, parallel port, 12½ lbs., Nationwide Xerox Warranty and Service. Options include 10Mb drive, modem, RS232C, LCD.

## for only \$1299.

## PIED PIPER

The portable computer all others will follow.

STM Electronics Corporation, 525 Middlefield Road, Suite 130 • Menlo Park, CA 94025 • (415) 326-6226

CP/M is a registered trademark of Digital Research, Inc. Dow Jones News Retrieval is a registered trademark of Dow Jones & Company, Inc.

Pied Piper is a registered trademark of STM Corporation. The Source is a service mark of Service Telecomputing Corporation, a subsidiary of The Reader's Digest Assn. Inc.



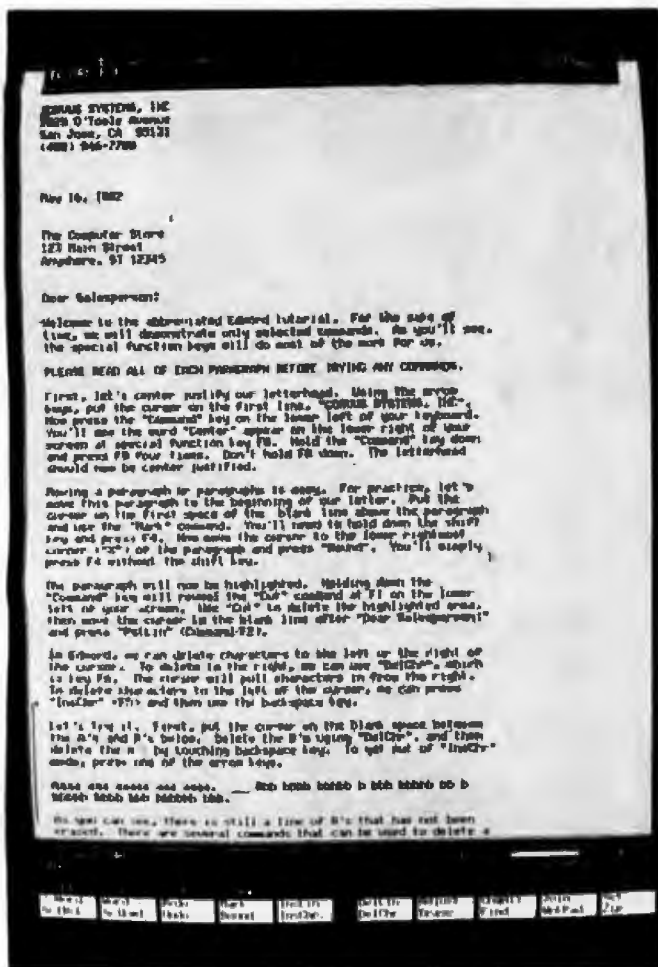


Photo 5: The EdWord text editor can display more than 60 lines of text on the screen. Note the thermometer-like workspace indicator (bottom right) and the cursor/position scale (lower left of text).

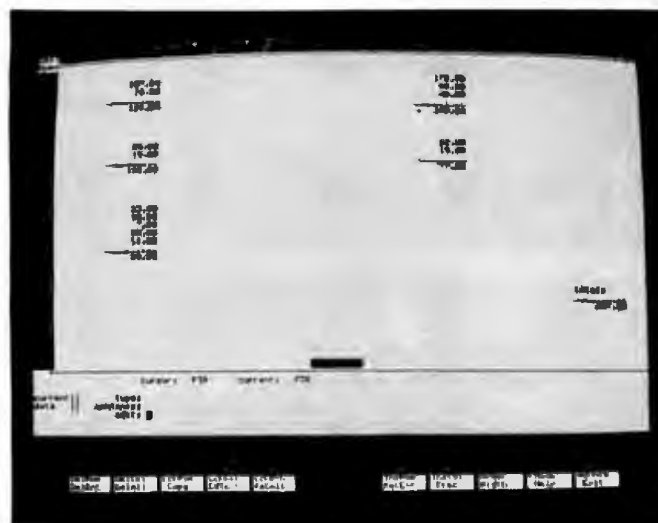


Photo 6: The LogiCalc spreadsheet. With this display, more than 400 items can be shown simultaneously.

EdWord operates solely on files residing in its workspace, a special area of a disk volume that you create. Several files or workpads must be included in this area. These workpads include the text file you are editing, a formatted print file (if you intend to print the text), files for the Undo and Redo information, copy space for your cut-and-paste operations, and a directory of this workspace. The smallest allowable workspace is 50 blocks (512 characters to a block) with the upper limit determined by the size of the volume containing the workspace.

Several important and variable editing parameters are displayed with graphics. A column rule indicating the width of the editing window tops the EdWord display. At the bottom of the screen is a thermometer-like scale that reveals the proportion of the workspace that is free. Another linear scale in the lower left of the screen displays the cursor's present position within the document being edited. In addition to these graphics representations, the system also shows the actual line number, column number, and number of lines in the text at the bottom of the display screen.

One advantage that EdWord provides over most present editors is the ability to execute system functions without exiting to the operating system. If you want a directory of available files, you simply request it from within the editor.

## LogiCalc

A chronic problem of most spreadsheet programs is the limited size of the video display. The Concept solves this problem by allowing you to rotate the monitor 90 degrees, displaying a spreadsheet with 38 lines and 10 cells of 12 characters (see photo 6). With more than 500K bytes of memory available, a LogiCalc model might contain 1000 active cells. Like EdWord, LogiCalc provides the expected functions and a few pleasant surprises. The expected functions involve cursor control and data entry. The surprises are more sophisticated, presenting the user with a calculator, linear-regression functions, formatting commands, averaging and summation functions, and even user-definable functions. Although these are not unheard of in spreadsheets, it's rare to find them all in one program (see table 4).

## Development Tools

Even with a text editor and spreadsheet, an obvious lack of business-applications software still limits the Concept. In particular, database-management programs and graphics and accounting packages will be necessary before this machine can take an active role in the office. Corvus is taking steps to encourage the development of more software by providing Pascal, FORTRAN-77, a 68000 assembler, and a CP/M emulator. It is hoped that this step will promote program development by software houses.

Corvus Pascal, developed by Silicon Valley Software, is compatible with the ISO (International Organization for Standardization) Level 0 standard and provides most

# TIMEX MAKES THE COMPUTER, BUT WE MAKE IT TICK.

If you own a TS-1000 or ZX-81 computer and want to bring out the power within it, you'll want Memotech. From easier input to high quality output and greater memory, Memotech makes the add-ons you demand. Every Memotech peripheral comes in a black anodized aluminum case and is designed to fit together in "piggy back" fashion enabling you to continue to add on and still keep an integrated system look.



**MEMOPAK RAM** All Memopak RAMs are directly addressable, user transparent, are neither switched nor paged and no additional power supply is required. You can also choose the Memopak RAM which is just right for your needs. From economy to power. **16K RAM** The Memopak 16K RAM is the most economical way to add memory to your TS-1000. It is fully compatible with the Timex or Memotech 16K RAMs to provide you with up to 32K of RAM. The 16K RAM also offers additional add-on capabilities through its "piggy back" connection. **32K RAM** The 32K Memopak enables you to execute sophisticated programs and store large data bases and like the 16K RAM is fully compatible with Timex's or Memotech's 16K RAMs to give you a full 48K of RAM. **64K RAM** The 64K Memopak is powerful enough to turn your TS-1000 into a computer with capabilities suitable for business and educational use. It accepts such BASIC commands as 10 DIM A (9000). **MEMOCALC** Memocalc, our spreadsheet analysis

software, enables TS-1000 users to perform complex number crunching routines with ease. With the 64K RAM a table of up to 7000 numbers with up to 250 rows or 99 columns can be specified. Quick revisions can be achieved by entering new data to your formula.

**MEMOTECH KEYBOARD** For ease of operation, the Memotech keyboard is a high quality standard typewriter keyboard, with TS-1000 legends. The keyboard is cable connected to a buffered interface which is housed in a standard Memopak case and plugs directly into the back of the



TS-1000 or other Memopaks. **MEMOPAK HRG** The Memopak High Resolution Graphics, with up to 192 by 248 pixel resolution, enables display of high resolution "arcade game" style graphics through its resident 2K EPROM, programmed with a full range of graphics subroutines.

### CENTRONICS PARALLEL AND RS232 INTERFACES

Memotech's Interfaces enable your TS-1000 to use a wide range of compatible printers. The resident software in the units gives the

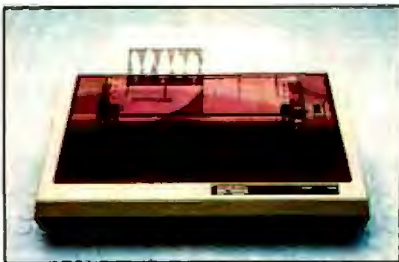
complete ASCII set of characters. Both Memopak Interfaces provide lower case character capabilities and up to 80 column printing. The RS232 Interface is also compatible with modems and terminals.

**SEIKOSHA GP 100A PRINTER** The Seikosha GP 100A uses a 5x7 dot matrix printing format with ASCII standard upper and lower case character set. Printing speed is 30 characters/second with a maximum width of 80 characters. The printer uses standard fanfold paper up to 9-1/2 inches wide. The GP 100A is offered as a package including cable and



interface. Other printer packages are also available through Memotech.

**ORDER AT NO RISK.** All Memotech products carry our 10 day money back guarantee. If you're not completely satisfied, return it within ten days and we will give you a full refund. And every Memotech product comes with a six month warranty. Should anything be defective with your Memotech product, return it to us and we will repair or replace it free of charge. Dealer inquiries welcome. To order any Memotech product use the order coupon or call our toll-free number **800/662-0949.**



TS-1000 is a registered trademark of Timex Corp.

**MEMOTECH**  
CORPORATION

7550 West Yale Avenue, Denver, Colorado 80227, 303/986-1516, TWX 910-320-2917

Mail To: Memotech Corporation, 7550 West Yale Ave., Denver, CO 80227			
Code	Price*	Qty.	Total
16K RAM	\$ 49.95		
32K RAM	99.95		
64K RAM	149.95		
Memocalc	49.95		
Keyboard with Interface	99.95		
High Resolution Graphics	99.95		
Centronics Parallel Interface	74.95		
RS232 Interface	99.95		
Printer Cable	19.95		
GP 100A Printer Package**	399.00		
Shipping and Handling	4.95		\$ 4.95
Tax (Colorado residents only)			
TOTAL			\$

\*All prices quoted in U.S. dollars. Prices and specifications subject to change without notice.  
\*\*Please add an additional \$5.00 for printer shipping charges.

Check  MasterCard  Visa

Account No \_\_\_\_\_ Exp. \_\_\_\_\_

Name \_\_\_\_\_ Phone number \_\_\_\_\_

Address \_\_\_\_\_

City \_\_\_\_\_ State \_\_\_\_\_ Zip \_\_\_\_\_



### LogiCalc Functions

Advance	Automatic cursor advance during text entry
ACalc	Automatic recalculation of whole spreadsheet whenever an item is entered
Aform	Begins text entry on a predefined form template
Copy	Copies series of entries to another part of the sheet
DelAll	Erases every entry
DelCol	Erases a whole column
DelEnt	Erases a single entry
DelRow	Erases a whole row
EdText	Allows editing of items on the entry line
Exit	Returns to previous menu
FMode	Selects form mode
Go To	Moves cursor to a specific entry
Help	Produces a help message for any function label
InsCol	Inserts a new column into the array
InsRow	Inserts a new row into the array
LckBth	Allows simultaneous viewing of two parts of the sheet
LckCol	Allows simultaneous viewing of two parts of the sheet
LckRow	Allows simultaneous viewing of two parts of the sheet
Load	Reads a disk file into the array
LstVol	Lists all files of a volume
Merge	Overlays a disk file onto the current array
MovArr	Positions the cursor at the top left entry
NxtRow	Moves cursor to first item of next row
Order	Changes the order in which the array is evaluated
Prec	Sets the number of decimal places to be displayed at any entry
Print	Prints copy of spreadsheet
ReCAL	Recalculates results at every position
ReCEnt	Recalculates results at one position
Save	Writes array to a disk file
Space	Displays space available
Where?	Gives coordinates of cursor position
Width	Sets cell width

**Table 4:** The LogiCalc functions include all the expected ones plus a few surprises.

UCSD features as extensions. A run-time library provides a source of relocatable support code. Any compiled Pascal source file must be linked with this library before the system produces executable 68000 object code. The same developer provides the FORTRAN-77 compiler that conforms to the ANSI (American National Standards Institute) standard. As with the Pascal, this compiler's output must be linked to a run-time library before execution.

The Corvus ASM68K assembler is quite similar to Motorola's specifications syntax for 68000 assemblers, and its output is also relocatable object code that must be linked to a run-time library. The CP/M emulator makes the Concept actually emulate the registers and instructions of an Intel 8080 microprocessor. Programs written for the 8080 can thus be transferred and run on the Concept. Obviously, for anyone who has already invested in 8080 software, this feature is important. Unfortunately, because Corvus doesn't emulate instructions for Zilog's Z80 microprocessor, Z80 specific code will not run under the CP/M emulator.

All the built-in CP/M commands are available, as well as the transient commands: ASM, DDT, DUMP, ED, LOAD, PIP, STAT, SUBMIT, SYSGEN, and XSUB. Because of the software overhead, however, the emulator runs slower than the average CP/M system. In the emulation mode, the Concept provides access to as large a quantity of hard-disk storage space as the user wants. In fact, you can assign 16 CP/M logical-disk drives to the mass-storage volumes. By adding the optional 8-inch floppy-disk drive, the Concept can also read standard IBM 3740-format single-density disks. When you use the emulator, the screen and keyboard appear to CP/M as a Lear Siegler ADM 3A video terminal.

### Documentation

Bluntly, the lack of documentation for the Concept is a tragedy. While some manuals are available, they don't begin to cover what you need to know to set up an office-automation system, and the Corvus Concept definitely falls into that category. The only saving grace is that Corvus worked very hard to ensure that users won't need to refer to the manuals during day-to-day operations. The manuals supplied with the system are listed in table 5. Most of the ones we received were readable, but they were also stamped "Preliminary" and all contained errors and confusing passages.

Conspicuous by its absence is an introductory manual providing an overall view of the Concept. The user needs to know what to expect from this system, how to set it up, and something about the philosophy behind the system design. Although installing the system and getting it to run required only that we make simple connections and follow straightforward procedures, everything had to be done in the right order—which was not always obvious. After a dozen phone calls during a four-week period, we finally got our two workstations and the hard-disk drive with a video-cassette-recorder backup communicating over the network.

Considering that the Concept is aimed at the business market, Corvus should make the installation as fast and painless as possible. A big step in that direction would be an improved set of manuals. The current materials are primarily a set of dry references for the applications software packaged in impressive suede-cloth binders. Still lacking are tutorials for the novice, quick-reference cards for the advanced user, and some nitty-gritty technical manuals on the software and the circuitry. With support materials like these, independent consultants and data-processing managers would have no qualms about recommending this system to clients, and third-party developers could provide much-needed software and add-on boards.

### Performance

While user-friendliness is an important consideration, the Concept must also be able to work for a living. The machine's particular combination of features—graphics potential, powerful processor, large memory, FOR-

# SuperSoft FORTRAN

## Now for CP/M-86®, MS DOS, and IBM PC DOS®

SuperSoft FORTRAN is the answer to the growing need for a high quality FORTRAN compiler running under CP/M-86 and IBM PC DOS. It has major advantages over other FORTRAN compilers for the 8086. For example, consider the benchmark program used to test the IBM FORTRAN in InfoWorld, p. 44, Oct. 25, 1982. (While the differential listed will not be the same for all benchmark programs, we feel it is a good indication of the quality of our compiler.) Results are as follows:

**IBM FORTRAN:** 38.0 Seconds

**SuperSoft FORTRAN:** 2.8 Seconds

In its first release SuperSoft FORTRAN offers the following outstanding features:

1. Full ANSI 66 standard FORTRAN with important extensions
2. Standard data types, double precision, varying string length, complex numbers
3. Free format input and free format string output
4. Compact object code and run time support
5. Special functions include string functions, dynamic allocation, time/date, and video access
6. Debug support: subscript checking, good runtime messages
7. Full IEEE floating point
8. Full 8087 support—available as option (\$50.00).

#### Program developers:

SuperSoft's family of FORTRAN compilers means you can write your programs once and they will run under CP/M-80, CP/M-86, and MS DOS. This lets you get your applications running fast no matter what the environment.

The current compiler allows 64K code space and 64K data space with expansion anticipated in future releases.



"At last, a FORTRAN compiler that works great on my 8086, 8087, and 8088 based systems!"

### SuperSoft FORTRAN: available NOW and working great!

Requires: 128K with CP/M-86® and MS DOS

Price: \$425 (in each environment)  
CP/M-80 version also available.

In conjunction with SuperSoft, SuperSoft FORTRAN was developed by Small Systems Services, Urbana, IL, a leader in FORTRAN development.

CP/M and CP/M-86 are registered trademarks of Digital Research.

**Japanese Distributor:** ASR Corporation International, 3-23-8, Nishi-Shimbashi, Minato-Ku, Tokyo 105, Japan. Tel. (03)-437571 Telex: 0242-2723.

**European Agent:** Micro Technology Ltd., 51 The Pantiles, Tunbridge Wells, Kent, England TN2 5TH TEL 0892-45433. Telex: 95441 Micro-G.

Circle 431 on Inquiry card.

# SuperSoft®

FIRST IN SOFTWARE TECHNOLOGY P.O. Box 1628 Champaign, IL 61820 (217) 359-2112 Telex 270365



### Outline of Corvus Manuals

Personal Workstation User Guide (120 pages)	CP/M Emulator Installation Guide (20 pages)
System Start-up	Installing CP/M
Keyboard and Display	CP/M on the Concept
Operating System	Technical Notes
Utilities	
Peripheral Connections	FORTRAN Language Reference Manual (171 pages)
Omninet Disk Installation Guide (41 pages)	Introduction
Hardware and Software Required	Lines, Statements, and Control Flow
Hardware Setup	Data Types and Constants
Booting from Disk	FORTRAN Names, Arrays, and Substrings
Firmware Update	Expressions
Disk Initialization	Specifications Statements
Booting from the Network	Data Initialization
Copying System Files to Hard Disk	Assignment Statements
Operating System Reference Manual	Control Statements
File System and Volumes	FORTRAN Input and Output
Operating System Interface	Units
Utility Software	Format Specifications
Software Development Tools	Program and Subprogram Structure
Linker and Librarian	Using the FORTRAN Compiler
Drivers	
LogiCalc Glossary (142 pages)	Pascal Reference Manual
Function Key Labels	Introduction
The System Functions	Defining Data Types
The Calculator Functions	Declaring and Referencing Variables
The Linear-Regression Functions	Expressions
The Slash Commands	Statements
Miscellaneous Functions	Input and Output
The User-Defined Functions	Program Structure
Conditional Expressions	Standard Procedures and Functions
EdWord User Guide (133 pages)	Running the Pascal Compiler
Overview	Pascal Language Syntax
The EdWord Workspace	Relationship to Other Versions
Making a TXT Workpad	Data Representations
Basic Editing	
Formatting Text	ASMK68 Assembler Reference Manual (82 pages)
Printing a Workpad	Introduction
Dot Commands and Codes	Layout of an Assembler Program
Search and Replace	Operand Information
Cut and Paste	Assembler Directives
	Assembler Operation Codes
	Using the Assembler
	Assembler Output and Messages

Table 5: Outline of manuals available for the Concept and its attendant software.

TRAN, and Pascal—makes it attractive to scientists and designers, as well as to the business community. To determine a performance rating of the Concept in a time-sensitive environment, we compiled the Pascal version of Jim Gilbreath's prime Sieve benchmark (see "Eratosthenes Revisited: Once More through the Sieve," January 1983 BYTE, page 283). The compilation was fast, less than 8.2 seconds, with an execution time of 21.26 seconds, slower than the times of most 8-MHz 68000s running Pascal. We also compiled the FORTRAN version of the Sieve with a compilation time of 30 seconds and an execution time of 4.5 seconds—a quite respectable performance.

While multiuser systems always exhibit a loss of response time as more users come on line, this result may not occur with a distributed processing system such as the Concept and Omnet combination. In this case, the only possible waiting occurs when two users try to access the same shared resource, for instance, the hard-disk drive or a printer. We were unable to detect any difference with

either one or two active users, even when both were performing tasks involving a high level of disk I/O.

### Prices and Options

Today, the Concept does not offer many options. The basic workstation with 256K bytes of memory costs \$4995. Another \$1000 gets you an additional 256K bytes. Included with the workstation are the operating system, two serial ports, and the built-in Omnet interface. The required hard-disk drive, available from Corvus with capacities of 6, 10, and 20 megabytes, costs an additional \$2495 to \$4495. You can install the hard-disk drive in an expansion slot, if it is intended for use on a single Concept, and through the Omnet interface, if it is to be shared by more than one workstation.

The only real options are a thin-line 8-inch floppy-disk drive and the Mirror backup unit for the hard-disk drive. The floppy-disk drive, in its own enclosure, connects to an interface board installed in the workstation's expansion slot. The Mirror, which connects between the hard-



# SUPER BARGAINS

**ACE 1000 COLOR COMPUTER!** ..... List \$1545  
**SHARP COMPUTER** ..... 249



## SUPERBRAIN II

Double Density ..... 1894  
 Quad Density ..... 2274  
 Super Density SD ..... 2649  
**COMPUSTARS**  
 TO DEALERS ..... CALL & SAVE

Advanced Micro Digital S-100 Super-Quad Single Board Computer. Z80 64K RAM, Disk Controller, RS-232 ..... Only 699

**ALTOS — single and multi-user**  
 ACS-8000-15D ..... List 5990  
 Only 4699

**ATARI 400** ..... 289  
 800 ..... 655

## PRINTERS

OKIDATA 82A ..... 489  
 CENTRONICS 739-1 ..... 499  
 IDS PRISM 80 ..... 743

**EPSON MX-80 FT** ..... 547  
 MX-80 ..... 459  
 MX-100 ..... 749

ANADEx 9501A .....  
 Silent Scribe ..... 1345  
 NEC #3510 Letter Quality ..... 1623  
 C. ITOH F10 Letter Quality ..... 1399  
 Smith Corona TP-1 ..... 595

**TRAXX 5 1/4" Add-on Drives** ..... 249

Memory Merchant 16K static ..... 159  
 Central Data RAM S-100 64K ..... 299  
 Systems Group  
 RAM S-100 64K ..... 449  
 Microangelo Video Graphics ..... 715

**AMERICAN SQUARE COMPUTERS** is organizing a World Wide Association of Computer Dealers. Open a Store or Start Work Out of Your Home! We Charge NO FRANCHISE FEE! (Our Compellers charge a FRANCHISE FEE of from \$15,000.00 to \$45,000.00.) Be a Winner! Let US help YOU get started **MAKING MONEY by HELPING PEOPLE to put COMPUTERS to WORK.** Write or Phone today.

Which Computers are Best? ... Free

Insured Shipping at Low Rates.

**We Repair Computers**

**One hour free troubleshooting on business systems.**

**Full Time Graduate Technician on Duty.**



## TELEVIDEO

Televideo 910+ ..... 518  
 Televideo 925 ..... 718  
 Televideo 950 ..... 899  
 Televideo Computers ..... Call

**ADDS VIEWPOINT A-1B** ..... 469  
**ZENITH Z-19 Terminal** ..... 649  
 Z-89 48K Computer ..... 2119  
 Z-90 64K DD ..... 2399  
**ZVM-121 ZENITH Green Screen monitor** ..... 125

**INTERTUBE III or EMULATOR** ..... \$710  
**AMDEK Color Monitor** ..... \$329

**GOBBOUT COMPUPRO**  
 Super Sixteen 8085/8088 The fastest 8-16 bit computer! Runs 8 and 16 bit code! 128K Static RAM, 6MHz CPU's LIST 3440 SPECIAL 2569

**News Systems 816/A, B, and C with enclosure and drives.**  
 816/A ..... List 5495 ..... Only 4395

**SEATTLE** pure 16 bit computer is the fastest microcomputer by actual test! S-100, 128K Static RAM, 8 MHz 8086, 22 slot Mainframe  
 Model #2 ..... List 3785 Only \$3028  
 #1 as above  
 but 64K ..... List 2990 Only \$2392

**IBM PC memory made by SEATTLE.**  
 Now with "Flash Disk" ... 192K = 697  
 64K = 427

**CALIFORNIA COMPUTER 2210A**  
 List \$1995 ..... Only \$1595  
 Z80, 64K, I/O, Disk controller + CPM.  
 California main frame ..... 484

**SYSTEMS GROUP** computers run **FRIENDLY OASIS** Call ..... SAVE

**QUAY COMPUTER**  
 Two drives + CPM ..... \$1745  
 Four user MPM 208K  
 Hard Disk ..... \$5945

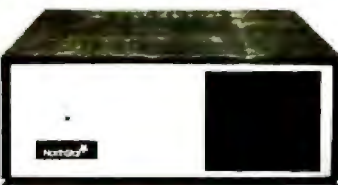
**TARBELL'S**  
 Empire I & II have two 8" disk drives  
 The I is single sided, the II is double sided.

**FREE Business Software**  
 Empire I ..... List 4888 ..... Only 3495  
 Corvus Hard Disk ..... SAVE  
 SSM Video BRD VB3 kit ..... 361  
 Spectrum Color ASM ..... 223



## NORTH STAR

**ADVANTAGE 64K Green Phosphor**  
 The Best Business Graphics, 2 Disks, Serial Port. Options CPM — Business programs ..... \$2894



**NORTH STAR Horizon**  
 Powerful North Star BASIC Free  
 Superb for Business & Science  
 Free Secretary Word Processor

Horizon Standard is now HRZ-2-64K Quad  
**Factory Assembled & Tested** ..... Only  
 Horizon-2-64K-Quad ..... \$2894  
 Horizon-1-64K-QHD 5 ..... 3999  
 Horizon RAM 64K ..... 594

Big Sale on Multi-User  
 Time-Sharing ..... SAVE  
 North Star Hard Disk 18Mb ..... 4295  
 English to Basic Translator ..... 75  
 Zbasic 2 to 5 times faster! ..... 325  
 Secretary Word Processor ..... 69  
 Wordstar Word Processor ..... 278  
 Floating Point Board ..... 699  
 Oasis ..... 699  
 CPM for N\* Extra features ..... 147  
 Micro Mike Software ..... CALL  
 MICROSTAT ..... \$355  
 Pascal-80 ..... 539  
 Extra Precision BASIC ..... 49  
 Northword ..... 179  
 Infomanager ..... 328  
 General Ledger ..... 399  
 Accounts Receivable ..... 399  
 Accounts Payable ..... 399  
 Inventory ..... 399  
 Order Entry ..... 399  
 PROPAC ..... 1299  
 DOS + BASIC 5.2 ..... 28

**INTEGRAND** main frames S-100. Many models to choose from  
 Only 200 & UP

## MODEMS

DC HAYES — S-100 ..... \$329  
 POTOMAC MICRO MAGIC ..... 369  
 SIGNALMAN ..... 97  
 CAT NOVATION ..... 159  
 AUTOCAT ..... 215



## MICRO DECISION

"A DEAL YOU CAN'T REFUSE"

64K RAM, Z80, 4MHz, 2 Serial Ports, Disk Controller. FREE SOFTWARE: CPM — Microsoft BASIC — BaZic — Wordstar — Logicalc — Correct-It.

	List	Only
with 1 5 1/4" Disk	\$949	\$1049
with 2 5 1/4" Disks	1545	1400



## DECISION I

"The IBM-360 on the Z-80 & S-100 BUS!"

Sixteen Programs running simultaneously! Free CPM, Microsoft BASIC, and WORDSTAR with complete system!

DECISION I + 65K Static + 8" Disks DMA	3403
DECISION I + 65K Static + 2 5 1/4" Disks	2795
DECISION I + 65K Static + 5" Disk + 5 Mb Hard Disk	4235
DECISION I-2user 256K Static + 5" Disk + 5 Mb Hard Disk + MICRONIX	5830
DECISION I — Z-80 + I/O + 65K	1915
DECISION I — Rackmount + 20 Mb HD - 8" DRV	Reg. 6235 Inventory Sale 5415

## MORROW Hard Disks up to 26 MEGABYTES

HDC-M26	\$3333
HDC-M20	3333
HDC-M10	2955
DMA-M5	Reg. 1775 Inventory Sale 1400
DMA-M10	2235
DMA-M16	2795

## MORROW 8" Disk

Discs 2D + CPM 600K ..... Only \$834  
 Discs 2 + 2 + CPM 1.2 Mb ..... 1068  
 Add Drives 2D = 599 2 + 2 = 1795  
 Discs 2D dual + CPM ..... Only 1384  
 Free Microsoft BASIC from MORROW with Discs system or hard disk.

**FAST FIGURE** — Most powerful spread sheet. 5 1/4" or 8" ..... 99

**Wordstar** ..... 278  
 All MicroPro Software for IBM, Apple, North Star, Morrow, etc. SAVE! CALL

Call for latest prices & availability

Factory Guarantees

We Beat Prices

# AMERICAN



# COMPUTERS

919-889-4577

4167 Kivett Dr.

Jamestown N.C. 27282

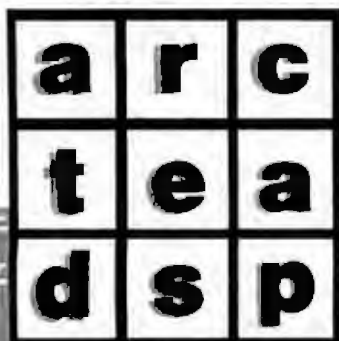
919-883-1105



The intensity of Scrabble;  
the excitement of Boggle;  
the imagination of word search games...

# WORD CHALLENGE™

The Ultimate Word Game.



Ready for some mental gymnastics? Take on Word Challenge. You'll race the clock with LEX, an opponent of uncannily human intelligence, to find hidden words in a square of random letters. (The sample square has 142 words.) Longer words score better points, so while you might enter "cap," "ape" and "tea," LEX is picking out "aster," "repast" and "sacred," all part of his remarkable 90,000-word vocabulary. But don't give up. You can select from 26 different skill levels, choose the square size (3 x 3, 4 x 4 or 5 x 5), time limit and a variety of scoring methods.

Word Challenge. Only \$39.95 at your computer dealer. For Mastercard and Visa orders, call toll-free, 1-800-323-0023. In Florida, call collect, 305/566-3511. Or complete the coupon and send check or M.O. to: Word Challenge, Proximity Software, 3511 N.E. 22nd Avenue, Fort Lauderdale, Florida, 33308.

**PROXIMITY™**

Please send \_\_\_\_\_ Word Challenge Disk(s) for which I've enclosed \$39.95 each (plus \$2.00 shipping and handling). Florida residents please add 5% sales tax.

Check appropriate box.

- Apple II, II Plus or II Plus E (min 48k) w/disk
- IBM Personal Computer (min 64k) w/disk
- Osborne I (min 64k) w/disk

Name \_\_\_\_\_

Address \_\_\_\_\_

City \_\_\_\_\_ State \_\_\_\_\_ Zip \_\_\_\_\_

Apple, IBM and Osborne are registered trademarks of Apple Computer, Inc., International Business Machines Corp. and Osborne Computer Corp. respectively. Boggle and Scrabble are registered trademarks of Parker Brothers Division of CPG Products Corporation and Selchow and Richter, respectively.

disk drive and a user-supplied video-cassette recorder, records data on a video cassette. This backup is essential in an office environment where lost data means lost business. The Mirror—which can record 6 megabytes in 11 minutes, 10 megabytes in 17 minutes, and 20 megabytes in 35 minutes—costs \$1250.

### Service

While Corvus Systems Inc. is not a small company, getting a Concept repaired won't be as easy as with some other popular personal computers. This is a sophisticated machine, and the only place to get one fixed is at a Corvus-authorized dealer. Presently, there are only two dozen of these dealers across the country. It's likely that these dealers will need technical manuals to perform the necessary repairs, and there is also no word yet about the availability of service contracts. This seems to mean that Concept owners are taking a chance if they rely on one machine. With a large networked system, you can usually weather an occasional failure. At this point, I should add that we haven't had any problems in more than 100 hours of use.

### The Envelope Please

I approached the Concept with high expectations, which for the most part have been realized. The designers have included some features that are very special. They have created menus for every possible situation. The keyboard and video display should set a standard for mass-produced personal computers. The bundling of a complete package of business software and hardware is also an idea to be imitated. These features make the Concept a highly usable computer system.

I would like to see Corvus attend to a few details. My most nagging concern is with the inconsistencies encountered when you move from level to level in the menus. When you want to return to a parent menu, you must select a function button. Depending on which level you are at, however, that key is labeled Quit, Exit, Edit, Cancel, or (Cncl). One of the advantages of function keys is not having to memorize the commands. With this arrangement, you must still memorize a set of commands for each level. Adding to the confusion is the fact that the same function label has a different result in different menus. For example, in one menu Cancel returns you to the most recent menu; at another level, it returns you all the way back to the first level, the Dispatcher.

I also found a few cases in which a function listed on the screen was not yet implemented, specifically the < Para and Para > functions in EdWord and the print spooler. In only one case did I find an improperly implemented function, which was a minor problem. Overall, Corvus has done many things right in creating the Concept, but the system needs much more applications software to take advantage of its features. Although the manuals seem to be a major stumbling block, if a sufficient number of companies develop programs and boards for this computer, the Concept could still become a very popular machine. ■



# Plug 3,000 new applications into your Apple®

**THE CP/M Card™ plugs CP/M Plus™ into your Apple.** The CP/M Card gives you the option of running your Apple II with the speed and capability of a professional Z-80 system with CP/M\*-compatible software. You plug in the CP/M Card. Then choose CP/M or your standard Apple software at your option.

**Plug into a big, new world of software.** The CP/M Card gives you instant access to the world's largest selection of microcomputer software—more than 3,000 CP/M-compatible applications, languages, and programming utilities. So, you, too can use professional business programs such as WordStar,<sup>®</sup> SuperCalc,<sup>™</sup> Condor,<sup>™</sup> and other high-performance software from Day One. Yet, you still have access to your present library of Apple software.

**Plug into incredible performance.** Together, the ultra-fast CP/M Card and CP/M Plus run applications up to

300% faster than your Apple system! The CP/M Card is the only Apple II performance package that offers the speed and efficiency of CP/M Plus.

## **A plug about quality.**

The CP/M Card was designed and built by Digital Research, the creators of CP/M, and Advanced Logic Systems, the most respected manufacturer of Apple performance products. So you know the CP/M Card is the most perfectly integrated Apple performance package you can buy.

Why just keep plugging along? The CP/M Card provides everything you need—including 64K of on-board memory, CP/M Plus, CBASIC,<sup>‡</sup> GSX<sup>™</sup>-80 and full documentation—for just \$399.

Now available through the CP/M library. See your local microcomputer dealer today. Or contact Advanced Logic Systems, 1195 East Arques Ave., Sunnyvale, CA 94086 (800) 538-8177. (In California (408) 730-0306.)



**Advanced Logic Systems**  
**The CP/M Card for your Apple II.**

CP/M, CP/M Plus, the CP/M Card and CBASIC are either trademarks or registered trademarks of Digital Research Inc. Z-80 is a registered trademark of Zilog, Inc. WordStar is a registered trademark of MicroPro International Corporation. SuperCalc is a trademark of Sorcim Corporation. Condor is a trademark of Condor Computer Corporation. GSX-80 is a trademark of Graphics Software System. Apple is a registered trademark of Apple Computer, Inc. ©1982 Digital Research Inc.

Circle 18 on Inquiry card.



# How to make work like a

First, neatly cut out the "370" label.

Now, when nobody's looking, nonchalantly tape it to your terminal, just under the "IBM," as if it really belonged there.

Then wait for your chance and quickly slip a dBASE II™ disk into your main drive.

That's it.

Your IBM Personal Computer is now ready to run a relational database system, the kind that IBM put on their mainframes last year.

And you're ready with more data handling power than you would have dreamed possible before dBASE II.

## You'll wonder how you managed without it.

You'll find that dBASE II, because it's a relational database management system (DBMS), starts where file handling programs leave off.

dBASE II handles multiple databases and simplifies everything from accounting to department staffing to monitoring rainfall on the Upper Volta.

With a word or two, you CREATE databases, APPEND new data instantly, UPDATE, MODIFY and REPLACE fields, records and entire databases. Organize months worth of data in minutes with the built-in REPORT. Do sub-field and multi-field searches, then DISPLAY some or all of the data for any condition you want to apply.

And you've just begun to tap the power of dBASE II.

## Easy to look at, easy to use.

Input screens and output forms couldn't be easier—just "paint" your format on the CRT and what you see is what you'll get.



You can do automatic calculations on fields, records and databases, accurate to 10 digits.

And you can use dBASE II interactively for answers right now. Or save your instructions, then repeat everything with two words: DO Manhours, DO ProjectX, DO whatever has to be done.

## Use dBASE II to help make your choice:

If you've got a 96k IBM PC, send us \$700 and we'll send you a copy of dBASE II to use free for 30 days.



# e your micro mainframe.



Instead of just poring over a manual, run it and make sure that it does what you need done.

Then if you find it isn't right for you, send it back and we'll return your money, no questions asked.

But if you do that, you'll have to remove that label. Because nothing short of a mainframe works like dBASE II.

Call (213) 204-5570 today or drop by your local computer store for the rest of the story.

Ashton-Tate, 9929 Jefferson Blvd.,  
Culver City, CA 90230.

## Ashton-Tate

Circle 48 on inquiry card.

©1982 Ashton-Tate

CP/M is a registered trademark of Digital Research



# Achieving Greater White-Collar Productivity in the New Office

*The conversion to automated tools in an office must address many issues, especially human factors.*

---

Randy J. Goldfield  
The Omni Group  
115 East 57th St.  
New York, NY 10022

---

The issues of automated office management and white-collar productivity are no longer the stuff for futurists. The spiraling availability of high-technology office equipment, coupled with inescapable economic forces like increasing labor and management costs on the one hand and decreasing costs of electronics and communications on the other, mandate that top management address the issue of how to increase office worker productivity in this new environment.

The trend is clear: improved white-collar productivity has become a key to increased profitability. There is a

twofold reason for this: the white-collar work force now accounts for the majority (53 percent) of workers and, simultaneously, past blue-collar productivity gains show little leeway for further improvements. According to Labor Department statistics, while industrial productivity rose 83 percent during the past decade, there was a mere 4 percent advance among white-collar workers, despite huge outlays for new technological equipment. The shift away from an industrial work force to an office work force adds greatly to the importance of automation as well as to the potentials for greater output.

Today, business is on the verge of enormous changes spawned by the development of new technologies for distributed word processing, smart copiers, effective terminal PBXs, computerized filing and data banks, laser printing, and the like. As a result, management is faced with the strategic issue of collectively committing tens of billions of dollars to the new and evolving technology of office automation. Executives are asked to weigh technologies that are often not completely understood, factor

them into potentially disruptive human elements, and then decide to what extent they should commit to a relatively new office work-style or mode of operation.

## The Two Reactions to Office Technology

There have been two general reactions to the challenge of office technology. Both are extremist and contribute to poor results in automated ventures. The majority trend has been to wait for the emergence of time-proven office systems and technologies that present minimum risk. Unfortunately, this trend often leads to a loss of competitive edge in the marketplace.

The second reaction falls to the breed of executives who, so overly enthralled with new technologies, ignore bottom-line reality. To some degree, the reason that investment to date in advanced office equipment has not paid off in more visible productivity dividends is because this Buck Rogers group—by focusing predominantly on equipment at the expense of integrating advances into office procedures and human factors re-

---

*Reprinted with permission from the Directory of Information/Word Processing Equipment and Services, available from Information Clearing House, 500 Fifth Ave., New York, NY 10010. The directory is sponsored by the Association of Information Systems Professionals (AISP).*

---

## About the Author

Randy J. Goldfield is president of The Omni Group, a New York-based consulting firm that specializes in office systems productivity improvement.

---

**CP/M<sup>®</sup>  
IBM<sup>®</sup>  
APPLE<sup>®</sup>**

# PRICE WAR!

<b>WordStar<sup>®</sup></b> <b>\$269</b>	<b>dBASE II<sup>™</sup></b> <b>\$489</b>	<b>SuperCalc<sup>™</sup></b> <b>\$189</b>	<b>Multiplan<sup>™</sup></b> <b>\$199</b>	<b>Perfect Writer<sup>™</sup></b> <b>\$289</b>
<b>WordStar<sup>®</sup> MailMerge<sup>™</sup></b> <b>\$369</b>	<b>WordStar<sup>®</sup> dBASE II<sup>™</sup></b> <b>\$749</b>	<b>VisiCalc<sup>®</sup></b> <b>\$189</b>	<b>SuperWriter<sup>™</sup></b> <b>\$249</b>	<b>InfoStar<sup>™</sup></b> <b>\$299</b>

A.L.S. <sup>™</sup> Z-80 Card \$129 CP/M Card \$359	FOX AND GELLER <sup>™</sup> Quickcode \$229 dUnit \$ 69 dGraph \$229	Wordstar/MailMerge \$369 Wordstar/MailMerge/SpellStar \$509 Wordstar/InfoStar \$549 InfoStar \$299 CalcStar \$ 89 DataStar \$179 SuperSort \$149 SpellStar \$229 ReportStar \$229 DataStar Update CALL	DASIS <sup>™</sup> The Word Plus \$129 Punctuation and Style \$109	SORCJM <sup>™</sup> SuperCalc \$189 SuperWriter \$249 SpellGuard \$179
ASPEN SOFTWARE <sup>™</sup> Grammar \$ 60 Random House Proofreader \$ 39 Random House Thesaurus \$119	HOWARDSON <sup>™</sup> Tax Preparer (Apple) \$179 Tax Preparer (IBM) \$189	Wordstar/InfoStar \$549 InfoStar \$299 CalcStar \$ 89 DataStar \$179 SuperSort \$149 SpellStar \$229 ReportStar \$229 DataStar Update CALL	ORGANIC <sup>™</sup> Milestone \$269	TCS ACCOUNTING <sup>™</sup> Accounting Package (4 Modules) \$289 GL, AR, AP, PR or Inv Mgmt \$ 99 ea.
ASHTON-TATE <sup>™</sup> dBase II \$489	JUS <sup>™</sup> Easywriter II \$239 Easywriter II \$139 Easywriter Financial Management Series CALL	MICROSOFT <sup>™</sup> Softcard \$259 Ram Card \$ 89 Videoterm (Vide <sup>™</sup> ) \$269 All Three Above \$509 Multiplan \$199 Enhancer II (Vide <sup>™</sup> ) \$119 BASIC 80 \$275 BASIC Compiler \$295 COBOL Compiler \$549 FORTRAN 80 \$349 Flight Simulator \$ 45	PEACHTREE <sup>™</sup> Series 4 PeachPak (CA, AR & AP) \$369	VISICORP <sup>™</sup> VisiCalc \$189 VisiTerm \$ 85 VisiDex \$189 VisiFile \$249 VisiSchedule \$249 VisiTrend/Plot \$249 Business Forecaster \$100 Desktop Planner \$249
COMPUTING <sup>™</sup> Power \$119	LEXISOFT <sup>™</sup> Spellbinder \$259	MICROSOFT <sup>™</sup> Softcard \$259 Ram Card \$ 89 Videoterm (Vide <sup>™</sup> ) \$269 All Three Above \$509 Multiplan \$199 Enhancer II (Vide <sup>™</sup> ) \$119 BASIC 80 \$275 BASIC Compiler \$295 COBOL Compiler \$549 FORTRAN 80 \$349 Flight Simulator \$ 45	PERFECT SOFTWARE <sup>™</sup> Perfect Writer \$289 Perfect Speller \$169 Perfect Writer/Speller \$389 Perfect Calc \$169 Perfect Filer \$279 All Four Perfect Products \$749	VISICORP <sup>™</sup> VisiCalc \$189 VisiTerm \$ 85 VisiDex \$189 VisiFile \$249 VisiSchedule \$249 VisiTrend/Plot \$249 Business Forecaster \$100 Desktop Planner \$249
CONTINENTAL SOFTWARE <sup>™</sup> Home Accountant CALL	LIFETREE SYSTEMS <sup>™</sup> Volkswriter \$145	MICROSOFT <sup>™</sup> Softcard \$259 Ram Card \$ 89 Videoterm (Vide <sup>™</sup> ) \$269 All Three Above \$509 Multiplan \$199 Enhancer II (Vide <sup>™</sup> ) \$119 BASIC 80 \$275 BASIC Compiler \$295 COBOL Compiler \$549 FORTRAN 80 \$349 Flight Simulator \$ 45	PICKLES AND TROUT <sup>™</sup> CP/M for TRS Model II \$169 CP/M for TRS Model 16 \$189 Hard Disk CALL	FLOPPY DISKETTES (Boxes of Ten) 8" \$ 25 5" (SS) \$ 25 5" (DS) \$ 35
DIGITAL RESEARCH <sup>™</sup> CB-80 Compiler \$109 PASCAL/MT+ \$379 Access Manager \$259 BASIC 86 \$149 PASCAL/MT+ 86 \$299 Concurrent CP/M 86 \$259	METASOFT <sup>™</sup> Benchmark \$379	MICROSOFT <sup>™</sup> Softcard \$259 Ram Card \$ 89 Videoterm (Vide <sup>™</sup> ) \$269 All Three Above \$509 Multiplan \$199 Enhancer II (Vide <sup>™</sup> ) \$119 BASIC 80 \$275 BASIC Compiler \$295 COBOL Compiler \$549 FORTRAN 80 \$349 Flight Simulator \$ 45	SILICON VALLEY SYSTEMS <sup>™</sup> Word Handler \$149 Lot Handler \$129	

## NOW, PAY LESS, AND GET GREAT SERVICE, TOO!

If you're looking for rock-bottom prices *and* fast, personal service, take a close look at 800-SOFTWARE.

Because we buy in volume, we're able to sell the products you want at prices that finally make some sense. But don't take our word for it. Compare prices and see for yourself!

### OUR SERVICE CAN'T BE BEAT.

We take care of you like our business depends on it. Because it does.

When you call 800-SOFTWARE, you get the fastest delivery available anywhere. Which means that every order is filled the day we get it. And that our unique

Order Tracking System<sup>™</sup> is on the job, keeping tabs on your order, every step of the way.

Our giant inventory — one of the largest in the United States — also assures you of the fastest possible service. Everything's in stock so you don't have to wait.

Technical support? Business software expertise? We've got it — and it's the best you'll find *anywhere*.

But, put us to the test. Let us prove what we've proven to satisfied customers around the world.

That our prices *are* lower. That our service *is* better. That there really and truly *is* a difference.

We look forward to your call.

TO ORDER, CALL TOLL-FREE:

**800-227-4587**

In California, 800-622-0678  
or 415-644-3611  
CA residents add sales tax

OR WRITE:  
**800-SOFTWARE, INC.**

3120 Telegraph Avenue,  
Berkeley, CA 94705



- Purchase orders accepted.
- Prompt UPS 3 day Blue Label
- Call for shipping charges, *free* catalog, and other low software prices.
- Now open Mon. Sat.
- International and national dealer requests welcome.
- Quantity discounts available
- Prices may change.

© 1983 800-Software, Inc.



# QUARTER MEGABYTE OF RELIABLE MEMORY WITH PARITY

- 8/16 BIT DATA PATHS
- 24 BIT EXTENDED ADDRESSING
- 230 nS ACCESS TIME (from pSTVAL)—Runs in 4 MHz systems with no wait states.

## FOR 16 BIT IEEE-696 SYSTEMS



**DMEM**

- **TWO INDEPENDENTLY ADDRESSABLE 128 KB REGIONS.**
- **PARITY ERROR DETECTION**—Programmable read options: Latched vectored, pulsed vectored, bus error signal generated.
- **TRANSPARENT REFRESH**, continuous operation w/o wait states or arbitration delays.
- **DATA INTEGRITY** with added byte parity check-bit.
- **CERTIFIED RELIABLE:** 168-hour burn-in dynamic memory test.
- **64K DYNAMIC MEMORY CHIPS** with large cell geometry delivers low soft error rate.
- **FIELD PROVEN**—used in all Dual System 83 series 68000-based computer systems with UNIX\*.

DMEM-256KP ..... \$1295

\*UNIX is a trademark of Bell Laboratories.

# DUAL

**DUAL SYSTEMS CORPORATION**  
2530 San Pablo Avenue • Berkeley  
CA 94702 • (415) 549-3854 • 172029 SPX

quirements—often created overly ambitious projects that were never completed or disappointed users or caused fiascoes when employees refused to adapt to change.

Of course, almost everyone knows cases where high-technology equipment was installed and failed to live up to expectations. Responsible management, however, recognizes that the office has become the next logical place to look for the sort of improvement that can mean sharply increased profits. In fact, with office overhead costs now accounting for 52 percent of operating costs (up 100 percent since 1955), improving productivity in the office has become imperative. What, then, are the key issues to determine before creating a corporate office automation strategic plan? And what are the results that can realistically be expected? These questions must be addressed before any successful implementation can be accomplished.

American industry invests enormous amounts of capital in its workers—and is growing rapidly as the U.S. economy evolves from primarily a manufacturing base to a service base economy. The federal government predicts that by 1985 about 55 million workers of the projected 104 million person work force will be working in offices. For a national economy that historically has had a farming and manufacturing base, this is a revolution indeed. The Commerce Department estimates that some 60 percent of the gross national product already involves information production, storage, transfer, and utilization—clear evidence that the Information Age is already well upon us.

A recent analysis of current and projected work force costs for more than a dozen companies conducted by Gibbs Consulting Group shows they spend record amounts in direct costs for white-collar workers and for information resources/access in an attempt to reap greater gains in worker output. And this is clearly the trend. Melody Johnson, of Kidder Peabody, explains, "Everyone seems to be jumping into automation! Unfortunately, not everyone is prepared

to deal with the problems, and consequently not all will reap the benefits."

Because, despite these expenditures, most office workers are far from being as productive as they can be. In a recent Lou Harris poll conducted for Steelcase, between 67 and 80 percent of white-collar workers reported their individual productivity could be increased if the office work load were reorganized and analyzed so work flowed more smoothly from person to person and department to department. In fact, almost all executives surveyed said they backed investment in more computer terminals and electronic filing, typing, copying, and other equipment to increase office efficiency.

Business executives give top rankings to conversion to electronic-processing telecommunications and data-processing methods as these offer the most visible productivity gains. In addition, the need to enhance overall functioning, and the need to seek better physical layouts that would positively affect employee productivity, play important roles in the reorganization and refining of the office environment.

Despite the investment in labor and the clearly perceived need for productivity increases, the total investment in information resources has reached only about \$73 billion, which, impressive as it might seem, does not clear the threshold necessary for meaningful productivity improvement. In a recent survey of professional productivity, it was determined that professional staff interfaces with computers less than 1 percent of the time. Pens and pencils, at 65 percent, were by far the most popular tool. Overall, it is clear that integrated systems with their synergistic effect on productivity have not yet been put into the right place in significant numbers.

### The Spread of Automation: The Rationale

Of course, many current office systems have at least some equipment that can help boost output. Although U.S. business is generally still entrenched in inefficient paper, mail, and filing systems and relies on anti-





# 13 TIMES FASTER THAN dBASE II™

If you bought your computer to save time, then you need SUPER, the most powerful database system you can use. Power is a combination of speed, ease of use and versatility. SUPER has them all.

**FAST** - To demonstrate SUPER's speed, ISA retained a professional dBASE programmer to benchmark SUPER vs. the acknowledged leader. A simple mailing list application was chosen to minimize dBASE programming cost. The results:

Task	SUPER Time	dBASE II Time
Set up/Program	5:20 min.	12:18:00 hrs.
Input 100 records	50:29 min.	1:27:50 hrs.
Sort & Print Labels	6:41 min.	4:18 min.
Totals	1:02:30 hrs.	13:50:08 hrs.

Notice that SUPER was faster at every task where *your time is involved*—and saving your time is probably the whole reason you bought a computer.

**EASY TO USE** - SUPER won because of its ease of use. Since it is menu-driven, office personnel can easily learn to use SUPER to set up their own applications, speeding and simplifying dozens of tasks without the need of programmer support.

**VERSATILE** - SUPER, unlike other business programs, doesn't dictate how to run your business. With SUPER the computer does what you want, when you want, the way you want it. *SUPER may be the only business program you'll ever need.* It can handle customer files, payables, receivables, depreciation, appointments, cost accounting, time charges, commissions, inventory, manufacturing control, and even matrix accounting systems!

#### **SUPER PERFORMANCE AT A SUPER PRICE -**

That SUPER beats the \$700 dBASE program may surprise you, but in terms of price vs. performance SUPER has no competitors. Among its features are: production input, data compression, multiple databases on line, transaction posting, file reformatting, stored arithmetic files, flexible report formats, hierarchical sort and multi-disk files for up to 131, 068 records. It can select by ranges, sub-strings, and field comparisons. It interfaces to word processors such as WordStar™, SuperSCRIPTSIT™, Model II/16 SCRIPTSIT™, and NEWSRIPT™. In fact SUPER has so many features that

it takes a six-page product description to cover them all. Write or call and we'll send you one.

SUPER is available for TRS-80™ Models I & III under NEWDOS™, LDOS™, and DOSPLUS; for TRS-80 Models II, III and 16 under TRSDOS™; and CP/M™ systems.

**Prices:** TRS-80 and Osborne versions \$250.00  
Other CP/M versions \$295.00  
Manual (Price applicable to purchase) \$ 25.00

**Now available for the IBM PC \$250.00**  
MasterCard and VISA accepted.

#### **OTHER SOFTWARE**

- **ManageMint™:** A PERT/CPM project management system compatible with SUPER. It includes scheduling, resource and financial management modules.
- **Sales Planning and Data Extraction System:** Improves hit rates while cutting costs.
- **Small, economical program packages** for accounting, business and office applications as well as utilities.

*Write for Catalogue*



*Institute For Scientific Analysis, Inc.*

## **SOFTWARE FOR HARD USE™**

Dept B-3 Institute for Scientific Analysis, Inc.  
P.O. Box 7186 Wilmington, DE 19803 (215) 358-3735

**ORDERS ONLY**  
**800-441-7680 EXT. 501**

Trade mark owners: dBASEII- Ashton-Tate. SCRIPTSIT, SuperSCRIPTSIT, TRSDOS, and TRS-80 - Tandy Corp. NEWDOS/80-Apparat, Inc. WordStar-MicroPro Intl. Corp. NEWSRIPT-PROSOFT. LDOS-Logical Systems, Inc. CP/M-Digital Research



quoted typing equipment and "dumb" copiers, there also are electronic data-processing machines, leased or owned private branch exchanges or key systems, and increasing numbers of basic word processors (mainly stand-alone, single systems). And these devices can, and do, improve productivity. But productivity improvement is not always the only issue. In fact, productivity increases when not offset by staff reduction or cost avoidance will not benefit the organization. And it takes careful control to ensure

the savings are captured.

It is estimated that U.S. business can anticipate a productivity and cost reduction of about \$300 billion annually by 1990, simply by adapting new technology and focusing work forces in the right direction. Jack Walsh, Director of Information Services at Avon Products, feels that productivity is a secondary consideration. He says, "Most managements are concerned with profitability. Those of us in the trenches, who understand the day-to-day needs of

coordinating human resources, machinery, procedures, etc., see productivity as a realistic goal, but senior management will lean toward profitability. Until our offices mature, the profitability of installing automated equipment will overshadow productivity issues."

In addition to productivity improvement and profitability concerns, an added benefit of automation is to allow top management to make far faster, higher-quality decisions because of the new systems' capabilities for organizing, sorting, and storing huge amounts of data at speeds measured faster than ever thought possible. And, in fact, other "soft" benefits, such as improved customer service, faster research and development, better marketing information, etc., are all outgrowths of office automation.

Therefore, the executive charged with determining policy on automation must understand both hard and soft improvement opportunities and pressures and the three basic rationales for conversion.

*Improving Corporate Profits.* Current competitive patterns and seemingly intractable lags in productivity make this a persuasive argument for automation. The significance to a company's competitive position, of course, varies with the industry. In banking and insurance, for instance, automation is a critical issue. But at some point in the next 5 to 7 years it is clear that automation will be a necessity that is driven equally by increasing overhead and more automated competition.

For example, some banks have increased their market share by taking greater advantage of information technology to provide 24-hour banking and instant access to customer records. This strategy stems from the highly competitive environment of banking. Similarly, legal firms use terminals to query court proceedings and other legal information as a counter to the growing volume and complexity of precedent searches. In helping to achieve these goals, office automation becomes a strategic issue as well as an operating decision.

*Reducing Escalating Costs.* Con-



# EXPOTEK

2723 W. Windrose Suite 3  
Phoenix, Arizona 85029

## 1-800-528-8960

All Prices Subject To Change

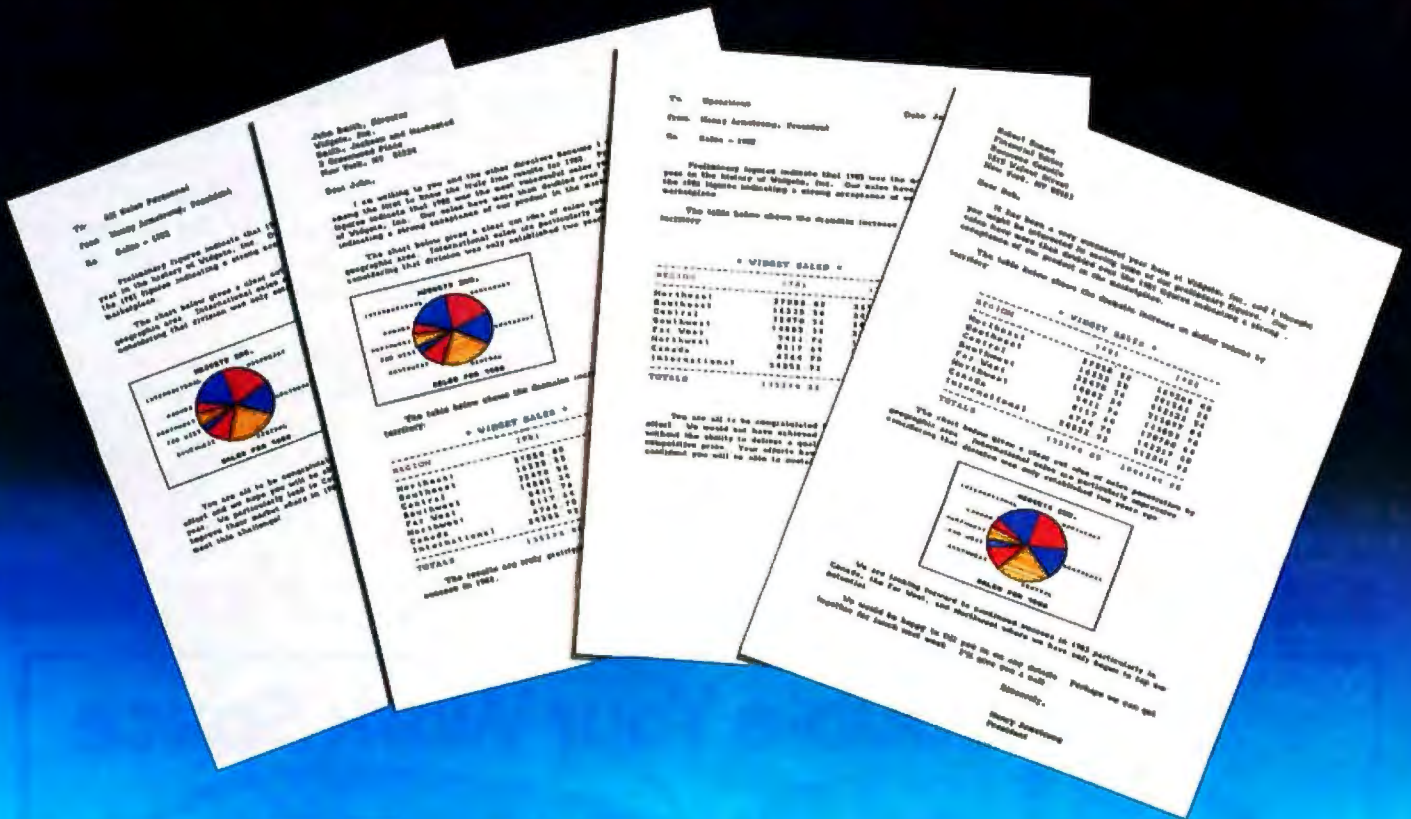





COMPUTERS		PRINTERS	
<b>ATARI</b>		<b>OKIDATA</b>	
1200 - \$645	800-48K - \$499	M92 - \$515	M93A - \$910
410 - \$75	810 - \$429	M82A - \$399 w/Tractor & Grap.	\$479
1010 - \$75	850 - \$159	M84P - \$978	M84S - \$CALL
<b>ALTOS</b>		<b>ANADIX</b>	
5-15D - \$2120	5-5D - \$4100	9500A - \$1290	9501A - \$1290
<b>NORTHSTAR</b>		<b>CITOH</b>	
Advantage - \$2600	Horizon 64QD - \$2600	F-10P - \$1299	F-10S - \$1299
<b>TELEVIDEO</b>		1550P - \$659	Prowriter 1550CD - \$709
802 - \$2599	802H - \$4450	8510AP - \$409	8510BCD - \$545
806 - \$4950	800A - \$1250	<b>DATASOUTH</b>	
<b>APPLE-LOOK-A-LIKE CALL</b>		DS120 - \$595	DS180 - \$1175
<b>APPLE CARDS</b>		<b>DIABLO</b>	
16K RAM - \$78	Z80 CARD - \$235	630RO - \$1799	820 - \$900
Videx Card - \$227	Smart Term - \$279	<b>NEC</b>	
Microsoft Prem. Pk - \$475		8023 - \$450	7710 - \$2045
<b>SOFTWARE</b>		3510 - \$1375	3550 - \$1834
Apple All Major Brands - \$CALL		<b>TI</b>	
Wordstar - \$299	Datatar - \$180	810 - \$1240	820 - \$1795
Calcstar - \$100	Spellstar - \$165	<b>TERMINALS</b>	
<b>DISK DRIVE</b>		<b>ADDS</b>	
Microsci Apple Dr. - \$265		A1 - \$485	Viewpoint A3 - \$485
Rena Elite I - \$275		<b>HAZELTINE</b>	
Rena Elite II - \$450		1500 - \$995	ESPRIT - \$498
Rena Elite III - \$550		<b>TELEVIDEO</b>	
<b>MODEMS</b>		910 - \$569	925 - \$718
HAYS - MICROMODEM - \$269		920 - \$735	950 - \$899
HAYS - SMARTMODEM - \$210		<b>ZENITH</b>	
HAYS - 1200 Baud - \$530		Z19 - \$689	Z89 - \$2129
<b>DISKETTES/BOXES</b>		<b>MONITORS</b>	
Elephant - \$20	Scotch - \$25	Dysan - \$35	
<b>GUARANTEED LOW PRICES</b>		Amdek 300 - \$140	Color I - \$295
<b>Customer Service</b>		Amdek Color II - \$645	Color III - \$350
<b>602-863-0759</b>		BMC Green - \$85	USI Amber - \$159
		<b>COMPUTER IC'S COMPLETE LINE</b>	
		SPECIAL 4116 (150ns) \$1.50ea.	



# RANDOM ACCESS IN A PRINTING BUFFER?



# YES!

## Introducing . . . The IS PipeLine™ Random Access Printing Buffer.

Insert pictures, graphics or spread-sheet data into reports. Duplicate form letters—automatically changing addresses on each. Now, all your programs can work together to produce printed output.

For the first time ever, here is a buffer that not only frees your fast computer from your slow printer but also allows you to rearrange, compose and copy your data on its way to the printer.

- Random Access Printing—stores paragraphs or pictures for printing in any order—any number of times.
- FIFO Printing—conventional first-in first-out operation.
- Compression of data for efficient utilization of memory space.
- Ability to interrupt long-term buffer operations for straight-thru short-term printing.
- Simple Erase feature to clear buffer.
- Automatic duplication capability.
- Easily expandable, by you, from 8K Bytes to 128K Bytes.

The IS PipeLine is Universal—it works with any parallel (Centronics\*—style) computer/printer combination. A special version is available for PKASO™ Printer Interfaces.

The IS PipeLine is a self-contained unit with operating manual, cables and power supply included.

For more information on the truly revolutionary IS PipeLine Random Access Printing Buffer, call us today.



**Interactive Structures Inc.**  
146 Montgomery Avenue  
Bala Cynwyd, PA 19004  
Telephone: (215) 667-1713

\*Centronics is a trademark of Centronics Data Computer Corp.

Circle 234 on inquiry card. The IS PipeLine™ Random Access Printing Buffer is patent pending.



ventional office support systems are not only outdated, but inefficient. Labor-intensive jobs like secretarial typing, shorthand, etc. can be greatly reduced or eliminated by automation. In addition, potential staff reductions through improved processing by machinery can often reduce the number of employees required to perform the more redundant tasks.

**Increasing Professional Productivity.** In the average company, professional salaries account for about half of total salary costs. As the largest segment of the work force salary, increased professional productivity becomes a prime target and justification for automation and increased output. An outlay for equipment, therefore, can be recouped very quickly. Although difficult to quantify, the benefit of providing complete and correct data to professionals is, perhaps, the greatest profit improver office automation will offer. According to James Folts, Vice President, Corporate Development at Syn-trex Incorporated, "Automation as a

management tool is the single most important factor in office automation. Historically, management has viewed office automation as a secretarial tool. However, this approach is the least cost-effective. When used as a professional tool, automation can have an impact on productivity for outweighing the simple increases in document production many companies see as the chief benefit of automation systems."

While word processing and data processing have initially focused on clerical and secretarial staff, increased professional productivity is now seen as a major priority in business. Professional staff salaries have the greatest impact on white-collar costs because much of professional work can be defined as decision making. The key factors in improving productivity are timely handling and processing of information and a reasonable amount of information upon which to base decisions. When people don't have the correct information resources, decision making becomes more complex, and usually less effective.

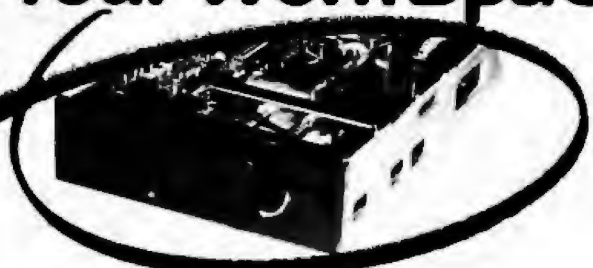
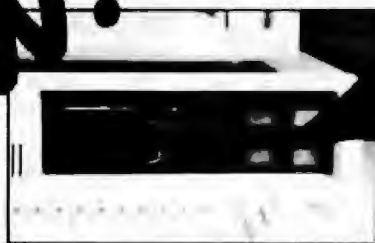
Conversely, if you inundate people with facts, details, and ideas, they are unable to effectively analyze this profusion of information and the right decisions will become impossible to make. The crux is that the proper amount of information provided in a timely fashion permits reasonable decisions. A chief objective within the office, therefore, is to provide professionals with reasonable tools that give them the information they need to make practical, timely decisions. Information must also be presented in a useful form and automation enhances the availability of information. Hence, the obvious relationship between decision making and automation.

### Taking the Plunge:

#### The Risks of Converting

While pioneering is not often profitable, however, timely implementation is important. To wait for the perfect system, totally compatible with every other device, at the right price from the right company is to delay forever. The greatest gains in

# NEW! Double Your Work Space



## TEAC 5 1/4" Floppy Disk Drives

Double your work space with the new TEAC 5 1/4" Floppy Disk Drives. Because the TEAC FD-55 Series Drives are half the height of conventional drives, you can fit up to four TEAC drives in the same space where two conventional drives fit. Or, have room for two floppy disk drives and a hard disk drive.

Not only are the new TEAC drives half the height, they also consume half the power and generate half the heat. Design innovations using a low-noise brushless DC direct drive motor are responsible for this breakthrough. The result: a highly reliable drive with over 10,000 hours life backed by a one year parts and labor warranty.

SPECIFICATIONS			
	UNFORMATTED CAPACITY	TRACK DENSITY	TRACKS PER DISK
FD-55A (1 side)	250K Bytes	48	40
FD-55B (2 sides)	500K Bytes	48	80
FD-55E (1 side)	500K Bytes	96	80
FD-55F (2 sides)	1000K Bytes	96	160

Maynard Electronics also manufactures a complete line of peripherals for the IBM PC and PCXT. They include: SandStar™ Series fully modular boards, Memory Expansion and 5 1/4" and 8" Floppy Drive Controller Boards, clock calendar and Parallel, Serial and Game Parts.

Maynard Electronics is an authorized distributor of TEAC Floppy Disk Drives. Call or write today for complete technical data and price.



### MAYNARD ELECTRONICS

400 E. Semoran Blvd. • The Greater Mall • Suite 207 •  
Casselberry, FL 32707 • 305/331-6402

We make modern times better.

# The Inmac Plus floppy™ is totally reliable, guaranteed for life, and you can get one free.

ALL YOU HAVE TO DO is ask, and we'll send you three Inmac Plus premium diskettes.

One—up to a \$9.90 value—is free.

The other two are for you to use for 45 days at no obligation. Test them out. Compare them to the diskettes you're now using.

We're convinced that once you try Inmac Plus, you'll buy Inmac Plus. And nothing else.

But if you're not completely satisfied, simply return the two diskettes and keep the third one with our compliments.

## Inmac Plus quality for error-free performance.

Do your floppy disks work the first time, every time you put them in your drive?

Ours will, and we're not just saying that. We back every Inmac Plus diskette with the strongest guarantee in the industry—a *lifetime guarantee*.

For as long as you own an Inmac Plus diskette it will read and write flawlessly. It will protect your data. It will perform to perfection—or we'll replace it free.\*



With Inmac Plus diskettes, you're guaranteed 100% read/write accuracy and lifetime data protection.

The problem with ordinary floppy disks is that they gradually wear down under the everyday stress of drive heads and pressure pads. This can result in everything from annoying read/write errors to complete data loss.

Inmac Plus diskettes don't have this problem. They're made with a durable oxide coating that "gives" not flakes as hard-coated disks do. So you don't wind up gambling with your data or wasting hours of valuable programming time.

Inmac Plus diskettes excel on all types of

\*Understandably, we cannot guarantee damage resulting from neglect or abuse. Nor do we assume responsibility for any consequential damages.



*Inmac Plus diskettes surpass every applicable performance standard in the industry. Trust them with your most critical programs and data.*

drives, even finicky ones. One reason for this is a special reinforced hub ring that protects against a major cause of data loss—warps, dents, and tears resulting from the drive's clamping hub.

In all, Inmac Plus diskettes go through 32 separate quality tests. And each is given an individual registration number to help us maintain the highest quality standards possible.

Due to this stringent quality assurance program, they surpass every applicable performance standard in the industry. You can trust them with your most critical programs and data.

## Nothing compares— at any price.

Add it all up.

Inmac Plus diskettes give you total reliability. 100% read/write accuracy. Lifetime protection for your data.

That's why they're your best buy—at any price.

## This exclusive Trial Offer ends August 31, 1983.

Here's how it works.

Simply mail the attached card or phone our toll-free number by August 31, and we'll send you three Inmac Plus diskettes—one of which is yours to keep, no matter what.

The other two are yours to use for 45 days at no obligation. Return them if not completely satisfied.

But we're expecting just the opposite. We think you'll be so utterly impressed, you'll want to keep the two diskettes.

That's why we're enclosing an invoice with



your order, so that by the end of the trial period, you can mail it back to us, along with your check or money order. Or if you prefer, use your credit card—whichever is most convenient for you.

Remember, send no money now. We want you to try Inmac Plus before you buy Inmac Plus, and we'll ship your diskettes within 24 hours so that you can get started as soon as possible.

Offer limited to one free diskette per customer. Offer void in Alaska and Hawaii.

## Get three diskettes for the price of two.

To be sure of getting the Inmac Plus diskette that's right for your system, specify its make and model. Below are some of the most popular systems and the corresponding Inmac Plus diskette. If yours is not listed, call us for assistance and pricing information.

System	Inmac Plus description	Price for 3 diskettes
Apple II, II Plus, IIx; IBM PC (single side); Osborne PC; Radio Shack TRS80-1 or 3	5¼" SSDD Soft Sector	\$11.80 (save \$5.90)
AB Dick Magna Writer; Cromemco Z2H; HP85/Series 9826A, 9836; IBM PC (Dual Side)	5¼" DSDD Soft Sector	\$16.80 (save \$8.40)
DEC RX01; IBM System 32, 3737, 3740, 3730, 3741, 3600, 3601, 3790, 3791	8" SSDD Soft Sector	\$15.80 (save \$7.90)
	IBM format 2305830	
CDC 9406; HP3000 Series 33; IBM Series I, diskette 2; IBM System 34, diskette 1	8" DSDD Soft Sector	\$19.80 (save \$9.90)

Double density diskettes can be used in single density applications.

Send attached postage-free  
card or phone toll-free.

**1 (800) 547-5444**

[1 (800) 547-5447 in California.]

When you call, ask for a free Inmac catalog. Inmac Plus diskettes are available only through the Inmac catalog or through special offers such as this.

**inmac**

**World's leading source of computer  
supplies and accessories.**

Circle 226 on inquiry card.

107121



**IBM**  
personal computer  
**UCSD**  
p-System™  
Version IV.1

NCI now offers  
Version IV.1 which includes:

- RAMdisk
- Subsidiary Volume Support
- 8087 Numeric Coprocessor Support
- FASTER Long Integers (2x)
- FASTER Floating Point (3x)
- 25% greater floppy storage
- Floppy Write Verification
- Asynchronous Serial I/O
- Extended memory codepool
- 8086/87/88 Macro Assembler
- 8087 Native Code Generator
- program caller unit
- generalized sort unit
- 32 bit seek
- FASTER Seek
- FASTER Turtlegraphics
- Adaptable Support
- PC DOS Filer Utility
- Background Spooler

Also available

- PFAS Pascal File Access System
- Hard Disk Support
- Advanced Systems Editor
- Sprinter text formatter
- QuickISAM/PascalISAM/SuperDB
- QuickForm/PascalForm

Available for

- IBM pc
- Victor 9000

TM Regents University California  
TM IBM Corporation

For more information call

**Network Consulting Inc.**  
Discovery Park  
Suite 110-3700 Gilmore Way  
Burnaby, B.C. Canada V5G 4M1  
604-430-3466

profitable automation will be forthcoming from research and development groups working at beta test sites across the country, and the fear of becoming involved in automation too early, or of being locked into obsolete equipment, should be put into its proper perspective. A timely start, despite the hazards involved, will ensure a smoother transition, as automation makes further advances, along with the development of a core of internal expertise that can provide hands-on knowledge and a leading edge on the competition.

But this does not mean that one should opt for an overnight plunge into the so-called, much-touted "office of the future." Because most offices exist with yesterday's systems (or lack of them), an orderly update to the "office of today" makes more sense and avoids the trauma, expense, and serious disruptions that an overly ambitious or, perhaps, premature program will invariably cause.

Of course, outright purchase of equipment in a climate so volatile is rarely desirable, although some underfinanced manufacturers make their rentals virtually punitive versus relatively attractive lease/purchase plans. The cash flow and capital situation of the company is, of course, also a factor. In fact, cost-justification and return on investment become highly complex.

### Quantifying Benefits: Justifying the Investments

There is, typically, a "backbone" application that must exist to justify automated equipment within each area of a company. Frequently, that backbone is word processing—the task of text-editing and manipulating words—where productivity can be dramatically increased by automation with the least outlay of capital and most quantifiable resultant savings. In promoting a recently announced multipurpose office system, for example, salespeople stressed its application simply by cost-justifying it as an automatic typewriter. Despite many other capabilities, products from Xerox, Syntrex, IBM, and Wang are also marketed in this manner to

capture the most obvious audience. Chuck DeNapoli, General Sales Manager at Micom, explains, "Our marketing approach is to appeal to the clients' common ground, and then augment it. New accounts usually feel more comfortable approaching advanced automation applications as an add-on to their current typing process rather than a completely new and different mode of operation. Improved typing is often the best avenue to travel on first applications."

But once a terminal is in place for word processing, additional peripherals can add sex appeal and accrue additional benefits for very little or no extra cost. Applications like automatic filing, conferencing, or electronic mail can complement the backbone application.

Electronic mail alone, for instance, is rarely cost-justifiable except in unique situations requiring both speed and accuracy. But without a large installed base of preexisting terminals as a backbone, it realistically is both prohibitive in cost and in usefulness.

Another key issue is to determine to what extent potential and achieved benefits can be quantified. By and large, the task of quantifying clerical work has been accomplished through systems as sophisticated as MTM and other industrial engineering techniques. Secretarial productivity, however, is somewhat more ephemeral. If a secretary received 20 calls today, versus 40 yesterday, is she half as productive? Clearly, the task is more complex because, in addition to measuring output, a value must be placed on it. Yet administrative support audits can—and do—quantify secretarial efficiency, typically finding cost reduction opportunities of about 20 percent in most studies.

If secretarial productivity quantification is somewhat difficult, it's a cinch compared to the issue of quantifying professional and managerial productivity, which raises far more questions as to its value or its feasibility.

The difficulty, of course, is in assigning a dollar value to creative and intangible activities that may or may not eventually result in tangible

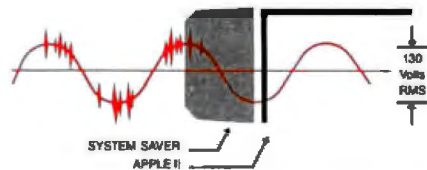
# System Saver™

The most important peripheral for your Apple II and IIe.



## For Line Surge Suppression

The SYSTEM SAVER provides essential protection to hardware and data from dangerous power surges and spikes.

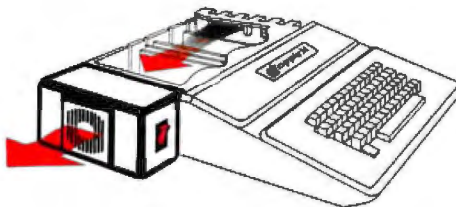


By connecting the Apple II power input through the SYSTEM SAVER, power is controlled in two ways: 1) Dangerous voltage spikes are clipped off at a safe 130 Volts RMS/175 Volts dc level. 2) High frequency noise is smoothed out before reaching the Apple II. A PI type filter attenuates common mode noise signals by a minimum of 30 dB from 600 khz to 20 mhz, with a maximum attenuation of 50 dB.

## For Cooling

As soon as you add 80 columns or more memory to your Apple II you need SYSTEM SAVER.

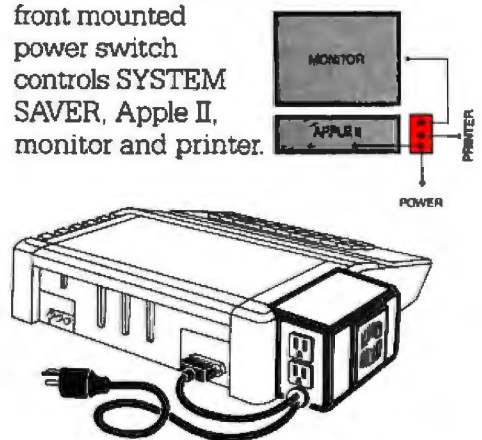
Today's advanced peripheral cards generate more heat. In addition, the cards block any natural air flow through the Apple II creating high temperature conditions that substantially reduce the life of the cards and the computer itself.



SYSTEM SAVER provides correct cooling. An efficient, quiet fan draws fresh air across the mother board, over the power supply and out the side ventilation slots.

## For Operating Efficiency

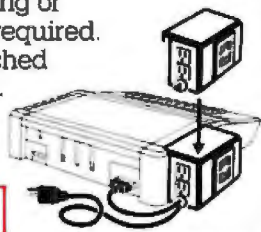
SYSTEM SAVER contains two switched power outlets. As shown in the diagram, the SYSTEM SAVER efficiently organizes your system so that one convenient, front mounted power switch controls SYSTEM SAVER, Apple II, monitor and printer.



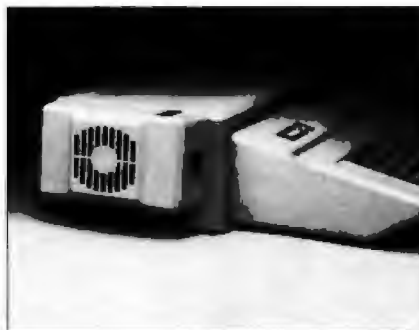
The heavy duty switch has a pilot light to alert when system is on. You'll never use the Apple power switch again!

## Easy Installation

Just clips on.  
No mounting or hardware required.  
Color matched to Apple II.



## Compatible with Apple Stand



Suggested Retail **\$89.95**  
One Year Warranty

Kensington Microware Ltd.  
919 Third Avenue  
New York, NY 10022  
(212) 486-7707

**KENSINGTON  
MICROWARE**  
Circle 253 on inquiry card.



# P&T CP/M<sup>®</sup> 2 is GROWING

**TRS-80 MODEL II**  
**\$185**

Still the best CP/M for the Mod II with features like 596 Kb per diskette, typeahead, full serial port support, and more.

**TRS-80 MODEL 16**  
**\$220**

Includes full support for thinline drives; gives 1.2 Mb per diskette for the Mod 16 (2-80 model) and Mod II's with double sided drives.

**RADIO SHACK HARD DISK**  
**\$250**

Includes all the features of P&T CP/M 2 plus 8.7 Mb per hard disk drive.

**CAMEO HARD DISK**

Support for the standard Cameo hard disk system (\$250) or the multiplexer (for multiple computers) system \$400.

**CORVUS HARD DISK**  
**\$250**

Support for a 5, 10, or 20 Mb Corvus hard disk system.

Start with a Model II floppy system and grow into a hard disk. Since all P&T CP/M 2 systems are fully compatible, you will have no conversion worries.  
**Special note:** P&T hard disk systems allow you the user to configure logical drive assignments to your specifications. Write for more details.

Prepaid VISA, M/C, or COD orders accepted. All prices FOB Goleta and subject to change. CP/M is a registered trademark of Digital Research. TRS-80 is a trademark of Tandy Corp.

**PICKLES & TROUT**  
P.O. BOX 1206  
GOLETA, CA 93116  
(805) 685-4641



benefits to the company. Is a trip to a convention productive? By what standard? How do the hours spent preparing for an internal meeting contribute directly to the bottom line of profits? Should productivity be determined by the number of reports read or memos written or meetings attended? Obviously not, but finding out what methods to best use is difficult. The target group may not be willing to cooperate and there are many aspects of professional activity that cannot be measured. Finally, in addition to support staff and professional quantification, those "soft" benefits or value of more complete, timely, or accurate information must also be considered.

## A "backbone" application must exist to justify automated equipment within each area of a company.

For example, putting a price tag on the speed and accuracy with which market data, government regulations, competitive analyses, sales figures, inventory, etc. are available is difficult but can make a significant difference on the bottom line of a company. In terms of government reporting alone, the burden for some companies is immense. For example, a report released in March 1979 estimated that *each* of the 48 largest U.S. companies spent an average of \$54 million annually on government reporting.

However, implementation cannot begin, even after benefits have been established and costs justified, without careful consideration of how quickly implementation can take place within a particular company's individual environment. Its resources, potential user acceptance, and funding availability must all be realistically appraised. Appropriate planning is critical, and the environment will define how fast changes can be implemented and how quickly benefits will accrue.

## Managing Change in the Office

The mechanics of managing office automation present another side to the environment issue. In putting together a plan, one must determine:

- size of staff necessary to implement and convert the facility
- the function of each staff member
- study methodologies used to study, justify, and design the system
- productivity measurements
- result quantifiers

Of course, top management most frequently asks: "How much will automation cost?" Although this is a valid query, it is impossible to answer in generalized terms. Costs will depend on the company's current level of automation, the industry, and individual needs and must reflect them. As a general rule of thumb, hardware costs should be offset by labor savings and productivity increases within about 18 to 36 months, and sometimes can be realized sooner.

Cost considerations are being helped by continuing breakthroughs in microelectronics and other technologies. Cost reductions of 85 percent and more are being realized, and further reductions are certain to appear as the volume of production of automated office equipment continues to run counter to general inflationary trends.

If an implementation plan is being created, it is important to also determine the best way to integrate the plan to a corporation's internal attitudes. Should a task force or committee be set up to assist in the planning and conversion process? What involvement should end users have? Who in the firm should take on day-to-day operational responsibilities? How should such a plan be structured to ensure integration with complementary functions such as data processing and personnel?

The management philosophy of a company will dictate the appropriate method of involving employees. Democratic, highly communicative firms typically opt for committees, with high user feedback and re-



# NATIONAL COMPUTER PRODUCTS



**Video Monitors**

AMDEK Video 300 12" hi-res gfm	145 <sup>00</sup>
AMDEK Color 11" w/ audio out	209 <sup>00</sup>
AMDEK Color II hi-res RGB	289 <sup>00</sup>
AMDEK Color III hi-res RGB	389 <sup>00</sup>
BMC 12AU 12" hi-res green	99 <sup>00</sup>
NEC 1201M 12" hi-res green	169 <sup>00</sup>
NEC 1212M 12" composite color	229 <sup>00</sup>
NEC 1202M 12" RGB for IBM PC	409 <sup>00</sup>
TAXAN Vision 1 12" hi-res RGB	329 <sup>00</sup>
TAXAN Vision 3 12" hi-res RGB	499 <sup>00</sup>
USA 12" Amber display	169 <sup>00</sup>
ZENITH 12" hi-res green	119 <sup>00</sup>



**MICROSOFT**  
Microsoft Multi-Plan

Hailed outstanding product of the year by InfoWorld Magazine.

Only **\$179<sup>00</sup>**

Specify Apple DOS, Apple 2-80, or 8" CP/M



**Kaypro**

The anytime-anywhere computer. Includes CP/M, CBASIC, a spreadsheet and wordprocessing software.

PLEASE CALL FOR MORE DETAILS.



**VisiCorp**  
VisiCalc

Only **\$179<sup>00</sup>**

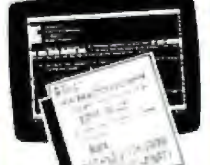
VisiFile IBM ..... 219<sup>00</sup>  
VisiTextPlot ..... 229<sup>00</sup>  
VisiSchedule ..... 229<sup>00</sup>  
VisiWord (for IBM with 128K) ..... 299<sup>00</sup>



**OSBORNE I**

New! Includes double-density drives, and software: CP/M, WordStar, MailMerge, SuperCalc, CBASIC & MBASIC.

PLEASE CALL FOR OUR PRICE.



**MicroPro**

WordStar ..... 349<sup>00</sup>  
Random House Thesaurus ..... 129<sup>00</sup>  
MailMerge ..... 129<sup>00</sup>  
SuperSort ..... 129<sup>00</sup>  
SpellStar ..... 129<sup>00</sup>

Specify Apple, IBM, or 8" CP/M format.



**Diskettes**

Only 100 for only **\$219<sup>00</sup>**

3M Scotch 5 1/4 55/DD Box of 10 ..... 25<sup>00</sup>  
3M Scotch 5 1/4 55/DD Box of 10 ..... 35<sup>00</sup>  
Verbatim 5 1/4 55/DD Box of 10 ..... 29<sup>00</sup>  
Head Cleaning Diskette 5 1/4 ..... 27<sup>00</sup>

**Popular Software**

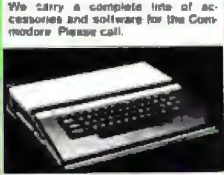
dBASE II by Ashton Tate	449 <sup>00</sup>
SuperCalc by Sorcim	229 <sup>00</sup>
The Home Accountant IBM	119 <sup>00</sup>
1-2-3 Lotus - Please call for details, Personal Investor IBM	129 <sup>00</sup>
The Tax Manager 1983 IBM	179 <sup>00</sup>
Flight Simulator IBM	35 <sup>00</sup>
Verform for IBM	249 <sup>00</sup>

Please specify Apple II or IBM PC



**COMMODORE 64**  
Special Price **\$379<sup>00</sup>**

COMMODORE 1541 Disk Drive 329<sup>00</sup>  
DataSette program recorder 65<sup>00</sup>  
DATA 20 Z-80 & 80 column pac 229<sup>00</sup>  
CARDIO Centronics interface 79<sup>00</sup>  
Tolt. Text Processor 38<sup>00</sup>  
Spritmaster 35<sup>00</sup>  
MicroSystem RS-232 interface 59<sup>00</sup>



**ATARI 1200XL**  
Only **\$679<sup>00</sup>**

ATARI 800 with 48K 499<sup>00</sup>  
ATARI 810 Disk Drive 429<sup>00</sup>  
ATARI LIGHT PEN by Syntec 129<sup>00</sup>  
Athen Voice Box 129<sup>00</sup>  
File Manager Plus data base 79<sup>00</sup>

We carry much more for Atari Call

Defender - Dig Dug  
Donkey Kong - Galaxian  
Pac Man - Centipede  
Qix - Star Raiders  
Missile Command - Miner 2049  
YOUR CHOICE Only 329<sup>00</sup> ea.



**COLECOVISION**  
State-of-the-Art video game

Only **\$187<sup>50</sup>**

Donkey Kong game included

Expansion Mod I allows use of ATARI 2600 VCS games on ColecoVision 75.00



**Modems**

Hayes Smartmodem 300	219 <sup>00</sup>
Hayes Smartmodem 1200	619 <sup>00</sup>
Novelton J-Cat 0-300 baud	125 <sup>00</sup>
Anchor Mark I 300 baud	164 <sup>00</sup>
Anchor Mark VHI 300/1500 baud	399 <sup>00</sup>



**EPSON FX-80**  
180 cps, 10" carriage, 2K buffer

**EPSON FX-100**  
GEMINI 10  
C. ITOH 8510  
C. ITOH 1550

Please call for prices



**Letter Quality Printers**

C. ITOH F 10 Starwriter 40 cps	1359 <sup>00</sup>
C. ITOH F 10 Printmaster 55 cps	1649 <sup>00</sup>
Dalbywriter 40 cps w/16 buffer	1249 <sup>00</sup>
NEC 3510 33 cps RS-232 serial	1449 <sup>00</sup>
NEC 3530 33 cps parallel	1899 <sup>00</sup>



**OKIDATA ML92**  
180 cps, 10 inch carriage, 80 columns

Only **\$499<sup>00</sup>**

Tractor for ML 92 ..... 59<sup>00</sup>  
OKIDATA 93 ..... 659<sup>00</sup>  
OKIDATA 92A with tractor ..... 659<sup>00</sup>  
OKIDATA 84A per tractor ..... 99<sup>00</sup>



**TRANSTAR 315 Color Printer**

Prints 7 colors plus more than 30 shades, all in a single pass of the print head. And it's built by Seiko.

Only **\$549<sup>00</sup>**



**NEC 3550 Spinwriter for IBM PC**

Only **\$1995<sup>00</sup>**



**Apple IIe**

Please call for prices on Apple IIe system packages and other accessories

**Call for Lowest Price.**



**Apple Disk Drives**

Special buy! **Franklin Ace 100** only **\$359<sup>00</sup>**

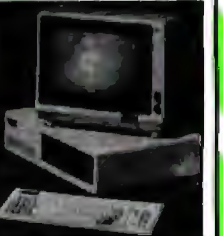
Forth Dimension ..... 269<sup>00</sup>  
MicroSci A2 ..... 299<sup>00</sup>  
MicroSci A2 with controller ..... 369<sup>00</sup>  
Rana Elite I ..... 269<sup>00</sup>  
Rana Elite I w/controller ..... 369<sup>00</sup>  
Corona 5 megabyte hard disk ..... 1399<sup>00</sup>



**IBM Personal Computer**

Includes 84K, 2 DD/DS 320K drives, keyboard, color video card & MS-DOS

PLEASE CALL FOR SYSTEM PRICE.



**Columbia MPC**

IBM PC compatible system includes 128K, 2 DS/DD 320K drives, keyboard, video card, MS-DOS & CP/M 86 software. Monitor not included.

**COMPLETE SYSTEM** Only **\$1795.00**



**Franklin Ace 1000 & 1200**

Apple II compatible computer - 64K, superpower case, and more!

PLEASE CALL FOR DETAILS

System packages at special prices

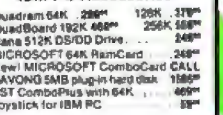


**IBM PC COMPATIBLE DESKTOP COMPUTER**

128K 320K disk drives, 9" display, serial & parallel ports, and MS-DOS

Under **\$2400**

Please call for more details



**IBM PC COMPATIBLE PORTABLE**

128K, 320K disk drives, 9" display, serial & parallel ports, and MS-DOS.

Under **\$2300**

Please call for more details



**IBM PC Accessories**

Quadram 64K	289 <sup>00</sup>	128K	379 <sup>00</sup>
QuadBoard 192K 489 <sup>00</sup>	256K	369 <sup>00</sup>	
Rana 512K DS/DD Drive	249 <sup>00</sup>		
MICROSOFT 64K RamCard	249 <sup>00</sup>		
New! MICROSOFT ComboCard CALL DAYLONG 5MB plug-in hard disk	1899 <sup>00</sup>		
AST ComboPlus with 64K	469 <sup>00</sup>		
Joystick for IBM PC	59 <sup>00</sup>		

**SATISFACTION GUARANTEED**

We will accept the return of most items within 15 days of your receipt of the merchandise. At your request we will repair, exchange, or issue a prompt refund. Understandably, software is not returnable. Please call for more details.

To order please send money order or cashier's check. Personal checks 3 weeks to clear. Prices reflect 12% cash discount. We accept VISA, MasterCard, American Express, Diners Club and Carte Blanche. Shipping, handling & insurance charges add 3% of merchandise total (min. \$5.00). California residents add 8% sales tax. Foreign customers please call or write. Prices and availability subject to change without notice. All equipment is new and warranted by the manufacturer.



National Computers Spring 1983 collection of State-of-the-Art computer merchandise is available now. You'll find hundreds of products, including computers, printers, video monitors, modems, and accessories for the Apple II, IBM PC, and CP/M systems, all at the great prices you expect from us. It includes dozens of illustrations and some very informative comparison charts. For your copy send \$1.00, which we will credit to your next order.



sponse, while more paternalistic firms, predictably, design a system and only then introduce it to the staff.

Analysis of individual office styles is also important. What works in New York may not work in Boston, but almost certainly will be totally inappropriate in Los Angeles or Honolulu.

The type of industry is also important. The style of a large nonprofit theater corporation will vary widely from a light manufacturing facility. Careful consideration of the organizational and management philosophy and style will prevent the formulation of a heavy-handed or inappropriate action plan and greatly support active gains in implementation. Of course, risk factors will vary, not only from company to company, but from division to division, or even from department to department. They may include issues such as impact on unionization, loss of professional and clerical staff, trauma during conversion, disruption of schedules, changes in pay scales, or even sabotage to equipment.

It is best to define and realistically consider these risks versus the opportunities, and once a decision has been reached, to proceed, setting up implementation programs to mitigate the risk factors whenever possible.

To lessen some of these risks, begin automation slowly. Installing a "core" system to provide one department or office with several applications is a good approach, with dispersed or satellite equipment of a more limited but compatible type in other parts of the company. In this way, the overall corporate structure is introduced to the benefits of automation on an incremental basis.

Such basic systems should be capable of relatively simple expansion, as more and more of the firm's information and transactions are switched from paper to electronic media as development of the system proceeds. This sort of solution, if the original equipment is planned as cost-efficient from the beginning, can also ease financing problems that may extend beyond cash flow and debt considerations. Programs that are demonstrably self-liquidating can go far toward

convincing boards of directors and activist stockholders of the viability of new technologies.

### **Picking the Hardware: Defining the Function**

The concern that is raised with greatest frequency by users at professional conferences, seminars, and on consulting assignments is always: "What equipment should we be using in automating our office?" Unfortunately, the push from zealous vendors has focused attention on equipment, and all too often users are made to believe that it is the machine rather than the procedures that is the key to a successful conversion. Management is also intimidated by the technology and fearful of making a wrong choice.

Publicity and media overexposure, coupled with a host of manufacturers jumping into this hot marketplace, have inevitably led to confusion over the viability of the "office of the future." But when you define office automation needs by *function*, rather than with a hardware bias, equipment falls relatively easily into five basic functional categories.

Of course, equipment will vary considerably and continue to do so, but can best be judged by the components most systems use and then individually compared.

**Input.** This converts information from the human-recognizable form of the typed page to electronic storage form, for example, the keyboard on a word processor is the input component through which an operator translates a handwritten draft into impulses on magnetic media.

**Output.** The component that performs the reconversion translating from electronic/storageable form to human-recognizable form, e.g., laser printers that translate magnetic coding into typewriter-quality, human-readable documents.

**Storage.** The electrical, magnetic, and optical filing of information that can be done on microfilm or microfiche, computer disk, cassette, magnetic card, or other media, both on line or off. These media have the unique ability to conserve space by thousands of percentages.

**Transport.** The transfer of information either electromagnetically or optically between devices, as in OCR scanning or facsimile transmission.

**Processing.** The capability to perform logical arithmetic or formatting manipulation of information, as well as the control of all four previous physical components through software procedures.

By determining the requirements of a particular office, one can select the category of functions that need to be fulfilled and judge available equipment by the quality and features of the components that fulfill these functions. The old hardware categorizations, such as "stand-alone word processor" or "executive terminal," are not really relevant. To be sure, to best address business needs, the process must involve defining current support requirements and potential benefits of automation, designing the appropriate systems, and estimating resource requirements to achieve the plans.

Some firms have even created a position to address this need, such as Director of Office Automation, Vice President of Productivity, etc. Although the titles vary, and the responsibilities range from simple advisory to wholesale implementation and management duties, the position is, in almost all cases, that of a company-wide coordination ensuring an integrated and compatible approach to office automation.

This sort of approach requires a management commitment to change. And although no totally futuristic or empirically more productive automated office exists in today's business place, beta test sites and partial conversions are springing up nationwide. Many have been instigated by relocation projects—company moves are a perfect opportunity for reevaluation and change.

### **Converting the Office: A Blueprint for Change**

Planning and bringing to successful completion a conversion to office automation must successfully address all the issues already described. The approach suggested below can assist in ensuring success, but the solution,

**"My Dad bought NEC TREK for all the wrong reasons."**



When I told my Dad about NEC TREK, NEC's new personal computer, he wanted one right away.

I told him it's a Z80-based system with 16K ROM/16K RAM expandable to 32K ROM/32K RAM.

He said it looks like fun.

I told him it has 10 programmable function keys, high-powered graphics capabilities, powerful Microsoft BASIC included, and an 8-octave programmable musical tone generator.

He said it has lots of 'fun games'.

I told him how its memory storage can interface with cassette, diskette, or cartridge, and how it has a wide variety of sophisticated software available—important things like financial management packages. And how NEC gives him big system power at a small system price,

including options like their thermal printer, disk drive, digitizer touch panel, expansion unit and data recorder. The whole package for under \$2,000, and the computer itself is only \$349.

He just challenged me to a game of Protector. :)

That's my Dad. I love him, but sometimes I wish he could understand how a kid feels.

**NEC**

**NEC Home Electronics (U.S.A.), Inc.  
Personal Computer Division**

1401 Estes Avenue, Elk Grove Village, IL 60007

Nippon Electric Co., Ltd., Tokyo, Japan



**Adventure at your fingertips™**

™ Synapse Software



of course, must vary depending upon the unique needs of the situation. The outline below helps make sure that all aspects of office automation strategic planning are covered, but, realistically, the skill of a Houdini still may be needed to pull it off.

**Step 1. Create a detailed work plan for the project.** Because of the implications and tremendous breadth of an undertaking like this, a fully detailed, time-phased plan is necessary to describe tasks that must be undertaken, manpower necessary, elapsed time for each task, and target due dates, which may extend over a period of years. Such a plan will help control an unwieldy, major undertaking. Most important, the plan should be approved by top management before the program begins, which guarantees its knowledge of and involvement in various steps. Interface with office corporate groups is also necessary to ensure compatibility in planning between sites.

**Step 2. Assess business needs and relate them to automation/productivity implications and opportunities.** Those involved in designing automated systems must understand the future business directions and strategies of the corporation and compare the operating objectives, long-term positioning, and economic and regulatory constraints to available technological solutions. For instance, rapid growth, industry needs,

competitors' capabilities, and even the overall economy are important considerations when designing a system. Governmental policies, new business strategies, cash flow, or changing marketplace conditions all should impact the plan.

Because of the certainty that meaningful office automation will vastly affect both day-to-day operations and strategic outlook for the enterprise, rigid analysis of where the company is and where it intends to go is essential. When the planning process is ended, if it is successful, the firm will commit itself to a phased implementation program that will merge downstream with the company's evolving business and market strategies to capture potential productivity gains.

**Step 3. Select applications and concepts that will profit and improve business.** By applying the set of available automated office concepts to business needs, a backbone application as well as additional peripheral applications should evolve.

It is critical, then, that the benefits of technology *specific to industry and business* be determined. For example, electronic mail is most attractive when *internal* communications need enhancement. For a firm with largely external communications needs, electronic mail will not be a great boon. It is the role of the office automation

practitioner to overlay the business needs onto the available technology, determining applications.

Armed with what amounts to a first-cut solution, the planners must then determine resource requirements to bring about such a solution. Financial and personnel needs must be weighed carefully and then factored in with a prudent estimate of what future technical, human, and financial resources the company can commit. Without an assessment of the "real" constraints as perceived by future end users, office automation planners may find themselves in a situation where "client" departments are very resistant to change and feel left out of the planning process involved. Needless to say, "solutions" presented without first going through this feedback loop are doomed to failure.

**Step 4. Conceptualize the architecture of the system.** The user must develop a conceptual design of the proposed system based on available technology, price/performance, and vendor service and support records. Systems architecture must be described in terms of the five physical elements previously mentioned: Input, Output, Storage, Transport, and Processing.

At this point, organizational alternatives must be considered. Should devices be located in centers, in clusters, or individually? Should they

## WE GAVE YOUR DRIVES THE FIRST BREAK THEY EVER HAD...



The DCU is the original Drive Control Unit that turns floppy drives off during periods of inactivity by using a state of the art optoisolator with zero crossover control and built in activity monitor.

We've continued to improve the design (it's the size of a business card to fit within the drive), ease installation time (about 15 minutes) and models are now available for virtually all popular 8 inch drives (including a foreign version). So for those of you, who are still grinding down your drives, wearing out media and exposing yourself to unnecessary noise...isn't it time to give them a break?

Assembled and tested ..... \$49.95  
Kit with Documentation ..... \$29.95  
Type of drive MUST be stated with order.  
NY residents add local tax. Include \$1.50  
for postage and handling.

**OPTRONICS TECHNOLOGY**  
P.O. Box 81, Pittsford, N.Y. 14534, (716) 377-0360

# Frustration Insurance.

The Assembly Language Programming Series from Osborne/McGraw-Hill.



1) 6502 Assembly Language Programming  
Leventhal Order #27-6 \$16.99  
"The book that will probably get the reputation as being the 6502 Bible."  
INTERFACE AGE



2) 6502 Assembly Language Subroutines  
Leventhal, Saville Order #59-4 \$15.95  
Over 50 ready-to-use subroutines



3) 6809 Assembly Language Programming for the Apple II.  
Mottola Order #51-9 \$12.95  
Run programs hundreds of times faster and use less memory space than with programs written in BASIC.



4) 6809 Assembly Language Programming  
Leventhal Order #35-7 \$16.99  
"Leventhal appears to have a formula for producing programming manuals. If so, it's a good formula... he has produced another clear and thorough manual for the serious programmer!"  
AMERICAN MATHEMATICAL MONTHLY



5) 6800 Assembly Language Programming  
Leventhal Order #12-8 \$15.99  
A complete reference to the 6800 instruction set and programming techniques.



6) 68000 Assembly Language Programming  
Leventhal Order #62-4 \$16.99  
Covers 68000 assembly language programming in the explicit detail needed to tap the full potential of this highly evolved microprocessor



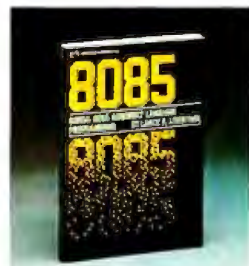
7) Z80<sup>®</sup> Assembly Language Programming  
Leventhal Order #21-7 \$16.99  
"There may never be a better book on the Z80 assembler than this one..."  
CREATIVE COMPUTING



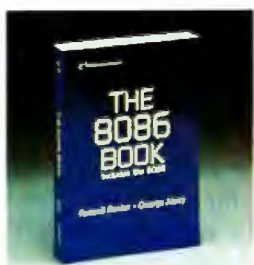
8) Z80<sup>®</sup> Assembly Language Subroutines  
Leventhal, Saville Order #93-8 \$15.95  
(Available 4/83)  
Over 50 useful subroutines to save you valuable programming time.



9) Z8000<sup>®</sup> Assembly Language Programming  
Leventhal, Osborne, Collins  
Order #36-5 \$19.99  
An excellent source reference for this powerful, 16-bit device. Filled with trouble-shooting hints and sample problems to guide the user to mastery of this "super chip"



10) 8080A/8085 Assembly Language Programming  
Leventhal Order #10-1 \$15.99  
"...an excellent encyclopedia of assembly language programming."  
BYTE



11) The 8086 Book  
Reclor, Alesy Order #29-2 \$16.99  
"...far superior to any other book about the 8086"  
DR. DOBBS JOURNAL

Before you hit the Frustration Key, reach for an Osborne/McGraw-Hill book.



By phone, call TOLL FREE: 800-227-2895. In California, call 800-772-4077. VISA and MasterCard accepted.  
By Mail, complete the coupon below and mail to Osborne/McGraw-Hill, 2600 Tenth Street, Berkeley, CA 94710.  
All orders must be pre-paid. Check, money order, VISA and MasterCard accepted. Add shipping fees per item: \$0.75 4th Class, \$1.50 UPS, \$3.00 1st class/UPS Blue Label. California residents, add local tax.

Allow 4-6 weeks for delivery. Prices subject to change without notice.

Z80 and Z8000 are registered trademarks of Zilog Inc.

©1983 Osborne/McGraw-Hill

 Osborne/McGraw-Hill

\_\_\_\_ Please send me a free catalog Dept C-1

Name \_\_\_\_\_

Address \_\_\_\_\_

City \_\_\_\_\_

State \_\_\_\_\_ Zip \_\_\_\_\_


Indicate method of payment. \_\_\_\_\_ Check/Money Order  
 \_\_\_\_\_ VISA/Exp. date \_\_\_\_\_ MasterCard/Exp. date \_\_\_\_\_

Card # \_\_\_\_\_

Signature \_\_\_\_\_

QTY	ORDER #	PRICE

Tax \_\_\_\_\_  
 Shipping \_\_\_\_\_  
 TOTAL \_\_\_\_\_

 Osborne/McGraw-Hill  
 2600 Tenth Street  
 Berkeley, CA 94710



be used by dedicated full-time operators or by multifunction personnel? Should devices be located at the professional workstation, by secretaries, or perhaps only one should be assigned within a department?

Often, enormous flexibility can be achieved through the use of distributed information systems, which sometimes permit equipment to be located at great distances from the main computer.

During rapidly changing business conditions when inventory control is especially crucial, this sort of option can have enormous economic impact. As architecture falls into place, planners need to establish a system of priorities that combines the predetermined criteria for potential solutions and the interrelated business strategies they must address. Also, planners must begin working toward specific rather than general goals. Therefore, it is important that past work and estimates of future needs be checked for accuracy.

*Step 5. Define and address human resource issues.* The reaction of the

end user to automated office support systems must be considered, including behaviorism; staff orientation, training, and preparation; and habit changes. In fact, it is the people problems that are perhaps the most difficult issues to resolve.

New positions, new tools, and new roles for office staff are bound to create fear and concern among office workers. Job security status and salary issues will need to be addressed. In addition, human resources to undertake the physical conversion must be located and allocated to the tasks ahead. In this area, senior office systems practitioners must take a strong hand during the planning process. Subordinates and those with experience in early, less sophisticated office equipment may press for less than optimum solutions as they seek to defend or enlarge their own power—this can prove fatal in such a venture.

Senior office automation practitioners must consider whether current staff with expertise in the fields of data processing and word processing,

telecommunications, and the like have the abilities to move into crucial management roles in the new office structure. Often, new technologies involve massive and potentially dangerous change, and top management should view the decisions made on the issues of supervision, reporting, and authority levels to be as important as they would be when establishing a new division upon which the firm places major hopes for future profitability.

*Step 6. Select appropriate hardware.* Basic assumptions must now be made about the equipment itself. Key considerations are availability, level of support, price flexibility, and the performance of hardware, software, telecommunications, and related items. Architectural requirements will begin to emerge as the list of expected information flows is juxtaposed against technology assumptions. Negotiations with vendors must begin, equipment must be selected and displayed, and operating staff must be trained.

*Step 7. Design the management process cycle.* With a workable program for implementing office automation, planners still have not completed work on critical issues. An especially crucial consideration involves the management processes necessary if the new systems are to work at optimum and productive levels. A most common cause for failure in achieving hoped-for productivity gains from automated office equipment is not establishing new management systems that will provide smooth and efficient operations.

A number of critical new management processes must be developed to translate the plan into a successful set of operations. Cost audits and post-installation reviews need to be devised to enable the user to establish and maintain the cost-effective, efficient, service-oriented automated office environment. A permanent staff of service-oriented, technically knowledgeable, bottom-line-oriented personnel must be recruited or developed to manage the new systems.

*Step 8. Address key corporate issues.* Finally, identify and resolve organizational issues such as end-user

## **ALF COPY SERVICE**

**FAST • RELIABLE • LOW COST**

If you produce software, ALF's disk copying service is the quick, convenient answer to your disk duplication needs. Most orders are shipped in less than a week. Every disk we copy is verified bit by bit and guaranteed 100% flawless. Standard formats include Apple II (including nibble-copy proof and double-boot), Apple III, Atari, IBM, Osborne, and TRS-80.

Our "no frills" pricing means you don't have to buy extras you don't need — set-up charges are \$10 to \$25 per disk to be copied, copying charges are 30¢ to 40¢ per side (minimum: 50 copies).

Of course, we have the frills too — including custom printing and packaging. Call us today for complete details.

We also sell blank disks in bulk pack boxes of 100. All are 5¼", single sided, double density (except Nashua single density), unlabeled, with hub ring. Add \$7 per hundred for sleeves, \$2.50 per hundred for shipping.

<b>3M</b>	<b>\$165/100</b>
<b>CDC</b>	<b>\$165/100</b>
<b>MEMOREX</b>	<b>\$165/100</b>
<b>NASHUA</b> (double density)	<b>\$160/100</b>
<b>NASHUA</b> (single density)	<b>\$140/100</b>
<b>VERBATIM</b>	<b>\$185/100</b>

**ALF (303) 234-0871 1315F NELSON ST. DENVER, CO 80215**





# Technically, IDE's new Combination Board for the IBM PC is a knockout.



## It beats the knockout problem.

IDE's new Combination Board allows you to cable both serial and parallel interfaces from the back of the board itself.

So even if your IBM PC doesn't have a knockout at the back, you can now interface printers, disks, or communications devices. Without any troublesome jury rigging, without wasting expansion slots, and with the unit's protective cover still in place.

## It's a technical knockout.

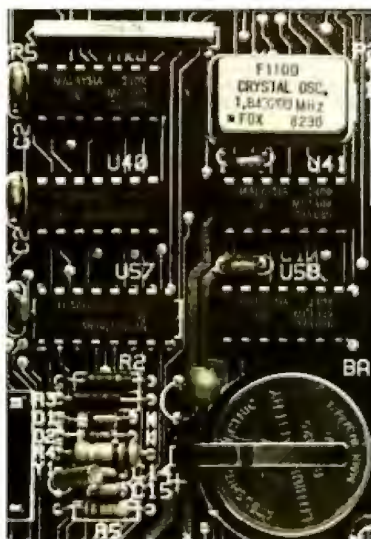
The interfacing innovations are only the beginning.

For the first time, you can get a Winchester disk drive interface on a combination board. Or you can use the same interface for a printer.

Only the IDE Combination Board gives you this capability.

And that's only one of 3 options

IDE offers. You can also add a serial interface (RS232C Cable Adapter included) and/or clock/calendar with battery backup.



## The price is a very nice touch.

To really be knocked out by the IDE Combination Board, just take a look at our price structure.

You buy only the options you want — so you never have to pay for something you don't need.

And with IDE's helpful upgrade policy, you can trade up your board for one with more memory or options. For very little money.

### Pricing table

Memory only:	One option:
64K \$275	Add \$75
128K \$385	Two options:
192K \$485	Add \$120
256K \$575	Three options:
	Add \$150

## A Combination Board this advanced deserves a lot behind it.

IDE backs up its new Combination Board with a one-year warranty...not just 90 days.

It's available for immediate delivery, and installation is free in major metropolitan areas.

So call us now to order your Combination Board. We'll answer any questions you have, and give you the name of your nearest IDE dealer.

He'll show you the new IDE Combination Board and the whole line of IDE products: Winchester disk drives, memory boards, printer spooler software, and disk-emulation software.

They're all technical knockouts.

**1-800-257-5027**  
(in MA call (617) 272-7360)

**IDE Associates**

44 Mall Road, Burlington, MA 01803



# IF YOUR COMPUTER'S IMPORTANT TO YOU *Insure It!*

Without SAFEWARE™ you could be uninsured. For as little as \$35 a year, SAFEWARE provides complete protection for all hardware, media and purchased software. Both business and home application. Call toll free today for more information or immediate protection. Columbia National General Agency, 88 E. Broad, Columbus, Ohio 43215. (In Ohio call 1-800-848-3112)

## 1-800-848-3469



### Introducing SPL the first multi-mode spooler for CP/M computers

If you believed that your computer couldn't do better than a single task system think again. You can convert your machine into a dual-task computer with SPL, the amazing Spooler program developed by Blat R+D. SPL enables you to use hidden capacity available on your CP/M computer to print documents and run your ordinary programs, all at once.

While printing, your regular programs won't stop processing, waiting for the printer to finish. SPL will store the information to be printed in internal or external (disk drives) memory until the printer is ready to receive the data. Result: your programs will run at full speed.

As SPL can use up to the full capacity of your disks for temporary storage, it's much more powerful than hardware spoolers, which are limited to 64k memory or less.

SPL is an advanced product with several modes of operation. In addition to intercepting the output to the printer, SPL can print your existing text files, or those that your programs will create from now on. SPL will even take care of tab expansion. As an added bonus, SPL needs no installation on most CP/M 2.x computers.

### If you have a computer **Get A Second Computer FOR \$139**



Registered Trademark of Digital Research

You could get an equivalent increase in computing power by spending \$1000 to \$3000, but SPL is only \$ 139, including disk and manual.

To order your SPL program call us today specifying what disk format you require. You can charge it to your VISA or Master Card if you prefer.

Blat Research+Development Corp.  
8016 188th SW, Edmonds, WA 98020  
Phone orders: [206] 771-1408

involvement, information policies, security standardization and operational responsibilities to ensure acceptance, and proper coordination and control of office automation strategies and implementation.

### Top Management Briefing

In summary, management must be aware that office automation is not simply the acquisition of new and better technology to achieve productivity gains. Equipment alone is not the answer, and management must stop the unplanned proliferation of machines to ensure a cost-justified, totally integrated, strategic approach to the office. A comprehensive program must be devised that will provide such key benefits as:

- standardized base line studies to ensure company-wide conformity and a base for future cost-justification
- compatible backbone equipment selection to allow for future systems integration
- bulk discount purchasing where feasible
- education and training programs for clerical, secretarial, and professional staff
- internal expertise in office technology to design and manage systems and benefits

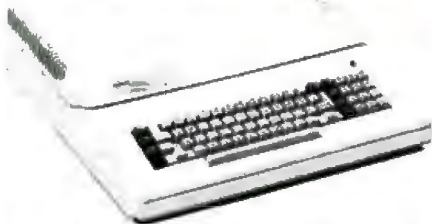
An office automation conversion cannot be successful without senior management guidance and support. While office automation offers an important strategic opportunity for business in the 1980s and promises increases in productivity, as with any new opportunity, only the best will manage to reap those benefits fully. Specific strategies and goals help to maintain viable operations and garner increases in output. The '80s will be the decade when automated tools will be mastered and accepted as commonplace in the office. Yet the process is bound to be a somewhat painful one; mistakes will be costly. Delay may be irresponsible; haste, catastrophic. Management must find an approach to best utilize new technologies to achieve that shimmering goal—increased white-collar productivity and profitability. ■



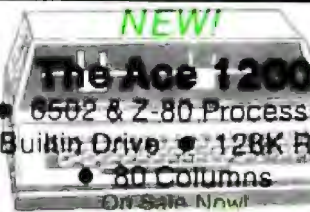
# COMPUTER SPECIALTIES

Circle 131 on inquiry card.

## FRANKLIN ACE1000



We Have An Ace Up Our Sleeve For You! Call For Sale Price Now!



NEW!

### The Ace 1200

- 6502 & Z-80 Processors
  - Built-in Drive • 128K RAM
  - 80 Columns
- On Sale Now!

## CALL BASIS 108 THE ALTERNATIVE

### CORONA

IBM® P/C Compatible.  
• Desktop with one 320K Drive  
128K Ram, Ser. & Par. Ports,  
Hi-Res Monitor, MS-DOS,  
Basic and Multiplan \$2550  
• Portable same components as the  
"Desktop" but portable \$1995

## SYSCOM SYSTEMS



New Apple Compatible System CALL!

### ACCESSORIES

Fourth Drive	279	Hayes 1200 Babd	939
Fourth Controller	89	Sooper Spooler (16K)	299
Rana Elite One	299	Z-80 by Microsoft	229
Rana Controller	89	Videoterm (80 col)	244
Micro Sci A-2	349	EPS Keyboard	318
Micro Sci A-40	349	The Grappler Plus	119
Trackball By T.G.	48	RGB by Electrohome	219
3" Drives by Amdisk	749	Parallel Card (8' cable)	69
New Vista Products...Call		Z-Card by ALS	139
Verisa Card	169	The CP/M Card by ALS	329
16K Ram (2yr WNTY)	59	Synthesizer by ALS	529
SoftCard Plus By MS	449	Joystick by TG	46
SoftCard Prem System	449	In Line Buffer	229
J-Cat By Nov	124	Disk Emulator (294K)	689
CPS Multi-Func by Mtn	169	Appit-Card 6M2	429
Micro Modem II	278	Expan Chassis by Mtn	539
Smart Modem	219	Winchester Hard Disk	CALL

\*APPLE IS A REGISTERED TRADEMARK

## Apple II



### SOFTWARE

Screen Writer II	103
Magic Window	69
SuperText II by Muse	118
BPI SOFTWARE	
Exec Secretary	119
Pro. Easy Writer	119
LetterPRFT/w/m	119
WORD HAND	
General Manager	119
Visicalc by Visicalc	239
PFS by Sofl Puf	109
Visifile by Visicalc	139
Visitrd/Visitpt by Visicalc	29
PFS Report	69
DB Master	164

PFS: Graph	89
Desktop Plan	184
Wall Street by M.L.	219

### CP/M® SOFTWARE

Basic Interpreter™	CALL
Basic Compiler by MS289	
Cobol-80 by Microsoft	539
Fortran-80 by Microsoft	446
Word Star	229
Mail Merge	159
Mail Star	159
Data Star	189
Color Star	99
Microcalc	212
Word II by Ashton-Tate	494
Word by Peachtree	CALL
Wordcalc by Peachtree	CALL
Wordcalc	CALL
Wordcode	239
The Programmer 82	109
Real Estate Analyzer	139
Real Estate Tricks	29
Graphix	27
Special Effects	27

### CALL FOR CATALOG!

\*CP/M is a Registered Trademark

## COLUMBIA

The Columbia MPC is IBM® P/C Hardware & Software Compatible. The Price? Non-Comparable! Save Hundreds and Call

## IBM-IBM-IBM-IBM-IBM-IBM-IBM

<b>AST</b>	<b>QUADRAM</b>
Combo Plus 64K (S/P) 349	Quadboard II 64K .429
Combo Plus 256K (S/P) 639	Quadboard II 256K .669
MegaPlus 64K (S/P) 459	Quad 512+64K .369
MegaPlus 256K (S/P) 749	Quad 512+512K 1049

<b>QUALITY COMP</b>	<b>TECMAP</b>
Big Rise .449	Complete Line CALL
<b>SAVONS</b>	<b>MBY</b>
5 MB Hard .489	Monte Carlo .399
10 MB Hard .889	Monte Carlo 256K .649
15 MB Hard .279	<b>VEREX</b>
Slave 5 MB .129	Baby Blue (4K & Z-80) .447
	Baby Blue-Rampole .659

### SOFTWARE

Visicalc (256K)	185	Vedit-86 by Cmpview	199
Word Star	249	The Programmer	369
Mail Merge	88	CP/M-86 by Digital	279
Peachtree Pkgs	CALL	Basic-80 by MSoft	297
Volks Writer	129	Fortran-80 by MSoft	419
Super Calc	217	M/Sort by MSoft	159
Easy Writer II	239	Easy by Denver	543
Home Acct. Plus	109	Mathemagic by ISM	69
CP/M-86 by Cmpview	299	Logon by Ferox	129
Vedit by Cmpview	129	Fastscreen by Cu	73

### CALL FOR CATALOG!

## FREE SHIPPING

### SALE KEYCOMP II

By Non-Linear Systems

The totally portable, powerful and profitable computer for your home or office.

- 280 • 64K Ram • Two 5 1/4" floppy disc drives (double density) • 8" video display (80 col)
- IBM 280 • Parallel Printer • Intermec

**SOFTWARE INCLUDED:**

- CP/M 2.2 • S/Basic • Profit Plan
- Perfect Water W/P • Perfect Calc
- Perfect Filer • Perfect Speller

## ZENITH

Z-100 All in One	129	Call
Z-100 Low Price	129	Call
Color Upgrade Kit	139	139
192 K Upgrade Kit	200	155
RGB Color Monitor	139	589
Auto-Dial Terminal (21-1-A)		589
System Software Pack #1 (Z55-100-1)		449
System Software Pack #2 (Z55-100-2)		299

### The Price/Performance Leader!

Eagle II	2495
Eagle III	3199
Eagle IV	4699
File 10	2450

New! Eagle 1600 (8086 Microprocessor) Call!

Free Brochure

## Commodore

Dataset	64
Disk Drive	469
Graphic Printer	319
16K Mem Expander	79
24K Mem Expander	139
IEEE-488 Card	69
6 Slot Expans	99
Afron Chassis	198
40/80 Col w/16K	229
40/80 Col w/64K	319
Wico Joystick Delux	37
Wico Trackball	59
Modem	95
Centronics Cable	69



## Commodore 64 On Sale . . . . \$399

Complete Catalog Hardware/Software FREE!  
NEW SX 100 PORTABLE with 5" Color and 1 Drive or with 5" Monochrome and 2 Drives

## ATARI 1200XL On Sale! 800 w/48K 529 400 w/16K . . . 229

410 Recorder	74	The Bookkeeper	194
810 Disk Drive	439	The Entertainer	69
825 Printer	639	The Educator	124
830 Modem	359	The Programmer	56
850 Interface	159	The Communicator	334
Full-View 80	979	Pac-Man	33
Joystick (P40)	45	Microball	26
48K by Intel	189	Chandler	27
32K by Microtek	99	Frogger	27
1010 Recorder	79	Gob	33
Epson Cable	34	Microsoft Basic	69

CALL FOR CATALOG!

## TERMINALS TELEVIDEO MONITORS TAXON PRINTERS OKIDATA

TVI 910	578	RGB Vision I	
TVI 910 Plus	699	RGB Vision III	
TVI 970	750	12" Amber	

319	52	549
319	2410P	2350
129	Microline 82	419

ORDER TOLL-FREE!! 1-800-854-2833

TO ORDER Phone orders invited using Visa Mastercard American Express or bank wire transfers Visa MC and American Express service charge of 2% Mail orders may send charge card number (include expiration date) cashiers check money order or personal check (allow 10 business days for personal or company checks to clear) Please add 3% (\$5.00 minimum) for UPS shipping handling and insurance COD's minimum \$250.00 with \$25.00 deposit All equipment is in factory cartons with manufacturer warranty Opened products not returnable Restocking fee for returned merchandise Equipment subject to price change and availability Retail prices differ from mail order prices \$40.00 min purchase \*With prepaid cash orders \*Exclude certain printers & monitors & foreign orders Calif residents add 6% State Tax For APO and FPO - add 10% \$25.00 min for postage Call residents add 6% Sales Tax include phone number credit cards not accepted Foreign Orders - include 3% handling shipped air freight collect credit cards not accepted

## COMPUTER SPECIALTIES

(619) 579-0330

MAIL TO: 1251 BROADWAY EL CAJON, CA. 92021



# ONLY

**THE NEW ATARI 1200XL HOME COMPUTER  
MAKES SOPHISTICATED GRAPHICS AND  
SOUND SO EASY TO PROGRAM.**

**ONLY** the new ATARI 1200XL Home Computer combines custom microchip technology with 64K RAM computing power to deliver graphics and sound capabilities that are so easy to program. The ATARI 1200XL has 11 graphics modes and 5 text modes. (The Commodore 64 and Apple II-e have only 2 graphics modes and 1 text mode.) Additional text and graphics modes allow users to easily program sophisticated graphics effects with relatively few commands, taking full advantage of the 256 color variations available. The sound capabilities of the ATARI 1200XL are also easy to program. Four distinct "voices" spanning 3½ octaves are controlled by a separate microchip, leaving the principal microprocessor chips free to perform other tasks.

**ONLY** the ATARI 1200XL offers a keyboard featuring 8 programmable function keys controlling 16 functions in a 64K computer. (That's twice as many as the Commodore 64). Four new function keys enable you to lock and unlock the keyboard electronically, disable the screen DMA for faster processing time, generate European language or graphics characters, turn the keyboard sound on and off or access the one-touch cursor control. The unique user-definable "help"

# THE NEW

key permits users to self-test ROM, RAM, audio-visual circuitry and keyboard functionality or call up assistance within complex programs. For even more help, Atari gives you a toll-free number to call for product and technical information (800) 538-8543; in California 1-(800) 672-1404.

**ONLY** the ATARI 1200XL offers you a home computer compatible with virtually all ATARI Computer peripherals and software (compatibility that other new computers like the Commodore 64 don't offer). There are over 2,000 programs and seven programming languages currently available for the ATARI 1200XL. New programs like AtariWriter™ and languages like ATARI Microsoft BASIC, Assembler Editor, PILOT, Pascal, ATARI BASIC, Forth, and Macro Assembler offer you even greater programming challenges and flexibility.

**ONLY** Atari puts so much more in the new 1200XL Home Computer so you get so much more out of it.



# ATARI® 1200XL™

## HOME COMPUTER





## TI's new Compact Computer. It takes over your work, not your desk.

The ordinary personal computer occupies too much of the ordinary desk.

Now Texas Instruments brings you a cordless compact computer that solves the same sort of problems as the Apple™ or IBM™ personal computer. It has enough memory and power for complex problems in business and science, yet the whole thing is smaller than a magazine page.

Sophisticated software is available right now for finance, statistics, production planning, graphics—and spreadsheet and wordprocessing are just around the corner.

For most personal computer tasks, its 6K RAM and 34K ROM are ample. The system is easily, economically expanded.

The TI Compact Computer 40 has peripherals that make it even more useful:

a 4-color printer/plotter; an RS-232 interface for talking with other computers or running a larger printer; and TI Wafertape™ drive for program or data storage. TI Solid State Software™ cartridges offer you a choice of convenient, foolproof programs.

Its built-in language is TI Enhanced BASIC, which allows you to write programs in everyday words. The integrated liquid crystal display shows 31 characters, which can be scrolled to show up to 80 per line. It operates on four AA alkaline batteries that give up to 200 hours of service.

The TI Compact Computer 40 offers solutions anywhere you go. Yet it retails for less than 1/3\* the price of Apple™ or IBM™ personal computers. The TI Compact Computer—compact in price and size, but not in power. See it soon at your Texas Instruments retailer.

Creating useful products  
and services for you.



# TEXAS INSTRUMENTS

Copyright © 1983 Texas Instruments

Circle 452 on Inquiry card.



\*Based on published manufacturer's suggested retail price.

Apple is a registered trademark of Apple Computer, Inc. IBM is a registered trademark of International Business Machines Corp.

**Thunder Tector**  
UNINTERRUPTIBLE POWER SUPPLY

TM



**DON'T BE LEFT IN THE DARK!**  
For \$295, you can protect YOUR  
Data, Time and Computer.

Protect your computer operation from loss of data files, lost keyboard input, and questionable integrity of stored information due to power failure. Operation is completely automatic, just attach your own 12V battery, or purchase below.

Available for:

**Apple, Radio Shack, IBM, Olivetti,  
and most other personal and business computers.**  
Specify equipment to be attached when ordering.

If not completely delighted, return in original condition within 30 days for refund. Ten percent restocking fee will be charged. Ninety-day factory warranty.

Gel battery pack available with cables: 1-amp. computers - \$65; 2-amp. computers - \$111.

For fastest delivery, send certified check or money order payable to "Thunderhawk." Send 10% with C.O.D. orders. Sent FOB, Texas. Price subject to change without notice. Texas residents add 5% sales tax. Broad selection of power ranges available for larger computers — call for prices.

DEALER INQUIRIES INVITED — send on letterhead.

**Thunderhawk Manufacturing (214) 586-6256**  
A Division of Thunderhawk Corporation  
P.O. Box 573  
Jacksonville, TX 75766

© 1983 Thunderhawk Corporation

gram under an old name from Information Unlimited Software (IUS); Volkswriter, from Lifetree Software; Wordstar, from Micropro International; and The Final Word, from Mark of the Unicorn.

### Preliminary Cautions

A word-processing program is a tool, and, just as you choose a hammer that fits your hand, you should choose a program that fits both the job to be done and your working style. That means you should try out the software before you buy it. Most computer users will certainly want to buy their word-processing software from a retail computer store or dealer, not only to try out the program before buying but to be able to ask questions there after the purchase. The state of the art in user's manuals is still not sufficiently advanced that I can recommend giving a new program to an inexperienced user without a live person somewhere around to give advice and render help.

---

**Four major users of word processors: an author of magazine articles, a marketing manager doing mass mailing, a personal secretary, and a newsletter editor.**

---

As many different word-processing jobs exist as there are things that people want to write. But the capabilities you may need in a system do fall into a few broad categories. For instance, Dr. Larry Press, in a 1980 article in *onComputing* magazine (precursor to *Popular Computing*, see reference 8), outlined four major kinds of word-processing work, typified by four users: an author writing long continuous articles, a marketing manager doing mass mailings of form letters, a secretary typing many short personalized letters, and a newsletter editor concerned about document merging and exact formatting.

There are also a number of ways to test word-processing programs. Some authorities count the number of available features; some weigh the balance of features for different tasks. Some people look for only one or two features that may be vital in certain jobs; others avoid characteristics judged undesirable. No list of features can fully capture the feel of using a program, just as knowing the weight and length of a hammer gives you only a rough idea of what it will feel like to pound a nail with it. My method of evaluating these programs has been partially subjective, and here I should state my prejudices.

Although I have on occasion done work similar to that of each of the four hypothetical users above, my everyday use of a word-processing program is closest to that of the author: writing, rewriting, and editing lengthy articles. The first program I ever used was Magic Wand running on a Z80-based CP/M-80 system with a Cops-10 video terminal. (Magic Wand, now called Peachtext by its distributor, Peachtree Software, is not reviewed here because a version of it was not available for the IBM Personal Computer when I started this project.) I am a



NEW FOR APPLE II AND IIe

# WILDCARD™

## MAKES BACK-UP COPIES OF PROTECTED SOFTWARE QUICKLY, EASILY, WITH JUST A PUSH OF A BUTTON.

New software locking schemes have rendered even the latest generation of copy programs virtually unusable. Locksmith™, Nibbles Away™ and other "Nibble copiers" require complicated parameter settings, much patience and great effort to use. More often than not, the results are disappointing. WILDCARD is different. Rather than copying disks track by track, WILDCARD ignores the disk and any copy protection encrypted on it. Instead, WILDCARD takes a snapshot of memory in your Apple® II.

Now you can make back-up copies of protected software with the push of a button.



Software is not copy protected. System requirements: Apple II Plus with 64K and DOS 3.3 or Apple IIe. Franklin Ace also supported.

\*Wildcard does not operate with CP/M® or other microprocessor based software.

### FEATURES

- Hardware copying device... push button operation.
- Copies 48K memory resident software, most 64K software.
- No programming experience or parameters necessary.
- Backs up DOS 3.2 and DOS 3.3 disks.
- Creates DOS 3.3 unprotected and autobooting disks.
- WILDCARD lives in any slot. Undetectable by software.
- Produces autobooting disk in 2 minutes.
- Copies are DOS 3.3 compatible.
- Copies become accessible for alterations.
- Simple, easy-to-use software included.

### WILDCARD Utility Disk 1 also included, featuring:

- Automatic program compression and BRUN file maker.
- Multiple programs can be placed on the same disk.
- Recreates basic files to load and save.
- Files can be placed on a hard disk...and more.

### WILDCARD

\$139.95

Order direct from East Side Software Co., 344 E. 63 St., Suite 14-A, New York City 10021, 212-355-2860. Please include \$3.00 for shipping and handling. Orders outside continental U.S. please add \$10.00 for shipping and handling. Mail and phone orders may be charged to MasterCard and VISA. N.Y. State residents add sales tax. Dealer inquiries welcome.

**IMPORTANT NOTICE:** The WILDCARD is offered for the purpose of enabling you to make archival copies only. Under the Copyright Law you, as the owner of a copy of a computer program, are entitled to make a new copy for archival purposes only and the WILDCARD will enable you to do so. The WILDCARD is offered for no other purpose and you are not permitted to utilize it for any other use, other than that specified.

Apple and the Apple logo are registered trademarks of Apple Computer, Inc.—CP/M—trademark of Digital Research, Inc. Locksmith—trademark of Omega Microwave, Inc. Nibbles Away—trademark of Computer: applications.

## At a Glance

### Name

Easywriter II

### Type

Word-processing program

### Manufacturer

Information Unlimited Software Inc.  
2401 Mannship Way  
Sausalito, CA 94965  
(415) 331-6700

### Price

\$350

### Format

Two 5 1/4-inch floppy disks

### Language

C (source code not available)

### Computer

IBM Personal Computer

### Documentation

User's manual: 92 typeset pages in small loose-leaf binder;  
function-key sticker

### Audience

Beginning users of word processing

moderately fast touch-typist (I usually can type faster than I can think), and I like to place the detached keyboard in my lap.

Simply using Easywriter II, Volkswriter, Wordstar, and The Final Word was the most important test I could put them to, but my conclusions are inevitably affected by the factors I've listed above. Your needs and desires will inevitably differ from mine. That's all the more reason to try any program before you buy.

## Easywriter II

Only the name is the same here. Easywriter II is a completely different program from the Easywriter sold by IBM. The II suffix is intended to distinguish this Easywriter package, written in the C language for IUS by the Basic Software Group, from the IBM-distributed program (Easywriter 1.0 and Easywriter 1.1), written in FORTH by Cap'n Software. Easywriter II is being sold directly by and through the dealers of Information Unlimited Software Inc., not by IBM.

Information Unlimited Software certainly has learned from IBM how to package Personal Computer software; Easywriter II is sold in a boxed, 9 1/4- by 8-inch, linen-covered loose-leaf binder that is perfectly coordinated in appearance with IBM's Personal Computer documentation.

IUS was not able to coordinate certain other characteristics of its new program quite as well, at least at first. In

# FREE SHIPPING

## IBM® Personal Computer Products

Davong 5 MB Hard Disk System — \$1495.00 12 MB — \$1995.00  
IBM PC-2 Drive System \$ CALL

### Quadram — Quadboard with Parallel

Port, Serial Port, Clock/Calendar, Expandable to 256K

64K on brd. — \$425.00 128K on brd. — \$530.00  
192K on brd. — \$629.00 256K on brd. — \$719.00

### Quadram Memory Expansion

192K Maximum  
64K on brd. — \$230.00 128K on brd. — \$350.00  
192K on brd. — \$499.00

### Amdek Monitors

Mod 300 Phosphor — \$150.00 Composite Color III — \$345.00  
IBM RGB Compatible Color II — \$850.00 Color I — \$300.00

### IBM/TRS 80 Disk Drives/Cabinets

TM 100 Single 40 Track Drive — \$169.00  
TM 100-2 Double 40 Track Drive — \$280.00

## Apple II® Computer Products

### Syscom Apple Compatible System... \$695

Apple Compatible Controller Card..... \$ 79.95  
Apple Compatible Disk Drive w/Cabinet & Cable..... 249.00  
w/Controller..... 315.00  
Printer/Graphics Interface..... 99.95  
Davong 5 MB Hard Disk System — \$1495.00 — 12 MB — \$1995.00  
Apple Compatible Joysticks..... 29.95

### Epson/Smith-Corona Printers

MX80 \$425.00 FX80 \$550.00 MX100 \$640.00  
TRS 80 / Parallel Printer Cable \$20.00  
IBM Parallel Printer Cable \$35.00



STAR MICRONICS GEMINI 10 \$ CALL  
GEMINI 15 \$ CALL

Smith Corona TP-1 Letter Quality Daisy Wheel..... \$575.00

TRS-80 MOD III Drives w/RS 232..... \$1650.00

### TRS-80 MOD III Disk Controller

Includes Disk Controller, Power-Supply, Mounting Hardware, Cables and Instruction Manuals..... \$239.00  
COMPLETE

Dual 8" Slim Line — \$100.00 — Dual 5 1/4" Slim Line — \$ 99.00  
Single 5 1/4" Slim Line — \$ 69.00

AST MEMORY EXPANSION PRODUCTS \$ CALL

**JMR POWER SUPPLY AND CABINETS**

**DATA-MAIL**  
P.O. Box 818, Reseda, CA 91335  
1-800-635-5555

VISA, MASTERCARD (\$100 Min., Add 2%)  
Or Certified Check  
90 Day Warranty (Parts & Labor)  
TRS 80 is a Registered Trademark, Tandy Corp.  
Prices Subject to Change Without Notice

FREE SHIPPING IN CONTINENTAL U.S.  
(TRS 80 MOD III EXCEPTED)

**(213) 993-4804**  
(IN CALIF.)



## Word Tools for the IBM Personal Computer

Richard S. Shuford  
Special Projects Editor



Photo 1: Four currently available word-processing programs for the IBM Personal Computer (Model 5150): Easywriter II, from Information Unlimited Software; Volks-writer, from Lifetree Software; Wordstar, from Micropro International; and The Final Word, from Mark of the Unicorn. (All photos by Ed Crabtree.)

The BYTE editorial staff was clustered in the computer lab eagerly watching text scroll up the screen of a video display. The date was August 13, 1981, and we were watching Phil Lemmons' first report on the announcement of the IBM Personal Computer (reference 6) come in through a modem connection.

"Aha," someone said, reading from the screen, "IBM is offering an impressive set of software: Microsoft BASIC, Visicalc, the Peachtree business package, UCSD Pascal, CP/M-86, and . . . Easywriter?" We were sufficiently surprised at the appearance of this program from the realm of Apple computers that we

later called Phil to double-check; the Easywriter word-processing program, from Information Unlimited Software, just didn't seem to fit with the other pieces of software in that initial announcement.

Before long, many purchasers of the IBM Personal Computer (PC) were also surprised by Easywriter, and unpleasantly so. The first Easywriter package, Version 1.0, quickly developed a reputation for user-unfriendliness and annoying bugs. Eventually IBM released the improved and more reliable Version 1.1, but the impression had been made and many independent developers of software perceived a ripe opportunity to sell an alternative word-processing program for the IBM PC.

In trying to seize this opportunity, some developers rushed dubious programs to market in the guise of word-processing software. But enough time has now gone by that a state of dynamic equilibrium (although certainly not a state of calm) has settled over the market for IBM PC word-processing programs, and most users will be able to find a program that meets their needs. In this article, I'll tell you about four candidates: Easy-writer II, a new and different pro-



## HIGH TECHNOLOGY PRODUCTS & SERVICE FROM THE HIGH COUNTRY

### IBM-PC HARDWARE

#### PRINCETON GRAPHICS SYSTEM

PGS HX12 RGB Color Monitor  
THE High Resolution Monitor for your IBM-PC.  
100% IBM Compatible, includes cable  
690 Dots Horizontal Resolution ..... CALL

#### QUADRAM CORPORATION

Quadboard Multifunction Board  
Full expandability from 64K to 256K  
Parallel Printer Port  
Asynchronous RS232 Serial Modem Port  
Programmable clock/calendar  
Ram Disk Drive (software)  
64K starts at ..... \$429.00  
Microfazer Printer Spooler  
Print Buffering from 8K to 64K  
One Model goes to 512K!  
Any printer/computer combo  
Why wait on your printer?  
(All prices include power supply)  
8K Epson Snap-On ..... \$139.00  
8K par to par w/copy ..... \$149.00  
8K ser to par w/copy ..... \$169.00  
8K par to ser w/copy ..... \$179.00  
8K ser to ser w/copy ..... \$169.00

#### DAVONG SYSTEMS

Hard Disk Drive / Can be internal  
Complete package includes  
Drive, controller, power supply,  
software and documentation  
5, 10 or 15 meg  
5 meg ..... \$1594.00

#### THE XEDEX FAMILY

Baby Blue™ CPU Plus  
Get CP/M + 64K of main memory ..... CALL

#### TANDON TM100-2

Industry Standard 320K Drive  
Fully IBM Compatible ..... ONLY \$259.00

#### TANDON "SLIM-LINE" TM50-2

Put Two in One Slot! ..... CALL

#### MAYNARD ELECTRONICS

Floppy Disk Controller Card  
Parallel or Serial Port  
w/parallel ..... \$229.00  
w/serial ..... \$259.00

#### CORONA DATA SYSTEMS

Hard Disk — 5 or 10 meg  
Seagate Technology w/Data Guard  
Comes initialized!  
ROS networking available  
16 operating systems in dynamic partitions  
Includes CP/M and Pascal extensions  
5 meg \$1539.00 10 meg \$1969.00

#### COLUMBIA DATA SYSTEMS

IBM compatibility in a Multi-User 16 bit  
computer 128K two serial ports parallel port  
and 8 exp slots Runs MS-DOS, CP/M 86 or  
MP/M 86, OASIS 16 ..... CALL

### IBM-PC SOFTWARE

#### BUSINESS & PERSONAL

Applied Software Tech., Versalom ..... \$319.00  
Ashion Tale, D BASE II ..... \$469.00  
Requires PC-DOS & 128K  
Continental, Home Accountant Plus ..... \$99.00  
Denver Software, EASY™ ..... \$549.00  
Eagle Software, Money Decisions ..... \$145.00  
HowardSoft, Real Estate Analyzer II ..... \$189.00  
Info. Unlimited, Easy Writer II ..... \$245.00  
Easy Planner ..... \$143.00  
Easy Speller ..... \$128.00  
Easy Filer ..... \$295.00  
Micro Pro, Wordstar ..... CALL  
Peachtree, GL AR AP ..... \$372.00  
Sorcim, Supercalc ..... \$220.00  
Superwriter ..... \$294.00  
Visicorp, Viscalc 256K ..... \$199.00  
Videx ..... \$199.00  
Vistatext/Vistapl ..... \$232.00  
Vistatext ..... \$232.00  
NOT LISTED? ..... CALL

#### GAME SOFTWARE/HARDWARE

Auto. Simulations, Oil Barons ..... \$74.00  
Temple of Apshai ..... \$29.00  
Circle of Ra ..... \$15.00  
Avston Hill, Galaxy ..... \$19.00  
Midway Campaign ..... \$16.00  
Fantastic, Snack Attack II ..... \$29.00  
Infocorn, Deadline ..... \$37.00  
Starcross ..... \$29.00  
Zork I, II, III, each ..... \$29.00  
Innovative Designs, Pool 15 ..... \$25.00  
Microsoft, Flight Simulator ..... \$39.00  
Sierra-On Line, Ulysses ..... \$29.00  
Crossfire ..... \$22.00  
Sirius, Gorgon ..... \$29.00  
Spinaker, Snooper Troops, 1 or 2, ea ..... \$35.00  
Story Machine or Face Master ..... \$25.00  
M&R Enterprises, Super Mod ..... \$55.00  
TAG, Joysticks ..... \$45.00  
Trak Ball ..... \$47.00  
Tech, Adam & Eve Paddles ..... \$29.00

★★★★ MILE-HIGH SAVER ★★★★★

**TEAC HALF-HEIGHT 320K DISK DRIVE**

IBM COMPATIBLE PUT TWO IN ONE SLOT! HIGH RELIABILITY

5 1/4" FD658 DS/DD LOW POWER DRAIN QUIET

**ONLY \$279.00**

★★★★★★★★★★★★★★★★★★★★

### APPLE/FRANKLIN HARDWARE

★★★★ FOURTH DIMENSION SYSTEMS ★★★★★

**DISK-DRIVE PRICE BREAKTHROUGH**

**SUPER DRIVE — Plug-In Apple Compatible Add-On**

**PLUS one box of Elephant Diskettes SS/DD**

**\$269.00**

WITH CONTROLLER, ADD \$55.00 WITH CONTROLLER, DOS & MANUAL, ADD \$90.00

#### RAMA SYSTEMS

Eite Series  
300% faster than Disc II  
Advanced write-protect features  
Exclusive centering device-gentler, more accurate  
Eite I (up to 163K) ..... \$289.00  
Eite II (326K) ..... \$469.00  
Eite III (652K) ..... \$609.00  
Four Drive Controller ..... \$99.00

#### MICROSOFT

A2 — 100% Apple Compatible  
Proven performance  
Add-On Drive ..... CALL  
Drive w/controller ..... CALL  
**VISTA COMPUTER CO., INC.**  
**PRESENTS THE V1200:**  
Removable mass storage for your Apple!  
6 meg (formatted) per cartridge  
Comes complete w/disk, cable, controller,  
software and one 6 meg Vistapak cartridge  
All for only ..... \$1195.00

### FRANKLIN ACE

**THE APPLE II+/III ALTERNATIVE**

**ACE 1000** Upper and Lower Case Automatic Repeat Numeric Keypad Larger power supply with fan 64K on mother board CALL for Special package price

**ACE 1200** Move over II! 128K RAM on Board 80 columns Z80 Chip for CP/M Built-in drive, built-in color Serial and parallel interface CALL for price w/monitor!

**NEC APC**  
The Advanced Personal Computer 128K—expands to 256K 1 Megabyte storage per disk Detached Keyboard with Keypad 22 Programmable Function Keys Superior Resolution — 640 x 475 CALL FOR PRICES!

CALL FOR LOW APPLE SOFTWARE PRICES

### HIGH TECH OF THE MONTH

**STB SYSTEMS, INC. "Super-RIO"™ Card**

**THE TRULY ULTIMATE IBM PERIPHERAL**

**EIGHT- FUNCTIONS ON ONE BOARD**

- 64-256K
- Add 64-512K w/ "Super RIO Piggyback"
- (Optional) — Fits on Super RIO — Up to 768K
- Two RS232 ports • One parallel port
- Game port (Apple or IBM joysticks)
- Up to 64K printer spooler
- RAM disk drive • clock/calendar

**TRULY A WINNER!**  
Call for Price  
**Simply The Best!**

### PRINTERS

#### DOT MATRIX

**C. ITOH**  
Prowriter I - par ..... CALL  
Prowriter II - par ..... \$699.00

**EPSON**  
FX 80 ..... CALL

**IDS, Prism & Microprism** ..... CALL

**OKIDATA**  
82A ..... \$419.00  
83A ..... \$689.00  
84 par ..... \$1055.00  
92 par ..... CALL  
93 par ..... CALL

**STAR MICRONICS**  
Gems 10 ..... CALL

Quantities  
7030 ..... \$1695.00

#### LETTER QUALITY

**BROTHER HR-I** ..... \$884.00  
**BYTEWRITER** ..... \$599.00  
**C.I.TOH**  
Starwriter F 10 par ..... \$1389.00

**NEC**  
7710 /730 ..... \$2291.00  
3550 IBM plug-in ..... \$1899.00

### MONITORS

**AMDEK, 300 Amber** ..... \$159.00  
300 Green ..... \$155.00  
310, A, G IBM including cable ..... \$179.00  
Color I, composite ..... \$344.00  
Color II RGB (IBM compatible) ..... \$744.00

**BMC, Green** ..... \$88.00

**NEC, 1201 Hi-Res Green** ..... \$169.00  
1201 Color composite ..... \$329.00  
1203 RGB (IBM compatible) ..... \$659.00

**TAXAM, Amber** ..... \$129.00  
Green ..... \$119.00  
RGB III (IBM compatible) ..... \$560.00

**USI, Pr 3 Amber** ..... \$155.00  
**ZENITH, Green Med-Res** ..... \$118.00

### DISKETTES & STORAGE

**DYSAN, 10 each 5 1/4" SS/DD, DS/DD** ..... CALL  
**ELEPHANT, 10 each 5 1/4" SS/DD** ..... \$23.95  
10 each 5 1/4" DS/DD ..... \$34.95  
**VERBATIM, 10 each 5 1/4" SS/DD** ..... \$26.95  
10 each 5 1/4" DS/DD ..... \$39.95

**LIBRARY CASE, 5 1/4"** ..... \$2.50  
**DISK BANK, 5 1/4" Interlocking swivel** ..... \$5.50  
**DISK FILE, 5 1/4" Elephant "The Trunk"** ..... \$21.95

### APPLE EXTRAS

**16K RAM EXPANSION**  
Microsoft ..... \$75.00  
Microtek ..... \$72.00

**80 COLUMN CARDS**  
Videx ..... \$249.00  
Vista ..... \$225.00  
Wesper Wizard 80 ..... \$169.00

**PRINTER INTERFACES**  
Microtek, RV611C par ..... \$63.00  
Dumping GX w/graphics ..... \$105.00  
Dumping w/16K Buffer ..... \$160.00  
Grappler ..... \$119.00

### MODEMS

**HAYES**  
Smartmodem 300 ..... \$211.00  
Smartmodem 1200 ..... \$535.00  
Micromodem II ..... \$275.00

**NOVATION**  
CAT (Acoustic) ..... \$153.00  
D-CAT ..... \$188.00  
Auto Cat ..... \$219.00  
Apple Cat II ..... \$273.00  
212 module (1200 baud for Apple Cat II) ..... \$354.00  
212 Apple Cat II ..... \$626.00

## Rocky Mountain Micro, Inc.

**MAIL ORDERS:** 10890 E. 47th Ave.  
Denver, Colorado 80239

#### TERMS AND CONDITIONS:

- All prices reflect a 3% cash discount
- Personal checks (allow 10 days to clear), VISA, MasterCard, wire transfers, include telephone number
- COD orders accepted — \$300 maximum — \$10 surcharge • All products factory sealed with manufacturer's warranty
- PO's accepted from qualified customers • Approval needed on all returns • 10% restocking charge unless defective, plus shipping • All Colorado residents add 3 1/2% sales tax, City and County of Denver residents additional 3% sales tax.
- Shipping Costs 2% UPS Ground UPS Blue Label — rate quoted at time of order.
- All prices subject to change without notice • Lease/financing available
- Export orders accepted from foreign dealers Contact F L Kleinberg & Co TWX 910-940-2517
- Telephone Order Desk Hours: 8 AM to 8 PM, Monday through Friday, 10 AM to 4 PM, Saturday, Mountain Standard Time. CIRCLE 495 ON INQUIRY CARD FOR COMPLETE "LINE CARD"

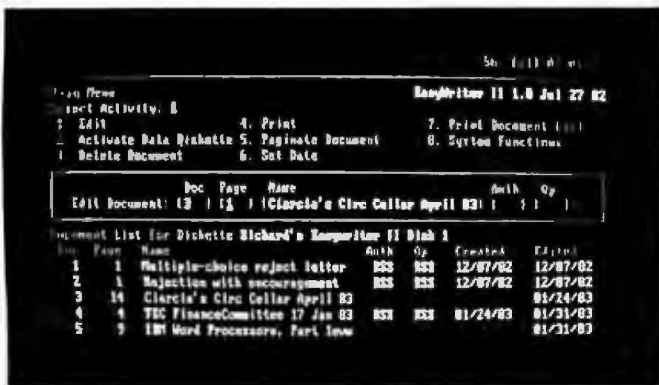
**NATIONAL ORDER DESK:**

# 1-800-862-7819

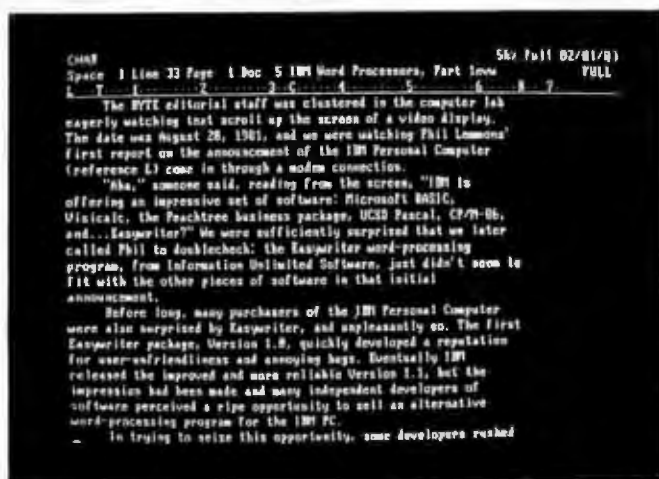
IN COLORADO CALL: 303-371-2430

**YOUR SATISFACTION IS OUR BEST ADVERTISING WE SERVICE WHAT WE SELL**





**Photo 2:** The first thing Easywriter II does is give you a menu of possible activities. The special file system keeps track of a certain amount of document history, as you can see here from the directory of one disk. Two of the documents were "imported" to the Easywriter II disk environment from a PC-DOS disk; therefore, parts of their histories are missing. The file names appear on the screen in bright-intensity characters, most other things in normal intensity. You call up a document by typing only its number, not its full name. This photo was taken from the screen of an IBM Monochrome Display, as were all other screen shots in this article except photo 13.



**Photo 3:** A typical editing screen display produced by Easywriter II. The top three lines of the screen are used to show a variety of status information and transient messages, including the current text-object mode (CHAR for character), percentage of the document disk used (56 percent), the current date, the cursor position ("Space" means column), the current page number, the name of the document, an indication of space left in the current page, and a tab ruler. All characters have normal video attributes (not especially bright, inverted, blinking, or otherwise).

the version I tested, the biggest such discontinuity was that Easywriter II did not run under PC-DOS (also known as MS-DOS, the most widely used disk operating system for the IBM Personal Computer). It ran in its own disk environment, storing its files in an incompatible format and requiring that floppy disks be specially formatted for storing documents.

The unique disk environment caused other problems. The Easywriter II software was divided onto two disks: a

"system" disk and a "housekeeping" disk. Even such a simple operation as copying document files required an annoying number of manual disk changes, and operation on a single-disk-drive system was impossible. Only single-sided floppy disks were supported, with a capacity of less than 100,000 bytes' worth of documents on one disk (on a double-sided drive, only one side was used). A utility program on the housekeeping disk converted Easywriter II files to PC-DOS format and vice versa, but it could copy correctly only onto single-sided disks; this undocumented fact caused me some frustration. "Importing" a 21,504-byte file to an Easywriter II disk took 2½ minutes.

At least one of the effects of the Easywriter II disk structure was good. The structure allowed long (30-char-

## Easywriter II depends heavily on the use of on-screen menus and function keys.

acter) document names (like "TEC FinanceCommittee 17 Jan 83") and the keeping of a certain amount of document history; author's and typist's names, size in pages, and dates (but not times) of creation and last modification (see photo 2). Each document on a data disk was assigned a sequence number by the system, so that you did not have to type those long file names; you referred to documents by number.

The verbs in the preceding section are intentionally past tense. According to a telephone conversation I had with a representative of IUS, a new version of Easywriter II should be available by the time you read this. The new version is intended to run under PC-DOS, and most, if not all, of the inconveniences caused by the disk environment should be removed.

I found the editing command structures in Easywriter II to be quite different from those of the other microcomputer word-processing programs I have used. Easywriter II is organized around pages and modes. The computer's video-display screen is used as a window onto one page of the document (see photo 3); normally, you can scroll only up and down on this single page, and you have to issue an explicit command to move to the next page or a previous page, either of which takes about 4 seconds. The most text you can cram into one logical page is about 200 lines, and the computer will remind you of every line entered on a page past line 54 (or a number you set).

The action of any editing and most cursor-movement commands depends upon the current object mode. Seven possible modes each correspond to one defined text object (character, word, sentence, paragraph, line, block, and page). Each command acts upon the object named by the mode currently in effect. To select the object mode, you press one of the 10 assignable-function keys (F1 through F10) on the left side of the keyboard or, in some cases, a function key plus the Shift key. Some of the more dangerous operations (like delete page) require explicit

# The best thing next to a computer.

Whatever your computer system or its purpose, put a PRINTEK professional printer beside it for more versatile performance, greater reliability, and superior value.

## The single printer solution for...

- **Spread sheet specialists:** to 227 cols, 16" paper, 6 copies.
- **Word processing professionals:** near-letter quality, 45 cps (model 910) and 80 cps (model 920), true descenders, proportional spacing, underlining, 2 standard fonts, 2 optional fonts, 4 vertical spacings, 8 character sizes.
- **Data crunchers:** 200 and 340 cps models, 160-260 lines per minute typical, 7 foreign character sets, downloadable for special sets, 2-8K buffers to keep the speed up.
- **Graphics artists:** dot addressable, full raster, 144x144 or 72x72 resolution for fine detail and shading of charts.

## Full-featured and reliable...

- **Great office mates:** office quiet, typewriter size, easy-change cartridge ribbons, front panel accessible operator controls and indicators, intelligent microprocessor control, self diagnostics, easy interfaces.
- **Ready to work everywhere:** multiple voltage power supply, regulatory compliance (FCC, UL, CSA, VDE).
- **One year print head warranty:** over 125,000 text pages.
- **2500 hours MTBF:** nearly two years between service calls.
- **Quality U.S. manufacture:** extensive quality control plus days of continuous tests of circuit boards and complete units.

## The affordable professionals...

Model 910, \$1595 list. Model 920, \$2395 list. See your dealer.

PRINTEK, Inc., Benton Harbor, Mich. 49022 616/925-3200

**printek**   
best thing next to your computer

Dealer  
inquiries  
invited





HARD DISK SUPPORT RACET COMPUTES = HARD DISK SUPPORT RACET COMPUTES = HARD DISK SUPPORT RACET COMPUTES = HARD DISK SUPPORT RACET COMPUTES = HARD DISK SUPPORT RACET COMPUTES =

## FIELD PROVEN HARD DRIVES

**5 to 240 MEGABYTES ON LINE** for the TRS-80\* Mod II/XVI  
Winchester and Cartridge Disk Drives available for immediate delivery!!

**5 MEGABYTE FOR Mod I, II, and III**  
**CALL FOR PRICING**



**14+ Megabyte (formatted) ARM Winchester Disk Drive** CALL for Pricing  
Includes ECG error detection and correction. FAST, Service Contract Available (\$30/month/drive). Multiplexor available. SHARE hard drive between four Model II's!!

**20 Megabyte CII Honeywell Bull Cartridge Drive** \$7995  
10 Megabytes fixed, 10 removable for the professional installation requiring Removable Media for BACKUP. 60 and 120 Megabyte add-on drives available. Up to 240 MEGABYTES!! Four port multiplexor available to SHARE hard drives.

### HARD/SOFT DISKS SYSTEM (HSDS) SOFTWARE

Radio Shack 2.0 Compatible Operating System for Hard Drive Operation. Run your 2.0 software on hard drives without conversion (except drive designation). Compatible with most machine language programs that use the standard calling sequence. Supports ARM, Cameo, Cynthia Bull, Corvus, Data Peripherals, QCS, Radio Shack, and certain other hard drives.

Access BOTH your floppy disk drives and hard drive files **INTERCHANGEABLY!!** Complete utilities include HZAP (Hard Disk SUPERZAP), Directory Catalog System, Parameterized FORMAT, HPURGE (Bulk Copy/Purge Utility) and others.

The Hard/Soft Disk System (HSDS) Software has almost two years **FIELD** experience. Version 5.0 adds several enhancements including maintenance of system files on the hard drive, files as large as the disk, the ability to segment the disk as logical drives, and definable directory size. Floppy backup (close to a Megabyte per minute) is provided for Winchester drives.

HSDS for Radio Shack \$500  
HSDS for Other Drives \$400

**RACET COMPUTES LTD.**  
Integrity in Software

1330 N. Glassell, Suite M, Orange, CA 92667 (714) 997-4950

**CALL FOR COMPETITIVE PRICING ON HARD DRIVE SUBSYSTEMS —**  
**BUY WHERE YOU CAN GET SOFTWARE SUPPORT!!**  
**DEALER AND SYSTEM HOUSES — WE HAVE DEALER PRICING!!**  
CIRCLE READER RESPONSE FOR FREE TRS AND NEC CATALOG.

\*TRS-80 is a trademark of Tandy Corporation.

HELP For help, select an editing command or one of the choices listed below: (press ESCAPE to edit)

Editor	3. Editing Keys	5. Fonts
1. Status Lines	4. Page Formatting	
2. Cursor Control		

**MERGE** copies text from one place to another. The amount of text merged at one time is limited by the page size.

#### To Merge

- Mark merge text with TAGS. (See TAG.)
- Edit destination page.
- Press MERGE when the cursor's on the line ABOVE the point you wish text inserted.
- Enter - the drive number, then press TAB to move to the next blank - the number of the source document - the TAG name. All text UP TO THE NEXT TAG will be copied.
- Press RETURN, then press ESCAPE to continue editing.

Photo 4: Easywriter II relies heavily on "help" screens to coach new users on how to use the system, rather than lengthy chapters in the written documentation or online tutorial files. After you hit the F2 function key, you are presented with a menu of possibilities. Shown here is the explanation of the merge function.

confirmation. The keys of the numeric/cursor-control keypad on the right are also used.

Easywriter II depends quite heavily on use of both on-screen menus and the function keys. The use of menus is common enough, but use of the function keys deserves some attention. The assignable keys F1 through F10 are used both unaugmented and along with the Shift and Alt (alternate) keys. IUS provides a reference sticker as an aid in remembering what the function keys do, and I gather that you are supposed to affix the sticker to the front panel of the IBM PC system unit, between the disk drives and the IBM nameplate. The sticker has one great deficiency: it's too small. The words within the key outlines seem to be in 5-point type and are impossible to read without leaning up close.

The page orientation, the object modes, and the heavy, enforced use of the function keys combined to make me dislike editing with Easywriter II. I don't put much significance on page divisions in the documents I write and edit (this article, for instance), and it's much more convenient to be able to scroll up and down through a large buffer containing the whole document. And with Easywriter II, block-move and block-copy operations cannot occur in block sizes greater than one page.

When editing text, I like to make both large and small changes in the same pass through the text. Easywriter II assumes that you will make changes mostly at the level of one text object at a time. I also found myself forgetting what mode was in effect (even though a status line on the screen indicates this) so that I often changed the wrong text object. Furthermore, I like to leave my fingers in the home position on the keyboard, so that I'll know where they are and only rarely need to look at them to guide my keystrokes. Using Easywriter II, you have to use the function keys a lot to change between the modes, and you have to lift your hands out of the home position and look down at them to hit most of the function keys (while

# TODAY'S PRODUCTIVITY IS TOMORROW'S PROFIT.

That's why Quark designs office automation software to increase your productivity. With programs that will dramatically enhance your Apple® III or IIe. So you'll do more work—more efficiently—in less time—for less money.

And all Quark programs are extremely friendly. So you can devote your efforts to using them, not learning them. Yet you'll discover many sophisticated features no other software can offer.

Find out for yourself. See your dealer today for a complete demonstration of our Word Juggler™ word processing system. And innovative utility programs, such as our Catalyst™ hard disk boot.

Because tomorrow belongs to the productive. And who wants to be left behind in yesterday?

Quark Incorporated,  
2525 West Evans, Suite 220  
Denver, Colorado 80210,  
(303) 834-2211.



**Quark**<sup>™</sup>  
INCORPORATED  
Office Automation  
Software



squinting at the reference sticker). This sort of thing slows me down. You use the keyboard's directional cursor keys, which require you to move from home position, to move the cursor. It's not that I object to function keys in themselves, but there should be a way for expert users to streamline their actions.

My objections don't apply to some users. If you are new to computers (see photo 4), you may appreciate having certain keys dedicated to common functions, and if you are a hunt-and-peck typist you won't care about the home position. And again, if you do only light editing of your text once you have entered it, these problems will be negligible. But once you have learned the system, if you come to use it frequently for editing and revision, you just might get tired of moving your hands back and forth every other keystroke.

You format text for printed output from Easywriter II chiefly by getting it to look on the screen the way you want it on paper. (I'll have more to say about such screen-oriented formatting later on.) A "ruler" line on the screen defines tab settings, margins, and page centering; as many as eight rulers may be used for each document.

Decimal-tab settings allow easy alignment of columns of figures, although no column-move facilities are provided. Different headers and footers may be defined for left and right pages, with page numbering placed as desired.

Printing can occur while editing is taking place, including immediate printing of the page just edited. The version of Easywriter II that I tested was unable to drive a serially interfaced Integral Data Systems Prism printer at full speed; IUS is planning to speed up the new version to avoid this problem.

The program I had didn't contain a true global search-and-replace function (the updated version is supposed to have one). An update of the documentation is planned, giving more tutorial examples.

A few other comments are in order: Online help for most functions can be gotten by simply pressing the F2 key. Whenever you wish to take a break from working, you can hit the Escape key, and the page you are working on will automatically be stored on disk against the possibility of some system mishap while you're gone. Sections of one document may be tagged to be merged with another document. No extra backup copies of files

*Text continued on page 196*

Property	Easywriter II	Volkswriter	Wordstar	The Final Word
Price	\$350	\$195	\$495	\$300
Printed documentation	9¼- by 8- by 1¼-inch binder, 92 typeset pages, 5-page index; linen-covered box; function-key sticker	9- by 7- by 1½-inch binder, about 70 typeset pages, 5-page index	12- by 10- by 1¼-inch binder, 230 pages, 5-page index, 14 pages specific to IBM PC; packet reference card; separate tutorial workbook	12- by 10¼- by 2¼-inch binder, 402 pages, 8-page index; reference card; function-key chart
Minimum practical hardware configuration	64K bytes of RAM, 80-character display, two 5¼-inch floppy-disk drives (reviewed version supports only single-sided drives), and printer	64K bytes of RAM, 80-character display, one 5¼-inch floppy-disk drive, and printer	128K bytes of RAM, 80-character display, two 5¼-inch disk drives (double-sided recommended), and printer	128K bytes of RAM, 80-character display, two 5¼-inch double-sided floppy-disk drives, and printer
Maximum number of characters directly manipulable	window sees only one page at a time; number of pages in file varies with disk size	with 128K bytes, 58,570 characters; with 64K bytes, 15,370 characters	varies according to disk size	varies according to disk size and user-set size of swap file
Editing universe	window into one page of file	window into buffer in RAM	window into buffer automatically paged to and from disk	window into buffer automatically paged to and from disk; supports two windows and multiple buffers
Command structure	mode-oriented; uses menus and special- and assignable-function keys plus Alt and Shift keys	uses special- and assignable-function keys plus Alt key	control keystrokes organized by two-level menus, limited function-key support	control keystrokes organized by three-level menus, user-definable function-key support; mode-oriented
Tutorial course for beginners?	first chapter in user's manual	files for online tutorial provided on disk	separate stand-up beginner's workbook (introductory textbooks available from independent sources)	nine chapters of user's manual, some chapters also provided on disk for online practice
Online help during editing?	separate screen displays explaining function keys and editing procedures, placed on screen after user types F2	brief descriptions of function keys placed on screen after user types F1	command menus appearing at top of screen after user types proper control character (menus may be suppressed by expert users)	command menus at top of screen appearing after user types Control-X, also brief messages on command sequences and key-stroke functions

Table 1: Comparative properties of four word-processing programs for the IBM Personal Computer.

# Nine Thousand Nine Hundred & Ninety Dollars.

**3 USERS. 21 MBYTES  
WINCHESTER. 320K RAM.**

**AND YOU CAN ONLY GET IT  
FROM GIFFORD.**

Look at that price again. We were a little skeptical at first, too. But after checking our totals we knew we'd finally done it: developed a multi-user, 8-16 bit obsolescence-proof hard-disk computer system, complete with dBase II™ SuperCalc-86™ and MP/M-86™ for under \$10,000. Expandability's a breakthrough, too. You can add four additional users for just \$600 each, plus terminal.

**IS IT 8 BIT OR 16 BIT? YES.**

Like you would expect of a Gifford computer system, it can run any combination of 8 and 16 bit CP/M programs simultaneously. So, on top of all the thousands of 8 bit CP/M programs available, you'll also be able

to take advantage of any of the more powerful 16 bit programs... and run them at the same time. And when we say it works, it really works. After all, we were the folks who invented 8-16 bit operating systems.

**STOP LOOKING. AND START  
CUTTING.**

Send us the coupon and we'll send you a brochure detailing *all* the advantages of going with Gifford. Such as, our exclusive networking and multi-tasking telecommunications packages, our two year warranty and the benefits of selecting an IEEE 696/S-100 bus-based system.

There's lots more to tell, but if you're a business or technical professional looking for an obsolescence-proof, multi-user hard-disk computer system that features expandability and dependability, plus complete service and support at an incredibly low price, stop looking and cut the coupon.

And by all means, wait for our brochure before you make any investment.

**Gifford Computer System 321  
Includes:**

320K Static RAM Memory

Two 8" DS/DD Floppies 2.4Mb  
Formatted

Gifford F5-21 Winchester Drive 21Mb  
Formatted (27 Mb Unformatted)

CompuPro Enclosure 2 With:  
IEEE 696/S-100 bus  
9 I/O Ports  
20 bus Slots

dBASE II

SuperCalc-86

MP/M-86

*Terminals not included. Compatible  
with all standard RS-232 terminals and  
printers.*

MP/M 8-16 is a proprietary implementation of MP/M-86 and was configured for CompuPro by Gifford Computer Systems. CP/M and MP/M are registered trademarks of Digital Research. SuperCalc is a trademark of Sorcim. dBase II is a trademark of Ashton-Tate. CompuPro is a trademark of Godbout Electronics. Prices and specifications subject to change.

**Gifford Computer Systems is an  
authorized CompuPro Systems Center.**



*Terminals not included.*

1922 Republic Avenue, San Leandro, CA 94577  
(415) 895-0798 A division of G&G Engineering

**I'D LIKE THE WHOLE STORY.**

Please send me your brochure.

Name \_\_\_\_\_ Title \_\_\_\_\_

Organization \_\_\_\_\_

Address \_\_\_\_\_

City \_\_\_\_\_ State \_\_\_\_\_ Zip \_\_\_\_\_

Phone \_\_\_\_\_

Please have a representative call me.

BY \_\_\_\_\_

GIFFORD COMPUTER SYSTEMS CENTERS  SAN LEANDRO, CA 94577 (415) 895-0798  SAN FRANCISCO, CA 94104 (415) 391-4570  
 LOS ANGELES, CA 90064 (213) 477-3921  OKLAHOMA CITY, OK 73112 (405) 840-1175  HOUSTON, TX 77046 (713) 877-1212

Circle 208 on Inquiry card.



# LOWEST SOFTWARE

We hereby certify that your purchase from Discount Software represents the lowest price sold anywhere. If you find a lower price on what you purchased within 30 days, send the ad and we'll refund the difference.

	Discount Price
<b>CP/M</b>	
<b>ARTIFICIAL INTELLIGENCE</b>	
Medical (PAS-3)	\$849
Dental (PAS-3)	\$849
<b>ASHTON-TATE</b>	
<b>\$4??</b> dBASE II...	call for price
Financial Planner	\$595
Bottom Line Strategist	\$349
<b>ASYST DESIGN/FRONTIER</b>	
Prof Time Accounting	\$549
General Subroutine	\$269
Application Utilities	\$439
<b>DIGITAL RESEARCH</b>	
CP/M 2.2	
Intel MDS	\$135
<b>\$149</b> Northstar	
<b>\$159</b> TRS-80 Model II (P&T)	
Micropolis	\$175
<b>\$98</b> CBasic-2	
Display Manager	\$319
Access Manager	\$239
Multiplan	\$219
<b>\$449</b> PL/1-80	
BT-80	\$179
MAC	\$85
RMAC	\$179
Sid	\$65
<b>\$90</b> Z-Sid	
DeSpool	\$49
CB-80	\$459
Link-80	\$90
<b>FOX &amp; GELLER</b>	
Quickscreen	\$135
Quickcode	\$265
<b>\$65</b> DUtil	
<b>MICRO-AP</b>	
S-Basic	\$269
Selector IV	\$295
Selector V	\$495
<b>MICRO DATA BASE SYSTEMS</b>	
HDBS	\$269
MDBS	\$1099
DRS or QRS or RTL	\$319
MDBS PKG	\$1999
<b>MICROPRO</b>	
<b>\$289</b> WordStar	
<b>\$199</b> Mail Merge	

WordStar/Mailmerge	\$399
WS/MM/SpellStar	\$549
Customization Notes	\$44
<b>\$199</b> SpellStar	
DataStar	\$249
InfoStar	\$349
ReportStar	\$254
Wordmaster	\$119
Supersort I	\$199
Calc Star	\$129
<b>MICROSOFT</b>	
<b>\$229</b> Basic-80	
<b>\$329</b> Basic Compiler	
<b>\$349</b> Fortran-80	
<b>\$549</b> Cobol-80	
M-Sort	\$175
<b>\$159</b> Macro-80	
MuSimp/MuMath	\$224
MuLisp-80	\$174
<b>ORGANIC SOFTWARE</b>	
Textwriter III	\$111
Datebook II	\$269
Milestone	\$269
<b>OSBORNE (McGraw/Hill)</b>	
G/L, or AR & AP, or PAY	\$59
All 3	\$129
All 3 + CBASIC-2	\$199
Enhanced Osborne	\$299
<b>PEACHTREE</b>	
G/1, A/R, A/P, PAY, INV (each)	\$399
PB Version	Add \$234
Peachcalc	\$249
Other	Less 10%
<b>STAR COMPUTER SYSTEMS</b>	
G/L, A/R, A/P, Pay (each)	\$349
All 4	\$1129
Legal or Property Mgt.	\$849
<b>STRUCTURED SYSTEMS</b>	
Business Packages (call)	
<b>SORCIM</b>	
<b>\$249</b> SuperCalc	
Act	\$157
<b>SUPERSOFT</b>	
Ada	\$270
Diagnostic II	\$89
Disk Doctor	\$89
Forth (8080 or z80)	\$149
Fortran	\$319
Ratfor	\$79
C Compiler	\$225
Star Edit	\$189
Scratch Pad	\$266
StatsGraph	\$174
Analiza II	\$45

Disk Edit	\$89
Encode/Decode II	\$89
Optimizer	\$174
Term II	\$174
Utilities I or II	\$54
<b>SOFTWARE DIMENSIONS/ACCOUNTING PLUS</b>	
1 Module	\$399
4 Modules	\$1499
All 8	\$2799
<b>UNICORN</b>	
Mince or Scribble (each)	\$149
Both	\$249
The Final Word	\$270
<b>WHITESMITHS</b>	
"C" Compiler	\$609
Pascal (incl "C")	\$859
"PASCAL"	
Pascal/MT+ Pkg	\$429
Compiler	\$315
SP Prog	\$175
Pascal Z	\$349
Pascal/UCSD 4.0	\$670
<b>DATA BASE</b>	
dBASE II	Call 4??
FMS-80	\$799
FMS-81	\$399
Condor I & III	Call
Superfile	\$159
<b>"WORD PROCESSING"</b>	
Perfect Writer	\$189
WordSearch	\$179
SpellGuard	\$199
Peachtext	\$289
Spell Binder	\$349
Select	\$495
The Word	\$65
<b>\$145</b> The Word Plus	
Palantier-1 (WP)	\$385
<b>"COMMUNICATIONS"</b>	
Ascom	\$149
BSTAM or BSTMS	\$149
<b>\$139</b> Crosstalk	
<b>\$89</b> Move-it	
<b>"OTHER GOODIES"</b>	
Micro Plan	\$419
Plan 80	\$495
Target PlannerCalc	\$79
Target Financial Modeling	\$299
Target Task	\$299
Tiny "C"	\$89
Tiny "C" Compiler	\$229
MicroStat	\$224
Vedit	\$130
MiniModel	\$449
StatPak	\$449
Micro B+	\$229
String/80	\$84



# PRICES GUARANTEED

These remarkable savings represent only half the story of Discount Software. The other half is our reputation for prompt, courteous, and informative service. We are always available, always ready to help.

String/80 (source).....	\$279
ISIS CP/M Utility.....	\$199
Lynx.....	\$199
Supervyz.....	\$95
ATI Power (tutorial).....	\$75
Mathe Magic.....	\$95
CIS Cobol.....	\$765
Forms II.....	
Graph Magic.....	\$79
Basic.....	\$249
Zip MBasic, CBasic.....	\$129

<b>PEACHTREE</b>	
G/L, A/R, A/P, PAY, (each)....	\$224
PeachPack P40.....	\$395
<b>ACCOUNTING PLUS</b>	
G/L, AR, AP, INV, (each).....	\$385
<b>"OTHER GOODIES"</b>	
Super-Text II.....	\$127
Data Factory.....	\$269
Mini Factory.....	\$269
DB Master.....	\$184
Versaform VS1.....	\$350

Fortran (MSDOS).....	\$429
"C" (MSDOS).....	\$429
CP/M 86.....	\$239
<b>"OTHER GOODIES"</b>	
Lotus 1-2-3.....	\$329
SuperCalc.....	\$269
VisiCalc.....	\$219
Visiplot/trend.....	\$259
Visidex.....	\$219
Easyfiler.....	\$359
Mathemagic.....	\$95
dBase II.....	Call 4??
Condor Q & R, Others.....	Call
Statpak.....	\$449
Optimizer.....	\$174
Desktop Plan.....	\$259

## APPLE II

<b>ASHTON-TATE</b>	
(See CP/M Ashton-Tate)	
<b>BRODERBUND</b>	
G/L (with A/P).....	\$444
Payroll.....	\$355
<b>INFO UNLIMITED</b>	
EasyWriter (Prof).....	\$155
EasyMailer (Prof).....	\$134
Datadex.....	\$129
<b>MICROSOFT</b>	
Softcard (Z-80 CP/M).....	\$239
Fortran.....	\$179
Cobol.....	\$499
Tasc.....	\$139
Premium Package.....	\$549
RAM Card.....	\$89
<b>MICROPRO</b>	
(See CP/M Micropro)	
<b>VISICORP</b>	
Visicalc 3.3.....	\$189
Desktop/Plan II.....	\$219
Visiterm.....	\$90
Visidex.....	\$219
Visitrend/Visiplot.....	\$259
Visifile.....	\$219
Visischedule.....	\$259

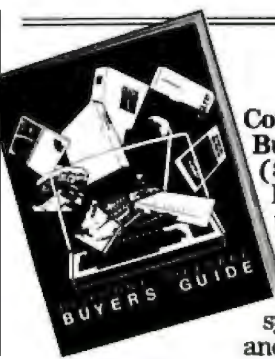
## IBM PC, 16 BIT 8, DISPLAYWRITER

<b>"WORD PROCESSING"</b>	
Wordstar.....	\$289
Spellstar.....	\$199
Mailmerge.....	\$199
Easywriter.....	\$314
Easyspeller.....	\$159
Select/Superspell.....	\$535
Write On.....	\$116
Spellguard.....	\$189
Textwriter III.....	\$189
Spellbinder.....	\$349
Final Word.....	\$270
<b>"LANGUAGES &amp; UTILITIES"</b>	
Crosstalk.....	\$174
Move-it.....	\$129
BSTAM or BSTMS.....	\$149
Pascal MT+ /86, SPP.....	\$679
CBasic 86.....	\$294
Act 86.....	\$157
Trans 86.....	\$115
XLT 86.....	\$135
MBasic (MSDOS).....	\$329
MBasic Compiler (MSDOS).....	\$329
Both.....	\$629
CBasic Compiler (MSDOS).....	\$495
Cobol (MSDOS).....	\$649
Pascal (MSDOS).....	\$429

## FORMATS AVAILABLE.

8" single density
8" OSII
Superbrain
Micropolis/Vector Graphic
NorthStar Horizon
NorthStar Advantage
Osborne
Heath/Zenith
Cromemco
Televideo
Xerox 820
Dynabyte
Hewlett-Packard 125
NEC
Eagle
Apple II/III
Otrona
TRS-80 Model I/II/III
DEC VT-180
Altos
CP/M-86
IBM PC

\*New formats added weekly. Call for information.



## FREE WITH PURCHASE:

**Complete Software Buyer's Guide (\$5.00 value)**  
Filled with facts and usable advice about scores and scores of software programs from accounting and business systems to word processing and utilities.

**Exclusive Service "Hotline"**  
Our reputation for courteous and knowledgeable service has resulted in calls from people who never purchased our products. Now a separate "hotline" is available to customers only.

**Confidential Software BargainGrams**  
Regular notices of insider's bargains not available to the general public.



ORDER TOLL-FREE  
VIA VISA OR  
MASTERCARD:

**1 800 421-4003**  
Calif: 1 800 252-4092

6520 Selma Avenue, Los Angeles, CA 90028

**DISCOUNT SOFTWARE**  
Outside Continental U.S.—add \$10 plus Air Parcel Post. Add \$3.50 postage and handling per each item. California residents add 8% sales tax. Allow 2 weeks on checks. C.O.D. \$3.00 extra. Prices subject to change without notice. All items subject to availability. \*Mr. trademark. Blue Label \$3.00 additional per item. CP/M is a registered trademark of DIGITAL RESEARCH, INC.

BM 583

# SOFTWARE



Property	Easywriter II	Volkswriter	Wordstar	The Final Word
Longest line length that can be set	255 characters (horizontal scrolling possible)	80 characters	240 characters (horizontal scrolling possible)	65,535 characters (no horizontal scrolling; line is wrapped back onto screen for display only)
On-screen status information shown during text entry and editing	text-object mode in use; percentage of document disk used; current date; cursor position (column, line, page); document name; margins; tab stops; page center; right-hand word-wrap zone; other transient messages	disk drive being used for file accesses (logged drive); cursor line and column; percentage of buffer unused; cursor is enlarged during insert mode; additional transient messages	active file name; current page; cursor line and column; insert mode on or off; line spacing; margins and tab stops; page breaks; various line-ending codes; optional command menus; other transient messages	version of The Final Word in use; text insert/alignment mode; current buffer name; file name associated with current buffer; percentage of buffer contents behind cursor; "*" if buffer has been modified; "+" if new deletions will be appended to old; "H" if new text will be highlighted; current "verb" (actually adverb); transient messages
Screen location of status information	three lines at top, normal character attributes	bottom line, inverse video	top two lines (if menu suppressed) of rightmost column; menus occupy several lines at top of screen, in both normal and bright intensities	next-to-bottom line, inverse video; transient messages appear on bottom line; menus on several lines at top of screen
Use of IBM PC function keys	extensive, mandatory; uses Alt and Shift keys with assignable keys; function-key sticker provided	extensive, mandatory; Alt key doubles functions; on-screen key menu	optional; curious choice of key assignments	optional; uses Alt, Shift, and Control keys with assignable keys; key chart provided; assignments may be changed by user
Action of Del key	deletes current text object	deletes character to the right of cursor	deletes character to the left of cursor	deletes character at cursor
Action of back-arrow key	nondestructive backspace	destructive backspace (replaces character with a space)	nondestructive backspace	delete character backwards
Decimal tab stops?	yes	no	yes	no
Column-move capability?	no	no	yes	no
Possible insertion of nonprinting ASCII control characters?	no	yes	no	yes
Formatting scheme	on-screen	on-screen; some printing parameters stored in disk files	on-screen	both on-screen and embedded-command formatting possible
Transition time from edit mode to printing start (includes answering queries as fast as reasonably possible)	reviewed version: 25 seconds for 28,469-character (or 9-page) file	128K-version: 16 seconds for 28,469-character file printed directly out of buffer; 64K-version: 48 seconds for same file, includes saving to disk	60 seconds for 28,469-character document, includes saving to disk	for 28,187-character document, without embedded-character formatting: 1 minute, 35 seconds; for same document with formatting: 4 minutes
Print while editing?	not reliably	no	yes	yes
Obtain file directory without leaving program?	document files only	yes	yes	yes
Can user change default parameters?	some (with menu-driven utility program)	those in format (.FMT) files	only printer-support parameters	most print and edit defaults (with menu-driven utility program)

# WE HAVE THE JUMP ON THE COMPETITION

10 YEAR WARRANTY



**Kangaroo**™

## in QUALITY and PRICE!

**Kangaroo**—the best disk at any price!

CERTIFIED 100% ERROR FREE

REINFORCED HUB RINGS

ALL **KANGAROO** DISKS ARE  
PACKAGED IN A HARD LIBRARY CASE

10 YEAR WARRANTY

### Suggested List Price

5 1/4 inch Single Sided/Double Density **\$29.95**

5 1/4 inch Double Sided/Double Density **\$39.95**

### Try A Box Of Kangaroos On Us!

We are so convinced **Kangaroo** is the best disk you can buy that we make this offer. Buy a box of **Kangaroos**, if for any reason you are not satisfied with the quality of **Kangaroos**, return them within 30 days for a full refund—no questions asked.

EXCLUSIVE NORTH AMERICAN  
DISTRIBUTOR:

MICROCOMPUTER  
BUSINESS  
INDUSTRIES  
CORPORATION

**MBI**

ADMINISTRATIVE OFFICES 1019 8TH STREET, GOLDEN, COLORADO 80401 (U.S.A.)  
TELEPHONE: (303) 279-8438

TWX: 910 934 0191

Circle 537 on inquiry card.



Property	Easywriter II	Volkswriter	Wordstar	The Final Word
Document assembly during editing	includes "tagged" sections of other document files	can include entire files	can include entire files; marked blocks of files may be written to disk	marked blocks of text may be transferred between two buffers
Document assembly during printing	no documented method	can embed entire files in output	needs optional Mailmerge program at extra cost	can embed entire files in output
Accept operator input for immediate inclusion in printed output?	no	no	needs Mailmerge	yes
Automatic formatting capabilities (other than defaults)	multiple-line headers and footers, alternating left and right	page formatting through .FMT files	single-line headers and footers	extensive and complex capabilities through embedded commands
Default text-justification style	flush-left (ragged-right margin)	flush-left (ragged-right margin)	fully justified	fully justified (as distributed; user can change)
Can documents be printed without being saved to disk?	yes	yes	no	no
Difficulty of changing from single spacing to double spacing	difficult	easy	difficult	easy, requires use of formatter
Can text be searched for printing attributes?	no	yes	no	yes
Printers supported (not all printers can output all text attributes)	IBM Parallel Printer; Epson MX-80; Diablo 1610*; Diablo 1650 (with sheet-feed); Diablo 630*; NEC 5510*; and C. Itoh Parallel* (others, without full capability)  <i>*requires adjustment of numeric parameters from chart</i>	IBM Parallel Printer; Epson MX-80 (with and without Graftrax); Smith-Corona TP-1; Brother HR-1; Comrex CR-1; NEC 8023-A; and NEC 3550 (other printers, without full capability)	IBM Parallel Printer; Epson MX-80; Diablo 1610/1620; Diablo 1640/1650; Diablo 630; NEC 5510/5520; NEC 3550†; Qume Sprint 5; and C. Itoh Starwriter (others, without full capability)  †partial support	IBM Parallel Printer; Epson MX-80 with Graftrax; C. Itoh 8510; Leading Edge Prowriter; Diablo 1610/1620; Diablo 1640/1650/630; NEC 8023A; NEC 3550; NEC 5510/5520; Qume Sprint 9/35; IDS 440/460; IDS Prism; Centronics 737/739; and Radio Shack Daisywheel II (others, with varying capability)
Special features of disk-file format	nonstandard file format in tested version; file-conversion utility produced normal PC-DOS files; new version to use PC-DOS files	"¶" character (ASCII decimal 20) at hard returns, "§" character (ASCII decimal 21) at page ends; otherwise normal PC-DOS files	high bits of character bytes set at ends of words and at soft returns; soft (ghost) hyphens and other special attributes use nonprinting ASCII values	normal PC-DOS files; high bits of character bytes set only in highlighted text
Checking of spelling integrated into program?	no	no	yes (with optional program Spellstar at extra cost)	no

# PURCHASE ORDER

## Interactive Videodisc System

**\$4995-  
COMPLETE**

TO: THE INTERNATIONAL INSTITUTE  
OF APPLIED TECHNOLOGY  
2121 WISCONSIN AVENUE, NW  
WASHINGTON, D.C. 20007  
(202) 965-7410

QTY	DESCRIPTION	PRICE
1	<b>TOUCHÉ SYSTEM</b> , including a fully assembled desk-top enclosure, housing: <ul style="list-style-type: none"><li>• APPLE II motherboard with 64K</li><li>• Single floppy disk drive and controller card (256K)</li><li>• IIAT touch sensitive color monitor (13")</li><li>• PIONEER laser videodisc player</li><li>• IIAT video/touch interface circuitry</li><li>• Audio amplifier switchbox</li><li>• Course authoring language</li></ul>	
	TOTAL	\$4995-

COMMENT

**APPROVED**

I'm ready to go with the IIAT system. It meets all our training and information needs. And it costs \$3000 less than any I've found. Let's stop looking and start using it—



Property	Easywriter II	Volkswriter	Wordstar	The Final Word
<b>Most annoying characteristics</b>	multiplicity of text-object modes; (in version tested) incompatible disk format, single-sided-disk use even on double-sided drives, necessity to change disks for routine functions; lack of ability to search text for printing attributes	block operations by groups of lines only; 80-character maximum line length; (to expert users) required use of function keys	unchangeable default conditions; tedious method of printing same text in two different formats; lack of planning in adaptation to IBM PC hardware; lack of ability to search for printing attributes	enslavement to forward and reverse modes for most editing operations; lack of single-line screen scrolling; inadequate differentiation in documentation between certain similar features; requirement of two return characters between paragraphs; inflexible tab-setting
<b>Most pleasing characteristics</b>	long, descriptive document names (30 characters in length); use of ordinary "cut-and-paste" terminology; accuracy in the reproduction of IBM's documentation binder	quickness of screen scrolling; simplicity of design; storage of canned formats; ability to insert almost any ASCII character into text	efficient grouping of control characters for cursor movement and other often-used operations; variable amounts of user prompting through repressible menus	extreme flexibility; protection against interruptions and system crashes; ability to view and edit two documents at once in two visible text windows; provision of Control-T command to correct two-character transposition typos
<b>Miscellaneous comments</b>	Special telephone-help service may be purchased for \$70 per year. Second serial port cannot be used for printer.	You purchase a version tailored to run on a 64K-byte system; when you send in the registration card, you are sent the 128K version. Owners of version 1.1 may receive an upgrade to 1.2 for \$20.	Wordstar has provision for helping hyphenate words during reforming of paragraphs. Text is displayed on screen in bright attribute, menus in normal attribute.	TFWINM (see text); does not use "meta" characters for commands. Uses Recover program to maintain swap file. Printer paper may be offset to save forms. Screen-highlighted text shows up in blue on a color monitor.

Co-owner Jack Abbott says, "I hope you've been reading my review series in Byte magazine on Database Management Systems. Please call me at (602) 842-1133 if I can be of help in solving your software requirements."

# WAREHOUSE SOFTWARE

**CALL TOLL FREE FOR ORDERS**  
**1-800-421-3135**

## MOST DISK FORMATS AVAILABLE:

Program names prefaced with "\*" available also for IBM PC

## CP/M DATA BASE MANAGEMENT SYSTEMS:

#Ashton-Tate DBase II ..... **Call**  
 #Condor III ..... **Call**  
 #T.I.M. .... **\$365**  
 #Infostar ..... **Call**

## CP/M UTILITIES

Package Price, Wordstar, Mailmerge, Spell Checker, for CP/M 80 and for IBM PC  
 ..... **\$445**  
 Above package with Spell Star ... **\$495**  
 #Wordstar ..... **\$285**  
 #Mailmerge ..... **\$125**  
 #Wordstar & Mailmerge ..... **\$395**  
 #Spellstar ..... **\$145**  
 Calcstar ..... **\$135**  
 #Aspen 50K Spell Checker ..... **\$50**  
 C-Basic ..... **\$115**  
 Lotus 1, 2, 3 (IBM Only) ..... **\$375**

CB-80 ..... **\$415**  
 Dastar ..... **\$215**  
 Supersort ..... **\$175**  
 #Supercalc ..... **\$195**  
 CP/M Power ..... **\$135**  
 #T.C.S. AR, PAY, AP, GL ..... **\$400 or \$125** each module  
 Target Systems Planner Calc ..... **\$85**  
 #MOVE-IT (Micro to Micro COM & MODEM) ..... **\$105**  
 Fox Geller Quickscreen ..... **\$135**

## SPECIALS

#TCS AR, PAY, AP, GL Augmented Version . **\$400 or \$125** each module

**dBase II** includes special extra disk of example programs including inventory, invoicing, and mail list at no extra charge. Also included is **Everyman's Data Base Primer**, 300 pages on dBase II. .... **Call**

Microsoft Basic 80 ..... **\$265**  
 Microsoft Basic Compiler ..... **\$295**  
 Accounting Plus Modules . . . **\$485** ea  
 Peachtree Peach Pak, AR, AP, GL. . **\$375**  
 Peachtree Magic Wand, Spell Checker, Mail List ..... **\$350**

## IBM PERIPHERALS

IBM Disc Controller Adapter w/par. or serial port ..... **\$249**  
 Seven Function Board—64K expandable to 256K, par. port, async port, realtime clock w/battery, game paddle port, print spool software, ramdisk software, 1 year warranty ..... **\$395**  
 Piggyback Board—Expands multi function board by 256K (No Ram) ..... **\$150**  
 64K Ram expansion ..... **\$75**  
 4 Function Board, same as 7 function board without the RAM or the software. . **\$250**  
 64K RAM expandable to 256 w/Async port ..... **\$295**  
 Tandon 100-2 D/S D/D Drives 320K for IBM PC ..... **Call**  
 5MEG Winchester w/removable cartridge ..... **Call**

## WAREHOUSE SOFTWARE

Orders—Call 1-800-421-3135  
 Technical Information—  
 (602) 842-1133

4935 W. Glendale Ave. Suite 12  
 Glendale, Arizona 85301

**ALL PROGRAMS GUARANTEED LATEST VERSION—FULL DOCUMENTATION**

Prices reflect 3% cash discount. Please add \$5.00 per order for shipping. Price & availability subject to change without notice.



# COMPUTER WAREHOUSE

CALL TOLL FREE **1-800-528-1054**

## ATARI

**Special 800 System**  
800 w/48K, recorder, Pac Man or  
Star Raiders, joysticks ..... **\$640**

1200 ..... **Call**  
800 (48K) ..... **\$525**  
400 ..... **\$225**  
810 Disk Drive ..... **\$440**  
850 Interface ..... **\$170**  
410 Recorder ..... **\$75**  
830 Modem ..... **\$155**

## COMMODORE

64 ..... **\$395**

## AXLON

Rampower 48 for Atari ..... **\$140**  
Rampower 128 for Atari ..... **\$355**  
Ramdisk 128 for Apple ..... **\$355**  
Ramdisk 320 for Apple ..... **\$1035**  
Data Link ..... **\$300**

## PRINTERS

**Anadex**  
9620A ..... **\$1445**

**C-Itoh**  
F-10-Parallel ..... **\$1165**  
F-10-Serial ..... **\$1165**  
55 CPS-Series ..... **Call**  
8510 Parallel (Prowriter) ..... **Call**

**Computer International**  
Daisywriter 2000 w/16K ..... **\$975**  
Daisywriter 2000 w/48K ..... **\$1000**

**Comrex**  
CR-1-S ..... **\$675**  
CR-1-P ..... **\$775**

**Datasouth**  
DS 180 ..... **\$1170**

**Diablo**  
620 RO w/Tractors ..... **\$920**  
630 RO w/Tractors ..... **\$1730**

**IDS**  
Microprism 480 ..... **\$515**

**Epson**  
All models ..... **Call**

**NEC**  
PC-8023A ..... **\$435**  
3510 ..... **\$1375**  
3550 ..... **\$1835**  
7710 ..... **\$2050**  
7720 ..... **\$2425**

**Okidata**  
All models ..... **Call**

**Smith-Corona**  
TP-1 ..... **\$650**

**Star Micronics**  
Gemini-10 ..... **Call**  
Gemini-15 ..... **Call**

**Tally**  
1805/1802 ..... **\$1455**  
MT 160I w/Tractors ..... **Call**  
MT 160L w/Tractors ..... **Call**  
MT 180 ..... **Call**

**Texas Instruments**  
810 Basic ..... **\$1260**

**Toshiba**  
P1360 ..... **\$1475**

## SPECIAL OF THE MONTH

**NEC 8023A ..... \$435**

## DISK DRIVES

**Percom**  
Atari S/S S/D 1st Drive ..... **\$400**  
Atari S/S S/D 2nd Drive ..... **\$300**  
Atari S/S D/D 1st Drive ..... **\$525**  
Atari S/S D/D 2nd Drive ..... **\$330**

**Rana (Drives for Apple)**  
Elite 1 ..... **\$265**  
Elite 2 ..... **\$420**  
Elite 3 ..... **\$550**  
Controller (w/Drive only) ..... **\$75**  
1000 (For Atari) ..... **Call**

## MONITORS

**Zenith**  
12" Green Screen ..... **\$95**

**Amdek**  
Video 300 ..... **\$130**  
Video 300A ..... **\$145**  
Color I ..... **\$285**  
Color II ..... **\$610**  
Color III ..... **\$360**

**BMC**  
12" Green ..... **\$85**  
13" Color ..... **\$265**

**Comrex**  
13" Color Composite ..... **\$290**  
13" RGB ..... **\$455**

**NEC**  
JB 1201 ..... **\$155**  
JB 1260 ..... **\$115**

**Taxan**  
12" Amber ..... **\$125**

**USI**  
9" Amber ..... **\$130**  
12" Amber ..... **\$150**

## MODEMS

**Hayes Smartmodem** ..... **\$210**

**Novation**  
CAT ..... **\$140**  
D-CAT ..... **\$155**  
J-CAT ..... **Call**

## VIDEO TERMINALS

**Qume**  
QVT 102 ..... **\$550**

**Televideo**  
910 ..... **\$570**  
910 Plus ..... **\$570**  
920 ..... **\$735**  
925 ..... **\$730**  
950 ..... **\$915**  
970 ..... **\$1100**

**Zenith**  
Z-19 ..... **\$670**  
Z-29 ..... **\$640**  
ZT-1 Keyboard Only ..... **\$350**

## COMPUTERS

**Altos**  
ACS 8000-15 ..... **\$3550**  
Series 15D ..... **\$2125**  
Series 5-5D ..... **\$3900**  
5-80-10 ..... **Call**

**Eagle II** ..... **\$2330**

**NEC**  
8001 ..... **\$730**  
8012 ..... **\$470**  
8031 ..... **\$730**  
APC ..... **Call**

**Northstar**  
Advantage ..... **\$2800**  
Advantage w/5MB ..... **\$3600**  
Horizon II 64K QD ..... **\$2625**

**Sanyo**  
MBC-1000 w/Micropro Software,  
S-Basic, CPM\* ..... **Call**  
Above w/2 Drives ..... **Call**

**Televideo Systems**  
TS-802 ..... **\$2599**  
TS-802H ..... **\$4450**

**Zenith**  
Z-120 ..... **\$3100**  
Z-110 ..... **\$3025**

## DISKETTES

**Maxell**  
MD-1 (Qty. 100) ..... **\$250**

**Scotch**  
744-0 (Qty. 100) ..... **\$225**

**Elephant**  
S/S S/D (Qty 100) ..... **\$180**

2222 E. Indian School Rd.  
Phoenix, Arizona 85016



# COMPUTER WAREHOUSE

Order Line: 1-800-528-1054 Other Information: 602-954-6109  
Order Line Hours: Mon.-Fri. 10-5 MST Saturday 9-1 MST



## At a Glance

### Name

Volkswriter

### Type

Word-processing program

### Manufacturer

Lifetree Software Inc.  
177 Webster St., Suite 342  
Monterey, CA 93940  
(408) 373-4718

### Price

\$195

### Format

5¼-inch floppy disk, PC-DOS (MS-DOS)

### Language

IBM (Microsoft) Pascal [source code not available]

### Computer

IBM Personal Computer

### Documentation

User's manual, approximately 70 typeset pages in small loose-leaf binder; tutorial files on distribution disk

### Audience

Beginning users of word processing

under PC-DOS and is one of the few word-processing programs for the IBM PC that can be run (although not at top performance) on a fairly small hardware configuration, i.e., 64K bytes of user memory and one 5¼-inch floppy-disk drive. Lifetree Software provides two different sets of program files (see photo 5) for registered users of VW: one set, to be used in systems with 64K bytes, contains separate programs (linked in execution by batch files) for Volkswriter's editing and printing functions; the other set, to be used with 128K bytes or more, combines the two programs into one.

In keeping with its modest hardware demands, Volkswriter is moderately priced. With a suggested list price of \$195, VW is the least expensive of the four tools considered in this article. The program is simple in design, and I found it quite straightforward to use for modest writing projects. It's a no-frills piece of software: it has just enough features to get most jobs done.

Lifetree Software doesn't come as close as Information Unlimited Software in imitating IBM's user's manuals, but some thought was given to the matter, because the loose-leaf binder and box are roughly the same size as IBM's, although covered with slick paper instead of linen.

To initiate first-time users to the concepts of word processing and its peculiarities, VW depends less on the user's manual than on a series of interactive lessons. You take the lessons by editing a set of files that comes on the Volkswriter distribution disk. I found the lessons to be well done except for a couple of problems, such as a search-and-replace lesson that became unintentionally modified by being searched and replaced. (These glitches can be considered minor if a knowledgeable user can be consulted by the person taking the lesson.)

In contrast to Easywriter II's page orientation, Volkswriter treats the display screen like a window onto a large, continuous buffer, or storage area, containing the entire text you are editing. Both the buffer and the Volkswriter program itself must fit simultaneously in user memory, so that the amount of text you can work on in a 64K-byte system is limited to around 15,000 characters. But this limitation makes possible great speed in moving the window around in the buffer. You never have to wait for the word-processing program to read more text from a floppy disk; it's always immediately accessible. In a 128K-byte system, you can work on a buffer size of as many as 60,000 characters. The status line at the bottom of the screen tells you what percentage of the buffer is available for entering text, although for some reason it starts out at 93 percent empty instead of 100 percent.

Like Easywriter II, Volkswriter uses the 10 assignable-function keys heavily to invoke various commands; the Alt key is used to double the commands available with the assignable-function keys. Also as in Easywriter II, you must use these keys; there is no alternative for the expert user. The keys of the numeric/cursor-control keypad on the right side of the keyboard are used also as they are marked. My feelings about having to use the assignable-function keys in Easywriter also apply to VW, but I

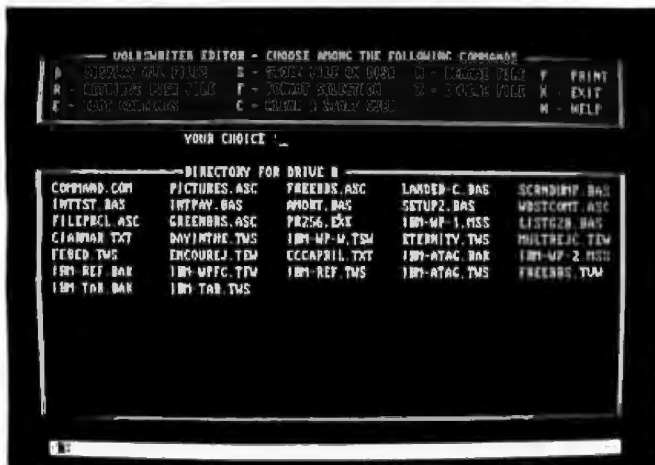


Photo 5: Volkswriter consistently places the list of major menu choices at the top of the screen, with subsidiary information arranged underneath as required. Shown here is the main menu, which appears on the screen after a brief graphical diversion.

Text continued from page 186

are made unless you give explicit commands to cause it. No automatic-hyphenation functions are provided. A crude kind of "undo" command can, under most conditions, cancel changes to a page made since it was called up. Some other specific features are delineated in the comparison in table 1 (see pages 186-194).

## Volkswriter

Volkswriter, or VW as its devotees call it, was one of the first alternatives to the original Easywriter. VW runs

## Okidata **MICROLINE 92**

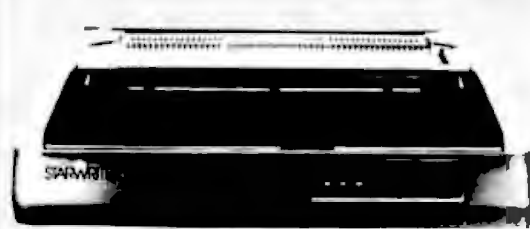


**\$524.88 UPS DELIVERED**

- 180 characters per second, bi-directional, logic-seeking printhead action with 80 & 40 cps hi-res correspondence print modes
- 9 x 9 matrix produces correspondence, 10, & 17 cpl with true descenders; double width & download option for character sets standard
- Subscripts, superscripts, underlining, backspace, & forms control
- Friction & pin feed paper handling takes up to 3-part forms (8 1/2")
- Centronics parallel or RS-232C interfacing (specify)

Microline 93 (136 columns).....\$884.88

## C. Itoh **F-10 Starwriter**



**\$1379.88 UPS DELIVERED**

- 40 characters per second, bi-directional, logic-seeking printhead action
- 136 column, friction fed, takes 15" paper & 3-part forms
- 96 character set, fully-formed letters on Diablo-compatible daisywheels for optimum print quality
- Subscripts, superscripts, underlining, backspace, & forms control
- Centronics parallel or RS-232C interfacing (specify)

F-10 Printmaster (55 cps).....\$1679.88  
F-10 Tractor (Starwriter/Printmaster).....\$289.88

### PRINTERS

**Anadex**  
Anadex WP-6000A (P&S) ... \$3499.88  
Anadex DP-8501A (P&S) ... \$1499.88  
Anadex DP-8620A (P&S) ... \$1499.88

**Centronics**  
Centronics 122 (P)..... \$629.88  
Centronics 122 (R)..... \$649.88  
Centronics 352 (P&S)..... \$1894.88  
Centronics 353 (P&S)..... \$2329.88

#### C. Itoh



C. Itoh Prowriter.....\$399.88  
w/RS-232C.....\$499.88  
C. Itoh Prowriter 2.....\$734.88  
w/RS-232C.....\$789.88

#### Daisywriter



Daisywriter 2000 48K buffer (P&S)  
sold only w/cable.....\$1129.88  
Tractor.....\$149.88  
Sheetfeeder.....\$739.88

**Diablo**  
Diablo 620 (S).....\$1029.88  
Diablo 630 (S).....\$1199.88  
Diablo 630 KSR (S).....\$2694.88  
630/630KSR Tractor.....\$389.88

#### Star Micronics



Gemini 10 (P).....\$399.88  
Gemini 10 (P&S).....\$479.88  
Gemini 15 (P).....\$499.88  
Gemini 15 (P&S).....\$579.88

### PRINTERS

#### IDS



IDS Prism 80 (P&S).....\$1104.88  
above w/graphics.....\$1189.88  
above w/sheetfeed.....\$1294.88  
above w/4-color.....\$1339.88  
IDS Prism 132 (P&S).....\$1269.88  
above w/graphics.....\$1339.88  
above w/sheetfeed.....\$1459.88  
above w/4-color.....\$1699.88  
IDS Microprism (P&S).....\$879.88

**Okidata**  
Microline 80 (P).....\$339.88  
Microline 82A (P&S).....\$419.88



82A Okigraph ROM.....\$49.88  
80/82A Tractor.....\$89.88

### PRINTERS

**Okidata**  
82A Roll Paper Holder.....\$49.88  
Microline 83A (P&S).....\$879.88  
83A Okigraph ROM.....\$49.88  
Microline 84 w/graphics & tractor



Parallel, 200 cps.....\$1094.88  
RS-232C, 200 cps.....\$1139.88

#### NEC



NEC 3510 (S).....\$1929.88  
NEC 3530 (P).....\$1799.88  
NEC 3550 (P).....\$2199.88  
3500 Tractor.....\$239.88  
NEC 7710 (S).....\$2399.88  
NEC 7720 KSR (S).....\$2799.88  
NEC 7730 (P).....\$399.88

### PRINTERS

#### NEC



NEC PC-8023A (P).....\$499.88

#### Qume



Qume Sprint 11+ Parallel or RS-232C,  
includes cables.....\$1449.88

**Smith-Corona**  
Smith Corona TP-1.....\$679.88  
Specify either 10 or 12 cpl,  
& parallel or RS-232C interface

**Transfer**  
Transfer 130.....\$759.88

**CALL FOR PRICES** on Cannon, Datascout, Epson, Mammesmann Tally, Panasonic, Ricoh, Silver Reed, & others

**Interfaces**  
PKASO card/cable.....\$129.88  
IDS PKASO card/cable.....\$189.88  
Parallel Card w/cable.....\$89.88  
Grapplers w/cable.....\$149.88  
CBM/PET w/cable.....\$119.88  
TRS-80 Color RS-232C to  
Parallel w/cable.....\$99.88  
VIC/Commodore 64 Serial Inter-  
face w/cable.....\$149.88

**Parallel Cables**  
IBM-PC.....\$29.88  
TRS-80 Model I/III.....\$29.88  
TRS-80 Model II/16.....\$29.88  
Atari 800.....\$29.88  
Osborne-1 (IEEE488).....\$39.88  
Prism 80/132/MicroPrism Centronics  
cable adapter.....\$20.00  
Centronics male/male.....\$29.88  
Centronics male/female.....\$39.88

**RS-232C Cables**  
DB-25 male/male.....\$29.88  
DB-25 male/female.....\$29.88

**Information & Orders**  
**(603)-881-9855**

Orders Only: (800)-343-0726

### No Hidden Charges

FREE UPS shipping on all orders—No extra charge to use credit cards—All equipment shipped factory fresh with manufacturer's warranty—COD orders accepted (\$10 fee added)—No purchase orders accepted—No foreign or APO orders accepted—Minimum \$50 per order—This ad prepared in February; prices are subject to change.



HIGH TECHNOLOGY AT AFFORDABLE PRICES  
**THE BOTTOM LINE**

MILFORD, NH 03055-0423 □ TELEPHONE (603) 881-9855



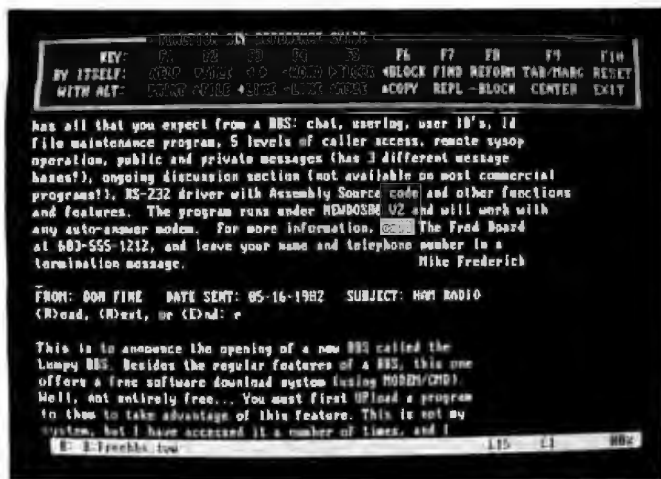


Photo 6: Typical screen display in Volkswriter's edit mode. By hitting the F1 key, you cause the reference guide to the assignable-function keys to appear at the top of the screen. This is the only online help available, however. The bottom line of the screen shows status information in inverse video.

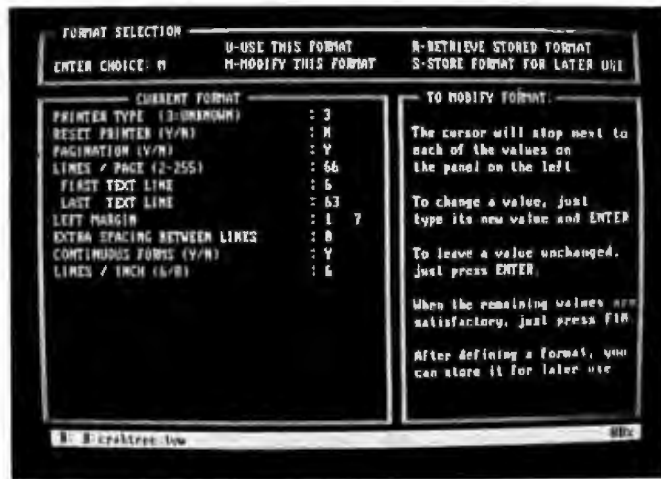


Photo 7: Parameters of Volkswriter's printing format are stored in disk files given file name extensions of ".FMT". You can change the parameters using a simple, menu-driven procedure, illustrated here.

didn't find editing with VW as objectionable as Easywriter II, perhaps because the effects of VW's commands are not modified by a lot of object modes.

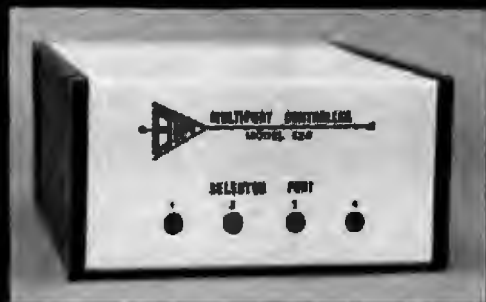
Lifetree does not give you a reference sticker to look at, but by pressing the F1 key, you cause a menu of the assigned command functions to appear at the top of the display screen (see photo 6). (Incidentally, use of F1 makes more sense than Easywriter II's use of F2.) The legends are somewhat cryptic to the new user, but once you have become familiar with Volkswriter the display makes sense. Also, the F10 key is used as a kind of panic button; you can press it to halt an operation you did not intend. The system is kind to inexperienced users in that it asks you to confirm your intentions when you give it a command that could wipe out a large part of the text.

The printed output that Volkswriter produces is

formed on the page according to parameters specified by special format files (given ".FMT" extensions). The parameters vary somewhat depending on what printer you are using, but they can include the character pitch to be used, the margins on the page, line spacing, justification, and starting page number. You can set up separate format files (see photo 7), automatically invoked, for each type of document that you produce, or you can use the default format. You can even change the formats during printing with a command embedded in the text.

In the document file, you can embed any number of header and footer lines, with justification specified to alternate between left and right pages. You can set temporary indentations for quoted paragraphs or other special material. You can embed almost any arbitrary character code in the text, perhaps to activate a special

# Need More Serial Ports ?



- \* Add a BTA smart multiport controller to your C.P.U.
- \* The MODEL 524 expands a single RS232 port to four individual ports with port selection and baud rate controlled by user software.
- \* Buffered inputs permit simultaneous operation increasing data exchange rate.
- \* 62K spooler model also available.

Price  
**\$249.00**

**Bay Technical Associates**

P. O. Box 387, Bay St. Louis, MS. 39520  
601 - 467-8231

# 64K STATIC RAM MEMORY



## S-100 STATIC MEMORY BREAKTHROUGH

Finally, you can buy state-of-the-art S-100/IEEE 696 static memory for your computer at an unprecedented savings.

Memory Merchant's memory boards provide the advanced features, quality and reliability you need for the kind of operational performance demanded by new high-speed processors.

### Completely Assembled.

These memory boards are not kits, nor skeletons — but top-quality, high-performance memories that are shipped to you completely assembled, burned-in, socketed, tested and insured with one of the industry's best warranties.

### Superior Design & Quality.

Memory Merchant's boards are created by a designer, well known for his proven ability in advanced, cost-efficient memory design. Innovative circuitry provides you with highly desired features and incredible versatility.

Only first-quality components are used throughout, and each board is rigorously tested to assure perfect and dependable performance.

### No Risk Trial.

We are so convinced that you will be absolutely delighted with our boards that we extend a no-risk trial offer. After purchasing one of our boards, you may return it (intact) for any reason within 15 days after shipment and we will refund the purchase price (less shipping).

## NEW S-100 PRODUCTS COMING SOON:

- \* DUAL 8/16 BIT CPU BOARD
- \* 128K 8/16 BIT STATIC RAM
- \* 256K 8/16 BIT DYNAMIC RAM

# \$629.

**48K PARTIALLY POPULATED \$519.**  
**32K PARTIALLY POPULATED \$409.**

### 64K RAM, MODEL MM65K16S

- 64K x 8-bit
- Speed in excess of 6 MHz
- Uses 150ns 16K (2K x 8) static RAMS
- Ultra-low power (435 Ma. max. — loaded with 64K)
- Bank Select **and** Extended Addressing
- A 2K window which can be placed anywhere in the 64K memory map
- Four independently addressable 16K blocks organized as:
  - Two independent 32K banks **or**
  - One 64K Extended Address Page **or**
  - One 48K and one 16K bank for use in MPM<sup>1</sup> (option)
- Each 32K bank responds independently to phantom
- 2716 (5V) EPROMS may replace any or all of the RAM
- Field-proven operation in CROMEMCO CROMIX<sup>\*</sup> and CDOS<sup>\*</sup>.
- Compatible with latest IEEE 696 systems such as Northstar, CompuPro, Morrow, IMS, IMSAI front panel, Altair and many others.

**OEM and DEALER inquiries invited.**

**Memory™  
Merchant**

14666 Doolittle Drive  
San Leandro, CA 94577  
(415) 483-1008

Circle 290 on inquiry card.

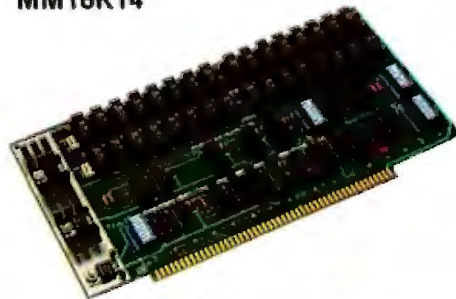
## FULL TWO-YEAR WARRANTY.

The reliability of our boards, through quality-controlled production and proven performance, has enabled us to extend our warranty to a full two years. That's standard with us, not an option. This includes a 6-month exchange program for defective units.

### Shipped direct from stock.

All Memory Merchant's boards are shipped direct from stock, normally within 48 hours of receipt of your order. Call us at (415) 483-1008 and we may be able to ship the same day.

### 16K RAM, Model MM16K14



### 16K STATIC RAM \$169.

16K x 8 Bit  
Bank Select & Extended Addressing  
Four independently addressable 4K blocks  
One 4K segment equipped with 1K windows  
Uses field-proven 2114 (1K x 4) RAMS  
Low Power (less than 1.2 Amps)  
Runs on any S-100 8080, 4 MHz Z-80 or 5 MHz 8085 system.

Prices, terms, specifications subject to change without notice.

<sup>\*</sup>Cromix and CDOS are trademarks of CROMEMCO.  
<sup>1</sup>MPM is a trademark of Digital Research



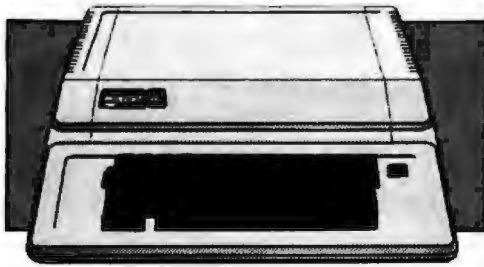


# Professionals T.M.

LOW PRICES TO PROFESSIONALS WHO KNOW WHAT THEY WANT AND KNOW HOW TO USE IT.

DEALERS  
WE BUY  
EXCESS  
INVENTORIES

## apple II+//IIe supply center



APPLE IIe 64K, 40 COLUMN	\$1.175
APPLE IIe 128K, 80 COLUMN	\$1.385
APPLE IIe STARTER SYSTEM BY APPLE (System A)	
64K and 80 column	
1 Disk II with controller	
Apple Monitor III	
Monitor Stand	\$1.750
APPLE IIe STARTER SYSTEM BY COMPUTER EXCHANGE (SYSTEM B)	
128K and 80 column	
1 Micro-Sci Drive with controller	
Filer, Utility and DOS 3.3 Diskette	
Sanyo 9" Green Monitor	
RF Modulator (for color TV)	
Game Paddles	
Game with color graphics and sound	\$1.675
WARRANTY is 100% Parts and Labor for 90 days by us.	
To substitute or delete drive on System B, subtract \$245 and add drive price (System D)	
To add on Micro-Sci A2 Drive to above, add \$245 (System DD)	
To substitute or delete monitor on System II, subtract \$130 and add other monitor price (System M)	

### DISK DRIVES for APPLE II+//IIe

<b>μ-SCI</b>	A2, 5 1/4", 143K Disk Drive	\$ 479	\$290
	Controller Card for A2 Drive	\$ 100	\$ 79
	A40, 5 1/4", 162K Disk Drive	\$ 649	\$320
	A70, 5 1/4", 208K Disk Drive	\$ 589	\$450
	Controller for A40 or A70	\$ 190	\$ 79
	Filer, Disk Utility Software	\$ 250	\$ 15
<b>VISTA</b>	5 1/4", 143K Disk Drive, Std. Height	\$ 300	\$240
	5 1/4", 2 Double Sided, 320K, Half Height	\$ 420	\$320
	Quarter, 5 1/4", 2 Double Sided by Side or Standard Cabinet	\$ 715	\$670
	Controller Card	\$ 89	\$ 79
	V1000 Dual II", Std. Format w/Controller, Complete	\$2195	\$1805
<b>TEAC</b>	Y1200, 5", 648K Disk Pack System	\$1549	\$1199
	Super-5, 143K Disk Drive, 1/2 High	\$ 379	\$279
	Super-5, Controller Card	\$ 89	\$ 69
	C.P. Software, Filer Utility and DOS 3.3	\$ 29	\$ 15

## HARDWARE

for Apple II

### RAM EXPANSION (II or II+ only)

	LIST PRICE	OUR PRICE
Comd RAM Card, 2Yr. Wty	\$ 179	\$ 30
• ALS, ADDRAM	\$ 90	\$ 60
• Microsil, RAMCard	\$ 100	\$ 79
• Solera Systems, RAM Card	\$ 249	\$109
RAM Card 64K	\$ 425	\$319
RAM Card 128K	\$ 590	\$450
Aspen RAM Disk System 320K	\$1395	\$995

### 80 COLUMN VIDEO (II or II+ only)

• ALS, Smarterm II	\$ 179	\$730
Oni Cheap Video, 64 col	\$ 89	\$ 80
Video, Videoterm 80 col	\$ 345	\$229
Soft Video Switch	\$ 25	\$ 25
Enhancer II	\$ 149	\$ 99
Function Strip	\$ 79	\$ 59
PSD, Para/Ser Interface	\$ 229	\$189
Full Video Line Call Up to 35% off		
Video Vision 80	\$ 395	\$199

### MISCELLANEOUS

ALS, The CP/M Card	\$ 399	\$299
Z-Care	\$ 169	\$129
Color II	\$ 179	\$139
AUTAR, RF Modulator	\$ 35	\$ 25
CCS, Serial Interface 7710A	\$ 150	\$129
Other CCS Cards in stock	Call	Call
Don Paymer, Lower Case Chips	\$ 50	\$ 39
Don Pak, DAD 003 & R Mouth	\$ 125	\$ 85
• Eastside, Wild Card, copier	\$ 139	\$ 99
Kanington, System Saver	\$ 90	\$ 69
Kral, Joystick (Ap II+)	\$ 65	\$ 49
Paddis (Ap II+)	\$ 50	\$ 39
MAR, Sup II fan	\$ 50	\$ 39
• Microsil, 280 Softcard	\$ 245	\$245
Softcard Premium Pack	\$ 595	\$495
280 Softcard Plus	\$ 645	\$450
MicroTek, Dumping GX, Graphics Printer II/F	\$ 249	\$189
Dumping 64, Buffered 64K Spooler	\$ 349	\$239
Mountain, CPS Multifunction Card	\$ 239	\$189
No. 9, Booster 3.6 Mhz	\$ 695	\$545
Orange Micro, Grappier Plus	\$ 185	\$119
Practical Peripherals		
MB5 BK Serial (Epson)	\$ 159	\$129
MBP 16K Para (Epson)	\$ 159	\$129
Microbuffer II 16K, (Specific)	\$ 269	\$209
Microbuffer II 32K, (Specific)	\$ 299	\$229
• PCPI, Appli-Card, 14 features		
4Mhz	\$ 295	\$ 235
6Mhz	\$ 375	\$275
8Mhz	\$ 455	\$ 355
IBM, A10 II, Serial/Para Interface	\$ 225	\$189
TG Products, Game Paddles III+	\$ 49	\$ 39
Joystick (II+)	\$ 60	\$ 45
Select-A-Port (II+)	\$ 60	\$ 45
Trak Ball (II+)	\$ 65	\$ 44
WCSB, Trackball (Ap II+)	\$ 85	\$ 55

## SOFTWARE

on disk for Apple II/II+/IIe

### BUSINESS

	LIST PRICE	OUR PRICE
Apple Computer, Inc.		
Apple Fortran	\$ 200	\$150
Apple Writer II	\$ 159	\$119
How to (Educational)	\$ 59	\$ 25
Apple Logo	\$ 175	\$149
50% off other Apple Inc. software		Call
Applied Soft Tech, VersaForm	\$ 269	\$205
Artsci, MagicWindow II NEW!	\$ 150	\$ 99
Ashton-Tate, dBase II (CP/M) with User's Guide by Software Banc	\$ 730	\$430
Continental, GL, AR, AP or PR va	\$ 250	\$189
1st Class Mail	\$ 75	\$ 49
Home Accountant	\$ 75	\$ 49
• Hayden, Pre Writer (Specific bnd)	\$ 170	\$ 99
• High Tech, Job Cost Control	\$ 250	\$209
Into Master	\$ 169	\$119
Howard, Soft.		
Real Estate Analyzer II	\$ 195	\$129
Tax Preparer	\$ 225	\$149
Info Utilim, Easywriter (PRO)	\$ 175	\$119
LJK, Letter Perfect w/Mail Merge	\$ 150	\$ 99
• Micro Craft, (CP/M)		
Professional Billkeeper	\$ 750	\$395
Verdict, (Legal Billing)	\$ 750	\$395
• Micro Lab, Tax Manager	\$ 180	\$119
Micro Pts, (all CP/M)		
InfoStar	\$ 495	\$329
Report Star	\$ 350	\$229
WordStar® - Training Manual	\$ 495	\$189
Mail Merge™	\$ 250	Call
SpellStar™	\$ 250	Call
SPECIAL! All 3 above	\$ 695	Call
Data Star™	\$ 295	Call
Microsil, Multi Plan (CP/M)	\$ 275	\$179
Multi-Plan (DOS 3.3) New!	\$ 275	\$179
Mass, Super Text 40/56/70 New!	\$ 125	\$ 89
De-Lim, ScreenWreter II	\$ 130	\$ 99
The Dictionary	\$ 100	\$ 69
General Manager II New!	\$ 230	\$159
Baburn/E.P. Soft, (Disk and Book)		
Some Common Basic Programs		
75 Business, Statistics and Math programs for the Apple II	\$ 100	\$ 49
Practical Basic Programs		
40 more very valuable programs beyond "Some Com BasicProg"	\$ 100	\$ 49
Feachme, Requires CP/M & MBASIC, 40 columns		
Series 40 GL & AR & AP, all 3	\$ 595	\$395
Series 40 Inv or Pay., ea	\$ 400	\$275
Series 9 Text & Spell & Mail, all 3	\$ 595	\$395

	LIST PRICE	OUR PRICE
Perfect, Perfect Writer	\$ 495	\$299
Perfect Speller	\$ 295	\$199
Perfect Filer	\$ 595	\$399
Quality, GBS w/3 gen. (a DBMS)	\$ 650	\$475
Samble, Sons Speller, specific	\$ 125	\$ 95
• Simon Valley, Word Handler	\$ 250	\$119
Sol/Bye, Executive Secretary	\$ 250	\$169
Executive Speller	\$ 75	\$ 35
Software Dimensions/System Plus		
Accig Plus, General Ledger	\$ 425	\$295
Accig Plus, GL, AP and A/R	\$ 595	\$395
Accig Plus, above + Inventory	\$1355	\$775
Software Publishing, PFS File	\$ 140	\$ 99
PFS Report	\$ 125	\$ 89
PFS Graph	\$ 140	\$ 99
Southwest Data Capture, call to specify		
STC, The Creator NEW!	\$ 200	\$139
StenoWare, DB Master	\$ 229	\$155
DO Utility I or II	\$ 99	\$ 69
Video		
Appewriter II preboot disk	\$ 20	\$ 15
Visacalc 80 col. preboot disk	\$ 50	\$ 39
Visacalc 80 col. to 176K disk	\$ 90	\$ 69
VisCorp/Personal Software		
Visacalc 3.3	\$ 250	\$179
VisCorp/Personal Software		
Visacalc 3.3	\$ 250	\$179
VisFile or VisDex, each	\$ 250	\$179

### UTILITY & DEVELOPMENT

Beagle, Utility City	\$ 30	\$ 22
DOS Boot	\$ 24	\$ 18
Apple Mechanic	\$ 30	\$ 22
Control Panel Software		
• Filer, DOS Utility	\$ 20	\$ 16
Copy II Plus (bit copier)	\$ 40	\$ 35
• Epsom, Graphics Dump	\$ 15	\$ 9
trans.		
GrafFORTH by Paul Lutus	\$ 75	\$ 59
TransFORTH II by Paul Lutus	\$ 125	\$ 99
Witworth.		
A.L.D.S.	\$ 125	\$ 79
BASIC Compiler	\$ 395	\$299
Bobol 80	\$ 750	\$599
Fortran 80	\$ 195	\$149
TASC Compiler	\$ 175	\$119
• Ganga Locksmith (bit copier)	\$ 100	\$ 75
PageSet, Comp. Graphics Sys. New!	\$ 70	\$ 53
Graphics Magician New!	\$ 80	\$ 41
Phoenix, Zoom Grafik	\$ 40	\$ 29
Quality, Bag of Tricks	New!	\$ 29
Practical Systems, VC-Expand	\$ 100	\$ 49
VC-Expand 80	\$ 125	\$ 89
Sensible, Back It Up, (bit copier)	\$ 80	\$ 49

### HOME & EDUCATION

Continental, Home Accountant	\$ 75	\$ 49
OTHER BRANDS AND PROGRAMS IN STOCK, CALL.		

## WHILE THEY LAST OVERSTOCK SPECIALS FOR APPLE II/II+/IIe

Comd RAM Card, 2Yr. Warranty	\$ 179	\$ 30
Microsil 16K RAMCard	\$ 100	\$ 79
Solera Systems, 32K RAM Card	\$ 249	\$109
MAR, SuperTerm 80 col	\$ 375	\$299
Video, Videoterm 80 column card	\$ 345	\$229
CCS, Serial Interface 7710A	\$ 150	\$129
Calendar Interface 7728	\$ 110	\$ 85
Calendar Clock 7424A	\$ 120	\$ 85
Centronics Interface 7720B	\$ 120	\$ 85
Micro Pts, WordStar® (CP/M)	\$ 495	\$399
MicroLab, Micro Courier	\$ 250	\$175
Micro Telegram	\$ 250	\$175
Coeder, Conder Jr. for ALS Smarterm (CP/M)	\$ 195	\$ 69

## 50% OFF While They Last

Two Month 50% OFF While They Last  
VIC 20 Hardware and Software  
ATARI, 400 and 800 Peripherals and Software  
DEC, 1001 Hardware and Software  
AMATEX, CP800, Dot Matrix Printer, \$495

### AXLON

The Leader in Man-Add-on's

RAMpower (28K System 800)	\$ 475	\$350
RAMpower app. Module (for 400)	\$ 185	\$139
RAMpower 32K (400 or 800)	\$ 120	\$ 89
Nonscan Diagnostic Diskette	\$ 15	\$ 12

VISA  
Master Charge

★ Means a BEST buy

## AD #965

NATIONAL ORDER DESK TOLL FREE  
(800) 547-1289

All Other Orders Including Oregon: 245-6200  
Hot Lines For Information  
On Your Order  
[503] 245-7404

THE WORLD'S LARGEST COMPUTER MAIL ORDER FIRM

# Computer Exchange T.M.

ALL MAIL: P.O. Box 23068, Portland, OR 97223  
SHOWROOM AT 11507D SW PACIFIC HWY., PORTLAND, OR, OPEN M-SAT 10-5  
Circle 505 for IBM Peripherals, Circle 506 for Apple, Circle 507 for all others.



## At a Glance

### Name

Wordstar

### Type

Word-processing program

### Manufacturer

Micropro International Corporation  
33 San Pablo Ave.  
San Rafael, CA 94903  
(415) 499-1200

### Price

\$495

### Format

5¼-inch floppy disk, PC-DOS (MS-DOS)

### Language

Translation from 8080 machine language to 8086/8088 machine language (listing provided of some sections that may be customized by the user)

### Computer

IBM Personal Computer (as reviewed)

### Documentation

Tutorial workbook Wordstar Training Guide, 230-page user's manual in large loose-leaf binder, printed with letter-quality computer printer

### Audience

Users of word-processing software who require advanced features

One change applauded by many users has been the discontinuation of the copy protection of the VW distribution disks; other changes are not as obvious: reassignment of the F3 key, inclusion of conditional page breaks, provision for sub- and superscripting, and support for more printers. One change that has not been made is to provide for placement of block markers to allow block-move operations on pieces of text other than mere groups of lines (such as a sentence partly on one line and partly on another).

Volkswriter is a basic, functional tool for working with words. If your major use of the IBM Personal Computer is for some purpose other than word processing, Volkswriter would be a good, moderately priced software purchase to extend the capabilities of your system.

But if your needs are like mine, you'll want to explore more versatile (and, alas, more expensive) word-processing programs like . . .

## Wordstar

This product of Micropro International Corporation is without doubt the best-known and probably the most widely used personal computer word-processing program. Wordstar was developed for use on 8080A- or Z80-based CP/M-80 systems and was first sold in June 1979. It has become a point of reference for word-processing capabilities; whenever a new word-processing program comes on the market, people ask, "How does it compare to Wordstar?"

Wordstar really is a very versatile tool, well suited for many types of document composition and editing, but it is not flawless, and the \$495 list price may seem high to many potential buyers. Dr. Larry Press reviewed it in *onComputing*, along with three other programs (see reference 8). He rated it best of the four in certain kinds of work.

The version of Wordstar that I tested was 3.2, which seems to be a translation to the 8086/8088 processor and PC-DOS from the CP/M-80 version. The programmers at Micropro who adapted Wordstar to the IBM PC evidently did a lackluster job. The documentation supplied, contained in a large loose-leaf binder, was that written for the CP/M-80 product, plus a 14-page addendum on features unique to the IBM PC program that contained some confusing typographical misinterpretations. The Wordstar package also contains a self-standing tutorial workbook.

One of Wordstar's hallmark characteristics is its multiple-menu-oriented command structure. When you begin execution of the program, a "no-file" menu appears on the display screen (see photo 8). You select one of the activities listed among the menu items by typing a single alphabetic character. Included in the menu choices are running the optional, extra-cost Spellstar spelling-check program and the Mailmerge form-letter program. If you type a "D" from this menu, you will be asked for a document file name; after you respond, Wordstar will load the file into its working text buffer and go into edit mode (see photos 9 and 10 on page 204).

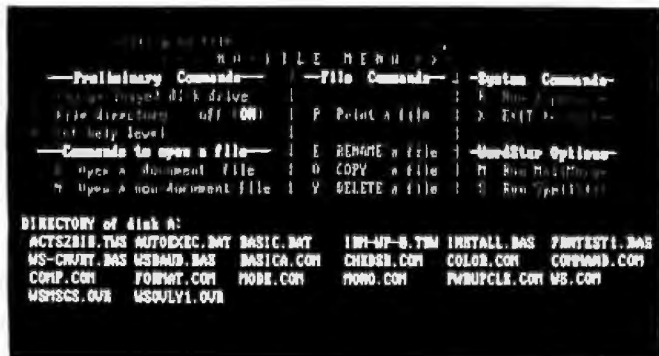


Photo 8: If no file name is specified in the command line when Wordstar is started, the program places this "no-file" menu on the screen. Menu options are selected when you type a single character. In this mode, you can perform various utility operations and even run a system utility program like CHKDSK (to find out how much room is left on a disk) without exiting Wordstar. The optional Mailmerge and Spellstar programs cost extra.

function supported by your printer or to use one of the IBM PC's special display characters. Or you can generate certain printing attributes (such as boldface, underlined, or accented characters) by brute force, by explicitly causing two or more lines of text to be printed on top of each other.

Volkswriter has been around long enough to have already undergone some changes from its original design.

# Full Use of the Epson MX-80 Under Wordstar

Neil G. Wallace  
11306 Concho Lane  
Houston, TX 77072

You can't take advantage of many of the printing capabilities of the Epson MX-80 (or the similar MX-100) printer when you use Wordstar, as distributed by Micropro International for the IBM Personal Computer, unless you change the user-addressable printer-driver routine. This can be done easily using the PC-DOS DEBUG utility program.

Following the procedure given here, you can upgrade Version 3.2 of Wordstar so it can use more of the capabilities built into the Epson MX-80 equipped with Grafrax-Plus. These modifications will enable printing of double-width, italic, and compressed characters, along with super- and subscripts.

Here's how to do it, as derived from information in Appendix C of the Wordstar reference manual and Appendix B of the Epson user's manual:

1. Copy the Wordstar file WS.COM onto a disk that you can use for experimentation (in case something goes wrong). Also copy the PC-DOS file DEBUG.COM onto the disk. Don't make these changes to your master copy of Wordstar.

2. Put the experimental disk into disk drive A of your IBM Personal Computer.

3. From the PC-DOS command prompt A>, enter the command:  
DEBUG WS.COM

This begins the process of modifying the program.

4. Type the characters  
E 0784

and press the Enter (Return) key. The computer's display should now show

-E 0784

04B5:0784 00

Now type in a "1" and press Enter. The screen will show

-E 0784

04B5:0784 00.1

Enter "Q" and start over if the screen shows something different.

5. Now type  
E 0785

(and Enter). After the "00." in the computer's response, type "8E" and press Enter. The screen will look like this:

-E 0785

04B5:0785 00.8E

6. Now type

E 0789

After the computer prints the "00." type "1". The display will show

-E 0789

04B5:0789 00.1

7. And finish this stage by entering

E 078A

After the "00.", put "94". The display will show

-E 078A

04B5:078A 00.94

You have just given Wordstar the ability to tell your MX-80 to print double-width characters. After these instructions have been put into Wordstar, you can use the embedded command ^PW (Control-P, W) to start double-width output and ^PE to turn it off. (Double width will also be turned off automatically at the end of the line.)

But you've just started. The remainder of the changes to Wordstar are done in much the same way. Perform the following summarized steps:

E0793

04B5:0793 00.2

E0794

04B5:0794 00.1B

E0795

04B5:0795 00.34

turn on italics  
with ^PY

E0798

04B5:0798 00.2

E0799

04B5:0799 00.1B

E079A

04B5:079A 00.35

turn off italics  
with ^PY

E076B

04B5:076B 00.1

turn on

E076C

04B5:076C 00.8F

compressed mode  
with ^PA

E0770

04B5:0770 00.1

E0771

04B5:0771 00.92

turn off  
compressed mode  
with ^PN

E0775

04B5:0775 00.3

E0776

04B5:0776 00.9B

E0777

04B5:0777 00.53

E0778

04B5:0778 00.0

Turn  
superscripts  
on with ^PT

E077A

04B5:077A 00.3

E077B

04B5:077B 00.9B

E077C

04B5:077C 00.53

E077D

04B5:077D 00.1

Turn subscripts  
on with ^PV

E077F

04B5:077F 00.2

E0780

04B5:0780 00.9B

E0781

04B5:0781 00.48

turns off super-  
and subscripts  
with ^PQ

Now this is important: you must, after entering all the preceding commands in DEBUG, do one more thing. Enter the following:

W04B5:0100

Your computer will come back with  
Writing 5000 Bytes

as it makes your changes to your experimental copy of Wordstar. Then exit DEBUG by typing "Q" and pressing Enter.

You're now through and can try out Wordstar's new capabilities. Use superscript commands in text in the following way: "5^T2^T^Q" will print "5<sup>2</sup>". Use subscripts this way: E^V3-x^V^Q will print "E<sub>3-x</sub>".

Have fun.



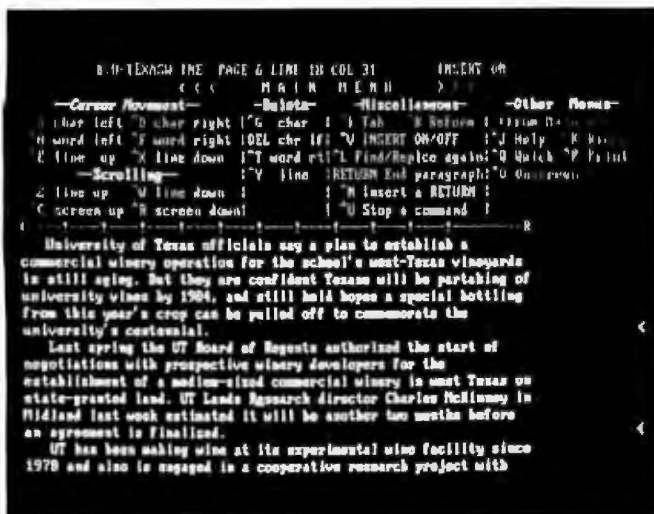


Photo 9: A typical editing screen display produced by Wordstar. Status information is displayed on the top line of the screen; the menu occupies the next several lines. Below the menu is the tab and margin ruler.

The text being edited and the category headings in the menus appear on the screen in bright intensity, while menu items and status information appear in normal intensity. Because this practice differs from most IBM PC programs, you may need to readjust the contrast and brightness of your video monitor to find a comfortable brightness level. At the right side of the screen, line-ending markers ("<") show that two of the lines (at the ends of paragraphs) end with "hard" return characters; the other lines end with "soft" returns, which can be removed when paragraphs are reformed (realigned).

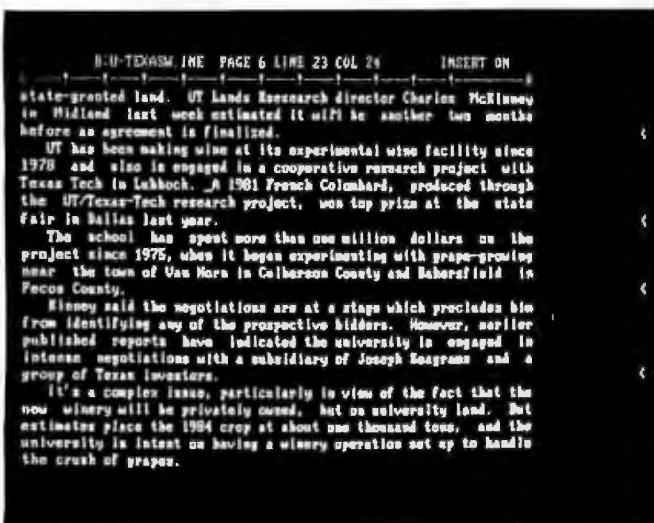


Photo 10: Wordstar's editing display with the main menu removed. (The main menu shows operations invoked by typing only a single control character.) You can choose one of four different degrees of user-prompting, ranging from continuous display of all menus through display of only subsidiary menus down to no user-prompting at all.

The text here has been reformed into Wordstar's default mode, full right and left justification. On the screen, text is justified by insertion of full character-size spaces; on the printed output, from printers that can perform microspace incrementation, the text will be justified character by character.

Once in the edit mode, a new, main menu appears on the screen. Because typing ordinary characters inserts them into the text buffer, you access items on this menu by typing control characters—requiring two keystrokes, one to hold down the Control (Ctrl) key and the other to hit the letter key. Four of the command items in the main menu activate other menus containing less frequently used commands, so some functions (for instance, "move cursor to beginning of buffer") require striking three separate keys (including the Control key). The four submenus are called Quick, Print, Block, and On-Screen. If you have memorized which commands go with which combination of keys, you can type the keys fast enough so that the secondary menus never have time to appear on the screen, or you can give a command to prevent the menus from appearing on the screen at all. The cursor-movement control keys are grouped in an efficient arrangement around the left hand's home position; you can take the cursor anywhere without lifting your arm. (If you want to lift your arm, you can use the IBM's special cursor keys on the right.)

This structure makes a lot of sense to me and suits my working style (although my left little finger does get tired from pressing the Control key). But a lot of people complain that all those menus are confusing. If menus and control characters bother you, you'd better stay clear of Wordstar.

Part of the adaptation from CP/M-80 to the IBM PC was the assignment of many of the multikeystroke commands to the special-purpose or assignable-function keys on the IBM PC's keyboard. The cursor-pad keys were sensibly assigned, but I don't understand some of the assignments of F1 through F10. Keys are dedicated to functions like "set help level" and "set left margin" when functions that you need all the time, like "reform paragraph," are left out in the cold (or out in the menu). And there is no way I know of to change these assignments. Micropro doesn't even give you a function-key sticker.

The other famous characteristic of Wordstar is its screen-oriented print formatting. The popular description of this feature is "what you see is what you get," but in most cases this is not strictly true. The IBM PC's display adapters are not capable of replicating many of the variations of printing styles that a lot of today's printers are capable of producing, including 132-column output, microspace justification, expanded character sizes, italic fonts, and sub- and superscripts. So what you see is sometimes only a hint of what you get, and these hints often show up in the displays as embedded extraneous characters. (Wordstar does have a command to make these temporarily disappear.)

Screen-oriented print formatting is nice if you are doing short business letters, reproducible newsletters, and other documents that you will always want to print in exactly the same format you entered the text. However, if you have an article manuscript, as I often do, that you want to print in both single- and double-spaced versions, Wordstar's style of print formatting is a bother; you have to print one version and then go back into edit mode to

WESTICO - The Software Express Service that really delivers:

# IBM PC SOFTWARE

16 Bit software for IBM PC, Victor 9000, CP/M-86 and MSDOS.

Westico has good news for owners of the new 16 bit microcomputers — a full selection of quality software. Programs for businesses, professionals, and software developers. Westico can provide its CP/M-80 programs for "Baby Blue" and similar 8 bit hardware options. And there's more good news. We deliver more than quality software fast. We deliver Westico. That means you receive Westico's outstanding technical support and expertise when you need it.

**MicroGANIT** — Sophisticated project planning system which uses Critical Path Method analysis. Visually oriented system makes it easy to interactively define task and project parameters. Budget costs and work hours are also calculated and displayed. Percentage allocation of resources to tasks and partial completion of tasks on the critical path are other features. \$395/\$25.

**STATPAK** — Statistics software library in Microsoft BASIC designed to give users an effective alternative to time-sharing. Performs probability calculations, independent variable statistics, discrete & continuous distribution functions, regression analysis, means testing, survey data/contingency tables and more. Includes plotting and data management. \$500/\$40.

**MINIMODEL** — Does big financial planning jobs at micro prices for cash flow projections, financial forecasting, venture analysis, and risk analysis. Model limited to 32,000 by 32,000 cells. Report content and format totally under user control. \$495/\$50.

**VERDICT** — For law offices with up to 25 attorneys and a total of 35 timekeepers (including paralegals, secretaries, etc.). All time and expenses are distributed to client or other designated overhead accounts. Analysis of billings, aging of receivables, and analysis of each timekeeper's work effort. Produces monthly client review sheets and ready to mail itemized bills. \$995/\$50.

**BILLKEEPER** — For professional offices — architects, accountants, engineers, consultants, ad agencies — with all of the features of VERDICT. \$995/\$50.

**MICRO-TAX** — Accepts information, summarizes data, computes tax, and prints returns required by the Internal Revenue Service. LEVEL 1 for individuals produces 14 schedules and forms. \$195. LEVEL 2 for professionals produces 33 schedules and forms. Includes depreciation, state tax interface, integrated data base for year to year data storage. \$1000. LEVEL 3 is a Partnership & Corporate package which produces 19 schedules and forms. \$1000.

**POSTMASTER** — Mailing list system to maintain name and address files. Produces everything from mailing labels to customized letters. \$150/\$25.

**FINALWORD** — Full screen interactive word processor with tables of contents, automatic indexes, simultaneous printing and editing. \$300/\$40.

**ASCOM** — For telecommunications between micros or micro to main frame. Easy to use full menu mode or expert command mode. Built-in commands for auto-dialing modems and tables for character translation, and suppression. Remote mode for controlling other micros. \$175/\$30.

**C386** — C language compiler for 8088/8086 machines. \$395/\$35.

**BASIC-86** — Standard microcomputer BASIC language. \$325/\$30.

**JANUS-ADA** — Compiler for useful subset of ADA language. \$650/\$75.

**PASCAL/MT-86** — Compiler generates machine language. \$800/\$40.

**SID-86** — Symbolic debugging tool for CP/M-86. \$150/\$15.

**EMSD-86** — Emulates execution of CP/M-80 programs. \$100/\$10.

**U-86** — Utility programs for PC DOS and MS DOS. \$180/\$20.

**The Westico 24-Hour Computer Hotline for 300 baud modems (203) 853-0816 for detailed information and quick access ordering.**



Westico has more than 250 programs that work on a wide variety of microcomputers including ADDS Multivision, Altos, CPT, Cromemco, DEC, Dynabyte, Eagle, Exon, Facit, Hewlett-Packard, IBM, Interlec, Kaycomp, Monroe, NEC, North Star, Northern Telecom, Ohio Scientific, Otrona Attache, Radio Shack, Sirius, Televideo, Vector Graphic, Victor, Xerox, Zenith. We're working hard to be your software company.

#### 4 Ways to order

- Write Westico, Inc., 25 Van Zant Street, Norwalk, CT 06855.
- Call (203) 853-6880.
- Telex 643-788
- Dial-up our 24-hour computer (300 baud) (203) 853-0816.

COD, MasterCard and VISA accepted.

Prices do not include shipping and are subject to change. In CT add 7½% sales tax. All sales final.

Manual price may be credited toward purchase of software.

Dealer inquiries invited.

WES-61

Copyright © 1982 Westico, Inc.

Call for FREE catalog.

**WESTICO**  
The Software Express Service

25 Van Zant Street • Norwalk, Connecticut 06855  
(203) 853-6880 • Telex 643-788



# BYTE Books Carry Waite

A New Primer Series

## Computer Animation Primer

by Mitchell Waite and David Fox



**JUST PUBLISHED!**

Illustrated in full color, this lively guide to the exciting world of computer-animated graphics is virtually "2-books-in-1." The first part covers the theory and products of high-resolution computer graphics, from frame buffer technology to shading algorithms; the second part shows you how to unlock the power of the Atari computer for true color animation. Features include program listings in Atari BASIC and 6502 Assembly Language, a source catalog of hardware and software for both Apple and Atari computers, and examples of today's best animation efforts.

## Apple Backpack

by Scot Kamins and Mitchell Waite

Concrete methods for developing "user-friendly" software are at your fingertips in this useful course in humanized programming. Written in readable and often witty style, and with complete details on everything from screen formatting to writing clear documentation.

## 8086/8088 16-bit Microprocessor Primer

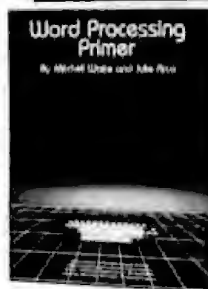
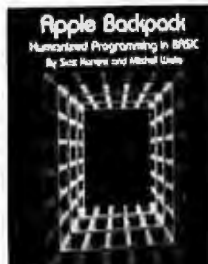
by Christopher L. Morgan and Mitchell Waite

You don't have to be a hardware engineer to follow the author's clear, crisp descriptions of the vastly more powerful new Intel 8086/8088 16-bit microprocessors. Covers design, capabilities, potential, currently available software, and new products based on the 8088, with emphasis on the IBM Personal Computer.

## Word Processing Primer

by Mitchell Waite and Julie Arca

Focusing primarily on inexpensive microcomputer-based text-editing products, this book gives you a thorough rundown on a powerful new way to electronically generate, correct, and manage all kinds of typewritten documents. Coverage includes controlling copy appearance, and selecting equipment and programs.



reform all the paragraphs, then print the second version. And even if you want only a double-spaced version to be printed, you might want to type in the text in single-spaced mode so that you can see more of it on the screen at once.

Another defect in Wordstar that shows up in similar circumstances is that you cannot use the search function to locate embedded printing-attribute characters. If you want to change all your underscored text to boldface, you have to search for it the hard way—by eye.

Wordstar encourages printing with even right and left margins (producing fully justified output) even on printers that cannot perform proportional spacing according to the width of characters (such printers are properly called "fixed-escapement," although Micropro calls them "Teletype-like"). As a result, a lot of Wordstar users routinely produce printed output that has been justified only by insertion of multiple full spaces between words. Such printouts look impressive at first glance, but they are actually harder to read than text that is printed flush-left, with a ragged right margin. Full justification should be set as a default condition only when the program has been customized to use a printer that can print in microspace increments. (This could form part of Wordstar's installation process.)

For all its versatility, Wordstar does not have some functions that would be useful. As distributed, it does not support the special printing attributes of the popular Epson MX-80 printer, (The MX-80's alter ego, the IBM Parallel Printer, can do the fancy printing only if the Grafrax-Plus option has been installed. There do exist ways to use the Epson attributes; see page 203.) Most of Wordstar's built-in printer options are for expensive formed-character (usually daisywheel) printers.

The default settings of most parameters cannot be changed by users. The program cannot use all the memory space available to the 8088 microprocessor—it must swap portions of the text of a long file to and from the disk. And to do any combining of files and interactive defining of the output text during printing, you must have the Mailmerge program at an additional cost.

## The Final Word

This program is a product of Mark of the Unicorn, a software house that established its reputation with a product called MINCE, which gave to microcomputer systems an editor with most of the capabilities of the big-computer editor EMACS. (The name is a recursive acronym: MINCE Is Not Complete EMACS.) One of my discoveries in this project has been TFWINM: The Final Word Is Not MINCE. The two programs share a common heritage, many similar features, and even some code (in the C language), but there are differences in the organization of editing commands and in output facilities. (MINCE for CP/M-80 systems was reviewed in BYTE by Christopher Kern; see reference 4.)

The Final Word is an extremely flexible word-processing system. You can use it to effortlessly produce types of output that would possibly require great effort using any

*Text continued on page 210*

Circle 378 on inquiry card. —>

At your bookseller or computer store. Or  
mail coupon for 15 days' FREE examination!

Byte/McGraw-Hill  
P.O. Box 400  
Hightstown, N.J. 08520



Please send me the book(s) checked for 15 days on approval. At the end of that time I will pay for the book(s) I keep, plus local tax, postage, and handling, and return any unwanted book(s) postpaid.

- 021742-4  Computer Animation Primer \$18.95  
033356-4  Apple Backpack \$14.95  
043109-4  8086/8088 \$16.95  
067761-1  Word Processing Primer \$14.95

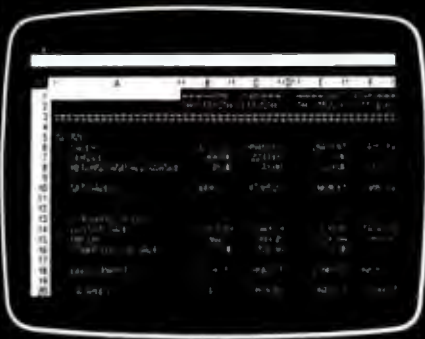
Name \_\_\_\_\_

Address/Apt. \_\_\_\_\_

City/State/Zip \_\_\_\_\_

28-D191-2144-3

# 2nd Generation Spreadsheet for Apple II™ and IIe™



**MAGICALC™**  
+  
**EXPAND-A-RAM™**

Everything VisiCalc can do and much more. Plus 64K or 128K RAM. Plus 80-column display for Apple IIe at no extra cost.

**MAGICALC** is a completely new second generation spreadsheet program for Apple II. This state-of-the-art system includes 70-column upper and lower case video, full 80-column board display, hard disk compatibility, individual column widths, invisible columns for confidential data, and full compatibility with VisiCalc that lets you utilize existing VisiCalc models. Refer to the box below for a comparison of **MAGICALC** and **VISICALC**.

**EXPAND-A-RAM** 64K or 128K of additional RAM memory for expanded **MAGICALC** worksheets. Includes **MEMORY MANAGEMENT SYSTEM** — relocates DOS for more free memory in BASIC. You also get **RAMDISK** emulators for **APPLE DOS**, **APPLE PASCAL™** and **CP/M™** — a software package that emulates a standard Apple floppy disk drive but is 2 to 10 times faster. Plus more.

Registered trade marks: Apple... belongs to Apple Computer, Inc., Magicalc to Artsci, Inc., Expand-A-Ram to Prometheus Products, Inc., VisiCalc to Visicorp, CP/M to Digital Research, Inc.

**EXPAND-A-RAM** for Apple II plugs into any slot and works with the many software programs that use 16K of RAM in slot 0 — including **CP/M**, **APPLE PASCAL™**, **LISA**, **MERLIN**... and many others. **EXPAND-A-RAM/80** for Apple IIe, which includes the 80-column display, goes into the auxiliary slot. No modification of your Apple is required.

**SPECIAL LOW INTRODUCTORY PRICES** for the combination **MAGICALC** plus **EXPAND-A-RAM** are \$399 with 64K RAM and \$499 with 128K RAM. Apple IIe users (only), please specify your choice of the standard **EXPAND-A-RAM** or **EXPAND-A-RAM/80** with 80-column Display at no additional charge.

See your local dealer for details:

**ARTSCI, INC.**  
5547 Satsuma Ave., North Hollywood, CA 91601,  
(213) 985-2922

**PROMETHEUS PRODUCTS, INC.**  
45277 Fremont Blvd., Fremont, CA 94538,  
(415) 490-2370

<i>COMPARE!</i>	MAGICALC	VISICALC
Preboot required	NO	YES
70 column upper and lower case video display	YES	NO
Full 80 column board display	YES	NO
Individual column widths	YES	NO
Invisible columns for confidential data	YES	NO
Hard disk compatibility	YES	NO
Full compatibility with VisiCalc	YES	YES
Program plus 128K RAM	\$499	\$745



From



... and



**PROMETHEUS**



# How to get the best out of (and into) your computer.

You've invested in your computer to get data accurately, intelligibly. The modem is no place to compromise and slip in a weak link.

With Novation Cat<sup>®</sup> modems you don't. Our Cat line is a full one. At one end—our small, handy J-Cat. It purrs along at 300 bps, excellent for home use. At the other end, with all the features and conveniences you want for business—our full blown smart, automatic communication systems that can roar along at 1200 bps.

All have one thing in common—unique, highly advanced LSI chips. Our engineers have designed these little marvels, eliminating

the complexity and costs of typical modems, and producing instead modems elegantly simple in execution with absolutely state-of-the-art reliability and features.

There's nothing quite like working with the latest and the best. Come see.

The Cats are at leading computer stores.

---

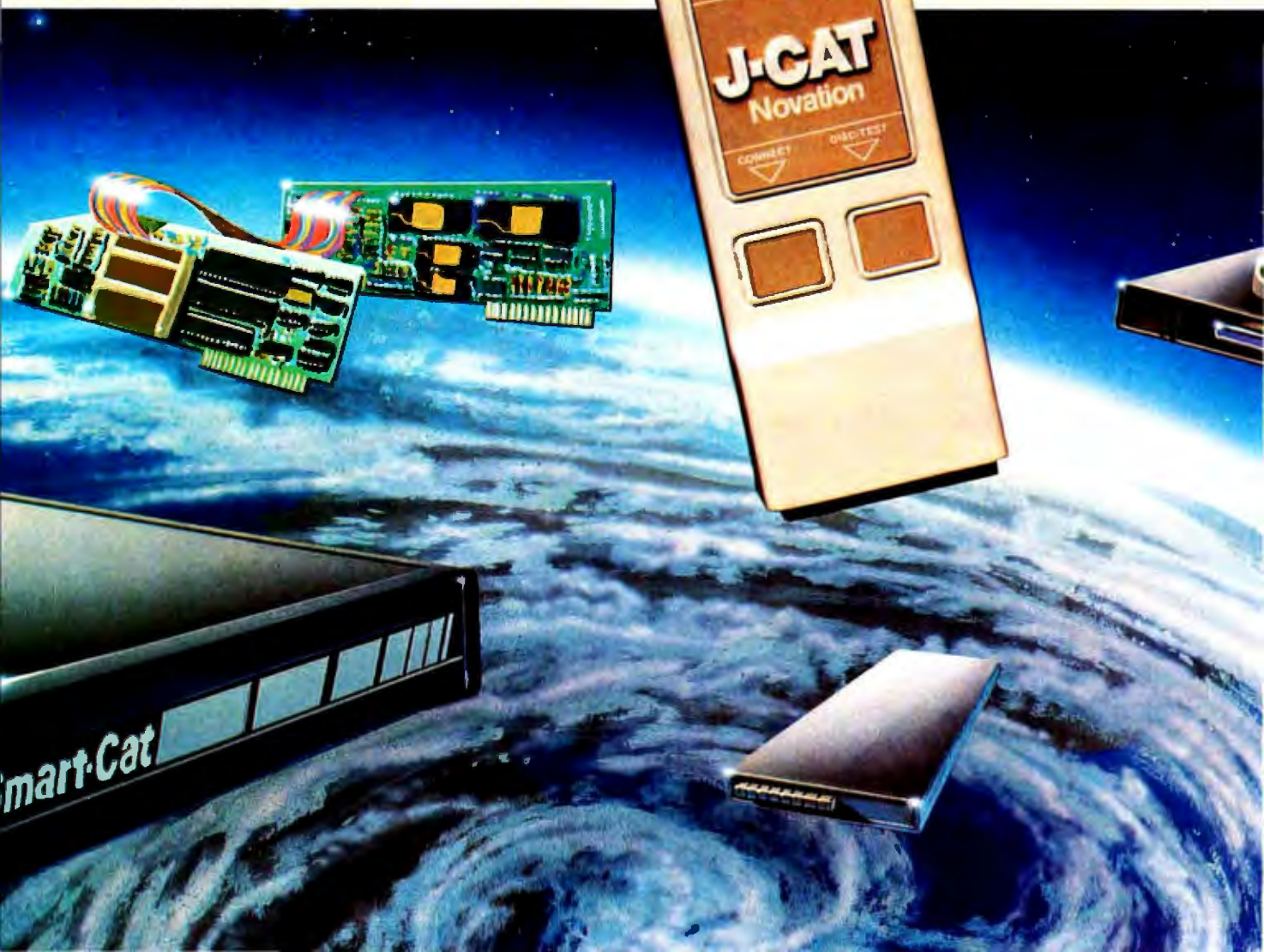
## There's another good reason to buy right now.

Tucked inside every Cat package, you'll now see a special "get acquainted" subscription to **The Source<sup>SM</sup>**. You might as well get started right.

---

## J-CAT™ MODEM

It's smaller. 1/5th the size of an ordinary modem. Easy to stick-on, tuck-in, put anywhere you want. Auto-answer. Also, no fussing to get into the right mode, answer or originate—J-Cat does it automatically. \$149\*





## 103 AND 103/212 SMART-CAT™ MODEMS



They do more, do it easier and do it in less space. And with LSI technology they run better and cooler—and will for years. Built-in dialer, redialing on busy signal, auto answer, plus extensive software command set.

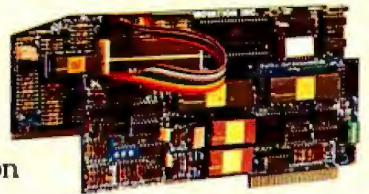
103 Smart-Cat (300 BAUD, full duplex) \$249\*  
103/212 Smart-Cat (300 or 1200 BAUD full duplex) \$595\*

## 212 AUTO-CAT™ MODEM



You get all the options of a full duplex Bell 212A compatible modem and more. It's an advanced modem with custom microprocessors and LSI circuits that have let us cut parts count and costs drastically—while improving performance in every way. Auto-answer and auto selection of 1200 bps or lower speed. Both synchronous and asynchronous. \$695\*

## APPLE®CAT™ II WITH 212 OPTION



Complete communication system for Apple owners. Modular design lets you grow into—not out of—the system. Comes with excellent software—our own Com-Ware™ is a simple-to-use, menu driven terminal program. Full range of speeds up to 1200 bps. All auto functions—phone directory with auto configuration and auto dial, redial, answer, disconnect. Binary or text modes. VisiCalc™ and CP/M™ compatibility—and the list is growing. Installation can still be just one slot in your Apple II, even with optional 212 card. \$389\* and up.

# Novation

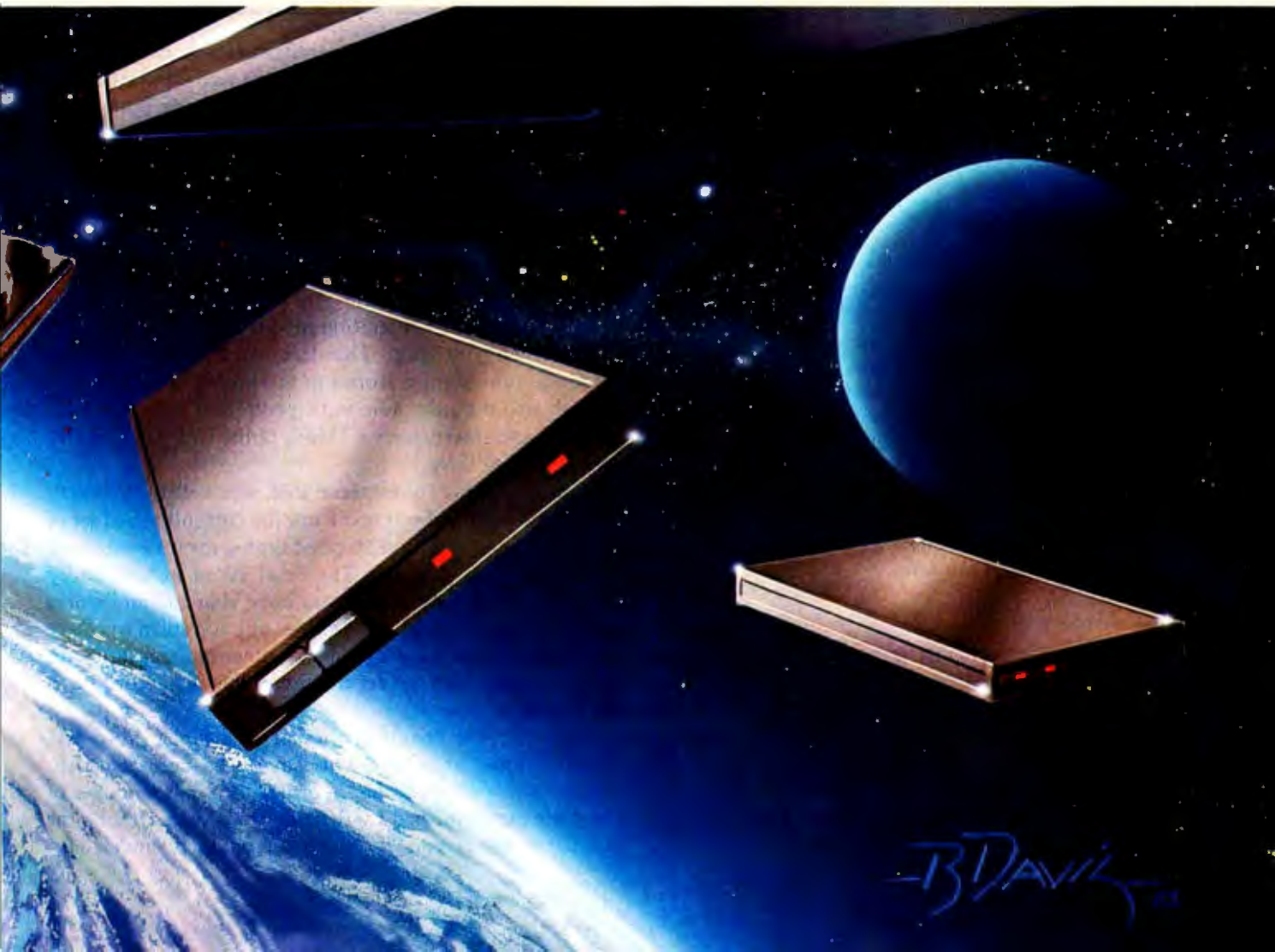


*The recognized leader in personal communications.*

Novation, Inc., 18664 Oxnard Street, Tarzana, CA 91356  
(800) 423-5419 · In California: (213) 996-5060

Cat is a registered trademark of Novation. VisiCalc is a trademark of Personal Software, Inc. CP/M is a trademark of Digital Research Inc. Apple is a registered trademark of Apple Computer Inc. \*Suggested retail

Circle 334 on inquiry card.



*B. DAVIL*



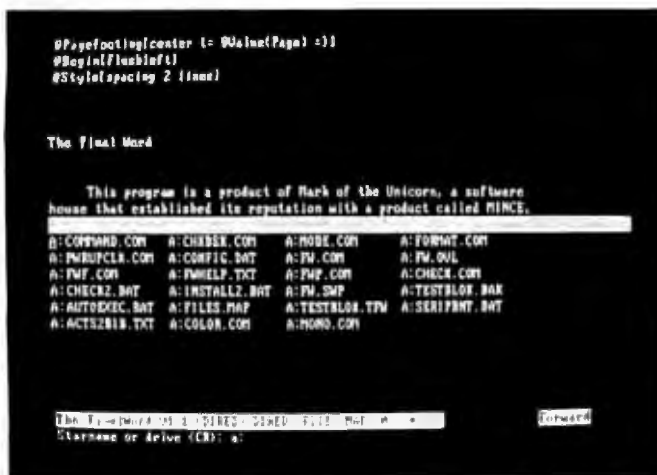


Photo 11: One of The Final Word's unusual features is the possibility of setting up two separate editing windows on the screen, with each window opening onto a different text buffer. Here the top window shows a portion of this article, while the bottom window shows a special buffer that contains the directory of one of the disks in the system. The white bar separates the two windows; the windows' relative sizes can be varied. You can also have as many as 12 buffers set up at once and switch between them with buffer commands.

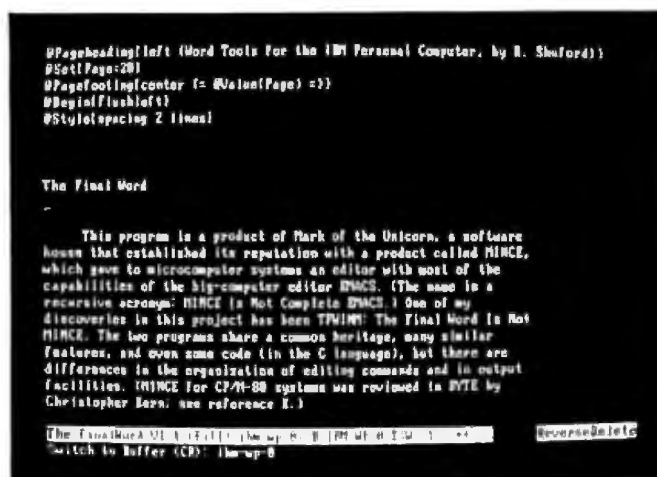


Photo 12: The Final Word's normal editing display. Status information is shown in the next-to-bottom line in inverse video, with transient messages and user-command input on the bottom line. The text is displayed in normal intensity. (You can change the character video attributes by using the system-configuration utility program.)

The five text lines at the top of the screen illustrate some of the embedded formatting commands used by The Final Word. These are interpreted by the formatting program and do not appear in the final output in this form.

Text continued from page 206:

other program. But with this great flexibility comes an extra measure of complexity. This program is more complicated than even Wordstar, but fortunately you don't have to learn every command and feature to productively use The Final Word. (One of the programmers for Mark of the Unicorn, Craig Finseth, described the concerns of the designers of the program in a BYTE article last year; see reference 2.)

## At a Glance

### Name

The Final Word

### Type

Word-processing program

### Manufacturer

Mark of the Unicorn Inc.  
POB 423  
Arlington, MA 02174  
(617) 489-1387

### Price

\$300

### Format

Two 5¼-inch floppy disks, PC-DOS (MS-DOS)

### Language

C (source code not available)

### Computer

IBM Personal Computer (as reviewed)

### Documentation

User's manual: 402 pages printed with letter-quality printer in large loose-leaf binder; tutorial files on distribution disks; reference card, function-key chart

### Audience

Users of word processing who need advanced features and extensive formatting capabilities

The Final Word has several unusual features including the following: You can view and edit two separate active documents (see photo 11), each in its own buffer and half-screen window, and you can transfer sections of text between the buffers. You can restore ("undelete") small segments or even large chunks of text that you have inadvertently or purposefully deleted. You can create files containing disk directories. And you can terminate execution of the program, do some other task with the computer, and then reactivate The Final Word to find your text buffers and even editing modes in place just as they were when you quit. This last capability is provided through information stored in the buffer-swap disk file, which also provides automatic protection against system crashes and interruptions. (Mark of the Unicorn calls this feature State Save.)

During editing, one special disk file, called FW.SWP, holds the swapped-out text from the currently used set of buffers. After you have stopped typing for seven seconds (or a duration you set), The Final Word automatically saves the segments of text you have changed and stores them on disk. This storage allows you to return to where you were after a power outage or other interruption with little trouble. You can set the size of this file according to your needs.

Some of the characteristics of The Final Word will seem strange to people who have been accustomed to some other editing system. For instance, block moves of text are accomplished by deleting the block, moving the cursor to where you want it to go, and then "undeleting"

# ESPRIT III™

goes TVI-950 one better.

Our new Esprit III™ is a plug-to-plug replacement for the TeleVideo TVI-950. Same command set. Same keyboard layout. The same features. Even the same user-PROM capability.

But Esprit III goes TVI-950 one better. And that one important difference is price. Esprit III costs \$300 less. In fact, it costs \$100 less than TeleVideo's far less capable TVI-925.

Look at the numbers. TVI-950 performance for less than TVI-925 cost. You'll agree. Esprit III is the best one.

	Esprit III	TVI 925*	TVI 950*
Buffered mode	Yes	Yes	Yes
Programmable function keys	Yes	No	Yes
Line graphics	Yes	No	Yes
Page/line transmit	Yes	Yes	Yes
Smooth scrolling	Yes	No	Yes
Price	<b>\$895</b>	\$995	\$1,195

\*Trademarks of TeleVideo Systems, Inc.

Esprit Systems, Inc., Hazeltine Terminals Division, 500 Commack Road, Commack, NY 11725 (516) 462-5598

*Esprit* Systems, Inc.  
Hazeltine Terminals Division



See us at  
NCC  
Booth W6288



the block. Anyone who has ever lost several hours' work on a computer system because of a careless erasure command will become quite nervous performing The Final Word's block-move procedure. (And you do have to be careful, because you can't do any further deletions to make room for the block at its intended destination without destroying it.)

In any attempt to rate word-processing programs by counting the number of commands, The Final Word would win hands down, at least in the group of programs reviewed here; there are nearly 160 different commands. It sounds like you could sink into a morass of control possibilities, but the program uses a logical series of menus to organize them. The structure of menu use seems somewhat akin to Wordstar's system, except that The Final Word goes one step further: three levels of menus for most commands, instead of two.

The most frequently used commands are assigned to single control characters (which you type with two key-strokes, of course). The two commands I used the most were the ones that change the direction of operation, either forward or backward. Most of the operations available in The Final Word proceed relentlessly in the selected direction. A set of commands select the operation that is to be performed, such as search for a string, delete an object forward, and delete ("kill") an object backward. Other commands select the text objects on which other commands operate. The objects are characters, words, sentences, lines, paragraphs, edges of lines, viewscreens, and buffers. (Does this remind you of Easywriter II? It's superficially similar, but the syntax is much more usable.) And some single control-character commands activate miscellaneous functions, such as "do the last operation again," "change the capitalization style of the word after the cursor," and "transpose the last two characters typed." This last command I found handy in correcting a common typographical error.

You type Control-X to cause a menu of menus to be displayed on the top section of the screen (see photo 13). You then type a character to select one of the submenus; when the submenu shows up, you type another character to activate the desired function. For instance, you can type Control-X to obtain the list of menus, then type "M" to select the Miscellaneous menu, and then type "Q" to select the Query Replace operation. As in Wordstar, if you type the commands fast enough, the menus don't show up on the screen. (The list of menus includes Buffers, Capitalization, Files, Help, Layout, Miscellaneous, Regions, Set, and Windows.)

If you don't like using the menus, you can use the function keys instead. And The Final Word has these in abundance, too. The directional cursor keys on the right work as you would expect (actually providing a mode of cursor movement not available through the Control-character functions). The Ins (insert) key works according to The Final Word's current mode.

Over on the left side of the keyboard, the assignable-function keys are used, consistent with the rest of The Final Word, in an exhaustive manner. First, ten functions

are assigned to the unaided keys F1 through F10. Ten more functions can be invoked by holding down a Shift key while pressing F1 through F10. Ten more are available through combinations with the Control key, and ten more by using the Alt key. These 40 functions have been reasonably assigned by Mark of the Unicorn, but if you don't like the assignments you can change them yourself. If you like to use function keys, this surely gives you as many as are practical on the IBM PC.

But this is not for me. I can remember mnemonically assigned control-character functions, even through three levels of menus, much better than I can remember arbitrary associations of numbered keys. ("Hmm. . . let me see; Alt-F2 is 'turn fill mode on or off,' but Shift-F2 is 'place cursor at marker,' or was it the other way around?") You do get a reference chart describing the uses of all 40 functions, but I think very few people will bother to learn more than the unaugmented set of 10.

The documentation for The Final Word is more than 400 pages in a large loose-leaf binder. Most of these pages are a reference and installation guide, but the first 10 chapters are a comfortably paced set of lessons for inexperienced users. Some of the lessons use tutorial text files, provided on one of the distribution disks, to enable you to practice using a basic subset of the editing and formatting commands. And if you forget a command during an editing session, you can obtain an explanation of the use of most commands from an online help file.

In formatting output, you can use The Final Word the same way you use the other three programs we've discussed: make the text look the way you want on the video-display screen and transfer the document to the printer in that format. But there is another choice.

The Final Word has a powerful advanced-formatting facility that can be invoked through an advanced-print command. You can embed any number of special formatting commands in the text to obtain perfect formal output arranged spatially and typographically into chapter titles, enumerated indented lists, subheads, tables of contents, indexes, and even cross-references. The formatter can rejustify text according to specifications given at print time, automatically number items, produce headers and footers with section and page numbers, and print numbered footnotes. Character attributes may be switched easily, and proportional spacing can be obtained via microspace justification on printers capable of it. (A large number of printers are supported by the output routine.) The formatter can even invoke the inclusion of sections of text not in the active document, but stored in a disk file, and you can type in text from the keyboard during printing for inclusion in the output. Page breaks are not normally shown on the video-display screen, but you can request a "view" output from the formatter.

There are two prices to be paid for all this wonderful capability (besides the cost of the program). The first price is learning the complications arising from inserting format commands into the text. It will probably take you many hours and much experimentation to become proficient in using the embedded commands. Fortunately, the

# THE FORTH SOURCE™

## MVP-FORTH - A Public Domain Product

MVP Forth is fig-FORTH updated to the FORTH-79 Standard Required Word Set. The source is public domain. Included are an editor, FORTH assembler, tools and utilities, making it compatible with the instructional book, *Starting FORTH*. Except for hardware dependencies, all high level FORTH is transportable between all systems. Modifications and extensions can be simplified through the use of MVP-FORTH Programming Aids and Meta and Cross Compilers.

## MVP FORTH Books - A Series

- Volume 1, All about FORTH** by Haydon. MVP-FORTH glossary with cross references to fig-FORTH, *Starting FORTH* and FORTH-79 Standard. 2<sup>nd</sup> Ed. \$25
- Volume 2, MVP-FORTH Assembly Source Code** includes CP/M, IBM-PC®, and APPLE® listing for kernel \$20
- Volume 3, MVP-FORTH Math & Floating Point Extensions** by Koopman. \$20

**MORE COMING!**

## MVP-FORTH Software - A Transportable FORTH

- MVP-FORTH Programmer's Kit** including disk, documentation, Volumes 1 & 2 of MVP-FORTH Series (*All About FORTH*, 2<sup>nd</sup> Ed. & *Assembly Source Code*), and *Starting FORTH*. Specify CP/M, IBM-PC, TRS-80/1® or 3, TRS Color Computer or APPLE \$150
- MVP-FORTH Cross Compiler** for CP/M Programmer's Kit. Can also generate headerless code for ROM or target CPU \$300

- MVP-FORTH Meta Compiler** for CP/M Programmer's kit. Use for applications on CP/M based computer. Includes public domain source \$150
- MVP-FORTH Fast Floating Point** for APPLE Programmer's Kit. Includes 9511 math chip on board with disk and documentation. \$400
- MVP-FORTH Programming Aids** for CP/M, IBM or APPLE Programmer's Kit. Extremely useful tool for decompiling, callfinding, and translating. \$150
- MVP-FORTH** by ECS Software for IBM-PC or ATARI® 400/800 Standalone with screen editor. License required. Upgradeable \$90
- MVP-FORTH** by ECS Software for IBM-PC or ATARI 400/800. Enhanced with color animation, multitasking, sound, utilities, and unlimited run time license. \$175
- MVP-FORTH Professional Application Development System (PADS)** for CP/M, IBM-PC, or APPLE. A three level integrated system with complete documentation. Complete system for IBM, CP/M, or APPLE \$400
  - MVP-FORTH PADS enhanced virtual system \$150
  - MVP-FORTH PADS Programming Aids \$150
  - MVP-FORTH PADS Meta Compiler \$150

\*\*\* MVP-FORTH operates under a variety of CPU's, computers, and operating systems. CP/M® disks can be supplied 8", 5.25", 3740 format or 5 1/4" for Osborne® Northstar® Micro Decisions® Kaypro® or H89/Z89®. Specify your computer and operating system. \*\*\*

## FORTH DISKS

FORTH with editor, assembler, and manual

- APPLE** by M.M. \$100
- APPLE** by Kuntza \$90
- ATARI®** valFORTH \$50
- CP/M®** by M.M. \$100
- HP-85** by Lange \$90
- IBM-PC®** by L.M. \$100
- NOVA** by GCI \$100
- TRS-80/1®** by N.S. \$90
- Z80** by L.M. \$50
- 8086/88** by L.M. \$100
- VIC FORTH** by HES. VIC20 cartridge \$60

Enhanced FORTH with: F-Floating Point, G-Graphics, T-Tutorial, S-Stand Alone, M-Math Chip Support, MT-Mult-Tasking, X-Other Extras, 79-FORTH-79.

- APPLE** by M.M., F, G, & 79 \$140
- ATARI** by PNS, F,G, & X. \$90
- CP/M** by M.M., F & 79 \$140
- Apple, GraFORTH** by Insoft \$75
- IBM-PC, PolyFORTH** by F.I, F, G, S, M, MT, & X \$300
- Multi-Tasking FORTH** by S.L., CP/M, X & 79 \$395
- TRS-80/1 or III** by M.M.S F, X, & 79 \$130
- TUTORIAL** by L & H, includes *Starting FORTH* \$95
- Extensions** for L.M IBM, Z80, and 8086
  - Software Floating Point \$100
  - 8087 Support (IBM-PC or 8086) \$100
  - 9511 Support (Z80 or 8086) \$100
  - Color Graphics (IBM-PC) \$100
  - Data Base Management \$200

**CROSS COMPILERS** Allow extending, modifying and compiling for speed and memory savings, can also produce ROMable code.

\*Requires FORTH disk

- CP/M \$300
- TRS-80/1 \$300
- Northstar® \$300
- 8086® \$300
- IBM® \$300
- Z80® \$300
- Apple II/II+ \$300
- fig-FORTH Programming Aids** for decompiling, callfinding, and translating. Specify CP/M, IBM-PC, 8086, Z80, or Apple \$150

Key to vendors:

F.I. FORTH Inc. M.M. MicroMotion  
L & H Laxen and Harris M.M.S. Miller Microcomputer Services  
L.M. Laboratory Microsystems N.S. Nauticus Systems  
S.L. Shaw Labs

**Jupiter Ace Computer - Z80 FORTH micro code - \$150**

## FORTH MANUALS, GUIDES & DOCUMENTS

- ALL ABOUT FORTH** by Haydon. See above. \$25
- FORTH Encyclopedia** by Derick & Baker. A complete programmer's manual to fig-FORTH with FORTH-79 references. Flow charted, 2<sup>nd</sup> Ed. \$25
- FORTH Encyclopedia Pocket Guide** \$7
- And So FORTH** by Huang. A college level text. \$25
- FORTH Programming** by Scanton \$17
- FORTH on the ATARI** by E. Floegel \$8
- Starting FORTH** by Brodie. Best instructional manual available (soft cover) \$16
- Starting FORTH** (hard cover) \$20
- 1980 FORML Proc.** \$25
- 1981 FORML Proc 2 Vol** \$40
- 1982 FORML Proc.** \$25
- 1981 Rochester FORTH Proc.** \$25
- 1982 Rochester FORTH Proc.** \$15
- A FORTH Primer** \$25
- Threaded Interpretive Languages** \$21
- AIM FORTH User Man** \$12
- APPLE User's Manual MicroMotion** \$20
- META-FORTH** by Cassady. Meta compiler in 8080 code \$30
- Systems Guide to fig-FORTH** \$25
- Caltech FORTH Manual** \$12
- Invitation to FORTH** \$20
- PDP-11 User Man.** \$20
- CP/M User's Manual, MicroMotion** \$20
- FORTH-79 Standard** \$15
- FORTH-79 Standard Conversion** \$10
- Tiny Pascal fig-FORTH** \$10
- NOVA fig-FORTH GCI** \$15
- Installation Manual fig-FORTH** \$15

**Source Listings of fig-FORTH**, for specific CPU's and computers. The Installation Manual is required for implementation. Each \$15

- 1802
- 8080
- PACE
- 68000
- 6502
- 8086/88
- 6809
- Eclipse
- 6800
- 9900
- NOVA
- VAX
- AlphaMicro
- APPLE II
- PDP-11/LSI-11
- Z80

**Ordering Information:** Check, Money Order (payable to MOUNTAIN VIEW PRESS, INC.), VISA, MasterCard or COD's accepted. No billing or unpaid PO's. California residents add sales tax. Shipping costs in US included in price. Foreign orders, pay in US funds on US bank, include for handling and shipping by Air: \$5 for each item under \$25, \$10 for each item between \$25 and \$99 and \$20 for each item over \$100. Minimum order \$10. All prices and products subject to change or withdrawal without notice. Single system and/or single user license agreement required on some products.

**DEALER & AUTHOR INQUIRIES INVITED**

# MOUNTAIN VIEW PRESS, INC.

PO BOX 4656

MOUNTAIN VIEW, CA 94040

(415) 961-4103

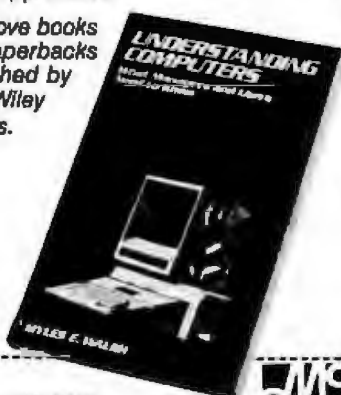


# McGraw-Hill Bookstore

## Popular Paperbacks To Increase Computer Usage

1. So You Think You Need Your Own Business Computer. The Manager's Guide to Selecting, Installing, and Using the Right Small Computer System by William E. Perry 216 pp. \$14.95
2. BASIC for the Apple II by Brown, Finkel and Elbracht. From fundamental principles to such advanced techniques and string variables, subscripted variables, subroutines, and more. 416 pp. \$12.95
3. Byteing Deeper into Your Timex Sinclair 1000 by Mark Harrison. Guidance in programming efficiently, 37 carefully selected programs. 176 pp. \$12.95
4. Successful Software for Small C Computers Structure Programming in BASIC by Graham Beech. For novice programmers, applications to business, science, computer science, education. 192 pp. \$14.95
5. 6502 Assembly Language Programming by Fernandez, Tabler, Ashley. For Apple, Atari, Commodore owners, 100s of opportunities to practice coding typical routines. 256 pp. \$12.95
6. Understanding Computers. What Managers and Users Need to Know by Myles E. Walsh. Computer fundamentals, step-by-step briefing on how complex chores are handled; plus info on data bases, storage and retrieval, teleprocessing, distributed processing. 266 pp. \$14.95

All above books are paperbacks published by John Wiley & Sons.



Please print clearly.  
This coupon is  
your shipping label.

McGraw-Hill Bookstore  
1221 Ave. of the Americas, N.Y., N.Y. 10020  
Send me (circle) book # 1 2 3 4 5 6

No. copies \_\_\_\_\_  
Check, money order or credit card only  
Visa \_\_\_\_\_ Amer Exp. \_\_\_\_\_ Master Chg. \_\_\_\_\_

BY5 3

Acct. No. \_\_\_\_\_ Expires \_\_\_\_\_

Name \_\_\_\_\_

Address \_\_\_\_\_

City \_\_\_\_\_ State \_\_\_\_\_ Zip \_\_\_\_\_

Add applicable sales tax, plus \$1.75 each postage and handling for the first book, \$.75 for each additional book.

commands are plainly recognizable in function; some typical commands are:

```
@Address[text]
@Majorheading[text]
@Style[Topmargin 6 lines]
```

There is even a @Verse format for those who are inclined to write poetry. Nonetheless, learning to write proper formatting commands is like learning to write programs for a FORTRAN compiler—error messages can suddenly come after the formatter has been running for three minutes, and you have to edit the file and start over.

The second price is the time required for the software to recognize and interpret all those embedded commands and the time needed by the formatter routine to process them. The time taken for The Final Word to do its housekeeping and begin printing a large document after you give the command can increase greatly when the formatter routine is called as part of the process. For instance, a 28,167-character file (last month's Ciarcia's Circuit Cellar) required 1 minute, 35 seconds for printing to begin without formatting; the duration jumped to 4 minutes with advanced formatting. If you want to format a lot of long documents, you'll find yourself taking a lot of enforced coffee breaks. But once the file has been formatted, you can start editing again as it prints. If most of your writing work involves producing documents with complicated structures, I think you'll gladly wait while the computer sorts it all out for you.

In addition to taking up time, the operation of the formatting routine also consumes a great deal of disk space. Unless you severely restrict your use of The Final Word, you'll need at least the disk space provided by two double-sided 5¼-inch floppy-disk drives.

Mark of the Unicorn, in contrast to Micropro International, allows you to customize your copy of The Final Word in a simple, menu-driven fashion. You can set up your preferred default conditions for editing and formatting parameters (such as indentation, tabs, preferred justification style, and page margins). You can define your own keyboard usage, binding functions to keys as you please. And if you need help, you can call or write Mark of the Unicorn.

### Conclusions

The four programs I've discussed here are a representative sample of the word-processing programs available for the IBM Personal Computer.

Two of them are important because of their wide commercial success: the February 1983 issue of *Softalk for the IBM Personal Computer* (reference 9) ranked Wordstar as the best-selling IBM PC program during December 1982, with Easywriter II ranked eighth in the same survey. (Wordstar is also important because of its many good features. I can't speak so highly of Easywriter II.)

The other two programs are significant because of the value they offer in functionality: Volkswriter provides simple, easily understood word-processing capability at a

# TIME SPECTRUM<sup>®</sup>

AN INNOVATIVE CONCEPT IN MODULAR EXPANSION

Only the new TIME SPECTRUM brings you a galaxy of expansion options for your IBM-PC<sup>®</sup>...with VERSAPAK<sup>®</sup>.

**VERSAPAK SERIAL EXPANSION MODULE** - Adds a second standalone serial asynchronous port with **COMPAK**.

**VERSAPAK SYNCHRONOUS EXPANSION MODULE** - Adds two standalone serial synchronous ports with **SYNCPAK**.

**VERSAPAK MEMORY MODULE** - Memory expansion from 256KB to 512KB in 64KB increments, with optional second serial asynchronous port with **RAMPAK**.

**CLIFFHANGER<sup>®</sup>** - Proprietary connector mounting hardware simplifies installation of I/O lines.

**TIME SPECTRUM FOUNDATION MODULE** - Contains a Real Time Clock, 64KB RAM (expandable to 256KB), serial asynchronous port, and optional parallel printer port.

Watch for new **VERSAPAK** modules to be introduced soon.

For more information on the revolutionary new **TIME SPECTRUM** and **VERSAPAK** expansion modules, see your nearest IBM-PC authorized dealer or contact:

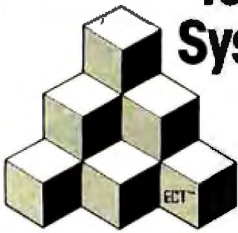
## PERSYST

15801 Rockfield, Ste. A, Irvine, CA 92714  
714-859-8871

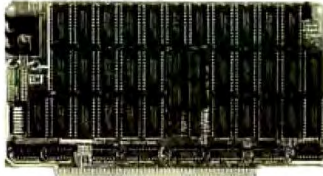


# ECT™

## Building Blocks for Microcomputer Systems, Dedicated Controllers and Test Equipment



**S-100  
64K  
STATIC  
RAM**



ECT's 64K STATIC RAM is a low power fully static 64K x 8 bit S-100 Bus Memory Board. 2716 EPROM's can be intermixed with the RAMs.

**\$399.00**

# ECT™

Specializing in Quality Microcomputer Hardware  
Industrial • Educational • Small Business • Personal  
Card Cages, Power Supplies, Mainframes, CPU's,  
Memory, I/O, OEM Variations

**ELECTRONIC CONTROL TECHNOLOGY, INC.**

763 Ramsey Ave., Hillside, NJ 07205 (201) 686-8080

OLIVETTI'S PRAXIS 30 PERSONAL PRINTER

# PRAXIS MAKES PERFECT™

AT THE PERFECT PRICE:

**\$599\***



\* add \$10 for shipping

- \* PORTABLE DAISY WHEEL PRINTER
- \* CENTRONICS AND WORDSTAR COMPATIBLE
- \* SERVICE FROM OLIVETTI DEALERS
- \* OLIVETTI APPROVED

\* VARIABLE PITCH ON PRAXIS 35, ADD \$100

TO ORDER SEE YOUR LOCAL DEALER, OR  
SEND CHECK OR MONEY ORDER TO:



**ARK MICROSYSTEMS  
P.O. BOX 4190  
ANN ARBOR, MI 48106  
(313) 769-7253**

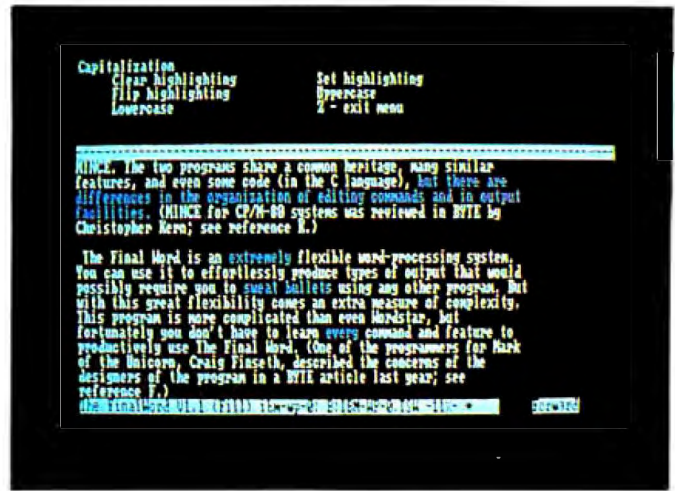


Photo 13: When you type Control-X, a top-level menu of menus appears at the top of the screen. You then type a character (control or regular) to select one of the menu choices, such as the menu of Capitalization commands shown here. You then hit one more key to invoke the desired operation.

This display, produced on an Amdek Color-II RGB (red-green-blue) video monitor, shows that portions of text designated to be highlighted on the screen show up in blue. Such highlighted text is underlined when the Monochrome Display Adapter is used.

relatively low price, while The Final Word, selling at a higher price, offers an amazing amount of flexibility for writing complex documents.

If I had to choose one of the four, I would probably buy The Final Word, because of its great flexibility, and yet there are things I don't like about the Mark of the Unicorn product. So I am still looking for the word-processing program of my dreams. In fact, I wrote most of this article using a fifth program I received too late to include in the project. So perhaps I'll be writing another review soon. In the meantime, consider your needs when you are choosing a word-processing program, and try before you buy. ■

### References

1. Cooper, Robert G. Jr., Paul Thain Marston, John Durrett, and Theron Stimmel. "A Human-Factors Case Study Based on the IBM Personal Computer." April 1982 BYTE, page 56.
2. Finseth, Craig A. "Managing Words: What Capabilities Should You Have with a Text Editor?" April 1982 BYTE, page 302.
3. Jong, Steven. "Designing a Text Editor? The User Comes First." April 1982 BYTE, page 284.
4. Kern, Christopher O. "MINCE, A Text Editor." September 1981 BYTE, page 150.
5. Kern, Christopher O. "The Scribble Text Processor." February 1983 BYTE, page 302.
6. Lemmons, Phil. "The IBM Personal Computer: First Impressions." October 1981 BYTE, page 26.
7. Press, Laurence I. (Larry). "Newest Easywriter Still in the Slow Lane: Version 1.0 a Lemon; 1.1 a Little Bit Sweeter." *Business Computer Systems*, November 1982, page 103.
8. Press, Larry. "Word Processors: A Look at Four Popular Programs." *onComputing*, Summer 1980, page 38.
9. "Softalk Presents the Bestsellers." *Softalk for the IBM Personal Computer*, February 1983, page 115.



# BASIC VS. JRT PASCAL:

A NO-HOLDS-BARRED COMPARISON.

**EASE-OF-USE** By dividing programs into modules, JRT Pascal makes even very complex programs—of nearly any size—a breeze to manage. Pascal code is *self-documenting*; program sections are identified by meaningful names, not line numbers. Error messages are verbal, not number codes. JRT offers 12 data types (to Basic's 2 or 3), and it has both regular and hex numbers.

**POWER** For power—the ability to write better, clearer programs, faster—Pascal is the run-away winner. Example: JRT simplifies programming by accomplishing complicated operations (for Basic) with one command:

<b>Basic</b>	<b>JRT Pascal</b>
IF A\$ = "V" OR A\$ = "W" OR A\$ = "X" OR A\$ = "Y" OR A\$ = "Z" THEN...	IF A IN ['V..Z'] THEN...

**FLEXIBILITY** JRT's wide variety of data types reduces programming restrictions. And the data types are not all fixed in size.

There are 3 looping statements (Basic has 1). With JRT, very large programs can be created and run, because program modules can be spread over many diskettes. Common modules can be used for several programs. Basic generally limits strings to 255 bytes; JRT strings go up to 64K.

**EFFICIENCY** Whereas Basic relies on a static, inefficient memory map to allocate storage, JRT's dynamic storage fills every available main storage area; there's no waste. With Basic, sub-routine modules must be linked together; with JRT, they can be linked—but don't have to be. JRT's more powerful commands run faster; typically, you'll write Pascal programs 3 to 10 times faster than in Basic. *Exclusive:* JRT lets you directly access the CP/M\* operating system for better total system control.

**NOW.** Consider our copy policy. (If you want to make copies, it's OK with us—so long as they're not for re-sale.) Check our astounding price: \$29.95!—and satisfaction is guaranteed—or your money back. Basic versus JRT Pascal: which comes out on top? Right! The coupon below is for your convenience. Or call. Today.

Here's the real shocker!		
Features	Basic	JRT Pascal
Structured programs	No	Yes
Separate compiled modules	"Chaining"	Structured procedures with auto-loading & purging
Arithmetic precision	Usually 6 or 7 digits	14 digits
Indexed files	No	Yes
Maximum string size	255 characters	64,000 characters
Loop statements	1	3
Data types	Usually 2 or 3	12
CASE statement	No	Yes
Introduced	1965	1980
Price	???	\$29.95!

Full support for indexed files

CRT screen formatting & full cursor control

Facilities for formatting printed reports

File variables & GET/PUT

Dynamic arrays

SEARCH procedures for fast table look-up

Extended CASE statements

Random files to 8 megabytes with variable length records

64K dynamic strings

Activity analyzer prints program use histogram

14 digit BCD FLOATING POINT arithmetic

True dynamic storage

Advanced assembly interface

Fast one-step compiler; no link needed

Efficient compiler needs only 85K diskette space

Maximum program size: more than 200,000 lines

More than 200 verbal error messages

Separate compilation of auto-loading external procedures

No limits on procedure size, nesting or recursion

175-page user manual with 3-ring protective plastic binder & 5 1/4" or 8" diskettes

Handy JRT Pascal reference card

Graphing procedures

Statistic procedures



THE COMPLETE PASCAL FOR CP/M.

# \$29.95!

JRT PASCAL 3.0

Send JRT SYSTEMS or  
to 45 Camino Alto/A21 phone 415/388-0530  
Mill Valley, CA 94941

Here's my \$29.95; please send me JRT Pascal. I understand that if I'm not completely satisfied, I can return it within 30 days—with the sealed diskettes unopened—for a full refund. (Allow 4-6 weeks for shipping.)

I need the 5-1/4" diskettes for  Apple CP/M;  Heath, Hard Sector;  Heath, Soft Sector;  Northstar;  Osborne;  Superbrain;  Televideo;  Xerox 820. I need  8" SSSD diskettes.

Name \_\_\_\_\_

Address \_\_\_\_\_

City \_\_\_\_\_ State \_\_\_\_\_ Zip \_\_\_\_\_

Check  C.O.D.  MasterCard  VISA  
(CA residents add sales tax. Add \$6 for shipping outside North America.)

Card # \_\_\_\_\_ Exp. \_\_\_\_\_

Signature \_\_\_\_\_

\*CP/M is a Digital Research TM.

A 56K CP/M system is required.



# Victor has delivered more advanced 16-bit microcomputers than any other manufacturer save one.

## Here's why: Unsurpassed price/ performance value.

One look at the prices and capacities of these three popular Victor 9000 configurations and you'll understand why the Victor has quickly become the world's 2nd most popular advanced 16-bit microcomputer.

The Victor 9000 quite simply offers the best price/performance combination available on the market today.

The powerful memory and storage capacities of the Victor 9000 are only part of the Victor performance story.

Designed to be a hardworking, hands-on computer, the Victor 9000 gives new meaning to the term "user-friendly." From the human size, detached keyboard to the tilting, turning, high resolution display screen, the Victor 9000 makes complex business computing easy. And with scores of proven business application software packages available right now, plus networking, complete communications capabilities, and a complete line of high performance peripherals, the Victor 9000 is the class of its class.

To get the complete story on the powerful, friendly and very affordable Victor 9000, just call the Victor office nearest you or call 1-800-VIC-9000.



**\$3,995.00**

### The 16-bit Victor 9000 Personal Business Computer with two single-sided floppy disks.

Includes two single-sided floppy disks providing 1.2 megabytes storage; central processing unit, CRT and detached keyboard; communications and networking capabilities.

### The 16-bit Victor 9000 Personal Business Computer with two double-sided floppy disks.

Includes two double-sided floppy disks with 2.4 megabyte storage; central processing unit, CRT and detached keyboard; communications and networking capabilities.

**\$4,745.00**



**\$5,995.00**

### The 16-bit Victor 9000 Personal Business Computer with internal hard disk.

Includes fixed/removable storage device featuring 10.6 megabyte fixed/ and 1.2 megabyte removable storage; central processing unit, CRT and detached keyboard; communications and networking capabilities.

# VICTOR®

Victor Technologies, Inc. P.O. Box 1135 Glenview, Ill. 60025  
1-800-VIC-9000

# Victor has delivered more advanced 16-bit microcomputers than any other manufacturer save one.

**Here's how: Unsurpassed local distribution, support and service nationwide.**

The Victor 9000 personal business computer system has the hardware and the software you need. But, equally important, Victor has the human ware. Our

new network of 8 districts, 50 branch offices and over 650 highly trained Victor dealers guarantees you superb day-in, day-out service and support. Locally, where you need it, when you need it. Which is what you should expect from a company with 66 years of experience in solving business application problems.

Here's how the Victor service/support network breaks down. As you can see, there's a Victor dealer near you.

**DISTRICT 1: ATLANTA**  
District Office  
320 Research Court  
Technology Park  
Norcross, GA 30092  
(404) 449-7950

**Indiana**  
1401 E. Riverside Drive  
Indianapolis 46202  
(317) 635-1236

**Minnesota**  
790 S. Plaza Dr., Mendota Hgts.  
55120-1572 (Minneapolis)  
(612) 454-8600

**DISTRICT 4: DALLAS**  
District Office  
1404 Walnut Hill Lane  
Irving, TX 75062  
(214) 258-5000

17241 Murphy Avenue  
P.O. Box 18528  
Irvine 92713 (Orange County)  
(714) 860-0363

**Branch Offices**  
Maryland (Includes Delaware)  
1031 Cromwell Bridge Road  
Towson 21204 (Baltimore)  
(301) 821-6710

**North Carolina**  
(Includes So. Carolina)  
1611 E. Seventh Street  
P.O. Box 9546 (28209)  
Charlotte 28204  
(704) 375-7708

**Pennsylvania**  
3559 Meadow Lane, P.O. Box 546  
Bensalem 19020 (Philadelphia)  
(215) 392-9510

**Virginia (Includes Wash. D.C.)**  
2110 Dabney Road, P.O. Box 6818  
Richmond 23230  
(804) 359-4081

7635 Sewells Point Road  
Norfolk 23513  
(804) 583-4511

8112 Catehouse Road  
Falls Church 22042  
(703) 573-0550

**DISTRICT 8: SAN FRANCISCO**  
District Office  
101 California St.  
San Francisco, CA 94111  
(415) 392-1981

Includes 6 branches and 67 dealers in 9 states.

**Branch Offices**  
California  
2718 J Street  
Sacramento 95816  
(916) 441-3158

5 Dorman Avenue  
San Francisco 94124  
(415) 826-8876

**Colorado (Includes Nebraska, Montana, Wyoming)**  
Waterfront Business Park  
7100 N. Broadway, Bldg. 4A  
Denver 80221  
(303) 428-4950

**Oregon (Includes Idaho)**  
14215 N.W. Science Park Dr.  
Portland 97228  
(503) 640-0535

**Utah (Includes Idaho)**  
537 E. Third, South  
Salt Lake City 84102  
(801) 363-0535

**Washington (Includes Montana, Hawaii, and Alaska)**  
13400 Northrup Way  
Bellevue 98005 (Seattle)  
(206) 824-7980

Includes 7 branches and 70 dealers in 5 states.

**Branch Offices**  
Alabama  
601 S. 37th Street  
Birmingham 35222  
(205) 252-2178

**Florida**  
5228 Beach Boulevard  
Jacksonville 32207  
(904) 386-7751

3000 W. Hallandale Bch. Blvd.  
Hallandale 33009 (Miami)  
(305) 458-3356  
(305) 949-4246 (Miami)  
(305) 421-8583 (Deerfield Bch.)

649 W. Vasquez Street  
Orlando 32804  
(305) 841-9251

**Georgia**  
580 Peachtree-Dunwoody Rd.  
Suite 102  
Atlanta 30342  
(404) 298-1044

**Tennessee**  
169 Racine Street, P.O. Box 11698  
Memphis 38111  
(901) 324-5554

702 Melpark Drive,  
P.O. Box 40844  
Nashville 37204-0644  
(615) 382-0151

**DISTRICT 2: CHICAGO**  
District Office  
3 O'Hare Tower  
8420 W. Bryn Mawr Ave.  
Chicago, IL 60631  
(312) 399-1500

**Missouri**  
200 N. Leffingwell at Pine  
St. Louis 63103-2295  
(314) 535-9900

**Wisconsin**  
9028 W. Capitol Drive  
Milwaukee 53222  
(414) 438-0305

**DISTRICT 3: CLEVELAND**  
District Office  
8133 Rockside Road, Suite 302  
Independence, OH 44134  
(216) 447-8890

Includes 7 branches and 95 dealers in 5 states.

**Branch Offices**  
Kentucky  
2480 Bardstown Road  
Louisville 40205  
(502) 458-5281

**Michigan**  
23200 Telegraph Road  
P.O. Box 2165 (48037)  
Southfield 48034 (Detroit)  
(313) 355-5330

**New York**  
3435 Harlem Road  
Cheektowaga 14229 (Buffalo)  
(716) 838-5100

**Ohio**  
5621 Creek Road  
Blue Ash Industrial Park  
Cincinnati 45242  
(513) 984-1080

3261 E. Royalton Road  
Broadview Hgts. 44147 (Cleve.)  
(216) 526-0260

3972 Indianapolis Avenue  
P.O. Box 14405  
Columbus 43214  
(614) 263-8606

**Pennsylvania**  
(Includes W. Virginia)  
108 Rosalyn Road  
Carnegie 15108 (Pittsburgh)  
(412) 278-5300

**Branch Offices**  
Arkansas  
1000 W. 3rd Street  
Little Rock 72205  
(501) 376-0605

**Missouri (Includes Nebraska)**  
1535 Broadway  
Kansas City 64108  
(816) 842-7856

**Louisiana**  
1605 Dallas Drive  
Baton Rouge 70808  
(504) 927-4180

3220 Interstate 10 Service Rd.  
Metairie 70001 (New Orleans)  
(504) 831-2801

**Texas**  
3018 Diamond Park Drive  
P.O. Box 47746 Dallas 75247  
(214) 831-8430

5818 Southwest Freeway  
Houston 77057  
(713) 782-8954

2201 Cee Gee Street  
San Antonio 78217  
(512) 828-8471

**DISTRICT 5: LOS ANGELES**  
District Office  
17744 Skypark Circle  
Suite 274  
Irvine, CA 92714  
(714) 850-8944

Includes 4 branches and 61 dealers in 4 states.

**Branch Offices**  
Arizona (Includes New Mexico)  
8126 N. 23rd Avenue  
Suite D Phoenix 85021  
(602) 249-4887

**California (Includes Nevada)**  
1202 Olympic Boulevard  
Santa Monica 90404 (L.A.)  
(213) 450-1559

3661 Camino Del Rio S.  
San Diego 92108  
(714) 283-7001

**DISTRICT 6: NEW YORK**  
District Office  
2005 Rf. 22  
P.O. Box 1463  
Union, NJ 07083  
(201) 687-4700

Includes 7 branches and 95 dealers in 8 states.

**Branch Offices**  
Connecticut  
West Hill Center  
21 New Britain Avenue  
Rocky Hill 06067  
(203) 583-5388

541 W. Putnam Avenue  
Greenwich 06830  
(203) 629-9091

**Massachusetts (Includes Maine, Vermont, New Hampshire)**  
135 Bear Hill Road  
Waltham 02154 (Boston)  
(617) 890-3800

**New Jersey**  
2005 Route 22, P.O. Box 1463  
Union 07083  
(201) 687-4700

**New York**  
(Includes Rhode Island)  
Three Corporate Plaza  
Washington Ave. Extension  
Albany 12203  
(518) 869-8446

99 Jericho Turnpike  
Jericho 11753 (Long Island)  
(516) 334-7715

355 Lexington Avenue  
New York City 10017  
(212) 697-8900

**DISTRICT 7: WASHINGTON**  
District Office  
8260 Greensboro Drive  
Suite 510, McLean, VA 22102  
(703) 448-1185

Includes 5 branches and 88 dealers in 7 states and the District of Columbia.

To get the complete story on the powerful, friendly and very affordable Victor 9000, just call the Victor office nearest you or call 1-800-VIC-9000.

# VICTOR<sup>®</sup>

Victor Technologies, Inc., P.O. Box 1135, Glenview, Ill. 60025 1-800-VIC-9000



## A Comparison of Five Database Management Programs

*Actual field use uncovers surprising results.*

---

Jack L. Abbott  
8525 North 10th Ave.  
Peoria, AZ 85345

---

Database management systems, or DBMSs, are general-purpose programs that accept data in a format that you determine, process the data according to your requirements, and then output the data in the report format that you specify. While a review of such a program may tell you about its major features, only by comparing several DBMSs can you determine which program best fits your needs.

A good DBMS should fill the gap between a custom-designed application program and an off-the-shelf general-purpose package. I designed a comparison test of five DBMSs around that specification. I looked at the Selector V by Micro-Ap Inc., dBASE II by Ashton-Tate, FMS-80 by Systems Plus, Condor III by Condor Computer Corporation, and Analyst and Qsort by Structured Systems Group. By using an actual inventory file maintained by two jewelry stores as test data, I uncovered some significant differences in these programs.

Essentially, DBMSs perform four functions: data input, selection and sorting, processing, and report output. The comparison test included all these functions. In table 1, you see a typical example of the data-input format used to maintain the inventory for the two jewelry stores. The two stores have a total of 1007 different types of jewelry pieces with varying quantities of each type. The data-input format consists of 15 descriptive items or fields about each different piece of jewelry. The complete description of one piece of jewelry requires a total of 128 characters (bytes) and is called a record. The 1007 records make up the inventory file. This file occupies between

135K and 155K bytes of disk storage depending on the storage method used by the particular DBMS.

After establishing the input format, I displayed this information on the screen. The display is similar to that of table 1, except that blank spaces are provided after each field name so the inventory data can be typed in for each record. After entering the jewelry stores' inventory data, I translated the jewelry-store file to the individual formats of the five DBMSs. I used the file as a benchmark to compare these programs.

Data-input functions include defining the structure of the records as shown in table 1. Custom input screens may also be generated by some of the DBMS programs. Instead of the columnar input format, a custom screen permits placement of identifying labels and adjacent blank spaces where you can type in the field information. An example is a screen display of a purchase-order form. You enter the order data into the blank spaces of that form for each field in the record. The DBMS then saves the data for subsequent processing.

The second function is selection and sorting. Let's assume that, after all the jewelry store inventory data has been entered, you want to find all individual records that pertain to rings. The most effective way is to first either sort or index records on one or more selected fields. Sorting a file aligns all the records in ascending or descending order based on the alphabetical or numeric values in one field. Indexing a file accomplishes almost the same result but requires much less disk storage space because only a single selected field of a record (with an index pointer to the full record) is sorted.

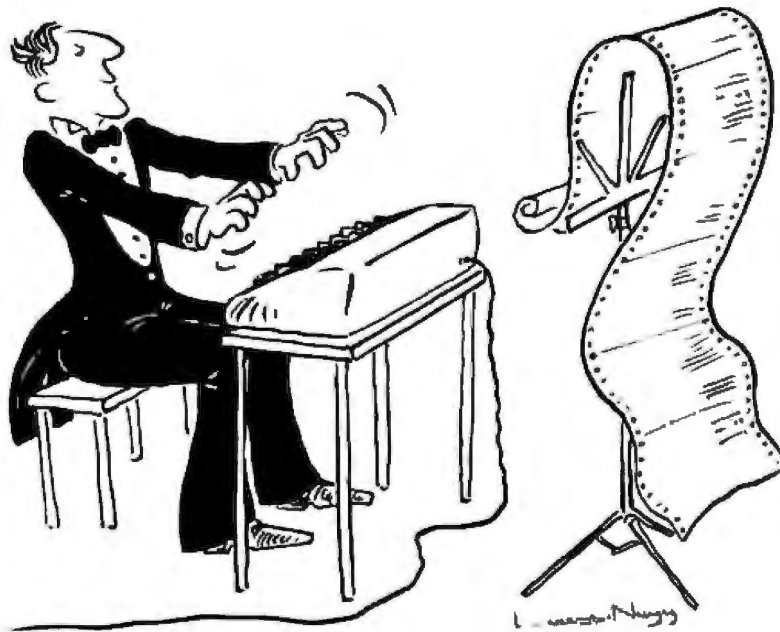
In my example, the CATEG (category) field of each jewelry-file record tells whether the record pertains to chains, rings, watches, brooches, etc. To find all the ring records, you ask the DBMS to sort or index the file, placing each record in alphabetical ascending order based on

---

### About the Author

Jack L. Abbott was previously manager of systems programming at Philco Western Programming Development Laboratories in Palo Alto, California. He is now a consultant and owner of the Software Center, a software store, in Glendale, Arizona.

---



# The Well-Tempered Cross-Assembler

Before Johann Sebastian Bach developed a new method of tuning, you had to change instruments practically every time you wanted to change keys. Very difficult.

Before Avocet introduced its family of cross-assemblers, developing micro-processor software was much the same. You needed a separate development system for practically every type of processor. Very difficult and very expensive.

But with Avocet's cross-assemblers, a single computer can develop software for virtually any microprocessor! Does that put us in a league with Bach? You decide.

## Development Tools That Work

Avocet cross-assemblers are fast, reliable and user-proven in over 3 years of actual use. Ask NASA, IBM, XEROX or the hundreds of other organizations that use them. Every time you see a new microprocessor-based product, there's a good chance it was developed with Avocet cross-assemblers.

Avocet cross-assemblers are easy to use. They run on any computer with CP/M\* and process assembly language for the most popular microprocessor families.

XASMO5 ...	6805	} \$200 each
XASMO9 ...	6809	
XASM18 ...	1802	
XASM48 ...	8048/8041	
XASM51 ...	8051	
XASM65 ...	6502	
XASM68 ...	6800/01	
XASMF8 ...	FB/3870	
XASM28 ...	Z8	
XASM400 ...	COP400	
XASM75 ...	NEC 7500	\$500
(Coming soon: XASM68K ... 68000)		

## Turn Your Computer Into A Complete Development System

Of course, there's more. Avocet has the tools you need from start to finish to enter, assemble and test your software and finally cast it in EPROM:

**Text Editor VEDIT** -- full-screen text editor by CompuView. Makes source code entry a snap. Full-screen text editing, plus TECO-like macro facility for repetitive tasks. Pre-configured for over 40 terminals and personal computers as well as in user-configurable form.

CP/M-80 version ..... \$150  
 CP/M-86 or MDOS version ..... \$195  
 (when ordered with any Avocet product)

**ROM Simulator** -- ROMSIM by Inner Access eliminates need to erase and reprogram EPROM. Installed in an S-100 host, ROMSIM substitutes RAM for EPROM in external target system. 16K memory can be configured to simulate the 2708, 2758, 2716, 2516, 2732, 2532, 2764, 2564 in either byte or word organization. Avocet's configurable driver makes loading of HEX or COM files fast and easy.

From \$495 depending on cabling and RAM installed.

**EPROM Programmer** -- Model 7128 EPROM Programmer by GTek programs most EPROMS without the need for personality modules. Self-contained power supply ... accepts ASCII commands and data from any computer through RS 232 serial interface. Cross-assembler hex object files can be down-loaded directly. Commands include verify and read, as well as partial programming.

PROM types supported: 2508, 2758, 2516, 2716, 2532, 2732, 2732A, 27C32, MCM8766, 2564, 2764, 27C64, 27128, 8748, 8741, 8749, 8742, 8751, 8755, plus Seeq and Xicor EEPROMS.

(Upgrade kits will be available for new PROM types as they are introduced.)

Programmer ..... \$389  
 Options include:  
 Software Driver Package ..... \$ 30  
 RS 232 Cable ..... \$ 30  
 8748 family socket adaptor .... \$ 98  
 8751 family socket adaptor ..... \$174

## Call Us

If you're thinking about development systems, call us for some straight talk. If we don't have what you need, we'll help you find out who does. If you like, we'll even talk about Bach.

VISA and Mastercard accepted. All popular disc formats now available -- please specify. Prices do not include shipping and handling -- call for exact quotes. OEM INQUIRIES INVITED

\*Trademark of Digital Research



**AVOCET  
SYSTEMS INC.**

DEPT. 583-B  
 804 SOUTH STATE STREET  
 DOVER, DELAWARE 19901  
 302-734-0151 TLX 467210



STRUCTURE FOR FILE: JEWELRY.DBF

NUMBER OF RECORDS: 00000

DATE OF LAST UPDATE: 00/00/00

PRIMARY USE DATABASE

FLD	NAME	TYPE	WIDTH	DEC	Explanatory note:
001	STOCKNBR	C	010		STOCKNUMBER
002	CATEG	C	008		CATEGORY (RINGS, BROOCHES, ETC.)
003	STYLE	C	010		STYLE (LADIES, MENS, GOLD, ETC.)
004	QTY	N	004		QUANTITY
005	COSTGM	N	010	002	COST PER GRAM
006	COSTCT	N	010	002	COST PER CARAT
007	TOGWT	N	010	002	TOTAL GRAM WEIGHT
008	TOTCWT	N	010	002	TOTAL CARAT WEIGHT
009	STNWTEA	N	010	002	STONE WEIGHT EACH
010	STNWTTOT	N	010	002	STONE WEIGHT TOTAL
011	COSTEA	N	009	002	COST EACH
012	TOTCST	N	010	002	TOTAL COST
013	STORE	N	001		STORE
014	VENDOR	C	007		VENDOR
015	ENTDATE	C	008		ENTRY DATE
**	TOTAL	**	0012B		

Table 1: Example of data-input format used for the jewelry-store inventory. FLD is the field number, NAME is field description, TYPE describes whether the entry is alphabetical or numeric, WIDTH is the number of characters in the field, and DEC is the number of decimal places used in the field.

a comparison of the alphabetical values in the CATEG field.

After the data file has been sorted or indexed at your typed-in request, the DBMS will rapidly run through the file or the index and select all the records in the rings category. At your option the selected records are then either displayed, printed, or placed in a separate file for further processing.

For the third function, processing, you tell the DBMS to perform specific operations on the selected records. Using the ring example, let's say you want to record a 20 percent price increase for all rings. First, you ask the DBMS to divide the COSTEA (cost each) field of every ring record by .80 to reflect the 20 percent price increase. You then multiply the QTY (quantity) value by the COSTEA value and store the result in the TOTCST (total cost) field. You can perform similar mathematical operations on any fields in the record.

The fourth function, output, may be a simple listing of the selected data or a more elaborate presentation, including statistical summaries, subtotals, and totals on a formatted page report. The more sophisticated DBMSs include report output generators that make it possible for you to print your data output as mailing lists, checks, purchase orders, invoices, or in any desired format.

DBMS designers use two general methods for function selection. One method displays a list of general functions as soon as the DBMS starts to run on the computer. From this list, or menu, you select a submenu that expands your selected function into a detailed list of tasks. The second method presents you with a blank screen after the DBMS is loaded. You must initiate the DBMS directly, using its commands individually, or through a command file. A command file is simply a series of DBMS commands written in sequence. You use a single initiating

command to execute that entire sequence of commands. The sequence may include commands to accomplish specific tasks or to display Help information and menu selections.

Ideally a DBMS should handle any application. In actuality design trade-offs occur, making some DBMSs more effective than others for a given application. The jewelry-store inventory, for example, has only one relatively short data file, but it must be accessed and updated as quickly as possible. An important characteristic of a DBMS for a jewelry-store inventory would be speed. In another application (for example, when processing personnel records), the DBMS must readily access several different files (such as payroll, hiring, and job performance information). Information may be required about one person from many files, a number of people from one file, or a number of different people from a number of different files. The DBMS must provide data from all these files with reasonable speeds, but definitely not the rapid access required by the inventory application. Additionally, the DBMS that processes personnel records must handle longer record lengths and a larger number of files than a DBMS that handles inventory data. Hierarchical or network DBMSs are better for simultaneous, multiple-file access while relational DBMSs are most efficient when extracting data from one file at a time.

### Data Storage Requirements

For each of the five DBMSs discussed here, you should have available two disk drives with (depending on your application) a minimum capacity of at least 300K bytes per drive. (Table 2 presents the system requirements for each of the DBMSs plus the maximum number of records, file size, and record length that each DBMS will handle.) As I mentioned earlier, the example jewelry-



The QX-10.  
No ad can do it justice.

# Epson.

There's an awful lot of computer hype these days. And we think it's time for a little old-fashioned honesty.

So we're going to give you a few solid reasons why — even if you look at nothing else — you should go to your dealer and take a close look at the new Epson QX-10.

**Anybody can use it.**

What makes the QX-10 the most remarkably usable computer to date is a unique software system called VALDOCS, coupled with a new keyboard design called HASCI. VALDOCS reduces the time it takes to master the QX-10 from hours to minutes by displaying exactly what your options are, while the straightforward, detachable HASCI keyboard places all the most-used functions right in front of you, grouped logically and labeled in plain English.

**You may never buy software again.**

VALDOCS may be all the software you'll ever need. Right out of the box it's a sophisticated *word processor*; an *information indexer* for easy access to files; an *electronic mail system*; a *calcula-*

*tor*; an *appointment book and notepad*; and a *high resolution business graph drawing system*.

**A little price tag.**

Mere words are not enough. To fully appreciate the powers of this machine, you must experience it for yourself. So visit your dealer and see what it can do. And if that doesn't sell you, the comfortable price tag will. It sells for under \$3000. And that's no hype.



**EPSON**  
EPSON AMERICA, INC.  
COMPUTER PRODUCTS DIVISION

Call (800) 421-5426 for the Epson dealer in your area.



DBMS	Program Version	Operating System (8 bit)	Operating System (16 bit)	Memory Requirements (in bytes)	Maximum Records Per File	Maximum Record Length (in bytes)
Analyst and Qsort	2.0	CP/M and MP/M	not available	48K	65,535	255
Condor III	2.09	CP/M and MP/M	MS-DOS and CP/M 86	56K	32,767	1024
dBASE II	2.3B	CP/M and MP/M	MS-DOS and CP/M 86	48K (16-bit version: 128K)	65,535	1000
FMS-80	2.21D	CP/M and MP/M	not available	56K	65,535	20K +
Selector V	1.04	CP/M and MP/M	MS-DOS and CP/M 86	56K	65,535	25,245

**Table 2:** Statistical information about each database management system. Figures in the table list the maximum length and number of possible records, but the disk configuration of your system will determine the maximum number of files.

store database file of 1007 records occupies from 135K bytes to 155K bytes of storage on a disk depending on the disk storage format. Each time you sort the file on a different field, an additional equal amount of storage is required. Indexing a file is similar to sorting but requires much less disk storage space. In the jewelry-store example, a median disk storage requirement for an index file on the CATEG field is 35K bytes. This figure will vary depending on the number of characters in the indexed field.

While not absolutely necessary, it is desirable to have the DBMS and required CP/M utilities on one drive and the data file on another. Compare my example file with your own intended application. Consider that if I keep all the jewelry file data on one drive, the example file will occupy 135K bytes, and with one additional sort the files will occupy a total of 270K bytes on a typical 320K-byte system drive.

Analyst and Qsort are written in CBASIC2, but a runtime interpreter is furnished and need not be purchased separately. FMS-80, dBASE II, and Condor are written in assembly language. Selector V is written in compiled CBASIC2. Assembly-language coding is the fastest and most efficient, followed by compiled CBASIC, with interpreted CBASIC the slowest. The compiled CBASIC program Selector V performs some functions more rapidly than assembly-language-coded programs. However, assembly-language-coded programs require less memory and disk storage space.

### Timing Comparison

Table 3 shows how the five DBMSs fared in timing tests that were run on a Dynabyte 8/1 8/4 Z80 micro-computer running at 4 megahertz with 64K bytes of RAM (random-access read/write memory), two 8-inch drives, and a Televideo 925 terminal. Benchmark tests on this machine place it as average or a little better in comparison to the processing times of most popular micro-computers. Significantly better times will be obtained if you have a hard-disk drive or use a RAM drive. (A RAM drive is a program and additional RAM that look to the computer like a very fast simulated disk drive and speed up processing greatly.)

Now let's consider some of the factors influencing the

test results for each of the five DBMSs:

**Analyst and Qsort** (\$350 from Structured Systems Group, 5204 Claremont, Oakland, CA 94618; (415) 547-1567): The longer times required for this DBMS to load individual menus are a result of its being written in interpreted CBASIC2. Once the menus are reached, processing times are very fast. This program does not have file indexing. A sequenced file is obtained by sorting. The disadvantage is that a sorted file takes up as much disk storage space as the original file. Its file-sort time is the best of the five DBMSs. Times to locate a record after the sort is finished are comparable to indexed files.

**Condor III** (\$995 from Condor Computer Corp., POB 8318, Ann Arbor, MI 48107; (313) 769-3988): Because this DBMS is written in assembly language, the time required to bring up the program or to switch from one function to another is 2 or 3 seconds. There is no menu, but you can easily construct one using a command file and the supplied screen-display generator. Condor will sort a 128K-byte file in 3 minutes and 30 seconds. By chance, the jewelry file is 128K bytes. To sort a file over 128K bytes in length, you must split the file into sections and then sort each section. The individual sections must then be recombined. This is a time-consuming and somewhat complex procedure and is a serious deficiency if you plan to generate large files. (The latest version of Condor is now able to sort files larger than 128K bytes.)

**dBASE II** (\$700 from Ashton-Tate, 10150 West Jefferson Blvd., Culver City, CA 90230; (213) 204-5570): Like Condor, this DBMS does not have menus for the individual processing tasks. The program will load and be ready for operation in 2 or 3 seconds. You must remember the commands to implement the program's functions. As an alternative, it is a simple matter to use the supplied screen display generator to construct a command file help menu. You can request the help menu to be displayed at the outset. Command file menus can also be generated to select groups of sequenced commands.

The most significant deviation from the other four DBMS processing times is listed in comment 5 of table 3. It took 1 hour and 21 minutes to delete 50 records from the database and re-index the file on one field. This is not as serious as it might first appear because records are first marked for deletion but are not permanently erased until

Maximum Fields Per Record	Maximum Field Length	Digits of Accuracy	Screen Editing
50	255	14	line oriented
127	127	10	fully addressable cursor
32	254	10	fully addressable cursor
255	255	10	fully addressable cursor
99	255	14	fully addressable cursor

a pack operation is accomplished. Marking the record for deletion takes little time. It is simply a matter of finding the record in the file and then marking it. Records can generally be located within a few seconds. After the record is marked it will be ignored by the program for most processing or selection tasks. To complete the process and regain the disk storage space used by the deleted records you must then execute a pack command. Next the file must be rewritten to the disk to condense the CP/M disk file. The records can be marked for deletion during normal operations and then at night or during a slack period the pack operation and file rewrite can be performed.

**FMS-80** (\$990 from Systems Plus, 3975 East Bayshore, Palo Alto, CA 94003; (415) 969-7047): This DBMS has menus for each function. It is written in machine language and the times to bring up the various menus are short. It took 15 minutes to merge and re-index the file after entering 50 new records. This is longer than the time taken by the other DBMS programs to perform this function. In addition, each time you first ask FMS-80 to find a record by searching the index file, it responds, "please be patient, re-establishing index file." This took another 25 seconds with the jewelry file. Subsequent searches take only 2 or 3 seconds to find a record. A very good feature not reflected in the timing charts is the capability to modify (but not delete) records directly from the index file. This can be accomplished in seconds. This may explain why the file must be reestablished each time it is used.

**Selector V** (\$495 from Micro-Ap Inc., 7033 Village Parkway, Suite 206, Dublin, CA 94568; (415) 828-6697): The times for Selector V, a compiled CBASIC2 program, to bring up its menus are much shorter than those required for Analyst and Qsort, an interpreted CBASIC2 program, and are comparable to those of FMS-80, a machine-language program. The times to go to the different functions of Selector V are very good indeed.

### Distinguishing Features

Of course, there's more to a database management system than storage requirements and execution times. Now I'll discuss the individual systems in terms of those features that set each DBMS apart from the rest.

**Analyst and Qsort:** Program functions are selected from menus. Times to load program modules to accomplish different functions are slower than for the other DBMSs. This may not be a handicap if a number of records are processed at a time. After a function menu has been displayed and the program module loaded, processing execution times are excellent. File indexing is not available. The same results are obtained by sorting the file. Logical selection times for individual records or groups of records are as short as for indexed files. Qsort can be used as a stand-alone program to sort data generated by other programs. Report outputs are limited to six lines for each record unless the program structure is modified. This permits mailing-label generation but limits the output formats available to forms less than six lines in length. Analyst always puts in a form-feed prior to starting a report.

Command-file generation procedures are not available. Report output procedures are complex to establish, but the descriptive documentation is excellent. To use any of the CP/M operating-system commands, you must exit the Analyst program. This is the lowest-priced of the DBMSs reviewed and should be considered if it can accomplish your application.

**Condor III:** This DBMS has an excellent screen and report generator. Although Condor, dBASE II, and FMS-80 all include a programming language for generating command files, the Condor programming language is the easiest of the three to learn. Indexing can be automatically accomplished on one field after new records are entered. Condor is especially well suited for accounting applications because a number of commands are tailored specifically for that use. Every time that you bring up Condor, you must enter a six-digit serial number, otherwise the program will not perform properly. I don't like this feature because it takes time and is nonproductive. A major drawback of this DBMS is the limitation of not being able to sort files over 128K bytes in length without dividing and then recombining them. This is particularly annoying because it is necessary to sort a file to permanently remove deleted records. An outstanding interface is maintained with CP/M, and any required operating-system commands, including calling up disk directories, are available without leaving the DBMS. Command files can be generated that enable the program to perform sequenced commands or display a user-designed menu with only one command entry. In the processing area, Condor DBMS has no mathematical precedence established and does mathematical operations in the same order they are entered. Fractional results will always be rounded off to two decimal places. The Condor documentation is good, but it would be helpful if examples of more applications were included.

**dBASE II:** One of dBASE II's strongest points is its ability to access a data file rapidly and to find and display or print out single or groups of logically selected records with a minimum of operator direction. Simple application programs can be easily generated by the newcomer to computing. For more complex applications, the



Program Operation or Function	Analyst and Qsort	Condor III	dBASE II	FMS-80	Selector V
1. Time from when initiating command is typed in until database main menu is displayed or until the database is ready to accept commands if there is no menu.	35 sec.	3 sec.	3 sec.	28 sec.	18 sec.
2. Time to go from main menu, or time until database program is ready to accept commands to examine, edit, or enter data.	30 sec.	3 sec.	3 sec.	5 sec.	5 sec.
3. Length of time to return to the main menu from data examine, edit, or enter-data function.	15 sec.	3 sec.	3 sec.	5 sec.	5 sec.
4. Time required to accept, merge, and sort or (where applicable) re-index on one field 50 records into the 1007-record test inventory file. Does not include time required to type in the record data.	2 min. & 50 sec.	3 min. & 45 sec.	3 min. & 25 sec.	15 min.	1 min.
5. Time required to delete 50 records from the 1007-record test file. This includes cleaning up and compacting the file after the records have been marked for deletion but does not include the time required to mark or select the records for deletion.	20 min.	7 min. & 30 sec.	1 hour & 21 min.	11 min. & 40 sec.	1 min. & 20 sec.
6. Time required to sort the 1007-record inventory example file on one field. All the records are aligned in alphabetical order based on the information contained in one field.	2 min. & 46 sec.	3 min. & 30 sec.	14 min. & 30 sec.	12 min.	3 min.
7. Time required to index the 1007-record file on one field.	not applicable	3 min. & 30 sec.	3 min.	4 min.	4 min.
8. Time to find a single record by key search with the record located at the other end of the 1007-record file from where the search is started.	3 sec.	3 sec.	3 sec.	3 sec.	3 sec.
9. Time required to extract 50 selected records spaced equidistantly throughout the 1007-record file.	6 min. & 30 sec.	20 sec.	3 min.	4 min.	2 min. & 30 sec.
10. Time required to go from the main menu or from when the DBMS is ready to accept a command to the start of printing a selected report.	25 sec.	3 sec.	3 sec.	6 sec.	18 sec.
11. Time required to return to the main menu after the report is printed.	15 sec.	3 sec.	3 sec.	6 sec.	8 sec.

**Table 3: Comparison of times required for the Dynabyte 8/1 8/4 microcomputer to perform the tasks listed in the left column. Don't place too much emphasis on speed. It is only one of the criteria involved in choosing a database management system for your needs.**

dBASE II programming language is flexible enough to accomplish almost any application. This may sometimes cause problems for the new user. Because so many options are available, learning the program commands can be difficult. For most applications this is preferable to sacrificing capability in favor of a less complicated program. Command files can be generated using the programming language. The current version of dBASE II includes a screen-display and report generator subprogram called ZIP. ZIP works well but has the annoying attribute of sounding the terminal alarm whenever a command is entered to tell the program to do something.

With the exception of the length of time required to pack the data file after deletion of records, this DBMS accomplishes all applications very well. Like Condor, it interfaces well with CP/M. Command files can be generated as well as custom menus.

All DBMSs should be able to use files generated by other programs; dBASE II transfer procedures for files with different formats are easier to use and more effective than any of the other DBMS programs. This transfer procedure is used so that data to be processed by dBASE II can be transferred to or from other programs running under CP/M such as Wordstar or CBASIC2. Its data-handling capabilities make dBASE II the most nearly satisfactory of the five DBMS programs for a real-time application.

The documentation is reasonably well done. If you are a new user I recommend you obtain Robert A. Byers's *Everyman's Data Base Primer Including dBASEII* (available for \$16.95 from Ashton-Tate, 10150 West Jefferson Blvd., Culver City, CA 90230). It lists several programs, including a mailing-label program. Simple step-by-step instructions on how to design and use the programs are included.

**FMS-80:** Like Condor and dBASEII, this DBMS is written in assembly code, but unlike the others, it has menu selections for the different functions. Command files can also be generated. The CP/M interface to run CP/M commands is limited when compared with Condor or dBASE II. A formatted report capability is available but it is complex to set up. Initial setup of the applications programs developed with FMS-80 should be done by someone with a programming background. Adding new records to a file is time consuming in comparison with the other DBMSs. The documentation should be expanded to better explain a number of program functions, including report generation.

**Selector V:** This DBMS and Analyst each come close to the classic definition of a network or hierarchical DBMS, as opposed to the other three, which may be loosely defined as relational. Data can be extracted from multiple files more easily with a hierarchal than with a relational DBMS. Accessing multiple files with a relational data-

# INTRODUCING 1-2-3.<sup>™</sup> IT'LL HAVE YOUR IBM/PC JUMPING THROUGH HOOPS.



Meet 1-2-3 — the remarkable new software package that puts more raw power at your finger tips than anything yet created for the IBM PC. 1-2-3 actually combines information management, spreadsheet, and graphing in one program that can perform all three functions interchangeably and instantly at the touch of a key. That's power.

To explain: since 1-2-3's information management, spreadsheet and graphing functions reside in memory simultaneously, you can go from retrieval to spreadsheet calculation to graphing instantly, just by pressing a few keys. So now you can experiment and recalculate and look at data in an endless variety of ways. As fast as your mind can think up new possibilities. There's no lag between you and the computer. And that's a new kind of power — power that's greater than the sum of its programs.

## The spreadsheet function.

If 1-2-3 were just a spreadsheet, you'd want it because it has the largest workspace on the market (2048 rows by 256 columns). To give you a quick idea of 1-2-3's spreadsheet capabilities: VisiCalc's spreadsheet for the IBM PC offers 15 arithmetic, logical and relational operators, 28 functions and 32 spreadsheet-related commands. 1-2-3 has 15 operators,

41 functions and 66 commands. And if you include data base and graphing commands, it actually has 110!

In addition, 1-2-3 is up to 50 times as fast as established spreadsheets. With all the features you've ever seen on spreadsheets. 1-2-3 also gives you the capability to develop customized applications (with 26 macro keys) and lets you perform repetitive tasks automatically with one keystroke. If 1-2-3 were just a spreadsheet, it would be a very powerful tool. But it's much, much more.

## The information management function.

Add to 1-2-3's spreadsheet a selective information management function, and the power curve rises at an awesome rate. Particularly since 1-2-3's information management capability reads files from other programs such as WordStar, VisiCalc and dBase II. So you can accumulate information on a limitless variety of topics and extract all or pieces of it for instant spreadsheet analysis. Unheard of before. Specific 1-2-3 information management features include sorting with primary and secondary keys. Retrieval using up to 32 criteria. 1-2-3 performs statistical functions such as mean, count, standard deviation and variance. It can produce histograms on part or all of the data base. 1-2-3 also

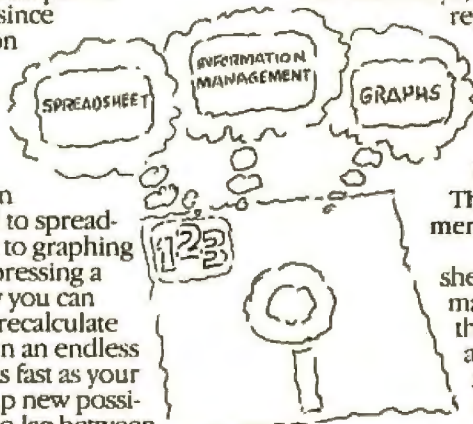
allows for the maintenance of multiple data bases and multiple criteria.

## The graphing function.

1-2-3 enables you to create graphs of up to six variables using information already on the spreadsheet. And have it on screen in less than two seconds! Once you've made a graph, three keystrokes will display it in a different form. If data on the spreadsheet changes, you can display a revised graph with one keystroke. This instant relationship of one format to another opens up a whole new application area. For the first time graphics can be used as a "what if" thinking tool!

For a full demonstration of 1-2-3's remarkable power, visit your nearby 1-2-3 dealer. For his name and address, call 1-800-343-5414 (in Mass. call 617-492-7171).

Lotus Development Corporation,  
55 Wheeler Street, Cambridge, MA 02138.



Spreadsheet, graphing, information management all in one



1-2-3 and Lotus are trademarks of Lotus Development Corporation. All rights reserved. WordStar is a registered trademark of MicroPro Inc. VisiCalc is a registered trademark of VisiCorp. dBase II is a registered trademark of Ashton-Tate.





# FROM THE CREATORS OF THE DATA DRIVE® COMES APPLETTTE 1® AND APPLETTTE 2® SLIMLINE DRIVES



**Available At CompuShack Stores**

**Applette 1® and Applette 2® are 100% Apple II compatible.** Halftracking, DOS, PASCAL, and CP/M®. 300% faster track to track speed with 15% greater storage capacity on a 40 track mode with enhancer diskette TEAC® mechanism and read/write electronics. Direct shaft drive, metal band positioner, photo coupler write-protected sensor. 10,000 lifetime hours, and more. **One year warranty on all parts and labor.**

Headquarters Telex: 18-3511

TAVA  CORP.

Answer Back CSMA

**(714) 730-6772**

\*DATA DRIVE, APPLETTTE 1, APPLETTTE 2, and TRUMP CARD are registered trademarks of TAVA Corporation, respectively.

\*TEAC is a registered trademark of TEAC Corp.

\*CP/M is a registered trademark of Digital Research, Inc.

Circle 371 on Inquiry card.



# \$1590



Full size smart terminal with detachable keyboard

4Mhz Z80A CPU  
64K RAM Main Memory  
200Kbyte 5 1/4" floppy disk  
(Osborn, Xerox, IBM, CP/M-86 formats)  
Two serial ports

Complete software package includes:  
WordStar word processing  
Correct-It spelling checker  
LogiCalc electronic spreadsheet  
Microsoft BASIC  
NorthStar compatible BAZIC  
CP/M 2.2 Operating System



# At \$1790, this computer was selling like hotcakes. So we dropped the price.

Crazy? No, not really. You see in order to meet the demand for the Micro Decision™ we increased our production. When we did that, our costs dropped. We're passing our savings on to you, because that's our philosophy.

More for less.

So now it only takes \$1590 to buy a Micro Decision with 64K of memory, a 200K double density floppy drive and a full-size Morrow smart terminal with detachable keyboard. Not bad. But there's more.

The Micro Decision also includes a package of business and professional software worth well over \$2000. The WordStar® word processor. A 36,000 word spelling checker. The LogiCalc™ electronic spreadsheet. And both Microsoft BASIC-80® and NorthStar-compatible BAZIC®. Plus, the CP/M® 2.2 Operating System that gives you access to thousands of other software programs. And, we take the mystery out of CP/M with plain English commands and single-key operation.

If you have your own terminal, you can buy the complete

computer and software package for \$995. That's the Micro Decision MD1™. The MD2™ includes another double-density disk drive, plus Personal PEARL™ the relational data base manager. Price? Only \$1395.

More memory? No problem. The Micro Decision MD3™ gives you two double-sided, double-density disk drives with 768K of storage and Personal PEARL for only \$2290. Without the terminal, \$1695.

Come in for a complete demonstration at your nearest Morrow Designs dealer. If you don't know who that is, call us toll-free at (800) 521-3493. In California, call (415) 430-1970. At \$1790, the Micro Decision sold like hotcakes. At \$1590, we've just sweetened the deal.

More computer, for less.

## MORROW DESIGNS

MORROW DESIGNS  
600 McCormick Street □ San Leandro, CA 94577  
(800) 521-3493 □ (415) 430-1970 In California



Circle 314 on Inquiry card.



Micro Decision, MD1, MD2, and MD3 are trademarks of Morrow Designs.  
WordStar is a registered trademark of MicroPro, Inc.  
LogiCalc is a trademark of Software Products International.  
BASIC-80 is a registered trademark of Microsoft Corporation.  
BAZIC is a registered trademark of Micro Mikes, Inc.  
Personal PEARL is a trademark of Relational Systems, Inc.  
CP/M is a registered trademark of Digital Research, Inc.



# Stalking the East-Asian Microcomputer

Phil Lemmons  
West Coast Editor  
McGraw-Hill Publications  
425 Battery St.  
San Francisco, CA 94111

Although the products of Asia's modern technologies do not yet rival its ancient treasures, they soon will. The five-nation Far East Electronics Tour in October and November 1982 delivered this message to one group of Americans through a series of six electronics trade shows: the Japan Data Show and the Japan Electronics Show (both covered in the first part of this article, "New Japanese Microcomputers," April *BYTE* 1983, page 110), the Korea Electronics Show, the Taiwan Electronics Show, the Hong Kong Consumer Electronics Show, and China Comm 1982, in Beijing. Firms in all these countries except China manufacture microcomputers of local design.

The first stop on the tour was Japan, where the trade shows exhibited the most significant new microcomputers and where a remarkable Tokyo neighborhood showcases the vigor of the domestic Japanese microcomputer market. The rest of the tour revealed interesting developments in the other countries as well. (For those who are thinking of joining the 1983 Far East Electronics Tour, the organizer is Commerce Tours International, 870 Market St., San Francisco, CA 94102, telephone (415) 433-3072.)



Photo 1: Yamagiwa Technica, a six-floor store in Akihabara, Tokyo, sells only microcomputers and associated products.

## Akihabara, Tokyo, Japan

If the object is electronics, then every tour of Asia should begin and end in Akihabara. This remarkable neighborhood in Tokyo is as interesting as the Japanese electronics shows. Akihabara (pronounced with the accent on the third syllable) covers an area of several square blocks. More than 400 electronic shops of varying size are packed into buildings about five to eight stories high. Escalators take you from the middle of one shop and drop you into the middle of another. There are

probably more shops selling microcomputers and related products in Akihabara than in any other neighborhood in the world, except perhaps in Osaka, the great industrial city that boasts a neighborhood called Nipponbashi said to rival Akihabara.

Many scenes in Akihabara strike the Western eye as improbable: a man riding a bicycle with an NEC PC-9801 16-bit computer strapped on the back fender; a shop with bins full of a remarkable hybrid device, a combination electronic calculator and mechanical abacus; integrated-circuit shops packed with customers of all ages and pocket-books standing side by side poring over the latest chips; a





Photo 2: A no-frills electronics store in Akihabara.



Photo 3: Typical Akihabara store display.



Photo 4: The Samsung SPC-1000 Z80A-based home computer from Korea.



Photo 5: The thronged exhibit booth of the Multitech Industrial Corporation at the Taiwan Electronics Show.



storefront full of oscilloscopes and logic analyzers arranged to grab the eyes of potential customers.

Some of Akihabara's larger stores sell all kinds of Japanese-made electronics—audio, video, music, home appliances. Each devotes an entire department to microcomputers; often a whole floor is packed with machines from most of the major Japanese manufacturers.

Some large stores—notably Yamagiwa Tecnica, shown in photo 1—sell microcomputers only. Yamagiwa Tecnica has six floors: one devoted to software, another to home computers, another to more powerful computers (mostly 16-bit), word processors, and so on. The one-floor NEC Bit-Inn has nothing but NEC machines ranging from the PC-2001 hand-held computer to the NS200 (known in the U.S. as the Advanced Personal Computer) and the PC-9801, both 16-bit computers. Expansion boards and accessories for these computers are in stock. Another store, shown in photo 2, offers no frills but good prices on boxed computer products, mostly from NEC. Customers walk where they can, mostly behind the rows of boxes. Typically, the interiors of the retail computer stores are packed with equipment on display. Photo 3 shows a section of a typical store interior.

Many small stores in Akihabara specialize in various kinds of components. One storefront devoted to semiconductors was selling 64K-bit dynamic RAM chips at 8 for 9000 yen, or about \$4.25 per chip. (The lowest price I've seen in this country is \$5.50 per chip, from a mail-order firm.) Customers had the choice of NEC, Mitsubishi, or Toshiba RAMs. The man behind the counter complained that 64K-bit RAMs were in short supply, which led me to believe that the prices were probably no lower than usual. Another small shop sold disk drives, power supplies, single-board computers, circuit cabinets, and the like.

Many of us foreign shoppers were concerned about the reliability of these low-priced goods. Were we being offered factory rejects? A Japanese businessman allayed our fears, saying there was no need to worry about getting defective goods in Akihabara. If a

Japanese electronics manufacturer discovered that defective goods bearing its name were being sold by any shop, the company would never again deal with that shop. In effect, the manufacturers police the retail trade.

The neighborhood was so much like a bazaar that I found the impulse to haggle irresistible. But I was worried: Would haggling be possible when I spoke no Japanese and the shopkeeper spoke almost no English? Would the concept of bargaining be clear? Would the shopkeeper find bargaining offensive? Could he recognize the English words for numbers? At last I ventured to ask, "Discount?"

The shopkeeper replied, "Target price?" and handed me a pad and pencil. The list price was 120,000 yen, then worth about \$450. I wrote,

---

### **A NEC memory board costs \$700 in the United States but sells for \$362 in Akihabara.**

---

"90,000." The shopkeeper laughed pleasantly and wrote, "100,000." We soon reached agreement on a price of 96,000 yen. A NEC memory board for the Advanced Personal Computer with a list price in the United States of \$700 then changed hands in Akihabara for only \$362.

The flourishing electronics industry that makes Akihabara possible has in part resulted from efforts of the Ministry of International Trade and Industry (MITI). Because MITI's Industrial Electronics Division funds research, some Americans have charged that Japan's electronics manufacturers enjoy an unfair advantage in competing with American manufacturers. Toshio Takai, who worked in MITI for 25 years before becoming executive vice-president of the Electronic Industries Association of Japan, denies the charge. He says, "MITI funds only basic research, and MITI's research money cannot be used for development of commercial products." Takai also points out that there is nothing to stop the government of the United States from funding research in electronics as MITI does in Japan.

## **Seoul, Korea**

Our introduction to the Korea Electronics Show was unlike what we encountered elsewhere on our journey. As my group arrived at the trade center, we saw dozens of black sedans that formed a semicircular barricade in front of the exhibition hall. Perhaps a hundred men in dark business suits, some holding handguns, arrayed themselves behind the barricade. All the Koreans who approached the exhibition hall were stopped by these guards, but Westerners could pass through. In addition to the guards, the only Koreans inside the barricade were old women stooping over crude short-handled brooms, sweeping every speck of dust from a wide path leading to the entrance of the hall. As we watched, several more black sedans arrived and passed through the barricade to park in the protected semicircle. More guards emerged from the newly arrived cars. All the guards now appeared poised for action, their eyes watchful. One guard opened the rear door of a car and out stepped a lone man in a dark business suit. All eyes followed that lone man as he walked down the clean-swept path and disappeared into the hall. "The President," someone said.

Inside, exhibits of consumer electronics and components and a few Korean microcomputers vied for our attention. Photo 4 shows the Samsung SPC-1000 home computer, a Z80A-based machine with a 32K-byte ROM containing Samsung-HuBASIC, 70K bytes of RAM, a music and sound generator, and an audio cassette built in for mass storage. Samsung also makes the Samsung Personal Computer, the SPC-2000. It is a 64K-byte CP/M-based system with dual 5¼-inch floppy disks, a detached keyboard with programmable keys, and a video monitor that tilts and swivels. Gold Star, Taihan, DMS, Trigem Computer, and a few other companies also displayed microcomputers.

The Trigem 20 is a 64K-byte Apple look-alike with a 12K-byte BASIC in ROM (read-only memory). The Trigem 20 has sound and color-graphics capabilities, game input/output, and eight empty expansion slots as standard equipment. Company spokes-

**LOW PRICES AND HIGH PROFITS. THE ACCOUNTING PARTNER™** is an easy-to-use, professional software package designed for companies with sales up to \$5 million. All for less than \$400.00. And it was created by people who design the most sophisticated systems around.

Why not help your customer perform efficiently and save money, while helping yourself to a decent profit? Our ambitious consumer advertising program will help. Plus newly available toll-free (800) number support. So please call us now!



**STAR SOFTWARE SYSTEMS**

20600 Gramercy Place, Suite 103  
Torrance, CA 90501 / (213) 538-2511

Circle 526 on Inquiry card.

**THE ACCOUNTING PARTNER™**





# The Japanese Microcomputer Marketplace

Kurt Veggeberg  
5702 Ave. C  
Austin, TX 78752

Over the past four years Japanese microcomputer manufacturers have seen their share of Japan's domestic market increase from 10 to 75 percent. Clearly, advances in technology and marketing techniques make this the market to watch throughout the decade.

Almost every Japanese electronics company, large and small, is in the personal computer business. Fierce competition is seen in all price ranges as each firm attempts to carve its own market niche. A great boon to consumers, the lively market is producing microcomputers that come fully equipped with features hardly imaginable just a few years ago when Apple and Radio Shack dominated the Japanese market. By following the competition's footsteps, the Japanese are able to offer compatibility with existing hardware and software plus improvements in reliability, service, features, and price. As an added advantage, many companies supply themselves with semiconductor chips and have their own well-established distribution networks.

Today's typical Japanese microcomputer usually has a Z80 microprocessor and offers a variety of standard features such as separate numeric keyboards, programmable function keys, selectable 40- or 80-character displays

and Japanese or graphics character sets. Each company tries to include a feature in its machine that sets it apart from the competition. For example, some of the newer VLSI chips like the 64K-bit RAMs are appearing in many computers. Additional features seen recently include bubble memory, plug-in ROM packs, built-in terminal functions, and Japanese character sets with 3000-7000 characters. The 16-bit microprocessors are generating a lot of excitement as well. The 8088 appears to be winning the 16-bit popularity contest. One of the earlier 8-bit systems already offers an 8088 plug-in card.

Traditional excellence in miniaturization is evident in the current crop of Japanese pocket and portable computers. Even though the Japanese have little outside competition, the domestic market is characterized by fierce scrambling.

A move toward office automation is keeping the domestic microcomputer market booming. Despite the initial high cost of dedicated word-processing systems (around \$12,000), they quickly became essential office equipment. These word processors use one of several methods to enter and manipulate the Japanese language, which consists of two syllabaries, or kana, and thousands of individual characters. One entry method uses a board with several thousand characters printed on it. A stylus helps the user select the characters to enter. A more popular method uses a keyboard with the syllabaries. Using about 50 characters only, this method is easily im-

plemented on a qwerty-style keyboard. The user simply types the symbols for the sound of a character and then presses a button. The machine decodes the input and produces a character. Most systems can even determine the character you want from the context in which it's being used. This capability is essential with a language in which many characters have the same sound. These word-processing systems are usually sold complete with dot-matrix printers (24 by 24 dots) that produce good-quality printouts. Hardware and software advances have brought the prices for these systems down to around \$3000 and the low cost is a factor in the growing strength of the domestic market.

## The Software Scene

While Japanese hardware distinguishes itself with special advanced features, several problems plague the software development effort.

With the two syllabaries and thousands of characters, the Japanese language is much more difficult than English to manipulate electronically. Few of the current microcomputers can easily be used for word processing, although some progress is evident. Another factor in the software industry's slow growth is that use of disk drives is not as widespread as it is in the U.S. This places a severe limitation on the type of software that can be marketed to a wide audience. Additionally, the use of computers in business applications lags far behind that in the United States. Electronic spreadsheets such as Visicalc are having an effect on the use of microcomputers in Japan, but this is a recent development.

Availability of software is another important issue. The number of domestic private software houses remains small and premium prices are charged for imported software—usually a 100 percent markup over the U.S. list price. However, the situation could

men say that the Trigem 20 differs from the Apple II in the video color signals, ROM software, and power supply. According to Trigem, the government of Korea is distributing 5000 microcomputers to the country's high schools, 1000 of which will be Trigem 20s. The export price of the Trigem 20 is \$350 in quantities of

3000, with a 9-inch green-phosphor video monitor selling for \$68 in the same quantities.

The Korean electronics industry developed rapidly, and by 1981 consisted of almost 800 companies employing 270,000 people. Two-thirds of the \$3.8 billion annual production is components, with another one-fifth

devoted to consumer electronics. The Korea Institute of Electronics Technology and the Korea Electro-technology and Telecommunications Research Institute have concentrated on digesting and improving imported technologies. The Electronic Industries Association of Korea expects these research institutes to generate advanced technol-

change soon because most Japanese microcomputer manufacturers are concentrating their efforts on standard operating systems. This should encourage the development of software in Japan and also encourage the importation of American software with a corresponding increase in the exportation of Japanese hardware.

Both production and distribution of software are rapidly becoming part of the book publishing domain. Simple cassette programs appear alongside magazines and other printed materials in bookstores across Japan. Most of the stores provide microcomputers so potential software buyers can try programs before purchasing. As you might expect, this attracts a lot of attention and so far I have been unable to push past the children to try any programs myself.

### Intense Interest

The Japanese express a great deal of interest in microcomputers and appear to be welcoming them into their lives. A current television series on microcomputer programming is aimed at beginners and more conventional instruction is offered in a variety of places from computer stores to private schools. These courses target every possible group of future computer users. Japanese computer magazines reflect the growing demand for computer information with their multiplying numbers and rapid increases in size.

Although the Japanese have not yet made a strong showing in American markets, they're fully aware of the potential for profit in the U.S. Japanese domestic products are well designed and competitively priced and their success with low-cost printers and video displays indicates their ability to play a strong role in the American personal computer market. While this competition may bring difficulties for manufacturers, the benefits for end users should be plentiful. ■

ogies for integrated circuits, computers, and telecommunications. One goal mentioned at the electronics show is to produce 64K-bit dynamic RAM chips in 1984 using home-grown technology.

### Taipei, Taiwan

The Taiwan Electronics Show, held

at the China External Trade Development Council Exhibition Complex in Taipei, had 511 exhibitors. While most products displayed were consumer electronics or components, I saw a lot of computer products too.

The most common microcomputers made in Taiwan are blatant copies of the Apple II. Also shown were an apparent copy of the Radio Shack TRS-80 Color Computer and two copies of the Osborne 1. An Osborne 1 copy called the Datatree Portable Business Computer had a 9-inch screen, two double-density floppy-disk drives, and all the software usually bundled with the Osborne 1; this machine cost \$800. The second Osborne-like portable, made by GRE Rong Electronics, includes a 6502 processor, as well as a Z80, and claims compatibility with both the Apple II and the Osborne 1.

I didn't get to see, as promised, a third Osborne look-alike. Its designer refused to bring his prototype to the Taiwan Electronics Show and insisted on a private meeting with me miles away at the office of one of his friends. When the designer arrived, more than an hour late, his appearance presented quite a contrast to the usual conservatively dressed Taiwan businessman. Half-inch-long white stitches left me no doubt about how his purple suit was put together. His purple and orange floral print shirt and inch-wide white polkadots in his purple tie set up a high-frequency oscillation with the seams of the suit.

Under the circumstances, there was real danger of my overlooking the business of the meeting. But, I asked, "Where's your Osborne look-alike?"

His eyes shifted from place to place as if looking for assassins. "If anyone saw it," he said earnestly, "they might copy my design."

If it happened to Adam Osborne, it could happen to him.

Some businessmen on the island explain the epidemic of Apple II copies as a response to the Nationalist Chinese government's ban of video games. Many companies in Taiwan had bought great quantities of discrete logic circuits and 6502 microprocessors in preparation for an expected boom in the game-machine market.

The government's ban left these companies with huge inventories of chips useful for building Apples. That might explain the Apple copies, but what about the bastard Osbornes?

Because U.S. Customs officials are watching for products from Taiwan that infringe upon American patents and copyrights, Americans would be ill-advised to rush off to Taipei to pick up a \$245 Apple or an \$800 Osborne clone. Furthermore, some local insiders told me during the show that many electronics firms in Taiwan are pushing the government there to ban the export of these illicit products. Many in Taiwan believe that copyright and patent infringements in electronics damage the reputation of the entire electronics industry in the Republic of China and injure the island nation's trade. Despite great economic advantages, some foreign companies are reluctant to manufacture in Taiwan for fear that designs will be copied by local entrepreneurs and sold on the open market at unbeatable prices.

Some respectable Taiwan firms that make legal Apple-compatible products are tired of having to defend themselves against charges inspired by illicit Apple-clones made by other firms. For instance, Stan Shih's Multitech Industrial Corporation produces the successful and lawful 6502-based Micro-Professor II, and Shih is incensed when people call that compact machine a copy of the Apple. The Micro-Professor II packs 64K bytes of RAM and a 16K-byte ROM BASIC into a unit slightly larger than an average modem. The computer will execute most Apple II software because its own software uses system calls compatible with those in the Apple's operating system. Priced in Taiwan at around \$200, the Micro-Professor II is not an imitation of an Apple but an improvement on it. The Micro-Professor II accepts software cartridges as well as audio-cassette-based software (the audio recorder and a disk-drive controller are optional). According to Shih, the Multitech BASIC interpreter has 90 instructions more than Applesoft BASIC.

Micro-Professor II has enjoyed great success in Taiwan (see the thronged



# HOW TO CUT YOUR COMPANY'S LONG DISTANCE PHONE BILL 50% OR MORE.

**RCA** American Communications

# Free.

WATS, MCI, SPC, AT&T, RCA, USTC, ITT, WU, SBS...our brochure unscrambles the alphabet soup facing every cost-conscious company seeking the best mix of long distance communications services.

In many cases, an RCA private line satellite channel is the solution to expensive long distance phone bills. But even if an analysis shows we can't help you, our brochure will.

To get it, write Walt Ploji, 400 College Road East, Princeton, NJ 08540. Or call (609) 734-4300.

**RCA** American Communications

Multitech show booth in photo 5) not only because of its compactness and low price, but also because of its optional Chinese character controller (CCC). The Z80-based CCC adds another 64K bytes of ROM and 2K bytes of RAM to the little Micro-Professor II, and gives the user access to 22,000 Chinese characters, each displayed in a 16 by 16 matrix. With the CCC installed, the Micro-Professor permits the user to enter BASIC programs in either Chinese or English. Multitech recently remedied the only obvious deficiency of Micro-Professor II—its small keyboard—by offering a full-size typewriter keyboard as an inexpensive option. The optional keyboard has cursor keys and two "fire" keys, the latter for games. At least one member of the Far East Electronics Tour left Taiwan with a Micro-Professor II in his luggage.

Multitech now has more than 250 employees and annual revenues of \$20 million. The company's future products will include a portable computer.

Tony Jwang of J. E. Computer Company says that the only way for Taiwan's microcomputer companies to survive is to stop copying foreign machines and design their own. However, J. E. Computer now produces computers compatible with the Radio Shack TRS-80 Color Computer and the Apple II.

Taiwan's answer to Japan's MITI is ERSO, the Electronics Research and Service Organization of the Taiwan Industrial Technological Research Institute. Since 1974, ERSO has been transferring electronics technologies to local industry. ERSO develops electronic products more advanced than those of local industry and then assigns the manufacturing rights to a private Taiwan company. Recent ERSO products include the EMB86/01, an 8086-based single-board computer for the Multibus. ERSO also developed the BC-1000, a multiuser Z80A-based computer running the MP/M multiuser operating system, and turned manufacturing and marketing over to PECOR (President Enterprises Corporation), a private company in Taipei. ERSO's highest priorities now include development by 1984 of VLSI (very large-scale integra-

**DISKETTE  
DUPLICATION  
SERVICES**

## SOFTWARE PRODUCERS CUT YOUR COSTS!

If you are a microcomputer software producer, check the following to see how your requirements and Hoffman's services match up. Using one source for these activities can save you valuable time and money.

- |                                      |  |
|--------------------------------------|--|
| <input type="checkbox"/> DUPLICATION | <input type="checkbox"/> SPECIAL PACKAGING         |
| <input type="checkbox"/> DISKETTES   | <input type="checkbox"/> EDITORIAL/PRINTING        |
| <input type="checkbox"/> LABELS      | <input type="checkbox"/> COMPONENT ASSEMBLY        |
| <input type="checkbox"/> SLEEVES     | <input type="checkbox"/> WAREHOUSING/DROP SHIPPING |

We know you will be pleased with our high quality and low prices. Quantities from 10 to 10 million.

Please call, write or return this ad for more information.



**Hoffman** COMPUTER PRODUCTS

1720 FLOWER AVENUE, DEPT BY10 • DUARTE, CALIFORNIA 91010  
(213) 303 1571

Name \_\_\_\_\_ Title \_\_\_\_\_  
 Company \_\_\_\_\_  
 Address \_\_\_\_\_  
 City \_\_\_\_\_ State \_\_\_\_\_ Zip \_\_\_\_\_  
 Telephone ( ) \_\_\_\_\_

tion) technology capable of producing 64K-bit RAMs and development of microcomputers and minicomputers. One of ERSO's goals is to foster the computerization of Taiwan.

### Hong Kong

The Hong Kong Consumer Electronics Show revealed several microcomputers made locally. Video Technology makes two home computers. The Creativision uses a 6502A microprocessor running at 2 MHz and has 16K bytes of user RAM and a 12K-byte BASIC in ROM. The system serves as a game machine as well as a computer. The compact VZ100 Personal Computer has a Z80A running at 3.58 MHz, up to 35K bytes of RAM, 8K bytes of ROM containing system software and a BASIC interpreter, and a 45-key rubber keyboard.

Eaca International Ltd. has been making microcomputers in Hong Kong since 1979. The product line includes four different Z80-based microcomputers, the Genies I through IV. The Genie III is an all-in-one desktop computer that has a 4-MHz Z80A, 64K bytes of RAM, two 5¼-inch floppy-disk drives, and runs CP/M version 2.2. Two exhibitors in the Hong Kong Consumer Electronics Show said that the Crown Colony has set a goal of becoming a net exporter of computers by 1985.

### Beijing, China

For the 20 members of the American Electronics Association trade mission to Beijing, the Chinese capital held several surprises. The first was the Chinese-language NEC PC-8001B used behind the desk at the Yanjing Hotel. The second was the amount of attention devoted to the trade mission by officials of the Fourth Ministry of Machine Building of the People's Republic of China, also known as the Ministry of the Electronics Industry. Three representatives, Huang Zhao Ming (seen in the dark gray coat at center in photo 6), president of the China Electronics Import and Export Corporation (CEIEC), and Li De Guang and Sun Shunxing, respectively vice-president of the corporation and director of the corporation's Department of Trade Relations, met with

members of the trade mission for several hours.

While some discussions centered on the particular trading interests of the members of the trade mission, the Chinese emphasized their desire for the relaxation of export restrictions on American technology. At dinner one

Handley briefed the trade mission on the current state of electronics in China: "The Chinese electronics industry is still working in the late 1960s or early 1970s. They have a few research institutes that can produce a few advanced semiconductors. They make a few microprocessors."



Photo 6: The American Electronics Association trade mission met with representatives of the People's Republic of China Electronics Import and Export Corporation (CEIEC), including its president, Huang Zhao Ming (in dark gray coat at center).

night at Beijing's International Club, the tour members joined the Chinese officials in repeated moutai toasts to the easing of restrictions on LSI and VLSI technology. (Moutai looks like vodka and tastes like death.) To date, the United States government has turned down export licenses for all integrated-circuit technology more complex than that of 2K-bit RAMs.

According to Peter Handley, a commercial officer in the United States Embassy in Beijing, CEIEC has in recent years imported about \$160 million in electronic equipment annually, including computers from Hewlett-Packard, DEC, IBM, Apple, Intel, and Cromemco. Photo 7 shows the crowded Osborne Computer booth at China Comm 1982, an exhibition of Western communications and computer equipment. The Stalin-Gothic-architecture Beijing Exhibition Center was packed with Chinese visitors; the only free space was inside the booths, as shown in Hewlett-Packard's large and popular booth (see photo 8). Other exhibitors included California Computer Products, Burroughs, Cromemco, Honeywell, IBM, Perkin-Elmer, Prime, and Wang.

CEIEC prefers importing entire production lines rather than products. France recently sold China a complete plant for making minicomputers, magnetic disks, and printers. Four Japanese firms have sold China complete production lines for electronic components. West Germany and the United Kingdom have made similar deals. In the past two years, the United States has sold China only one electronics factory, valued at \$8 million.

Handley says that China's main goals for electronics imports are field-effect transistors, acoustic wave filters, integrated circuits and LSI manufacturing equipment, magnetic recording heads, and satellite earth stations. China wants to buy 15 satellites and the technology required for manufacturing its own.

The CEIEC arranged a tour for our group of the Beijing Wire Communications Factory, which makes telephone exchanges and 32-bit and 48-bit minicomputers. Photo 9 shows the front panel of one of these minicomputers. The 32-bit machine comes with 64K bytes of RAM; the 48-bit machine has 32K bytes of RAM expandable to 128K bytes and runs FOR-





Photo 7: Osborne Computer Corporation's booth at China Comm 1982 was crowded with computer enthusiasts.



Photo 8: It was standing room only at China Comm 1982. The only free space was inside the booths, such as Hewlett-Packard's, shown here.

TRAN, ALGOL, and BASIC. The factory has been working in cooperation with Honeywell for about a year and several of its staff members are currently living in Minnesota for training.

Many members of the tour were surprised by the level of poverty in the Chinese capital. Since no one has refrigeration, in late fall the Chinese pile bok choy (Chinese cabbage) high in vacant lots and on roofs and balconies in the hope that nature will preserve it as the only green vegetable for the winter months. Everywhere men and women are engaged in brute, physical labor, and the sight of a woman pulling a cart full of rocks or bricks is all too common.

China is seeking to quadruple its annual industrial and agricultural output by the year 2000. During the trade mission's visit, the English-language *Beijing Review* quoted Premier Zhao Ziyang as saying that meeting the country's production goals depends on progress in science and technology. To quote that publication:

*Addressing a national science and technology awards conference held in late October, Premier Zhao specified a guiding principle for China's economic construction: develop science and technology in order to boost the national economy. He said that every department engaged in national economy must stress achieving technical progress so as to gradually shift production to a new technological basis.*



Photo 9: Front panel of a 32-bit minicomputer made at the Beijing Wire Communications Factory.

Zhao went on to say that building new factories would not be enough; old factories must be technically transformed as well. In the same issue of the *Beijing Review* (November 1, 1982, volume 25, number 44), Hi Qiamou, honorary president of the Chinese Academy of Social Sciences, was reported to have endorsed the maxim "Let a hundred flowers blossom and a hundred schools of thought contend" in scientific and cultural work.

During the trade mission's days in Beijing, the Chinese made no effort to hide the backwardness of their indus-

try; instead, they appealed for help. Most members of the trade mission felt sympathy and expressed hope for wider trade, but a few raised concerns about possible military uses of microprocessor technology if the Chinese leaders once again come to regard the United States as an arch-enemy.

The impression of centralized power is so forceful in Beijing that I believe no action by the Chinese government can be ruled out. The Chinese tour guide denounced the emperors for denying the common people even the right to use colors other than gray and dark blue, reserving brighter colors for the nobility and yellow for the emperor alone. But almost all the people of Beijing still wear gray or dark blue. When the guide pointed out the building from which the premier now governs the People's Republic, Americans noticed that the roof is the same yellow as the tiles on the roof of the Imperial Palace. Americans can hardly predict the ultimate uses of microprocessors in a land that still thinks in such terms. ■

*For background information on the Japanese microcomputer industry see "The Japanese Computer Invasion" by Stan Miaszkowski, August 1981 BYTE, page 200. The May 1982 issue of BYTE also contains several articles on Japanese microcomputers, the state of the industry, and the manufacturers themselves.*



# Taxan monitors when precision counts

Dedicated to quality and precision, TAXAN offers a complete line of monitors including green and amber, ultra-high resolution monochrome, plus medium and high resolution RGB monitors.



⊗ TAXAN also offers the 410-80, 80 column and RGB card to interface with the Apple IIe.

⊗ TAXAN monitors stand alone.

See your local ⊗ TAXAN dealer, or call us for details!

⊗ **TAXAN**

TSK Electronics Corporation  
18005 Cortney Court  
City of Industry, CA 91748  
(213) 810-1291

Circle 485 on Inquiry card.



# An Inexpensive Letter-Quality Printer

Stuart Brown  
Bell Labs  
600 Mountain Ave. 3D-420  
Murray Hill, NJ 07974

The desire to have letter-quality printing for the output of programs such as word processors is common among computer hobbyists. Purchasing a letter-quality printer, such as a Diablo terminal, is usually out of the question because of the high cost—\$1500 to \$3000. One option is to buy a used IBM Selectric typewriter and install a commercially available computer interface. This process does have drawbacks, however. It ends up costing more than \$1000 and can require major modifications to the typewriter.

Another option is the solenoid-activated key-pusher, a unit that fits over a standard typewriter keyboard and emulates a human typist. This method has two major drawbacks. First, because the key-pusher is mechanical, it tends to decay with time; second, the quality of the text is limited to the quality of the typewriter itself.

These two forms of typewriter conversion share the same goal: translating a computer's digital-control signals into the mechanical actions necessary for printing. With the recent introduction of the low-cost Olivetti electronic typewriter (see photo 1), the manufacturer has tackled this problem for you. The question now becomes: How can the hobbyist interface a home computer to



Photo 1: The Olivetti Praxis 30 electronic typewriter. The two cables in the rear connect to a parallel port on a microcomputer.

the electronics? This article describes a low-cost interface between a typical hobbyist computer or small business computer and the Olivetti Praxis 30 electronic typewriter.

## The Typewriter

The Olivetti Praxis 30 is a portable electronic typewriter with high-quality print. Its retail price is about \$250. Like the popular Diablo terminal, it uses a carbon ribbon cartridge (\$4 each) for crisp type and has interchangeable print wheels (\$30 each) for variations in style. The Praxis typewriter is controlled internally by two mask-programmed Fairchild F8 microprocessors. All functions—such as tab stops, margins, carriage movements, printing, and keyboard scanning—are controlled by these two chips, with some help from SSI (small-scale integration) interface chips. This electronic control

makes the Praxis typewriter ideal for interfacing to a computer.

## Interfacing the Praxis Typewriter

It is possible to interface the Praxis typewriter to a typical home computer in two obvious ways. The first method requires that the F8 microprocessors be removed and their functions emulated by your computer. These functions include control of the carriage stepper motor, print-wheel motor, type motor, and other motors and sensors. This approach offers the most versatility in determining interletter spacing and print speed. (The interletter resolution determines the output quality of most word processors.) I tried this way first and failed miserably. While controlling the carriage stepper motor is relatively easy, controlling the print wheel is not because the print-wheel motor is a standard DC motor, not a stepper.

After many hours of observation using a logic analyzer, I determined that the Praxis typewriter microprocessors position a character for typing by carefully pulsing the print-wheel motor in one direction, causing the character to pass beyond the print hammer, and then reversing the motor with timed pulses until the character is properly aligned under the hammer. This timing varies with the character positions on the print wheel, and I was unable to determine the algorithm. Because Olivetti considers this timing information proprietary, calling its engineering department led to a dead end.

I chose the second and easier interface option: working with the micro-

## About the Author

Stuart Brown received a B.S. degree in electrical engineering technology from Purdue with a minor in computer science. He has worked for five years at Bell Labs in the Interactive Digital Systems Research department. He is currently attending Rutgers for an M.S. in electrical engineering.

# 1 SUPER WAREHOUSE

PHONE ORDERS FREE  
(ONE DOLLAR CREDIT FOR PHONE ORDERS)

203-265-1223

## PRINTERS

ANADIX	MFG. LIST
9000/1A	<del>\$1625.</del>
9500/1A	<del>1725.</del>
9620A	<del>1845.</del>
9625A, Dual	<del>1995.</del>
WP6000, Dual	<del>3250.</del>
DATASOUTH	
DS180	<del>\$1695.</del>
DS220, Dual	<del>1995.</del>
DIABLO	
630, Letter	<del>\$2995.</del>
WP Option	<del>300.</del>
FACIT/DATA ROYAL	
4510	<del>\$ 695.</del>
4560, Letter	<del>1295.</del>
4565, Letter	<del>1895.</del>
4570, Dual	<del>3295.</del>
5000c	<del>1595.</del>
MANNESMANN TALLY	
1601	<del>\$ 930.</del>
160L, Dual	<del>1075.</del>
1801	<del>1190.</del>
180L, Dual	<del>1335.</del>
1602	<del>1695.</del>
1605	<del>1695.</del>
1612KSR	<del>2295.</del>
1612RO	<del>1945.</del>
1802, Dual	<del>1995.</del>
1805, Dual	<del>1995.</del>
QANTEX	
7020, Dual	<del>\$1695.</del>
7030, Dual	<del>1995.</del>
7040, Dual	<del>2195.</del>
SMITH CORONA	
TPI, Letter	<del>\$ 850.</del>

## VIDEO TERMINALS

LEAR SIEGLER	
ADM3A	<del>\$ 595.</del>
ADM5	<del>645.</del>
ADM21	<del>695.</del>
ADM22	<del>695.</del>
ADM24	<del>1195.</del>
ADM31	<del>1095.</del>
ADM32	<del>1295.</del>
ADM38 (DEC)	<del>1195.</del>
ADM42	<del>2195.</del>
VECTOR GRAPHICS	<del>1050.</del>
MODEMS	<del>925.</del>
PRINTERS 310	<del>2045.</del>
PRINTERS 500	<del>1695.</del>
ANN ARBOR	
GENIE	<del>1195.</del>
GENIE+PLUS	<del>1895.</del>
AMBASSADOR	<del>1595.</del>
META MODE	<del>50.</del>
DEC MODE	<del>100.</del>



**IF YOU REALLY WANT IT  
— CALL US —  
BEST AND LOWEST PRICES**

## APPLE II+ COMPATIBLE COMPUTERS

INCLUDES - FAN, 64K, UPPER/LOWER CASE, + + +

**Special \$995**

- DATA SWITCH BOXES • BUFFER BOXES
- INTERFACE CARDS • GRAPHIC BOARDS
- SHEET FEEDERS • PRINT SPOOLING
- DS120 CONTROLLER CARDS
- ANDERSON JACOBSON MODEMS
- FLOPPY & WINCHESTER DRIVES

In addition, we can make EIA RS 232 cables to your order, and supply you with ribbons, printer stands, print wheels, thimbles for all printers listed. And many, many more items. CALL NOW.

All items shipped freight collect either motor freight or UPS unless otherwise specified. All prices already include 5% cash discount. Purchase with credit card does not include discount. Connecticut residents, add 7½% Sales Tax. For fastest delivery send certified check, money order or bank-wire transfer. Sorry, no C.O.D. orders. All equipment is in factory cartons with manufacturers' warranty. Prices subject to change without notice. Most items in stock or shipped as received.

1 **NATIONWIDE SERVICE, MOST PRODUCTS**  
**SUPER WAREHOUSE**

P.O. BOX 373 WALLINGFORD, CONNECTICUT 06492

ORDER LINE

203-265-1223

ORDER HOURS

9:00 AM - 5:00 PM-EST

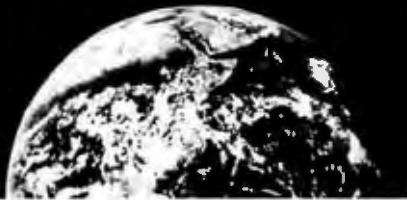
MONDAY-FRIDAY

Circle 1 on Inquiry card.

**PRICES SO LOW—WE CAN'T LIST THEM!**



# MEASURE, MONITOR & CONTROL



Use your computer to interact with the world around you!

**NOW AVAILABLE** — An affordable analog to digital conversion board PLUS both direct wire and AC line carrier remote device control.

Attaches to the RS-232C serial interface of your computer and/or modem!

Now you can measure the temperature, energy consumption, light levels, humidity, etc. of your home or office. With the same device you can monitor the status of window, door, fire, and smoke sensors for security protection. Control your lights, siren, stereo, or heating system in response to sensed inputs.

#### ADC-1 features include:

- 16 Analog to Digital Inputs (12 bits plus sign — Resolution 1 part in 8096).
- 4 Digital (on/off) Inputs
- 6 TTL Switched Outputs - Connects directly to solid state AC relay or other TTL circuits
- Controls 32 Possible Devices via BSR, Levitron, Radio Shack AC line carrier appliance and lamp remote control modules.
- Analog to Digital conversion at 7 Hz. Display 20 sensor array in 2.5 seconds.
- 6 User selectable baud rates from 300 to 9600
- **AFFORDABLE** — both measurement and control functions for **ONLY \$329.**
- Includes protective enclosure with easy-to-use terminals for sensor attachment.
- Sensors available from Remote Measurement Systems include: light, temperature, wind, moisture, electrical energy consumption, security system switches.

Automate and protect your home. Monitor energy consumption and heat loss. Construct your own weather station. Control scientific experiments and log data. Uses limited only by your imagination!



### REMOTE MEASUREMENT SYSTEMS, INC.

P.O. Box 15544 • Seattle, Washington 98115  
Tel 206-525-3369

Send for complete specifications  
Telephone, Visa and Mastercard  
orders welcome.

		10	11	12	13	14	15	16	17
		B33	B32	B31	B30	B29	B28	B27	B26
O0	A8		1	2	3	4	6	5	Tab
O1	A9	Reloc			l	k	j	h	Marg Bypass
O2	A10	Corr	?		,	m	n	b	Half Space
O3	A11		q	w	e	r	t	7	Marg Left
O4	A12		a	s	d	f	y		Marg Right
O5	A13	Shift Lock	1/2	p	o	i	u	Back-space	Tab Set
O6	A14	Repeat	=	-	0	9	8	Return	Expr
O7	A15		z	x	c	y	g	Space	Tab Clear

Table 1: The columns of this scan matrix are the bits (and corresponding pins) that are individually pulled low by Processor B for keyboard scanning. The rows are the bits (and pins) that are sensed by Processor A. Blanks in the matrix are either unassigned or unidentified scan positions.

processors rather than without them. This involves emulating the keyboard action, that is, making the microprocessors think that someone is typing.

I first observed how the keyboard is scanned. One of the typewriter's two F8 microprocessors, which I call Processor B, is responsible for asserting, by pulling low, one of eight scan lines that form the columns of a key matrix. The other F8 (Processor A) senses which line connected to the key rows goes low when a key is closed. This key is then identified by the F8 software through its position in the matrix. Using an ohmmeter, I traced the keys to identify their positions in the 8 by 8 scan matrix (see table 1). The *shift* function is not part of the scan matrix; it is a special input to Processor A.

To print a character (or perform a nonprinting function such as a margin set) with the cooperation of the typewriter's microprocessors, you sense the row scan lines until the appropriate one-of-eight code is transmitted by Processor B. You then emulate a key closure by pulling low the Processor A line corresponding to the desired key's matrix row position. For example, to type the letter "s," wait for pin 31 of Processor B (bit 2) to go low. For as long as it is low, bring pin 12 of Processor A (bit 4) low. As mentioned, the shift function has a dedicated input line of its own. To shift to uppercase, pin 17 on Pro-

cessor A is held low during the sense/assert operation for the character to be shifted.

The keyboard is software debounced by the Praxis typewriter's microprocessors, which means that a key must remain closed during four scans to be recognized as a valid entry. In the controlling program, the action of sensing and pulling low is repeated four times.

The advantage of this sense/assert interface is that the typewriter keyboard can still be used for normal typing without disconnecting anything. The resolution of your word-processing program is limited by the resolution of the typewriter (one-half space). The only required modification to the typewriter is to solder 19 wires to the pins of the two microprocessors.

### Hardware Configuration

To interface the Praxis typewriter to your computer, you need nine output, or assert, lines (eight as part of the scan and one for the shift function); eight input, or sense, lines; and a couple of grounds. These usually come from a parallel-port board or chip. A good choice is the Intel 8255 parallel-interface chip, which has 24 I/O (input/output) lines. Ideally, your port's output lines should go through an open collector buffer to allow the keyboard to bring Processor A's inputs low when a key is

# TAVA CORP. INTRODUCES THE TRUMP CARD<sup>®</sup>, IBM<sup>®</sup> COMPATIBLE, FULLY POPULATED 256K RAM + SERIAL I/O + GAME I/O. \$499



## 256K RAM

A 64K to 256K parity checking RAM is fully socketed for easy memory expansion. The memory address is switch selectable, using up only the required memory space

## GAME I/O

Interface consisting of two joy-sticks and four switch inputs are IBM BASIC compatible. A standard GAME I/O DB 15 connector provides connection to the rear plate of the IBM computer

## GOLD IBM INTERFACE

Gold connectors as well as glass epoxy PCB will provide years of reliable service, with all hardware interface meeting the IBM specification

## ASYNCHRONOUS COMMUNICATION

A RS232 and 20Ma (TTY) interface supports software programmable baud rates, parity, stop bits, and character. Modem and serial printer are fully supported by the IBM communication software. A standard DB25 connector allows for the easy connection to serial devices



**Available At  
CompuShack Stores  
OUTSTANDING  
QUALITY  
AT AFFORDABLE  
PRICES!**



For Further Information Contact:

**Tava Corp.**

1711 Corinthian Way Suite 1011  
Newport Beach, CA 92660

**(714) 261-0200**

Headquarters Telex: 18-3511  
Answer Back CSMA

THE TRUMP CARD is a registered trademark of TAVA Corporation.  
\*IBM is a registered trademark of IBM Corporation.



pressed. However, the 8255's totem-pole outputs don't seem to mind the brief short circuit to ground. I built a minimum-configuration, 4-MHz Z80 system whose sole purpose is to run the typewriter. It sits in-line between the host computer or modem and my terminal. You will probably want to use your microcomputer to do the job and save money.

The first step in connecting your port to the Praxis typewriter's processors is to disassemble the typewriter and remove the computer control board. The step-by-step procedure is as follows:

1. Turn off and unplug the typewriter. With it facing you, lift the hinged cover that protects the print mechanism. It hinges on a rod that runs horizontally through the platen. Gently pull the right end of the cover until the plastic hinge clears the rod. Then slide the left side of the cover off the rod.
2. Twist off the plastic platen handgrips by rotating each one counter-

clockwise. Also, it is a good idea to remove the ribbon cartridge.

3. Turn the typewriter over and remove the four screws that hold the plastic base on—two at the front edge and two at the rear.
4. Right the typewriter and lift off the plastic case. The keyboard remains mounted to the base.
5. Remove the two screws that hold the keyboard assembly to the base and lift the keyboard up slightly. Five cables must be unplugged from sockets on the rear of the keyboard assembly. Remember their orientation. Photo 2 shows the keyboard assembly with the Praxis typewriter cables removed. The two cables at the bottom are from the parallel port.
6. The keyboard can now be removed from the base. Turning it upside down, you discover that the circuit card is held to the keyboard card by three nuts. Remove these nuts and save the two grounding flanges (remembering the orientation of the flanges).

7. The processor card can now be separated from the keyboard card with the flexible ribbon cable acting as a hinge. Orient the boards as shown in photo 3. Note the locations of Processors A and B and the new cable wiring.

I suggest using a ribbon cable to attach your parallel port to the circuit card. Figure 1 is an interconnection diagram between an Intel 8255 port chip and the Praxis typewriter microprocessors. Solder the cable wires to the pins of Processors A and B on the foil side of the printed-circuit card. Use the same caution you would to solder a microprocessor into a board. [Editor's Note: Unless you have had some kit-building or soldering experience, you should not attempt to solder wires to a printed-circuit board.] Plug the other end of the cables into your parallel port and use an ohmmeter to check for proper wiring. The cables can be brought out of the typewriter by cutting slots in the ventilation holes in the case under the

## The **ACTION** Solution For Expanding Businesses...

The **DISCOVERY 500**, a fully integrated desktop computer with 5 1/4" hard and floppy disks, supports up to 7 users. It is the ideal, low cost turnkey business system. The full size **DISCOVERY** supports up to 16 users with a wide variety of disk and tape subsystems. And remember, all **DISCOVERY** users have their own dedicated memory and 8-bit or 16-bit CPU, running CP/M-80\* or CP/M-86\*. Action's own multiuser multiprocessor operating system, the **dpc/os** makes it easy.

The **dpc/net**\* low-cost local area networks of multiple **DISCOVERY**s provide the ultimate in performance. Up to 150 users in 10 **DISCOVERY** systems can be on-line simultaneously with full resource sharing. For the first time, mainframe capability at micro prices.

\*CP/M is a reg. TM of DIGITAL RESEARCH INC.

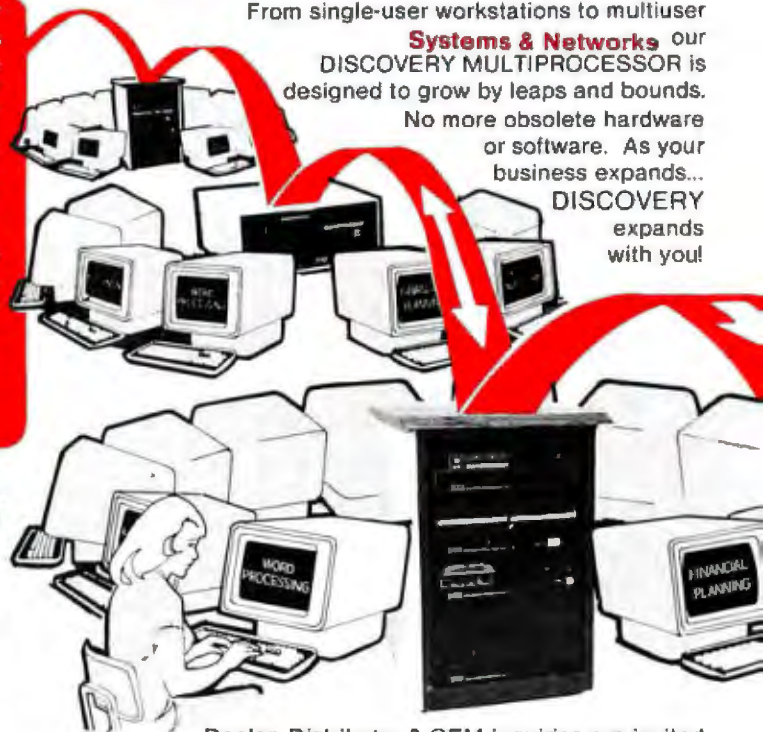
**dpc/os** is a reg. TM of ACTION COMPUTER ENTERPRISE INC.

From single-user workstations to multiuser

**Systems & Networks** our **DISCOVERY MULTIPROCESSOR** is designed to grow by leaps and bounds.

No more obsolete hardware or software. As your business expands...

**DISCOVERY** expands with you!



Dealer, Distributor & OEM inquiries are invited.

Step into the future...Take **ACTION** Today! Call **(213)351-5451**



**Action Computer Enterprise, Inc.**  
430 N. Halstead St., Pasadena, CA 91107 O USA  
TWX 910-588-1201 ACTION PSD O (213) 351-5451

In Europe: A.C.E.(Europe) Eindhoven, Netherlands TELEX 51767 ACE E NL Tel. 040-452658  
In Canada: CESCO Electronique LTEE O Montreal, Canada O (514) 735-5511  
In Asia: Action Computer Enterprise (Asia) Hong Kong TWX 75332 PACIC HX Tel. 5-440071

End Users circle number 10 on inquiry card. Dealers circle number 11 on inquiry card.



## SAGE TECHNICAL BRIEFING

### SYSTEM DESIGN, SAGE IV

The challenge was to create a computer having room for a megabyte of RAM, a built-in Winchester with floppy backup, and the ability to perform 2,000,000 instructions per second.

A small miracle, in other words.

And small is exactly what it turned out to be. In fact, the 16-bit Sage IV, including all of the above attributes, takes up less than 1/2 cubic foot.

What made such a breakthrough possible? System design.

It took the latest in memory and processor technology, plus Winchester technology. And it took a highly integrated, closely packed, low power, high speed design incorporating a proprietary bus.

Now the Sage IV is ready for you. Actually, you can choose from three different Sage IV models to meet your exact needs—configurations with a 5 megabyte Winchester plus 640K floppy right on up to a combination of four fixed or removable Winchesters plus one or two floppies (200 megabytes of disk capacity in all).

Because of the Sage IV's no-compromise system design you can load a 16K program in 1/10 second from Winchester disk.

What's more, there are over 120 sources for existing popular programs for the Sage IV. The incredible p-System operating system, standard on every Sage IV converts software that was originally written for 8-bit com-

puters in Pascal, BASIC and Fortran. Optionally, CP/M, Modula, and Hyper-Forth are also available.

Better yet, our small miracles come with prices to match.

So give us a call or write today for more Sage IV information and the name of your nearest dealer.

Sage Computer Technology,  
35 North Edison Way, #4, Reno,  
NV 89502 (702) 322-6868.

In Europe: TDI LTD, 29 Alma  
Vale Road, Clifton, Bristol  
BS8-2HL Tel: (0272) 742796.

**SAGE**  
COMPUTER TECHNOLOGY

Circle 401 on inquiry card.



COMDEX/SPRING '83

April 26 to 29, 1983 • Georgia World Congress Center • Atlanta, Georgia





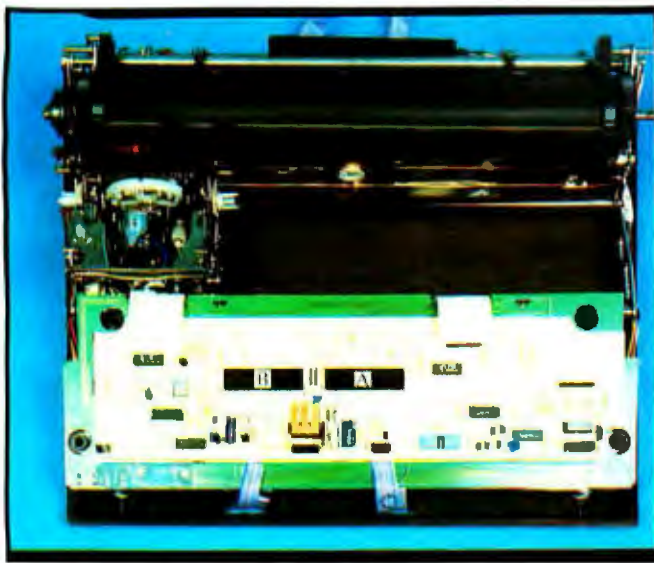


Photo 2: Bottom view of the component side of the keyboard assembly. Processors A and B are identified.

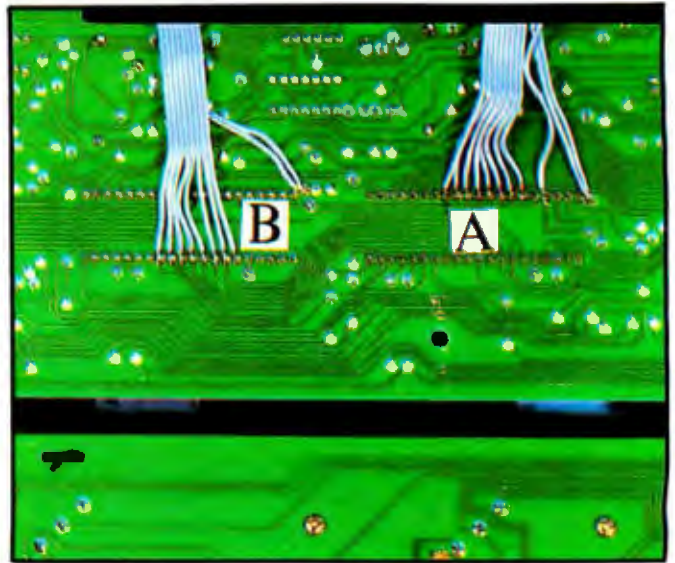


Photo 3: View of the printed-circuit side of the Praxis processor board. Note where the flat ribbon cables are connected to the A and B processors. Wires from Processor A connect to the output side of the parallel port. The lower board is the keyboard.

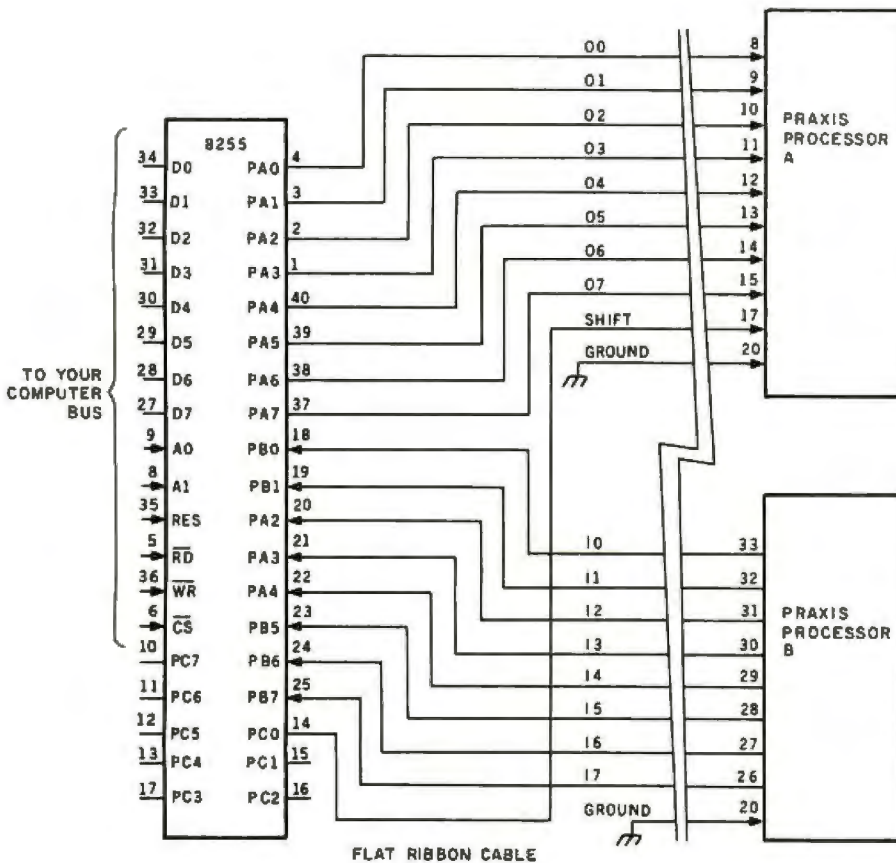


Figure 1: The interconnection between an Intel 8255 parallel-port chip and the Praxis microprocessors.

keyboard. Reassemble the keyboard and typewriter by reversing the disassembly steps.

### Software

The interface program (see listings 1 and 2 on pages 254-261) fits in less than 1K bytes, plus however much RAM you wish to allocate for buffer space. I assume a 2K-byte buffer in my code. The software is written in the C language and Z80 assembly code. C can be easily translated into assembly code or BASIC. The assembler I use has nonstandard (but Zilog-like) mnemonics. Assembly language is necessary for the interrupt handling and the critical timing of the keyboard sense/assert loops. I use interrupts because characters arrive from a host computer on a serial line to my special-purpose Z80 system, but other hardware/software combinations might not require interrupts.

Figure 2 is a flowchart of the control program. The typewriter is inherently a very slow device. Some speed is gained by taking advantage of the 12-character buffer that the typewriter's microprocessors use, but there is a danger of overflowing this buffer if the delay constants in the C program are changed. These con-

# High Resolution RGB Color Monitor Designed for the IBM Personal Computer

## FEATURES

- 80 characters x 25 lines
- 690 dots horizontal resolution
- 16 colors
- .31 mm dot pitch tube
- non-glare, black matrix
- plugs directly to IBM PC, cable supplied
- FCC Class B Approved



Princeton Graphic Systems' new HX-12 high resolution color monitor is designed with an NEC.31 mm dot pitch CRT to give you up to 690 dots horizontal resolution. You need not compromise the display quality of your system with monitors rated at less than the 640 horizontal dots generated by your IBM PC. The PGS HX-12 delivers 16 super colors, 80 characters x 25 lines. It is the best price/performance PC direct drive monitor in the market today. Get the PGS HX-12 and discover for yourself how well it complements your IBM Personal Computer.

phic Systems High Resolution 80 character HX-12 RGB  
 phic Systems High Resolution 80 character HX-12 RGB  
 phic Systems High Resolution 80 character HX-12 RGB  
 phic Systems High Resolution 80 character HX-12 RGB  
 phic Systems High Resolution 80 character HX-12 RGB  
 phic Systems High Resolution 80 character HX-12 RGB  
 phic Systems High Resolution 80 character HX-12 RGB  
 phic Systems High Resolution 80 character HX-12 RGB  
 phic Systems High Resolution 80 character HX-12 RGB  
 phic Systems High Resolution 80 character HX-12 RGB

80 character display

**PGS**

**Princeton  
Graphic Systems**



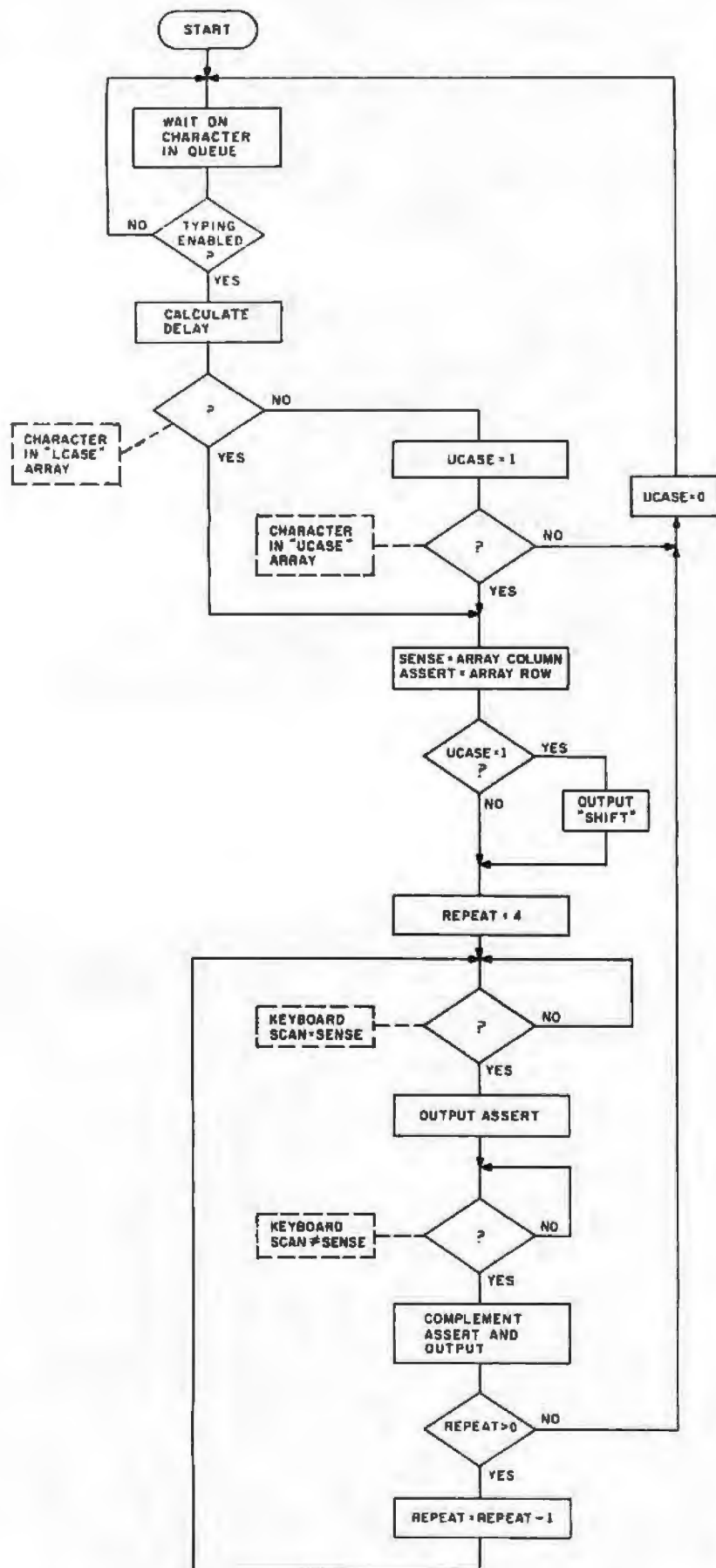


Figure 2: A flowchart of the controlling software as implemented in the C and Z80 assembler programs.

starts assume a 4-MHz processor clock.

The assembly-language routines and their functions are detailed below. Names preceded by an underscore are symbols external to the C program.

*int*—Called on an interrupt that occurs when a character is received in the serial port. The character is queued by *int*, which also transmits a Control-S to the host computer when the character queue is in danger of overflowing.

*start*—The parallel and serial ports are configured here. All variables are cleared and the queue pointers are set to their initial values. The stack pointer is set and interrupts are enabled. Finally, the C program is entered at its beginning (*\_\_main*).

*putc*—A character passed by *\_\_getc* is output on the serial line to the host.

*\_\_getc*—This routine is called from C to check and return characters from the queue. If no character is available, a -1 is returned; otherwise, a character from the queue is returned and the queue pointers are updated. If this causes the queue to empty, a Control-Q is sent to the host and the pointers are set to the base of the queue.

*\_\_put*—This routine is called with two arguments. The first is the value that Processor B will be asserting (and we will be sensing) when the desired key is being scanned. The second argument is the value we assert on Processor A's pins. The shift line is pulled low if the C program has set the variable *\_\_upper* to 1.

The delay loops in the C program assure that the characters are not sent to the typewriter faster than it can type or buffer them. If you have hardware timers available, the size of the program can be reduced. I have designated two Escape sequences to control typing. Until the TYPE\_ON code (ESC followed by Control-B) is received, characters are returned from the queue by *\_\_getc* but are ignored in the C loop. To type a character, a delay is first calculated. This delay allows time for the typewriter mechanics to print the character and/or move the carriage. Special

Text continued on page 262

# A NEW LIFE FOR YOUR APPLE II®

## MOVE UP TO THE NEW GENERATION WITH AN

# EPS KEYBOARD!



### FEATURES:

- Plug-in EPS PROMWARE™ Modules reconfigure keyboard for popular software packages, virtually eliminating complex command sequences.
- 12 Special Function Keys give up to 48 commands for popular software packages when used with EPS PROMWARE™ Modules.
- PROMWARE Modules available for WORDSTAR\*, VISICALC\*, APPLEWRITER II\*, SCREENWRITER II\*, and other packages.
- Interface Board plugs into keyboard socket on motherboard, no I/O slot required.
- 6 ft. cord and telephone style jack provide convenient placement and portability.
- Latching cover secures extra PROMWARE™ Modules and Command Templates.
- Full Word Processing layout — convenient and time saving.
- Word Processing Edit Keys (Delete, Insert, Find, Replace).
- CAP-LOCK, Working SHIFT Key.
- Auto-Repeat on all keys.
- Full cursor control with UP and DOWN arrows improves speed in spread sheet and word processing applications.
- 21-key Numeric Pad allows easy data entry.
- Works with APPLE II+ and most older versions, most 80 column cards and printers.

### TECHNICAL SPECIFICATIONS

- Full ASCII character set
- Microprocessor controlled
- Pinout matches APPLE II requirements
- Parallel output
- Power 5 Volts, 100 mA
- 1 9/16 x 9" x 3"
- 5 1/2 lbs.

Ask about optional Softswitch, 20 ft. extension cord, and Burn-Your-Own-Prom Kit.

**Economic \*\* Flexible \*\* Comfortable**  
**THE COMPLETE, INTELLIGENT SOLUTION**  
**Ideal for both Business and Personal Applications**

To order, please call or write to:

## EPS

Executive Peripheral Systems, Inc.

800 San Antonio Road, Palo Alto, CA 94303 (415) 856-2822

EPS and PROMWARE are trademarks of Executive Peripheral Systems, Inc.

\*Trademarks of Micro Pro International, Personal Software, Apple Computer Inc., and On-Line Systems.

**See us at  
 BOSTON  
 APPLEFEST  
 Booth A634**



# COMPU SHACK®



## IBM®

**Special  
of the  
Month!**

### IBM PC- COMPLETE LINE

#### IBM

PC System includes 64K IBM-PC with 320KB Floppy Disk Drive, Controller, Color Graphics Card, Monochrome Monitor. All for only **\$2599.00**

### LOTUS 1-2-3 SOFTWARE ... CALL

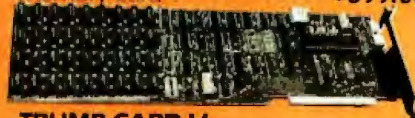
#### TAVA CORP. PRODUCTS

##### TRUMPCARD

A unique memory card with 256K Ram Game I/O and Serial I/O **\$499.00**

##### TRUMP CARD II

Serial I/O and 512K fully populated memory card **\$699.00**



##### TRUMP CARD V

Features Parallel and Serial I/O, Game I/O and a Clock/Calendar with battery back-up. A fully populated 256K memory board **\$599.00**

##### QUADRAM

Quad Board - 256K, Parallel Port, Serial I/O, Clock Calendar with battery backup **\$599.00**

512K Ram with Serial I/O **\$799.00**

##### AST RESEARCH

Combo Plus- 256K, Parallel & Serial Port, Clock Calendar W/Bat back-up, Superdrive, Superspool **\$599.00**

Mega Plus- 512K, Parallel & Serial Port, Clock Calendar W/Bat back-up **\$1199.00**

##### MAYNARD ELECTRONICS

Floppy Disk Controller **\$179.00**

Floppy Disk Controller w/Parallel Port **\$229.00**

Floppy Disk Controller w/Serial Port **\$239.00**

##### HERCULES GRAPHICS CARD

This card gives you 720 x 350 graphics **\$499.00**

\*CP/M 86 is a registered trademark of Digital Research Inc.

\*CP/M 80 is a registered trademark of Digital Research Inc.

### BIG BLUE

Dual I/O ports, dual processing, Serial port, Parallel port, 5 MHz, Z80 B, 64K, Hard disk interface, Clock/Calendar, let's you run existing CP/M® software. List **\$589** Ours **\$479**

### DISK DRIVES

For IBM PC

Tandon 100-2 **\$249**

Teac 55-B Slimline 320KB **\$269**

Shugart SA-455 Slimline 320KB **\$269**

### OTHER PRODUCTS FOR IBM

### MODULE CONVERSIONS FOR YOUR IBM-PC



## IBM®

**Z-80** Card-Will put PC in touch with 20,000 existing programs **CALL**

**8086**-Lets your IBM run 3 to 4 times faster **CALL**

**68000**-Converts PC to 32 bit Architecture and UNIX III. It transforms PC to a powerful cost effective Commercial Engineering work station **CALL**

**80286**-A multi-user expansion provides cost effective benefits **CALL**

**16032**-This micro-card offers VAX like functionality and architecture to PC **CALL**

**UNIX/XENIX™**-XENIX on IBM-PC **CALL**

**PC Versa Card**-512K Memory Card provides user flexibility to run on time tested Software available on any of the chosen processors **CALL**

### FLOPPY DISK DRIVES

#### SHUGART

SA400 SS/SD **\$169.00**

SA450 DS/DD **\$239.00**

SA800/801 SS/SD **\$365.00**

SA850/851 DS/DD **\$459.00**

#### TANDON

TM-100-1 SS/DD **\$189.00**

TM-100-2 DS/DD **\$249.00**

TM-100-4 DS/DD **\$359.00**

TM-848-1 SS/DD **\$425.00**

TM-848-2 DS/DD **\$499.00**

#### SIEMENS

FDD 100-5 **\$159.00**

FDD 200-5 **\$199.00**

#### QUME

DT-5 DS/DD **\$269.00**

DT-8 DS/DD **\$469.00**

### HARD DISK SYSTEMS FOR IBM AND APPLE

#### DATAMAC

6MB **\$1595.00**

12MB **\$1995.00**

18MB **\$2695.00**

Complete subsystem with software, cables and power supply

#### CORVUS

5MB Special **\$1999.00**

10MB Special **\$2999.00**



### PRINTERS

#### EPSON

FX-80 FT w/Graftrax Plus **\$599**

FX-100 FT w/Graftrax Plus **\$799**

MX-80 FT w/Graftrax Plus **\$499**

MX-100 FT w/Graftrax Plus **\$699**

#### STAR MICRONICS

Gemini 10 **CALL**

Gemini 15 **CALL**

#### SMITH CORONA

TP-1 parallel **\$579.00**

TP-1 serial **\$579.00**

#### C-ITOH

GX-100 (50 CPS Dot Matrix) **\$249.00**

8510 **\$469.00**

1550 (15") **\$699.00**

F-10 (40 CPS Letter Qual) **\$1395.00**

F-10 (55 CPS Letter Qual) **\$1695.00**

\*APPLE is a registered trademark of Apple Computers, Inc.

\*IBM is a registered trademark of IBM Corporation

\*APPLETTE I, APPLETTE 2, (X) TRUMP CARD are registered trademarks of TAVA Corporation, respectively.



**WE'VE MOVED  
TO BIGGER FACILITIES  
TO SERVE YOU BETTER**

# (714) 261-1000

Sales and Service: Business & Home Computers

**PLEASE NOTE OUR NEW PHONE NUMBER**

PRICES AND AVAILABILITY SUBJECT TO CHANGE WITHOUT NOTICE

**OKIDATA**

82A	\$429.00
83A	\$699.00
84AP parallel	\$999.00
84AS serial	\$1099.00
97A	\$525.00

**BROTHER**



HR-1 A parallel	\$769.00
HR-1 A serial	\$869.00
Tractor feed option	\$135.00

**NEC  
SPINWRITER**



7710-1	CALL	3510	CALL
7715-1		3515	
7730-1		3520	
7720-1		3525	
7725-1		3530	
3550			
PC8023A			

**MONITORS**

**AVAILABLE (All Models) CALL**

**AMDEK MONITORS**

Color I	\$359.00
Color II	\$699.00
Color III	\$399.00
300A	\$199.00
310A	\$199.00

**PRINCETON GRAPHICS SYSTEMS**

High Res. Color **CALL**

**SINCLAIR/TIMEX PRODUCTS**

**MEMOTECH PRODUCTS**

16K Memopack	\$ 59.00
32K Memopack	\$ 99.00
64K Memopack	\$169.00
Memopack High Res. Graphics	\$139.00
Memopack Centronics Parallel interface	\$139.00

**EPSON QX-10**

Z-80 CPU, w/64K Ram Video Graphics Processor, 12" monitor and many more features **CALL**

**HX-20**

Notebook Computer **CALL**



**apple**

**Apple IIe** 64K Complete System, 80 Column Card, One Disk Drive w/Controller, Monitor, Stand, plus 20 diskettes **\$1995.00**

**Apple II+** Computer System with 48K of memory, 2 "Data Drive" disk drives, controller card, 12" green screen hi-Resolution Monitor. All Cables and manuals are included for a CompuShack price of **\$1699.00**

For the same system listed above with a 16K card, Z80 card and an 80 Column card add **\$351**

**OTHER PRODUCTS FOR APPLE**

**Special of the Month!**



**TAVA CORP. \$279**  
**APPLETTE 1®**



100% Compatible Slimline drive for APPLE II+ and APPLE IIe. Runs DOS, C-PM® Pascal software. Suggested retail price **\$399.00**

**TAVA CORP. PRODUCTS**

<b>e plus 101</b>	
Interface for parallel printer	\$89.00
<b>e plus 102</b>	
Parallel output buffer board	\$169.00
<b>e plus 103</b>	
8K Epson buffered interface	\$149.00
<b>e plus 104</b>	
16K Serial output buffer card	\$199.00
Z80 card CP/M® included	\$159.00
80 column card	\$179.00
Disk drive controller card W/ diagnostics software	\$99.00
Disk drive controller	\$79.00

**HAYES MICROCOMPUTER PRODUCTS**

Micromodem 11300 baud	\$299.95
Smartmodem 1200 baud full duplex	\$529.95

**KAYPRO II COMPUTER SYSTEM**

64K Ram, Perfect Writer, Perfect Filer, Perfect Speller, Perfect Calc, S-Basic, CP/M® version 2.2, two disk drives, 9" (green) monitor, RS232 interface, Parallel Printer interface, and Weatherproof Carrying case, w/C-ITOH Dot Matrix Printer and cable **\$1995.00**

**DEC Rainbow 100**

Keyboard, CPU, Z-80/8088, 64K Serial RS232 Port, Two X-400KB Disk Drives, Monitor, CP/MB6®/80 Software, Printer and cable **\$3495.00**

**DECMATE II**

Complete System, Keyboard, CPU, 64K Words Ram, two 400 KB disk drives, monochrome monitor, operating system **List \$4500.00**

**DEC PROFESSIONAL 300**

Complete System, Keyboard, CPU, 256 KB Ram, two 400 KB disk drives, monochrome monitor, operating system **Under \$5000.00**

## CompuShack®

**CALL YOUR LOCAL COMPU SHACK DEALERS:**

California	Anaheim	*
	Concord	(415) 828-4752
	Glendale	(213) 340-7000
	La Mirada	(213) 947-9505
	Pasadena	(213) 792-8889
	San Fernando Valley	(213) 906-7000
	San Jose	(408) 973-1444
	Tucson	(714) 261-1000
	Walnut Creek	(415) 945-8011
	West LA	(213) 906-7306
	Woodland Hills	(213) 888-0030
Colorado	Denver	(303) 422-4545
Idaho	Twin Falls	*
Illinois	Chicago	(312) 964-4612
Montana	Great Falls	*
	Missoula	(406) 721-1811
New York	New York	(800) 228-5525
	Rochester	*
	Rorie	(315) 336-0266
Texas	Austin	(512) 258-1062
Washington	Richland	*
	Spokane	*
Wisconsin	Verona	(608) 845-7110
Canada	Toronto	(416) 593-8974
U.K.	London	01-925-0480

\*Call For Phone Number

16861 ARMSTRONG, IRVINE, CA. 92714  
HEADQUARTERS/TELEX: 181667 — ANSWER BACK: COMPU SHACK TSTN

ALL FLOPPIES REPAIRED QUICKLY AT LOW COST



# Call for MTI's lowest prices!

"QED" DISCOUNTS. VISA & MASTERCARD.

## VIDEO TERMINALS

ADM-3A Upper case only, direct cursor address.  
 ADM-5 Full ASCII, keypad, limited editing, etc.  
 MTI personal computing option for above, 800Kb.  
 Esprit Full ASCII, num. keypad, limited edit., etc.  
 Esprit II Full Esprit feat., Adds. ADM-3 & 5 emu.  
 Esprit III Full Esprit feat., Teletext 950 emul.  
 ADM-22 Ergonom. detached key, editing, etc.  
 ADM-23 Conversation & block mode, 2 page mem.  
 ADM-24 ADM-22 feat., 256 char buffer, graphics.  
 ADM-31 Full editing, 2 page buffer, protected fields.  
 ADM-32 Ergonom. ADM-31 with bus. graphics, etc.  
 ADM-35 DEC System terminal, 80 or 132 col., etc.  
 ADM-36 IBM 3277 keyboard layout, use with p.c.  
 VT 100 DECscops, 80 or 132 col., upgradable, etc.  
 VT 18X Personal computing option, 360 Kb stor.  
 VT 101 Non-upgradable VT100.  
 VT 102 Non-up. VT100 with adv. video, print, port.  
 VT 131 Abovs with editing and block mode.  
 TI 940 80 or 132 col., ergonom., one page buff., etc.

## GRAPHICS TERMINALS

VT125 Full VT100 with DEC ReGIS firmware.  
 VT 100/Digital Eng. Retro-Graphics Tektronix comp.  
 VT 101/Digital Eng. Retro-Graphics Tektronix comp.  
 VT 102/Digital Eng. Retro-Graphics Tektronix comp.  
 VT 131/Digital Eng. Retro-Graphics Tektronix comp.  
 ADM-3A/Digital Eng. R-Graphics Tektronix comp.  
 ADM-5/Digital Eng. Retro-Graphics Tektronix comp.  
 Colorscan 10/D.E.R.G., VT 100/52 emu., Tektronix.  
 VT100 w/TI 810 plotter, Tektronix compatible.

## TELEPRINTERS

LA 34-AA DECwriter IV 30 cps, variable char. widths  
 Diablo 620 RO letter quality 512-byte input buffer.  
 Diablo 630 RO API letter quality most pers. comps.  
 Diablo 630 KSR letter quality, 2688-byte buffer, etc.  
 TI 745 portable, thermal, built-in acoustic coupler.  
 TI 785 portable, above feat. with bubble memory.  
 Epson MX-80 80 cps serial impact printer, 80 CPL.  
 Epson MX-100 MX-80 plus 100 characters per line.  
 LA 120 RA receive only 180 cps, 132 col. multi. cop.  
 LA 120 AA KSR DECwriter III keyboard version.  
 LA 100 letterprinter, 240, 80 & 30 cps, graphics.  
 LA 50 personal printer, 100 cps, graphics capability.  
 LA 12 portable KSR, 150 cps on normal bond paper.  
 TI 783 portable, thermal, 120 cps bidirectional, etc.  
 TI 785 783 features plus acoustic coupler, etc.  
 TI 787 783 features plus internal modem, etc.  
 TI 810 RO impact, 150 cps, 132 col, multiple copies.  
 TI 820 RO 810 feat. plus full ASCII, 1280 char. buff.  
 TI 820 RO full features of RO plus full ASCII key.

## DATAPRODUCTS LINE PRINTERS

M-200 2400 baud 200 lpm at 72 cpi dot matrix printer.  
 B-300 tabletop band printer, 300 lpm, 132 col., etc.  
 B-600 pedestal-mounted 600 lpm band printer.  
 B-1000 cabinet-enclosed 1000 lpm band printer.  
 BP-1500 cabinet-enclosed 1500 lpm band printer.

## ACOUSTIC COUPLERS

Omnitec 715 300 baud orig./full duplex.  
 Omnitec 710 300 baud orig. /half & full duplex.  
 Vedic VA 3413 300/1200 orig. only.

## MODEMS

VA 103 300 baud modemphone, rotary & tone.  
 VA 355 300 baud 103 orig./ans. full duplex.  
 VA 212LC low cost 1200 baud 212A orig./ans.  
 VA 212PA orig./ans. with auto dial.  
 DFO3AA DEC 212A.  
 VA 1250 202 dir. con. w/o rev. chan.  
 VA 1255 202 dir. con. w/ rev. chan.  
 VA 3212 212A/103 orig./ans. w & w/o auto dial.  
 VA 3451 triple modem w & w/o auto dial.  
 Vadic double modems VA & Bell comp.  
 VA 2450 Bell 201 comp. w & w/o rev. chan., etc.  
 MICOM modems up to 9600 bps.

## LINE DRIVERS

MICOM asynch. & synch. line drivers.  
 MICOM 4 & 8-channel multiplexing line drivers.

## MULTIPLEXORS

MICOM 4, 8 & 16-channel multiplexors.

## PERSONAL COMPUTERS

DEC VT 180 64K, 360 Kb 5 1/4" dual floppy stor.  
 MTI Rooster 64K, 800 Kb 5 1/4" dual floppy stor.

## CP/M APPLICATIONS SOFTWARE

MicroPro, Microsoft, Polygon & Select.



Applications Specialists & Distributors  
 Computer Terminals, Peripherals & Systems  
 New York:  
 516/621-6200, 212/767-0677, 518/449-5959  
 Outside N.Y.S.: 800/645-6530  
 New Jersey: 201/227-5552  
 Ohio: 216/464-6688

## Listing 1: The C program.

```

* Global variables
char upper;          * upper case flag - used in "put" routine *
unsigned int delay1, delay2;    * typing delays *

* After assembly code initialization, the program
* is entered here.
main()
{
    char ch;
    char count;      * holds the current print position *
    char type;       * if "type" = f, typing is enabled *

    type = 0;        * default values *
    upper = 0;
    delay1 = 0;
    count = 0;

    while(1)         * infinite loop *
    {
        * getch is the assembly language routine
        * that checks for a character in the queue.
        * If the queue is empty, getch returns a EOF.
        * Otherwise, the character is returned.
        if(a = getch) == EOF) continue;

        * If the char begins an escape sequence
        * get another char to see which.
        * Otherwise, if type = 0, continue waiting
        if(a == ESC)
        {
            while(a = getch() == EOF);    * need another char *
            if(a == TYPEON)
                type = 1;                * enable typing *
            if(a == TYPEOFF)
                type = 0;                 * disable typing *
            continue;

            * continue looping if typing is disabled *
            if(!type) continue;

            * Type a character. First check for special
            * characters that will need long delays.
            switch(a)
            {
                case NL:
                    * A line feed can only be done
                    * in conjunction with a carriage
                    * return. Go back to the main
                    * loop
                    continue;

                case CR:
                    * Calculate carriage return delay.
                    * "count" holds the current print position
                    * The minimum delay is for a line feed alone.
                    * "delay1" is set to CRDEL * count
                    * If CRDEL * count - 65536, delay2 is
                    * set to count the overflow.
                    if(count == 0)
                    {
                        delay1 = LFDEL;    * minimum delay *
                        break;
                    }
                    if(count == MAXCDEL)
                    {
                        * Set delay1 to maximum.
                        * Set delay2 to the overflow
                        delay1 = MAX15;
                        delay2 = (count - MAXCDEL);

                        * delay1 = (CRDEL * count) + LFDEL;
                        count = 0;    * reset this to position 0 *
                        break;
                    }
            }

            * These are the various delay constants
            * as declared and by the C program to
            * make sure that the buffer internal to
            * the printer will not overflow.
            if(a == BACKSPACE)
                * delay after back space *
            if(a == LF)
                * delay after line feed *
            if(a == CR)
                * carriage return delay per character *
            if(a == MAX15)
                * maximum value in a register pair *
            if(a == MAXCDEL)
                * MAXCDEL * (MAX15 LFDEL)/CRDEL *
            if(a == TAB)
                * delay after each char *
            if(a == TABSPACE)
                * delay for tab space *
            if(a == SPACE)
                * minimal tab size in spaces *
    }
}

```

Listing 1 continued on page 256

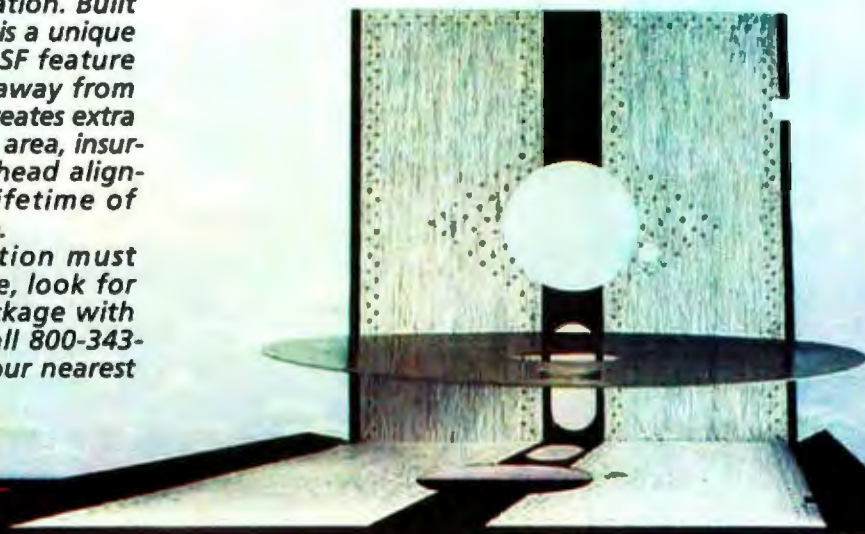
# BASF QUALIMETRIC™ FLEXYDISKS® BUILT FOR ETERNITY - WARRANTED FOR A LIFETIME.

*BASF Qualimetric FlexyDisks® offer you more...an extraordinary new lifetime warranty.\* The BASF Qualimetric standard is a dramatic new international standard of quality in magnetic media...insurance that your most vital information will be secure for tomorrow when you enter it on BASF FlexyDisks today.*

*We can offer this warranty with complete confidence because the Qualimetric standard reflects a continuing BASF commitment to perfection...a process which begins with materials selection and inspection, and continues through coating, polishing, lubricating, testing, and 100% error-free certification. Built into our FlexyDisk jacket is a unique two-piece liner. This BASF feature traps damaging debris away from the media surface, and creates extra space in the head access area, insuring optimum media-to-head alignment. The result is a lifetime of outstanding performance.*

*When your information must be secure for the future, look for the distinctive BASF package with the Qualimetric seal. Call 800-343-4600 for the name of your nearest supplier.*

Circle 57 on Inquiry card.



**BASF**  
**FlexyDisk**



ENTER TOMORROW ON BASF TODAY



**BASF**



# ERG/68000 MINI-SYSTEMS

- Full IEEE 696/S100 compatibility

## HARDWARE OPTIONS

- 8MHz, 10MHz or 12MHz 68000 CPU
- Memory Management
- Multiple Port Intelligent I/O
- 64K or 128K STATIC RAM (70 nsec)
- 256K, 512K or 1MB Dynamic RAM, with full parity (150 nsec)
- 5 1/4" or 8" D/D, D/S floppy disk drives
- 5MB-40MB hard disk drives
- Full DMA disk interface
- 1/4" tape streamer
- 10 to 20 slot backplane
- 20 or 30 amp power supply
- Desktop or rack mount cabinets

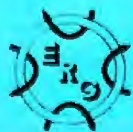
## SOFTWARE OPTIONS

- 68KFORTH<sup>1</sup> systems language with MACRO assembler and META compiler
- Fast Floating Point package
- Motorola's MACSBUG
- IDRIS<sup>2</sup> operating system with C, PASCAL, FORTRAN 77, 68K-BASIC<sup>1</sup>, CIS COBOL<sup>1</sup>, RDBMS
- CP/M-68K<sup>3</sup> O/S with C, Assembler, 68K-BASIC<sup>1</sup>, + 68K-FORTH<sup>1</sup>, Z80 Emulator<sup>1</sup>

Trademark <sup>1</sup>ERG, Inc.

<sup>2</sup>Whitesmiths    <sup>3</sup>Digital Research  
<sup>4</sup>Micro Focus

30 day delivery  
with valid Purchase Order  
OEM prices available  
For CPU, Integrated Card Sets  
or Systems.



**Empirical Research Group, Inc.**  
P.O. Box 1176  
Milton, WA 98354  
206-631-4855

Listing 1 continued:

```

* Control functions
* These codes correspond to non printing functions.
* Found in the array "lcase" and "ucase"
*
#define EMPTY 0x00 * for empty matrix positions *
#define MELOC 0x01 * main key *
#define MARR 0x04 * margin bypass *
#define CORR 0x05 * carriage key never used *
#define HALF 0x06 * half space *
#define MARI 0x07 * set left margin *
#define BS 0x08 * back space *
#define TAB 0x09 * tab /> next stop *
#define ML 0x0a * line feed - only available with carriage return *
#define MARR 0x0b * set right margin */
#define LOCK 0x0c * shift lock *
#define CR 0x0d * carriage return with line feed *
#define OH 0x0e * 1 2 (not an ASCII character) */
#define TABC 0x0f * clear tab stop */
#define TABS 0x10 * set tab stop */
#define EXPR 0x11 * carriage return without line feed *
#define REP 0x12 * repeat *
#define SP 0x13 * space character */
#define ESC 0x1b * ASCII escape */

*
* No typing will be done until the sequence
* ESC TYPEON is received. All characters received
* after ESC TYPEOFF will be ignored
*/
#define TYPEOFF 0x01
#define TYPEON 0x02
#define EOF -1
/*
* These are arrays.
*
* bit converts binary to one-of-eight code
*
char bit[8] = {0x01, 0x02, 0x04, 0x08, 0x10, 0x20, 0x40, 0x80};

*
* Lower Case characters and codes.
*
* The indexes into this array determine
* what key's position in the keyboard matrix.
* Note that the first index corresponds to the
* column and the second index to the row.
*
* The ' character is escaped with a */
char lcase[8][8] =
    EMPTY, '1', '2', '3', '4', '5', '6', '7', TAB,
    MELOC, '8', '9', '0', '1', '2', '3', '4', MARR,
    CORR, 'q', 'w', 'e', 'r', 't', 'y', 'u', HALF,
    EMPTY, 'a', 's', 'd', 'f', 'g', 'h', MARI,
    LOCK, OH, 'p', 'o', 'i', 'j', 'k', BS, TABS,
    REP, 'l', 'n', 'm', 'v', 'z', CR, EXPR,
    EMPTY, 'x', 'c', 'v', 'q', 'z', SP, TABC
    ;

*
* Upper Case - corresponds to chars on keys in lcase[]
*
* If a character cannot be found in "lcase", this array is
* searched. "ucase" = 1 for the "put" subroutine if the
* character is found in this array.
*/
char ucase[8][8] =
    EMPTY, '1', '2', '3', '4', '5', '6', '7', TAB,
    MELOC, '8', '9', '0', '1', '2', '3', '4', MARR,
    CORR, 'Q', 'W', 'E', 'R', 'T', 'Y', 'U', HALF,
    EMPTY, 'A', 'S', 'D', 'F', 'G', 'H', MARI,
    LOCK, OH, 'P', 'O', 'I', 'J', 'K', BS, TABS,
    REP, 'L', 'N', 'M', 'V', 'Z', CR, EXPR,
    EMPTY, 'X', 'C', 'V', 'Q', 'Z', SP, TABC
    ;

*
* Call the "lookup" subroutine to check
* look for the character in array "lcase".
* If not there, check array "ucase".
*
* Characters not found are ignored.
*
if (lookup(a, lcase) == 0)
    upper = 1;
lookup(a, ucase);
upper = 0;

```

Listing 1 continued on page 258



# LAST NIGHT, COMPU SERVE TURNED THIS COMPUTER INTO A TRAVEL AGENT FOR JENNIE, A STOCK ANALYST FOR RALPH, AND NOW, IT'S SENDING HERBIE TO ANOTHER GALAXY.

**NO MATTER WHICH COMPUTER YOU OWN, WE'LL HELP YOU GET THE MOST OUT OF IT.**

If you've got places to go, CompuServe can save you time and money getting there. Just access the Official Airline Guide Electronic Edition—for current flight schedules and fares. Make reservations through our on-line travel service. Even charter a yacht through "Worldwide Exchange."

If your money's in the market, CompuServe offers a wealth of

prestigious financial data bases. Access Value Line, or Standard and Poor's. Get the latest information on 40,000 stocks, bonds or commodities. Then, consult experts like IDS or Heinold Commodities. All on line with CompuServe.

Or if, like Herbie, intergalactic gamesmanship is your thing, enjoy the best in fantasy, adventure, and space games. Like MegaWars, the ultimate computer conflict.

To get all this and more, you'll

need a computer, a modem and CompuServe. CompuServe connects with almost any personal computer, terminal, or communicating word processor. To receive an illustrated guide to CompuServe and learn how you can subscribe, contact or call:

## CompuServe

Consumer Information Service  
2180 Wilson Road, Columbus, Ohio 43228

**800-848-8199**

In Ohio, call 614-457-8650

An H&R Block Company



FOR TRS-80 MODEL I OR III  
IBM PERSONAL COMPUTER

## The MMSFORTH System. Compare.

- The speed, compactness and extensibility of the MMSFORTH total software environment, optimized for the popular IBM PC and TRS-80 Models 1 and 3.
- An integrated system of sophisticated application programs: word processing, database management, communications, general ledger and more, all with powerful capabilities, surprising speed and ease of use.
- With source code, for custom modifications by you or MMS.
- The famous MMS support, including detailed manuals and examples, telephone tips, additional programs and inexpensive program updates. User Groups worldwide, the MMSFORTH Newsletter, Forth-related books, workshops and professional consulting.

# mmsFORTH

### A World of Difference!

- Personal licensing for TRS-80: \$129.95 for MMSFORTH, or "3/4TH" User System with FORTHWRITE, DATAHANDLER and FORTHCOM for \$399.95.
- Personal licensing for IBM PC: \$249.95 for MMSFORTH, or enhanced "3/4TH" User System with FORTHWRITE, DATAHANDLER-PLUS and FORTHCOM for \$549.95.
- Corporate Site License Extensions from \$1,000.

If you recognize the difference and want to profit from it, ask us or your dealer about the world of MMSFORTH.

MILLER MICROCOMPUTER SERVICES  
81 Lake Shore Road, Natick, MA 01760  
(617) 653-6138

Listing 1 continued:

```

* This subroutine checks in "array" for the
* character in "v". If not found, a 0
* is returned. Otherwise, the character's
* row and column positions are converted
* to one-of-eight codes by array "bit" and
* passed to the assembly language routine "put".
* Upon return from "put", delay1 and, if set,
* delay2 are counted down to zero.
*
lookuplv, array)
char v:
register char array{#|8|}
{
char x, y:
{for y = 0: v = 8: y++}
{for x = 0: x = 8: x++}
{
* x is the assert row, y the sense column
iflv == array{x|y|}
{
put{bit{y|, bit{x|}}
while{delay1 > 0} --delay1:
while{delay2 > 0} --delay2:
return{!}: * character is in "array"
}
}
}
return 0! * character was not in "array"
}
    
```

Listing 2: The Z80 assembler program.

```

* These are the assembly language routines
* The mnemonics are similar to Zilog's.
* Check the Z80 Assembly Language
* Programming Manual and you will see the
* similarities.
*
* Some examples:
*
* Here Zilog
lda nn 0x1234 LD A,[1234H]
lddddnn hl,0xa12a LD HL,A12AH
ldr lxda.s. LD A,[IX+8]
pushqq de PUSH DE
ld.nnddabc.de LD [abc].DE
*
Numbers in the form 0x1234 are hex
*
0800 RAM > 0x0800 / start of ram in my system
079c BUFSIZ > 1948. / buffer size, in characters
0014 HIGHW = 20, / high water mark, 20 from top of memory
1000 STACK = RAM-2048. / stack pointer set here
*
00ff INIT = 0xff / initial value in output port
*
/ Intel 8255 parallel port
0000 PBASE = 0x00 / port base address
0000 PA = PBASE / Port A address
0001 PB = PBASE+1 / Port B address
0002 PC = PBASE+2 / Port C address
0003 CONT = PBASE+3 / Configuration command register
*
008a CONP = 0x8a / PA out; PB in; PC0-3 out; PC4-7 in
*
/ Intel 8251 Serial Port
0004 TRBASE = 0x04 / port base address
0005 TSTAT = TRBASE+1 / status register
0004 TDATA = TRBASE / data register
*
/ configuration mode and command
004e TMODE = 0x4e / 8 bit length; no parity; 1 stop bit;
0037 TCOMM = 0x37 / enable rx and tx
*
/ 8251 Status masks
0002 HRBF = 0x02 / receiver buffer full
0001 UTBE = 0x01 / transmitter buffer empty
*
00fe SHIFT = 0xfe / assert shift line (bit 0)
0011 GO = 0x11 / CONTROL 0
0013 STOP = 0x13 / CONTROL 3
*
globl main
globl put, upper, getc
*
0000 c1 82 00 ipnn start
0038 ; *0x35
*
/ 0x3B: IM1 vector - here on receiver buffer
/ full interrupt
*
/ Test the queue pointer fillp for its proximity
/ to the top of the queue (highw).
*
/ If fillp <= highw, store char in buffer and
/ increment fillp.
*
/ If highw < fillp <= topmem, send STOP,
/ store char, and increment fillp.
*
/ If fillp > topmem, send STOP, store char,
/ but do not increment fillp.
    
```

Listing 2 continued on page 260

# Keep your bottom line on the up and up and up.

The future never comes with any guarantees.

But there is a way to improve tomorrow's business performance today.

It's a microcomputer program called the Bottom Line Strategist.™

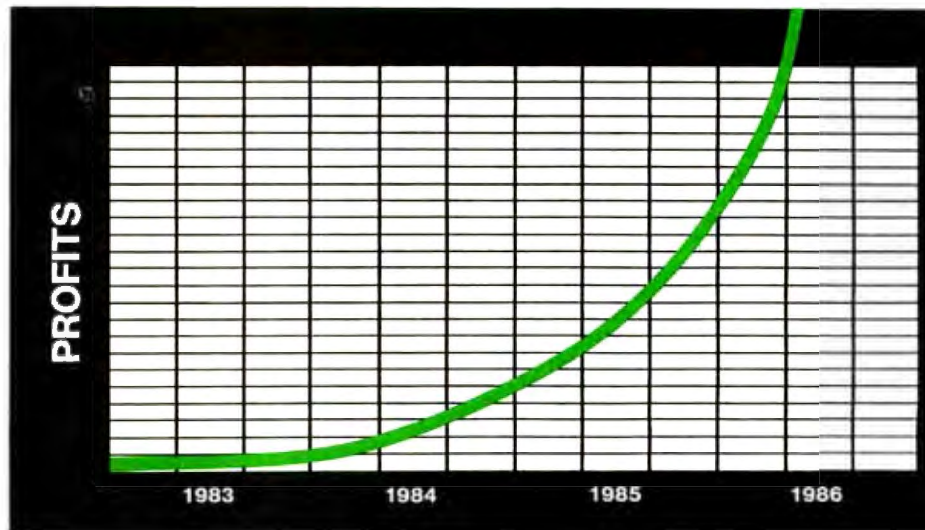
## The future is now.

With the Strategist and your microcomputer, you can explore *alternative* business decisions and get answers to the questions common to any business focused on growth:

How much money are we risking? Will the business be profitable? When? Is that soon enough? Can we improve this by changing the price? What's the impact of our assumptions on net worth, cash flow, market penetration and growth?

The Strategist uses seven sophisticated econometric models originally developed for companies on the Fortune 500 list.

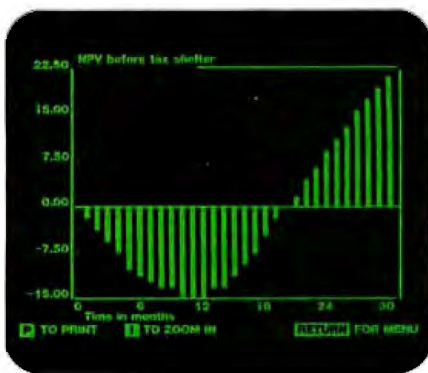
But it's pre-programmed, so all you do is enter your current business assumptions, then sit back and watch the dynamics of your future unfold graphically.



The Strategist plots (and tabulates) your marketing and sales projections; anticipated cash flows; break-even point; Net Present Value; and more—a total of 11 production, financial and marketing forecasts.

If any area looks interesting, the unique "zoom" takes you in for a closer look at the picture. And if you don't like what you see, do it all over again.

Instantly. Without any programming. And do it as often as you need to get the results that you want.



## Tomorrow's answers today.

The Strategist is a unique short-cut to experience, without the hard knocks.

You can refine your pricing policies. Optimize your cash flows. And maximize your profits while minimizing your risks.

In today's business climate, how much is that worth? The Bottom Line Strategist is \$400.

## Our no risk offer.

You can check out the Bottom Line Strategist with no financial risk.

Drop by a dealer showroom and run through a hands-on demonstration. Then take home a package and use it for 30 days. It runs on 8-bit and 16-bit microcomputers (IBM PC, Apple II, CP/M, etc.) If you don't like it, return it and you'll get your money back.

For the name of your nearest dealer, contact Ashton-Tate at 10150 West Jefferson Boulevard, Culver City, CA 90230.

Better yet, call (213) 204-5570 today. Because if time is money, the Bottom Line Strategist is money in the bank.

**The Bottom Line Strategist™**

ASHTON · TATE ■

Circle 49 on Inquiry card.



# IBM PC, APPLE ... ANY CPU

Expand your system with these low cost add-ons, which do not require internal installation or limit your expansion capability.

## "SELECTO-SWITCH"



P24AB  
\$139

The -P24AB "Selecto-Switch" will allow you to connect two printers to the same parallel port. After installation, the "Selecto-Switch" can select either one, just by turning a knob. Imagine the time savings and ease of operation. Our "Selecto-Switch" will pay for itself in less than 6 months. The -S24AB will do the same on your serial port. Many other models are available for up to 6 ports (and 36 wires.) Fully compatible with RS-232, Centronics, Parallel, IEEE 488, RS-449, TRS 80, Apple, IBM PC ... etc. Prices start from \$80.00 (in quantity).

## "AUTO-SWITCH"



ASU-3-PPM  
\$499

The ASU-3 is an automatic version of our "Selecto-Switch" family. Your CPU can control 3 devices totally under program control. Automatic baud rate, remote operation, port labeling and many other options are available. Also available in 5 and 7 port units. Prices start from \$449.00 (Single Qty.).

## "AUTO-SCAN"



ASN-7-PPM  
\$538

The ASN-7 is an automatic port scanner. Up to 7 CPU's can be polled and, upon request, any CPU can be connected to a shared device (printer, modem, etc.) Fully automatic control. Priority port and contention are optional. Also available for 3 and 5 ports. Prices start from \$249.00 (Single Qty.).

Dealer inquiries invited.

Also available from Giltronix, a full line of innovative system products for back-up switching, monitoring, fall-back and port sharing. Both rack mount and stand alone units are available. Contact Giltronix or our local distributors.



3780 Fabian Way, Palo Alto, CA 94303  
(415) 493-1300 1-800-531-1300

### Listing 2 continued:

```

0038  f5          int1:  movl $4, %eax          save r1 register
0039  09          *%kx          save %e, %r, %h register

003a  14 00      idata  1,0
003b  32 00 00   ld,na  %eax,%eax
003c  32 01 00   ld,na  %eax,%eax
          ; last check proximity of fillp to highw
0042  11 0e 0f   lddnm  %eax,%eax
0043  04 5b 02 08 lddd,na,%fillp
          ; if fillp <= highw, store character normally
0049  0f          xorr  %eax,%eax
004a  0d 52      schld  %eax,%eax
004c  30 17      jrcz  int1
          ; clear carry
          ; high-fillp
          ; c clear if fillp <= highw

          ; fillp is > highw. Send STOP and set stopf = 1
004e  3e 13      idrn  %eax,%eax
004f  0d b4 00   calln  %eax,%eax
          ; send STOP
0051  3e 01      idrn  %eax,%eax
0052  32 01 00   ld,na  %eax,%eax
          ; IF fillp = topmem,
          ; set 'nomore' so fillp won't be incremented.
0058  21 47 0f   lddnm  %eax,%eax
0059  0f          xorr  %eax,%eax
          ; clear carry
005c  0d 52      schld  %eax,%eax
          ; topmem-fillp
005e  20 05      jrcz  int1
          ; c clear if topmem != fillp
0060  3e 01      idrn  %eax,%eax
          ; set flag
0062  32 00 00   ld,na  %eax,%eax

          ; put char in buffer at fillp and increment fillp
          ; if nomore = 0
0065  2a 02 00   int1:  ldhl,na,%fillp
0066  0b 04      ins,na  %eax,%eax
          ; get character
006a  06 7f      andn  %eax,%eax
          ; 7 bit ascii
006b  77          id,hl  %eax,%eax
          ; into buffer
006d  3a 00 08   lda,na  %eax,%eax
006e  7e 01 00   cpm  1
          ; is nomore set?
0070  70 05      jrcz  int2
          ; c clear if nomore = 0
0074  11          popq  %eax,%eax
          ; restore register af
0075  09          xorr  %eax,%eax
          ; restore bc, de, and hl
0076  1b          si
          ; re-enable interrupts
0077  0d 4d      retl

0079  33          int2:  incs  %eax,%eax
007a  32 02 08   ld,na  %eax,%eax
007b  0f          popq  %eax,%eax
          ; restore register af
007c  09          xorr  %eax,%eax
          ; restore bc, de, and hl
007d  1b          si
          ; re-enable interrupts
007e  0d 4d      retl

          ; system initialization
0082  3e 0a      start: ldrn  %eax,%eax
          ; configure port
0083  03 03      out,na  %eax,%eax
          ; COM1
0084  3e 1f      ld,na  %eax,%eax
          ; INIT
0085  03 00      out,na  %eax,%eax
          ; PA
0086  03 02      out,na  %eax,%eax
          ; PC

          ; clear all of ram
008c  3e 00      ld,na  %eax,%eax
008d  21 00 08   lddnm  %eax,%eax
          ; RAM
008e  77          id,hl  %eax,%eax
008f  11 01 08   lddnm  %eax,%eax
          ; RAM+1
0090  01 00 08   lddnm  %eax,%eax
          ; STACK-RAM
0091  0d b0      idir

          ; set up buffer pointers
009a  21 06 08   lddnm  %eax,%eax
009b  22 02 08   id,na  %eax,%eax
009c  22 04 08   id,na  %eax,%eax

          ; reset serial port
00a3  3e 40      ld,na  %eax,%eax
00a4  03 05      out,na  %eax,%eax
          ; TSTAT
00a5  3e 37      ld,na  %eax,%eax
00a6  03 05      out,na  %eax,%eax
          ; TCOMM

          ; load stack pointer
00ab  31 00 10   lddnm  %eax,%eax
00ac  0d 56      im)
          ; set interrupt mode 1
00ad  1b          si
          ; enable interrupts
00ae  03 42 01   jppn  %eax,%eax
          ; enter the C program

          ; Put a character out through the serial port
          ; The char is to be output in %a register
          ; %b register destroyed
00b4  47          iput:  id,hl  %eax,%eax
          ; save
          ; wait on buffer empty
00b5  0b 05      out1:  ins,na  %eax,%eax
          ; TSTAT
00b6  06 01      andn  %eax,%eax
          ; UFB
00b7  26 fa      jrcz  %eax,%eax
          ; out1
00b8  79          id,hl  %eax,%eax
          ; a,b
00b9  0d 04      out,na  %eax,%eax
          ; TDATA
00ba  09          ret

          ; Called from C.
          ; Return char in buffer if available or -1
          ; if the buffer is empty. Check the queue pointer
          ; fillp against drainp.
          ; If fillp > drainp, return char pointed to by drainp
          ; and increment drainp.
          ; If fillp = drainp and drainp != buf, we have returned
          ; the buffer is empty. Reset both pointers to "buf"
          ; and return -1. Also send a GO to the host.
00bf  24 02 08   get:  ldhl,na,%fillp
          ; hl = fillp
00c0  0d 5b 04 08 lddd,na,%drainp
          ; de = drainp
00c1  0f          xorr  %eax,%eax
          ; clear carry
00c2  0d 52      schld  %eax,%eax
          ; fillp-drainp
00c3  30 23      jrcz  %eax,%eax
          ; c clear if fillp != drainp
    
```

Listing 2 continued:

```

00cb 21 06 08      / drainp = fillp. Now check drainp against buf
00cc          lddnn hl,buf      / hl = buf
00cd          xorl a           / clear carry
00ce          shllsld         / buf-drainp
00cf          jrcz get1       / x set if drainp = buf

00d3          / drainp = fillp and drainp != buf, so
00d4          / return -1 and reset both pointers to buf
00d5          lddnn dl,buf      drainp=fillp=buf
00d6          ld.nmddrainp.de
00d7          ld.nmddfillp.de

00e0          / If stopf = 1 send GO
00e1          lda.nn stopf
00e2          cpl             /
00e3          jrcz get1       / x clear if stopf = 0
00e4          ldnn a,GO
00e5          callnn lputa

00e6          / no char avail. Return -1
00e7          get1:          lddnn hl,-1
00e8          ret

00ee          / return char from buffer and increment
00ef          / drainp.
00f0          get2:          lda.de           de=drainp. Get char from buffer
00f1          incs de         / increment drainp
00f2          ld.nmddrainp.de
00f3          ldrr l,a        / return char
00f4          ldrr h,0
00f5          ret

00fb          / putisense, assert
00fc          / Called from C
00fd          / The arguments are on the stack at offsets 6 and 8,
00fe          / respectively
00ff          / 'sense' is the one-of-eight code to look for on the
0100          / scan lines.
0101          / 'assert' is the one-of-eight code to place on the
0102          / processor input.
0103          / Both values must be complemented before use
0104          / If the variable 'upper' was set in C, assert the
0105          / upper case line
0106          put:          lddnn hl,0
0107          callnn osv
0108          / test for upper case
0109          lda.nn upper
010a          cpl             / shift?
010b          jrcz p0
010c          ldrr a,SHIFT
010d          out.nn PC

010e          p0:          ldrr b,4.         count
010f          ldrr.idx.a.6.    / arg1: look for this scan
0110          cpl             / complement
0111          ldrr d,a         / to d
0112          ldrr.idx.a.8.    / arg2: put this out
0113          cpl             / complement
0114          ldrr e,a         / to e
0115          / wait for scan = sense value
0116          ina.n PB         / input Processor B value
0117          cpl             / has the code come up yet?
0118          jrcz p1         / if not, keep looking

0119          / output assert value
011a          ldrr a,e
011b          out.nn PA       / val out to Processor A

011c          / wait for scan complete
011d          ina.n PB         / input Processor B value
011e          cpl             / look for sense code to change
011f          jrcz p3

0120          / unassert lines
0121          ldrr a,INIT
0122          out.nn PA
0123          djnz p1          / do it again until b = 0
0124          out.nn PC       / negate shift
0125          jpnz cret       / back to C

0126          / register save sequence
0127          rsv:          ss.sp1y         / put sp onto the stack and put ret address in sp
0128          pushix          / push ix onto the stack
0129          ldixnn 0        / copy sp into ix
012a          addixpp sp
012b          addixsp sp     / add reset stack pointer from stuff in hl
012c          ldaphl
012d          jp.ly         / return
012e          cret:          ldapix
012f          popix
0130          popsp
0131          ret

0132          .->RAM
0133          / variables in ram
0134          / starting at address 800 (hex)
0135          8000 00        nomore: .byte 0
0136          8001 00        stopf: .byte 0
0137          8002 00 00     fillp: .word 0
0138          8004 00 00     drainp: .word 0

0139          / the character queue
013a          buf:          .->BUFBI2-HIGHW
013b          highw:
013c          .->HIGHW
013d          topmaa: .byte 0
013e          00
    
```

S-100 Boards from S. C. Digital

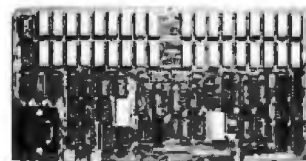


FLOPPY DISK CONTROLLER

features: **Model FDC1**  
 • Single or Double density, sides, in any combination of up to four 8" or 5.25" drives. • Digital phase locked loop. • DMA data transfer with cross 64K boundaries, 248 address, DMA arbitration. • Monitor/boot EPROM accommodating two different processors. • CPM Bios programs. • Serial port to 19.2K baud.

Z80B CPU BOARD

features: **Model Z80 CPU**  
 • 2, 4 or 6 mhz clock. • 22 bit Address by Memory Mapping in 16K blocks. • 2 or 4Kbyte EPROM (not supplied) with Phantom generation. • Jump on Reset. • Provision to run two different CPU's on the same bus, such as forth coming 8086.



NEW 256K DYNAMIC RAM

features: **Model 256KZ**  
 • 8/16B Data, 248 Address. • Parity bit per Byte • Transparent refresh • Unlimited DMA • 180nsec. Access time • Will run 8086, 8088, 80800 to 8mhz, Z80, Z8000 to 8mhz without wait states.



NEW 64K STATIC RAM

features: **Model 64KS**  
 • 8/16B Data 248 Address • Disable in 2K increments • 180nsec Access Time (with 64KB) from address on, runs 8086, 80800 to 10mhz, Z80, Z8000 to 8mhz without wait states • Battery back up capable.

Board Sets: For Limited Time Only!  
 • Z80B CPU, DMA Floppy Controller, CP/M 2.2, 64KB Static Ram \$1,000  
 • Z80B CPU, DMA Floppy Controller, CP/M 2.2, 250KB Ram \$1,250  
 • For CP/M Plus instead of 2.2 add \$50  
 Please call for latest prices.

All boards conform to IEEE696/S100 specifications, fully stocked, screened legends, masks, Gold contacts. Guaranteed One Full Year.

New Prices Effective May 1, 1983

Model	Price	with
FDC1	\$395	Monitor EPROM
Z80 CPU	\$325	Memory Mapping, 6mbz
256KZ	\$695	250KB, Parity
256KZ-120	\$695	478KB, Parity
64KS	\$425	64KB, CMOS
32KB/SM	\$295	32KB, CMOS
3SPC	\$250	3 serial 1 parallel cassette
CP/M 2.2	\$55	Purchased with FDC1
CP/M Plus	\$105	Purchased with FDC1
Z80 Monitor	\$55	2K m EPROM, source code, for 3SPC

All Boards come assembled and tested.

Delivery is within 3 to 5 working days. MC, Visa or CDD orders accepted. (Add \$6 for CDD orders) Illinois residents add 5 1/2% sales tax.

\*CP/M is a registered trademark of Digital Research, Inc. O.E.M. & DEALER PRICE AVAILABLE

**S. C. DIGITAL**  
 1240 N. Highland Ave., Suite #4  
 P. O. Box 906, Aurora, Illinois 60507  
 Phone: (312) 897-7749



delays are needed for carriage returns, backspaces, and tabs. The carriage-return delay is calculated by multiplying the current print position by a constant and adding the linefeed delay. If this number exceeds 65,535, a second delay must count the difference. The tab delay assumes a nominal 8-character tab width.

A character to be typed is first looked up in the *lcase* (lowercase) array. If it is not found there, the *ucase* (uppercase) array is checked. A character never found is ignored. The row and column indexes corresponding to the character's position in the array are converted by the *bit* array to one-of-eight codes. If the character is found in *ucase*, the upper variable is set to 1. The two one-of-eight codes are passed to the `__put` assembly-language subroutine. On return, the C program counts down the previously calculated delay and continues checking the character queue. The program will stop typing when a `TYPE_OFF` sequence (ESC followed by Control-A) is found in the buffer. Note that typing will not stop immediately if there are characters in the buffer ahead of `TYPE_OFF`.

### Typewriter Setup

I have selected control characters to perform the typewriter's programmable functions. These are found in table 2. It would be helpful to follow an example of their use. To set the tabs and margins, the host sends a `TYPE_ON` sequence followed by the hexadecimal ASCII (American Na-

Function Code	Hexadecimal Value	Typewriter Function
RELOC	03	reloc
MARB	04	margin bypass
CORR	05	correction key
HALF	06	half space
MARL	07	margin left
BS	08	backspace
TAB	09	tab
MARR	0b	margin right
LOCK	0c	shift lock
CR	0d	carriage return
OH	0e	½
TABC	0f	tab clear
TABS	10	tab set
EXPR	11	expr
REP	12	repeat

**Table 2:** This table shows control character mapping. I have assigned the special functions of the typewriter to ASCII control codes.

tional Standard Code for Information Interchange) codes 11, 0F, and 12 for "EXPR TABC REP." As explained in the Praxis typewriter operating guide, this sequence will clear all tabs and margins and return the carriage to position 0. Because my program does not calculate a delay for these control codes, the host should wait a second or two before sending more characters. The host can now set the tabs and margins by sending space characters (hexadecimal ASCII 20) to move the carriage to the desired column followed by the control functions MARL, TABS, and MARR as appropriate. Subsequent characters sent by the host will be printed by the typewriter until a `TYPE_OFF` sequence is found in the queue.

### Conclusions

I have tuned the delay constants in the program for the fastest possible typing speed. However, because I rely on the Praxis typewriter's internal buffer, I run very close to overflowing it. You may have to retune these constants for your particular system speed. Along the lines of improvements, it may be better to sense when the typewriter has finished printing a character by reading the F8 lines that control the mechanics.

One keyboard function I did not implement is the KB-I/KB-II switch. Being a toggle switch, it cannot be pulled like the momentary switches. A relay would do the job nicely.

I am quite pleased with the operation of the typewriter. It may seem that \$250 is a lot to spend on a portable typewriter. With letter-quality computer printers costing three to six times as much, however, the Praxis typewriter looks comparatively good. The quality of the type is excellent—crisp characters perfectly aligned.

I have written several driver programs on my host system to manipulate the typewriter. One program sets up tabs and margins and prints a file previously run through a word-processor program. A library of subroutines can be included in other programs to print output on the typewriter. One application is an elaborate checkbook program that uses the typewriter to print out checks. ■

## DATA TRANSFER PROBLEMS?

Your Simple Solution is **REFORMATTER**® Diskette Conversion Software



- Avoids serial communication protocols.
- Needs only one system to transfer data.
- Converts source code and data files.
- Allows 2-way transfer.
- Quick, reliable, and inexpensive.

VERSIONS	
Runs On	Reads/Writes
CP/M	↔ IBM 3740
CP/M	↔ DEC RT-11
CP/M-86*	↔ <b>NEW</b> IBM 3740
TRSDOS II	↔ CP/M
TRSDOS II	↔ DEC RT-11
DEC RT-11*	↔ CP/M
CROMIX	↔ DEC RT-11
PRICE:	\$249 *\$350

Requires 8" floppy drive



(415) 324-9114 TWX: 910-370-7457

467 Hamilton Avenue, Suite 2, Palo Alto, Calif. 94301

## Painter Power

### An Electronic Paintbrush for Artists

---

Chris H. Pappas and William H. Murray  
Computer Science Department  
Broome Community College  
Binghamton, NY 13902

---

Painter Power is a high-resolution graphics program that lets Apple II users create paintings on a color screen. Completed paintings may be viewed in a slide show on the color monitor or printed if a screen dump routine is available.

Painter Power allows you to use the Apple II keyboard, game paddles, or a joystick to paint color pictures. You use them to create "brushes" and to move objects around on the "canvas." We recommend, as a minimum, the purchase of a pair of high-quality, noncentering joysticks for the creation of brush shapes. (A noncentering joystick remains in position when released, easing figure and brush creation.) The brush moves across the screen at a predetermined rate of speed: snail, turtle, rabbit, and blitz. You control where the brush goes by the joystick and whether or not the brush is

touching the canvas (i.e., painting or not painting).

Painter Power operates in two modes: beginner and advanced. The beginner level is not as powerful as the advanced, which requires time and patience to master. With the beginner level, you can be up and painting in a flash. We estimate that it will take about an hour to master the beginner mode and probably a month of painting to master the advanced mode—it has a lot of features. With either mode, you can really paint creatively.

#### Beginner Mode

The beginner mode supplies a preformed brush. You can create a different brush by using the brush-create mode and preferably a joystick. You can also control the brush's width and shape in the creation process and, hence, the patterns made with a stroke.

#### At a Glance

**Name**

Painter Power

**Use**

Permits the use of a color television or monitor to serve as a painter's canvas for creating pictures from the Apple's high-resolution mode.

**Manufacturer**

Micro Lab  
2310 Skokie Valley Rd.  
Highland Park, IL 60035  
(312) 433-7550

**Price**

\$39.95

**Features**

Contains two modes: beginner and advanced. The beginner mode is easier to use but has fewer options. Both modes allow an

artist to select background color and brush colors and shapes. The brush shape can be controlled from the keyboard, game paddle, or joystick.

**Format**

A locked 5¼-inch floppy disk.

**Computer**

Designed to run on an Apple computer with a 16-sector disk drive. Requires 48K bytes of memory and Applesoft in read-only memory or a language card.

**Documentation**

44-page manual

**Audience**

Anyone wishing to create color paintings for personal pleasure or presentation.



Once satisfied with the brush shape, you change to paint mode and select the background color for the canvas. Your choices are green, purple, white, orange, blue, and black. As with oil paints, you can paint over previous work. This lets you experiment with a shape on the canvas before making it a permanent part of the picture.

If unsatisfied with a painting, you can "purchase" a new canvas by hitting the "C" key and clearing the pattern. Masterpieces can be saved on disk for a future showing.

### Advanced Mode

While the beginner mode will get you painting with a minimum of frustration, the real power of Painter Power lies in the advanced mode. It uses the keyboard, as many as four paddles or a joystick, two high-resolution screens (one for brush making and the other for the painting), and four text lines (for controlling the display) at the bottom of the canvas. A wraparound mode extends the canvas from -256 to +255 points in both directions on the beginner canvas to -512 to +511 points on the advanced canvas.

Two vectors on the text screen show the brush's location on the high-resolution display. The form is -100, +70, where -100 is 100 points left of the starting position and +70 is 70 points above the starting position of the brush. While the brush is painting, these numbers are constantly changing, which helps you position it precisely.

Painter Power lets you design and save as many as eight different brush shapes. A ninth shape, called Quickstroke, is available from among the eight original brushes. With Quickstroke, predefined patterns may be selected and painted on the canvas.

With the advanced mode, you can create patterns with mathematical functions. These shapes include circles, flower petals, spirals, ellipses, and sine or cosine waves. You have control over the size, scale, number of repeats, and beginning and ending angles.

### Slide Shows

The Slide Show option is a creative feature of this software. As many as 50 paintings can be shown along with optional titles. Each slide can be viewed for as long as one minute. The presentation is automatic. Once created, a slide show can be run by typing "N" when prompted.



Photo 1: Artist Chris Pappas prepares his canvas for a painting session using Painter Power.

Photo 3: Novices will probably favor abstract art as a means of expression until they gain control over the brush.



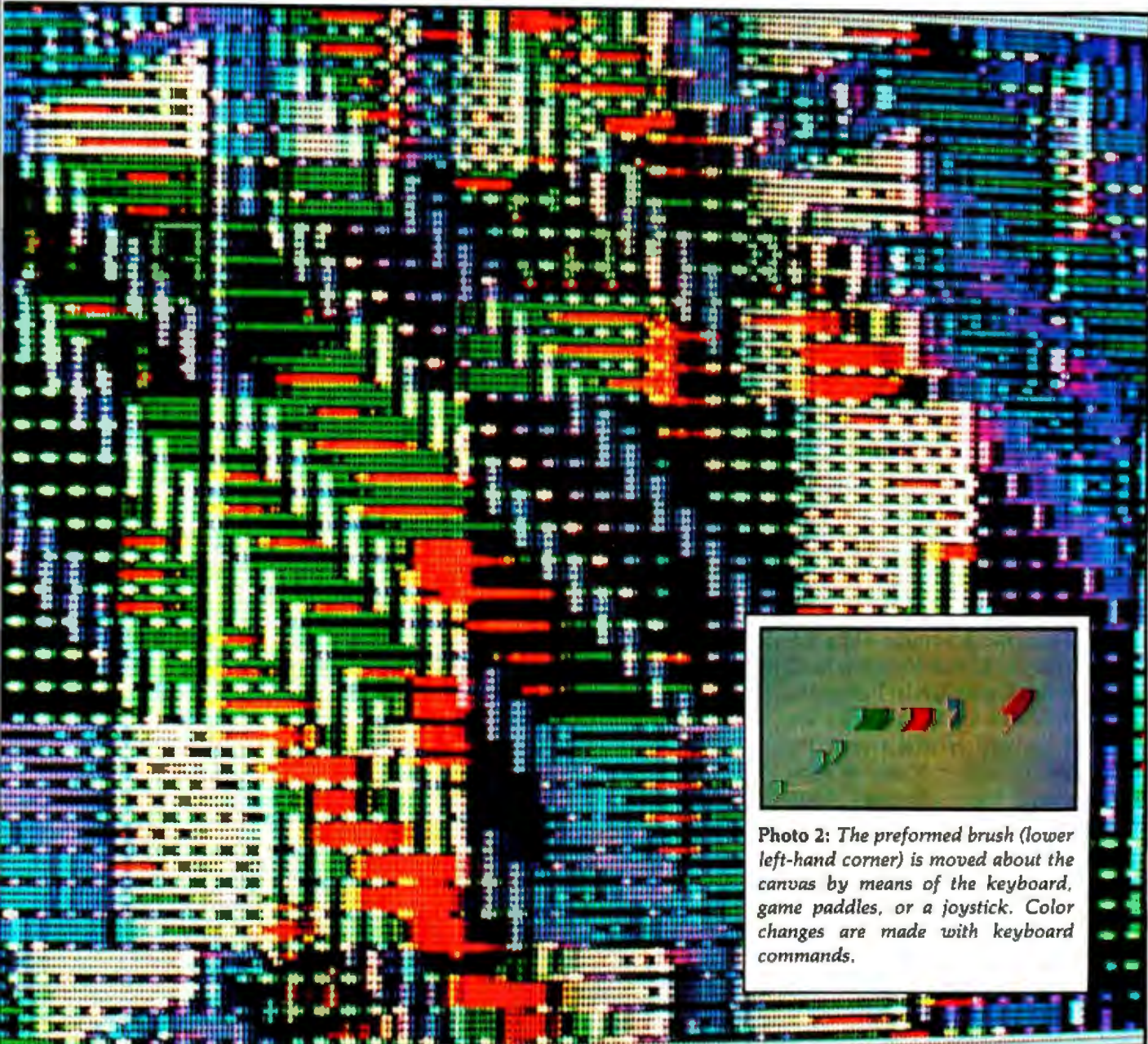
You and your loyal admirers can then view the gallery as many times as you like.

### Painter Power's Weaknesses

A major disadvantage of Painter Power became obvious when we tried to make a backup copy: the disk is locked. Shortly thereafter, we couldn't get the joystick to function correctly in the beginner mode. It took a letter, a telephone call, and two weeks to get a new disk. Replacements cost \$5 after the 30-day warranty period. Can you imagine the frustration an artist would feel if the joystick failed to operate in the middle of a masterpiece? It would be like running out of paint and having to wait for a new shipment.

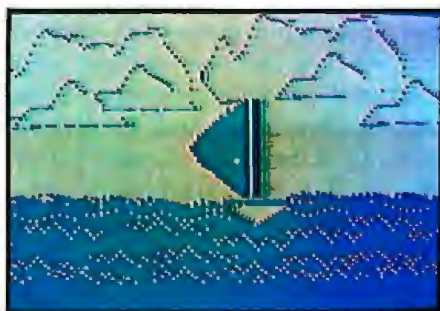
Another disadvantage was a lack of total control over the brush. We had several frustrating moments when the brush took off on its own across the canvas. This disad-



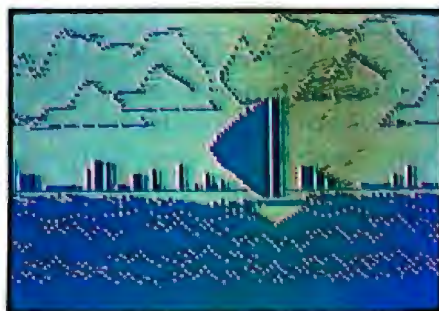


*Photo 2: The preformed brush (lower left-hand corner) is moved about the canvas by means of the keyboard, game paddles, or a joystick. Color changes are made with keyboard commands.*

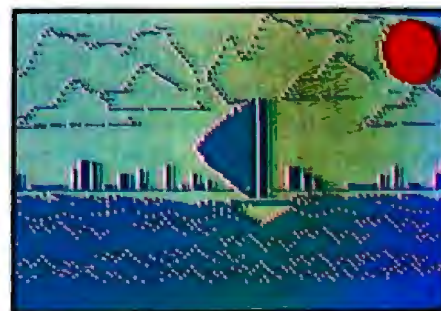
(4a)



(4b)



(4c)



vantage probably becomes less of a problem with experience in using the system.

### Conclusions

Despite its drawbacks, Painter Power is a real bargain for the price. It is a well-documented program with many deluxe features. ■

*Photo 4: A typical sequence in painting a scene. In 4a, the sailboat, water, and clouds were painted and saved on disk. In another work session (4b), the New York skyline was added to the scene. Finally, the sun was added to give contrast to the picture (4c). During the creation of these scenes a "mistake," such as an oblong sun, could be removed and repainted without destroying the whole canvas.*



## Ferment in Silicon Valley

---

Phil Lemmons  
West Coast Editor  
McGraw-Hill Publications  
425 Battery St.  
San Francisco, CA 94111

---

There is as much ferment—of a different kind—in Silicon Valley as in all of California's wine lands. Just as the soil and climate in Napa Valley are ideal for growing varietal grapes, the dynamism of Silicon Valley is ideal for starting high-technology companies.

Engineers and programmers will move from an established company whose top management decides against developing their ideas into products to an environment favorable to their work. Middle managers who believe their companies are neglecting a certain market segment look discreetly for engineers who can design a product that meets that segment's needs. Graduate students and faculty at Stanford and other universities in the area sometimes turn their best ideas into real products instead of dissertations and journal articles. Veteran entrepreneurs follow the evolution of technology and the emergence of new markets, trying to make a match. Venture capitalists patrol the towns along routes 101 and 280 in search of bright, energetic people with original ideas and plausible goals. In recent years, venture-capital firms have gone beyond bankrolling people who come to them with ideas; these firms now study the marketplace in search of unfulfilled needs

and then look for someone to start a company that will make a product that meets those needs. It's no wonder that new companies are constantly bubbling to the surface.

---

### How do companies get started? Profiles of four newcomers reveal different strategies.

---

A sampling of a few new companies illustrates the variety of startups in Silicon Valley. Victory Computer Systems introduced two new microcomputer systems at last fall's Comdex in Las Vegas. The Learning Company produces educational software for children aged 3 to 13. Adaptec develops and manufactures VLSI (very large-scale integration) controllers for Winchester disks. Evotek designs and manufactures high-capacity 5¼-inch Winchester disks. Although the products of these companies represent different technologies aimed at different markets, all four companies show the same imagination and drive and face similar challenges.

#### Victory Computer Systems

Roger Vass, a co-founder of Altos

Computer Systems of San Jose, California, had been walking the floors of computer shows for some time wondering what kind of system he should build. He knew that the microcomputer market was crowded, and as a former vice-president of marketing for Altos, he knew that he had to identify the right market niches before proceeding to design.

Vass's ideas gelled sometime between the Dataquest conference on the microcomputer industry held at Silverado, California, in January 1982 and the Hanover Fair held in West Germany the following April. Vass had considered building a desktop workstation using color graphics and voice input/output but decided that the time had not yet come for a successful product combining those technologies. In the end, he decided to build a multiuser system rather than an integrated workstation. "It's my conviction," Vass says, "that video-terminal technology and microcomputer technology are different. I'm not sure you can do a good job with both at the same time."

Instead Vass chose to build a "clustered, shared-resource computer with an unburdened 16-bit host." Victory's computers use not only a 16-bit microprocessor, but also a 16-bit hard-disk controller and an 8-bit



# BHART

Computers for Business, Home Applications, Resource Management Technology & Science  
NEW: 15-Day Exchange Privilege (See "TERMS" for details)



## GEMINI-10 from Star-Micronics

All the features of EPSON-FT plus backspace, continuous underline. List \$499 ONLY \$CALL!!!

Special: New prices  
**TOO LOW TO ADVERTISE!**

**NEW PRODUCT OF THE MONTH**

## A Generic Portable Computer?

-- No, not yet anyway. However if we as much as mention the brands of portable computers we now carry, and our super discount prices, we will have a lot of explaining to do!!! Before you buy ANY portable computer 16-bit or 8-bit, hard disk or floppy, you owe it to yourself to get OUR Price.



**SMITH-CORONA TP-1:**  
AT OUR PRICE, NO COMPUTER SHOULD BE WITHOUT ONE!

Daisy-wheel, letter-quality, interfaces all computers. Serial & parallel models at same low price. No less than 18 print-wheels—only \$6.95 each. List \$849 ONLY \$399!  
SPECIAL, ONLY this month...\$527  
NEW: Tractor for TP-1, easy retro-fit...\$159

## SOFTWARE FOR APPLE, IBM-PC, TRS-80, MOST CP/M TRY IT BEFORE YOU BUY IT!

SUPERCALC	\$295	CONDOR D/B III	650
SPELLBINDER	499	MONEYMASTER	199
MICROPLAN	450	SPELLGUARD	199

**YOUR CHOICE \$4995**

Receive a complete package, including manuals. Run the software, examine it, input data and print results as long as you want. A small part of the program (e.g. "save" or "update") is inaccessible in the original package, but if you decide to keep the software, and pay the balance of its cost, you will receive a special passkey to unlock that area so that all features of the software are at your command "For all computers."

**STAR Computer Systems BUSINESS PACKAGES:** Superior quality allows us to make an unprecedented commitment: **SATISFACTION GUARANTEED OR FULL REFUND WITHIN 30 DAYS!**

Legal Timekeeping Accounting Package.....\$950  
Property Management System..... 950  
Complete Accounting Package:  
GL A/R O/E A/P PAY 1250  
or each module individually at \$400

**Small Business System, including Inventory, A/R (w/Order Entry), A/P, Payroll, and General Ledger:** This system is more than enough for the needs of any small business up to 10,000 Ledger entries/month, handles multiple checking accounts and prints checks. Inventory notifies you when your stock has been depleted and prepares sales reports. Payroll calculates all Federal, State & Local taxes, allows all standard deductions plus 3 misc. deductions, prints all government-required reports and stores over 300 employees on a single 5 1/4" floppy. A/P stores 3000 transactions per month on a 500 KByte floppy, and A/R prints invoices and statements. Will work with Apple, TRS-80, IBM, most CP/M computers!

**COMPLETE ACCOUNTING PACKAGE** including the 5 modules described above...and you get a 30-day FREE exchange privilege for any of our other products, software or hardware at our current published ad prices!  
**\$499**

Displayed and sold at our Showroom, 12210 Michigan Ave., Grand Terrace, CA:



## MICRO-DECISION by Morrow Designs

Perfect desk-top computer  
• Z-80 1 Floppy standard 2nd optional Optional terminal or use your own • CP/M with user friendly shell • WordStar SpellChecker SpreadSheet Microsoft Basic 80 & BASIC List \$1195 to \$1790, Limited Quantity Call For Availability.  
NEW: Now with double-sided double-density Floppies (800 KB storage), and with Data Base Management Software. CALL For Availability!

## NEC APC



Extremely sophisticated graphics and color display (1024x1024 pixel) 16-bit (8086), 128K standard, expandable to 256K 1-2 1/2" Floppies 1 MEG each (run any CP/M program available on 8"). Detachable keyboard. Integral monitor (monochrome/color). Extensive software  
H01 Monochrome 1 Floppy List \$3298  
H02 Monochrome 2 Floppies List \$3998  
H03 Color monitor, 2 Floppies List \$4998  
CALL for appointment

# 3M FLOPPY DISKETTES

**SPECIAL OF THE MONTH COMPARE FOR QUALITY AND PRICE**

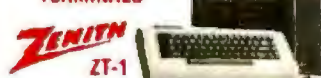
At our SPECIAL PRICE you would regret it later if you did not stock them NOW!!! All diskettes first quality, w/reinforced hubs, in individual envelopes and packaged in boxes of 10. Minimum order 5 boxes: LIMITED QUANTITIES

744D	5 1/4" s.s., d.d., soft/hard	List \$4.20	Special Buy \$1.95
745D	5 1/4" d.s., d.d., soft/hard	6.00	2.89
741D	8" s.s., d.d., soft/hard	5.55	2.65
743D	8" d.s., d.d., soft/hard	7.10	3.29

## INDEPENDENT SYSTEMS SELLERS:

Your systems sales do not have to be a struggle! Here's a new way for you to increase your sales and profits: Close the sale of any hardware/software combination. Then, rather than spend your precious time assembling and integrating all the individual components, give us a call and we will do this job for you. The complete system will be shipped to you ready to install, backed up by our guarantee of satisfaction! (Meanwhile, you can make another sale, play golf, go sailing or...)

## TERMINALS



A unique terminal. Connects directly to phone line without a modem and supports communication protocol to THE SOURCE, CompuServe, Dow-Jones. Can be used also as a local terminal with a RS-232 adapter. List ONLY \$495  
DEC VT 100 \$1375  
DEC VT 102 \$1320  
ADDS A1 \$529  
DUME 102 \$569  
WYSE \$799  
TeleVideo 970 \$1069

## MONITORS & PLOTTERS:

AMDEK 12" Amber	\$159
AMDEK COLOR II RGB, hi-resolution, 13"	\$699
AMDEK COLOR III RGB	\$382
ZENITH RGB high-resolution RGB	\$524
PRINCETON high-res 12" RGB	\$645
NEC 12" RGB high resolution	\$CALL

## INTERFACES & MODEMS, ETC.

Hayes Modems:	
SmartModem 300	\$214
SmartModem 1200	\$523
MicroModem II	\$269
MicroModem 100(S-100)	\$289
VENTEL RS-232 Modem	\$763
SSM modem 1200 Baud, autodial/rec	\$
MICROFAZER printer buffer	\$139
INTERFAZER 1/multi-users, up to 8 terminals & 2 printers!	\$239
TYMAC printer adapter /APPLE	\$89
GRAPPLER	\$129

## DOT-MATRIX PRINTERS:

NEC 8023A (parallel)	\$459
Mannesmann-Tally 160L	
NEW LOW PRICE	\$CALL
Okidata 83A 132 cpi (s/p)	\$649
Okidata 84-P 200 cps, & 50 cps	\$994
Okidata 92 just released	\$CALL
IDS Microprinter serial and parallel inputs, two printing speeds and printing grades, Draft/Correspondence	\$519

## Letter-quality printers:

Fujitsu 80 CPS (!)	\$2289
NEC 3510 33cps serial	\$1449
NEC 3530 same, parallel	\$1599
DIABLO 620 25cps ser	\$1094
BROTHER M4 1	\$794
DaisyWriter 2000 48K buffer!	\$1023
FRANSTAR emulates Diablo parallel	\$699
TOSHIBA 350, heavy-duty list \$	\$1649
OLJME NEW SPRINT II 40 cps LIST \$1681	SCALL
OLYMPIA ES100KRO Electronic Type-printer/Printer 17.5 CPS, s/p	\$1150
TEC Daisywheel 40 CPS, s/p	\$1389
TRACTOR for TEC	\$259

## 3 GRAPHICS SYSTEMS:



## COLUMBIA IBM-COMPATIBLE COMPUTER:

COLUMBIA 1600 16-bit 8088, accepts all IBM boards reads & runs all IBM software but has also additional Z-80 processor to run 8-bit CP/M. So compatible it can even use IBM keyboard! 128K, 1 parallel & serial ports standard, 8 expansion slots! COLUMBIA 1600 package computer as above + keyboard + CRT controller List \$3,835 \$CALL



Advanced color graphics under Z-BASIC, 16 bit (8088) & 8-bit (8085) 128K RAM, expandable to 768K (Expand to 192K for only \$180) Runs most IBM-PC software and CP/M.

ZF-100 128K RAM 8/16 bit, 1 floppy monochrome graphics	LIST \$2,399	SCALL
ZF-110 Similar to above, but COLOR GRAPHICS, 2 floppies	LIST \$3,499	SCALL
ZF-120 128K RAM 8/16 bit, 2 floppies monochrome graphics, integral display	LIST \$3,599	SCALL
NEW HARD DISK, 11.3 MByte, built-in LIST add \$2000 to 11/120 models above		SCALL



New, all the features of 802, PLUS • Larger Screen Nearly double the standard 12" video displays. Adj. adjustable positioning standard! • High-resolution graphics under CP/M. (640 x 240 pixels) standard! • 16 programmable function keys standard! • And the best of all: Priced at \$1000 under the 802! With all these features, the new TeleVideo computer is an outstanding buy!!! List \$2485 \$CALL For Availability

NEW: COD 15-Day Exchange Privilege (subject to terms below)

## ORDERS & INFORMATION: Member Better Business Bureau

Mo.-Fri. 9:00 AM-5:30 PM PST, Sat. 12:00 AM-5:00 PM PST

1-(800) 845-5555 CA, AK, HI call (714) 832-3443 TELEX 472-0127 ATTEN EMD

BANK REFERENCE: BARCLAYS BANK OF CALIFORNIA (213) 892-7244

AMERICAN EXPRESS, VISA, MASTERCARD

APO, FPO, INTERNATIONAL ORDERS ACCEPTED



# BHART

INC. P.O. Box 3791, Riverside, CA 92519

TERMS: Prices in this ad apply to prepaid orders only, reflect 5% cash discount off our regular sale prices. Personal checks allow 2 weeks to clear. Fortune-1000 companies, Universities and Government only 30 day net, based on our regular (non-cash) prices. COD based on non-cash prices and requires payment in full by Cashier's Check or Certified Check upon delivery. California residents add 6% tax. This ad supersedes all prior offers. Prices subject to change and offers may be withdrawn without prior notice. All merchandise new in original factory cartons, carry full manufacturer's warranty and are covered by full insurance during shipping. Absolutely no return on used or damaged items. Software returnable ONLY in UNOPENED original wrapping. We now offer 15-DAY EXCHANGE PRIVILEGE subject to 10% restocking charge on returned merchandise and excluding special order items. Add 3% for Handling, Shipping & Insurance (\$3.95 minimum)

CP/M is a registered trademark of Digital Research. Microsoft MultiPlan are trademarks of Microsoft Corp. CYMA is trademark of CYMA Corp. TurboDOS is trademark of Software 2000. Z80A is registered trademark of Zilog Inc. WordStar, SpellStar, CalcStar, DataStar, MailMerge are trademarks of MicroPro Company. APPLE is trademark of Apple Computer Inc.



microprocessor to handle input/output for each serial channel.

Once he made his decision, Vass moved quickly. Vass and Bill Daugherty, now vice-president for finance, used Visicalc to make projections and a business plan. In July 1982, Vass gave consultants the first contracts for the design of the two systems he planned to build. In August, Vass added electronics designer Jim Willott, who formerly worked at Zilog and Altos, to the Victory staff. Willott developed and oversaw further consulting contracts for the design of the Victory computers. Victory Computer Systems, which was not incorporated until September 7, 1982, announced its two systems at Comdex late in November.

The two Victory series of microcomputers differ only in the central-processing-unit board. Both systems use the high-speed VME (versa module European) bus, derived from the Motorola Versabus and adopted by Motorola, Mostek, Thompson,

Philips, Signetics, and other companies. (Victory expects to market 60 percent of its computers in Europe, the other 40 percent in the United States.) Both systems include integral fixed Winchester disks holding 20, 40, or 85 megabytes of data, and integral tape backup. Both systems can run CP/M on 4 terminals while running a 16-bit operating system on another 12 terminals. Both systems will be capable of running new friendly software that requires advanced graphics capabilities. The C. Itoh terminals, customized to Victory specifications, have options for color graphics with 640 by 480 resolution.

The Victory Spirit Series of computers is based on Intel's 80186 and runs operating systems from the Digital Research family. Victory made both choices in light of the many independent software development projects currently in progress for that hardware/software combination in the business market.

The Factor Series is based on the Motorola 68000 microprocessor and

runs the Unisoft Uniplus System 3 Unix operating system, which includes some of the enhancements to Unix developed at the University of California at Berkeley. The Factor Series targets the industrial-applications and process-control market. Because Vass sees that market as "software-development intensive," he chose the Unix operating system and its noted virtues as an environment for developing software.

With a couple of important qualifications, Victory Computer Systems is following the classic model of raising venture capital. In this model, start-up companies raise capital in three rounds. The first round is for organizing the company and designing a product. If that goes well, the outside capitalists will agree to finance a second round, which is for building a prototype. After the prototype is completed and working, the venture capitalists examine the existing competition and decide whether to invest in the third round, which involves manufacturing and distribution. In exchange for venture capital, the founders of start-ups surrender a percentage of their companies. Victory Computer Systems differs from this model in that its management team was able to put in a substantial amount of its own money and Vass was able to move into production much faster than the usual start-up. As well, Vass's background at Altos—his successful "track record"—reduced the percentage of the company that the founders had to surrender to the venture capitalists.

The greatest impetus in the founding of Victory Computer Systems was Roger Vass's willingness to use his own assets as capital. Now the company has opened new manufacturing facilities in the Berryessa industrial park in San Jose. The sales and executive offices remain in Gateway Place in the same city.

### The Learning Company

Ann Piestrup, founder of The Learning Company, is an educational psychologist who spent 10 years studying children's thought and language and especially the problem of how to maximize learning of basic

# AVAILABLE NOW



## FULLY CERTIFIED 1/4 INCH TAPE CARTRIDGE

DEI, the same company that leads the industry in 1/4 inch cartridge tape drives is now manufacturing fully certified 1600 bpi, 6400 bpi and 10,000 bpi/fci tape cartridges. Built and tested to exacting standards, our cartridges are guaranteed. Buy DEI cartridges for your most critical application requirements.

For price and delivery information, contact your local distributor or Data Electronics, Inc., 10150 Sorrento Valley Road, San Diego, CA 92121. Phone: (619) 452-7840, Telex 69-7118.

 DATA ELECTRONICS, INC.

skills. She decided to develop educational software "when I first saw that computers could do colorful, musical, playful things." Piestrup's studies had shown that active learning is the key to understanding, but when she looked at existing educational software for microcomputers, she saw little that actively involved the children or that exploited the computer's ability to generate immediate feedback using color graphics. In December 1979, Piestrup expressed her views and goals to Carolyn Stauffer, former director of the Apple Education Foundation. As a result, the foundation gave Piestrup an Apple II Plus with a language card, graphics, and SuperTalker and added \$1000 so that she could hire a programmer. Piestrup founded Advanced Learning Technology, a sole proprietorship, in order to receive the grant.

Piestrup and another expert on learning, Barbara Jasinski, designed the first program, specifying every screen on graph paper to show exactly what the low-resolution color graphics should do. Alice Chiang, a consulting programmer to International Business Machines, turned the specifications into an executable program. (Jasinski is now active in another new educational software company called Stepping Stones.)

Piestrup used the company's early experience as the basis for a proposal to the National Science Foundation and the National Institute of Education. Those two organizations were jointly awarding nine grants to both profit and nonprofit organizations for the advancement of the use of computers in education. Piestrup's proposal won a grant of \$130,000 and she founded The Learning Company to receive it.

At that stage, Piestrup brought in Dr. Teri Perl, a mathematics educator, and Warren Robinett, who has a master's degree in computer science from the University of California, Berkeley, and was a member of the original group of programmers at Atari. The programs resulting from the collaboration of Perl, Piestrup, and Robinett during the year's funding from the NSF/NIE grant are in the public domain, but they convinced

many people that The Learning Company's approach to educational software would make for commercial success.

Among those convinced were Tom Whitney, who formerly worked at Apple Computer Inc., and Jack Melchor of Melchor Venture Management in Los Altos, California. The Learning Company raised \$300,000 in January 1982 from the Los Altos venture-capital firm and individual investors. Since then the company has grown to a staff of 14, three of

whom are programmers. The Learning Company employs outside subcontractors as well. By January 1983, TLC had developed seven educational programs for children aged 3 to 13. The programs all use color graphics and are interactive, self-pacing, nonviolent, and easy for children to use on their own. Reception has been quite favorable. Both Apple and Atari market TLC products, and TLC has signed with 14 distributors, including Softsel, Micro D, and Bell & Howell. TLC is now in

## FRANCHISE OPPORTUNITIES.



### IT'S NEVER BEEN A BETTER TIME!

*The computer industry is experiencing a spectacular growth, by 1990 it will become a 20 billion dollar industry. Computer retailing was one of the few industries not seriously effected by the recent economic crisis.*

*Now... is a good time to consider a franchise opportunity with MicroAge, a leader in computer retailing. MicroAge has a proven "track record" with over thirty franchised stores throughout the United States and Canada. In an industry where experience is crucial, MicroAge has it, with six years computer retail experience and three years in franchising. It's just good sense to go with a leader.*

*If you're committed to success in computer retailing, it's essential you evaluate the MICROAGE COMPUTER STORES Franchise opportunity. Investment: \$130,000-\$200,000.*

*For detailed information about MicroAge "Franchise Opportunities," call (602) 968-3168 or write to:*

MicroAge Computer Stores Inc.  
1425 W. 12th Place  
Tempe, AZ 85281

**MicroAge**  
**COMPUTER STORE**  
"The Solution Store"™



the enviable position of deciding whether to accept a second round of venture-capital financing. TLC may not need more outside money.

### Adaptec

Adaptec was started to design and manufacture LSI circuits for producing inexpensive high-performance hard-disk controllers for microcomputers. Adaptec's founders came from large companies. Larry Boucher, Adaptec's president, spent 10 years at IBM working on high-performance input/output systems. Boucher left IBM to join Shugart Associates in 1979 and was soon responsible for developing integrated circuits and designing disk controllers. Boucher and Bernie Nieman, then an engineering manager at Shugart, developed the Shugart Associates System Interface (SASI) for connecting small computers and small hard disks. SASI has since been proposed as the ANSI (American National Standards Institute) Small Computer Standard Interface (SCSI).

Boucher's decision to found Adaptec was not instantaneous. "It grew," he says, "out of an inability to do what I wanted to do within the organization that I was working in." Shugart Associates was emphasizing disk drives and Boucher's primary interest lay in disk controllers and custom LSI chips.

When Boucher founded Adaptec early in 1981, he brought in Nieman and another former employee of Shugart Associates, Wayne Higashi, who had been manager of design assurance. This group of three ex-Shugart employees brought in John Hulme, an expert in LSI technology who had worked as an engineer and manager of semiconductor projects at Fairchild, Hewlett-Packard, and Siliconix.

Boucher, Nieman, Higashi, and Hulme agreed to contribute \$15,000 each and to work for one year without salary. They took some space in an old converted apartment building in Campbell, west of San Jose, and set about designing their first hard-disk controller. Ignoring noise from rock-band rehearsals and cabinet makers in adjoining apartments, Adaptec's

founders worked hard using their own S-100 personal computers and some surplus breadboards to develop a prototype. In the same period, Boucher refined Adaptec's business plan. "We did the numbers manually," Boucher recalls, "but we used Wordstar running on an S-100 system to write the plan." Within six months of the company's beginning, the prototype controller and the business plan attracted \$1,650,000 in venture capital.

In the two years since its founding, Adaptec has grown to a staff of 20 and expects to have 40 employees before the end of 1983. The firm now has its headquarters in Milpitas, California. Adaptec has received another \$4,300,000 in equity funding from four venture-capital firms: Lawrence, WPG Partners, of San Francisco; Technology Venture Investors, Menlo Park; New Enterprise Associates, San Francisco; and Merrill, Pickard, Anderson & Eyre, San Francisco.

Forecasting sales of \$10 million in 1983, Adaptec produces LSI products for Winchester-disk-drive control: chip sets for use in high-performance, multitasking applications and a single controller chip for use in personal computers. According to Phil Devin, an Adaptec product marketing manager, the company has "had evaluation-unit orders from all the major microcomputer companies and some of the major drive manufacturers." The Winchester Controller Chip will cost \$52 in large quantities in 1983 but that price is expected to fall to \$36 in 1984.

### Evotek

Sometimes venture capital comes through acquaintances. George Brennan, who has held senior management positions at Memorex, Honeywell, and the Marshall Electronics Group, knew some of the people at Ibis Systems in Los Angeles. Ibis makes high-capacity hard disks using thin-film media for use with IBM 3300 series computers. Brennan saw a need for high-capacity, high-performance 5¼-inch Winchester disks to be used with microcomputers, and he approached Ibis about licensing its

technology for the microcomputer market. Ibis agreed and soon Brennan was developing a business plan for Evotek.

After people at Ibis looked at the plan, they asked Brennan if they could send it on to two venture-capital firms that backed Ibis. These were the Hillman Group, reputed to be the largest of the venture-capital firms, and Rothschild Inc., of New York City. Brennan agreed and soon both venture firms backed Evotek, with the Hillman Group putting up \$3 million.

Evotek was incorporated in June 1981 with George Brennan as president. Burton Sisco, another founder and the vice-president of engineering, had worked with Brennan at Memorex. Gordon Steel, vice-president of finance, and Edmund Turek, vice-president of operations, also had experience at large companies.

Turek sought candidates for employment at Evotek who had experience designing 14-inch Winchester disks. From the beginning, Evotek's goal was to bring the technology for large hard disks down to the 5¼-inch size commonly used with microcomputers.

By June 1982, Evotek had prototypes ready to be exhibited at the National Computer Conference in Houston. Evotek then had 50 employees. In late November 1982, Evotek showed "preproduction" disk drives developed from the prototypes, and in January 1983 Evotek began shipping a family of hard disks that use thin-film media to store from 7.8 to 51 megabytes. The company now occupies a 50,000-square-foot building in the Sutter Hill-Fremont Business Center, a business park in Fremont, 10 miles north of San Jose. The number of employees had grown to 160 by February 1983.

### Looking for Venture Capital?

People looking for sources of capital may find the *Directory of Venture Capitalists* useful. The publication is available for \$20 from the Western Association of Venture Capitalists, Building 2, Suite 260, 3000 Sand Hill Rd., Menlo Park, CA 94025. ■



# HERE'S THE PERSONAL COMPUTER AD OUR COMPETITION DOESN'T WANT YOU TO READ.

It's an ad for NEC's APC™ Advanced Personal Computer. A solutions-oriented system that solves business problems in the simplest, most cost-effective way. The APC supports both CP/M-86™ and MS-DOS™. It can store more information than any system in its price range. In short, it's got the best price/performance of any personal computer. That's why our competition would prefer that you never see our system.

We asked some business men who sell systems why they preferred us. The reasons were clearly unique. They said the APC is not only powerful, but it's also easy to use. The 8-bit processor makes it easy to learn. The disk drive is simple to use. The application software is good.

They couldn't say any that well as we. They said they preferred us because of the good system.

"That APC of yours is the most powerful computer of any I saw. I don't know how you did it for that price."

"Now that I've used it for awhile, I see why you named it Advanced Personal Computer."

And that from businessmen who have tested the competition! When you see the APC, you'll understand why, although others, all of these businessmen picked NEC.

Our business software was optimized to take advantage of the APC's unique hardware features. That makes system operation faster and easier.

Our software includes a full set of general accounting packages, word processing, mailing list management, business planning, database management, and communications. And we're readying many more.

We're the only company to back our software with a unique unconditional guarantee. It will work or you get your money back.

Our high-resolution color graphics run circles, arcs and lines around everybody else. The APC screen images—lines and characters—are unprecedented in their clarity. Colors against resolution competitive systems often must.

comparing the APC for planning analysis, data management, word processing, and personal communications. The APC's unique hardware features, such as the 32-bit processor, give it an advantage over other systems.

A unique feature is the 128K bytes of built-in memory. The APC's keyboard and mouse are standard features you can't find on competing systems.

The APC's high-resolution color graphics are a real feature. The 128K bytes of built-in memory and the 1-million-byte floppy disk are standard features you can't find on competing systems.

See for yourself the personal computer our competition wishes had never been invented. The Advanced Personal Computer from NEC. Return the coupon to NEC Information Systems, Inc., 5 Militia Drive, Lexington, MA 02173.



**Now available with NEC hard disk.**

APC is a trademark of NEC Corp.  
CP/M-86 is a trademark of Digital Research, Inc.  
MS-DOS is a trademark of Microsoft, Inc.

Send me more information on the Advanced Personal Computer. **BE0583**

Name \_\_\_\_\_  
Title \_\_\_\_\_  
Company \_\_\_\_\_

Address \_\_\_\_\_  
City, State, Zip \_\_\_\_\_  
Telephone \_\_\_\_\_

**NEC**  
**NEC Information Systems, Inc.**  
5 Militia Drive, Lexington, MA 02173

**The Benchmark in World Class Computers**

Circle 325 on inquiry card.



# NAPLPS: A New Standard for Text and Graphics

## Part 4: More Advanced Features and Conclusions

*A standard way to encode color mapping and animation, closing with some predictions on how NAPLPS will be used by personal computers.*

---

Jim Fleming  
Unir Corporation  
Suite 106  
5987 East 71st St.  
Indianapolis, IN 46220

---

This is the fourth and final part of this series of articles on NAPLPS, the North American Presentation-Level-Protocol Syntax, a new communications standard for encoding both textual and graphics information. With this standard, graphics information can be sent from computer to computer, or from peripheral to peripheral, with little regard to inherent differences in the display capabilities of the various machines available. Such a standard will be particularly important for proposed mass-market data-communications systems such as videotex.

The first part of the series presented an overview of NAPLPS. The second part gave a detailed analysis of its basic features. And last month, some of the advanced features of NAPLPS were discussed. This month I will continue that discussion and conclude with some predictions about the future of NAPLPS.

---

### About the Author

Jim Fleming is a member of the ANSI X3L2 Committee on Character Sets and Coding. He is an independent consultant specializing in interactive computing systems.

---

These predictions are based on the premise that personal computing has not yet reached the majority of people in the world. For that to happen, personal computers must be very easy to use. Those readers who may be dreaming about the day when everyone will be assembling S-100 kits and toggling in bootstrap pro-

grams should probably reassess their thinking.

### Advanced Color Capabilities

As was mentioned in part 1, NAPLPS supports a variety of color modes. The most primitive one (mode 0) is quite portable and will be used in the majority of applications. As was previously described, colors are specified in color mode 0 by indicating the relative amounts of red, green, and blue that should be mixed to form the desired color.

Color modes 1 and 2, however, use a technique called *color maps* or *color tables*. As shown in figure 1, a color table is a set of indexes and their corresponding colors. These are tied together using the Set Color and Select Color commands. As can be seen in the figure, a given mixture of primary colors can be used more than once, and all the indexes do not have to be used. Note that the index value does not have any direct relationship with a hardware *drawing value* at this point.

In order to make an entry in the color table, you must first use the Select Color command to specify a

INDEX	COLOR		
	RED	GREEN	BLUE
0	0.2	0.3	0.0
4	0.0	0.0	0.0
5	0.5	0.8	0.8
6	0.0	0.8	0.8
25	1.0	1.0	1.0
26	0.5	0.5	0.5
27	0.5	0.0	1.0
31	0.0	1.0	0.0

Figure 1: A typical color table used with color modes 1 and 2 in NAPLPS. Each index value corresponds to a specific color. Note that the index values are arbitrary and that no index value appears more than once. Each color is represented as a mixture of the primary colors red, green, and blue.

certain index (see figure 2). This index value is encoded in the byte or bytes following the command and usually ranges from 0 to 63, although indexes as high as 16,777,215 can be encoded. After an index is chosen, you can then use the Set Color command to specify the mixture of red, green, and blue values that should be associated with the index.

When you want to select a color for drawing in color modes 1 and 2, you must specify the index for that color—not the actual color. The primary difference between modes 1 and 2 is that mode 2 allows you to specify a background color for text characters.

As shown in figure 3, when a picture is drawn into display memory, a drawing value is allocated to each index. This value is written into the display memory. The color information currently associated with each index is put into a hardware register associated with each drawing value, and anything drawn with that display-memory value will have that color. Note that a display value is allocated to an index only when drawing occurs. Also, each display value is allocated to only one index.

In order to create blinking and animation effects, the color associated with an index can be changed using the Select/Set sequence de-

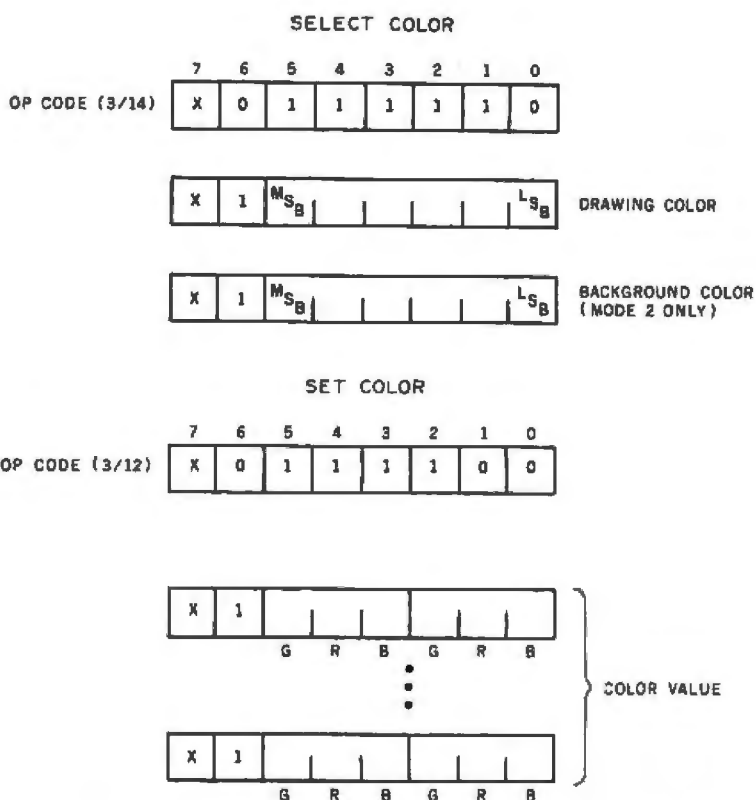


Figure 2: The Select Color and Set Color commands used to specify a color-table index value and a red, green, and blue mixture, respectively. (The codes 3/14 and 3/12 are an alternate way of indicating the hexadecimal numbers 3E and 3C.) In color mode 2, two indexes can be specified in the Select Color command if a background color for text is desired. The normal sequence used to load the color table is to first select an index and then set a color for that index. These actions cause a relationship to be established between an index value and a color. After a table is set up, each set color can be used by using the Select command. Also, the color associated with each index value can be changed by using another Set Color command.

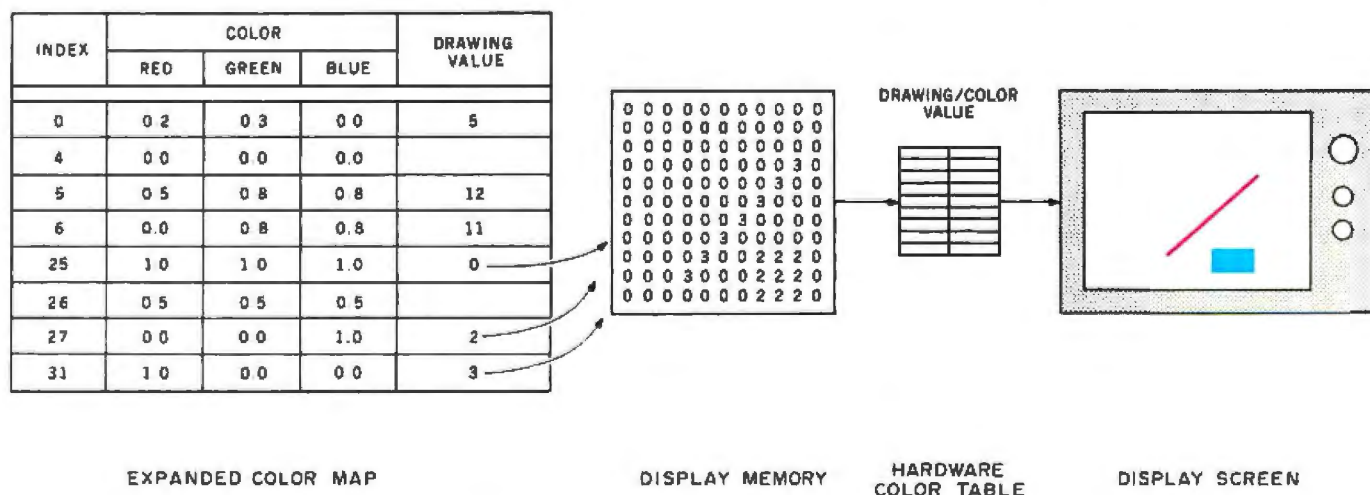


Figure 3: A typical color-table implementation. Note that special color-map hardware is required. The drawing value is the one used when drawing occurs in the display memory. It is an index into the hardware-based color map.



# CompuPro

SYSTEMS CENTER

**SYSTEM 8/16A** \$4395.  
**SYSTEM 8/16B** \$5245.  
**SYSTEM 8/16C** \$6745.  
 \* FULLY ASSEMBLED AND TESTED \*  
 Lease-Purchase/Maintenance Avail.

## MORROW DESIGNS

**MICRODECISION 2** \$1185  
 with/Microsoft Basic, Basic,  
 wordstar 3.0, Logical, Correct-It  
 speller, Personal Pearl Data base  
 manager, CP/M PILOT

**Cromemco** C-10SP P.C. \$1,500  
 CP/M-LIKE D.S., Word Proc.,  
 Spell Checker, Financial Planner,  
 32K Structured Basic

**SD Systems** Disk-Less Computer CALL

### BOARDS:

CCS Z80CPU \$ 239  
 FULCRUM 64K Static Ram  
 Bank Select/Ext. Address \$ 395  
 Scion Micro Angelo MA520 \$ 985

**SD SYSTEMS 3 8D SET**  
 w/1 yr warranty:  
 SBC 200 W/MONITOR PROM  
 VERSAFLOPPY II w/CP/M3.0 & BIOS  
 256 K EXPANDORAM III \$1295.00

### PERIPHERALS — ETC.

**LIBERTY FREEDOM 100**  
 (emulates Televideo 925) \$ 535.00  
**PARA DYNAMICS**  
 MAINFRAMES CALL  
**VOTRAX SPEECH SYSTEM** \$ 275  
**88M TRANSMODEM 1200** \$ 519  
 (HAYES COMPATIBLE)  
**TANDON 100-2 DS/DD Drives**  
 for IBM-PC \$ 245.00  
**QUME 8" Drives D.S./DD**  
 Thinline 242 \$ 445.00  
 Standard 842 \$ 445.00  
 ALL DRIVES ONE YEAR WARRANTY

**FULL DEALER SUPPORT**  
**VISIT OUR SHOWROOM**  
**Mrs. 9:00 A.M.-5:30 P.M. M-F**  
 Subject to Available Quantities  
 Prices Quoted Include Cash Discounts  
 Shipping & Insurance Extra  
 Circle 399 on Inquiry card.



14425 North 79th Street, Suite 8  
 Scottsdale, Arizona 85260  
 TELEX 168026  
 TECHNICAL 602-991-7878  
 SALES 800-826-3138

### BLINK

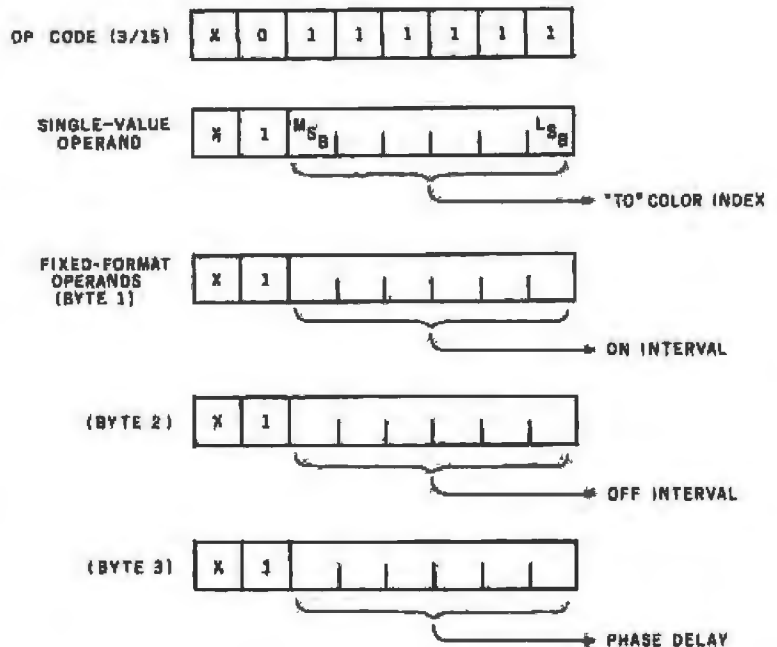


Figure 4: The Blink command is used to establish one or more asynchronous blink processes. These processes automatically modify the contents of the color map. In short, the Blink command causes the color of the current color index to be temporarily changed to that of the "to" color index. The on, off, and phase-delay times are specified in 1/10-second resolution, which allows this system to be compatible with both North American (60 frames per second) and European (50 frames per second) television systems. These times are used to control how often the color map is modified.

scribed above. This change will cause everything on the display screen that has been drawn with that value to change color.

### Color-Table Animation

The Blink command is used to set up automatic color-table animation sequences. As shown in figure 4, the Blink command is followed by several bytes that indicate a color-table index, an on interval, an off interval, and a phase delay.

When the Blink command is specified, a process is established that coordinates the timing and interaction that occur between two color-table entries. The "from" color-table index is set to the current color index (i.e., the last selected index). The "to" color-table index is the index specified in the byte immediately following the Blink command.

As shown in figure 5, the blink processes are independent asynchronous activities that copy values from one entry in the color table to another.

During the on interval, the color corresponding to the index specified by the "from" color is saved in an area of memory called the process-control block. Then the color corresponding to the index specified by the "to" index is copied to the "from" index. If the new color is different than the old color, a visual result will be seen.

Similarly, during the off time, the color information saved in the process-control block is restored to the color index specified by the "from" color.

For simple blinks or flashing, the "to" color index can specify a constant color that is used for copying purposes but not drawing. At this point it should be clear why hardware drawing values are not allocated to an index until actual drawing occurs. This technique allows each screen-based color to have a unique "from/to" color pair without requiring that colors be shared.

If you are following carefully, you will note that, at the beginning of the

# Compare the Olivetti M20 with any other personal computer, and you may win a trip to the Italian Grand Prix.



When you compare the Olivetti M20 with any other personal computer on the market, you'll find there's really no comparison. Because the M20 has more computing power at a smaller price than anyone else. That's right, anyone.

And we can prove it. Just take the Olivetti Challenge. When you're finished, simply drop it in the mail. Chances are, you might win one of the many exciting prizes in the Olivetti Challenge Sweepstakes.

Or, drop by and see an Olivetti dealer and pick up an official entry form. There's no purchase necessary. But hurry, the offer ends June 30, 1983.

## GRAND PRIZE

An expense-paid week for two at the Italian Grand Prix in Monza, Italy.

## FIVE SECOND PRIZES

Puch 12-speed European racing bicycles.

## TEN THIRD PRIZES

Seiko Analog/Digital racing watches.

## FIFTY FOURTH PRIZES

Handsome racing jackets.

Whose personal computer offers...	Olivetti M20 Personal Computer	Challenger #1	Challenger #2	Challenger #3
Microprocessors: 16 bit Z8001/8086; 16 bit BUS	✓			
Memory: 128K-512K	✓			
Disk Storage: 320K-640K floppy disks; 11MB Winchester	✓			
High Resolution Graphic Display: 512 X 256 monochrome or color	✓			
Operating Systems: PCOS, CP/M80, 86, 8000, MSDOS	✓			
Communications: parallel, serial and IEEE interfaces, TTY, RBTE, 3270, real-time clock	✓			
Application Software: integrated WP with data base and communications, integrated electronic work sheets with graphics, integrated accounting packages and vertical market packages	✓			
Base Price: * under \$3,000	✓			

\*Includes 128K, single 320K drive, monochrome graphic display, serial and parallel interfaces, and real-time clock.

NO PURCHASE NECESSARY

For the dealer nearest you, call 1-800-447-4700.  
In Alaska and Hawaii, call 1-800-1-17-0890.

OFFER ENDS JUNE 30, 1983

**DOCUTEL Olivetti**  
CORPORATION

Ohio residents may obtain an official entry form by sending a self-addressed stamped envelope to Olivetti Challenge Free Entry, P.O. Box 789, Madison Square Station, New York, NY 10159.



## BLINK PROCESSES

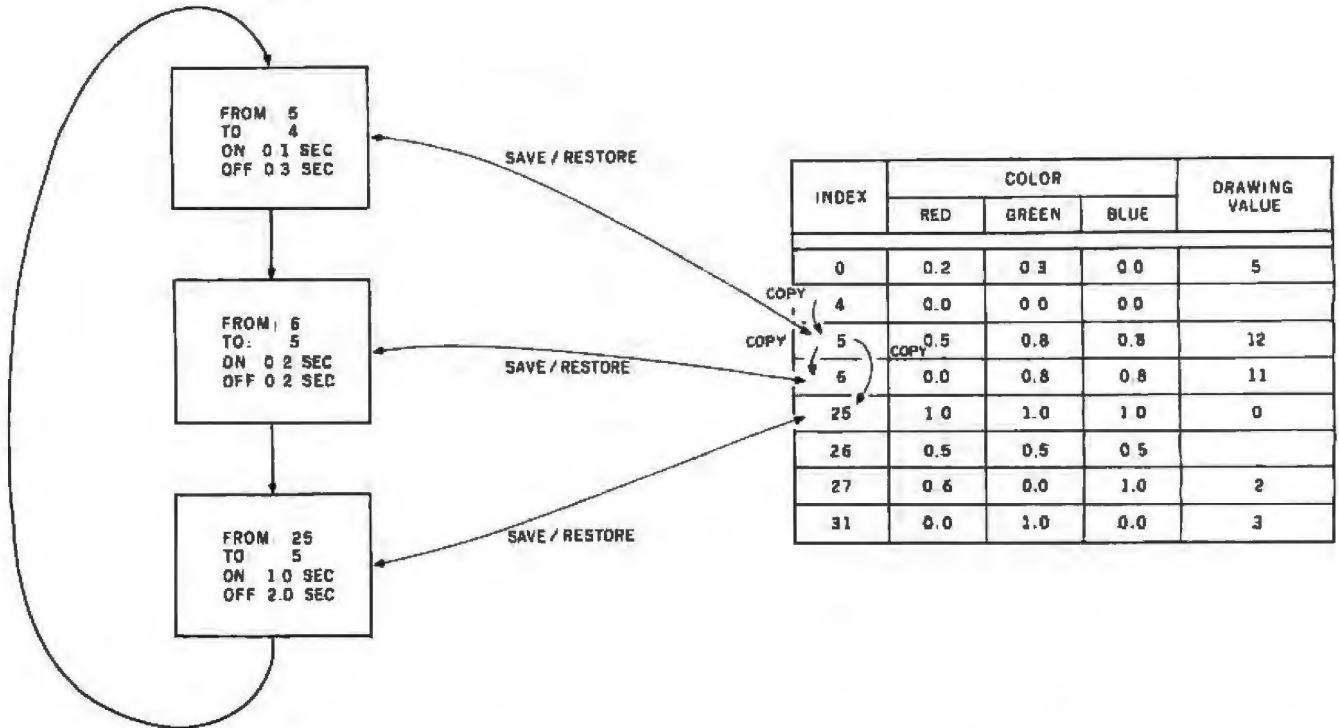


Figure 5: An example of three blink processes used together. The first process saves the contents of the color map at index 5 and then copies the contents of index 4 into index 5. After 0.1 second, the original contents of index 5 are restored for 0.3 second. The second process saves the contents of the map at index 6 and copies the contents of index 5 into index 6. Note that the second process can copy the contents of index 5 during the time it has been changed by process 1, causing a variety of effects. The third process, which runs very slowly, saves the contents of index 25 and also copies the contents of index 5 into index 25. When changes are made to the colors in indexes 5, 6, and 25, the corresponding hardware color-map registers 12, 11, and 0 are changed, causing visual changes to the screen.

on time, the color in the "to" color index is copied to the "from" color index. This copy is made independently of any blink activity that may be set for the "to" color. Thus, this copying could occur during a time when the "to" color has been changed by another blink process. The result is that multiple blink processes can be set up to allow colors to ripple around the color table in regular and irregular patterns. These patterns can be used to produce dramatic animation effects under full control of the terminal and without the need for host interaction.

These animation effects, plus the other features described in the previous articles, should establish NAPLPS as the most extensive information-exchange protocol available. As time goes on, it is expected that NAPLPS will replace ASCII (American National Standard Code for Information Interchange) as the standard for information inter-

change. As this occurs, almost every area of computing will be affected. In order to prepare for this impact, we need to look into the future to see how NAPLPS will help shape the world.

### Predictions and Conclusions

If one sits back and attempts to predict the future of personal computing and information exchange, some obvious predictions come to mind:

1. Integrated text and graphics will be essential in all visual information exchange.
2. Personal computers must be designed to be so easy to operate that a casual user can begin doing useful things immediately.
3. A personal computer will be used as a link to the rest of the world rather than a diversion from it.
4. People's efficiency will be increased by allowing concurrent activities.

5. The average personal computer user will be more of a consumer than a producer.

It should be noted that I have said nothing about the size of memory chips or the density of disk drives. These predictions involve only functionality and the user's view of computing capability. I am a firm believer that the consumer will be the ultimate decision maker when the fate of the personal computing field is decided. These users will make these decisions based on what they see, hear, and touch. They will not make their decisions based on how many chips are in a box or whether interrupts are enabled during DMA disk transfers.

Using these predictions and a little imagination, we can hypothesize what the ultimate personal computer will be like. Figure 6 illustrates my view of such a machine. Four functional servers are clustered around a central switching, control, and com-

# ORCA/M™

*The best 6502 Assembler in  
the World*

Hayden's *Object Relocatable Code Assembler for Micros* (ORCA/M) gives you the kind of high-level support you'd only expect to find on a main frame. Now you can develop sophisticated applications with the speed and ease of a high-level language, yet retain the control and efficiency that only assembly language can give.

## The Assembler

### Macro language features:

- Conditional assembly of source and macro files
- Separate source and macro files
- Nestable macros
- Parameter mid-string and string search functions
- Symbolic parameter assignment
- Numeric, string, and boolean type parameters
- Parameter subscripting
- Global communication between macros
- Macro expansion loop control
- Count, length and type parameter-attribute functions

## Extensive Macro Libraries

### Memory Constant Declarations:

- Integer
- Character
- Four-byte Integer
- Hexadecimal
- Floating Point

### Relocatable object module generation

### Fast assembly directly to disk

### Program segmentation:

- Selectively assemble individual subroutines
- Global and local scope of symbols

## The Linker

### Produce executable binary files from relocatable object modules

### Link routines from library files

### Link subroutine re-assemblies

### Define a new origin for previously assembled code

### Invoke at assembly time or by command

### Subroutine libraries:

- Floating point and double-precision routines
- Transcendental functions
- Hi- and lo-res graphics
- Multiple-precision integer math
- Input and output

## The Editor

### Co-resident screen editor:

- Global search and replace
- Block move
- Entry of non-keyboard characters

### Supports lower case adapters and shift-key modification

### 80-column: horizontal scrolling with 40-column displays

## The System

### Monitor: transparent control of system from one command level

### Extended Disk Commands:

- File copy
- File undelete
- Catalog sort
- Wildcard filenames

### Disk ZAP: Built-in disk sector editor

### Optimized DOS 3.3 compatible operating system

### Operating system interface:

- Supports a variety of configurations
- User-modifiable to allow linkage of custom drivers for peripherals

### 64k RAM supported, 48k required

This unique array of features and functions speaks for itself: the power of ORCA is unsurpassed.

All features are documented clearly and extensively. Source listings for the subroutine and macro libraries, as well as the operating system, are included.

**ORCA.** If you're serious about developing 6502 software, it's the one to have.

Available from your local dealer, or call:  
800-343-1218

(In MA call 617-937-0200)

ORCA/M: 21609

Apple II disk, 48k, DOS 3.3

Two drives and 64k

recommended

**Introductory Price: \$99.95**

Circle 528 on Inquiry card.

**HAYDEN**

**SOFTWARE**



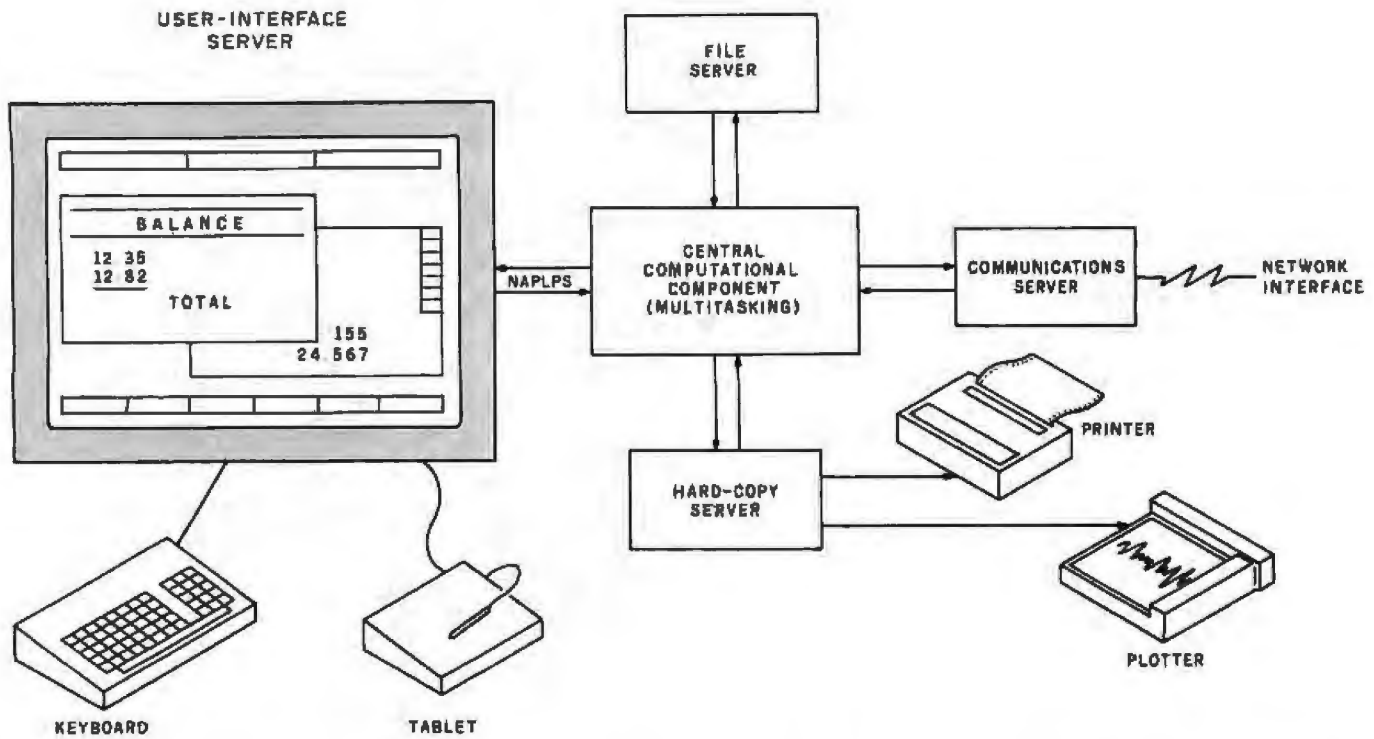


Figure 6: The ultimate distributed personal computer system for the serious user. Each of the components is an independent entity, each with the power of a typical personal computer available today. The diagram illustrates functionality and does not necessarily imply physical partitioning. NAPLPS is the language used between all components, especially between the User Interface and the Central Computational Component. The User Interface may be able to run a variety of local screen-based text and graphics editors without informing the Central Computational Component.

putational unit. These four functional servers are *not* meant to indicate peripherals hanging on a microcomputer. In fact, they may instead be integrated into one unit. To put things into perspective, I imagine that each of the functional servers would have the complexity equal to or greater than that of an IBM Personal Computer.

The Hard-Copy, Communications, and File Servers are straightforward. Ideally, the Hard-Copy Server would support integrated text and graphics in high-resolution black and white. Color hard copy would be desirable, but I could probably live without it. The Communications Server would provide all links to off-site services through modems and local networks. The File Server would provide the typical storage and retrieval functions. Features such as automatic redundancy and backup might be transparent to the user. Database-management capabilities could be built into the File Server, which would be responsible for organizing

the database in the optimum way based on the user's answers to certain queries.

The User-Interface Server would be an extremely high resolution color-graphics display with a variety of user-input devices. All input editing would be handled by this server. The user should be able to enter text and graphics with equal ease. The ability to point to objects on the screen should be available from any of the input devices. And the User-Interface Server should be able to support multiple *windows*, representing various concurrent activities currently in progress.

The Central Computational Component would be a multitasking system with the computational capability similar to most multiuser timesharing systems. A process (or task) would be active for each window in use in the User-Interface Server. Additional processes could be created to perform tasks for the user.

The Central Computational Component would also be responsible for

coordinating all server-to-server interactions. It would also act on the user's behalf if some attention is needed and the user is busy. For example, electronic mail received via the Communications Server would be stored in the File Server without the user becoming involved. The user would be able to retrieve the mail at a later time.

Given this model of an ultimate personal computer, it becomes useful to begin charting an evolutionary path from our current position to this ultimate system. It is obvious in figure 6 that the User Interface must be present in the system before any other component. It is not obvious that the user needs any other component as long as the User Interface has access to a Central Computational Component.

The first step along the evolutionary path is to give the user a User-Interface Server. From that day forward, the user's view of the system begins to form. (The old adage "love at first sight" can be applied to com-



# MEET THE JUGGLERS.

And what a unique troupe they are. Mullen's jugglers will keep your operation clicking, buzzing, stamping, whirring and whooshing. They manipulate everything from fluorescent tubes to hydraulic presses. Mullen components don't drop the ball, either.

If you ever feel like you have a thousand things to juggle, get help from these STD pros.

**They're versatile. They're reliable.**

**They're Mullen.**

## NEW PRODUCTS

(Qty. 1-3 prices)

### STD 801 and 811 Card Cages

Black anodized aluminum card cages, with motherboard and card retainer bar for use in high vibration areas. Specify bottom mount (801) or back mount (811). \$225 (8-slot motherboard), \$265 (12-slot).

### STD 881-8 "NEMA 12" Computer Enclosure

Intended for unfriendly industrial environments. Splash-proof box (oil and dust tight) includes 8-slot motherboard, card cage, card retainer bar, switching power supply (+5V @ 6A, +12V @ 1A, -12V @ 1/2A), 115V AC input. **Introductory offer: \$595** Options: 12- and 16-slot motherboards, stainless steel enclosure, EMI/RFI shielding. Call for quote on options

## STD BUS COMPONENTS

(Qty. 1-3 prices)

**STD 001.** Flat cable terminated prototyping board \$49.

**STD 002.** Dual 18 edge connector terminated prototyping board. \$554.

**STD 003.** Terminal block terminated prototyping board \$59.

**STD 101.** Extender board. 8.4" long. \$59.

**STD 201.** 8-channel TRIAC (4A/117V) output board \$229.

**STD 211.** 8-channel opto-isolated line voltage input board \$194.

**STD 221.** 8-channel SPST reed relay output board \$169.

**STD 231.** 8-channel low-voltage isolated input board, \$194.

**STD MBD\***. 8-slot (\$135) or 16-slot (\$175) high-speed motherboard

**STD 16K RAM\***. 16K X 8 static memory card \$325.

**STD CPU Z\***. 4 MHz Z80 CPU board with serial I/O and sockets for 8K of RAM/ROM \$335.

For more information, call Mullen Computer Products at (415) 783-2866 or write to MCP Inc., Box 6214, Hayward, CA 94544.

These dealers also carry Mullen products: **Jade Computer Products**, 4901 Rosecrans Hawthorne, CA 90250, (213) 973-7707; **Priority One Electronics**, 9161 Deering, Chatsworth, CA 91311, (213) 709-5111; and **Advanced Computer Products**, P.O. Box 17329, Irvine, CA 92713, 800-854-8230

\*DEM products manufactured by CompuPro - a Godbold Company, distributed by MCP Inc., a Godbold affiliate. All prices subject to change without notice. **Circle 320 on inquiry card.**

The logo for MCP Inc. features the letters 'MCP' in a bold, white, sans-serif font, set against a blue rectangular background with a white border.



# Monte Carlo Card

THE DISTINGUISHABLE CARD FOR THE DISCERNING USER.  
**FIVE FUNCTIONS ON A SINGLE BOARD**

- ★ 64K to 1 Megabyte RAM Memory
- ★ ONE IBM Compatible Centronics Parallel Port
- ★ ONE IBM Compatible RS-232 Serial Port
- ★ Clock/Calendar (Perpetual Time Keeper)
- ★ Dual-Port Joystick Interface
- Future Upgrade Option: Plug-On Direct Connect Modem
- The Clock/Calendar has full alarm features and 1/100th second timing.

This card is the Ultimate  
IBM Peripheral.  
See Your Local Dealer.

Available  
**NOW**

The Monte Carlo Card was ingeniously engineered to ensure that the maximum possible variety of the most sought-after features demanded by PC users was amassed upon a solitary board. Providing users with the best value for money, functionality, reliability, and flexibility, were our primary goals, which will enshrine the Monte Carlo Card as the premier expansion board for any PC user.

See Your Local Dealer or Call

## I-C Magic +

### GRAPHICS

- Full Color or B/W Tones
- HIRES and Medium Res.
- 4-Dot Sizes for Blow-ups
- Reproduce Graphics from Screen to Dot Matrix Printer, Full Screen or Sub-Section
- Rotation, Color Hue Selection
- Shift PrtSc Graphic Dumps
- Color on Prism 132/80
- Operates on EPSON/NEC/C-ITOH PRISM/OKIDATA

### SPOOLING

- Selectable buffer 1K to 64K
  - Serial or Parallel
  - True Background spooling at your fingertips
  - Save processor time
- SAVE  
MONEY
- Buffers all text and graphics

### TERMINAL

- RS-232 Direct or Modem connection
- Full terminal capability on a chip! Printer Hardcopy/Echo
- Full input/output buffering
- Background terminal features
- Easy for user customization

FOR YOUR IBM PC

IBM is a registered trademark of International Business Machines, Corp. MBI and I-C-Magic are trademarks of Microcomputer Business Industries, Corp

**MICROCOMPUTER  
BUSINESS  
INDUSTRIES  
CORPORATION**

**MBI**

ADMINISTRATIVE OFFICES: 1019 8TH STREET, GOLDEN, COLORADO 80401 (U.S.A.)  
TELEPHONE: (303) 279-8438 Circle 538 on Inquiry card.

TWX: 910-934-0191

# Monte Carlo Card

The distinguishable card for the discerning user

The only true FIVE function card  
for the IBM Personal Computer

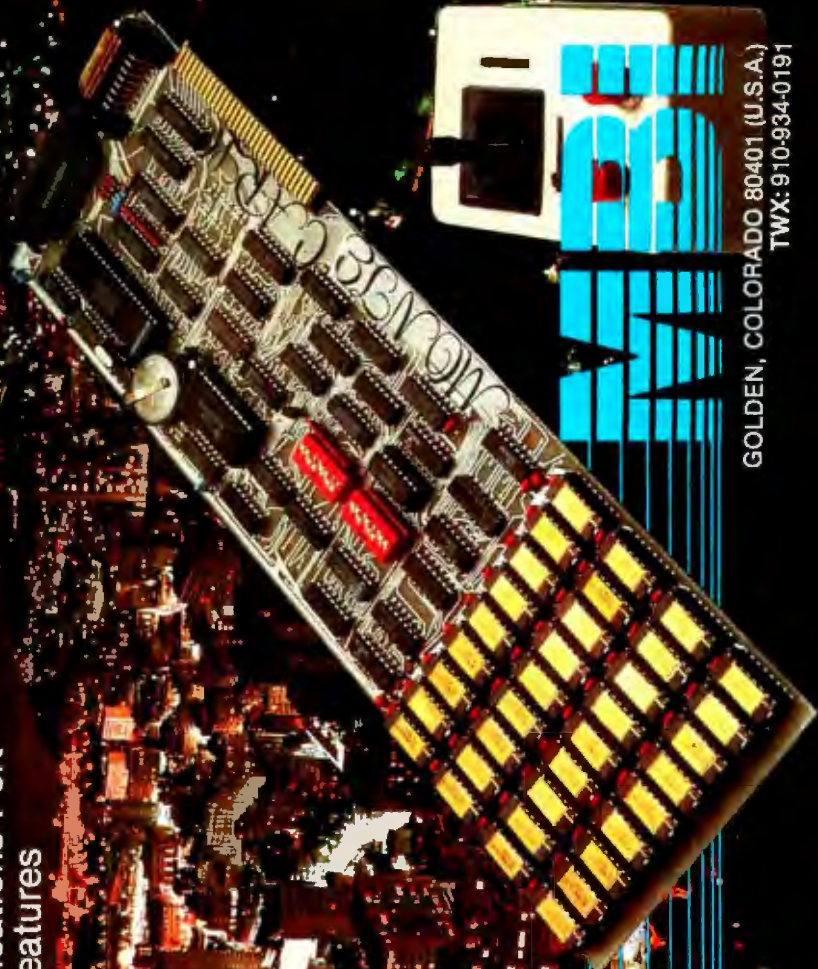
- 64K to 1 Megabyte of Memory
- ONE IBM Compatible Centronics Parallel Port
- ONE IBM Compatible Asynchronous Communications Port
- Clock/Calendar (Battery Backed) with Alarm Features
- Dual-Port Joystick Interface
- **Future Upgrade Option:**  
Direct Connect Plug-On Modem

Monte Carlo

**MICROCOMPUTER  
BUSINESS  
INDUSTRIES  
CORPORATION**

ADMINISTRATIVE OFFICES: 1019 8TH STREET,  
TELEPHONE: (303) 279-8438

GOLDEN, COLORADO 80401 (U.S.A.)  
TWX: 910-934-0191





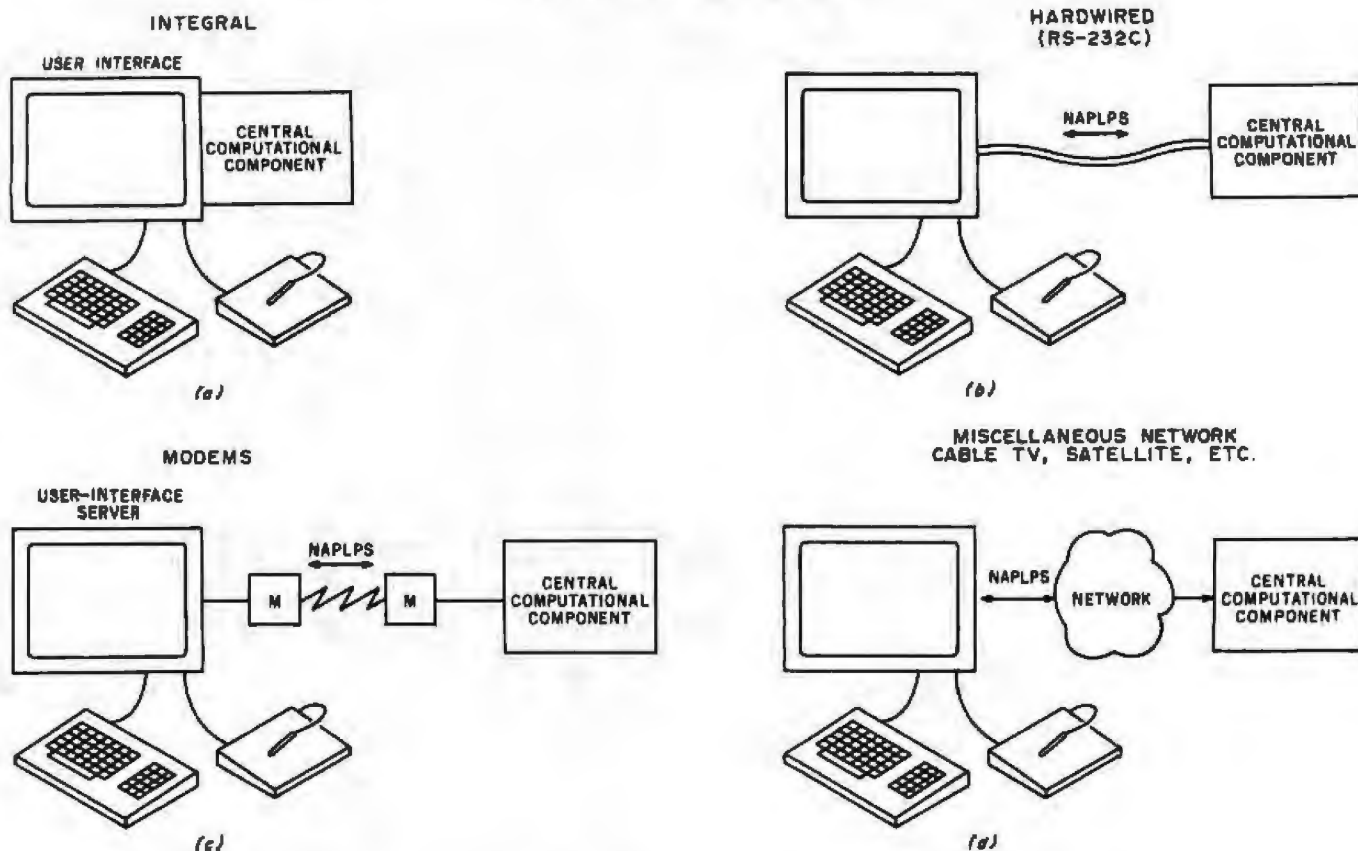


Figure 7: The User-Interface Server can be connected to the Central Computational Component in a variety of ways. A modem or a network arrangement allows a person to start using a User-Interface Server long before the Central Computational Component is needed.

puters as well as people.)

Because of this user view that is established, one is driven to give the user as much capability from day one as is economically feasible, even at the expense of not providing other components in the system. This strategy is compatible with the fact that a user will judge a system primarily from interaction with the User-Interface Server.

Once a user is given a User-Interface Server, another serious situation develops: the user will not want to give it up. This implies that when the user eventually obtains a Central Computational Component, he or she will expect the User-Interface Server to work with the new component.

What this all comes down to is that the user should be given the ultimate text/graphics terminal before any other component. The capabilities of

this terminal should be standardized, and everything but the kitchen sink had better be available, because the capabilities of that terminal will help shape all future services. And the interface to that terminal must be clearly defined *before* any terminals are given out.

This is where NAPLPS becomes involved—as the text/graphics terminal-interface protocol for the User-Interface Server. As shown in figure 7, a NAPLPS terminal can be connected via a variety of mechanisms to a Central Computational Component. From the first day of use, the user sees a certain set of capabilities and begins to get used to the local editing features available in the terminal. If a user is connected to a host via a modem, all computation and information are obtained from the remote host. The spectacular text/graphics displays are there from the

beginning and are not something the user must dream of having.

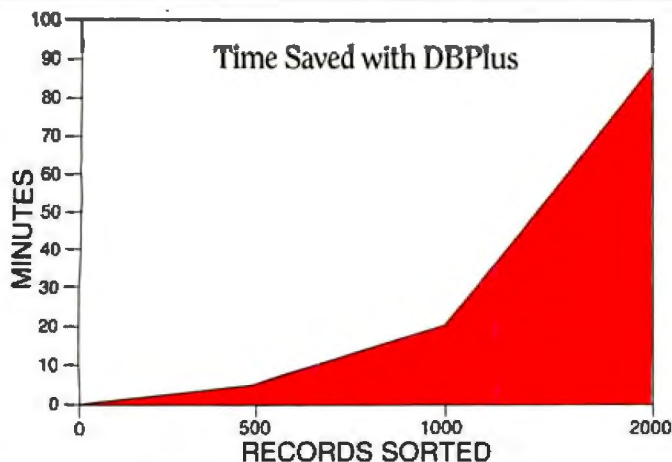
From the host computer's point of view, the user is now a constant, a known entity with a standard interface. Services can be developed with the assumption that the user will not be a moving target. This stability gives the developers of the host system more incentive to develop more services. More services attract more users, and more users of course mean more money, etc., etc.

The user begins to consume the prepackaged information and services. Most users may not want to become programmers or system administrators; they merely want to accomplish a task and get on with the rest of their lives.

At some point in life, however, a user may become more sophisticated and require a dedicated processor. A Central Computational Component

# DBPlus™

## **SORT, COMPRESS, and TRANSFORM dBASE II™ DATA FILES**



If you are serious about dBASE II™ you need DBPlus. This program runs outside of dBASE II™ and performs the following important functions on dBASE II™ data files:

- Sort
- Compress/Decompress
- Transform

DBPlus™ is designed to free you from the chore of typing or memorizing a new language. In most cases all you have to do is move the cursor to the next menu item and press return!

### **SORT**

DBPlus™ can sort a data file up to 15 times faster than dBASE II™ on a single field; 32 fields may be sorted in a single pass and each additional field requires 1% more sorting time.

### **COMPRESS/DECOMPRESS**

A copy of any dBASE II™ data file can be produced which is only 30% to 40% of the original size.

The compressed file will save you transmission time and phone costs when you send a data file over a modem.

Making backup copies of large data files can use up many floppy disks. Compressed files will save you space in archival storage.

### **TRANSFORM**

You can now modify the structure of any data file by adding, deleting, and modifying fields without any programming knowledge.

DBPlus™ can also create a new file which is compatible with WordStar/MailMerge.™

**Now retailing for \$125.**

Manual and demo disk may be purchased separately.

*Dealer and distributor inquiries invited!*

### **HumanSoft**

661 Massachusetts Avenue  
Arlington, Mass. 02174  
(617) 641-1880

dBASE II is a registered trademark of AshtonTate, Inc.  
WordStar/MailMerge is a registered trademark of MicroPro, Inc.  
DBPlus is a registered trademark of HumanSoft

Circle 218 on inquiry card.



can be purchased by the user and added to the original User-Interface Server. Many of the services that had been available on the remote host will probably be available on the dedicated processor.

Additional servers could be added to the Central Computational Component as the user desires. One interesting thing to note is that the display capabilities of NAPLPS are such that the Hard-Copy Server can use the same protocol. Also, because the File Server will certainly be able to store NAPLPS, we see that a complete, integrated personal computing system begins to emerge. NAPLPS becomes the common language in the system for information interchange.

The addition of the Communications Server is the mechanism by which a user and personal computer become an entity on a local-area network. Keep in mind that the addition of the Communications Server allows a far more sophisticated system than when the user was *remoted* to a host via an unspecified network. The *remoting* was done to create the link be-

tween the User-Interface Server and the Central Computational Component. The Communications Server was not involved. Figure 7 illustrates this difference.

If I have not lost you completely and you are good at reading between the lines, it should be clear that NAPLPS is a small part of a large, integrated personal computing system. Many of the parts of that system still need to be specified and implemented. Luckily, the part of most concern to users is quite mature and currently available in the marketplace. I predict that in three to four years systems similar to the one I have described will be commonplace in personal computing.

Those of you who are familiar with the various videotex systems that have been proposed may realize that my ultimate personal computer would be fairly compatible with such systems. In most videotex systems, a network of inexpensive home terminals with enhanced graphics capabilities are connected to a host computer. Ideally, the manufacturers of

these terminals will design them so that at some later date the user can add the above-mentioned servers.

As I said at the outset of this article, personal computing has not yet reached the majority of people in the world—but someday it will. If you are currently a personal computer user, you should feel honored to be among the pioneers. As the personal computing field begins to evolve into a mass-market, consumer-oriented, network-based information system, do not be surprised if you begin to feel like the odd man out. Also, do not be surprised if one day your neighbors invite you over to see their new computer that costs one fourth to one tenth the price of yours and has access to thousands of services via networking. And do not get upset when you find out that your neighbors cannot tell you which processor their computer uses or what transmission rates their modem supports. Instead, just feel good about the fact that you know a little bit about the language their computer uses to talk to the rest of the world. ■

# INTERSTELLAR DRIVE™

## A SOLID STATE DISK EMULATOR

**Save valuable time!**  
5 to 50 times faster  
performance than floppy disks  
and Winchester drives



**SAVE MONEY!**  
Increase your  
computer's productivity

The INTERSTELLAR DRIVE is a high performance data storage subsystem with independent power supply, battery backup, and error detection. It has 256KB to 1 Megabyte of solid state memory integrated to perform with your operating system.

PION'S INTERSTELLAR DRIVE is designed for use with a family of interfaces and software packages. Currently available are interfaces for IBM, S100, TRS80, Apple, SS50, and most Z80 uP, and software for most popular operating systems. Additional interfaces are continually being developed for the most popular computers.

Basic Price for 256KB unit (includes interface and software)  
**\$1095.** plus tax (where applicable) and shipping

Visa and Master Card accepted.



**PION, INC.**

Tel. (617) 923-8009

101R Walnut St., Watertown, MA 02172

TRS80 trademark of Tandy Corp. Apple trademark of Apple Computers  
Interstellar Drive trademark of PION, Inc.



# SuperSoft Ada\*

## The Real Thing

*In a world where Ada is becoming a widely accepted standard, it is important that programmers learn this language quickly. SuperSoft Ada provides an excellent means for doing just that. And in contrast to other Ada-like languages, SuperSoft Ada supports standard Ada syntax and only standard Ada syntax. This means you'll learn to write programs in valid Ada code only.*

### SuperSoft Ada

SuperSoft Ada is a native code, fully recursive, multi-pass compiler which generates ".COM" files. While currently a subset, SuperSoft Ada supports many features of the standard Ada languages such as:

loop	floating point
procedure	printer I/O
strings	case
console I/O	while
arrays	integers
for	disk I/O
characters	integers with exponents

#### types

- user defined types
- derived types
- enumeration types (no I/O)
- records and selected components

#### attributes

relational operators for arrays and strings

#### control structures

- labels
- goto
- exit

#### in out/out mode parameters for subprograms

#### pragmas

- list
- print
- optimize
- include
- system

Circle 432 on Inquiry card.

The second release of SuperSoft Ada (2.0) includes the most useful features of standard Ada. Anyone purchasing an early release will be promptly notified of all updates and charged only for the small price increase of later releases.

Ada is a state-of-the-art language designed for the demanding, contemporary user/programmer. Because it is required by the Department of Defense, Ada is certain to become a dominant language soon. Begin learning and using Ada now with SuperSoft Ada.

"This compiler is presently an incomplete implementation of the Ada programming language. It is intended that this compiler will be further developed to enable implementation of the complete Ada programming language, and then to be submitted to the Ada Joint Program Office for validation."

(Requires: 48K CP/M®)

Ada Compiler:	\$300.00
Manual Only:	\$ 40.00

**Japanese Distributor:** ASR Corporation International, 3-23-8, Nishi-Shimbashi, Minato-Ku, Tokyo 105, Japan, Tel. (03)-4375371 Telex: 0242-2723.

**European Agent:** Micro Technology Ltd., 51 The Pavilions, Tunbridge Wells, Kent, England TN2 5TH. TEL 0892-45433. Telex: 95441 Micro-G

\*Ada is a trademark of the Department of Defense (Ada Joint Program Office)

CP/M is a registered trademark of Digital Research, Inc.

# SuperSoft®

FIRST IN SOFTWARE TECHNOLOGY P.O.Box 1628 Champaign, IL 61820 (217) 359-2112 Telex 270365



# Better Software Manuals

*Your company's survival may depend on them.*

---

Dana Sohr  
POB 953  
Beltsville, MD 20705

---

Incomplete, disorganized, and unreadable—that's the way to describe many of today's software manuals. And indeed, what other reaction could there be to the following:

- a 79-page software manual that on page 69 describes "the first thing you will have to do before performing anything . . ."
- a manual that claims the user doesn't need to read other manuals, then, three pages later, refers the user to another manual for necessary information.

---

## About the Author

Dana Sohr is a freelance technical writer and editor. He writes a column on computers for a national trade magazine and is a consultant on office computers for the newspaper industry. His recent work includes a manual for LITMAS (a cross-indexing program for the Apple II) and one for Calc Result (a spreadsheet program for the Commodore 64).

---

## Acknowledgment

This article was prepared as part of a research project done in conjunction with Ben Shneiderman of the University of Maryland Computer Science department. Sincere thanks go to Dr. Shneiderman for his advice and ingenuity.

---

• a manual containing sentences such as: "The insert/delete key deletes characters to the left of the cursor position if operated in lowercase and if the Shift key is held down at the

---

**Purchasing decisions  
will be made not so  
much on program  
features but on how  
easy programs are to  
learn and use.**

---

same time as pressing INST/DEL all characters to the right of the screen cursor are moved one position to the right with every keystroke and spaces created." (This manual, believe it or not, supports a \$500 program.)

You don't have to look very far to find such examples, and you don't have to listen very long to hear complaints. Software manuals today are like the bicycle-assembly instructions of yesterday—those notorious documents responsible for unassembled bicycles left rusting away in basements everywhere.

Let's face it: many software manu-

als are patchwork affairs thrown together at the last minute either by programmers or by technical writers who write too technically. Both assume that the user, given a few scraps of information, can figure out the rest.

This approach certainly saves time and money, but in the long run it is economic suicide. With more computer novices entering the software market, and with similar programs competing for everyone's attention, purchasing decisions will be made not so much on program features but on how easy programs are to learn and use. Thus, purchasing decisions will increasingly be made on the strengths and weaknesses of manuals.

Imagine this scenario: a hardware-store owner is shopping for a computer. He's attracted to the Apple II because he's learned that the Apple can run software to write invoices. But lo and behold, the local computer store stocks five invoicing programs for the Apple—programs that just aren't all that different.

Which program does he buy? He looks at the documentation, and he buys the program that has the most attractive, readable, and understand-

# FRANKLIN'S BAKER'S DOZEN!



## 13 Good Reasons to Buy the **ACE 1200**

1. **Apple® II-compatible**
2. **CP/M®-compatible**
3. **128K of RAM**
4. **Built-in floppy disk drive**
5. **Disk controller**
6. **80 column card**
7. **Serial interface**
8. **Parallel interface**
9. **Upper and lower case**
10. **VisiCalc® keys**
11. **Cursor control pad**
12. **Numeric pad**
13. **Auto repeat keys**

Extras can more than double the price of your personal computer. Not so with the Franklin ACE 1200. It's the professional computer system that includes the extras—and a long list of exclusive Franklin features that make it the most extraordinary value on the market today.

The ACE 1200 has everything you'll need to add a color or black and white monitor, modem, printer, back-up disk drive and other accessories. You can choose from the enormous selection of Apple programs and peripherals because the ACE 1200 is hardware- and software-compatible with

the Apple II. And, with the built-in CP/M card, you can run both Apple II and CP/M programs. Franklin's CP/M operates three times as fast as many competing systems, drastically reducing processing time for most business applications.

The Franklin ACE 1200—the most extraordinary value on the market today. Call or write today for the name of your local authorized Franklin dealer.

Franklin ACE is a trademark of Franklin Computer Corporation. Apple is a registered trademark of Apple Computer Inc. CP/M is a registered trademark of Digital Research Inc. VisiCalc is a registered trademark of Visi Corp.



**FRANKLIN**  
COMPUTER CORPORATION

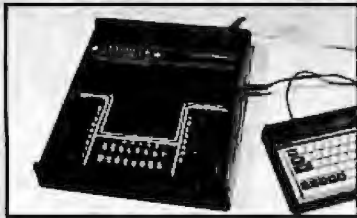
2138 Route 38, Cherry Hill, NJ 08002 609-482-5900 Telex: 837-385



RS-232

# DATA ACQUISITION

## Control & Measurement



**Starbuck Model 8232**

A general purpose real-world interface: connects to ANY computer or terminal via RS-232

### TYPICAL APPLICATIONS:

- Use with printing terminal: create low-cost data logger
- Use with modem and phone for remote acquisition & control
- Capture data bursts for subsequent analysis/plotting
- Monitor experiments; transfer data daily to main computer

### FEATURES:

- 8 analog inputs, 0-5 VDC
- 8 digital input channels
- 8 opto-isolated outputs
- All inputs and outputs fully protected to withstand abuse
- 8 bit (0.4%) analog accuracy
- On-board 2000 point buffer
- Up to 5000 analog readings/s
- Triggered acquisition
- Units may be chained for extra channels
- Controlled by ASCII strings
- Application manual details interfaces for common sensors
- Applications engineer on call
- THRIFTY PRICE: \$540. complete! Applications manual only: \$5. TRS-80 version also available

★ **STARBUCK** ★  
DATA COMPANY

PO Box 24, Newton, MA 02162  
(617) 237-7695

Dealer and OEM inquiries welcome

able manual.

Buyers are discriminating. In the future, when there will be more competing products from which to choose, buyers can afford to be even more discriminating. They will buy from anyone who can give them readable, usable manuals.

The same thinking also applies to computer-store owners. Why should store owners bother to sell a program with a shoddy manual when they can sell a competing program with a good manual? If they sell the first program, they know they will receive follow-up phone calls from frustrated customers and may even have to conduct in-store training sessions. But if they sell the competing program with the good manual, the store owners will spend much less time supporting the program; they'll receive fewer phone calls and answer fewer questions. For computer-store owners, it's more profitable to sell those programs backed by good manuals.

Good software manuals require an investment of time and money. Once that hurdle is crossed, producing a solid manual is a matter of knowing who the user is, how the user learns, what he needs to learn, and how to evaluate the finished product. This article offers advice to vendors and writers. It is designed to prevent the question, "How does this software work, anyway? I couldn't understand the manual."

A manual *transmits* information. Unfortunately, the transmission has to overcome some big obstacles before reaching its audience, the user. The biggest obstacle is the user himself.

### Create the Right Tone

Many will agree that first impressions are lasting ones, and the user's first impressions of your manual are crucial. If your manual is sloppily packaged and typographically ugly, or if it appears to be a well-packaged piece of technical drudgery, you are working at a serious disadvantage. You aren't trusted, you aren't liked, and any information you attempt to transmit will be distorted. Create the right tone, and what you transmit will be received.

### Define Your Audience

To create the right tone, think of the user, then tell that user what he wants to hear. If the program handles accounts receivable, tell the user how quickly and accurately he can send out his bills. Then tell him how easy the program is to learn and use. If the program does payroll, tell the user how quickly and accurately he can print checks. Then tell him how easy the program is to learn and use.

Entice and assuage the user by giving him what he wants, then go on with the business of listing necessary equipment, describing specific features, and detailing how to go about using the program.

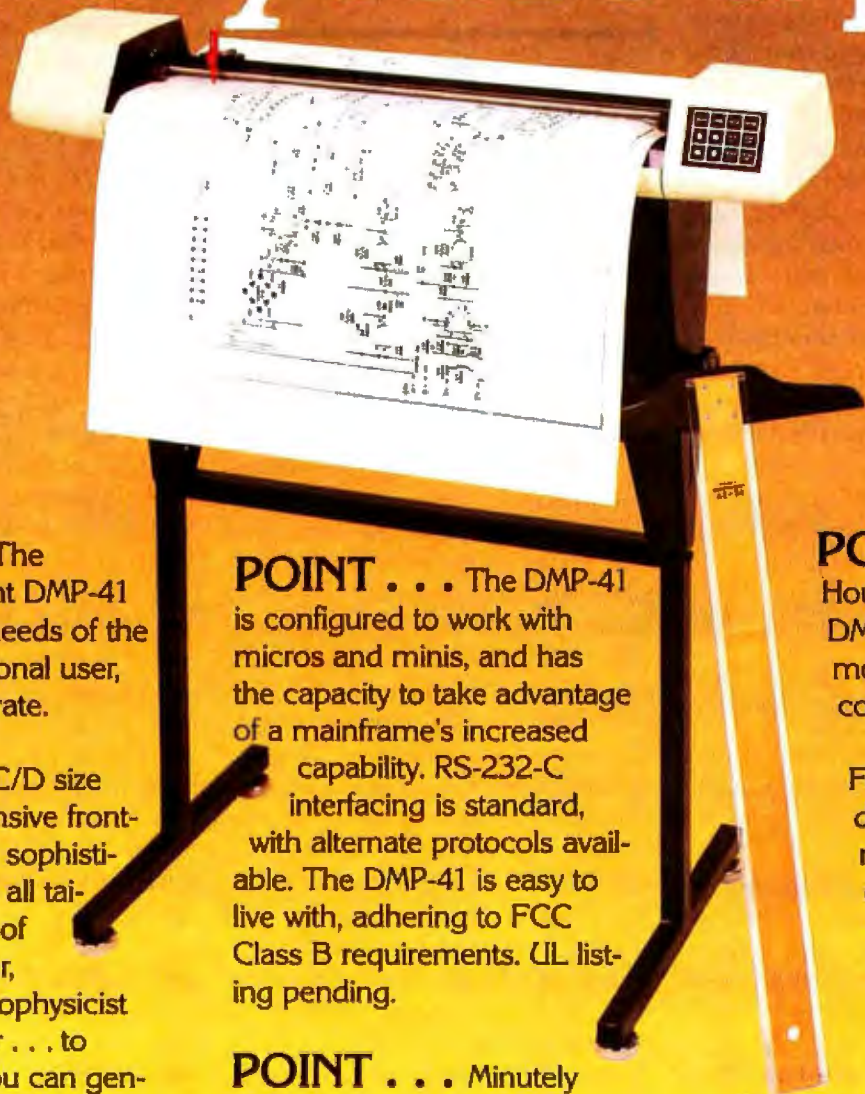
Your target audience will determine whether you transmit information at a breakneck speed or parcel it in doses. Study your intended users, and ask yourself some questions. What does the program do? Does it compile BASIC code, or does it teach BASIC? Different programs mean different users. The user of the first program, who is already writing his own code, understands something about programming. The user of the second program, who would like to write his own code, understands far less.

A manual for the experienced user should transmit information at a faster pace than does the manual for the novice. (For example, the first manual should not stop along the way to explain variable arrays; the second manual should.) By making educated guesses about the intended users of a program, you can determine what information the manual should transmit, and at what pace it should be transmitted.

In tutorials for novices, tone and pacing are crucial. Novices are bound to be shy about using a computer, and in some cases they will be terrified. Remember, many computer users today do not voluntarily decide to work with a computer; the decision is made for them by their managers. A manual for these novices must do several things. It must soothe the fears ("You can't hurt the computer, and the computer can't hurt you"); it must motivate ("The computer does the mindless tasks you always hated to do"). Only after you've created the



# It's easy to make points when you're a pro.



**POINT . . .** The Houston Instrument DMP-41 plotter meets the needs of the serious or professional user, yet it's easy to operate.

**POINT . . .** C/D size format, comprehensive front-panel controls and sophisticated firmware are all tailored to the needs of the surveyor, drafter, oceanographer, geophysicist and land developer . . . to name but a few. You can generate superior architectural elevations, contour maps, circuit-board layouts and assembly drawings quickly and accurately on bond, vellum or synthetic media.

**POINT . . .** The DMP-41 is configured to work with micros and minis, and has the capacity to take advantage of a mainframe's increased capability. RS-232-C interfacing is standard, with alternate protocols available. The DMP-41 is easy to live with, adhering to FCC Class B requirements. UL listing pending.

**POINT . . .** Minutely defined step size and high-resolution logic—combined with robust drives and optimized pen ballistics enable you to create plots of high precision and surpassing quality.

**POINT . . .** The Houston Instrument DMP-41 is one of your most cost effective considerations.\*

For the name, address and phone number of your nearest distributor, write Houston Instrument, 8500 Cameron Road, Austin, Texas 78753. Phone 512-835-0900, or 800-531-5205 if outside Texas. In Europe contact Bausch & Lomb Belgium NV, Rochesterlaan 6, 8240 Gistel, Belgium. Tel 059-27-74-45, tlx 846-81339.

**BAUSCH & LOMB**   
houston instrument division

\*suggested US retail \$2,995

See us at NCC Show, Booth 3810



right tone should your manual go on to provide well-paced, step-by-step knowledge.

Often you can't classify the typical user of a program. For example, both novices and seasoned computer users buy word-processing programs. In this case your word-processor manual should cater to the novice. The manual will not neglect the experienced user because all the information is provided, just at a slow pace. The experienced user knows how to use the keyboard, how to control the cursor, and how to protect disks; he can bypass such instructions and get to information he hasn't encountered before. Rather than resent the manual for slowing him down slightly, he'll probably wish that when he was a computer novice such a manual was the rule, not the exception.

Now that you know who the user is, how to create the right tone, and how to pace the manual, think about how to transmit information in a way that makes learning easy. After all, the user might be receptive to new information, but the information serves no purpose unless he can understand and recall it. Learning hinges on the way information is organized and the way it's presented.

### Organize by Tasks

No matter who the intended user is, a manual should be *task-oriented*—organized according to the tasks the program performs.

Although software manuals are, as a group, moving toward this orientation, a large number retain a more primitive organization. Many manuals are option-oriented; they begin with a section on the program's first menu option, then proceed to a section on menu option 2, and so on. That's fine—unless the user cannot perform the options in numerical order.

Consider chapter 1 of a certain bookkeeping-program manual. This chapter describes how to prepare invoices because "Invoices" is listed as menu option 1. In chapter 13, the user is instructed on recording customers' names and addresses because "Customers" is listed as menu option 13. Unfortunately, until the user records

his customer information (chapter 13), the program won't let him prepare invoices (chapter 1). So the user must read all the way to chapter 13 before actually doing work with the program. And after getting to chapter 13 and recording customers, the user must then try to figure out what to do next. Can he now go back to chapter 1 and prepare some invoices, or does he have to do something else first? The manual doesn't help him at all.

---

## Learning hinges on two basic factors: the organization and presentation of information.

---

An option-oriented manual doesn't synthesize information; it dumps it in the quickest (and cheapest) way possible. The user must read every chapter at one sitting, then try to arrange the information into some sort of logical order.

This scheme of manual organization makes great sense to the programmer, who organizes a task by breaking it into discrete sections of code, but it makes no sense to the user, who needs to be told what tasks to do and when to do them. For example, a word-processor manual should not begin with instructions on creating disk files because the program can't be used that way. Instead, the manual should first tell the user about editing and formatting, then tell him how to save material.

Task-orientation is no great mystery. Before you begin writing your manual, analyze the various tasks the program performs, then describe those tasks in the order in which the user should perform them. Make sure that all information needed to do the tasks is provided and that extraneous information isn't included. Most users don't care how a program works; they just want to know how to use it.

### Organizers

The manual shouldn't joggle the user with unexpected material because the user won't understand it ful-

ly. And if he doesn't understand it, he certainly won't be able to recall it.

To prepare the user for new information, include organizers in your text. The organizer, a very simple tool, can be a short introduction to a new section or chapter. An organizer for chapter 2 of a word-processor manual might look like this:

*In chapter 1 you learned how to format and edit what you type. In this chapter you will learn how to save what you type. Saving text on the disk will create a "disk file." Think of a disk file just as you would think of a file in a file cabinet. You can look at a disk file at any time, just as you can look at a file in the file cabinet. You can also add things to the disk file, change the file, or throw the file away . . .*

With this organizer in mind, the user can easily understand the purposes of the SAVE, REPLACE, and ERASE commands.

As the example shows, the organizers should look backward and forward at the same time. They should tell the user where he's been, where he is, and where he's going. A new computer program is a strange land in which the user can easily get lost. If the manual provides organizers, the user is always on solid, familiar ground. If organizers aren't provided, the user wanders aimlessly. He's never certain where he is, and the little that he learns is gained by trial and error.

### Move from the Whole to the Parts

Organizers alone don't ensure that the user will understand and recall new information. The manual should also move from the whole to the parts. At the same time, new information should be linked to knowledge the user already has.

Consider a wholesaler who buys an accounts receivable program. Like most software, this program was purchased because it makes a particular task easier to do; the wholesaler already knows a lot about that task before he lays his hands on the manual. He already knows, for instance, how to prepare an invoice. He



# MICRO

BUSINESS WORLD INC.  
Information Line (213) 704-6895  
TOLL FREE MAIL ORDER LINES  
(800) 423-5886 Outside Calif



## IBM SPECIAL OF THE MONTH IBM

### DISK DRIVES FOR THE PC

#### DOUBLE SIDED/DOUBLE DENSITY 320K

MSL  
**\$650.00**

OUR PRICE  
**\$229.00**

ONE YEAR WARRANTY



## APPLE II PLUS

PLUG-COMPATIBLE DRIVES

RANA ELITE I

W/CONTROLLER		W/OUT CONTROLLER	
MSL	OUR PRICE	MSL	OUR PRICE
549.00	399.00	449.00	329.00

### MICRO-SCI A2

W/CONTROLLER		W/OUT CONTROLLER	
MSL	OUR PRICE	MSL	OUR PRICE
519.00	379.00	409.00	299.00

## IBM

## PERSONAL COMPUTER



**INCLUDES:**  
2 Drives OS/DD  
Color Graphic Board  
64K Memory  
Video Monitor

MSL **\$3550.00** OUR PRICE **\$2849.00** Save **656.00**  
\*Subject to availability

## APPLE II E

STARTER SYSTEM

APPLE IIe 64K Drive w/cont Stand.  
APPLE II MONITOR  
80 COLS CARD.



MSL **\$1995.00** OUR PRICE **\$1699.00** Save **296.00**

## DAYONG

	MSL	OUR PRICE
051 503 Hard Disk 5M 10M	995.00	1485.00
	2495.00	1895.00

## MICROSOFT

	MSL	OUR PRICE
64K Ram Card w/warranty	350.00	249.00
128K Ram Card w/warranty	525.00	375.00
256K Ram Card w/warranty	875.00	649.00

## XEDEX BABY BLUE

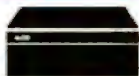
64K plus CP/M 2.2	600.00	499.00
-------------------	--------	--------

## KAYPRO

Computer Complete with CP/M and Perfect Software	1795.00	1595.00
--	---------	---------

## ALTOS 8 BIT SYSTEMS

Z80-BASED MULTITASKING WINCHESTER HARD DISK AND FLOPPY SYSTEMS INCLUDES MP/M II OPERATING SYSTEM



Model No.	No. of Floppy Disks	Floppy Disk Storage	Suggested List Price	Our Price
Series 5-15D	2	2 Mb	\$2,990	\$2,449.00
Series 5-5D	1	1 Mb	\$5,490	\$4,288.00
580-10	1	1 Mb	\$6,490	\$5,422.00

	ALTOS 5-15D	APPLE II	ALTOS 5-15D	APPLE II
Base Price:	\$2990	\$2995	3 ser., 1 parallel 1 ser., 1 par. = \$165	
Disk Drives:	2	1, add 1@ \$450	192 K	128K
Capacity:	2M bytes	320K bytes (for both)	Processor:	Z80A
Video:	User Opt. CRT	Monitor included	Computer:	Standard
Terminal Cost:	\$800 average	Apple POS	Graphic:	Industrial
Operating Syst:	MP/M included	Apple POS	Dot Matrix:	User Opt.
CP/M MP/M:	MP/M included	CP/M @ \$465	Printer:	@ \$500
Osiris DOS:	available	net. available	TOTAL:	\$4390* \$4675*

## RADIO SHACK TRS 80 MOD III



W/48K 2 DRIVE RS232

OUR PRICE **\$1733.00**

## OSBORNE PERSONAL COMPUTER

DOUBLE DENSITY INCLUDES SOFTWARE

- CPM
- MAIL MERGE
- WORDSTAR
- CB BASIC
- SUPERCALC
- M BASIC

OUR PRICE **1795.00**

## APPLE PERSONAL COMPUTER



PERIPHERALS AND SOFTWARE

	MSL	Our Price
Video Combo Package	375.00	259.00
Video Videoterm Card	345.00	238.00
Video Keyboard Enhancer II	149.00	118.00
Microsoft Software with CP/M	345.00	238.00
Microsoft Premium Pak	695.00	499.00
Microsoft 128K Card	99.95	72.50
PCP Appl I Card (4 MHz version)	445.00	338.00
PCP Appl II Card (6 MHz version)	595.00	448.00
Corvus Winchester 5MB	2,495.00	1,849.00
Corvus Winchester 10MB	3,495.00	2,849.00
Corvus Winchester 20MB	4,495.00	3,849.00
Saturn Systems 32K	249.00	185.00
Saturn Systems 64K	425.00	312.00
Saturn Systems 128K	599.00	432.00
Hays Micromodem II	379.00	285.00
Hays Smartmodem	279.00	223.00
Remington System Saver	90.00	68.00
M & R RF Modulator	30.00	22.00
M & R Super Fan	50.00	37.00
Graphics	175.00	135.00
Practical Peripherals		
Microbuffer II 16K	259.00	225.00
Practical Peripherals		
Microbuffer II 32K	299.00	239.00
Prometheus Versa Card	199.00	149.00
SVA Disk 2 + 2 Controller DSSD	395.00	335.00
SVA Disk 2 + 2 Controller DSSD	595.00	495.00
SVA App-L Cache 256 K Memory	1,200.00	1,049.00
TG Joystick	59.95	42.00
TG Select-A-Port	59.95	42.00
Wesper Micro Wizard 80	249.00	178.00
Wesper Micro BPO 16K	179.00	138.00
Wesper Micro BPO 32K	219.00	159.00
Wesper Micro SOB 16K	249.00	189.00
Wesper Micro SOB 32K	279.00	229.00
BMC 1401 w/RGB Interface	595.00	513.00
ALS 2-Card w/CP/M for Apple II	349.00	299.00

## IBM

## PERSONAL COMPUTER PERIPHERALS & SOFTWARE

	MSL	Our Price
QUADRAM Quadboard, 4 function bnd with 64 K	595.00	469.00
with 256 K	995.00	699.00
Quad Color II		
With 640x240 Resolution	575.00	439.00
Quad Color II		
With 640x400 Resolution	850.00	669.00
Printer Card w/cable (parallel)	159.00	109.00
Printer Card w/cable (serial)	179.00	139.00
Dayong Hard Disks		CALL

## SOFTWARE

Zork I by Infocom	39.95	28.90
Zork II by Infocom	39.95	28.90
Zork III by Infocom	39.95	28.90
Snooper Troops #1 by Spinnaker	44.95	33.50
Snooper Troops #2 by Spinnaker	44.95	33.50
Deadline by Infocom	49.95	37.50
Flight Simulator by Microsoft	49.95	37.50
Starcross by Infocom	39.95	28.50
Story Machine by Spinnaker	34.95	26.50
The Home Accountant by Continental	150.00	111.00
VrsiCalc by VisiCorp	250.00	189.00
Wordstat by Micropro	415.00	369.00
The Tax Manager by Microlab	250.00	189.00
VisiFile by VisiCorp	300.00	229.00
Supercalc by Sorcum	295.00	229.00
dBase II by Ashton Tate	700.00	489.00
Personal Investor by PBL	145.00	119.00

## MONITORS

	MSL	Our Price
BMC 12" Grn. Phs KQ 12 EU	249.00	178.00
12" Grn. Phs EO 1200 SU	219.00	148.00
HEC		
JB 12" Green	249.00	175.00
JC 12" Color	495.00	349.00
USI		
PI-2 12" Green	249.00	155.00
PI-3 12" Amber	289.00	185.00
LABTEK		
300 12" Green	195.00	145.00
Color I	395.00	325.00
Color II RGB Highres	895.00	895.00
ELECTRONOME		
ECM-1302 13" RGB Hires	595.00	395.00
ECM-1302-2 13" RGB Hires	895.00	595.00
Color Board for Apple II	749.00	195.00

## HEWLETT PACKARD

HANDHELD CALCULATORS AND COMPUTERS

	MSL	Our Price
HP 10C Slim-Line Prog Scientific	80.00	64.00
HP 11C Slim-Line Adv Prog Sci	100.00	79.00
HP 12C Slim-Line Adv Finan Prog	150.00	129.00
HP-15C Slim-Line Advanced Programmable Scientific w/Matrices	135.00	119.00
HP-16C Slim-Line Prog for Digital Electronics and Comput Science	150.00	129.00
HP-41CV Handheld Comp with SR Memory	275.00	209.00
HP-97 Desktop Fully Prog Print Card Reader for 41CV	750.00	599.00
Printer for 41CV	215.00	182.00
Optical Wand For 41 CV	385.00	289.00
Quad Ram Equals 4 Mem Mods	125.00	97.00
	95.00	61.00

CP/M is a registered trademark of Digital Research, Inc.



## S-100 PRODUCTS

ALL BOARDS ASSEMBLED & TESTED!

	MSL	Our Price
CALIFORNIA COMPUTER SYSTEMS		
2-80 CPU	325.00	259.00
Disk Controller/CP/M 2.2	425.00	339.00
64K Static RAM (200 mb)	750.00	549.00
Mainframe 110/60 HZ or 220V/50HZ	575.00	475.00
2 Serial Port + 2 Parallel	360.00	289.00
CP/M 2.2	150.00	119.00

When in LA please visit our showroom M-S 10-6.

## MICRO BUSINESS WORLD MAIL ORDER

We reserve the right to correct typographical errors. This ad supersedes all previous ads. California is subject to change without notice.

\*California residents add 8 1/2% sales tax  
\*\*Add 3% Shipping & Handling - Add 3% surcharge for credit cards. Order cannot be shipped unless accompanied by payment, including shipping, handling and tax where applicable.

OUTSIDE CA CALL TOLL FREE 1 (800) 423-5886 IN CA (213) 704-6895

Name (Please print) \_\_\_\_\_  
Address \_\_\_\_\_  
City \_\_\_\_\_ State \_\_\_\_\_ Zip \_\_\_\_\_

City	Make	Model	Description	Price	Total

Certified Check or M.O. Allow 2 weeks clearance for personal check.  
Bank Wire Transfer  
CREDIT CARD # \_\_\_\_\_ Exp Date \_\_\_\_\_ Signature \_\_\_\_\_

TOTAL ORDER \$ \_\_\_\_\_  
TAX IF APPLICABLE\* \_\_\_\_\_  
SHIPPING & HANDLING\*\* \_\_\_\_\_  
TOTAL ENCLOSED \$ \_\_\_\_\_





knows that the invoice should include the customer's name and address, inventory codes, prices, and so forth. He also knows that, according to his usual method, after preparing an invoice he must manually adjust customer accounts, tax accounts, salesman accounts, and so on.

However, while he knows how to prepare an invoice by hand, his new program does it differently. And the manual can use these differences to its own advantage.

People learn partly by contrast; new information isn't understood until a person compares it to a pattern created by older knowledge. For example, the statement "red is a bright color" can be understood only by mentally comparing red to other colors. Likewise, the wholesaler won't understand his accounts receivable program until he compares it to what he already knows. The manual should make that connection for him. It should briefly summarize how invoices are prepared by hand, then summarize how the *program* prepares invoices. This links new in-

formation to old knowledge, creating a clear contrast from which the wholesaler learns. "In the old days," he thinks, "I had to do all this stuff by hand. Now, after I prepare an invoice, the program automatically adjusts my customer, tax, and salesman accounts."

By starting at a simple whole and by linking new information to old knowledge, the manual gives the user his bearings. Now it can safely move on to the separate parts of the task and present step-by-step detail on preparing invoices.

### Repeat, Repeat

Sure, the user is intelligent; he bought your software, didn't he? But don't assume that he will instantly grasp important points. You have to repeat those points several times, then mention them once more in summary passages.

I'm not advocating that manuals be written for the addled. What I am arguing is that learning a new program is not unlike being in third grade and learning multiplication.

Remember third grade? How many hot afternoons did you spend at the flash cards until you could remember that 9 times 9 equals 81?

Because manuals should move from simple to complex information, it's critical that you make sure the user is with you every step of the way. This means that every important piece of information should be highlighted and dwelled upon, then drilled into the user's head. You can do this subtly, by providing several examples of a feature new to the user. Or you can do it directly, by repeating a definition. In a word-processor manual, for example, the user could be told several times the purpose of a command: "Remember, when you use the REPLACE command, the file you were working on *replaces* the old version of the file." Using this direct repetition, you run the risk of irritating those users who understood the REPLACE command immediately. But if you skim over important points, you run the risk of frustrating many users.

By orienting the manual around the tasks that must be performed, by providing organizers, by linking new information to old knowledge, and by repeating important information, you take a long step toward ensuring that the user can understand and recall new information. But that's only half the story. You also must present information in a way that helps users learn.

### Write Actively and Logically

When you prepare a software manual, you serve as a teacher. Unfortunately, you can't communicate verbally with the user. You can't shout and wave your arms and prod the user awake. You don't even know when the user's attention is lagging. However, if you write to engage the user at all times, presenting your material in a warm and lively style, you stand a good chance of communicating effectively. Dry, passive, turgid writing is not only boring, it hinders communication.

Use active verbs. A passive sentence such as, "The program was bought by Mary," takes about 25 percent longer to comprehend than the

## Finally, investment software from Dow Jones.

Dow Jones & Company, publisher of The Wall Street Journal and Barron's, is proud to introduce DOW JONES SOFTWARE.™

These products turn your personal computer into a powerful investment and business tool. With them, you can analyze and manage timely information available by telephone connection from Dow Jones News/Retrieval,™ the leading provider of online business and financial news and information.

DOW JONES SOFTWARE is reliable, easy-to-use, fully supported—from a company you can trust.

Available at selected computer stores. For more information call 1-800-345-8500 x 48.

(Alaska, Hawaii and foreign call 1-215-789-7008 ext. 48)

# DOW JONES SOFTWARE™

*...Bank on it.*



sentence, "Mary bought the program." Moreover, the second sentence, because it is more vigorous than the first, is easier to remember.

Arrange instructions in correct sequence because that's how the user should perform the instructions. If you give the instruction, "press the 'x' key while holding down the Shift key," the user will probably press the 'x' key, then the Shift key, and discover that nothing happens. Change the instruction to, "hold down the Shift key, then press the 'x' key."

Illogical instructions disrupt and sometimes destroy your message. You should also avoid pointless redundancy (e.g., "a total of four disks"), inconsistency (a command is first "SAVE" then "Save"), pretentiousness (using "determine" where "check" would do), and vagueness ("enter the file name").

### Write Relevantly and Simply

Make your writing more personal, more relevant to the user. Use the pronoun "you," not "we," as the former is more relevant to the user. Use the present tense; again, it is more relevant to the user.

Make the manual *human*. Use humor. Use familiar, everyday examples and analogies. Use hypothetical characters. Talk *to* your reader, don't just write *at* him.

Such techniques are, unfortunately, considered to be the tools of novelists alone. What the manual writer often forgets is that he, too, must serve his audience. He must instruct the user, but that's impossible when the user is bored and frustrated. Literary techniques applied with discretion keep the user interested and receptive.

Write as simply as you can. Avoid abstract nouns and verbs (e.g., concept, conceptualize). Abstractions do nothing but disrupt your efforts to teach the user. Above all, don't use jargon unless it's necessary and unless you're willing to define it the first few times you use it.

Use artwork wherever possible. Photographs and illustrations break up large bodies of type, attract the user's attention, and make informa-

tion more relevant. Instead of simply describing how to load disks, include an illustration. Rather than just describing an important screen image, include a photograph.

### Evaluate with the Eyes of a User

The evaluation is the last line of defense against errors, but too often vendors and writers ignore it (judging by their final products).

The evaluation doesn't have to cost a lot of money, and what money is spent comes back in the form of customer loyalty, goodwill, and sales. During the evaluation, you should identify and correct the manual's shortcomings; errors should be removed and omissions filled in. A critical evaluation produces a well-written, truly instructive manual that will make friends of users and computer-store owners alike.

You can evaluate the final draft of a software manual in various ways. Some methods cost more than others, and some are more effective than others, but no single method is sufficient. A thorough evaluation will in-

corporate two or more of the following methods:

**Editing:** Hire a professional editor on a temporary basis, preferably an editor experienced with instructional materials. An experienced editor can read the manual as the user would, and he can correct writing deficiencies.

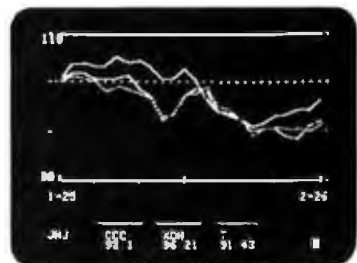
**Checklist:** The checklist, a very simple method of evaluation, sets standards for what the manual should provide. Here's an example of a much simplified checklist:

- Does the manual include (1) a table of contents, (2) an index, (3) introductory and summary material for each section and chapter, (4) a tutorial section in which the user gains hands-on experience with the program's functions, and (5) a quick-reference section in which the user can find information quickly and easily?
- Is the manual task-oriented?
- Does the manual move from the whole (a nontechnical overview) to

## Finally, technical analysis software from Dow Jones.

The DOW JONES MARKET ANALYZER™ is a powerful analysis program that can greatly increase the accuracy and effectiveness of the serious investor.

It can construct wedge breakouts, moving averages, support and resistance lines—a total of seventeen complex analyses. Now you can chart 100 securities in the time it would normally have taken you to chart one.



*Relative Strength Charts compare a security to an index such as the Dow Jones Industrial Average.*

# DOW JONES SOFTWARE™

1-800-345-8500 Ext. 48

Compatible with Apple systems and the IBM PC.

*...Bank on it.*



the parts (step-by-step knowledge)?

• Does the manual tell the user how to recover from errors, and are all error messages listed and explained in a section where the user can find them easily?

• Do section headings give a good idea of what the sections contain?

To devise a thorough checklist, examine existing manuals. What mistakes did you make in the past? What did you omit? Why did users complain?

Devising a checklist takes time, care, and effort. Fortunately, it can be used to evaluate future manuals, too. But the checklist alone is not a thorough method of evaluation. It uncovers mechanical errors but cannot uncover missing or ambiguously worded instructions.

**Self-Review:** Self-review, like the checklist, is a simple method of evaluation. The manual writer tests to see if he can use the program based only on the manual's instructions. In the process he typically uncovers missing or ambiguous instructions, incomplete descriptions, misspellings, and grammatical errors.

Self-review should be used for every manual but not as the sole method of evaluation. The writer, if he has any ego at all, isn't objective about his writing; he likes what he has written. Further, he already knows how to use the program, and during the self-review he may unconsciously supply information that is missing from the manual.

**Programmer Review:** Have the programmer review the manual. The programmer checks to see that the manual has covered all the program's functions and that it has covered them correctly. Unfortunately, while the programmer is the person best qualified to evaluate the technical accuracy of the manual, he will probably be of less help in evaluating the manual's organization and presentation.

**User Walk-through:** Select potential users of the program, hand them the manual, and see how quickly they learn the program. (Select worst-case users—people who have no computer experience.) Are they confused and

frustrated by certain sections of the manual? Do they have trouble finding information they need? Revise the sections where users run into trouble. Include more introductory and summary material, provide more examples; provide whatever the users believe is lacking. Then repeat the process with another group.

Users, after reading the manual, can be formally tested on their proficiency with the program. Can they perform all of the program's functions? How long does it take them? If a large percentage can't perform a certain function, revise the sections where that function is covered.

Users will often respond in mysterious ways to instructions that seemed perfectly clear to the writer. Those instructions can easily be revised. Users also uncover missing instructions and incomplete descriptions better than the writer or programmer can.

**Field Test:** If you're willing to spend some time and money, conduct a formal field test of both the program and the manual. Install the program at several sites, provide drafts of the manual, and then wait for the phone to ring. Are the test users calling you day and night? Can they understand the manual? Can they use the program? It costs less to answer these questions now, when only a few people are trying to use the program, than when 1000 buyers are calling in for help.

After two weeks, ask the users for comments and suggestions. Accept criticism, then use it to improve the manual. As in the user-walk-through method described above, test the users for specific knowledge, then revise the sections that don't seem to be communicating effectively.

## Conclusions

Buyers want and expect good manuals, and they will buy from anyone who can provide them. Thus, the poor quality of many of today's manuals offers a tremendous opportunity to enterprising vendors. Those who make a serious effort to produce well-written, instructive manuals will have a big advantage over their competitors; those who do not make the

effort will eventually fall by the wayside.

In all things—preparation, organization, presentation, and evaluation—all decisions hinge on the user—who he is, what he knows, and how he learns. If you constantly keep the user in mind, you're on your way to producing a readable, usable software manual. ■

## Bibliography

1. Al-Awar, J., A. Chapanis, and W. R. Ford, "Tutorials for the First-Time Computer User," *IEEE Transactions on Professional Communication*, vol. PC-24, 1981, pp. 30-37.
2. Brett, C. E., "Six Keys to Better Technical Writing," *Journal of Technical Writing and Communication*, vol. 1, 1971, pp. 45-59.
3. Coney, M. B., "The Use of the Reader in Technical Writing," *Journal of Technical Writing and Communication*, vol. 8, 1978, pp. 97-105.
4. Douglas, G. H., "The Common Diseases of Technical Writing," *Journal of Technical Writing and Communication*, vol. 4, 1974, pp. 37-46.
5. Goldfarb, S. M., "Writing Policies and Procedures Manuals," *Journal of Systems Management*, vol. 32, 1981, pp. 10-12.
6. Haupt, M., P. Perryman, and C. R. Schanstra, "Documentation Is the Key to Productive Computer Use," *Information and Records Management*, May 1982, pp. 22-28.
7. Maynard, J., "A User-Driven Approach to Better User Manuals," *Computer*, January 1979, pp. 72-75.
8. McCaskey, D. S., "Technical Writing: The Importance of Reader Interest," *Journal of Technical Writing and Communication*, vol. 3, 1973, pp. 217-221.
9. Meredith, G. P., "The Flow of Information," *Occupational Psychology*, vol. 31, 1957, pp. 99-103.
10. Vandenburg, J. D., "Improved Operating Procedures Manuals," *Ergonomics*, vol. 10, 1967, pp. 214-220.
11. Vaughn, J., "A Prescription for Programming's Least Popular Phase," *Data-ation*, vol. 25, January 1979, pp. 185-186.
12. Wagner, C. B., "Quality Control Methods for IBM Computer Manuals," *Journal of Technical Writing and Communication*, vol. 10, 1980, pp. 93-102.
13. Wiedman, T. G. and F. H. Ireland, "A New Look at Procedures Manuals," *Human Factors*, vol. 7, 1980, pp. 371-378.
14. Whittaker, D. A., "Write for Your Reader," *IEEE Transactions on Professional Communication*, vol. PC-23, 1980, pp. 170-173.

# THE PRICE OF **FAST** WAS JUST SHATTERED!



## 256Kbyte SemiDisk™ **\$995**

For more than a year, we've been making the most advanced disk emulator available for microcomputers. The one that's taken the "waiting" out of computing. Now, we have some more news that'll set the world on fire: A price cut! The NEW 256Kbyte board is only \$995. And the 512Kbyte SemiDisks for the S-100 and TRS-80 Model II are \$1495. (1Mbyte unit is \$2350.) So, what are you waiting for?

The SemiDisk is the **ORIGINAL** single-board microcomputer disk emulator. It has a greater storage density than any other: 1 Mbyte per board! And we've been shipping them for over a year! We didn't do this with 'me too' engineering. Our products are true innovations, based on reliable technology and proven designs, without the need for custom components.

Floppies are ok for data transfer or long-term storage. But they fall far short as online storage. If you are using high level languages, spelling checkers, word processors, databases and other disk-intensive software, you know the price you are paying: time. Your productivity is going down the drain. The SemiDisk disk emulator will save time and increase your productivity.

Even better, Release 5.0 of the SemiDisk CP/M-80 installation software contains SemiPool, an automatic printer buffer. No extra hardware is required; it's all in the software. Up to 8 Mbytes of buffer space! It's a better solution than a \$350 64Kbyte printer buffer that wastes space on your desk. Send documents of almost any length to the printer at a very high speed, then continue using the computer immediately. No Waiting!

### SemiDisk

It's the disk the others are trying to copy.

## SemiDisk Systems, Inc.

P.O. Box GG Beaverton, OR 97075 (503) 642-3100

Call 503-646-5510 for CBBS™/NW, a SemiDisk-equipped computer bulletin board.  
SemiDisk trademark of SemiDisk Systems, Inc. Copyright © 1983 SemiDisk Systems, Inc.







# The new TI Professional Computer. It makes you the one with the answers.



Today's business executive is faced with a world of questions. Questions about productivity. Cost control. And the bottom line.

To help you come up with the answers and alternatives, we introduce the new Texas Instruments Professional Computer. The one with the power, the expandability, the easiest-to-use keyboard, extremely high resolution graphics, and a broad array of software.

All the leading operating systems and programming languages are available. You can use many popular application programs from the best software suppliers to help you create spreadsheets, do word processing, construct graphics, communicate with other data bases or create your own. All of which lets you control assets, manage your time, and make projections for tomorrow's performance — today.

And for a clear "hard copy" print-out of information, you can rely on the new 850 Series printers, made by Texas Instruments especially for the new TI Professional Computer.

In short, the TI Professional Computer helps you make better business decisions based on better information. With the performance and reliability you expect from TI.

If you're on your way up, the new Texas Instruments Professional Computer can help. Because it makes you the one with the answers.

For full information and a demonstration, visit your local computer dealer, or write: Texas Instruments, Dept. 1A, P.O. Box 402430, Dallas, Texas 75240. Or call toll-free: 1-800-527-3500.

Creating useful products and services for you.



## TEXAS INSTRUMENTS

### SPECIFICATIONS

#### System Unit

16-bit, 8088 microprocessor  
64K byte RAM, expandable to 256K bytes  
4K byte graphics display memory  
5-slot expansion bus

#### Keyboard

Specially designed low profile  
Popular typewriter layout  
97 keys, including 12 function keys  
Separate numeric keypad and cursor control clusters

Tactile response, for quick positive entry  
Upper- and lower-case letters

#### Display Units

12-inch monochrome (green phosphor) or  
13-inch full-color, 25 lines x 80 columns  
High resolution, 720 x 300 pixels

#### Mass Storage

Built-in 320K byte diskette standard  
Additional internal storage of 320K byte diskette, or 5 or 10 Mbyte Winchester disks optional

#### Communications Options

300 BPS or 300/1200 BPS internal modem  
TTY, 3780  
3270 SNA stand-alone (Summer 1983)  
3270 BSC and SNA cluster (Fall 1983)

#### Operating Systems

MS™-DOS, Digital Research™ CP/M-86®, and  
Concurrent CP/M-86™. UCSD p-System™

#### Languages

BASIC, COBOL, FORTRAN, Pascal

#### Applications Software

Over 100 programs available from the most popular software vendors such as Microsoft, Ashton-Tate, Micro-Pro, IUS, Sorcim, Peachtree, BPI, Lifeboat and others.

#### Printers (Available Spring 1983)

150-cps TI 850 Series for most applications

FOOTNOTES: MS-DOS is a trademark of Microsoft Corporation. CP/M-86 and Concurrent CP/M-86 are trademarks of Digital Research, Inc. UCSD p-System is a trademark of the Regents of the University of California.



# Ulterior Motives, Lobo, Buying Your First Computer, JRT Update

*A first look at Modula-2 excites our resident critic.*

---

Jerry Pournelle  
c/o BYTE Publications  
POB 372  
Hancock, NH 03449

---

Let me begin with a confession: while I have a lot of fun with this column, I have an ulterior motive. True, this is the *User's Column*, and it will always be primarily for the benefit of computer users rather than hackers.

(As did many computer terms, "hacker" seems to have originated at MIT. The original German/Yiddish expression referred to someone so inept as to make furniture with an axe, but somehow the meaning has been twisted so that it now generally connotes someone obsessed with programming and computers but possessing a fair degree of skill and competence.)

My ulterior motive is to seduce my readers into becoming interested in what's happening in their machines, and in the computing world generally. For example, you may never learn a programming language, but the availability of good programming languages vitally affects you as a computer user; if hackers can't get powerful, well-documented, and highly portable languages, programs are going to cost far too much. In the worst case, we might drift back

toward the "high priest" syndrome that dominated computers back in the days of clean rooms and white coats.

So: for those who've written to ask, that's why I am and remain interested in languages for microcomputers. On which subject . . .

The big news is that Modula-2 runs on the Sage II computer. Modula-2 is the new language by Niklaus Wirth, the inventor of Pascal. If I'd known about it, I might not have started the Pascal Prime Project; Modula-2 is supposed to have most of the fixes we've all wanted for Pascal, plus a lot of other features.

(The Pascal Prime Project is a meeting of publishers of Pascal implementations for microcomputers; the meeting will, we hope, establish some standards for Pascal extensions.)

Pascal was intended as a teaching language, to be "compiled" on paper by instructors. A lot of people liked it, and transformed it into a "real" programming language. It was limited, particularly in text-handling and I/O (input/output) features, but it attracted a lot of adherents.

Modula-2 (short for modular language) was intended from the beginning as a full-fledged language. It was produced by Wirth after nine years' study of the problems of Pascal, including a year's sabbatical working with Mesa, the "Pascal-like" Xerox internal-development language. Modula-2 is supposed to have all of Pascal's desirable features, plus corrections for all its drawbacks.

We'll see. I only just have it running, so I can hardly claim to be an expert. On the other hand, I've liked everything I've seen so far. Modula-2, as the name implies, is compiled in chunks; once a chunk is working, it can be put into a library, accessible to any program that wants it. No more endless compile operations!

In particular, all Modula-2 I/O is "magic"; each implementation comes with a standard library of I/O routines that look a lot like an operating system. Programmers simply import them from their black box, and once they're available, invoke them as standard procedures. For example, you could have a module of CP/M I/O routines. It

# Computer OEMs: Now's the time to team with Altos.



As an OEM, you're aware there's a lot of 16-bit computers on the market. But what you may not be aware of are the many advantages to doing business with ALTOS<sup>®</sup> Computer Systems. Here's just a few:

- Altos currently offers the broadest range of cost-effective, single and multi-user 8086- and 68000-based computer systems.
- Altos supports the most popular commercial operating systems (XENIX<sup>™</sup>/UNIX,™ MP/M-86,™ MS<sup>™</sup>-DOS, OASIS-16, PICK, RM/COS,™ and UNIX System III™) plus most high-level languages.
- Altos microcomputers can run more existing applications software than any other computer in the world.
- Altos offers a large selection of utilities and compilers for converting existing Z80<sup>™</sup> and mini-computer applications, such as those written in DEC's<sup>®</sup> DIBOL.™
- Altos provides full communications support; both local networking and remote communications.
- Altos provides the widest range of 5¼" and 8" storage options, including floppy, Winchester disk and mag tape backup.
- Since 1977, Altos has delivered more than 35,000 multi-user systems and peripherals to satisfied customers throughout the world.

- Altos backs its computers with responsive, world-wide service and support. (Customer Service Division of TRW, Inc. in the U.S.)

If you're an OEM looking to remain on top, now's the time to team with Altos. Call, write or clip the coupon today.

- Please send me more information on Altos' single and multi-user 8086- and 68000-based computer systems.
- My application is \_\_\_\_\_
- Please have an Altos representative contact me.  
Name \_\_\_\_\_ Title \_\_\_\_\_  
Company \_\_\_\_\_  
Address \_\_\_\_\_  
City/State/Zip \_\_\_\_\_  
Phone (\_\_\_\_\_) \_\_\_\_\_

Mail to: Altos Computer Systems, Attn: Marketing Services, <sup>BT-5</sup>  
2641 Orchard Park Way, San Jose, CA 95134, Telex 470642 ALTO UI  
**800-538-7872 (In Calif., 800-662-6265)**



Packed with more value for OEMs

ALTOS is a registered trademark of Altos Computer Systems. 8086 is a product of Intel Corporation. 68000 is a product of Motorola, Inc. Z80 is a trademark and product of Zilog, Inc. XENIX and MS are trademarks of Microsoft Corporation. XENIX is a microcomputer implementation of the UNIX operating system. UNIX is a trademark of Bell Laboratories. RM/COS is a trademark of Ryan-McFarland, Inc. MP/M-86 is a trademark of Digital Research, Inc. OASIS-16 is a product of Phase One Systems, Inc. PICK is a product of Pick & Associates and Pick Computer Works. DEC is a registered trademark and DIBOL is a trademark of Digital Equipment Corporation. UNIX System III is a trademark of Western Electric.

©1983 Altos Computer Systems

Circle 26 on Inquiry card.



would contain error-handling routines—including the infamous BDOS errors, but supplemented with real information as to what has happened and what you should do now.

Note that the I/O routines are not part of the compiler. On the other hand, once they've been perfected and tested, they need never be compiled again; in fact, the compiler will complain if you try to compile (or link in) more than one version of the routines. The bottom line is that a good Modula-2 package should make I/O at least as convenient as CP/M or the better grades of BASIC—with plenty of capability for improvement if wanted.

I don't really know what that means in terms of compiler writing problems, but I don't have to care. From the user's point of view, many of Pascal's I/O problems vanish, and that's what's important.

The only microcomputer implementation of Modula-2 that I know of comes from Volition Systems, a group of computer hackers from the San Diego area. Its

Modula-2 comes with a thick stack of documents, including Wirth's book *Programming in Modula-2*. Volition Systems claims that a good Pascal programmer can become proficient in Modula-2 within a week. I can't vouch for that, not having had a week at it yet. I can testify that the documents seem to be written in English, and I've had no problems with the (rather small) parts I've waded through.

Late addition: Logitec of Los Gatos, California, promises a Modula-2 native-code compiler for the 8086 computer before June 1983. At present, it runs on Niklaus Wirth's machine in Switzerland.

My initial reaction to both the language and Volition Systems' implementation is positive. A few of the language constructions seem a little odd, and I know I would not have done certain things quite the way Wirth did—but they do make sense; at least those I've encountered do. Unlike my first experiences with Pascal, I don't find myself continually wondering, "Why the daylight did he

do that?"

As I said, we'll see. Just at the moment, the only thing we have here that can run Modula-2 is the Sage; that's not a problem, because the Sage works beautifully. By next month we'll have thrashed it about, and I'll be able to report benchmark times and things like that. Meanwhile, our love affair with the little Sage II continues; if you like UCSD Pascal and the "Scud" (UCSD p-System) operating system, you'll love that machine.

Volition Systems' Modula-2 runs on virtually any machine that can run p-System Pascal; in particular, that includes the Apple II and III as well as the Sage.

### More Good News

One of the best things that happened to microcomputers in 1982 was the pseudo disk: a system for fooling your computer into thinking that a bunch of memory is a disk drive. This really speeds up compilations, assemblies, and other tedious work.

I'm told it started in England under the name "Silicon Disk." My first experience was with the "Warp Drive" developed by G&G Engineering (San Leandro, California); this used the 8088 in a Compupro 816 dual-processor computer to turn superfluous ordinary memory into a pseudo disk. Later, that got modified into what is now called M-Drive, and I use it all the time.



Then came Semidisk—a board especially intended to be a pseudo drive; unlike the Compupro M-Drive that required a dual processor and a direct-memory-access disk controller, the Semidisk board would work with any S-100 system. (There are also versions for the IBM Personal Computer.) We installed it in our Compupro as the N-Drive, and I've happily used it ever since.

Comes now the Compupro M-Drive/H. This, too, is a half-megabyte pseudo-disk board that can be connected to any S-100 system. It's a little faster than the Semidisk, although you won't notice that unless you're using a superfast processor. M-Drive/H lists for about \$100 less

<p>CARTRIDGE RIBBONS FOR <b>APPLE PRINTERS</b> NEC 8023A C. ITOH PROWRITER</p> <p><b>\$9.95</b> EA <b>\$107.46</b> DOZ</p>	<p>CARTRIDGE RIBBONS FOR <b>EPSON</b> <b>MX-80 MX-100</b></p> <p><b>\$6.00</b> EA <b>\$11.05</b> EA <b>\$86.20</b> EA <b>\$129.00</b> DOZ</p>	<p>DUAL SPOOL RIBBONS FOR <b>OKIDATA</b> <b>PRINTERS</b></p> <table border="0"> <tr> <td>80, 82, 83</td> <td>EA</td> <td>DOZ</td> </tr> <tr> <td>92, 93</td> <td><b>\$2.77</b></td> <td><b>\$29.92</b></td> </tr> <tr> <td>84</td> <td><b>\$5.99</b></td> <td><b>\$64.69</b></td> </tr> </table>	80, 82, 83	EA	DOZ	92, 93	<b>\$2.77</b>	<b>\$29.92</b>	84	<b>\$5.99</b>	<b>\$64.69</b>
80, 82, 83	EA	DOZ									
92, 93	<b>\$2.77</b>	<b>\$29.92</b>									
84	<b>\$5.99</b>	<b>\$64.69</b>									
<p><b>LABEL</b> <b>SPECIAL</b></p> <p><b>\$2.99</b> /K (5K MIN)</p> <p><small>1 ACROSS 3, 2 15-18 CONTINUOUS LABELS</small></p>	<p><b>MAXELL</b> <b>DISKETTES</b> 5 1/4" SINGLE SIDE DUAL DENSITY MD-1</p> <p><b>\$29.90</b> /K</p>	<p><b>INNOVATIVE</b> <b>CONCEPTS</b> <b>FLIP'N'FILE</b> DISC STORAGE BOX HOLDS UP TO 60 DISKETTES</p> <table border="0"> <tr> <td>5 1/4"</td> <td>8"</td> </tr> <tr> <td><b>\$24.95</b> EA</td> <td><b>\$29.95</b> EA</td> </tr> </table>	5 1/4"	8"	<b>\$24.95</b> EA	<b>\$29.95</b> EA					
5 1/4"	8"										
<b>\$24.95</b> EA	<b>\$29.95</b> EA										

COMPLETE LINE OF OTHER RIBBONS AVAILABLE. PLEASE CALL  
ALL ABOVE PRICES INCLUDE SHIPPING

# Check-Mate™

51 DIAUTO DR  P.O. BOX 103  
RANDOLPH, MA 02368 

TOLL FREE 800-343-7706 IN MASS 617-969-7694

WE ACCEPT MASTER CARD & VISA  
MASS. RESIDENTS ADD 5% SALES TAX  
PHONES OPEN 9AM-7PM EASTERN TIME

# Now your computer can say anything and say it well. Introducing the Votrax Personal Speech System.

## Quite articulate.

The unlimited vocabulary Votrax Personal Speech System is the most sophisticated, low cost voice synthesizer available today. Its highly articulate text-to-speech translator lets your computer properly pronounce conversational words at least 95% of the time.

For all those unusual words and proper names, you can define an exception word table and store your own translations. And remember, the entirely self-contained Votrax PS System gets your computer talking without using any valuable computer memory.

## Built-in versatility.

Much more than just a voice output device, the Votrax PS System lets you mix either speech and sound effects or speech and music. A programmable master clock and 350 programmable frequencies give you unmatched control of speech and sound effects.

The Votrax PS System offers user expandable ROM for custom applications, user downloadable software and sound effects subroutines for easy user programming. Its programmable speech rate provides more natural rhythm, while 64 programmable amplitude levels give you greater control of word emphasis.

Actual size: 12.2" x 4.5" x 2.6"

## Friendly to humans.

Designed to look like a printer to your computer, the Votrax PS System is extremely easy to use. It can be used in tandem with your printer without an additional interface card. Both serial and parallel ports come standard, allowing you to connect the Votrax PS System to virtually any computer. Speech, music and sound effects are only a PRINT statement away.

# “Listen here”

## What to say after “Hello”.

Businesses will appreciate spoken data transmission, narration of graphic displays and unmanned, oral product demonstrations. Spoken verification of data input will make computers much easier for the blind to use. School children can receive comprehensive

## Votrax®

The Votrax Personal Speech System is covered by a limited warranty.

Write Votrax for a free copy.  
500 Stephenson Highway, Troy, MI 48084

computer instruction with voice textbooks as well as spoken drills and testing. And then, late at night, you can make those adventure games explode.

## A quick list.

- Highly articulate Votrax text-to-speech translator.
- 350 programmable frequencies for speech/sound effects.
- 64 amplitude levels.
- Simultaneous speech and sound effects or speech and music.
- 8 octave, 3 note music synthesis.
  - Serial and parallel interface standard.
  - User programmable master clock.
  - User defined exception word table.
  - User programmable speech rate, amplitude and inflection.
  - User expandable ROM for custom applications.
    - User downloadable software.
    - 3,500 character input buffer: sub-divisible for a printer buffer.
  - Internal speaker and external speaker jack.
  - Real time clock and 8 user defined alarms.
  - Oral power up and error prompting.
- X-on/X-off and RTS-CTS handshaking.
- Programmable Baud settings (75-9600).
- Interrupt driven Z-80 microprocessor.
- Parallel/Serial interconnect modes.
- Proper number string translation: the number “154” is pronounced “one hundred fifty four”.

To order, see your local computer retailer or call toll-free

**1-800-521-1350**

Michigan residents, please call (313) 588-0341. MasterCard, VISA or personal check accepted. The price is \$395 plus \$4 for delivery. Educational discount available. Add sales tax in Michigan and California.

© VOTRAX 1982





than Semidisk; both are sold at discounts by various mail-order houses. Neither is at all difficult to install given familiarity with CP/M and the innards of your system. (If you don't know or care what a number in base 16 is, find someone who does before trying it.)

You can put in more than one M-Drive/H if you need a pseudo disk larger than 500K bytes; or you can get a full-megabyte Semidisk board for \$2995. I've never needed more than half a megabyte, so I've tried neither method, but I've no doubt both would work.

There seem to be as many new sources of pseudo-disk boards as there are manufacturers of memory boards, so I expect competition will drive the price down a lot during 1983.

### Lobo Howls Again

Barry Workman of Workman and Associates has his new Lobo. Lobo calls it a Max-80. Barry calls his Ralph. As far as I can see, it was love

at first sight.

The Lobo comes with a *completely* reprogrammable keyboard and extensive documents; there's even a disk source for both the keyboard and the screen codes. Thus, if you want the key that most people believe is the "E" to be the Return key, you can set things up that way. If I ever get one, I probably will change the key tops; I can't say I care for the Teletype keyboard layout Lobo has chosen (although my late mad friend would have liked it, and my colleague Robert Silverberg is used to a key layout that has quote marks above a number) . . .

It has a lot of neat features, such as a built-in, battery backup clock; also, a controller able to handle 8-inch, 5¼-inch, and hard disks, all at the same time and in any combination. For those unable to afford an S-100 system with Semidisk or Compupro's M-Drive, for \$95 extra the Lobo comes with an additional 64K bytes of memory plus software to turn that memory into an I-Drive—that is, to fool the system into thinking that the

extra memory is a small, but very fast, disk.

The Lobo processor is a 5-MHz Z80A, making it faster than Alex's 4-MHz CCS S-100 machine, and nearly as fast as Zeke II, my Compupro 6-MHz Z80B. Indeed, the Lobo runs as fast as the 8085 in my Compu-pro 816 dual-processor machine, since we had to slow that down to 5 MHz to accommodate Jim Hudson's 8087 math chip.

All in all, at \$820 (\$915 with the extra 64K-byte memory) including CP/M 2.2, the Lobo is a strong candidate to be one's first machine. If you get one, consider getting the Zenith 12-inch Green Screen, which I've seen at Priority One for as low as \$89.50. I think it's slightly better than the Amdek that Lobo sells, and costs less. You'll also need disk drives; but I note that dual-drive 8-inch systems (single-sided) complete with case and power supply can be had for as low as \$600, and are regularly for sale at considerably less than \$1000.

There is this problem: Lobo does not furnish the source to the CBIOS (customized basic input/output system; the "hooks" by which your system talks to CP/M); and this means that you can't be *sure* that all disk systems will work properly with the Lobo. You can assume that all those Lobo sells will work, of course; but if you want to replace them, or you already have disks, you take your chances.

I don't understand why Lobo doesn't give you the CBIOS source. It's not as if it were a valuable secret, and I must have a score of letters detailing awful problems that would never have arisen if my correspondents only had the source to the CBIOS. With all-in-one package systems like the Osborne, there's not such a strong need for the CBIOS source. After all, Osborne has a big network of dealers to provide support for purchasers who get in trouble, and you're not supposed to be adding non-OSborne stuff to the machine anyway. However, systems like the Lobo are useful in large part because of their flexibility—but not having the CBIOS reduces that flexibility by a lot.

## BABY BLUE™

### THE "PLUG IN" SOLUTION TO SOFTWARE FOR THE IBM PERSONAL COMPUTER (AND SOME PC COMPATIBLES)



**SOFTWARE SELECTION:** BABY BLUE™ upgrades your IBM Personal Computer and allows you to run nearly 3000 popular CP/M® software programs.

**SOFTWARE VERSATILITY:** The BABY BLUE™ package includes three special "utility" software programs at no additional cost, making your computer very versatile.

**SOFTWARE SAVINGS:** BABY BLUE™ is now available bundled with WordStar™, MailMerge™, Personal Pearl™ and WonderCalc™ for only \$995. That's four applications programs plus BABY BLUE™ for only \$995.

**ADDITIONAL MEMORY:** BABY BLUE™ gives your computer 64K of additional main memory.

If you are looking for software . . . BABY BLUE™ is the solution!

Buy BABY BLUE™ at your microcomputer dealer.



Microlog Inc.  
222 Route 59, Suffern, NY 10901  
(914) 388-0353

Microlog is a subsidiary of  
Terminix Unlimited International, Inc.  
Dallas, TX (NASDAQ: TUI)

BABY BLUE is a registered trademark, registered wordmark and trademark and a trademark of Terminix International Corporation. The name Baby Blue is a trademark of Terminix International Corporation. All other trademarks are the property of their respective owners.

**Be Wise.  
Be Thrifty.  
Be A  
Night Owl.**



**Your Own University Library Online At Home!**

If you're free between the hours of six and midnight, make a date with one of the world's fastest, most powerful online information services — at a fraction of what it would cost during the business day. All you pay is a \$50 registration fee to receive your classified user's password. Then, any evening, you can summon up a wealth of information for as little as \$6 per hour.

Technical and scientific abstracts. Medical journals. Government studies. Business indexes. Major newspapers. BRS/AFTER DARK gives you access to the same comprehensive data files used by BRS Search Service subscribers, which include major corporations and reference libraries throughout the world. All instantly accessible with simple, interactive language.

Of course, BRS/AFTER DARK also gives you valuable peripheral services like a home-computer Newsletter and nationwide communication via electronic mail. Plus, shop-at-home services and instant software delivery programmed for the very near future.

Don't let another evening go by without BRS/AFTER DARK. All you need is your phone and any dial-up system or terminal. For more information about BRS/AFTER DARK, just fill out the coupon.

Circle 66 on Inquiry card.

**BRS**



**AFTER DARK**

Sign me up as a BRS/AFTER DARK subscriber for a one-time subscription fee of \$50. (Basic user's rate as low as \$6 hour.)

BY583

Charge to MASTER CARD/VISA (circle one)

Acct. No. \_\_\_\_\_ Expires \_\_\_\_\_

Send more information

Signature \_\_\_\_\_

NAME \_\_\_\_\_

ADDRESS \_\_\_\_\_

CITY \_\_\_\_\_ STATE \_\_\_\_\_ ZIP \_\_\_\_\_

Mail to: BRS • 1200 RT. 7 • LATHAM, NY 12110 • (518) 783-1161



Hank: Here's the report you've been waiting for. Hope you put your system on automatic and didn't wait up.

To all reps: Price changes on following items effective immediately: No. 10-111A, 10-114A; 10-AL.

Take that, bud. (And retaliate fast. I know phone rates are low now, but game's cutting into sack time.)



# Your computer's telephone. Hayes

Wouldn't it be great if, somehow, you could connect your computer to your accountant's, down the street? To the IBM\*\* PC at the branch office, upstate? Or to your favorite chess challenger, across country?

over ordinary phone lines, all across America.

But any modem will send and receive data.

Smartmodems also dial, answer and disconnect calls. Automatically. Without going through the telephone receiver, making them far superior to acoustic coupler modems.

**Choose your speed; choose your price.** The lower-priced Smartmodem 300 is ideal for local data swaps and communicates at 300 bps. For longer distance and larger volumes, Smartmodem 1200 communicates at 1200 bps or up to 300 bps, with a built-in selector that automatically detects transmission speeds.

Both work with rotary dials, Touch-Tone\* and key-set systems; connect to most timesharing systems; and feature an audio speaker.

Either Smartmodem is a perfect match for many different computers. And if you have an IBM PC, Hayes also provides the perfect communications software.

**Smartcom II™** We spent a lot of time developing our software, so you can spend less time using it. Smartcom II prompts you in the simple steps required to create, send, receive, display, list, name and re-name files. It even receives data completely unattended—especially helpful when you're sending work from home to office, or vice versa.

And if you need it, there's always "help." One of several special functions assigned to IBM function keys, this feature explains prompts, messages, etc. to make communicating extra easy.

With Smartcom II, it is. The program remembers communication parameters for 26 different remote systems. Just punch a key, you're all set.

You can treat dial-up and log-on sequences the same way. In fact, Smartcom II comes with codes already set up for four popular information services. COMPUSERVE® DIALOG'S KNOWLEDGE INDEX™, DOW JONES NEWS/RETRIEVAL SERVICE, and THE SOURCE™ AMERICA'S INFORMATION UTILITY.™ Procedures for obtaining an account with each of the services are included in the Smartcom II manual. But that's not all.

**Special offers for Smartcom II**

**owners!** Dow Jones News/Retrieval Service has a special introductory offer for

Smartcom II owners. By calling a toll-free number, they receive a free password and one free hour of service anytime after 6:01 p.m., local time.

You'll also be entitled to a valuable



With a telecomputing system by Hayes, you can.

Quickly. Easily. And for the price of a phone call.

**Hayes Smartmodem. Think of it as your computer's telephone.** Hayes Smartmodem 300, and the faster Smartmodem 1200, work with any computer with an RS-232 I/O port. They allow you to communicate,





Welcome to TELEMAIL! Your last access was Tuesday, Jan. 4, 1983 11:07 a.m. CHECK these bulletin boards: TELEMAIL...TELESOFT...



subscription offer for THE SOURCE. Smartcom II owners who subscribe to THE SOURCE will receive one free hour of daytime service.

Like all our products, Smartcom II and both Hayes Smartmodems are backed by excellent



documentation and full support from us to your dealer.

So see him today. Break out of isolation. Get a telephone for your desktop computer.

Hayes Microcomputer Products, Inc.,  
5923 Peachtree Industrial Blvd.,  
Norcross, GA 30092. 404/449-8791.

Smartcom II is a trademark of Hayes Microcomputer Products, Inc.

\*TM American Telephone and Telegraph

\* IBM is a registered trademark of International Business Machines, Corp.

© 1983 Hayes Microcomputer Products, Inc.  
Sold only in the U.S.A.

COMPUERVE INFORMATION SERVICE is a registered trademark of CompuServe, Incorporated, an H & R Block Company.

KNOWLEDGE INDEX is a service mark of DIALOG Information Services, Inc.

DOW JONES NEWS/RETRIEVAL is a registered trademark of Dow Jones & Company, Inc.

THE SOURCE and AMERICA'S INFORMATION UTILITY are service marks of Source Telecomputing, a subsidiary of The Reader's Digest Association, Inc.

Anyway, Barry Workman and my son Alex like their new Lobo. Me, I'll continue to reserve opinion until I've watched for a few months; but I'll admit that I'm impressed by what I've seen so far.

### Things My Postman Brings Me

A lot of people seem to think I'm a last resort for advice. Sometimes I can help, but fair warning: I try to answer all my mail, but work here ebbs and flows, and when it's at flood tide it can take weeks to months for me to get at something. I apologize. I was brought up to believe one should promptly answer one's mail, and John Carr and I try; but some days the press is just too much, and letters get into places they shouldn't, from which moldering piles they surface only by accident.

I've recently received a stack of horror stories. One, from Professor R. W. Marks at Villanova, concludes:

*The sum total of my experiences have led me to several rules for microcomputer buyers. (1) Will an abacus do? That is, will the grief you have to put up with be compensated by the advantages of a big machine rather than a toy? (2) Don't be misled by the size of a company. As Lily Tomlin says, "We're the phone company. We don't care. We don't have to." XXX and YYY (two large mail-order dealers) don't care. They don't have to.*

[Note: I don't name the two firms, because I've had no bad experiences with the one, and no experience at all with the other. As a matter of policy, I insist on several instances before naming names. . . J. E. P.]

*(3) Unless you want to learn one hell of a lot about the S-100 bus and the BIOS and the other pieces of alphabet soup, buy a system already integrated, or pay someone to do the integration. I'm not very impressed with what Apple offers for the money, but the thing runs as soon as you plug it in. (4) Under no circumstances trust salesmen or manufacturers to tell you anything remotely close to the truth about a product before you buy it. You will get all the rude surprises only after you have paid for the thing . . .*

*(5) Don't assume that expensive pieces will come with manuals.*

Dr. Marks describes one experience: he bought a T.E.I. mainframe from Jade. It arrived, and . . .

*I discovered it had come without any documentation, missing the main fuse and fuse cap, and seriously dented in one corner. I immediately called Jade and was told (no joke) that it was supposed to come without documentation, fuse, or fuse cap, and they were sorry about the dent, but it wasn't a Jade item and they were not responsible . . .*

Eventually, through persistence, he got someone at Jade to admit that the box was supposed to have documents; and finally they arrived. (Dr. Marks found them "surprisingly good.")

The story goes on, but the point is made: in dealing with mail-order houses, bigger is not necessarily better; and you'd better be prepared to be patient. Perhaps then, one should go to a computer store? It's time to hear from another reader.

Larry Hansford, a systems consultant in New Carlisle, Ohio, says:

*A typical scenario is a businessman who goes to the nearest computer store and tells the salesperson that he needs a computer for accounting and word processing. He walks out of the store with boxes in hand containing a computer, printer, software, supplies, and very little idea what to do with it.*

*Some time later, I get a call from an irate businessman who feels he has been taken advantage of. Unfortunately, he probably has been! I have been less than impressed with the knowledge of the salespeople in most of the computer stores. Their goal is to get a commission, not to make a satisfied customer. Most are, however, near experts on computer games of any and all types.*

*I appreciate the resulting business I get, but I resent having to clean up the mess. If they'd gotten competent advice in the first place, they'd have paid less and gotten more.*

Unfortunately, both my correspondents are right. Buying parts by mail order can, if you're not careful, bring you unrelieved grief; but going to the local computer store can be an even less satisfying (and more expensive!) experience. What, then, is one to do?

One solution is proposed by Erwin Strauss, sometimes known to science-



fiction conventions as the folksinger Filthy Pierre (indeed, his letter is signed Filthy). Strauss complains that my advice, namely that one should deal with systems-integration specialists who know what they're doing, is impractical. "Pournelle," he says, "gets special service because of his BYTE connections, and as for that nighttime visit by Tony Pietsch, that's like the *New York Times'* restaurant critic asking a top chef to whip up something and deliver it. For us mere mortals, it's more like getting a neurosurgeon to come over at midnight to put on a Band-Aid; if we succeed, we'll need scientific notation to figure the bill." He continues:

*I have some advice that's more practical. First, choose a computer that's been widely promoted (preferably on TV) for at least a year. Jerry may dream about the day when makers "no longer use their customers as a quality-control department," but for now the best thing is to let those who always have to be first on the block be the guinea pigs. If there hasn't been a big stink about a heavily hyped machine after a year, it's probably not too bad. This rule also means there'll probably be a service shop near you that's seen a good number of broken computers come in over the counter, so they should be able to diagnose accurately, and fix quickly, the problems that are characteristic of your machine.*

*Of course, this cuts the field down to names on the order of IBM or Apple or Radio Shack and such. I can already hear Jerry mooning over the features of his Godbout and Televideo and suchlike gear; but a novice has no business with that level of equipment.*

Strauss goes on at some length, ending by saying that if you have unlimited money ("as long as it stays within, say, four figures") you should pop for an IBM PC; otherwise, get a TRS-80 Model III. He's not so certain about the Apple II (despite its widespread publicity), and he hates the Apple III. He concludes, "Whatever the off-the-shelf system you get, you can be sure that it won't do everything you like, and it won't do much of what it does quite as handily as you'd like. But it will be serviceable, and at an affordable price, and with a minimum of start-up hassle."

That's one opinion. I have another.

## How to Buy a Computer

First, regarding Strauss's comment that "a novice has no business with that level of equipment," I couldn't disagree more. True: I certainly wouldn't aim a novice user at one of Bill Godbout's newest state-of-the-art systems; but then neither would Dr. Godbout. Tony won't let me have some of the new stuff I own until he's thoroughly bashed it about and found its limits.

---

### Buying by mail order can, if you're not careful, bring you unrelieved grief.

---

However: because a company is out at the frontiers of computer technology doesn't mean it can't and doesn't make good stuff for the ordinary user. Indeed, Compupro is an excellent example: here in this room I have three of its systems. One is Zeke II, the Z80 I'm writing this on now. The Z80 has been around so long that it's practically old hat; and Zeke II is utterly reliable, quiet, and operates nearly invisibly.

(True: we have customized the screen output and keyboard on Zeke II; but the system itself is very much standard from Compupro, and it works quite nicely with either the Televideo 950 or the Zenith Z-19 terminals.)

The second is an 8085/8088 dual-processor computer, as staid and stolid as you can get nowadays. When we first brought it up, Compupro was the only outfit that *had* a dual-processor machine, and I certainly wouldn't have recommended the system to a beginner; now it has become a standard, and consultants like Bill Grieb and Colin Mick recommend dual processors for vanilla systems.

Moreover, you can get a good S-100 system for at least no more than you'd pay for an IBM with comparable capabilities, and I for one prefer the more flexible system. My motto remains, "Iron is expensive, but silicon is cheap." With an S-100

system you can upgrade for less than with anything else I know of; and upgrades can be very significant.

I see many exciting new systems in development: 16-bit systems, even 32-bit systems, all upward-compatible with what I have at present. Right now all I have to do to make my 8085/8088 dual processor into a 68000 system is replace *one board*; all the memory, disk drives and controller, modem, I/O boards, and such like will work fine.

My third Compupro machine is utterly experimental, with a 12-MHz 8086 board. Now I certainly wouldn't recommend that for a novice; not this year, anyway. Next year, though, might be a different story.

Moreover, my experience with TRS-80 and Apple systems hasn't been as pleasant as Strauss implies yours will be. We hadn't had our Apple a month before it required major repairs; its switching power supply blew and took with it the motherboard and every card in the system. Then we had the experience of updating our DOS (disk operating system); more than \$60 for a single ROM (read-only memory) chip and a disk. This wasn't to get a new DOS, you understand; it was merely to update what we had. Now, they tell me, Apple won't even let you off that easily. In the future it will cost a great deal more to upgrade an old Apple II.

In fairness, I have to say that Carl Helmers has had five Apples for years. All run UCSD Pascal. His total repair bills for all five machines sum to less than \$500. Carl admits the machines are limited, but he has no complaint about their reliability.

What he calls reliable, though, is not my definition. I agree with Bill Godbout: "If the error rate is high enough to measure, it's too high." I've watched a lot of computer users shake cables, reboot disks, flick switches on and off, and in general put up with glitches that would have me on the phone to Tony Pietsch in seconds. I trust my *living* to these machines. I cannot and will not put up with "rather more or less . . ."

The Apple is great for Epyx's (marvelously fun) *Crush*, *Crumble*, and *Chomp*, but when I develop pro-

# The Most Convenient Marriage This Side of a Shotgun

The New Epson QX-10 and the QuCeS Hard Disk Storage System. Available Now at Your Local Epson Dealer.



**NEW!**  
Optional cartridge disk for on-line/off-line backup storage of up to 5 megabytes per cartridge.

Convenience is what the revolutionary QX-10 plain language microcomputer is all about. And now it's even more so. With 12 or 20 megabyte mass storage systems manufactured by QuCeS.

Now you can operate your new Epson QX-10 at peak performance with the QuCeS hard disk subsystem. A lot more memory. A lot more speed. And convenience. QuCeS mass storage systems are so reliable that Epson of America uses them in its own offices.

The new VALDOCS software system which runs the QX-10 is supplied by Epson. QuCeS furnishes the utilities such as Format, Back-up, and Test. Altogether an ideal marriage, with double-barreled convenience. Prices starting at \$2595.00.

Specifications	12 Megabyte	20 Megabyte
Storage Capacity— Unformatted Per Drive	12,749,184 Bytes	19,998,720 Bytes
Storage Capacity— Formatted Per Drive	100 MBytes	160 MBytes
Formatted Per Cylinder	32,768 Bytes	32,768 Bytes
Platters	2	2
Recording Heads	4	4
Cylinders	306	480
Data Tracks	1224	1920
<b>Performance Specifications</b>		
Rotational Rate	3600 rpm ± 1%	
Data Transfer Rate	50 Mbits per second ± 1%	
Access Time	8.33 milliseconds ± 1%	
Average Latency	8.33 milliseconds ± 1%	
Seek Time		
Track-to-Track	3 milliseconds	3 milliseconds
Average	85 milliseconds	120 milliseconds
Maximum	205 milliseconds	310 milliseconds
Settling Time	15 milliseconds	
<b>Physical Dimensions</b>		
Height	5.3"	5.3"
Width	12.1"	12.1"
Depth	16.5"	16.5"
<b>Environmental Specifications</b>		
Operating Temperature	40°F to 95°F / 4.4°C to 35°C	
Non-Operating Temperature	32°F to 135°F / 0°C to 57.2°C	
Humidity (Non-Condensing)	8 to 80%	
<b>Power Requirements</b>		
Voltage	115V AC	
Power	75 Watts	
Q.C.S. reserves the right to change specifications without notice or obligation.		



## Quality Computer Services

178 Main Street ■ Metuchen, New Jersey 08840 ■ 201/548-2135  
Toll-free number: (800) 631-5944

Circle 387 on inquiry card.



grams in UCSD Pascal or Modula-2, I'll use the Sage, and I won't regret the extra \$1500 it costs.

As to our TRS-80 Model I, we trashed that sucker long ago. It was always unreliable, and repeated trips to the local Radio Shack outlet didn't help. The problem was that Tandy cut corners; I have a letter from a Tandy official referring to "the realities of the mass market." If you're selling 100,000 machines, saving five dollars a unit can be significant—both in profits to the maker and misery to the user. Our system internally generated so much radio noise that anything additional—even an airplane using Doppler radar!—could cause it to spontaneously reset.

We got the TRS-80 for the boys, but they were never happy with it. When they tried to use it, they might or might not be able to boot the system disk on the first try. There was always doubt as to whether they'd be able to save programs—or even save text they'd written. It was clearly an undesirable situation for young people learning to use and like

computers, and eventually I got rid of it.

Again, in fairness, I understand that a lot of people are happy with the new computers Tandy puts out. My point is that advertising budgets don't have that strong a correlation with system utility and reliability. Just because a system is advertised on national TV doesn't make it a good buy any more than "as advertised on NBC" is a guarantee that your new car won't be a lemon.

Unfortunately, computer stores aren't the answer either. Example. I acquired a well-cared-for, second-hand Apple II from Bjo Trimble, the *Star Trek* lady. It was an older machine.

I knew nothing about Apple computers. The boys pointed out that we had a bale of software, mostly Epyx games, that wouldn't run with the disk operating system that came with our Apple. They'd looked over the games and very much liked them, and birthdays were coming up . . .

I could, I suppose, have studied up on Apples; but there's a lot to do

here, and it wasn't convenient just then, so instead I packed the whole mess up and went out to Compuplus. After all, it specializes in Apples now, and I've been doing business with this outfit for more than five years, going back to the time when it was Computer Components and sold surplus equipment.

I arrived. Waited patiently. Got a salesman. Explained that I had an old Apple II, didn't know what boards were in it, and was interested in how to upgrade it.

The result could have been drawn up as a *Doonesbury* cartoon. The salesman cut loose with a string of jargon that certainly made no sense to me—and which I suspect couldn't have made sense to anyone else. He touted some games programs. I explained that I had plenty of games programs. He mentioned printers. I told him I had a printer.

I began to get the brush-off. Clearly, the commissions on bells and whistles for the Apple aren't worth a salesman's time; not that it mattered, because it also became clear that the

## Can a Software Package Change the World?



### Spread Sheets First... QUESTEXT™ Next!

- A Revolutionary New Micro computer Can get to Systems Developers and End Users Alike
- But One General Purpose Package and save buying dozens of specialized Programs
- **EASY TO LEARN** • **100% Menu Driven**
- **EASY TO LEARN** in one session • **No Programming**
- **ALLOWS INSTANTANEOUS INNOVATION** • **No A/DIMS**

QUESTEXT™ is a highly general purpose system for organizing and communicating textual information. It organizes text into tree-like structures. It is the first electronic WordPerfect, a generalist information handler.

Unlimited uses: Desk Diary, On-line help and documentation, Computer-aided instruction, On job training, Top-down software documentation, Writer's assistant: Electronic notes, Speech teleprompting, Classroom blackboard, Address/phonebook, Public access query (on answering), Calendar/diary, Scheduling/planning, Archiving, Library and File cabinet indexing, Observation logging, Personnel aids (locator service, job description, list of commands), Customer/New Products support and training, Technical information management, Diagnostic support, Quality control, Price/Product data, Electronic Publishing, Bulletin boarding, Tutorials

and updates for textbases, Personal computing (messages/reminders and notes/commitment management, date list inventory/scheduling, system protocols, procedures, etc.); Home Computing (insurance inventory, research management, etc.); Survey and experiment control. Much more. Unprecedented potential for construction-related and systems developers.

**FEATURES:** Easy updating; Cursor saving; Error trapping; English prompting; No syntax; Fast machine readable rules; Simple commands (Help, Show, Add, Delete, Insert, Move, Edit, Print, View, Un, Total, Garbage recycling, Easy file control (Create, Delete, Backup, Modify); **REQUIRES IBM PC or 2.5 MB CP/M, ASCII CRT WHO CAN USE QUESTEXT? ANYONE CAN!** Systems Developers, Business People, Educators, Criminals, Scientists, Programmers and Nonprogrammers alike!

SEE BELOW FOR ADVANTAGES OF EARLY ORDER. MONEY BACK OFFER ON MINI VERSION. PHONE ORDERS 617 369 5719 • OEM AND DEALER INQUIRIES WELCOME



Mail to: iRr, 158 Main Street, Concord, MA 01740

PLEASE SEND ME QUESTEXT III

Mini Version (40 lines, 4000 words, 500 records) (Shippable for 14 days of Mini Version)

1000000 word version

Full System (1000000 words, up to 4000 records, 20,000 records) (Shippable to May 20, 1983 (After May 20, 1983, \$149)

Manual Only

Substantiating data with applications

Add \$120 Postage and Handling

TOYAL COST

\*\$1500 (Mini Version only) to charge without return

IBM PC

2.5 MB CP/M

1000000 word

Manual only

Substantiating data

Applications

Quantity

Price

Postage

Handling

Total

Address

City

State

Zip

## In Less Than 3 Minutes

Your IBM Model 50, 60, 65, 75, or 85  
Electronic Typewriter  
can be an RS232C PRINTER or TERMINAL



CALIFORNIA MICRO COMPUTER Models 5060 and 5061 can be installed easily and require NO modifications to the typewriter.

For additional information contact:

CALIFORNIA MICRO COMPUTER  
9323 Warbler Ave., Fountain Valley, CA.  
92708 (714) 847-4141

# FORMULA INTERNATIONAL INC.

12603 Crenshaw Blvd., Dept. B, Hawthorne, CA 90250

For information (213) 973-1921 • Orders Only (outside Calif.) (800) 672-8758



# pineapple™

**The Alternative! The Compatible!  
The Affordable! 48K Color Computer Kit!**

### FEATURES:

- ★ Fully compatible with Apple® II+
- ★ Singleboard for easy assembly
- ★ Popular 6502 MPU for large amount of software
- ★ Game paddle connector on both sides of case
- ★ Built in 2-watt amplifier for realistic sound effect with volume control
- ★ 8 on board peripheral connectors for expansion
- ★ 14 key numeric key-pad
- ★ 5-amp switching power supply

**\$645<sup>00</sup>**  
EACH

(please add 5% shipping and handling)



Easy to assemble! All components are clearly silk-screened on the high quality double-sided mother board. All integrated circuits, IC sockets, peripheral connectors, keyboard, switching power supply and the professional high impact plastic case are included.

### 5 1/4" DISC DRIVE FROM QUANTUM

100% Made In USA 100% Apple and Pineapple™ Compatible  
50% Faster Seeking Time Than Apple Disk II Drive!



- 1 Year Full Warranty
- 40 Tracks
- One of the Most Quiet Drives
- Color and Shape same as the Disk II Drive

Disk Drive **\$285.00**  
Controller Card **\$ 65.00**  
Controller Card with 13 Sector, 16 Sector Auto Select **\$ 85.00**

### The APPLE II LOOKALIKE COMPUTER CASE

Made with high impact plastic.  
Color and shape are compatible with the APPLE II

Buy while they last  
**\$150 ea.**

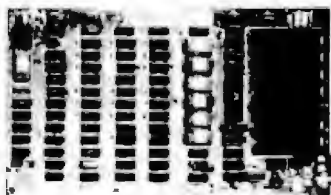
Keyboard not included with this price!



Model: APII

### 6502 CPU MOTHER BOARD

- 48K on board RAM (4116)
- 12K on board ROM (2716)
- Upper/lower case
- Composite-video output
- Apple II alternative
- Size: 14 1/4" x 8 1/2"



P.C. Board Only **\$99.00 ea.** Complete Component Pack **\$250.00**

**GUARANTEED TO WORK! BUILD IT IN 2 HOURS!**

### Big Savings On Peripheral Cards

Buy them in kit form.

All cards APPLE II and PINEAPPLE compatible.

80 column card kit . . . . .	\$120.00	EPR0M writer card kit (For 2708,2716,2732,2764,2532) . . . . .	\$89.50
Z80 GPM card kit . . . . .	\$110.00	Printer interface card kit (For Epson or Okj)	\$88.50
16K RAM card kit . . . . .	\$49.50	New disk controller card kit (3.2, 3.3 auto select) . . . . .	\$69.50
Disk controller card kit . . . . .	\$59.50	PAL Color Encoder card (assembled) . . . . .	\$88.50
RS232 interface card kit . . . . .	\$95.00		
16K RAM card (cable-less) kit	\$59.50		

### HEAVY DUTY SWITCHING POWER SUPPLY for Apple II, AP-II™ and Pineapple™ Computers

- +5V at 5.0 Amp
- +12V at 2.5 Amp
- 5V at 0.5 Amp
- 12V at 0.5 Amp



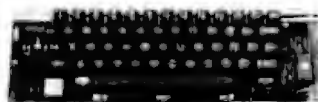
Model: THB-43H

Size and mounting holes are same as the ones used in the Apple II

**\$145.00 ea.**

### APPLE II+ COMPATIBLE KEYBOARD

- LSI keyboard decoder
- Upper/lower case function
- Full ASCII code output
- N-key rollover function
- LED ON/OFF indicator



LKB-3600-N

Keyboard Case

Keyboard Only **\$99.00 EA.** Plastic Case **\$35.00 EA.**

### 5 1/4" DISKETTE SALE

All diskettes soft sector single-side double density with hub rings.

		10 pcs.	100 pcs.
<b>wabash</b>	#M43A	\$21.50	\$195.00
<b>Verbatim</b>	#M525-01	\$26.50	\$240.00
<b>Scotch/3M</b>	#744D	\$26.50	\$240.00
<b>ATHANA</b>	#475001	\$19.50	\$175.00

Circle 200 on inquiry card.

Shipping & Handling Charges	
Under \$50.00	Under \$50.00
Purchase	Purchase
10%	5%
15%	10%
25%	20%

Minimum Order \$10.00/Calif. Residents add 6.5% Sales Tax. Phone Orders Accepted on VISA or MC ONLY. NO C.O.D.'s. Prices subject to change without notice.



**STORE HOURS**  
MON-FRI-10-7  
SAT-10-6

\*Apple and Apple II are the trademark of APPLE COMPUTERS, INC.

Inside California  
Outside Calif. (incl. Mexico & Canada)  
Overseas



salesman didn't even know what was available. He never mentioned any of the stuff I'd come prepared to talk about, like Pascal, or a Microsoft Softcard. Fortunately the cashier was well informed and took the trouble to give me some advice; without her, the trip would have been an utter waste of time.

Even so, I left thinking about a letter I got a year or so ago. It said, "Some day the salespeople in computer stores will be able to recognize a customer when they see one. Then maybe they can learn what to do when they find one . . ."

Some computer stores are excellent. Many more are not. Unfortunately, those who can tell the difference aren't the customers with problems; it's precisely those who need help the most who can't tell whether the help they're getting is of any use.

### So What Do You Do?

First, as I've said before; systems-integration consultants will earn their fees. True, Tony Pietsch isn't out looking for that kind of work now—but he was when I first met him. Filthy Pierre seems to have forgotten that when I met Tony he was a graduate student, and I was a science-fiction writer. This column grew out of my experiences, and, yes, I know I'm likely to get better than average treatment from people who know who I am now; but it wasn't always that way.

How do you find good systems consultants? How do you find any other professional help? The same principles apply. People who know what they're doing leave a trail of satisfied customers behind them. The really good ones don't hesitate to give references; their previous customers are their best salespeople.

Second, I do agree with Strauss on one point: unless you know what you're doing, don't go buy something brand new, particularly not from an outfit you never heard of. Wait for evaluations. Plenty of honest reviewers are in this field. Read what they have to say; and if all the reviewers ignore a system, ask yourself why. It may be we know

something. Most of us would rather write an enthusiastic rave than a negative review. I know I would.

Third, ask yourself what you really want. Most of the horror stories I hear come from readers who tried buying their systems a piece at a time at sale prices. You certainly can save some money that way; but even if you're pretty sharp, you'll pay with your time. Take Barry Workman's Lobo system as an example: he

---

## Unless you know what you're doing, deal with people who do; don't try to outsmart the system.

---

bought his disk drives on sale from Priority One. The Lobo worked fine first thing out of the box when connected to my Compupro drives; but it took a couple of days fooling with configuration jumpers to get it working with Barry's new Siemens drives. If he hadn't been here, with access to Priority One's helpful salespeople like Keith Burgess and able to call Nor Singh, it might have taken a lot longer.

And that, I think, is the real bottom line: unless you know what you're doing, deal with people who do; which is to say, don't try to outsmart the system. If people who seem to know about these small machines try to tell you that we haven't yet got to where a naive user can put together a business-quality computer complete with software for less than a couple of thousand dollars, perhaps you ought to listen.

I don't know any magic way to get a system dependable enough to bet your livelihood on—serviceable, convenient, complete with software—for so-called home computer prices. I do see a lot of computers, and I know what I'd buy as of this afternoon; but that's a different thing.

When Roland Green, the Chicago author who worked with me on my new book, *Janissaries II: Clan and Crown*, wanted advice on a first system, I told him to look at the Osborne. It's not an optimum system,

but I don't know a better beginner's package complete with software for a price Roland could afford.

When I went looking for a replacement for Ezekial, my dormant friend who happened to be a Cromemco Z-2, I did have an advantage the casual buyer doesn't have: I knew most of the major software developers, as well as a number of successful systems consultants. It seemed to me that people whose businesses depended on reliable equipment might have strong opinions on what was best; so I asked them what they used. When many more than half told me they had Compupro systems, it was enough for me, especially when I found that Tony had come to the same conclusion by studying the system specs; so that's what I bought. We sent in an order for the whole package direct to Compupro; and I haven't been disappointed.

When I go shopping again, I'll do the same thing; somehow I have more faith in the judgment of people like Richard Frank of Sorcim and Mike Lehman of Digital Research than in TV advertisements. But that, I hasten to say, is my view.

### JRT Pascal, Revisited

A few issues ago I mentioned that when my son Alex finished his Pascal Tutorial Package for the Pascal/M and Pascal/MT+ compilers, he intended to work one up using the \$29.95 JRT Pascal compiler.

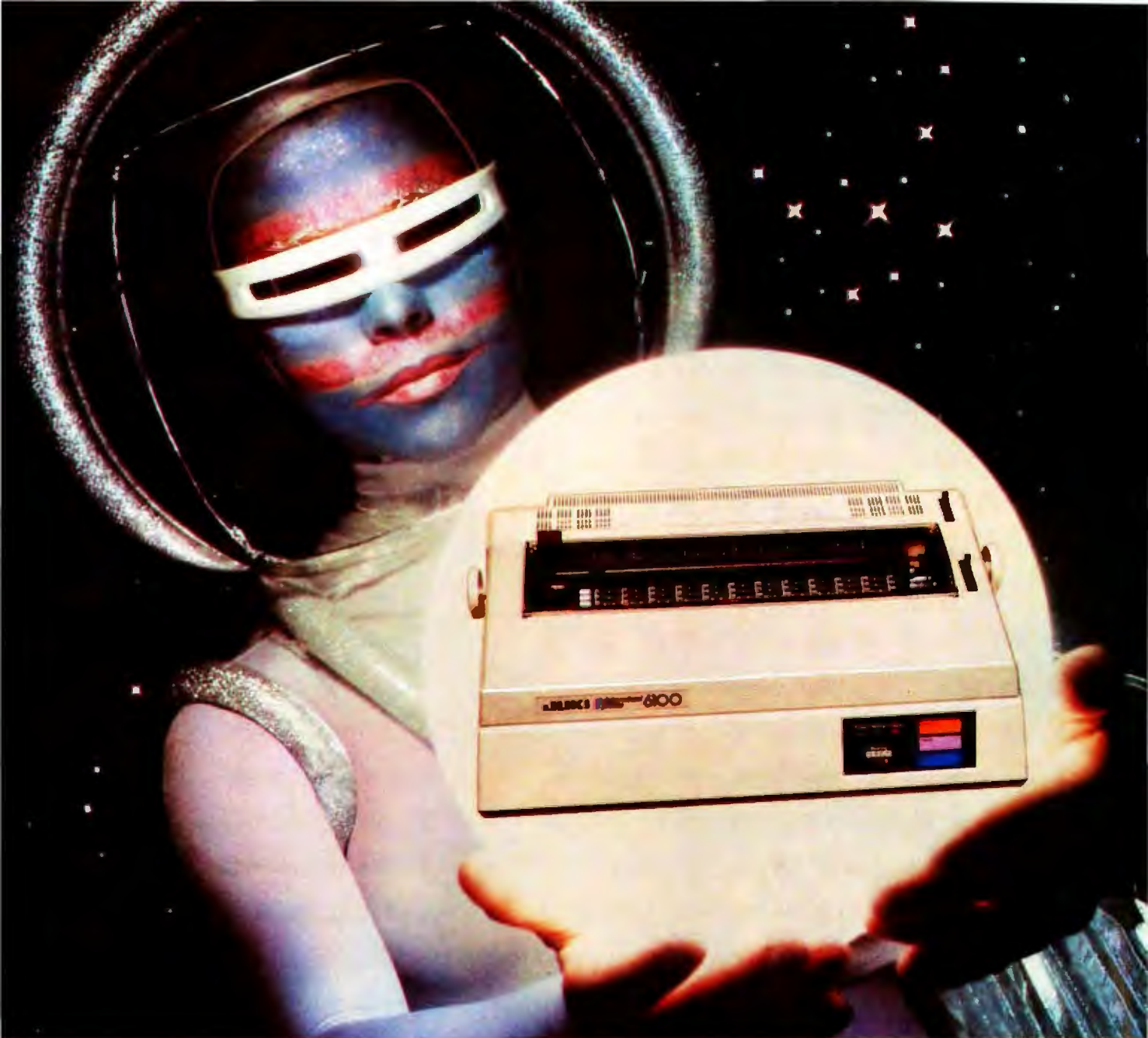
I was premature in that statement.

Alex, it seems, has a wild talent: he carries a Murphy field about with him. Whatever Alex works with, it is very literally true that if something can go wrong, it will. He also likes to work things to their limits.

Example: we were overhauling my Minimum Data Base for Barry Workman, and Alex found bugs and failure modes that must have been in there for years without my noticing them. When I fixed those, he found others.

Another example: when trying deliberately to create a run-time error to use as an example for the Pascal Introduction, he found that Pascal/M will cheerfully allow you to divide by 0. Not only does it not report an error, but it thinks that 3/0 =

*Text continued on page 314*



# The Juki 6100 printer. It should cost a lot more than \$699.

The new Juki model 6100 letter quality daisy wheel printer has full features you'd expect to find on a more expensive printer.

It can support word processing and graphic functions, print 18 CPS, and use a simple drop-in daisy wheel.

The 6100 has 10/12/15 pitch, proportional spacing, utilizes standard IBM Selectric typing ribbons, has 2K buffer memory (expandable to 8K), parallel interface, and both tractor feed and serial interface are available as options.

That's only the beginning.

Best of all, the low-noise Juki model 6100 is extremely reliable.

You can pay more, but you can't buy a better printer than the Juki model 6100.



Juki Industries of America, Inc.  
Head Office: 421 North Midland Avenue,  
Saddle Brook, NJ 07662. (201) 796-8800  
Branch Office: 20437 South Western Avenue,  
Torrance, CA 90501. (213) 320-9001

Circle 249 on Inquiry card.



# Number One Add-On

ALL PRODUCTS ARE  
XT COMPATIBLE!

## Communications

**NEW**

**Communications  
Products**

1. 5251 Terminal Emulator
2. Local Area Networking Product



### Advanced Comm. Card (AST-232)

- Programmable to communicate in Bisync, SDLC, HDLC, and Async protocols.
- Two Ports of RS 232



### CC-332 For use with AST-3780

- An IBM 2780/3780 RJE Emulator • Supports Bisync point-to-point communications protocol • Allows file transfer between Host & IBM PC • Ideal for IBM System 34, 38, 4300

### AST-SNA

- Emulates IBM 3274 Model 51C Control Unit
- Emulates 3278 Display Station
- Emulates 3278 Type Printer
- Optional 3770 Emulation
- Cluster Controller Operation
- Protocol Converter Support



### ComboPlus™

- Features 64K-256K Memory
- One Battery Backed-up Clock Calendar (std.)
- One IBM Compatible Async Port (opt.)
- One IBM Compatible Parallel Printer (opt.)

AST products are available from Computerland, Entre', ComputerMart and selected dealers worldwide.

SEE US AT BOOTH NUMBER 2  
April 26-29, 1983 Atlanta, Georgia



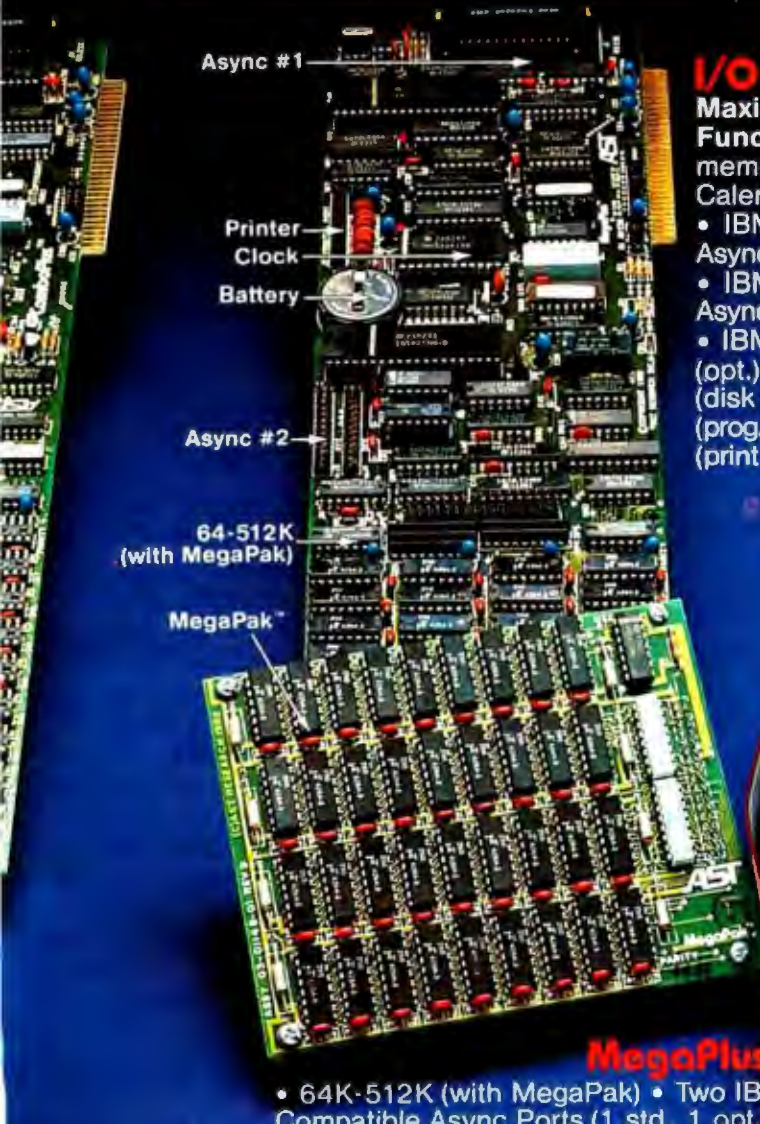
# Products for **IBM** PC

## Multifunction Cards

All Multifunction Products include:

- SuperDrive™ – a Disk Emulator Utility Program
- SuperSpool™ – a Printer Buffer Utility Program

Optional: New ConnectALL™ Connector Mounting Bracket



### I/O Plus™

Maximum 6 Functions (no memory) • Clock Calendar std.) • IBM Compatible Async Port #1 (std.) • IBM Compatible Async Port #2 (opt.) • IBM Printer Port (opt.) • SuperDrive (disk emulator prog.) • SuperSpool (print spooler prog.)



### ConnectALL™

NEW! AST Proprietary Connector Mounting Bracket (does not include cables shown in illustration)

Circle 4 on inquiry card.

### MegaPlus™

• 64K-512K (with MegaPak) • Two IBM Compatible Async Ports (1 std., 1 opt.) • One IBM Parallel Printer Port (opt.) • One Battery Backed-up Clock Calendar (std.) • Ideal for Concurrent CP/M, MBA, VISI Series software packages.

COMPEX

**AST**  
**RESEARCH INC.**  
Dealer Inquiries Welcome

2372 Morse Avenue  
Irvine, Calif. 92714  
(714) 540-1333



**Listing 1: Pascal/M compilation of the Silly program.**

```

prun pascal n:silly.pas
Source file name, options: N:SILLY.PAS,
2. S#1 P#1 SILLY lev1 (10234 bytes)
writeln(foo \); (* note undeclared variable *)
Line 5, Error #104 <sp> =continue, <cr> =quit?

writeln(foo)\; (* note undeclared variable *)
Line 5, Error #116 <sp> =contnue, <cr> =quit?

104: Undeclared identifier
116: Error in type of standard procedure parameter

1 Errors, 7 Lines, 10100 bytes not used. (ver 4.02)

```

0.0E-65, rather the opposite of what you'd expect infinity to look like. (Pascal/MT+ allows the division, but reports an error; it sets 3/0 equal to a very large number, which is more reasonable.)

Something like that happened in analyzing JRT Pascal. It seems there are bugs in the compiler. Not terribly serious bugs; indeed, we found nearly as bad in Digital Research's Pascal/MT+ and Sorcim's Pascal/M. There's a difference, though. Whereas Pascal/M and Pascal/MT+ try to be standard Pascal, with nonstandard extensions, the JRT Pascal compiler doesn't. JRT is intentionally a non-portable dialect, and programs written in JRT Pascal haven't a chance of running under any other Pascal compiler; worse, programs that will compile in standard Pascal blow JRT Pascal sky-high.

Worse yet, though, is the error handling. Pascal was designed as a teaching language, and it has a standard set of error messages. They are numbered and have a standard format, and experienced Pascal programmers know most of them by heart. For example:

```

Program Badhello (Output);
BEGIN
  writeln('Hello, world. ');
  writeln('Foo') (* note missing ; *)
  writeln('Hello again. ');
END {badhello}.

```

obviously isn't going to compile. Pascal/M and MT+ give you a standard message:

Error 6, Illegal symbol (possibly missing ; on line above)

which is probably the most common error encountered in Pascal. That error is rendered somewhat differently by JRT Pascal:

— Semicolon expected

This is reasonable, although it doesn't do much for teaching you what standard Pascal messages look like. However:

```

Program silly (output);
BEGIN
  writeln('Hello, world. ');
  writeln('Foo');
  writeln(foo); (* note undeclared
  variable *)
  writeln('Hello again. ');
END {silly}.

```

has far different results. The error messages generated by Pascal/M and Pascal/MT+ are shown in listings 1 and 2. These are about what you should expect. JRT Pascal generates the stuff shown in listing 3. Note that the only reference to an undeclared variable will have scrolled off the screen (it happens fast, too), and that there is no reference to the actual problem in the symbol table. The whole thing is pretty intimidating to someone just learning Pascal.

Pascal/M and Pascal/MT+ will show you where the error took place and offer you an opportunity to continue. JRT Pascal doesn't print the line, doesn't continue, and doesn't

**Listing 2: Pascal/MT+ compilation of the Silly program.**

```

mtplus n:silly.pas
Pascal/MT+ Release 5.5
© 1981 MT MicroSYSTEMS, Inc.

CP/M-80 version

Source lines: 7
Symbol Table Initialization
Available Memory: 19933
User Table Space: 15937
V5.5 Phase 1

Remaining Memory: 15975
V5.5 Phase 2
SILLY

```

Error # 104 at line 5  
Last ID: FOO

Type <space> or ^C

```

Lines : 7
Errors: 1
Code : 137
Data : 0
Pascal/MT+ 5.5 Compilation Complete

```

really identify the problem.

There has been a great debate in *Dr. Dobb's Journal* about JRT Pascal, with one reviewer contending that the language has its uses. He says it's a good production language for writing business programs and is certainly worth \$29.95. Another reviewer says it isn't acceptable at any price. I'm not going to get involved in that argument. I do say that it is *not* a language for beginners. It has funny bugs and gives confusing error messages.

Beginners don't have enough experience to know whether their problems are caused by flaws in the compiler or in their program. Add error messages not related in any obvious way to the error—there are lots more that I haven't room to show—and you have a situation tailor-made for undermining the student's self-confidence. Thus, Alex has decided against writing a version of his introductory package for the JRT compiler.

Those who know Pascal might find JRT Pascal useful; I'm told by experienced programmers that you can, if you're clever, program around its bugs. However, beginners should stay away from it, and anyone dis-

# Design, digitize, transform and dimension...all in 3-D!

## Introducing the Space Tablet™/Advanced Space Graphics™ System.

We see the world in three dimensions, not two. Now, there's an affordable, easy-to-use graphics system that lets you design, construct, manipulate and even dimension objects in 3-dimensional space . . . the Space Tablet/Advanced Space Graphics System.

### An added dimension.

The Space Tablet is a digitizer. It plots and records the X, Y and Z coordinates of any point in 3-space. To record a point, move the Space Tablet arm to the desired location and push a button. That's it. Lengthy keyboarding is unnecessary. Join points with line segments to create 3-D wireframe models, from real or imaginary shapes.

### Software flexibility.

Advanced Space Graphics is a true 3-dimensional CAD/D (computer aided design/drafting) system. It's designed to allow construction and manipulation of 3-D models using the 3-D Space Tablet, a high-res 2-D tablet or the keyboard as the data acquisition device. You can *interactively* manipulate and edit points in 3-D — a capability unique in computer graphics. Drawings can be altered in an endless variety of ways . . .

- Scale, rotate or move drawings about any axis.
- Create complex models by duplicating or mirror imaging components.
- Draw arcs and circles. Generate surfaces of revolution.
- Examine a drawing from 3 simultaneous orthogonal views while it's being constructed.
- Add text.

- Automatically dimension angles and lengths (5 ways) and watch them change accordingly as you alter the drawing.
- Drive several plotters or printers.

### Unleash your imagination.

All kinds of applications for the Space Tablet/Advanced Space Graphics System have already been developed . . . molecular modeling, architectural planning, irregular surface modeling for engineering and more. We see the Space Tablet/Advanced Space Graphics System as a tool to unleash your imagination. The possibilities are endless.

Examine the potential of 3-D CAD on your IBM PC (Apple II coming soon). The MCS Space Tablet/Advanced Space Graphics System — under \$1700, complete.

IBM PC minimal configuration:  
128K, game paddle adapter, color/graphics adapter.

Apple II Plus or Apple II E minimal configuration:  
64K, DOS 3.3.

### Special Offer

Send \$25.00 (in check or money order) to MCS for:

- 20-Slide Presentation and Owner's Manual.

or

- IBM PC or Apple II Demonstration Disk, plus hard copy plots and Manual.

Send \$50.00 for both. Please specify IBM or Apple for Demonstration Disk.

CT residents add 7½% Sales Tax. Prices subject to change without notice.

# MCS

Micro Control Systems, Inc.,  
143 Tunnel Road, Vernon, CT 06066  
(203) 872-0602





### Listing 3: JRT Pascal error message for the Silly program.

```
B>jrtpas2 silly
```

```
JRT Pascal ver 2.0
```

```
Copyright 1982 JRT Systems
```

```
0000 0001: Program silly (output);
0006 0002:         BEGIN
001B 0003:         writeln('Hello, world. ');
0026 0004:         writeln('Foo');
```

```
%Warning: Invalid dynamic storage address—possibly due to invalid variable or data type declaration.
```

	exproc name	addr	use cnt	time	stat
	PASCAL1	C9B6	0000	0004	30
	LEX	41EB	0000	008F	74
	PASCAL4	9FB2	0000	008B	30
	ADDMAIN	431E	0000	0000	74
	BLOCK	47D5	0001	0023	F4
	FIND	59E8	0000	0089	74
	PASCAL2	0001	0000	0000	00
	PASCAL3	A1CB	0001	0078	B0
	EXPR	5DSA	0001	0085	F4
	UPDATE	78AD	0000	0000	74
+	GEN	7AC6	0001	0090	F4
	FLDLST	0001	0000	0000	00
	PARMREF	7F08	0000	0000	74
	UPPER32	8344	0000	0003	74
	TEST	8367	0000	0000	74
	LEX2	83AB	0000	008E	74
	BIT6	85F0	0000	0088	74

```
addr :7CA6 prog :3F70 size :4872
base :87E2 cur :8F43 tos :8F66
low :9ED2 comprt :0000 purge :0000
```

```
@:TEMP2
```

```
%Error: Array index too small
```

couraged from Pascal by experiences with the JRT compiler might want to try something more standard before giving up.

### They're Getting There

There's good news and bad news from Digital Research.

There's a new manager in the documentation section of the languages division. His name is Michael Franusich, and he recently sent me a copy of the new CBASIC manual.

You may recall that I regarded the old CBASIC manual written by Gordon Eubanks at Compiler Systems as a really good example of what language documentation ought to be like; indeed, although I thought it could be improved, I hadn't seen any-

thing better. Then Digital bought out Gordon and revised the CBASIC manual to "technical writer" specifications, practically ruining it in the process. It removed most of the examples and all the text explaining the "philosophy" of the language.

Well, the good news is that the new manual is at least as good as the old Compiler Systems manual was, and in some ways is better. It contains plenty of examples, and most of the explanations are back in clear English.

Not only that, but I have drafts of the new manuals for CB-80 and CB-86 (CBASIC compilers that run on the 8080/Z80 and 8086/8088 respectively), and they're excellent too! In fact, I have letters from

Digital Research people claiming that it has been my constant hammering that caused the reforms there. I'm not sure I fully believe that, but it's nice to think I had a positive influence.

In any event, I think we can look forward to really significant improvements in Digital Research's documentation.

That's the good news.

### Alas, Poor SPP

The bad news is that Digital Research put out the new Pascal/MT+86 Reference Manual, and the manual for the MT+86 Speed Programming Package, before Franusich joined the staff; and lordy does it show.

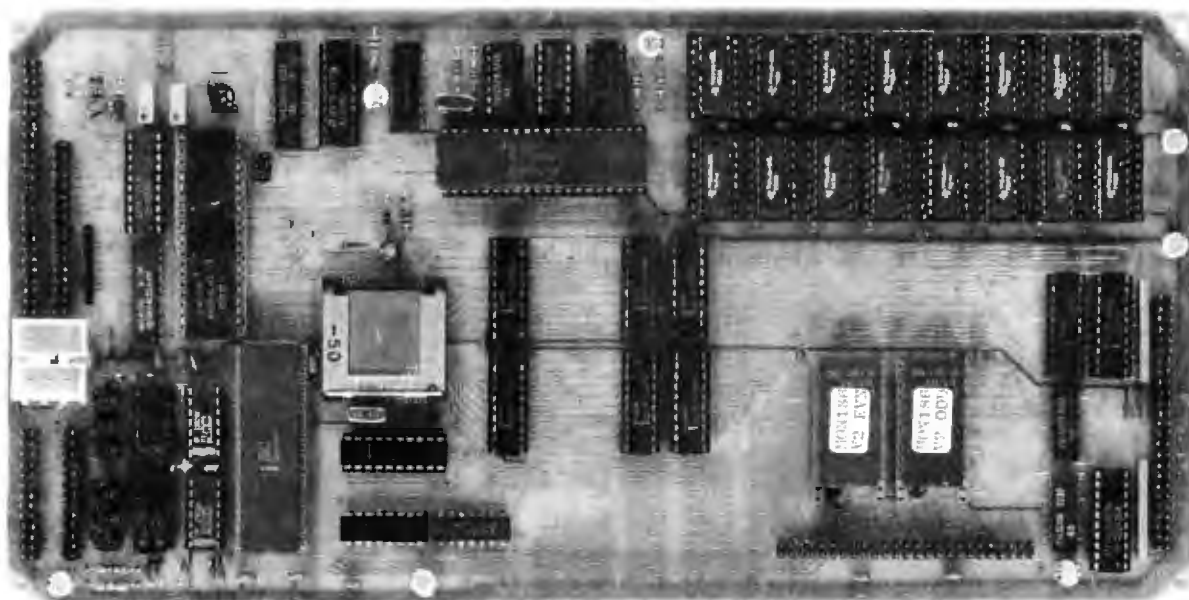
I'm a great fan of the Pascal/MT+ Speed Programming Package (SPP). That, you may recall, is a combination Pascal text editor, source-code formatter ("pretty printer"), and syntax checker that adds many of the best features of UCSD Pascal to the CP/M Pascal/MT+ compiler. It became even more important for Pascal/MT+86, because I don't have an editor that works under CP/M-86, and thus without the SPP, I couldn't write Pascal programs to run with my 8088.

Actually, that's not strictly true: thanks to the chaps at RR Software, I have Vedit for CP/M-86; alas, due mostly to sloth, I have not yet installed it, which isn't really fair to the Vedit people. I'll have to get it up if I'm going to use the 8088 side of my dual processor, since it is, at the moment, the only general-purpose editor I have that can work with the 16-bit processor.

Anyway, when Jim Hudson was over to show me how to use the 8087 math chip in combination with Pascal/MT+86, he helped me get the SPP editor installed, and it works fine, as does the MT+ compiler. Unfortunately, the old Digital Research "technical writing" staff got hold of the SPP documents and did for them about what it did for Eubanks' CBASIC manual. We did get lucky, though: the Pascal/MT+86 manual seems to be essentially unchanged from the last MT+ version, except for a global replacement of MT+

# STEP UP TO A 16-BIT POWERHOUSE!

## "THE SLICER"



The "SLICER" is a **HIGH PERFORMANCE** single board computer based on the new, highly advanced Intel 80186 CPU. The board has these advanced features:

- Full 8Mhz 16-bit microprocessor having complete software compatability with the 8086 and 8088 (as used in the IBM PC).
- Two full function RS232C serial ports. Both ports are interrupt driven with software data buffering.
- Floppy disk controller for 5¼ and 8" floppy disk drives, single or double sided, single or double density, using DMA operation.
- SASI hard disk controller port with DMA data transfer rate of up to 2Mb per second!
- 256Kb dynamic ram on board plus up to 32Kb EPROM.
- Bus expansion connector for future expansion.
- All this on a board the width of a 5¼" drive and only 11½ inches long!
- Sold as complete kit, partial kit, or bare board, with quantity discounts available.
- A high performance monitor ROM is included with all systems.
- Bios for CP/M86\* operating system included.
- Complete documentation included.

**This system is marketed and supported exclusively by:  
NUMERICAL CONTROLS, INC. 3438 Snelling Ave.  
Minneapolis, Minnesota 55406 (612)721-6353**

Mastercard, Visa, Check, Money Order, or C.O.D. orders accepted. Please allow 4-6 weeks for delivery.

\* CP/M a trademark of Digital Research Inc.

**CALL FOR SPECIAL INTRODUCTORY PRICE!!!!**



# StarLogic Announces More Disk Drive Savings

## TANDON DRIVES FOR IBM AND OTHER PERSONAL COMPUTERS

These basic drives can be mounted internally on IBM and other personal computers. Both full-size and the new ThinLine models are available.

TANDON TM100-1	\$165.00
TANDON TM50-1	\$145.00
TANDON TM100-2	\$235.00
TANDON TM55-2	\$215.00
TANDON TM-100-4	\$295.00
TANDON TM55-4	\$275.00
TANDON TM101-4	\$295.00
TANDON TMB48-1	\$350.00
TANDON TMB48-2	\$425.00

## APPLE II-COMPATIBLE DISK DRIVES FROM INTERFACE INC

Includes drive, cable and cabinet  
(also compatible with Apple look-alikes)

5 1/4" standard drive	\$205.00
ThinLine drive	\$185.00
Dual ThinLine drives	\$335.00

## EXTERNAL DRIVES FOR IBM PC FROM INTERFACE INC

Price includes drive, power supply, cable and cabinet.

100-1 with 160K IBM format	\$235.00
100-2 with 320K IBM format	\$305.00
55-2 with 320K IBM format	\$285.00
100-4 with 650K IBM format (includes software patch to DOS 1.1)	\$385.00
55-4 with 650K IBM format (includes software patch to DOS 1.1)	\$365.00

## WINCHESTER SUBSYSTEMS FOR IBM PC FROM INTERFACE INC

Includes Winchester disk drive, cabinet, power supply, cable, controller, I/O adaptor and software (JEL) for 1.1 DOS

5 Megabyte	\$1375.00
10 Megabyte	\$1575.00
15 Megabyte	\$1775.00

## IBM PC XT DISK DRIVES FROM INTERFACE INC

Dual floppy disk drives each with 362K bytes storage; both drives mount in "A" position \$ 450.00  
10 Megabyte Winchester Subsystem, Slave compatible with IBM DOS 2.0 \$1095.00

External floppy disk drives from Interface Inc are also available for the TRS-80 Model III, the Tandy Color Computer, and other personal computers.

All drives and peripherals have our standard warranty which includes 90 days parts and labor.

## TELEPHONE ORDERS ONLY

Only phone orders will be accepted. Master Card, VISA, Cashier's Check, COD accepted.  
(213) 883-0587

# StarLogic

20932 Cantara St.  
Canoga Park, CA 91301

Apple is a registered trademark of Apple Computer, Inc.  
IBM and IBM PC are registered trademarks of IBM Corporation  
TRS-80 is a registered trademark of Tandy Corporation  
ThinLine is a registered trademark of Tandon Corporation  
JEL is a product of Tall Tree Systems

Prices subject to change without notice.  
Prices do not include shipping charges which will be added to billing.

with MT+86. In fact, it's somewhat improved, with a few additional examples.

Of course, it does have that irritating "All Information Presented Here is Proprietary to Digital Research" inanity at the bottom of each page. Even so, although the manual is not what I'd call exemplary, it hasn't been ruined either; and with the new team in Digital Research's document foundry, we can hope for an update that will be a real improvement.

## Unmaligning the Osborne

In my December column I complained that the Osborne 1 lacks certain ASCII character keys. A dozen or more readers have written to tell me I was mistaken.

Although this is not documented anywhere that I (or any of those who wrote) know of, you can get the "missing" ASCII characters on the Osborne with the following key combinations:

Control-< produces { (Control-  
"less than" produces left curly  
brace)

Control-> produces } (Control-  
"greater than" produces right curly  
brace)

Control-/ produces - (Control-  
slash produces tilde)

Control-= produces \ (Control-  
equals produces accent grave)

I thank all those who took the trouble to inform me. Also, I appreciated the kind remarks many of you enclosed.

## Fastest Benchmark Yet

I continue to get new data using my matrix-multiplication "benchmark of sorts" from the October column. This "test" fills two matrices with real numbers, multiplies them, then sums their elements to give a checksum. Although the algorithm used to fill the matrices produces integers, the elements should be declared as real numbers.

For a time, the record was held by the Sage II running UCSD Pascal. Then Jim Hudson came over and installed his piggyback 8087 board that rides on the Compupro 816 dual-pro-

cessor machine, and that, running under Pascal/MT+86, took over the leadership.

Aaron Fox of the Department of Physiology at UCLA reports an even faster time. Fox writes:

*Recently our lab acquired several Lomas Data Products computers. This computer has a 10-MHz Intel 8086 processor operating with fast static memory. The October BYTE, with your matrix-multiplication benchmark, was of particular interest to me since it gave more times to test our Lomas against. For a 20 by 20 matrix the times for the Lomas were as follows:*

*2.9 seconds using Microsoft BASCOM-86  
34 seconds using Microsoft BASIC-86*

*Thus, the 10-MHz 8086 is about 7.5 times faster than your 8085 for BASCOM, but only about twice for MBASIC. It seems that the interpreted BASIC is not a fast implementation. (This may explain why all the benchmarks I have seen with the IBM PC running interpreted BASIC are quite similar in speed to the same programs running on a 4-MHz Z80.)*

*The point of this letter is that the 16-bit machines are fast and they are available with software today. As Sol Libes points out in the November BYTE, a 5-MHz 8086 is equivalent to 0.4 VAX, a fast and powerful machine . . .*

## The Word, Revisited

I've received several letters asking about spelling programs. This is a subject of considerable interest to me, and I think I have tried every spelling program available for my machines.

I continue to use Wayne Holder's The Word Plus program, version 1.2, from Oasis Systems. This version allows me to transfer the programs, plus the dictionaries, over to a pseudo disk for really fast operation. The Word Plus has a number of nice features, including the ability to look up the word in its dictionary; if it sees anything it thinks might be what you intended, it offers it as a candidate spelling and gives you the opportunity to correct the word.

The Word Plus is fast and easy to use, and it offers me a lot of information, such as a table of the words I've used sorted by frequency of use, thus allowing me to see how many times I've used "alas" and such like. (Do

# TIME-PROVEN PERFORMANCE



Now Available Nationwide  
Through Participating  
COMPUTERLAND Stores

While new printers with impressive specifications are introduced on an almost daily basis, only time will tell the true quality of the product. Over the past 2 years our customers have continued to buy the DS180 printer, not only because of its impressive performance and competitive price, but also because of our outstanding track record for product reliability and customer support.

We have continually improved on the performance of the DS180 by incorporating such enhancements as dot addressable graphics, 6 user-selectable print sizes and a 2000 character buffer. These features coupled with 180 cps printing, parallel and serial interfaces, adjustable tractor feed and over 40 other programmable features, make the DS180 one of the most versatile matrix printers available today.

Before you select your next printer, why not take a look at a time-proven performer—the Datasouth DS180.

The DS180 printer is available nationwide through our network of sales/service distributors.

**datasouth** computer corporation

P.O. Box 240947 • Charlotte, NC 28224 • 704/523-8500

Telex: 6843018 DASOU UW

Circle 158 on Inquiry card.



**What  
business does  
a handsome dog  
like me have  
with a  
top cat  
like  
you?**



My name's McGruff,<sup>TM</sup> and it's my business to help prevent crime. I think it should be your business, too—to teach your employees how to protect themselves. Just send for my business kit—it'll help you develop a program that teaches your employees how to make their homes burglar-proof, make their neighborhoods safer, even how not to get mugged.

And, while you're at it, get in touch with the cops—they can help you out. So now you're probably wondering (like a top cat businessman should), what's in it for you. That's easy. When your company works harder for your people, your people work harder for your company.

So take the time, and...

**TAKE A BITE OUT OF  
CRIME**

Write to McGruff, Crime Prevention Coalition,  
20 Banta Place, Hackensack, NJ 07601 for  
lots of information on Crime Prevention.

A message from the Crime Prevention Coalition,  
this publication and The Ad Council  
©1980 The Advertising Council, Inc.



people really prefer "unfortunately"? Alas, some have written to say they do.) The only improvements I'd make in The Word Plus have to do with defaults; I wish it would let me enter the name of the "specials" dictionary once and for all, instead of making me type in its name each time I invoke the program. That's hardly a major criticism. I can't imagine anyone not liking The Word Plus.

#### For All You Atari Users

Vincent Cate of USS Enterprises continues to improve his Critical Connection. This device lets you connect an Atari 800 to an RS-232C serial I/O port on a CP/M computer, and thereby use the CP/M system as the Atari's disk drive.

The device now lets your CP/M system simulate up to four Atari disk drives. We don't yet have an Atari 800 (I plan on getting one next month), so I've lent my test copy of the Critical Connection to an associate who does have both CP/M and an Atari. It works. Given the expense of Atari drives, and their slowness, anyone with an Atari and a CP/M system should seriously consider getting one.

#### When Shall We LISP?

One thing I'm greatly looking forward to is a good LISP running under CP/M-86. All the versions for the smaller microcomputers are very limited because 8-bit machines have such severe memory problems. (Hah. A sign of the times. I can recall when I thought 48K bytes of memory would be plenty, and 64K bytes more than enough for any purpose.)

Meanwhile, various friends keep urging me to try LISP. "Anything you can do in Pascal or BASIC you can do much quicker and more elegantly in LISP," they tell me. "How are you going to learn about artificial intelligence without it?" When I protest that I just don't know enough about LISP, they send me books.

So far I've successfully resisted learning LISP, but once there's a good version for my 8088 I fear I'll be doomed. Meanwhile, I can look over the books.

One, *Programmer's Guide to LISP*

by Ken Tracton, is the darndest thing I ever saw. Some of it is absolutely clear, the easiest to understand discussion of parts of LISP that I've yet seen. Some of it is absolutely opaque. The really odd part, though, involves strange omissions.

The index, for example, is horrible. Many of the most important terms and concepts in LISP simply aren't there. No CONS, no CAR, no CDR, no LAMBDA. In another place there's a glossary of sorts, but some of the definitions are frivolous (LAMBDA—something like DEFINE), while others (CONS, for example) are not there at all.

This sloppiness seems typical of Tab Books, which must employ the laziest and most incompetent copy editors in the publishing business; comic books have fewer typos. Also, cheap paper and an unaesthetic typeface are used.

For all that, I found Tracton's book rather valuable, since it does give a lot of examples, and much of the beginning discussion is clearer than I've seen anywhere else. It's a pity his publisher didn't think enough of his book to assign it a decent editor.

#### Let It GOTO Blazes . . .

Jeffrey Savit of the Savvy Computing Company writes at length about my (mild, I thought) defense of the GOTO statement in the December column. He says:

*One way to think about this is to consider that the problem with the GOTO is not always the GOTO itself, but rather the label it arrives at. First, there is no enforced textual relationship between the GOTO and the target label. If the GOTO is being used as an escape from a loop, the label will appear immediately after the loop body, but there is no way for the compiler to know it was intended as an escape if the label is accidentally placed elsewhere in the program . . .*

*The other problem with the label is that its presence means that there is less knowledge about the state of the program at the program text that follows it. The code after a label could have been reached by falling through the preceding text, or from any of the statements that GOTO the label. To understand this piece of the program the reader has to examine the entire program for GOTOs that might land there.*

**I/O-Plus 2**  
**\$135**

**MegaPlus 64k**  
**\$299**

## Now you can buy a QUAD function IBM PC board without having to buy more memory.

MegaPlus™ and I/O-Plus 2™ are the ultimate add-on products you will need to expand your IBM PC and XT. Which board you decide on depends on where you are headed. To take full advantage of your IBM PC and XT beyond 256k, you will want to expand with the MegaPlus™. It's features include two asynchronous ports, clock/calendar, printer port, and up to 512k of memory expansion. Ah! You say you already have all the memory you need? The I/O Plus 2™ gives you all the features of Mega-Plus™ to operate your printers, plotters and modems, set your time and date automatically with the clock/calendar, without adding memory. Also a special game adapter is available, but more about that later. Both boards include SuperDrive™ disk emulation and SuperSpool™ print buffer software.

### MEGA WITH MEMORY

The MegaPlus™ has three functions standard: Parity checked and fully socketed memory up to 256k in 64k increments; clock/calendar with battery back-up for automatic loading of time and date when the computer is turned on; and an asynchronous communication port (RS232C serial) which can be used as COM1 or COM2, (DTE for a printer, or DCE for a modem). Optional is a 100% IBM compatible parallel printer port, and a second asynchronous port for another \$35 each. The MegaPak™ option plugs onto your Mega-Plus™ "piggyback" style to give you 512k of additional memory. Now you can create disk drives in memory up to 360k, set aside plenty of space for print spooling, and still have memory for your biggest programs.

### I/O-PLUS 2 WITHOUT MEMORY

The I/O-Plus 2™ comes standard with a clip-on battery powered clock/calendar, and asynchronous communication port (RS232C serial). Optional is a second asynchronous port (DTE for a printer, or DCE for a modem), a parallel printer adapter, and the best game paddle adapter on the market. What's so special about our game adapter? Not only is it an IBM standard game port, but it can also use low cost, widely available Apple compatible paddles and joysticks. If your memory needs are satisfied, for less than the price of most single function boards, I/O-Plus 2™ gives you all the input and output ports you might need.

### FREE SOFTWARE

SuperDrive™ disk emulation software creates "disk drives" in memory which access your programs at the speed of RAM memory. SuperSpooler™ print buffer software allows the memory to accept data as fast as the computer can send it and frees your computer for more productive work. Some manufacturers sell hardware print buffers that do only this for hundreds of dollars. SuperSpooler™ eliminates the need for these slot robbing products. Both of these powerful pieces of software can be used with any expansion memory for your IBM PC or XT.

### CHEAP SOFTWARE TOO

What good is great hardware without some great software to use it with? We offer some terrific prices on some of the popular programs you will want to use your board with. How about the cream of the spreadsheet programs, SUPERCALC, for just \$159, or SUPERWRITER for \$239. If you are looking for data base management you can get dBASE II by Ashton-Tate for \$419, or 1-2-3 from Lotus for \$369.

### WHY BUY IT FROM US?

Because we provide the service and support most companies just talk about. Each board is fully tested and burned in prior to shipment. We realize how integral this board is to the use of your computer. What good is a warranty if it takes weeks for repairs to be made? We offer 48 hour turnaround or a replacement board on all warranty repairs. Do you hear anyone else making this promise? If you still are not convinced, and want to compare prices, remember we don't charge extra for credit cards, shipping, or COD fees. We think the ultimate testimony to our good service and high quality is that one of our largest customers is none other than IBM! If you still want to buy elsewhere, ask any competitor if they will face the acid test.

### THE ACID TEST

Qubie' (say que-bee-A) gives you a 30 day satisfaction guarantee on all board purchases. If you are not completely satisfied we will refund the entire cost of your purchase as well as pay the postage to return it. If you can get one of our competitors to give you the same guarantee, buy any other board you think compares and return the one you don't like. We're not

worried because we know which one you will keep. We also offer a one year parts and labor warranty. An additional one year extended warranty is available for \$50.

### TO ORDER BY MAIL SEND:

- your name and shipping address
- board type, size, and options requested
- daytime phone number
- California residents add 6% sales tax
- company check or credit card number with expiration date (personal checks take 18 days to clear)



### TO ORDER BY PHONE:

In California (805) 482-9829

Outside California

TOLL FREE 821-4479

### PRICES:

I/O-Plus 2™ with Clock/calendar, asynchronous communication adapter, SuperDrive™ and SuperSpool™ - **\$135**

MegaPlus™ with memory, clock, async, SuperSpool™ and SuperSpool™ software:

64k	\$299		
128k	\$349	256k	\$449
192k	\$399	512k	\$798

### OPTIONS:

Parallel Printer Port	\$35
Second Async Port	\$35
Game Adapter (I/O-Plus 2 only)	\$35
MegaPak™ with 256k of memory	\$349
Cable to parallel printer	\$35
Cable to modem or serial printer	\$25
Memory Diagnostics Program	\$10
1-2-3 by Lotus	\$369
SUPERWRITER by Sorcim	\$239
SUPERCALC by Sorcim	\$159
dBASE II by Ashton-Tate	\$419

### SHIPMENT

We pay UPS surface charges. UPS 2 day air service \$5 extra. Credit card or bank check orders shipped next day.

## QUBIE' DISTRIBUTING

4809 Calle Alto  
Camarillo, CA 93010

European Inquiries:  
129 Magdalen Rd.,  
London, SW18, England  
Phone (01) 870-8899



## Items Reviewed

<b>JRT Pascal</b>	\$29.95	<b>Sage II Computer</b>	\$3600
JRT Systems 1891 23rd Ave. San Francisco, CA 94122 (415) 566-5100		Sage Computer Technology Suite 4 35 North Edison Way Reno, NV 89502 (702) 322-6868	
<b>M-Drive/H</b>	\$1895	<b>Semidisk</b>	512K \$1995
Compupro Systems Oakland Airport, CA 94614-0355 (415) 562-0636		Semidisk Systems POB GG Beaverton, OR 97075 (503) 642-3100	1 megabyte \$2995
<b>Max-80 Computer</b>	\$820	<b>Speed Programming Package</b>	8-bit \$200
Lobo Drives International 358 South Fairview Ave. Goleta, CA 93117 (800) 322-6103 (California) (800) 235-1245 (outside California)	with extra 64K-byte memory \$915	Digital Research POB 579 Pacific Grove, CA 93950 (408) 649-3896	16-bit \$250
<b>Minimum Data Base</b>	8-inch \$84.50	<b>The Critical Connection</b>	Not available
<b>Pascal Introductory Package</b>	8-inch \$79.50	USS Enterprises 6708 Landerwood Lane San Jose, CA 95120 (408) 997-0264	
Workman and Associates 112 Marion Ave. Pasadena, CA 91106 (213) 796-4401		<b>The Word Plus</b>	\$150
<b>Modula-2 Compiler</b>	\$495	Oasis Systems Inc. 2765 Reynard Way San Diego, CA 92103 (619) 291-9489	
Volition Systems Inc. POB 1236 Del Mar, CA 92014 (619) 481-2286	for Sage II (including text editor) \$595	<b>Osborne 1</b>	\$1795
<b>Osborne 1</b>	\$1795	Osborne Computer Corporation 26500 Corporate Ave. Hayward, CA 94545 (415) 887-8080	
<b>Printmate 150 Impact Dot-Matrix Printer</b>	A1 \$1125	<b>Programmer's Guide to LISP</b>	\$10.95
Micro Peripherals Inc. 4426 South Century Dr. Salt Lake City, UT 84107 (801) 263-3081	B1 \$995	Ken Tracton. Blue Ridge Summit, PA: Tab, 1979.	paper \$6.95

## Book Reviewed

**Programmer's Guide to LISP** \$10.95  
Ken Tracton. Blue Ridge Summit, PA: Tab, 1979. paper \$6.95

Certainly it is possible to comment both the GOTO and the label to the effect that one and only one GOTO refers to that label, and that it is being used to escape from a loop, but that is precisely what a "leave" or "break" does without depending on the programmer not making a mistake . . .

On reflection, I agree with what Mr. Savit has said here. In my defense I'll point out (1) that Pascal has no "break," and my column speculated that a GOTO used as a substitute for "break" would do no harm, and (2) that "break" is one of the proposed extensions for the Pascal Prime Project.

In any event, Modula-2 has "break," and has no GOTO whatever; so if Modula-2 takes over from Pascal, this is one debate that will swiftly become history.

### Coming Attractions

I much enjoyed COMDEX, not only for the software and equipment I saw, but for the people I met. For example, at the Zenith party I met John and Sue Matlock of Micro Peripherals Inc. of Salt Lake City. John had connected an MPI impact dot-matrix printer to a Zenith Z-100, and the printer was merrily making hard

copy of everything that appeared on the Z-100 screen: words, symbols, graphics, swirls, and squiggles.

I've never had a dot-matrix printer, but that looked interesting. I got to talking with John Matlock about it.

The upshot was that in the next room sits an MPI Printmate 150 impact dot-matrix printer. Although it can be configured for driving by an RS-232C (serial) port, this one happens to expect a Centronics-style parallel input. There's a Centronics port on the Interfacer-4 board in my dual-processor system, but I don't recall precisely how Tony wrote that

# 10 reasons why you should call DataSource® for software...

- 1. Free Systems Analysis** We have developed a variety of self-administered analysis tools to help you identify those products best suited to meet your needs
- 2. Competitive Prices** Our volume enables us to offer you prices which are consistently competitive. Compare for yourself, then call us toll-free 800-328-2260.
- 3. Express Delivery** Time is money and we at DataSource understand that. Your order will be processed and shipped within 24 hours for all products in stock.
- 4. Discount Structures** We offer significant discounts to any individual, organization or user's group purchasing in quantity.  
**Key Account Program** For corporations and institutions, we offer a comprehensive program: volume discounts, complete maintenance packages, specially staffed technical support, a sales team experienced in micro applications, and several financing options.
- 5.**
- 6. Risk-Free Software** We stand behind every product we sell. All items are fully documented, backed by manufacturer's warranties, and are guaranteed by DataSource to be in perfect working condition.
- 7. Toll-Free Technical Support** We service what we sell. Our customers have direct access to our technical staff on a toll-free basis, 800-328-2260.
- 8. National Maintenance Network.** We offer a variety of maintenance agreements tailored to the specific hardware items you select. Call for more information.
- 9. Flexible Payment Options** We accept most major credit cards, checks, and money orders, as well as purchase orders from approved corporate accounts.
- 10. State-of-the-Art Software and Hardware** We carry a broad range of what we believe to be the best in software plus carefully selected hardware products and accessories.  
**Always the current versions in stock.**

Here's a small sampling of products available now from DataSource.<sup>®</sup>  
(If you don't see what you need, just call us at the number below.)

<b>Data Base Management</b>		<b>Languages</b>	
dBase II - Ashton Tate	\$475.00	C Basic - Digital Research	125.00
Condor III - Condor computer	495.00	CB 80 - Digital Research	420.00
Easy Filer - IUS	295.00	M Basic - Microsoft	275.00
VisiFile - Visicorp	189.00	Basic Compiler - Microsoft	310.00
Tim III - Innovative Software	325.00	Pascal MT+ - Digital Research	425.00
Infostar - MicroPro	297.00		
<b>Spreadsheets</b>		<b>Miscellaneous</b>	
Supercalc - Sorcim	125.00	The Home Accountant - Continental	110.00
Visicalc - Visicorp	189.00	Milestone - Organic Software	245.00
Lotus 1-2-3 - Lotus	Call	Statpak - NW Analytical	395.00
Multiplan - Microsoft	225.00	The Norton Utilities - Peter Norton	65.00
Calcstar - MicroPro	95.00		
<b>Communications</b>		<b>Hardware</b>	
CrossTalk - Microstuf	135.00	Hayes 300 Smartmodem	215.00
Move it - Woolf software	99.00	Hayes 1200 Smartmodem	525.00
		Epson FX80	595.00
		Okidata 82-A	439.00
		NEC 3550	1915.00
<b>Word Processing</b>		<b>June Specials from DataSource</b>	
Wordstar - MicroPro	297.00	Supercalc - All Formats	<b>\$125.00</b>
Spellbinder - Lexisoft	295.00	Microsoft Basic Compiler - Osborne	<b>\$235.00</b>
The Final Word - Mark of the Unicorn	245.00	<b>PLUS</b>	
Easy Writer II - IUS	265.00	<b>Sale prices on all Osborne Format software in stock!</b>	
Volkswriter - Lifetree	155.00		
The Word Plus - Oasis	125.00		
Spellguard - Sorcim	125.00		
Grammatik - Aspen	60.00		

FOR MORE INFORMATION CALL TOLL-FREE

**1-800-328-2260**

IN MINNESOTA, CALL 612-544-3615

Purchase orders accepted from corporate accounts. All orders are shipped UPS.  
\$7 shipping charge on software items. 2% shipping charge on hardware items.

**DATASOURCE**

DATASOURCE SYSTEMS MARKETING CORP.

Your source for micro software and hardware<sup>®</sup>

1660 South Highway 100, Minneapolis, MN 55416

Circle 512 on inquiry card.





# Real-Time C

for 8080, Z80

## A Run-Time Library for Whitesmiths' C 2.1

- Fast execution
- ROMable
- No royalties
- Fully reentrant machine support
- CP/M file support
- Error checking
- Usable with our AMX Multitasking Executive

**Real-Time C**      \$ 95  
 manual only      \$ 25  
 source code      \$950

Intel mnemonic    \$ 50  
 to A-Natural converter

### Benchmarks

1. Int to ASCII conv.
2. Long to ASCII conv.
3. Long random number generator
4. Double 20 x 20 matrix multiply
5. File copy (16kb)



■ with Real-Time C  
 □ without

4 Mhz Z80, 8" 5D diskette. Time: (min. : sec.), with processor, disks, etc.

AMX and Real Time C are trademarks of KADAK Products Ltd.  
 A Natural is TM of Whitesmiths Ltd. CP/M is TM of Digital Research Corp.  
 Z80 is TM of Zilog Corp.

### KADAK Products Ltd.



206-1847 W. Broadway Avenue  
 Vancouver, B.C., Canada V6J 1Y5  
 Telephone: (604) 734-2796  
 Telex: 04-55670

## The Serious Game Design Tool For The Serious Designer At The Price Of A Toy For The Hobbyist

The Game Cartridge Development System for the Atari™ 2600 Video Computer System™  
 Optional:  
 Atari 5200 Supersystem Adapter Package.

The FROB-26™

**Features Include:**  
 Real-time development  
 No machine modification  
 Apple II™ 48K/ one disk drive required.

Now Only \$495  
 Call today to order  
 408-429-1551  
 All major credit cards accepted.

For high profit rewards, purchase the tool that can do the job at an unbeatable price.

**frobco**

A Division of Tri-comp Polytechnical, Inc.  
 P.O. Box 8378, Santa Cruz, CA 95061  
 408-429-1551

The Miracle of Creation Can Be Yours™



Atari and Apple are registered trademarks of Atari, Inc. and Apple Computer, Inc., respectively. Video Computer System is a trademark of Atari, Inc.

into the BIOS. Since he's in Arizona just at the moment, I can't hook up the Printmate 150 for a test run, although I expect to have it running next week.

Meanwhile, there's one hitch. Although it will work with a great many machines, a specific design goal of the Printmate 150 was that it would work with the Zenith Z-100 computer. The Zenith Z-100 was designed to be able to run IBM PC software, and as a result has the same hardware for connecting peripheral devices as does the PC. When IBM designed the PC, for some totally inexplicable reason it chose to put the same physical cable connectors on its Centronics-style parallel output port that other people use as RS-232C plugs and jacks.

This means that I have a printer expecting parallel input through a connector into which I can plug a serial input. Because the RS-232C cable carries 16 volts in pins that the Centronics port expects to have only signals, a mistake can blow up a fair number of chips. Worse, both the PC and the Z-100 have both serial and parallel outputs coming out of identical plugs, practically guaranteeing confusion. This is a disaster waiting to happen.

I hope to avoid the problem so that next month I can report on my new printer.

We've also just received a disk containing the source code to the Otrona's BIOS. Tony has been looking forward to playing with that; he has some improvements in mind. He's already got WRITE, my favorite text editor, transferred to the Otrona, so that I was able to take the Otrona to COMDEX and write up a good part of my trip report in my hotel room.

More on the Otrona, the new printer, and Modula-2 next month. ■

*Jerry Pournelle welcomes readers' comments and opinions. Send a self-addressed stamped envelope to Jerry Pournelle, c/o BYTE Publications, POB 372, Hancock, NH 03449. Please put your address on the letter as well as on the envelope. Due to the high volume of letters, Jerry cannot guarantee a personal reply.*

# Complete Integrated Accounting System

Just plug it into your  and run your business!

INTEGRATED ACCOUNTING SYSTEM

GENERAL LEDGER

ACCOUNTS RECEIVABLE

BILLING

INVENTORY

ACCOUNTS PAYABLE

PAYROLL

WORD PROCESSOR - WORDSTAR™

SPELLING CHECKER

MAILING LIST - MAILMERGE™

Electronic Spreadsheet - REPORT MGR.

The best business program package on the market . . . providing all the software and storage you ever wanted.

- All programs self-prompting & menu driven
- Completely integrated accounting system
- General Ledger includes a chart of accounts developed by a CPA
- Has been in use for four years
- High speed operation
- All software pre-installed on hard disk and ready to run. No more diskettes & tedious paper work
- Self-explanatory . . . easy to use
- All software & hardware fully guaranteed & supported

CP/M® &  
APPLE®  
VERSIONS  
AVAILABLE  
SOON



5 MB WINCHESTER DISK  
plus ABOVE LISTED SOFTWARE  
in ONE INTEGRATED PACKAGE

**\$2,995<sup>00</sup>\***

\*Auxiliary Power Booster Required \$195.  
\*128K RAM Required.

10 MB Model available at

Dealer  
Inquiries  
Invited

Contact your  
local dealer or  
call us

## The Business Manager®

1420 E. Edinger Ave., Suite 115, Santa Ana, CA 92705

**(714)836-3569**

Circle 77 on Inquiry card.

IBM is a Reg. trademark of IBM Corp. Apple is a Reg. trademark of Apple Computers. CP/M is a Reg. trademark of Digital Research. Wordstar and Mailmerge are Reg. trademarks of MicroPro International. \*Prices and specifications subject to change without notice.



# Book Reviews

## Microprocessor Systems, Interfacing and Applications

Robert J. Bibbero and David M. Stern  
John Wiley & Sons  
1982; 192 pages  
hardcover, \$26.95

Reviewed by  
Dr. William H. Murray  
Computer Science Dept.  
Broome Community College  
Binghamton, NY 13902

*Microprocessor Systems, Interfacing and Applications* is an excellent introduction to microprocessors and data links in terms of signal paths and communication functions. Technically up to date and very readable, the book is aimed at "engineers, students, technicians, and managers who use microprocessors and design them into new devices and systems."

Wisely, Robert J. Bibbero and David M. Stern based their discussion not on a particular chip or family of processors but on a well-balanced cross section of current chips. In doing so, the authors successfully integrate the main concepts of their

book throughout its seven chapters. To illustrate how they do this, I'll look at several chapters.

In the first two chapters, the authors quickly review digital logic and microprocessor fundamentals. As you might expect, they cover such topics as number systems, base changes (including fractional numbers), digital logic gates, and the architecture and instruction sets of popular microprocessors. Unfortunately the authors "squeezed" the three topics that form the cornerstone of their book into the first chapter. Address decoding, signal driving over transmission lines, and timing deserve closer examination; more examples would have helped. A detailed discussion of benchmarks in chapter two merits attention.

Chapter three addresses the problems of transmitting data. Logically presented with many helpful details, the discussion goes from signal buses to drivers and systems that include parallel and serial transmission of data. Particularly noteworthy is a section on microprocessor buses.

In chapters four and five,

Bibbero and Stern contrast programming languages for microprocessors. Chapter four, devoted exclusively to BASIC, includes a good discussion of top-down structuring, flowcharting, algorithm development, and high-order languages. Unfortunately, the chapter is unspecific as far as actually writing BASIC programs goes. Chapter five looks at high-level languages such as FORTRAN, PL/I, FORTH, C-Code, and Pascal in terms of common points and strengths and weaknesses. More programming examples would have enhanced the discussion.

The chapter on device displays is typical of what you might find in most books on microprocessors. It describes the most popular displays, including seven-segment devices and CRTs.

Chapter seven deals exceptionally well with multiple microprocessor communication. Topics range from hierarchical processing layers, architecture and protocols of networks to topology, routing, and protocol. Ethernet and Proway are used to illustrate communications networks that operate between computers and micropro-

cessor terminals.

I have just a few minor squabbles with the book as a whole. Because *Microprocessor Systems, Interfacing and Applications* covers so many topics in so few pages (192), many details are left out. For example, in the section that deals with addressing and decoding the authors give no examples of how an address decoder actually decodes. The authors attempt to illustrate several programming languages with examples, but again leave you begging for a few more details. And just a minor annoyance, but noteworthy, is that illustrations of digital logic gates do not conform to industry drafting standards.

Readers who have worked with digital electronics or microprocessors should have no difficulty with the concepts presented or vocabulary used. In fact, the text may be too elementary for experienced engineers, technicians, and managers. It is an excellent primer on the microprocessor and data link in terms of signal paths and communication functions and would be particularly useful in classroom instruction. ■

## C compilers

HOST	6809 TARGET	PDP 11*/LSI 11* TARGET	8080/(280) TARGET	8088/8086 TARGET
FLEX*/UNIFLEX* OS-9*	\$200.00 \$350.00	500.00	500.00	500.00
RT 11*/RSX 11* PDP 11*	500.00	200.00 350.00	500.00	500.00
CP/M* 8080/(280)	500.00	500.00	200.00 350.00	500.00
PCDOS* CP/M86* 8088/8086	500.00	500.00	500.00	200.00 350.00

\*PCDOS is a trademark of IBM CORP. MSDOS is a trademark of MICROSOFT. UNIX is a trademark of Bell Labs. RT-11/RSX-11/PDP-11 is a trademark of Digital Equipment Corporation. FLEX/UNIFLEX is a trademark of Technical Systems consultants. CP/M & CP/M86 are trademarks of Digital Research. OS-9 is a trademark of Microware & Motorola.

### • FULL C

### • UNIX\* Ver. 7 COMPATABILITY

### • NO ROYALTIES ON GENERATED CODE

### • GENERATED CODE IS REENTRANT

### • C AND ASSEMBLY SOURCE MAY BE INTERMIXED

### • UPGRADES & SUPPORT FOR 1 YEAR

C SOURCE AVAILABLE FOR \$2500<sup>00</sup>

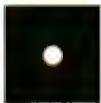
408-275-1659

TELECON SYSTEMS

1155 Meridian Avenue, Suite 218

San Jose, California 95125





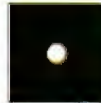
### MDBS III™

Mainframe-quality DBMS from  
Micro Data Base Systems, Inc.  
International Software Enterprises—USA  
(312) 981-9200



### ACCOUNTING PLUS™

A comprehensive microcomputer  
business accounting system.  
SOFTWARE DIMENSIONS, INC.  
(916) 722-8000



### QUICK CHECK™

Computer simplified bookkeeping  
and point of sale inventory.  
CHUCK ATKINSON PROGRAMS  
(817) 249-0166



### INMASS™

Integrated Manufacturing and  
Accounting Software System  
MICROCOMPUTER CONSULTANTS  
(916) 756-8104



### DATA COMMUNICATIONS SOFTWARE

ASYNC, BISYNC & SNA-SDLC protocol  
data communications software.  
IE Systems, Inc. & Micro-Integration, Inc.  
(603) 659-5891



### PC/FORTH™

Program development systems for Z-80  
and 8086/88 microcomputers  
Laboratory Microsystems, Inc.  
(213) 306-7412

# WHEN YOU BUY THE RIGHT SOFTWARE, YOU CAN'T GO WRONG ON THE HARDWARE.

CP/M® compatible software — for maximum  
work power on more than 600 computer models.

All the computers in the world won't help you without smart software. That's why we're showing some of the best software products you can buy, from solid, innovative companies. They're shown here together because they're all CP/M compatible. CP/M is the universally accepted operating system created by Digital Research that allows software products like these to run on more than 600 different computer models including the biggest names in hardware. So, to get smart software for your system, call one of the fine Independent Software Vendors listed above or to find out how CP/M can increase productivity in your world, contact Digital Research at (408) 649-5500.



**DIGITAL  
RESEARCH™**  
The creators of CP/M™



Circle 163 on inquiry card.

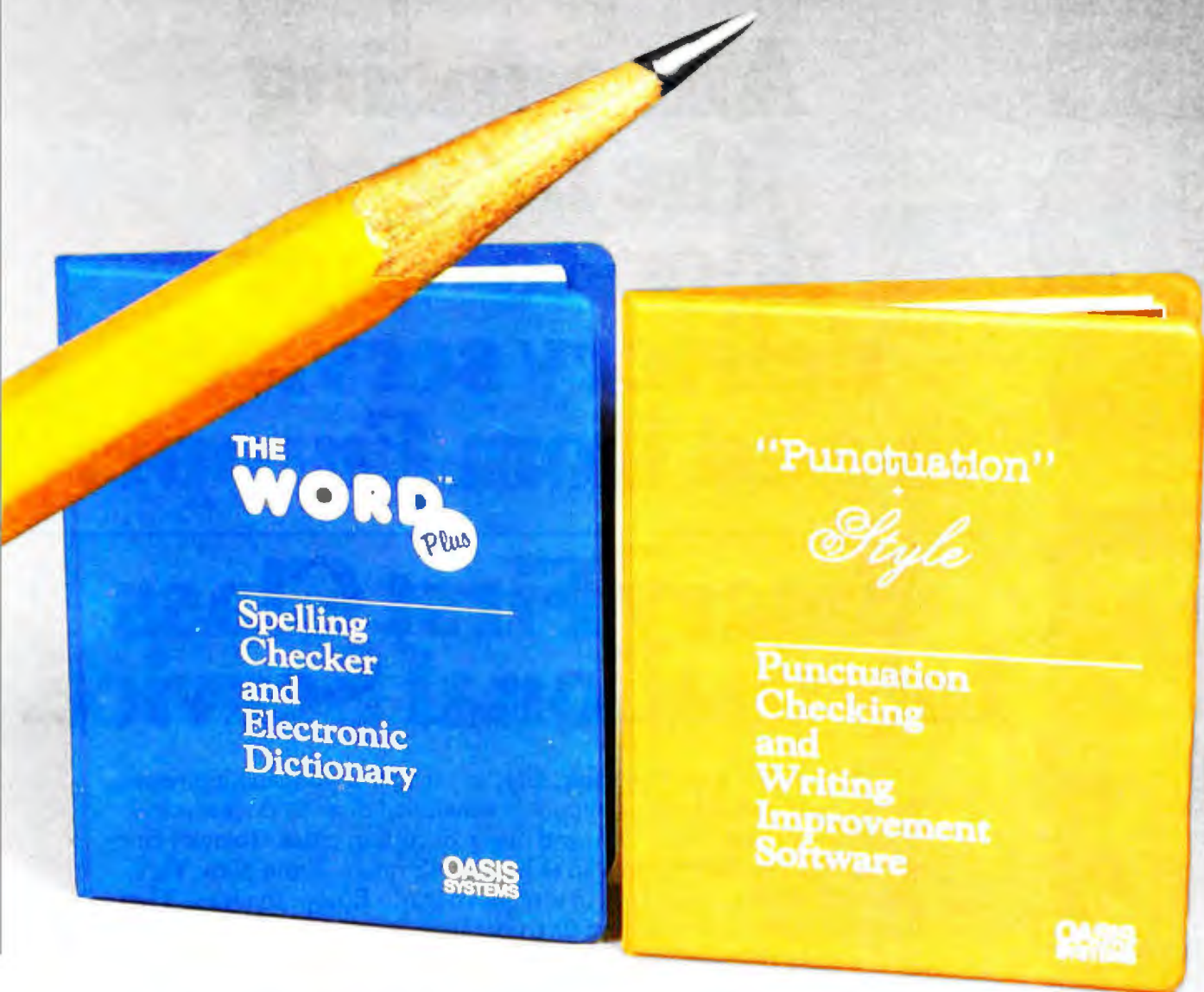
The logo, tagline and CP/M are either trademarks or  
registered trademarks of Digital Research Inc.  
©1982 Digital Research Inc.



# Software for Writers



**"Oasis Systems' software - unquestionably the best" . . . Peter McWilliams, author of the #1 best-selling book on word processing.**



The **WORD Plus** is the standard by which other spelling checkers are measured. Here's why:

- Real 45,000 word dictionary.
- Shows errors "in-context."
- Interactive word look-up finds correct spelling for you and corrects at the push of a button.
- Hyphenates words automatically.
- Solves crosswords, puzzles, and anagrams.
- Works with almost any CP/M®, CP/M-86® or MS/DOS compatible word processing program (WordStar, Magic Wand, Spellbinder, Perfect Writer, Select, Final Word . . . and more!).

**Punctuation & Style** takes the worry out of writing by automatically catching dozens of different punctuation errors, both common and obscure. In addition, P&S catches unpaired format commands (underline, boldface, etc.), doubled words, and more.

P&S gives you a "critique" of your writing, suggesting alternatives for commonly misused or over-worked phrases. It also shows where active voice can replace passive voice to add clarity and precision.

Punctuation & Style is the perfect companion to The WORD Plus. It works easily with most CP/M word processors. (Available soon for CP/M-86 and MS/DOS.)

Call or write for complete information:

**619-291-9489**

**OASIS  
SYSTEMS**

2765 Reynard Way  
San Diego, CA 92103

Circle 337 on Inquiry card.

Dealers contact:

**SOFTWARE DISTRIBUTORS**

1-800-252-4024 (in California)

1-800-421-0814 (outside California)





# Announcing the fastest door-to-door delivery service to and from Europe.

## Emery First Class International Service.

No matter what the value, size, or weight of your air shipments, Emery provides the fastest regularly scheduled door-to-door service available between most U.S. and major European cities. To most cities, we can deliver door-to-door in as little as 48 hours. From New York, we can deliver as quickly as overnight to major European cities. That includes everything from letters to packages to heavy cargo.

Emery offers you a total range of services from customs clearance to notifying your customer of the time of delivery, all for one basic price. For just a little more, you can even get proof-of-delivery and full documentation.

So the next time you want the fastest scheduled door-to-door service to most of Europe, ask for Emery First Class International Service. Call your local Emery office for details.

**Send for your free Emery  
First Class International Service  
Shipping Kit today.**

Mail coupon to:  
Emery

P.O. Box 4036, Woburn, MA 01888

Name \_\_\_\_\_

(Last) (First) (Middle Initial)

Title \_\_\_\_\_

Company \_\_\_\_\_

Address \_\_\_\_\_

City \_\_\_\_\_ State \_\_\_\_\_ Zip \_\_\_\_\_



**EMERY  
WORLDWIDE**

© Emery Worldwide 1983

1BY4

**Time after time,  
no one delivers like Emery.**

Circle 191 on Inquiry card.

# The Enhanced VIC-20

## Part 4: Connecting Serial RS-232C Peripherals to the VIC's TTL port

---

Joel Swank  
12550 SW Colony #3  
Beaverton, OR 97005

---

Owners of Commodore's VIC-20 personal computer know the fascination that can overcome the new computer user. Simplicity, of course, is both the VIC-20's main attraction and the reason for its low cost. And its uncomplicated nature makes the VIC-20 a good place for the beginner to start to explore the power of a microprocessor. But the real thrill comes with the machine's inevitable expansion to peripherals.

Commodore's Kernal operating system allows access to the VIC-20's serial user port. As a result, you can connect the VIC to modems, printers, and other serial devices. A modem opens the door to the world for the VIC-20. An ever-increasing number of information services are accessible via telephone lines: stock-market quotations, bulletin boards, and program exchanges are just a few examples, and many of these are free. With the proper software and hardware, two VIC-20 users can communicate directly to exchange programs and data,

### The User Port

Table 1a summarizes the standard RS-232C pin assignments used with most microcomputer systems, and table 1b shows the pin assignments of the VIC-20's user port. Notice that the VIC-20 uses a subset of the standard instead of all the circuits defined in the standard (13 possi-

ble subsets are listed in the standard's application notes, but the VIC-20 subset does not match any of them). Commodore's *Programmer's Reference Manual* defines two possible subsets of the VIC-20's user-port interface: the X-line interface and the three-line interface.

Software access to the VIC-20's user port is via logical device 2. Routines in the Kernal provide proper timing and logic to send and receive data by this device. Users can also access the port by way of the BASIC statements OPEN, CLOSE, and I/O.

### Overcoming Incompatibilities

The circuitry in the VIC-20 does not provide the voltages specified by the RS-232C standard; rather, it transmits data using TTL (transistor-transistor logic) level signals. In the VIC-20, signals between 0 V and 0.8 V (volts) represent a logical 0, while those greater than 2.4 V represent a logical 1. The RS-232C standard specifies that a logical 1 is any voltage more negative than -3 V, while a logical 0 is any voltage greater than +3 V. Thus the VIC-20 needs additional circuitry to properly interface with RS-232C devices.

Two ICs (integrated circuits) have been developed to solve this rather common problem. The 1488 contains four TTL-to-RS-232C line drivers, and the 1489 contains four RS-232C-to-TTL line receivers. These ICs are used in virtually every digital device that handles RS-232C voltage levels, and they're both inexpensive and easy to come by. You'll need one of each to build the VIC-20/RS-232C interface.

---

### Editor's Note

*This is the fourth and final article in Joel Swank's series on "enhancing" the Commodore VIC-20.*

---



You'll never have a better reason to begin shopping by mail:

# IBM RAM BOARDS

## 256K

WITH AN RS-232C INTERFACE

### \$349

\$529 WITH SUPERCALC

## 512K

WITH AN RS-232C INTERFACE

### \$579

\$749 WITH SUPERCALC

Our fully-populated memory boards include parity checking and a standard RS-232C interface. They are compatible with all IBM software.

This is a rare opportunity to save a great deal of money without sacrificing quality. These boards meet the highest standards of design, materials and manufacturing available — at any price. They are completely guaranteed for two years.

# Alpha Byte

## COMPUTER PRODUCTS

31245 LA BAYA DRIVE  
WESTLAKE VILLAGE, CA 91362

**To order or for information call**

**In New York:**

**(212) 509-1923**

**In Los Angeles:**

**(213) 706-0333**

**In Dallas:**

**(214) 744-4251**

**By Modem:**

**(213) 991-1604**

**CALL OUR MODEM LINE FOR WEEKLY SPECIALS.**

(1a)

### RS-232C Interface Connector Pin Assignments

Pin Number	Circuit Name	Description
1	AA	Protective Ground
2	BA	Transmitted Data
3	BB	Received Data
4	CA	Request to Send
5	CB	Clear to Send
6	CC	Data Set Ready
7	AB	Signal Ground (Common Return)
8	CF	Received Line Signal Detector
9	—	(Reserved for Data Set Testing)
10	—	(Reserved for Data Set Testing)
11		Unassigned
12	SCF	Secondary Received Line Signal Detector
13	SCB	Secondary Clear to Send
14	SBA	Secondary Transmitted Data
15	DB	Transmission Signal Element Timing (DCE Source)
16	SBB	Secondary Received Data
17	DD	Receiver Signal Element Timing (DCE Source)
18		Unassigned
19	SCA	Secondary Request to Send
20	CD	Data Terminal Ready
21	CG	Signal Quality Detector
22	CE	Ring Indicator
23	CH/CI	Data Signal Rate Selector (DTE/DCE Source)
24	DA	Transmit Signal Element Timing (DTE Source)
25		Unassigned

(1b)

### User-Port Lines

(8522 Device 1)

Pin ID	8522 ID	Description	EIA Circuit	Abbreviated Name	Direction	Mode
C	PBO	Received Data	(BB)	Sin	IN	1,2
D	PB1	Request to Send	(CA)	RTS	OUT	1,2
E	PB2	Data Terminal Ready	(CD)	DTR	OUT	1,2
F	PB3	Ring Indicator	(CE)	RI	IN	3
H	PB4	Received Line Signal	(CF)	DCD	IN	2
J	PB5	Unassigned	( )	XXX	IN	3
K	PB6	Clear to Send	(CB)	CTS	IN	2
L	PB7	Data Set Ready	(CC)	DSR	IN	2
B	CB1	Received Data	(BB)	Sin	IN	1,2
M	CB2	Transmitted Data	(BA)	Sout	OUT	1,2
A	GND	Protective Ground	(AA)	GND		1,2
N	GND	Signal Ground	(AB)	GND		1,2,3

Table 1: Pin assignments and signal names. The information in table 1a, a summary of RS-232C signals, comes directly from the RS-232C standard; the VIC's serial port signals, shown in table 1b, can also be found in Commodore's Programmer's Reference Manual for the VIC.

# Space. Saver.

## The TTX-1014 Desktop Daisywheel. More Features. More Value. Less Space.

Presenting the TTX-1014 Desktop Daisywheel. The perfect letter-quality daisywheel printer for your home or office.

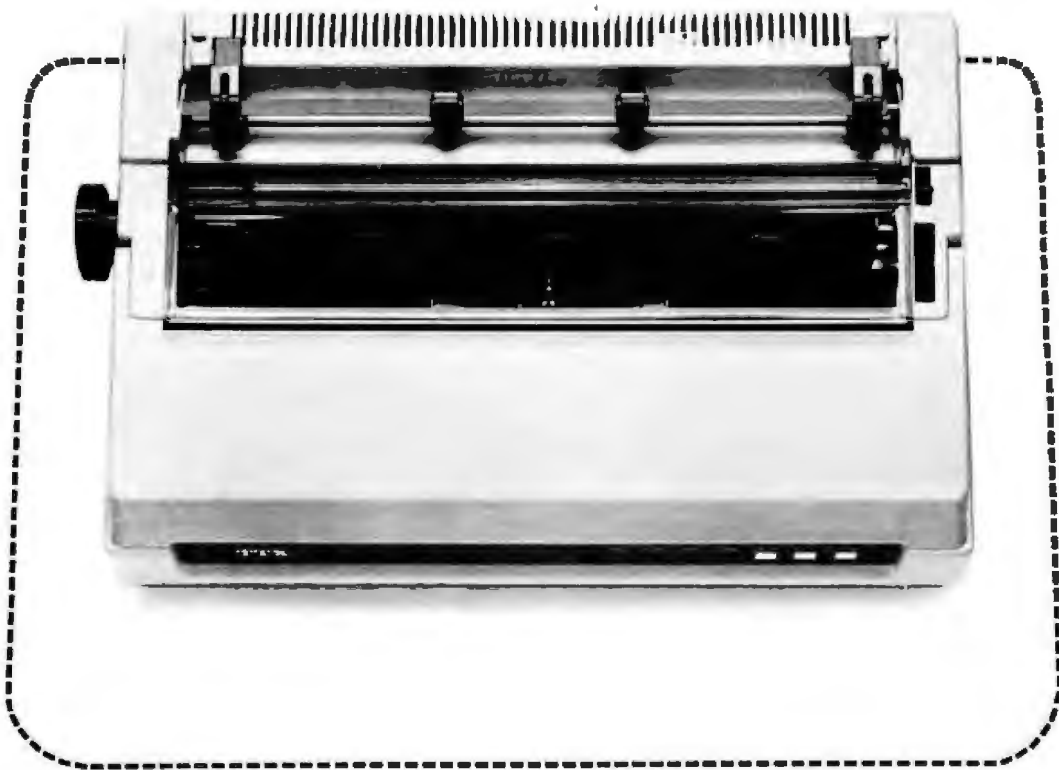
Your first look will tell you that the TTX-1014 Desktop Daisywheel is a different breed of printer. Sleek. Stylish. Compact. With a low-profile design and narrow footprint so it fits on any desktop...and leaves you plenty of room to work.

The TTX-1014 Desktop Daisywheel comes with an impressive array of standard features.

Bidirectional printing. Pin and friction feed. Full-size-form capability. Interchangeable, 100-character, ASCII printwheel. Built-in serial and parallel interface. Print speeds up to 140 words-per-minute. Plus switch- and program-selectable pitch, line spacing, and baud rates. All standard.

And all at a price that's irresistible. \$649! Complete.

The TTX-1014 Desktop Daisywheel. The best deal going for your home or office. Try it now at your dealer's showroom.



Conventional daisywheel printer footprint.

## TTX™

Teletex Communication Corporation  
3420 East Third Avenue  
Foster City, California 94404  
415/341-1300 TX: 349420



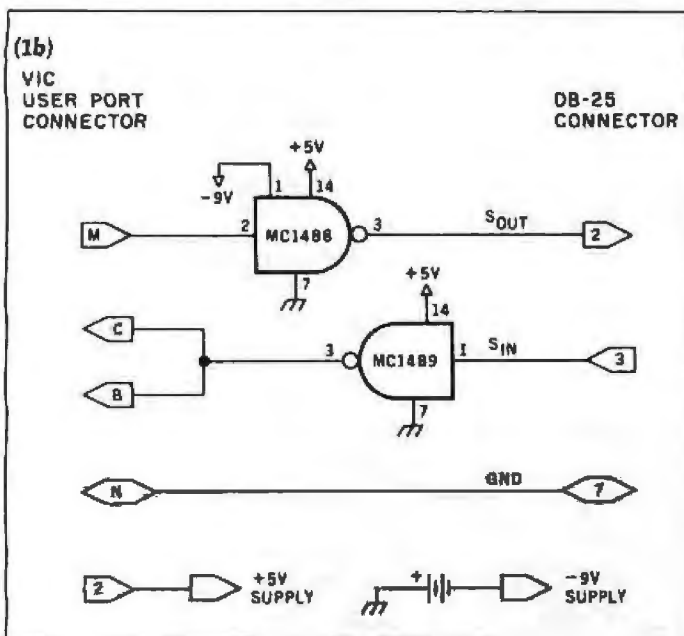
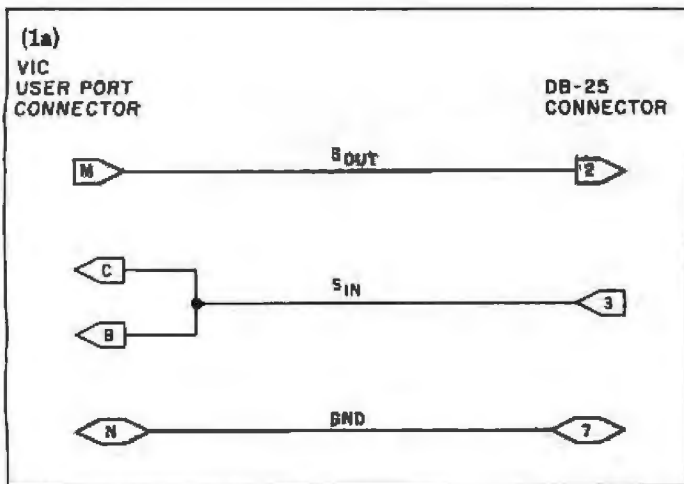
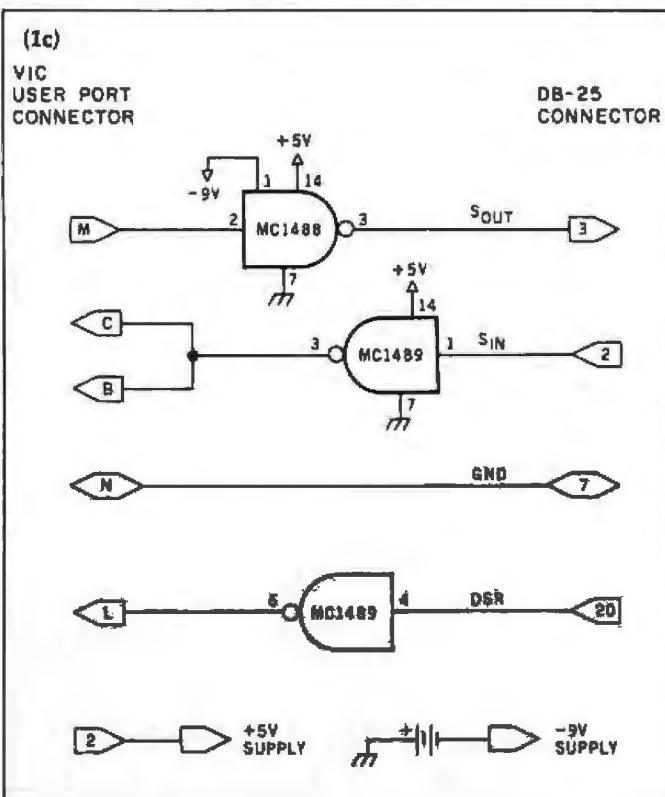


Figure 1: Schematic diagrams of connections between the VIC and other equipment. In figure 1a, the VIC is connected directly to a TTL-level compatible modem. Figure 1b shows the arrangement for connecting RS-232C-compatible DCE (data-communications equipment, such as a modem) to the VIC's serial port; figure 1c shows connections to DTE (data-terminal equipment, such as a printer or video terminal).



Connectors are another possible area of incompatibility: most RS-232C devices use a female subminiature D-type connector with 25 contacts termed DB-25; the VIC-20's connector is a card edge with 12 pins per side on 0.156-inch centers. If you intend to connect these two types of devices, you'll need a male DB-25 and a 24-pin edge-card connector.

### Connecting to Serial Peripherals

Several modems will accept the VIC-20's TTL-level signals. Commodore sells one, of course, as do Bizcomp and Micromint. If you use the VIC modem, you need no additional hardware, but if you use another TTL-level device, you'll need to make a cable with the proper connectors on each end. Figure 1a shows how signals should be routed.

Figure 1b is a diagram of the signal adapter you'll need to connect the VIC-20 to full-duplex RS-232C peripherals. The Commodore manual refers to this adapter as the three-line interface. The biggest problem with this circuit

is that it requires a negative power supply to match the voltage requirements of the RS-232C standard. I used a 9-V transistor-radio battery connected to provide negative voltage. (The circuit can be constructed on a small piece of perforated circuit board; the VIC connector is glued to one edge, and the DB-25 connector is attached by a three-wire cable.)

The user port can also communicate with a printer, a plotter, a video terminal, and several other RS-232C devices, but most of these, like the VIC-20, will be designed to fit the DTE (data-terminal equipment) category of the RS-232C standard. Because a DTE device is intended to be connected to DCE (data-communications equipment) instead of another DTE device, you have to fool both devices into thinking that the other is a DCE device. Figure 1c is a schematic diagram of how to accomplish that. It's simply a matter of using the same three signals used in figure 1b, but you also cross the wires and add a handshake line. This is the X-line interface Commodore refers to in its manual. The handshake

Text continued on page 338

# cdex™

## Training Programs

### Make Using Personal Computers Easy.

Cdex™ Training Programs are available for:

The VisiCalc® Program  
The WordStar™ Program  
The SuperCalc™ Program  
The EasyWriter II™ Program

The IBM® Personal Computer  
The Apple® IIe Personal Computer

Understanding Personal Computers and Their Applications  
Managing Your Business with the 1-2-3™ Program  
Managing Your Business with the MULTIPLAN™ Program



Even the best application programs and personal computers still take a considerable amount of time to learn how to use. That is...until now!

Cdex Training Programs are computer-assisted training programs that make learning straight-forward and efficient. In an hour, you can master the material on the Cdex disks and begin using the intended product.

It's tough to learn about computers from a book. That's why all Cdex Training Programs are on disk and are:

**Highly Interactive...**

Creating a dialogue with you and serving as your personal tutor.

**Completely Self-paced...**

You set your own learning time.

**Graphically Oriented...**

Remember, a picture is worth a thousand words.

**Usable Now and Later...**

Clear and concise training and reference programs for the first-time or experienced user.

Cdex Training Programs run on the same Apple® II Plus, Apple® IIe or IBM® Personal Computer as your other programs. See how effective a Cdex Training Program can be; ask your dealer for a demonstration.

Cdex™ Training Programs  
We make it easy.

# cdex™

**Cdex Corporation**  
5050 El Camino Real  
Los Altos, CA 94022  
415 964 7600



Listing 1: The assembly listing of VICTTY, a program to send data to an RS-232C printer that requires handshaking signals.

```

0001 0000      VICTTY : ROUTINE TO SEND TO THE VIC RS232C PORT
0002 0000      FOR USE WITH AN OUTPUT ONLY DEVICE (PPINTER)
0003 0000      THAT REQUIRES HANDSHAKING.

0004 0000      THIS ROUTINE WAS EXTRACTED FROM THE M/M-R/M MONITOR
0005 0000      TTY OUTPUT ROUTINES.

0006 0000      VICTTY ECNDS ALL CHARACTERS DISPLAYED ON THE SCREEN
0007 0000      TO THE RS232C PORT. IT WAITS ON THE DSR LINE
0008 0000      HANDSHAKE FROM THE OUTPUT DEVICE.

0009 0000      SET THE BAUD RATE BY POP'ING LOCATION 701 WITH ONE
0010 0000      OF THE FOLLOWING:
0011 0000      VALUE BAUD RATE
0012 0000      0      110
0013 0000      1      150
0014 0000      2      300
0015 0000      3      600
0016 0000      4      1200
0017 0000      5      2400
0018 0000      6      4800
0019 0000      7      9600

0020 0000      ACTIVATE WITH SYS 45056
0021 0000      DE-ACTIVATE WITH SYS 45121

0022 0000      VIC USER VIA ADDRESSES

0023 0000      DATAB1  *$9110      : B PORT DATA REGISTER
0024 0000      DORAB1  *$9112      : B PORT DIRECTION REGISTER
0025 0000      T1M1    *$9118      : TIMER 2 REGISTERS
0026 0000      T1M2    *$9119
0027 0000      PCP1    *$911C      : PERIPHERAL CONTROL REGISTER
0028 0000      IFR1    *$911D      : INTERRUPT FLAG REGISTER

0029 0000      VIC TV CHIP

0030 0000      TACTL5  *$9905      : TEST FOR LOWER CASE HERE

0031 0000      VIC RAMS

0032 0000      SYSK    *$300      : X REGISTER FOR SYS COMMAND
0033 0000      DISUEC  *$326      : OUTPUT VECTOR

0034 0000      EQUATES

0035 0000      LF      =10      : LINE FEED CHARACTER
0036 0000      CR      =13      : CARRIAGE RETURN CHARACTER

0037 0000      *=$B400

0038 0000      RD 27 03  ACT   LDR DISUEC+1  :GET HI BYTE OF VECTOR
0039 0000      C9 00      CWP $VICTTY  :MY ROUTINE
0040 0000      F0 13      BEQ $MVEC  :YES, SKIP VECTOR UPDATE
0041 0000      00 02 01  STA UECSA+1  :SAVE THE CONTENTS
0042 0000      00 26 03  LDR DISUEC  :OF THE OUTPUT VECTOR
0043 0000      00 01 01  STA UECSA
0044 0000      09 35 03  LDR $VICTTY  :PUT ADDRESS OF MY ROUTINE
0045 0000      00 17 03  STR DISUEC  :INTO VECTOR
0046 0000      00 15 03  LDR $VICTTY
0047 0000      80 27 03  STR DISUEC+1
0048 0000      00 1A 03  SKPVEC LDR PCP1  :USE CR2 IN DIRECT MODE
0049 0000      00 1D 03  AND $IF1  :FOR OUTPUT BIT
0050 0000      00 09 03  ORA $P21  :PUT A MARK ON THE LINE
0051 0000      80 1C 01  STR PCP1
0052 0000      80 7F 03  LDR $7F7  :SET B PORT HI BIT TO INPUT
0053 0000      80 26 03  STR DORAB1  :TO READ DSR LINE
0054 0000      80 29 03  LDR SYSK    :GET BAUD RATE INDICATOR
0055 0000      00 0C 03  CWP $00C  :SIGNAL LIMIT?
0056 0000      80 0E 03  BEQ $NOCLIP :YES,
0057 0000      80 20 03  LDR $0  :NO, DEFAULT TO 0
0058 0000      00 32 03  MOVLIP  RSL A  :MULTIPLY BY 2 FOR INDEX
0059 0000      00 33 03  TAX      :
0060 0000      80 03 03  STA BIAUTB+X :GET CORRESPONDING ENTRY
0061 0000      80 04 03  STA BIAUTB+1-X :FROM BAUD RATE TABLE
0062 0000      80 06 03  STR BIAUTB+1-X :AND SAVE IN BIT1M
0063 0000      80 00 03  RTS
0064 0000      00 40 60

0065 0041      ENTRY TO DE-ACTIVATE VICTTY

0066 0041      RD 27 03  DEACT  LDR DISUEC+1  :GET HI BYTE OF VECTOR
0067 0041      C9 00      CWP $VICTTY  :IS IT A LINE?
0068 0041      00 0C 03  AND $MVEC  :YES, RESTORE OLD
0069 0041      00 01 01  LDR UECSA  :VECTOR CONTENTS
0070 0041      00 26 03  STR DISUEC
0071 0041      00 02 01  LDR UECSA+1
0072 0041      00 27 03  STR DISUEC+1
0073 0041      00 00 60      NOPE   RTS

0074 0055      VICTTY : ROUTINE TO OUTPUT TO THE VIC RS232C PORT

0075 0055      RD FE 00  VICTTY  STR CHRR  :SAVE A COPY OF CHARACTER
0076 0055      00 58 00  TXR      :AND ALL REGISTERS
0077 0055      00 59 00  TXR      :ON THE STACK
0078 0055      00 48 00  PHR
0079 0055      00 56 00  TYR
0080 0055      00 4B 00  LDR $802  :LOWER CASE MODE?
0081 0055      00 05 00  AND TACTL5
0082 0055      F0 21  BEQ CHKR  :NO, SKIP TRANSLATION
0083 0055      00 44 00  LDR CHRR  :RETRIEVE CHARACTER
0084 0055      00 FE 00  BHI $CHKUPP :CHECK FOR UPPER CASE
0085 0055      00 07 00  CWP $0  :LESS THAN 'A' ?
0086 0055      00 41 00  BEQ CHKR  :YES SKIPPIT
0087 0055      00 18 00  CMP $85B  :GREATER THAN 'Z' ?
0088 0055      00 54 00  BCS CHKR  :YES SKIPPIT
0089 0055      00 14 00  ORA $820  :TRANSLATE TO LOWER CASE
0090 0055      00 07 00  STR $86E  :SAVE IT
0091 0055      00 FE 00  STA CHRR
0092 0055      00 00 00  BNE CHKR
0093 0055      00 78 00  CMP $8C1  :LESS THAN 'A' ?
0094 0055      00 0A 00  BEQ CHKR  :YES SKIP
0095 0055      00 09 00  CWP $80B  :GREATER THAN 'Z' ?
0096 0055      00 05 00  BCS CHKR  :YES SKIP
0097 0055      00 2F 00  AND $7F7  :CLEAR HI BIT
0098 0055      00 FE 00  STR CHRR  :SAVE IT
0099 0055      00 55 00  LDR CHRR
0100 0055      00 00 00  CWP $0  :RETURN?
0101 0055      00 08 00 00  BNE SEND :NO, JUST SEND IT
0102 0055      00 83 00  JSR SENDTY :YES SEND IT
0103 0055      00 0A 00 00  LDR $LF :AND FOLLOW WITH A LINE FEED
0104 0055      00 91 00 00  STR $LF
0105 0055      00 84 00 00  SEND  JSR SENDTY :SEND A CHARACTER
0106 0055      00 69 00 00  PLA
0107 0055      00 59 00 00  TXR
0108 0055      00 68 00 00  PLA
0109 0055      00 5A 00 00  TXR
0110 0055      00 58 00 00  PLA
0111 0055      00 5C 00 01 01  JMP (UECSA) :GO DO NORMAL OUTPUT ROUTINE

0112 009F      DELAY : DELAY FOR THE TIME IN BIT1M

0113 009F      RD FF 00  DELAY  LDR BIT1M  :MOVE DELAY TIME TO
0114 00A2      00 18 01  STA T1M1  :TIMER REGISTERS
0115 00A5      00 06 01  LDR BIT1M+1
0116 00A8      00 15 01  STR $0
0117 00AB      00 10 01  DEL2  LDR IFR1  :TIME UP?
    
```

```

0118 00AE      79 20      AND $820      (TEST TIMER 2 BIT)
0119 00B0      F0 21      BEQ DEL2  :NO, WAIT
0120 00B2      60        RTS          :YES, RETURN

0121 0067      SENDTY : SEND ONE CHARACTER TO THE RS232C PORT
0122 00E3      THE CHARACTER MUST BE IN CHRR AND
0123 00B3      IS NOT PRESERVED

0124 00B3      SENDTY  WAITDS  SEI          :DISABLE INTERRUPTS
0125 00B3      79 20      AND $820  :TEST DSR (P27)
0126 00B4      10 01      BPL SENDIT :IF ON, CONTINUE
0127 00B7      58        CLT          :ALLOW AN INTERRUPT
0128 00B9      30 07      BHI WAITDS  :AND WAIT FOR DSR

0130 00BC      20 9F 00  SENDIT  JSR DELAY  :DELAY A BIT TIME
0131 00BF      09 1F 00  LDR $81F  :PUT SPACE ON LINE
0132 00C1      20 1C 01  AND PCP1  :RAPH OFF CR2
0133 00C4      09 1C 00  ORA $8C0
0134 00C6      80 1C 01  STR PCP1
0135 00C9      20 9F 00  JSR DELAY
0136 00CC      A2 0B 00  LDX $0  :WAIT A BIT
0137 00CE      4E FE 00  OUTLUP  LSR CHRR  :GET A BIT
0138 00D1      90 0C 00  BEQ $1T0  :BRANCH IF ITS ZERO
0139 00D3      09 1F 00  LDR $81F  :ITS ONE -
0140 00D6      20 1C 01  AND PCP1  :PUT A MARK ON THE LINE
0141 00D8      09 1D 00  ORA $8C0
0142 00DA      80 1C 01  STR PCP1
0143 00DD      80 0A 00  BCS DELBIT :GO WRIT SOME
0144 00DF      09 1F 00  LDR $81F  :PUT SPACE ON LINE

0145 00E1      20 1C 01  AND PCP1
0146 00E4      09 1C 00  ORA $8C0
0147 00E7      80 1C 01  STR PCP1
0148 00E9      20 9F 00  DELBIT  JSR DELAY  :WAIT A BIT
0149 00EC      CA        DEX          :COUNT THE BIT
0150 00ED      00 0F 00  BNE OUTLUP :LOOP TILL ZERO
0151 00EF      00 1E 00  LDR $P21  :SEND STOP BIT
0152 00F1      20 1C 01  AND PCP1  :PUT MARK ON THE LINE
0153 00F4      09 1D 00  ORA $8C0
0154 00F6      80 1C 01  STR PCP1
0155 00F9      20 9F 00  JSR DELAY  :WAIT A BIT
0156 00FB      58        CLT          :ALLOW INTERRUPTS
0157 00FD      60        RTS

0158 00FE      ARM LOCATIONS

0159 00FE      00      CHRR  .BYT 0      :OUTPUT CHARACTER
0160 00FF      00 00  BIT1M  .WOR 0      :BIT DELAY TIME
0161 0101      00 00  UECSA  .WOR 0      :SAVE FOR OUTPUT VECTOR

0162 0103      TABLE OF BAUD RATE BIT TIMES

0163 0103      BIAUTB **
0164 0103      3F 23      .WOR $233F      :110 BAUD (0)
0165 0105      87 19      .WOR $1987      :150 BAUD (1)
0166 0107      82 1C      .WOR $821C      :300 BAUD (2)
0167 0109      3F 06      .WOR $3F06      :600 BAUD (3)
0168 010B      FD 02      .WOR $FD02      :1200 BAUD (4)
0169 010D      3D 01      .WOR $3D01      :2400 BAUD (5)
0170 010F      80 00      .WOR $8000      :4800 BAUD (6)
0171 0111      2C 00      .WOR $2C00      :9600 BAUD (7)

0172 0113      BMARK =8
0173 0113      ERRORS =END
0174 0113

SYMBOL DEFINED REFERENCES

A      0000 0058
ACT     0038
BIAUTB 0163
BIT0    0144
BIT1M  0160
BMARK  0172
CHRR    0159
CHKCR   0099
CHKUPP  0093
CR      0036
DATAB1  0023
DORAB1  0024
DEACT   0066
DEL2    0117
DELAY   0113
DELBIT  0148
DISUEC  0033
IFR1    0028
LF      0035
MOVLIP  0058
NOPE    0073
OUTLUP  0137
PCP1    0027
SEND    0105
SENDIT  0130
SENDTY  0124
SKPVEC  0048
SYSK    0032
T1M1    0025
T1M2    0026
UECSA   0050
VICTTY  0075
WAITDS  0125
X      0000
    
```

# Before you bet your software business on an OS, look who's betting on MS-DOS and XENIX.

**A waiting market.** If you write and sell 16-bit software, MS-DOS and XENIX give you the largest installed base. In fact, over fifty 16-bit manufacturers offer their microcomputers with MS-DOS or XENIX. IBM, Victor, Altos, Wang, Radio Shack, Zenith and Intel, to name just a few. And the list is growing. That means there's a ready and expanding market for your 16-bit applications software.

**The UNIX™ connection.** XENIX is the multi-user, multi-tasking, UNIX-derived operating system for 16-bit microcomputers. MS-DOS 2.0 is Microsoft's single-user OS. MS-DOS and XENIX share hierarchical file structure and I/O redirection, including simple piping. MS-DOS 2.0 also provides XENIX-compatible system calls. That means there's a migration path for programs written to run under MS-DOS and XENIX. What's more, both MS-DOS and XENIX are supported by Microsoft® languages. That's your single-supplier advantage from Microsoft.

**Comprehensive support.** Microsoft offers you a full product support program. Excellent documentation. Plus continual enhancements to both languages and operating systems. Your applications programs can even be listed in Microsoft's growing Source Directory of 16-bit applications packages. Contact us for current software offerings and vendors.

**Leadership.** Microsoft led the world into the 8-bit microcomputer marketplace

with the first BASIC for microcomputers. Now, we're leading it into the 16-bit market with single and multi-user operating systems.

**Bet the winner.** If you're writing and marketing software in the 16-bit marketplace, MS-DOS and XENIX are setting the standard. In fact, they're the standard operating systems for the world's largest selling 16-bit microcomputer systems. Which means your market is already there... and growing. Contact us for complete information. Before you bet your software on an operating system, look where your market is betting.

BETTER TOOLS FOR MICROCOMPUTERS

## MICROSOFT™

MICROSOFT CORPORATION  
10700 NORTHUP WAY  
BELLEVUE, WASHINGTON 98004

Microsoft is a registered trademark, and MS, XENIX and the Microsoft logo are trademarks of Microsoft Corporation. UNIX is a trademark of Bell Laboratories.





Data Rate	
value	bits per second
0	110
1	150
2	300
3	600
4	1200
5	2400
6	4800
7	9600

**Table 2:** Data-transmission rate control values. One of these numbers should be stored in location 781 before VICTTY is activated in order to set the data rate.

*Text continued from page 334:*

line is the DSR (data set ready) signal from the DCE device, whether it's a printer, a synthesizer, or some other peripheral. This signal must be sent to the VIC-20's DTR (data-terminal ready) input.

Handshaking is necessary because the VIC-20 can send data much faster than most serial devices can handle. At times, for example, a printer must ask the computer to stop sending data so that it can catch up. When the printer can handle more data, it informs the VIC-20 by asserting DTR.

## Software

Unfortunately, an error in the VIC's serial data-transmission routines causes the computer to ignore signals on the DSR line. In other words, if the printer sends the "wait" signal, the VIC-20 ignores it and continues sending data, which is thus lost. To circumvent this problem, I use a program called VICTTY (adapted from the terminal-communications routines in the monitors of the KIM and AIM computers). See listing 1 on page 336.

VICTTY can be used to send data directly to the user port. While it bypasses all the fancy buffering done by the VIC's routines, it does pay attention to the DSR signal, waiting for the printer so that no data is lost. The program echoes to the printer any characters that are sent to the screen and is activated by entering SYS 45056 at the keyboard.

The transmission rate can be selected by using a BASIC POKE instruction to store a number in location 781 prior to activation. Unlike the VIC-20 routines that are limited to 1200 bps (bits per second), VICTTY will work at up to 9600 bps (see table 2 for data rates and the corresponding values to store).

To list a BASIC program currently in memory and send it to a 2400-bps printer connected to the serial port, for example, you would enter

POKE 781,5 : SYS 45056 : LIST

When the listing is done, deactivate VICTTY by typing SYS 45121 or all the screen output will be sent to the printer. You can also deactivate VICTTY by pressing the Run/Stop and Restore keys. VICTTY can also be used from within BASIC programs—just include the same POKE and SYS commands in the program before you send the output to the screen.

## A Word about ASCII

It takes a bit of doing to make serial data from the VIC-20's port compatible with most standard printers. VICTTY alters the data as follows. First, it inserts a line-feed character after every carriage-return character (most terminals and many printers need both between lines). Second, it translates the VIC-20's uppercase/lowercase character set into standard ASCII (American National Standard Code for Information Interchange) characters. The VIC-20 has two characters sets: in one, the ASCII lowercase codes are replaced by special graphics characters; in the other, the ASCII uppercase codes produce lowercase characters, while the ASCII uppercase codes with the high-order bit on are used to produce uppercase characters.

## Other Uses

In its present form, VICTTY can only handle transfers of data out of the computer, although the hardware is capable of both transmitting and receiving. Still, VICTTY could be used to echo VIC-20 screen output to an 80-column video terminal that would enable you to see more information at a time. If the terminal does not handshake, connecting pin 4 of the 1489-type line receiver to +5 V will enable the interface in figure 1c to work.

Other RS-232C devices can be used with this software/hardware combination; some might require you to modify the interface arrangement. The VIC routines supplied by Commodore can be made to work with the interfaces shown as long as handshaking is not required. With any luck, this series will start you on your way to exploring such advanced peripherals as plotters, digitizers, and speech synthesizers, all of which are now available for the home market. ■

*The program in this article has been incorporated into a full-featured printer program for the Epson and other printers. It includes VIC graphics and access to all Epson functions via standard BASIC OPEN, CLOSE, and PRINT# statements (no SYS calls). It also has a special mode for BASIC listings that formats BASIC statements for readability. It will communicate to the printer via either a Centronics parallel interface cable or an RS-232C interface at up to 9600 bits per second with handshaking. For more information contact United Microwave Industries Inc., 3503C Temple Ave., Pomona, CA 91768.*

**dBASE II™ made easy!**

# **QUICKCODE™**

**The dBASE II Program Generator**

Now dBASE II is made easy with Quickcode by Fox & Geller. QUICKCODE is a program generator, a computer program which writes computer programs.

## **FAST AND SIMPLE**

With QUICKCODE you can generate a customer database in 5 minutes. Its that fast. All you have to do is draw your data entry form on the screen. It's that simple!

## **NO PROGRAMMING REQUIRED**

QUICKCODE writes concise programs to set up and maintain any type of database. And the wide range of programs cover everything from printing mailing labels and form letters, to programs that let you select records based on your own requirements. There are even four new data types that are not available with dBASE II alone.

## **YOUR CONTROL**

And since you work directly with your information at your own speed and your own style, you maintain complete control. Telling your computer what to do has never been so easy.

**QUICKCODE, by Fox & Geller. Absolutely the most powerful program generator you've ever seen. Definitely the easiest to use.**

Ask your dealer for more information on QUICKCODE and all the other exciting new products from Fox & Geller.



**FOX & GELLER**

Fox & Geller, Inc. Dept. INF 001 604 Market Street Elmwood Park, N.J. 07407 (201) 794-8883



# IF YOU KNOW WHAT YOU WANT . . .

## EDIX/WORDIX

\$149 (ea.)

Personal Data Base \$93

**CROSSTALK**  
\$119

## SUPERCALC

\$185

**EASYWRITER II**  
\$259

## CONDOR 3

\$488

**MULTIPLAN**  
\$179

## WORD HANDLER

\$145

**DB MASTER**  
\$148

## VISICALC

\$169

**FINAL WORD**  
\$223

• PFS \$99

• PFS Report \$79

• PFS Graph \$99

<b>IBM PC (DOS)</b>	IUS	Sorcim (see also ISA)	Condor Computer Corp.	BASIS
Advanced Operating Systems	Easy Speller 1 1	Spellguard	Condor 1	The Word Plus
The Programmer	Easy Filer	Supercalc	Condor 3	Organic Software
American Training International, Inc.	Easywriter II	Superwriter	Data Base Solutions	Datebook
ATI-Power for PC	Easy Planner	Southeastern	dNAMES	Milestone
DOS	AR/AP/GL (ea)	Data Capture	Digital Research	Passchree
Applied Software Technology	Financial Management Series (all 3)	Star	Access Manager	Series 4 Peach Pak (GL,AR,API)
Versaform	Lexlett	Legal Timekeeping, Billing, & Accis	MAC (macro assembler)	Pickles and Trout
Ashton-Tate	Spellbinder	Structured Systems	SID (symbolic debugger for 8080)	CP/M TRS 80 Mod II
dBase II	Lifeboat	GL, AR, AP Payroll, Inventory, OE (ea)	ZSID	Quality Software
Aspen Software	Lattice C Compiler	Analyst	CBASIC II (language)	GBS-DB Apple Dev Program
Grammatik	Lifetrax	Letterright	CB80	Relational Systems, Int.
Proofreader	Volkswriter	NAD	CIS COBOL	Personal Pearl
Byram Software	Lightning	OSORT	Display Manager	Select Information Systems
BSTAM (Micro to micro comm)	Master type	Supersoft	Pascal M+ w/SPP	Select with Super-spell
BSTMS (Micro to mainframe comm)	Lotus	Optimizer	BJR Associates	Software Dimensions
Comshare	1-2-3	Personal Data Base	FMS 80	Accounting Plus™
Master Planner	Mark of the Unicorn	Synergistic	FMS 80-1	GL, AR, AP, Inv each
Condor Computer Corp.	Mince	Data Reporter	FMS 80-2	All four
Condor 1	Final Word	Versa Computing	Esssoft	Berlin
Condor 3	Metasoft	Graphics Hardcopy System	MicroStat (stat package)	Pascal/M (Z80) (8080)
Continental Software	Benchmark Word Processor	VisiCorp	Epic Computer Corp.	Pascal/M (8086 8088)
Home Accountant Plus	Benchmark Mail (ea)	VisiCalc (256K)	Supervy	ACT 80 (Z80 8080 8085)
1st Class Mail	Microware	Desktop Plan I	Faircom	ACT 65 (6502)
CP Aids	CIS COBOL 8086	VisiTrend/Plot	MICRO B+ (Keyed file accessing)	ACT 68 (6800)
Master Tax	Micro Lab	Visidex	For CBASIC 2	ACT 69 (6809)
Standard Tax	The Tax Manager	VisiFile	For MBASIC, COBOL, PL/80, FORTRAN, Pascal MT+ CB 80	ACT 86/88 (8086, 8088)
DataMail	MicroPro	Visischedule	Fax and Geller	TRANS 86
Write On	Intostar	Business Forecasting Models	dGRAPH	Spellguard
Real Estate Investment Program	Report Star	Whall Software Systems Move II	Quickscreen	SuperCalc
Denver Software	Wordstar	<b>IBM PC HARDWARE</b>	Quickcode	Superwriter
EASY (Executive Acctg System)	Spellstar	Kraft	dUTIL	Supersoft
Diconics	Mailmerge	Joystick	FYI	C Compiler
Random House Electronic Thesaurus	Mailmerge [4]	Microsoft	Superfile	Ada Compiler
Digital Research	Microsoft	RAM Card 64K	Intelec	Systems Plus (see Software Dim.)
CBASIC 86	Flight Simulator	RAM Card 128K	Deadline	Wall Software Systems
CIS COBOL 86	Multiplan	RAM Card 192K	Zork I II III (ea)	Move II
Concurrent CP/M-86	MicroStat	RAM Card 256K	Star Cross	
Level 2 COBOL 86	Crosstalk	QUADRAM	Human Sall	
Pascal MT-86/w SPP	North American Business Systems	Quadboard 64K	D B Plus	
SID86	The Answer	256K	ISA (See Sorcim) ISM	
SPP86	Northwest Analytical	Tech Designs	Mathemagic	
Eagle Software	Stalpak	Adam & Eve Paddles	Ultima Intersystems	
Money Decisions	OASIS	TG Products	Pascal Z	
Emerging Technology	The Word Plus	Joystick	Pascal BZ (64K)	
Edix	Organic Software	Versa Computing	Pascal Z and BZ	
Wordix	Datebook	VersaWriter Graphics	Lexlett	
EZ Tax	Milestone (128K)	Tablet	Spellbinder	
EZ Tax Howard	Textwriter III (Text formatter)	Adventure International	Lifaboot	
Real Estate Analyzer II	PBL Corporation	Adventures (11-12)	T-Maker II	
Tax Preparer 1983	Personal Investor (128K)	American Training International, Inc.	Mark of the Unicorn	
Innovative Software	Peachtree	ATI-Power for CP/M	Mince (text editor)	
T1 M III	Series 4 Peachpak (GL/AR/AP)	Anderson-Bell	Final Word	
Fast Graphs	GL/AR/AP [5]	ABSTAT	Micro Pro	
Intellinet Assoc.	Ryan-McFarland	Artificial Intelligence (Requires CBASIC 2)	Intostar	
PC Text	RM/COBOL	Medical	Report Star	
Window	Full Dev System	Dental	Wordstar	
ISA (see Sorcim)	Runtime only	Ashton Tite dBase II	MailMerge	
Mathemagic	Scripts Data	Aspen Software	Wordstar/MailMerge	
Graphmagic	Job Cost Systems	Grammatik	Spellstar	
Combo Pack	Select Information Systems	Proofreader	Wordstar/Spellstar	
	Select with SuperSpell (Word Proc.)	Balances	Word/Spell/Mail	
	Software Publishing	The Boss Financial Accounting System	Calstar	
	PFS File	Byram Software	Dalstar	
	PFS Report	BSTAM (Micro to micro comm.)	MicroSoft	
		BSTMS (Micro to mainframe comm.)	BASIC 80	
		Cardbox	BASIC Compiler	
		Computer Development Inc.	FORTRAN 80	
		Image	COBOL 80	
		Comshare Target Software	MACRO 80	
		PlannerCalc	EDIT 80	
		Masterplanner	Math/μ Simp	
			μ LISP/μ Star	
			M-Sort	
			Multiplan	
			Microstat	
			CrossTalk	
			Northwest Analytical	
			Stalpak	

### WE'LL MATCH ANY ADVERTISED PRICE

Programming International will match any current nationally advertised price, where the advertiser is actually willing and able to sell at that price.

### HARDWARE

Carona	5MB Hard Disk	[6]	2495	1895
Datewriter				
Printer		[10]	1395	1235
Nayes Microcomputer				
Products				
Datcom Pascal				
Package			50	36
Hayes Stack Chrono-				
graph (RS-232)		[4]	249	199
Hayes Stack Smart-				
Modern (RS-232)				
300 Baud		[4]	279	209
Hayes Stack Smart-				
Modern (RS-232)				
1200 Baud		[4]	699	509
<b>NEC</b>				
12" Green Hi-Res				
CRT		[10]	285	167
7710 Printer		[10]	3085	2295
3530 Printer		[10]	2290	1735
8023 Printer		[10]	795	520
Novation				
J-Cal		[4]	148	119
Smart-Cal 103		[4]	259	207
Smart-Cal				
103/312		[4]	595	476

### dBASE Corner

- dBASE II (relational DBMS) . . . \$425
- Quickcode (program generator) . . . \$195
- dUTIL (programmer's utilities) . . . \$59
- ABSTAT (statistics package) . . . \$359
- D B Plus . . . \$95

Technical questions, M-F/9-5 (415) 324-0311

APPLE DOS		Edwards		Link Systems		Program Design Inc.		VisiCorp (Personal Software)	
Applied Software Technology		Compu-Read	30 22	Datatax	199 149	The New Step-by-Step	80 58	VisiCalc II 3.3	250 169
Versa Form		Perception	25 19	Datalink	100 75	Sensible Software		VisiFile	250 169
VS-1 Apple II/64K	389 249	Statistics	30 22	Link Video	195 149	Super Disk Copy III	30 23	VisiLink	250 169
VH-1 (Corvus)	495 360	Spelling Bee with Reading Primer	40 30	Link Sampler I	60 45	Multi Disk Catalog III	25 19	Desktop Plan II	250 169
VP-1 Versaform Pascal/Interface	245 180	Compu-Math/ Fractions	40 30	Link Disk	70 51	Disk Recovery ("The Scanner")	30 23	VisiPlot	200 156
ARTSCI (Sakapa)		Compu-Math/ Decimals	40 30	Link Enterprises		Applesoft Plus Structured BASIC	25 19	VisiTrend/Plot	300 234
Magic Window II (4070/80)	150 109	Compu-Math/Arithmetic Skills	50 37	Letter Perfect with Mail Merge	150 112	Disk Organizer II	30 23	VisiDex	250 194
Magic Window	100 75	Algebra 1	40 30	Data Perfect	100 78	DOS Plus	25 19	VisiTerm	100 65
Magic Mailer	70 49	Fractions (New version)	49 37	Edi 6502	100 78	Quickloader	25 19	VisiSchedule	300 234
Magic Words	70 49	Decimals (New version)	49 37	Lower Case Character Generator (accessory)	25 19	Image Printer-Letter Quality	40 30	Business Forecasting Model (req. VisiCalc)	100 78
Magic Pack Combo (Contains all 3)	225 156	Algebra 2	40 30	Lolus		Image Printer-Epson	40 30	† = CPM Softcard needed	
Ashlon-Tate		Counting Bee	30 22	Executive Briefing System	199 149	Image Printer-NEC Dot Matrix	40 30	<b>APPLE III</b>	
dBase II †	141 700 425	Compu-Spell/System	30 22	Micro Lab		The Bug	50 37	Applied Software Technology	
Avant-Garde Creations		Compu-Spell/Data Disk Levels 4 thru 8	20 15	The Invoice Factory	200 144	Build Using	30 23	Versa Form VS-3	495 371
Ultra Plot/01 F /Data Graph	99 71	Matri-Vert	16 12	The Merger	50 37	Edi Soli	30 23	DataMaster	
Beagle Brothers		Uni-Solve	25 19	The Learning System	150 108	Quadrant 6112	35 26	Write On	130 99
Alpha Plot	40 28	PSAT Word Attack	49 37	Painter Power	40 30	Sensible Speller	125 94	Univer Software	
DOS Boss	24 17	Skills	49 37	US Constitution Tutor	30 22	for SuperText	125 94	EASY (Executive Accounting System)	725 562
Utility City	30 22	SAT Word Attack	49 37	English SAT #1	30 22	for Apple CP/M	125 94	Insoft	
Apple Mechanic	30 22	EZ	69 55	VisiBlond	50 37	Pascal	125 94	TransForth III	125 94
Broderbund Software		Tax		VisiFactory	75 54	BEST (Applesoft Program Optimizer)	40 30	ALD System III	75 56
General Ledger (with A/P)	495 305	Hayden Software		The Asset Manager	200 144	Software Dimensions		Link Systems	
Payroll	385 275	Pie Writer/Standard	150 108	The Tax Manager	180 129	Accounting Plus™		Link Index	195 146
Commond		Pie Writer/Double Vision	150 108	Data Factory 5.0	300 216	GL AR AP Inv ea	395 239	Link Video	55 42
Roots/M †	195 140	Pie Writer/Multi	150 108	Wall Streeter	300 216	All four	1250 669	Link Sampler I	60 45
Computer Station		80-col	150 108	Payroll Manager	300 216	Software Publishing		Datatax	249 187
Combined Enhanced Graphics Software	55 40	for Smarterm. Videoterm. & Superterm)		Microsoft		PFS File	140 99	Datalink	149 112
Station Master	175 136	Hayes		Typing Tutor II	25 19	PFS Report	125 79	Micro Lab	
Comshare Targeted Software		Terminal Pgm	100 75	Time Manager	150 116	PFS Graph	140 99	Data Manager III	750 562
Target Planner/Calc I	99 74	Highlands Computer Services		A.L.D.S. †	125 97	Silicon Valley		Software Publishing Corp	
Image Maker	175 126	CHAE 2.0	40 30	Adios Math-80	125 87	Word Handler	199 145	PFS: File	175 120
Continental		MCAT 2.0	25 19	M-Sort	195 151	List Handler	90 68	PFS: Report	125 86
Home Accountant	75 52	E-Z Ledger	60 37	µLisp/µStar	200 156	Dictionary	125 94	PFS Graph	175 120
1st Class Mail	75 54	Howard Software		Multipan	275 179	Sirius		VisiCorp	
CPA #1 - GL	250 159	Creative Financing 1983	195 149	MUSE		Pascal Graphics Editor (48K II+)	100 69	Desktop Plan III	300 234
CPA #2 - AR	250 159	State Tax Prep. CA 83	225 179	Supertext 40/56/70	125 79	Southwestern Software		Visischedule III	300 234
CPA #3 - AP	250 159	Tax Preparer 1983	195 146	Supertext 40/80	175 126	Data Capture 4.0	65 45	Visicalc Advanced III	400 312
CPA #4 - PR	250 169	Real Estate Analyzer II	195 146	Form Letter Module 48K	100 72	Data Capture 4.0/Video		Business Forecasting Model	100 78
All four	51000 609	Information Unlimited Software (IUS)	150 108	Address Book Mailing List 48K**	50 36	Smarterm Super-term	90 65	<b>APPLE IIe</b>	
CPA #5 - Property Management	495 352	Datadex	150 108	Data Plot 48K**	60 43	Southwestern Data Z-Term Professional †	150 99	Software Publishing	
Crans Software		Datadex/Hard Disk Professional	300 216	Elementary Math Apple Soft 48K**	40 29	ASCII Express	80 59	PFS File	99
Menu Generator	40 29	Easywriter Professional	175 120	The Voice 48K	40 29	ASCII Express Professional	130 89	PFS Report	79
Creative Curriculum, Inc.		Easywriter	150 108	**Requires Applesoft, ROM or Apple II Plus		STC Professional Time and Billing	395 284	PFS Graph	99
Speed Reading Courseware	99 75	EasyMater	150 108	Omega Locksmith	100 75	Language Reading Development Program	175 126	VisiCorp	
Dafin 5/Level 10		Easy Mover	100 75	On-Line Systems		Apartment Manager	325 234	Visicalc Enhanced	202
Deprecation Planner	395 299	TelStar Level I	40 30	The General Manager	230 168	Stock Market Software, Inc.		<b>APPLE HARDWARE</b>	
Budget Planner	150 112	TelStar Level II	80 58	Screenwriter II	130 85	On Balance Volume Charting (Stock Market analysis) [Includes \$300.00 first year maintenance and update fee]	1500 1299	Hayes	
Business Bookkeeping System	395 289	FORTH Development System	140 101	The Dictionary	100 70	Stoneware		Micromodem II (with terminal pgm)	410 289
Datamat		Insol		Expeditor II* (Applesoft computer)	135 94	DBMaster	229 148	Keanington	
Write On II	130 90	GraFORTH II	75 56	LISA 2.5	80 56	Utility Pak #1	99 65	System Saver (Fan)	90 65
Real Estate Analysis Program	130 90	Electric Duot	30 23	EPFIV (Extended Programming Facility IV)	80 56	Utility Pak #2	99 65	Micro-Sci A2 3ST Disk Drive	510 329
Tax Beater	130 90	TRANSFORTH II	125 94	Peachtree Series 40 GL, AR AP Inventory, Payroll (eal)	400 239	DBMaster/Hard Disk	499 359	RAMcard (memory board)	100 69
Dataseft, Inc.		ALD System II	75 56	Penguin Software		Stat Pac	99 71	Softcard (CP/M board)	345 219
Micropainter (48K)	35 25	International Software Marketing		Complete Graphics System	70 50	Micro Memo	40 30	Premium System Softcard, 16K RAMcard, Video Videoterm 80 col Card Softswitch, Osborne CP/M User Guide	510 489
BASIC Computer (132K)	100 75	Mathemagic (Advanced programmable calculator package)	90 65	Special Effects	40 30	Electronic Price Sheet	100 72	Personal Computer Appli-Card (6MHz)	595 429
LISP Interpreter	125 94	Graphmagic	90 65	Graphics Magician	60 45	CompuCube	30 22	Video	
Decision Support		ISA (See Sorcim)		Additional Fonts and Character Sets	20 15	Graphics Processing System (Standard)	60 45	Keyboard Enhancer II	149 99
The Accountant	129 97	Kensington Microware Ltd. Format II	250 169	Complete Graphics System II (Apple Tab Ver I)	120 86	Graphics Processing System (Professional)	179 129	Videoterm w/Soft-Switch	375 239
Accountant with DBCalc	149 107	Lighting Software		Special Effects (Apple Tab Ver J)	70 50			* Manufacturer's trademark	
Delta Software		MasterType	40 30						
Bookkeeper Master Program	90 68								
Bookkeeper Check Writer	40 29								
Denver Software									
Pascal Tutor	125 97								
Pascal Programmer	296 223								
Financial Partner	250 188								

### TELEPHONE ORDERS

Outside Calif.: (800) 222-8811  
 Inside Calif.: (415) 324-3730  
 Hours: 7-8, Mon.-Fri., 9-5 Sat.  
 Inquiries/price quotes (415) 324-0305  
 Order status (415) 324-0306  
 Technical Support (415) 324-0311

MORE CP/M\*, APPLE\*, IBM PC\*, UNIX\*\*, UCSD p-System\*\* software, hardware, etc. call for quote.

## PROGRAMMING INTERNATIONAL

505 Hamilton Ave. • Suite 107  
 Palo Alto, CA 94301

TERMS: All prices subject to change without notice and availability. Cashier's check/MO/bank transfer. Allow time for company or personal checks to clear. Prices reflect cash prepaid discount. VISA/MASTERCARD/COD/PO's + 3% CA residents add sales tax. All sales final for games & special orders.

SHIPPING: \$2 per item for UPS surcharge (\$6 for Blue Label) within continental USA, except where shipping cost is specified in square brackets.

RETURNS: Must have authorization number obtained at 415-324-0305. Unauthorized returns will be refused; damaged goods will be refused. All returns subject to 10% restocking fee.

# WHY PAY MORE?



# Design Philosophy Behind Motorola's MC68000

## Part 2: Data-movement, arithmetic, and logic instructions

---

Thomas W. Starnes  
Motorola Inc., Microprocessor Division  
3501 Ed Bluestein Blvd.  
Austin, TX 78721

---

Last month, in part 1, I discussed the design philosophy behind the Motorola MC68000, a powerful 16-bit processor with multiple 32-bit registers. This month I'll describe the data-movement, arithmetic, and logic instructions of the MC68000. A thorough reading of the MC68000's user's guide (available from many computer bookstores and Motorola distributors) will give you all the details of each instruction's operation, but a look at the general categories of instructions, a discussion of why certain design decisions were made, and mention of some special capabilities of the instructions will give you insight into the power of this instruction set.

### Instruction Format and Addressing Modes

Before I get into the instruction groups, let's first look at how assembly-language instructions are written. Table 1 illustrates a common instruction format and the choices that can be made within it. First, of course, you can pick one of several microprocessor

instructions—for example, an addition (ADD), comparison (CMP), arithmetic shift left (ASL), or data move (MOV). If the instruction is one that handles data, you can, with the MC68000, select one of three data sizes: 8, 16, or 32 bits. This selection is made by following the mnemonic with a period and either a "B", "W", or "L", for byte, word, or long word; if no size is specified, the assembler will assume a 16-bit operation.

On a data operation, you need to make one or two more decisions, i.e., which addressing mode to use for the one or two operands the instruction requires. (See the text box on data organization on page 354 for more details.) Typically, you can select one of 14 modes; within most of these modes, one of eight address registers is selected. On many operations, you need to select a second addressing mode; this usually involves selection of one of eight data registers, but for the data-movement instruction, any addressing mode can be selected.

All MC68000 instructions are fully defined with 16 bits of *op code*. (*Op code* is short for operation code; it is the pattern of bits that a microprocessor interprets as a specific machine-language instruction executable by it.) Depending on the instruction or the addressing mode(s) selected, addi-

tional 16-bit extension words may follow the *op code*. These extension words provide additional addressing information and may make the total instruction length as long as 10 bytes. Because the instruction is always lengthened by multiples of 16 bits, you can ensure that instructions always begin on even-byte boundaries; because of the way the MC68000 fetches 16-bit quantities from memory, this placement of instructions increases the speed of program execution.

By far, the most common operation in any processor application is the movement of data. Other microprocessors move data with LOAD, STORE, PUSH, PULL, POP, and input/output (I/O) instructions. When you boil it all down, each instruction simply moves data from one location to another. So why not call them all MOVE? Simplicity of expression is a fundamental theme throughout the MC68000's instruction set: all similar operations should perform similarly in a number of respects. For example, if you can use an ADD operation with two 32-bit quantities, you should be able to use an add-with-carry operation with two 32-bit quantities. If you can select from 14 addressing modes to use an ADD operation, you should be able to select from 14 addressing

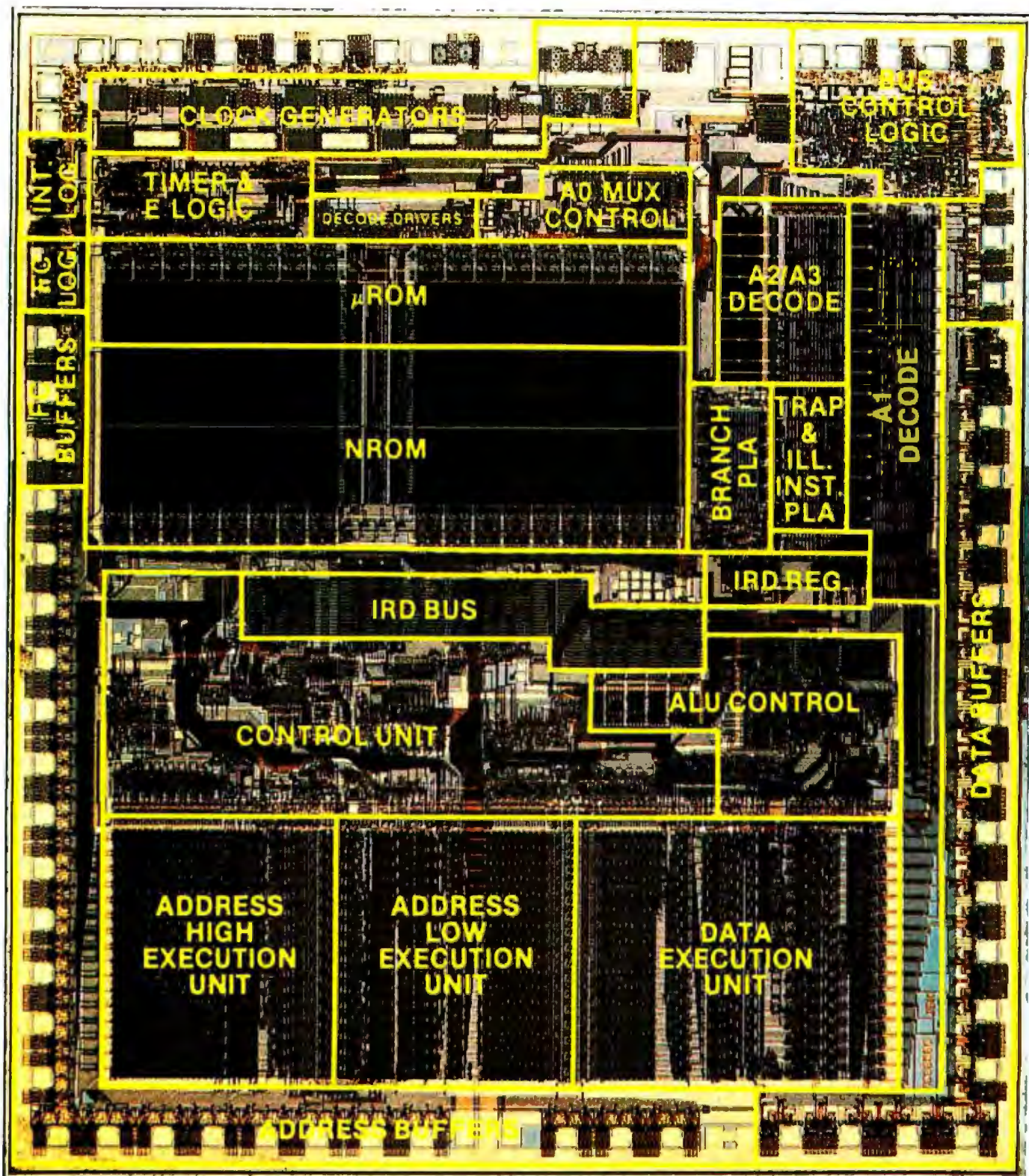
---

### About the Author

Thomas Starnes is an electrical engineer who has spent the last five years helping to plan the direction of the MC68000 family of processor products for Motorola.

---





**Photo 1:** The MC68000 microprocessor chip, which contains more than 68,000 transistors, is 246 by 281 mils (6.24 by 7.14 mm) in size. This photo shows the location of the major functions of the chip. "Int. Log." stands for "Interrupt Logic"; "A0 Mux Control", for "Microcode A0 Multiplexer Control"; and "FC Log.", for "Function Code Logic." The labels "μROM" and "NROM" indicate two areas of microcode. "Trap and Ill. Inst. PLA" stands for "Trap and Illegal Instruction Programmable Logic Array"; "IRD Reg.", for "Instruction Register Decode Register"; and "ALU Control", for "Arithmetic and Logic Unit Control." The Data Execution Unit houses the main functions of the arithmetic and logic unit, while the two Address Execution Units perform the arithmetic associated with the calculation of an address.



**Instruction format is:**

mnemonic.size source,destination

**Examples:**

```
ADD.L   D1,D2
MOVE.B  #15,-1(A0)
ADD     D1,D2      (size assumed to be ".W")
BGE    LOOP1      (only one argument)
RTS     (no arguments)
```

**Explanations:**

mnemonic = instruction abbreviation (ADD, CMP, MULS, etc.)  
 size (optional) = operand size:  
     .B means byte data (8 bits)  
     .W means word data (16 bits; default size)  
     .L means long word data (32 bits)  
 source (optional) = source operand addressing mode  
 destination (optional) = destination operand addressing mode

**Table 1: General format for MC68000 instructions.**

modes to use SUB (subtract). If certain status register codes are modified to reflect the results of an ADD, the same codes should also be modified when a SUB or NEG (negate) instruction is performed.

**Varieties of MOVES**

With this philosophy in mind, all of the old LOAD, STORE, PUSH, PULL, POP, and I/O instructions from other

microprocessors were rolled into one very powerful and flexible MOVE instruction in the MC68000. Let's look at just what this one instruction can do.

The MOVE instruction can move 8-, 16-, or 32-bit data from practically any location to practically any other. And a wide selection of addressing modes and registers for both the source and the destination should cover about any way you want to find

the operands. Table 2 lists the different combinations of addressing modes available on both the MC68000 and the Intel 8086 families. Let's look at what some of the MC68000 addressing-mode combinations allow you to do.

Certainly, you can copy data between registers, but you can also copy data to or from a register to memory using any of the memory-addressing modes. Most microprocessors allow the programmer to transfer data on the top of a stack to or from a register only. What if the data is really needed elsewhere in memory? You must run a second instruction to make the second move and use a register for a temporary holding space. The MC68000 allows you to move top-of-stack data to or from any register, another stack, a queue, any memory location, or any I/O location, all in one smooth motion. And why shouldn't you be able to? An added advantage of the MC68000 comes from its ability to use any one of the eight address registers as a stack pointer; this allows you to build as many as eight different stacks without having to swap out registers.

You can also do direct memory-to-memory moves. There are 10 different

	destination	Dn	An	(An)	(An) +	-(An)	d16(An)	d8(An,Xn)	Abs.W	Abs.L
	#options	8	8	8	8	8	8	128	N/A	N/A
source	#options									
Dn	8	M	M	M	M	M	M	M	M	M
An	8	M	M	M	M	M	M	M	M	M
(An)	8	M	M	M	M	M	M	M	M	M
(An) +	8	M	M	M	M	M	M	M	M	M
-(An)	8	M	M	M	M	M	M	M	M	M
d16(An)	8	M	M	M	M	M	M	M	M	M
d8(An,Xn)	128	M	M	M	M	M	M	M	M	M
Abs.W	N/A	M	M	M	M	M	M	M	M	M
Abs.L	N/A	M	M	M	M	M	M	M	M	M
d16(PC)	1	M	M	M	M	M	M	M	M	M
d8(PC,Xn)	16	M	M	M	M	M	M	M	M	M
Immediate	1	M	M	M	M	M	M	M	M	M

**Notes:**

- "M" means this combination available on the Motorola MC68000.  
 "I" means a comparable combination available on the Intel 8086 family.
- "#options" refers to the number of different ways an addressing mode can be used in the MC68000 due to the availability of multiple registers that can be used; for example, the "d8(An,Xn)" option can use 8 An registers and 16 Xn registers for a total of 128 combinations. "N/A" means "not applicable."
- Most of the source and destination addressing modes are explained in the text box "Data Organization and Addressing Modes," page 354. "An" and "Dn" are register addressing modes. "Abs.W" and "Abs.L" are word-address and long-word-address forms of absolute addressing.

**Table 2: Addressing modes available to the Motorola MC68000 and the Intel 8086. The information at the intersection of a row and a column indicates the availability of that source/destination addressing-mode combination for each microprocessor.**

# "I built this 16-bit computer and saved money. Learned a lot, too."

Save now by building the Heathkit H-100 yourself. Save later because your computer investment won't become obsolete for many years to come.

Save by building it yourself. You can save hundreds of dollars over assembled prices when you choose the new H-100 16-Bit/8-Bit Computer Kit – money you can use to buy the peripherals and software of your choice.

## H-100 SERIES COMPUTER SPECIFICATIONS:

**USER MEMORY:**  
128K-768K bytes\*

**MICROPROCESSORS:**  
16-bit: 8088  
8-bit: 8085

**DISK STORAGE:**  
Built-in standard  
5.25" disk drive,  
320K bytes/disk

**KEYBOARD:**  
Typewriter-style,  
108 keys, 13  
function keys,  
18-key numeric pad

**GRAPHICS:**  
Always in graphics mode.  
640h/225v resolution;  
up to eight colors  
are available\*\*

**COMMUNICATIONS:**  
Two RS-232C Serial  
Interface Ports and  
one parallel port

\* 128K bytes standard.  
\*\* Optional.

**DIAGNOSTICS:**  
Memory self-test  
on power-up

**AVAILABLE SOFTWARE:**  
Z-DOS (MS-DOS)  
CP/M-85  
Z-BASIC Language  
Microsoft BASIC  
Multiplan  
SuperCalc  
WordStar  
MailMerge  
Data Base  
Manager  
Most  
standard  
8-bit CP/M  
Software



The H-100 is easy to build – the step-by-step Heathkit manual shows you how. And every step of the way, you have our pledge – "We won't let you fail." Help is as close as your phone, or the nearest Heathkit Electronic Center.†

And what better way to learn state-of-the-art computing techniques than to build the world's only 16-bit/8-bit computer kit? To run today's higher-speed, higher-performance 16-bit software, you need an H-100. It makes a big difference by processing more data faster.

Dual microprocessors for power and compatibility. The H-100 handles both high-performance 16-bit software and most current Heath/Zenith 8-bit software.

Want room to grow? The H-100's standard 128K byte Random Access Memory complement can be expanded to 768K bytes – compared to a 64K standard for many desktop computers.

And the industry-standard S-100 card slots support memory expansion and additional peripheral devices, increasing future upgradability of the H-100.

High-capacity disk storage, too. The H-100's 5.25" floppy disk drive can store 320K bytes on a single disk. The computer also supports an optional second 5.25" and external 8" floppy disk drives. And an optional internal Winchester disk drive will be available soon.

For more information, circle the reader service number below. Better yet, visit your Heathkit Electronic Center for a demonstration!

*The H-100 gives me the most for my computer dollar!*

**Heathkit**  
Heath  
Company



LONG TRANSFER TO/FROM AN EVEN ADDRESS.

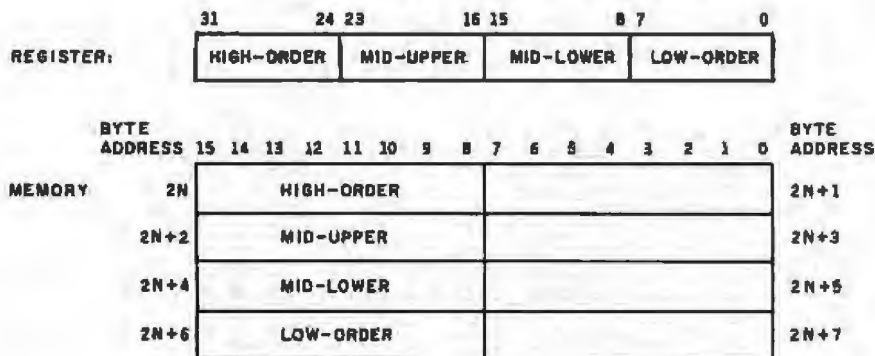


Figure 1: Moving data from a 32-bit register to memory using the MOVEP instruction. Bytes from the register are stored in every other memory byte. The instruction takes 24 clock cycles to execute.

memory-addressing modes to select from for the source operand and seven for the destination. Also, keep in mind that each addressing mode can use any of the eight address registers, further increasing the versatility of these move instructions. (Actually, in one mode, you have 16 registers to choose from—eight address and eight data registers.)

Just how many different ways are there to move general data in the MC68000? When you couple all of the combinations allowed with the selection of registers available, there are 34,888 different ways, and each one can be used for 8-, 16-, or 32-bit data. That ought to solve most programmers' data-shuffling problems!

The remaining data-movement instructions include SWAP, for instance, which exchanges the contents of any two data and/or address registers. You can read or modify the status register codes with a MOVE SR (Status Register) instruction.

The MC68000 was designed to interface directly to the MC6800 line of 8-bit peripherals so that all the existing peripheral circuits could easily be used on the MC68000. (Many of the 8-bit peripherals provide very useful functions that would need to be included in a 16-bit system.) To bring the best of the 8-bit peripheral world into the universe of 16-bit software, designers included a special MOVEP (Move Peripheral) instruction in the MC68000. Here's how and why it works.

Frequently, you must set up registers to ready a peripheral for operation. You need to connect an 8-bit peripheral to either the upper or lower half of the 16-bit-wide data bus. This means that the registers connected to a peripheral appear within the MC68000 memory address space as successive-even or successive-odd addresses. The MOVEP instruction will move either 16 or 32 bits of a given data register out to memory in 8-bit chunks, starting at a given location (see figure 1); addresses for each successive byte are incremented by two, not by the one that the normal MOVE uses. This allows the 2 or 4 bytes being transferred to be loaded into the proper peripheral port addresses. Thus, you can load as many as four 8-bit registers in one simple instruction. The MOVEP instruction is bidirectional, so that the registers can be either loaded or read.

Two special types of the MOVE instruction are the MOVEQ (Move Quick) and the MOVEM (Move Multiple Register). Often a register is used as a counter or a constant, with values that are typically rather small. The MOVEQ instruction makes it fast and easy to initialize a register to such values. MOVEQ will take any signed 8-bit immediate value between -128 and 127, extend its sign bit so that it will be correctly interpreted as a 32-bit number, and load it into one of the data registers. The op code for MOVEQ includes the 8-bit immediate

value; this means the microprocessor can perform the operation very quickly. Because the small immediate value is part of the MOVEQ op code itself, the instruction is classified as a separate addressing mode of the MC68000 called the "quick immediate" addressing mode.

It is common in machine-language programming to have to save the contents of various on-chip registers, use the registers for some other purpose, and then restore their former contents. This happens when you are beginning or ending a subroutine, executing an interrupt handler, changing tasks, or calling the operating system. The MC68000 has a very handy instruction that makes this a fast, efficient operation. The MOVEM instruction will take any combination (or all) of the 16 data and address registers and move them either to or from memory in an organized manner. These registers can be transferred to or from any stack or to a specific location in memory. They are put in memory and taken from memory in reverse order to ensure that each register receives its proper contents. An option of the MOVEM instruction is that either the lower 16 bits of the registers or the entire 32-bit registers can be transferred. An example of this instruction is:

```
MOVEM.L D0/D4-D7/A4/A5,40(A6)
```

which would save the registers as shown in figure 2. (The instruction will save registers D0, D4 through D7, A4, and A5 into memory starting at the location pointed to by the value in register A6 plus the value 28 hexadecimal.) The list of registers to be transferred is compactly encoded in a 16-bit value that follows the MOVEM op-code word—an "on" bit indicates the associated register is to be transferred. Not only is the MOVEM instruction both compact and useful, it is also as fast as possible for the number of bytes of information that must be transferred.

### Orthogonality

Arithmetic operations are key instructions in a microprocessor because they tend to be the ones that



"The Sanyo MBC 1000 is basically an excellent performer, operating both fast and reliably."  
Infoworld - 11/29/82



# SANYO PLUS



# \$1995

A full feature, fast, all-in-one z80 computer with \$2185 of software for \$1995.

The Sanyo Plus consists of a Sanyo MBC-1000 computer with a built-in 12" high-res. green phosphor 25x80 display. The detached keyboard features 5 special function keys and a 10-key pad. The Sanyo Plus comes complete with a parallel printer port, a serial communications port and room for three additional cards.

Plus you receive a second drive for a total formatted disk capacity of 624K.

Plus we now include over \$2000 worth of software including CP/M® 2.2, Sanyo Basic, WordStar 3.0 with training guide, Mailmerge, SpellStar CalcStar, InfoStar and a games disk. We thoroughly integrate and test each system, and generate work copies of your software.

Plus you get a 300 baud direct connect modem, with cable free modem software and a one-month subscription to The Source™.

One year warranty \$99. One drive system \$1649. Hard disks: 10 Mb-\$1995/16Mb. \$2395. (supply limited, no dealers please.)

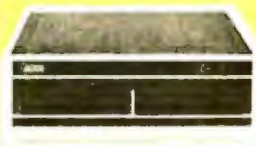
### TELEVIDEO



Now backed locally by T.R.W. Built-in CRT, detachable keyboard, dual floppies w/750K formatted capacity, 64K CP/M and more. Special: Telesolutions - Wordstar TM and CalcStar TM w/system \$279.

802 w/CP/M®	\$2669
803 w/CP/M®	\$1898
806 (20 Mb)	\$5149
TS 1602G	\$3495
816 (20 Mb)	\$6298
800A's	\$1299

### ALTOS



Our tech's favorite systems. From the lowest priced 3-user systems with either 2 or 8 MG. storage, to 40MG, 8-user 16 bit systems.

Add terminals, printers, and software and we can fully test and configure your system at low prices. Back nationwide by Moore Systems Service.

Series 5-15D	\$2195
Series 5-5D	\$3995
8000-10	call
8600-12	\$9465
Series 5-8000 systems include MP/IM	

### DIGITAL



New from DEC, microcomputers designed for the professional. Nationwide DEC service and reliability are standard. Free spreadsheet software with each system. Bridge the 8 bit/16 bit gulf with a system which runs both.

Rainbow 100 system	call
Professional 325 system	call
Professional 350 system	call

### NORTHSTAR



FREE SPREADSHEET

Prices now include free burn and test. We warranty each unit for 90 days from the day you receive it (not 90 days from the day we receive it). Call for prices on compatible software and hardware.

Advantage 64K Quad	\$2769
Horizon 64K Quad ...	\$2695
Advantage w/5 Mb.	\$3795

### TERMINALS



Now a full feature terminal at a dumb terminal price. 8 Edit function keys, 8 programmable function keys, 256 characters in a 8x12 cell graphics, detached keyboard with palm rest, printer port, 12" non-glare Sanyo display, keypad w/enter key, and much more. \$549. Adds 3A - Emulates the ADM-3A, detached keyboard, keypad, 12" green display nationwide Adds service. \$469.

Wyse 100	\$699
Wyse 200	call
Televideo 910	\$579
Televideo 925	\$735
Televideo 950	\$927
Televideo 970	\$1044
Zenith Z-19	\$689
Zenith ZT-1	\$459
Hazeltine Esprits	call
Qume	call
HOUSTON INSTRUMENTS	call

Zenith z110 ..... \$3089 Zenith z120 ..... \$3165

### PRINTERS



Okidata 82A	\$389
Okidata 83A	\$635
Okidata 84	\$969
Okidata 92	\$489
Okidata 93	\$835
Tally 160L	\$739
I.D.S. Micropism	\$525

### HIGH SPEED

Prism 80 "Loaded"	\$1369
Prism 132 "Loaded"	\$1469
Anadex 9501A	\$1369
DataSouth DS-180	\$1249
TI-810 Basic	\$1285

### LETTER QUALITY

Diablo 620	call
NEC 3510	\$1495
NEC 7710	\$2149
Transtor	call

## Scottsdale Systems Ltd.

617 N. Scottsdale Road, Suite B, Scottsdale, Arizona 85257

(602) 941-5856

Call 8-5 Mon.-Fri.



We participate in arbitration for business and customers through the Better Business Bureau of Maricopa County.

### SERVICE/ORDERING

**INTEGRATION:** Prices listed are for new equipment in factory sealed boxes with manufacturer's warranty. We will pretest your equipment, integrate your system, configure your software, provide special cables, etc., for an additional charge. Call for prices.

**ORDERING: MAIL ORDER ONLY.** Prices listed are for cash. No C.O.D.'s. We sell on a net 20 basis to Fortune 500 companies and Universities. Charge cards add 2%. Prices subject to change, product subject to availability. AZ. residents add 5%. Personal checks take 3 weeks to clear. 0-20% restocking fee for returned merchandise. Shipping extra - products are F.O.B. point of shipment. CP/M and MP/IM are registered trademarks of Digital Research.

**SOFTWARE:** We sell all popular CP/M® programs at discount. Software sold only with systems not warranted for suitability.

### GEMINI



The new best selling dot matrix printers, 100 c.p.s., litigation, tractor and roll feed. Graphics, 180 day warranty, 2.5K s/d buffer and much more.

Gemini 15	\$460
Gemini 10	\$304

### SANYO PR 5500

Finally - A full function, heavy duty, letter quality printer at a dot matrix price. Wide carriage, selectable 10, 12, or 15 pitch, 16 C.P.S. (Shannon text), bi-directional, s/d, parallel interface, bold, superscript, and subscript printing, s/d, cartridge ribbons, and more.

\$669





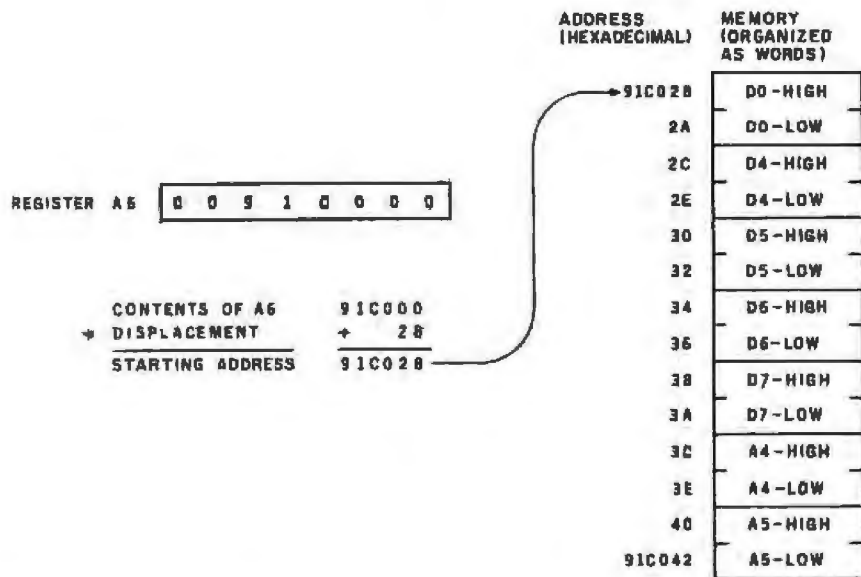


Figure 2: Pushing multiple registers to memory with the MOVEM instruction. This instruction offers a very fast way to store selected registers in memory and, later, restore them properly. This figure shows the storage of registers D0, D4 through D7, A4, and A5 to location 91C028 hexadecimal. The instruction itself is MOVEM.L D0/D4-D7/A4/A5,40(A6). (Remember that 40 decimal equals 28 hexadecimal.) The instruction takes 58 clock cycles to execute.

do the bulk of the work. The arithmetic and logic instructions allow programmers to write code exactly as they desire without having to rearrange data, gather more data, or do things in an unnatural order. As with so many other characteristics of the MC68000, the design of the arithmetic and logic instructions is very orthogonal—more so than for any previous microprocessor. *Orthogonality* can be defined as the ability of any allowed operation to use any resource in any way that any other operation may.

The arithmetic and logic instructions are very similar in the way they function, the way the condition codes are affected as a result, and the selection of addressing modes, registers, and operands available to them. The advantage of this is that, when coding, the programmer has only one uniform set of rules to remember. Older microprocessor designs forced programmers to have different sets of rules for even similar instructions, which decreased programmers' productivity by forcing them to recall and use correctly large amounts of essentially arbitrary information.

All of the dual-operand arithmetic instructions are true "one-and-a-half"

address operations (i.e., one operand can be specified as a memory address, but the other must be an internal register—the result overwrites one operand). Thus, you can add any register to any register, a constant to any register, the top of a stack to any register, a value buried in a stack to any register, a table entry to any register, an input from an I/O device to any register, or any memory location to any register. Or, because the order may be reversed, you can add any register to any of the same (except that you can't add to a constant, and you can't use the program-counter relative addressing mode to specify a destination). Also, remember that any of these instructions can occur with 8-, 16-, or 32-bit data.

### Arithmetic Instructions

Let's look at the types of arithmetic instructions that are available. Add (ADD), subtract (SUB), and compare (CMP) instructions are general two-operand instructions. ADDX and SUBX are used to work on numbers longer than 32 bits (the X condition bit in the MC68000 performs a function similar to the one the carry bit performs in most microprocessors). Two multiply and divide instructions

are available: signed (MULS and DIVS) for single-precision instructions and unsigned (MULU and DIVU) for multiple-precision instructions.

The negate (NEG) and clear (CLR) instructions require only a single operand, and you can use a NEGX to negate multiple-precision values. To blend mixed sizes of data, the MC68000 provides a sign-extend instruction (EXT), while a TST (test) instruction is used to check for positive, negative, or zero conditions. A special instruction, the indivisible test-and-set (TAS), provides software synchronization in multimicroprocessor operations.

One variation on the ADD instruction enables the MC68000 to overcome a common limitation of other microprocessors. The normal "one-and-a-half" address design of most processors makes it difficult to use constant (immediate) values with anything but registers. The MC68000 overcomes this with the ADDI instruction, which allows a byte, word, or long-word immediate value to also be added to an operand in memory using any legal destination-memory addressing mode.

The MC68000 has no increment or decrement instructions. Why? Remember, the idea is to treat all similar instructions the same. An increment instruction adds 1 to a quantity and is often used to step to the next element in a table of byte-wide values. But the MC68000 programmer will often be manipulating 16- and 32-bit data, which require increments of 2 and 4, respectively, to the table address. The design team wanted to generalize the increment and decrement instructions to make them useful with all data sizes yet still retain the speed associated with an instruction that does not have to fetch an immediate argument. To solve these problems, and then some, the designers gave the MC68000 "add quick" (ADDQ) and "subtract quick" (SUBQ) instructions, which allow any number from 1 to 8 to be added to or subtracted from any register or any memory location. The instructions accomplish this in the shortest possible time by using 3 bits within the 16-bit op code to hold the increment or decrement

*Text continued on page 352*



# WE LEAD THE FLEET WITH NATIONALLY KNOWN BRANDS AND LOW PRICES.

**SYSCOM II**  
Faithful to the Core  
**\$625**

"Upper/lower case"



## COMPUTERS

Apple II-E Starter System	\$1725
Chameleon, Columbia, Compac, Columbia	Dur staff knows!
Commodore 64, #1541 Drive, CRT, & software	\$945
Franklin ACE 1000	\$935
Franklin ACE 1200—1 drive, 80 column, 2-80, software	\$1735
IBM PC	Complete systems start at \$2650
Kaypro II w/Software	\$1695
<b>Kaypro II+</b>	400K drives \$1875
Kaypro 10	10MByte hard disk \$2775
NEC APC H02	green/2 drives \$3290
NEC APC H03	color/2 drives \$4190
Osborne Double Density	\$1825
Slimline S-100: Z-80, CP/M, 64K, 2MByte drives	Under \$2000
Syscom II—Apple II Plus Emulator	not a #@! kit \$625

## PRINTERS

Epson MX-80FT Type III	STILL AVAILABLE	\$505
Epson MX-100	w/Graphtrax	\$685
Epson FX-80	160cps, friction sprocket	\$585
Brother/Comox/BMC	(daisywheel, 17cps)	
New Model		\$785
F-10 Starwriter	40cps, Diablo codes	\$1225
6X-100 Graphic Printer	50cps, 5x7 matrix, sprocket feed	\$285
Mannesmann-Tally 180L	uses Daisy software	\$785
NEC 7710		\$2095
NEC 7730		\$2145
Okidata	uses standard spool type ribbons	
u82A	80 column, 120cps	\$415
u83A	132 column, 120cps	\$675
u84AP	200cps, 132 column, parallel	\$365
u92	160cps, 80 column, parallel	\$525
Prowriter II (C. Itoh 8510A)	120cps, proportional	\$435
Prowriter II (C. Itoh 1550A)	wide carriage	\$675
STAR MICRONICS	Runs Epson software, 100 cps, f/l, graphics	
Gemini 10	80 column, 100 cps	\$365
Gemini 15	15" wide	\$470
Toshiba #1350	top of the line dot matrix	\$1625

## VIDEO MONITORS

Amdek 300G	\$149
Amdek 300A	\$185
Amdek 310G	for IBM monochrome adaptor \$175
Amdek 310A	amber for IBM \$185
Amdek Color I	13" color composite \$325
Amdek Color II	13" RGB for IBM—16 color with cable \$675
BMC 12" Green	not fancy, but it works \$94
BMC 13" Color	composite \$310
BMC 13" RGB with card for Apple II+	\$395
Dynax 12" Green (6M-120)	BEST BUY \$129
Dynax 12" Amber (AM-121)	970 line resolution \$145
IBM MONOCHROME green	\$345
IBM COLOR	\$not available at press time
JCS RGB-III (630 lines, 16 colors, PC cable)	—ideal for 80 columns, graphics BEST BUY \$485
Princeton Graphics HX-12	\$595
Taxan VISION-III	RGB for IBM \$535

## SIERRA DATA SCIENCES

• S-100 cards for single and multi-user systems • Multi-user systems need one master, one additional slave per user and Turbo-DOS software • Complete systems with drives and CRT terminal are available.

Z-80 4MHz Master (84K/2 serial/floppy controller/hard disk part)	SBC-100	\$655
Z-80 4MHz Slave (2 serial/2 parallel/64K/EPR0M programmer)	SBC-100S	\$565
4-Port serial communication board	Z810/4	\$235
RS-232 Multiplexer board	SDS-MUX	\$235
Hard disk interface for Micropolis	SDS-HDI-M	\$129
CP/M for Master with BIOS	CPM/BIOS	\$150
Turbo-Dos for Master with Slaves	TURBO-DOS	\$645

## FOR COMMODORE 64

DATA 20 VideoPak 80	80 column display	\$165
DATA 20 Z-80 VideoPak	CP/M and 80 column	\$275
Serial to Parallel Printer Cable		\$79

## FOR APPLE—FRANKLIN—SYSCOM

<b>Advanced Logic Systems</b>		
CP/M Card	list \$399	\$295
Z-Card II	list \$169	\$135
Smarterm II	list \$179	\$139
Dirt Cheap Video	list \$89	\$75
Color II—RGB converter	list \$179	\$149
dBase II (requires CP/M)		\$429
Davong 10 MByte hard disk	BEST BUY	\$1835
Diagnostics Disk	tests drive, RAM, ROM, ports	\$45
Dumpling GX	like Grappler	\$115
Dumpling 16K	graphics and buffer, expandable	\$185
Fourth Dimension Parallel interface with cable		\$68
Grappler + (graphics for most printers)		\$135
Hayes Micromodem II		\$275
Hayes Micromodem II with Terminal Program		\$295
Mail Merge		\$95
<b>Magic Window/Word/Calc software pkg.</b>		\$235
<b>Rana Elite One</b>	up to 40 Track	\$285
Rana Elite One Plus	with controller	\$375
Rana Elite Two	double storage	\$455
Rana Elite Three	quad storage	\$585
Serial Interface		\$105
SSM Modemcard w/SOURCE		\$285
SuperCalc		\$155
<b>VISTA QUARTET (2 drives, thin, 640K, controller)</b>		\$595
Vista V-1200, 6MB removable cartridge system		\$1225
Wordstar		\$185

## MODEMS

Hayes Smartmodem 300	\$215
Hayes Smartmodem 1200	(the market approves) \$545

## NEC APC

<b>Advanced Personal Computer</b>	
Send a stamped/addressed envelope for a complete data sheet.	

## FOR IBM PC

AST Research cards include Spooler and Disk Emulator.		
AST ComboPlus with 64K, serial, parallel, clock		\$265
AST MegaPlus 64K, serial, parallel, clock		\$305
AST MegaPak 256K for MegaPlus		\$295
Davong 10MByte Hard Disk		\$1835
Keytronic keyboard		\$500
Monte Carlo 64K/S/P/Clock/Game		\$375
<b>MTI 512K RAM Board (with 64K)</b>		\$259
RAM sets (64K with parity)		\$65
Tandon TM100-2	Price may fluctuate	
Tandon TM100-4	with DOS-FIX	\$335
TEAC 320K Half-Height	F055-B	\$285

## FOR ATARI

AXLON Rampower 32 (400/800)	list \$120	\$105
Rampower 4B (400)	list \$185	\$155
Rampower 12B (800)	list \$475	\$375
850 Printer Interface		\$175
Printer Cable		\$35
<b>Rana Elite 1000</b>	single/double density floppy	\$335
Serial Cable		\$35

## CHAMELEON by Seegua

LOCAL SALES ONLY  
**\$1995**

## CORONA DATA SYSTEMS

Systems include half-height 320K drives, 128K RAM expandable to 512K on-board, 640 x 325 graphics, green monitor with 16 x 13 matrix characters, serial port, parallel port, DOS, Basic, and spreadsheet software.

PC-1 1 drive	list \$2595	\$2095
PC-2 2 drives	list \$2995	\$2375
PC-HD IBMByte hard disk	list \$4495	\$3495
PPC-1 Portable/1 drive	list \$2395	\$1950
PPC-2 Portable/2 drives	list \$2795	\$2250

## WABASH DISKETTES

Single Side Single Density 5 1/4" soft sector	with hub ring	
	5 boxes at \$17.50 per box	
Single Side Double Density		5 boxes at \$21/box
Double Side Double Density		5 boxes at \$32/box



## S-100 THINLINE COMPUTER SYSTEM

• Sierra Data Master (Z-80 4MHz, 64K, 2 Serial, Parallel, CP/M) • 2 Thinline B" drives, 2MByte • 6 atol mainframe, 12" x 18" x 10" high • Add any standard video terminal and printer  
COMPUTER \$1955  
Mainframe only \$450

## CABLES

Kaypro cable—printer	5ft	\$35
Osborne printer, parallel	5ft	\$35
Osborne serial, modem	5ft	\$35
TRS-80 Mod I/III	printer	\$35
TRS-80 Mod II	printer	\$35

Also see Apple, IBM, Atari, Commodore

## FOR OSBORNE

Corvus 6MB hard disk	\$1975
<b>OSMOS 1—double density mod</b>	\$175
OSMOS 2—370K drives	compatible with software \$855
OSMOS 3—750K drives	\$999
<b>OSMOS 4—Disk Format/Convert</b>	read/write 20 formats \$215
<b>OSMOS 5—80 Column</b>	select 52/80 display \$235
OSMOS 6—Drive Diagnostics	\$29

## CAT-A-LIST

### Brilliant IBM Software

#### System requirements:

#### 128K RAM/2—320KByte drives

• Software interface between Wordstar, Easywriter-II, Powertext, Spellbinder, Volkswriter, or Superwriter—and—Epson, Okidata, C Itoh, Diablo, NEC, IDS, and most popular printers. • Database features maintain, sort and select from files • Mail merge features for custom letters.

Manual (refundable with purchase) \$25  
Cat-a-List with manual list \$200 \$185

SEND A STAMPED/ADDRESSED ENVELOPE TO RECEIVE A COMPLETE DATA SHEET

Verify prices by phone. Add 2% for Visa or Mastercard. Add 6% on California orders. Orders prepaid with check, cashiers check, money order or wire transfer are shipped prepaid within the Continental U.S. COD's require 10% non-refundable deposit (re-stocking fee).

# IRONSIDES COMPUTER CORP



**Customer Service—  
Product Selection Advice  
(213) 344-3563  
ORDERS (800) 528-9537  
18905 Sherman Way  
Reseda, CA 91355**

Visit our new, enlarged showroom.



# CALL "THE COMPUTER-LINE" In Colorado.

"Committed to bringing computers within the reach of all Americans"™

The Computer-Line believes that it is important to be competitive by offering low prices; however, we regard service as the most important aspect of a mail-order organization. All our lines are available so that you, the customer, are able to talk to fully qualified computer specialists trained to answer all your questions pertaining to our microcomputers. We are renowned for our excellent after-sales support and our promptness for delivery. Peace of mind and excellence in service is our pledge to our customers.

## PRODUCTS for the IBM® PERSONAL COMPUTER

### The Ultimate IBM® Peripheral MONTE CARLO™ CARD

Five Functions — Memory/Serial/Parallel/Clock/Joystick

- Up to 1 Megabyte Expandable Memory
- One IBM Compatible Centronics Parallel Port
- One IBM Compatible Asynchronous Communication Port
- Clock/Calendar (Battery-backed) with Alarm
- Dual Port Joystick Interface
- Future Upgrade Options: Direct Connect Modem

..... \$CALL

### And The Sensational I-C — MAGIC

Prom Chip

Programmable Graphics Screen Dump

Print Spooling up to 64K

Terminal Emulation..... \$CALL



### Hard Disk System for the IBM® Personal Computer

The Davong System's Hard Disk Drive fits conveniently inside or outside of the second floppy disk drive location of the IBM® Personal Computer chassis, providing more than 30 times the capacity of a floppy diskette, plus greater speed & reliability.

Available for internal or external installation. Please specify ..... \$CALL



## SOFTWARE

Ashton-Tate:  
D. Base II..... \$475.00

Continental:  
Home Accountant Plus ..... \$99.00

The Business Manager™  
A complete accounting/word  
processing/spread sheet/hard disk  
system for your IBM PC ..... \$CALL

MicroPro  
Wordstar..... \$329.00  
Mailmerge ..... \$159.00

Sorclm Software:  
Supercalc..... \$199.00  
Superwriter..... \$299.00  
Spellguard..... \$149.00

Lifetree Systems:  
Volkswriter..... \$149.00

Visicorp:  
256K Visicalc..... \$185.00  
Visidex..... \$185.00

Peachtree  
Peachpak..... \$CALL

## QUADRAM CORPORATION

Quadboard: The memory board for the IBM featuring:

- Fully Expandable from 64K - 256K
- Parallel Port
- Asynchronous (RS232) Serial Port
- Clock/Calendar
- RAM Disk Drive ..... \$CALL

Microlazer:

- Buffering from 8K - 64K (4 - 32 pages of text)
- Printer & Computer Independent
- Parallel/Parallel, Parallel/Serial; Serial/Serial available
- Compute while you print! ..... \$CALL

## Peripherals for all Computers

### PRINTERS

TEC / C-ITOH Printers  
Prowriter I Parallel..... \$379<sup>00</sup>  
Prowriter I Parallel/Serial..... \$499<sup>00</sup>  
Prowriter II Parallel..... \$649<sup>00</sup>  
Prowriter II Parallel/Serial..... \$699<sup>00</sup>

F10 Printmaster 55 CPS ..... \$CALL

Okidata

Microline 92: 160 CPS bidirectional with 40 CPS  
correspondence. 80 column..... \$575<sup>00</sup>

Microline 93: 160 CPS bidirectional with 40 CPS  
correspondence. 132 column..... \$995<sup>00</sup>

Pacemark 2350: 350 CPS bidirectional/2 color  
printing/136 column.  
Parallel..... \$2195<sup>00</sup>  
Serial..... \$2295<sup>00</sup>

Pacemark 2410: 350 CPS bidirectional/2 color  
printing/85 CPS correspondence.  
Parallel..... \$2485<sup>00</sup>  
Serial..... \$2585<sup>00</sup>

ICALL FOR PRICES ON ALL OKIDATA PRINTERS!

Star Micronics  
Gemini 10 & 15..... Price Is Too Low To Publish!

IDS Prism  
132 Color..... \$1495<sup>00</sup>

Smith Corona  
TP-I Parallel or Serial..... \$569<sup>00</sup>

Call for prices on Epson's New FX Series



F10 Starwriter Letter Quality  
40 CPS Printer, Diablo Standard Daisywheel  
\$1195<sup>00</sup>

### DISKETTES

\*\*Kangaroo:

The disks with the 'jump' on the competition  
Outstanding value with library case and a  
ten year warranty

5 1/4" SS/DD (Box of 10)..... \$19<sup>95</sup>  
5 1/4" DS/DD (Box of 10)..... \$28<sup>95</sup>

Verbatim Diskettes

5 1/4" SS/DD (Box of 10)..... \$23<sup>95</sup>  
5 1/4" DS/DD (Box of 10)..... \$43<sup>95</sup>

Elephant Diskettes

5 1/4" SS/DD (Box of 10)..... \$22<sup>95</sup>  
5 1/4" DS/DD (Box of 10)..... \$29<sup>95</sup>

### Monitors

Amdek Color I..... \$299<sup>00</sup>  
Color II..... \$699<sup>00</sup>  
300G Green..... \$199<sup>00</sup>  
300A Amber..... \$199<sup>00</sup>  
310G Green..... \$179<sup>00</sup>  
310A Amber..... \$179<sup>00</sup>

BMC 15MHZ Green..... \$899<sup>00</sup>  
20MHZ Green..... \$1499<sup>00</sup>

NEC 1201 Green..... \$199<sup>00</sup>  
1212 Color Composite..... \$299<sup>00</sup>  
1203 RGB Hi-Res Color..... \$699<sup>00</sup>

Zenith ZVM-121 15MHZ..... \$199<sup>00</sup>  
Taxan Amber..... \$149<sup>00</sup>

### MODEMS

D.C. Hayes:  
Micromodem II (Apple)  
w/ Terminal Program..... \$299<sup>00</sup>  
Micromodem II (Apple)  
w/o Terminal Program..... \$299<sup>00</sup>  
Smartmodem 300 Baud..... \$299<sup>00</sup>  
Smartmodem 1200 Baud..... \$599<sup>00</sup>

Novation:  
J-Cal RS232 Direct Connect..... \$199<sup>00</sup>  
Cat..... \$149<sup>00</sup>  
Smart Cat 1200 Baud..... \$499<sup>00</sup>  
Appletac II (Apple)..... \$299<sup>00</sup>

ALL BRANDS ARE REGISTERED TRADEMARKS



### Apple IIe®

Provides these standard features:

- Typewriter-style, full ASCII keyboard, upper and lower case, and auto-repeat feature
- 6502A microprocessor (8-bit CPU)
- 64K bytes RAM memory
- 16K bytes ROM, which includes built-in Apple-soft BASIC language



- color graphics and sound capabilities
- seven I/O expansion slots
- back panel designed for quick connect/disconnect, using D-style connectors

.....SCALL

Special  
PRINCETON  
GRAPHICS  
SYSTEMS

- 690 Dots Hor.
- 16 Colors
- Non-Glare Screen
- Color at its finest

\*\*\*\*\* SCALL

RAM  
SPECIAL  
4164 Dynamic Ram  
200NS .....\$5.00 ea.  
U.S. made by Texas Instruments. We can supply the quantity & price Dealers & Mail need. Call or write for volume pricing

TANDON  
DRIVE  
Special  
Double Side/  
Double Density  
320K Bytes  
of Storage.  
TM-100-2  
\$249<sup>00</sup>

### Columbia Data Products Personal Computer



Featuring:

- IBM PC Compatibility
- 16-Bit 8088 Processor
- 8 Expansion Slots
- Two RS232 Serial Ports
- Centronics Printer Port
- Double Density Floppy Disk Controller
- 128K RAM Standard Memory

CALL FOR PRICING AND INFORMATION ON THE EXTENSIVE SOFTWARE STANDARD WITH THE COMPUTER!

TANDON  
Thin-Line  
TM-55  
\$245<sup>00</sup>

ZENITH Z100 COMPUTERS  
Z110-22 (Low Profile) .....\$3099<sup>00</sup>  
Z120-22 (All in one) .....\$3175<sup>00</sup>

WORD PROCESSING SPECIALS  
On Line Screenwriter \$85 Pro \$149  
Silicon Valley Word Handler \$119

### IBM® Personal Computer

Features:

- 64K Memory
- 2 Tandon TM-100-2 320K Byte Drives
- 1 floppy disk controller
- 1 color graphics card
- SlimLine drives and hard disk drives configurations are available upon request.



Call for pricing on all IBM® Systems.



### NEC's APC™

Offers:

- 128K or 256K bytes of user memory
- monochrome and color displays
- two-million bytes of floppy disk storage
- 5¼" hard disk
- hi-res symbol and line drawing graphics
- user-definable character set
- user-definable function keys
- CP/M-86™ operating system



.....SCALL

### Franklin Ace 1000

Offers:

- 64K Memory
- 40 column upper/lower case display
- Apple IIe compatibility
- more space between expansion slots and internal fan aid cooling

.....SCALL

Call for prices on Franklin Ace 1200!

For 24-Hour/7 Days a Week Ordering & Product Information, Call "Info-Line™", our computer modem line. 1-303-279-4218. Operates at 300 Baud, Full Duplex

## Products for the APPLE COMPUTER

We are smashing  
the prices on  
Apple Compatible  
Disk Drives!



- FOURTH DIMENSION Drives  
Plus a box of Kangaroo Diskettes .....\$289<sup>00</sup>
- FOURTH DIMENSION Drive with Controller  
Plus a box of Kangaroo Diskettes .....\$379<sup>00</sup>

We also carry:

- |             |              |            |
|-------------|--------------|------------|
| Microsci A2 | Rana Elite I | .....SCALL |
| A35         | Elite II     |            |
| A 40        | Elite III    |            |
| Generic     |              |            |

COMPUTER-LINE is Now Open  
7 DAYS A WEEK!!  
Product Information & Ordering Lines  
Mon. - Fri., 7 a.m. to 8 p.m.  
Sat. & Sun., 8 a.m. to 6 p.m.  
(Mountain Standard Time)

### MBI APPLETIME CARD

Works with DB Master and Visidex Mountain Computer mode  
Basic and pascal operation complete with datebook software .....\$ 89<sup>00</sup>

### MBI VIP CARD (Half Height Drives)

Dual Port Parallel/Serail Graphics Card.....\$129<sup>00</sup>  
Use ASCII Express The Professional 4.0 to simultaneously transfer data from modem to printer using the VIP Card.

ASCII EXPRESS (The Professional) .....\$99<sup>00</sup>

### APPLE SOFTWARE

- |                         |                            |
|-------------------------|----------------------------|
| Continental:            |                            |
| The Home Accountant     | .....\$ 54 <sup>00</sup>   |
| Silicon Valley Systems: |                            |
| Word Handler            | .....\$119 <sup>00</sup>   |
| List Handler            | .....\$ 59 <sup>00</sup>   |
| Stoneware:              |                            |
| DB Master               | .....\$159 <sup>00</sup>   |
| DB Utility 1, 2, 3      | .....\$69 <sup>00</sup> ea |
| Visicorp:               |                            |
| Visicalc 3.3            | .....\$185 <sup>00</sup>   |
| Visifiles               | .....\$185 <sup>00</sup>   |
| Visidex                 | .....\$185 <sup>00</sup>   |
| Visitrend/Plot          | .....\$229 <sup>00</sup>   |

### RAM CARDS

- |                         |                          |
|-------------------------|--------------------------|
| Microsoft 16K           | .....\$79 <sup>00</sup>  |
| CP/M FOR APPLE          |                          |
| Microsoft Z80 Card      | .....\$269 <sup>00</sup> |
| Advanced Logic          | .....SCALL               |
| Kensington System Saver | .....\$69 <sup>00</sup>  |
| T & G:                  |                          |
| Joysticks               | .....\$44 <sup>00</sup>  |
| Select A Port           | .....\$44 <sup>00</sup>  |
| Game Paddles            | .....\$29 <sup>00</sup>  |
| Kraft:                  |                          |
| Joysticks               | .....\$49 <sup>00</sup>  |
| Game Paddles            | .....\$33 <sup>00</sup>  |
| 80 Column Cards         |                          |
| Videx with Softswitch   | .....\$279 <sup>00</sup> |

Write or Call for Our Comprehensive Catalog.

## Call "THE COMPUTER-LINE"

Product Information & Order Lines: (303) 279-2848 or (800) 525-7877 "Computer-Line" Stores opening throughout the U.S.

Customer Service & Order Inquiries Line: (303) 278-8321

ORDER DEPARTMENT: COMPUTER-LINE, Inc. • 1019 8th Street • Golden, CO 80401  
COMPUTER-LINE of Denver • 1136 So. Colorado Blvd. • Denver, CO 80222

Write for our Franchise Package.

TERMS: All prices reflect a 2% cash discount. All goods acknowledged faulty on receipt by the customer will be repaired or replaced at our discretion. Customers must call for a RMA number before returning any goods. This facilitates our quick attention to faulty goods. We reserve the right to repair or return to the manufacturer for repair all goods becoming faulty within the specified warranty period. Any goods (hardware or software) returned for reshipping are subject to a 15% reshipping fee at our discretion. The charge for cancellation of orders is 20% at our discretion. NO returns on software. We accept no responsibility for any sales taxes made by manufacturers. Prices quoted for stock on hand and subject to change without notice. Specials in APO and international deliveries. Please add 2% (minimum \$3.00) for shipping APO and add to all prices 5% for shipping (minimum \$5.00). Please allow 10 working days plus mail time (if an order is mailed) in for receipt of all UPS delivered goods. All goods (other than APO or international) delivered UPS ground.

ALL BRANDS ARE REGISTERED TRADEMARKS



## MC68000 STATUS REGISTER

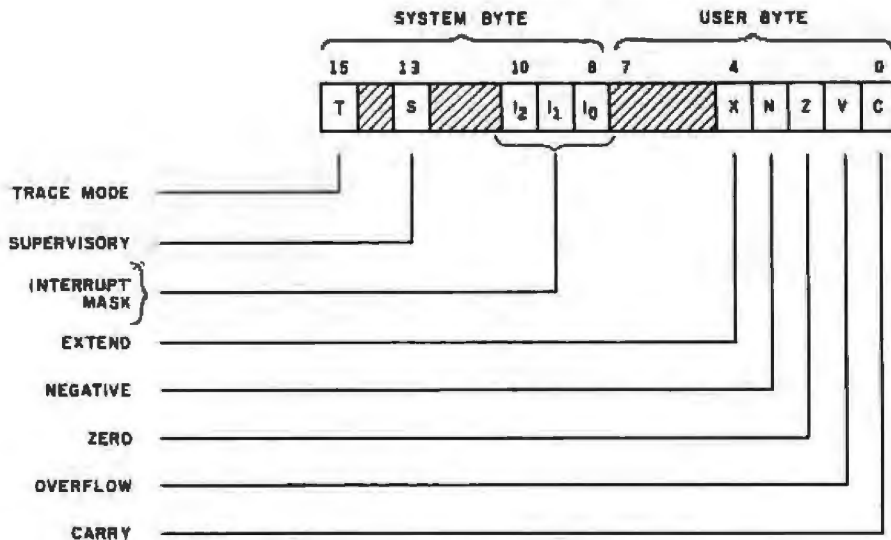


Figure 3: The bits of the MC68000 status register (SR).

amount (in this scheme, the bits 000 indicate an operand value of 8, not 0). Then, not only can you quickly and easily change an address pointer by 1, 2, or 4 for 8-, 16-, or 32-bit data, but you can also change counters by 3, 5, 6, 7, or 8. And the effect is identical to that using the standard ADDI instruction—even the status register codes are all the same.

Some odds and ends of arithmetic instructions include sign-extend (EXT), clear (CLR), and test (TST) instructions. Since three different sizes of data can be used in the MC68000, there should be a convenient way of changing size. If you want to move only part of a datum (for example, the bottom 16 bits of a 32-bit register), you need only use a MOVE instruction of the proper data size. If, however, you want to convert a datum to a larger-sized two's-complement value (for example, making a 16-bit value into a 32-bit expression), you need a special instruction. The EXT instruction will take an 8-bit or a 16-bit datum and duplicate its uppermost bit position through the higher portions of any data register in order to convert the datum to 16 or 32 bits wide, respectively. CLR simply loads a set of 0s into the destination. TST sets the negative and zero condition bits (discussed in the next section) according to the nature of the given operand.

### Status Register Codes and Multiple-Precision Arithmetic

What if you are dealing with binary integers that require more than 32 bits for expression? Say you want to add two 128-bit (16-byte) numbers. If both of these numbers were in the MC68000 registers, all eight data registers would be in use. More likely, the two values would be in 16 consecutive bytes of memory, starting with the most significant byte of data. The normal procedure to add two such numbers is to add the two least significant bytes, remember the carry, go to the previous bytes and add them, remember the carry, and so on. This sequence of operations is handled neatly in the MC68000 by the predecrement address-register deferred mode, which uses the notation  $-(An)$ . Use two address registers to point to the byte just past each operand. Each execution of an  $ADDX -(Am), -(An)$  instruction will decrement the values in the Am and An registers (m and n stand for numbers between 0 and 7), then add the two numbers pointed to by those registers. By putting this single instruction in a loop, you can quickly create the code needed to operate on multiple-precision numbers.

Let's detour for a second to discuss the status register of the M68000 (see figure 3). It contains the standard carry (C), overflow (V), zero (Z), and

negative (N) bits found in other microprocessors. It also has a status-register bit not found on other microprocessors, the X (or extend) bit. This bit was created to eliminate confusion caused by traditional overuse of the carry bit.

To explain the extend bit, I should describe the carry bit. In most microprocessors, the carry bit is overused. It is changed by (among other things) an addition instruction, but it is used in two different ways. Sometimes it is used in a later addition, such as in multiple-precision additions; sometimes a program tests the bit and branches according to the carry bit's state. So programmers use the carry bit for two different purposes: for extended-precision arithmetic and for program control.

The MC68000 has a bit for each purpose. Both the carry and the extend bits are changed according to the results of an addition instruction. However, the carry bit is used by the microprocessor during testing for program control purposes, while the extend bit is used as an input for multiple-precision arithmetic operations. For ADD, SUB, NEG, and specified shift and rotate instructions, both the carry and extend bits are updated. Other instructions—MOVE, AND, OR, TST, CLR, MUL, and DIV—change only the carry bit. This design helps prevent inadvertent changes to either bit.

Because of the extend bit, the familiar "add with carry" operation in the MC68000 becomes ADDX or "add with extend bit." Look at why this is important. Once you start a multiple-precision arithmetic operation and get a partial result, the integrity of the extend bit will be maintained even if you have to suspend the addition to do some data movement with the MOVE instruction. Programming becomes easier because you don't have to save the status register codes when interrupting a multiple-precision operation.

I should mention one other thing about multiple-precision arithmetic. When you have finished the multiple-precision operation, what does the negative bit mean? It correctly indicates that the result was positive or

REGENCY WALK COMPANY

STATEMENT OF EXPENSES FOR YEAR

CATEGORY	PLAN	ACTUAL
SALES	40,000	31,000
COST OF GOODS	25,000	25,000
NET SALES	15,000	6,000
ADMINISTRATION	4,000	4,000
ADVERTISING	3,000	4,000
RESEARCH	1,000	3,000
TOTAL EXPENSE	17,000	18,000

# HIGH TECHNOLOGY REQUIRES HIGH PERFORMANCE ACCESSORIES

In the fast moving, high technology world of microcomputers, the need for high performance accessories often gets overlooked.

Discwasher, recognized as a world leader in audio/video care accessories, understands this need and has developed a line of computer accessories to allow users to get the most from their computer hardware.

The easy-to-use *Discwasher™ Disk Drive Cleaner* is both a problem preventer and problem solver. Its dry format safely cleans single or double-sided drives without altering the delicate head alignment or doing possible damage to rubber drive parts with solvents.

The *Discwasher™ Computer Cassette Drive CareSet™* is a total maintenance package for your cassette drive system. It includes both the *Discwasher™ Computer Cassette Drive Head Cleaner* and the *Computer Cassette Drive Mechanism Cleaner*. Together, these two maintenance units can keep the high resolution heads and the critical drive system of your cassette drive system in optimum performance.

The *Discwasher™ DiscKeeper™* is a magnetically shielded storage system for floppy disks that takes up no more space than conventional folder packs. *DiscKeeper* protects against stray magnetic fields which can destroy valuable software. Three *DiscKeeper* sizes provide loss-free storage and protection for transporting any size disk format.



# discwasher

1407 NORTH PROVIDENCE ROAD, P.O. BOX 6021, DEPT. BY, COLUMBIA, MO 65205 USA

A DIVISION OF JENSEN an ESMARK Company



## Data Organization and Addressing Modes

Motorola designed the MC68000 to offer a versatile set of data sizes and addressing modes for the assembly-language programmer. To understand fully the power of this machine, you must first understand how the MC68000 organizes and moves data.

Although the MC68000 "sees" its memory space as a collection of 8-bit bytes, it works on several different data sizes. It can address memory in the following sizes: byte (8 bits), word (16 bits), and long word (32 bits). In addition, it can manipulate individual bits—a bit is specified by the byte it is

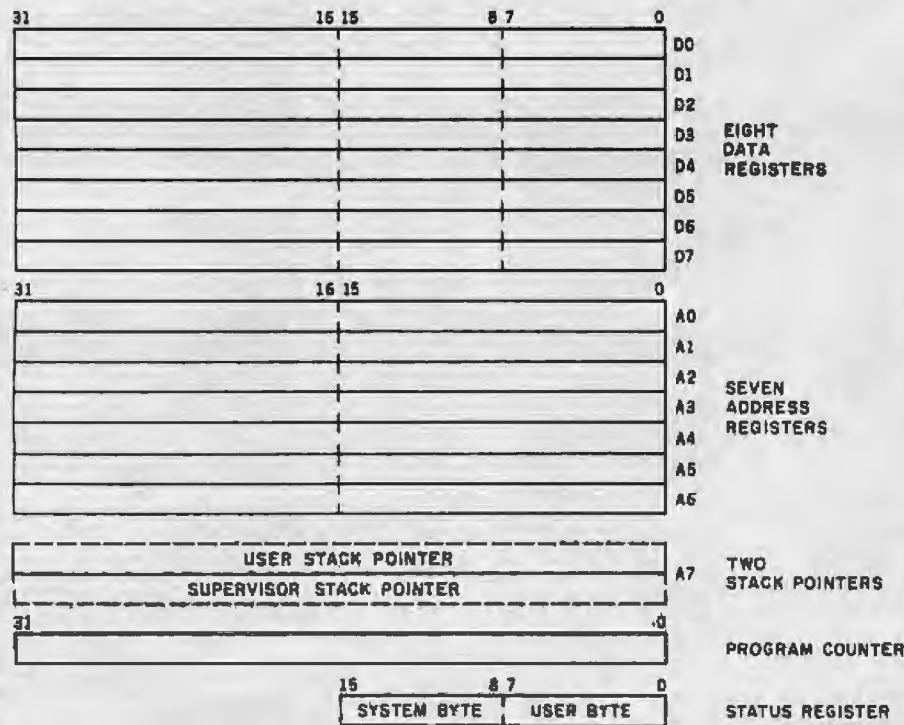
in and its bit number (between 0 and 7) within the byte.

The MC68000 has a definite preference for addressing 16- and 32-bit quantities that start at even addresses. In particular, it was designed to access quickly 16-bit quantities that start on an even address. Even though this speed comes at the expense of words and long words that begin at odd addresses (which would take two, not one, fetch operations to be accessed), this is not a serious disadvantage. MC68000 op codes are always 16 bits wide, and any arguments the MC68000

requires are always stored as one or more 16-bit words (even if the argument is only a byte quantity). Because of this, code that starts on an even-byte boundary will stay on an even-byte boundary and thus will be accessed at the fastest rate possible.

The MC68000 register set (see the figure) indicates the microprocessor's commitment to long-word data: even though this is a 16-bit machine, all the internal registers are 32 bits wide. The dotted lines in the data registers denote those registers' ability to handle 8-, 16-, or 32-bit-wide data. The address registers can handle either 16- or 32-bit-wide data.

The MC68000 supports six major addressing modes; although I will not go into the variations available in each mode, a short description of each will show you the basic ways the microprocessor can get its operands.



- **Inherent addressing:** the instruction itself tells the microprocessor where to get its operand. An example of this is RTS, return from subroutine, which gets the return address from the stack.

- **Register addressing:** the operand is a data or address register. An example is MOVE D1,D2, which moves the contents of data register D1 to data register D2.

- **Immediate addressing:** the operand is specified as part of the instruction. An example is MOVE #3,D2, which moves the value 3 into data register D2.

- **Absolute addressing:** the operand is specified by a 16- or 32-bit address that is appended to the instruction. An example is MOVE \$3F01,D2, which

negative. In most microprocessors, though, the zero bit indicates only that the most significant portion of the result is 0, not that the entire result is 0. The multiple-precision arithmetic instructions in the MC68000 are designed so that the zero bit will accurately depict the status of the entire result. This is done by allowing multiple-precision instructions to reset the zero bit (denoting a nonzero result) but not to set it

(denoting a zero result). With this scheme, the programmer's only responsibility is to set the zero bit before beginning the multiple-precision operation.

One final issue can come up in the middle of arithmetic operations, and the MC68000's handling of the problem illustrates another fundamental difference between it and so many other microprocessors. How many times have you interrupted a series of

arithmetic operations to modify some memory pointers and later discovered that your completed arithmetic operation gave a wrong result because you inadvertently modified certain status register code bits? When you get right down to it, when you add 12 to a memory address, who cares if a carry was generated or if the result was negative? In fact, the negative bit has no meaning in relation to addresses. We as programmers are hurt

moves the contents of the word at address 3F01 hexadecimal into data register D2. This is also called direct addressing because the operand address is being directly supplied.

• Register-deferred addressing: this mode has a lot of variations. Since these modes get rather complicated, I'll speak of them in terms of what the effective address is—that is, what memory location will be used to supply the source or destination operand. The simple address-register deferred mode makes not the register but the contents of the register the effective address. Because the register contents is itself the address of the given operand, this addressing mode is often called indirect addressing—the register indirectly supplies the effective address. Suppose that register A1 contains the value 100 and that the word at address 100 contains 12D hexadecimal. Then the instruction MOVE (A1),D2 will put the value 12D hexadecimal into data register D2. The notation "(An)" denotes address-register-deferred (or indirect) addressing using data register An.

Two related variations on address register deferred are called address-register deferred with predecrement and address-register deferred with postincrement; they have notations of "(An)" and "(An)+", respectively. In the predecrement variation, the address register An is decremented before its contents is used as the effective address; in the postincrement variation, the contents of the address register is used as the effective address, then the register is incremented. These modes are often used in loops for repetitive

operations on sequential areas of memory; they usually replace an explicit increment or decrement instruction, thus providing more compact, faster code. The incremental or decremental amount will be 1, 2, or 4 depending on whether the operand is a byte, word, or long word.

Another variation is called address-register deferred with displacement: in this mode (denoted "d16(An)"), the effective address is the contents of address register An plus the signed 16-bit value d16. Suppose address register A1 contains the value C100 hexadecimal and the word at address C25E hexadecimal contains 0. Then the instruction MOVE \$15E(A1),D2 moves the value 0 into data register D2. (The effective address, C25E hexadecimal, is the sum of the displacement 15E hexadecimal and the contents of register A1, C100 hexadecimal.)

The variation called address-register deferred with index and displacement (denoted "d8(An,Xn)") limits the displacement to an 8-bit signed number but makes the effective address the sum of three numbers: the displacement, the contents of the address register An, and the contents of an index register Xn, where the index register can be any of the address or data registers. The extra register is added into the effective address calculation to allow the same instruction to point to the base of a table (using d8 and An) and, during execution, to refer to different nearby memory locations by putting different values into the index register Xn. The word "index" in the addressing mode name refers to the commonplace use of the index register

to index into an array of numbers stored sequentially; in such a case, the value in the index register equals the subscript of the array element desired. Given the example directly above (register A1 contains C100 hexadecimal, word C25E hexadecimal contains 0) and the information that data register D6 contains is the value 100 hexadecimal, the instruction MOVE \$5E(A1,D6),D2 moves the same value (0) to data register D2 just as the instruction MOVE \$15E(A1),D2 would. In both cases, the effective address is C25E hexadecimal.

• Program-counter relative addressing: this mode has two variations, "d16(PC)" and "d8(PC,Xn)"; these are similar to the two forms of address-register deferred addressing described above. It is different in two ways: first, it uses the program counter (PC) instead of an address register; second, you cannot use this mode to specify a destination operand. The main advantage of this mode is that it allows you to write position-independent code. Because the program counter contains the address of the next instruction after the one currently executing, its use allows the current instruction to refer to data (or program locations for branches) relative to the instruction itself. The MC68000 designers included the restriction against using this mode for a destination operand to protect a program with errors from inadvertently destroying itself. In addition, this restriction prevents programmers from writing self-modifying code, a dangerous practice that programmers occasionally try to increase program performance.

by the senseless changing of status register code bits when address-related operations are run. Why don't we leave these bits alone when changing memory addresses?

As you can imagine, the designers of the MC68000 have addressed this problem. One of the primary distinctions between the data and address registers in the MC68000 is that instructions with an address register as the destination do not modify the

status register code bits. They are not changed by moving a new pointer value into an address register, incrementing or decrementing an address register, or by adding any value to an address register. This means that you should never run into a problem with memory-pointer modifications affecting your ongoing data arithmetic operations.

Another interesting note is that all operations to any address register af-

fect the entire address register. Because all MC68000 addresses are 32 bits wide, any operations with an address register as destination must perform in a way that keeps the result valid as a 32-bit address. One solution, to require all inputs to address-register operations to be full 32-bit quantities, would be wasteful of memory space. So either word (16-bit) or long-word (32-bit) operations may take place in any of the ad-



Instruction	Operation
ADD.B D6,D2 ADD.L 52(A1,D7.W),D6	adds the lower 8 bits of D6 to D2 (takes 4 clock cycles) the effective address is the sum of the constant 52, the contents of register A1, and the lower 16 bits of register D7; the long word at the effective address is added to the contents of register D6 (20 clock cycles)
ADD.W D3,(A7)	adds the lower 16 bits of D3 to the element on top of stack pointed to by A7 (12 clock cycles)
ADDI.L #5400,D1 ADDI.B #5A9,\$30B(A6)	adds 400 hexadecimal to the 32-bit contents of D1 (16 clock cycles) the effective destination address is the sum of the 30B hexadecimal and the contents of register A6; A9 hexadecimal is added to the byte at the effective address (20 clock cycles)
ADDA.W -(A5),A2	decrement register A5 by 2, then add the word pointed to by register A5 to register A2 (14 clock cycles)
ADDA.W #100,A5 ADDQ.W #1,(A4)+	add the value 100 to the contents of register A5 (12 clock cycles) add 1 to the word pointed to by register A4, then increment register A4 by 2 (12 clock cycles)
ADDQ.B #3,D7 ADDX.L -(A2),-(A5)	add 3 to the contents of register D7 (4 clock cycles) after decrementing both registers A2 and A5 by 4, add together the X bit and the two long words pointed to by A2 and A5 (30 clock cycles)

Table 3: Examples of MC68000 addition instructions. The clock times given are worst-case times for the instruction.

dress registers A0 through A7. If a word operation is performed, the 16-bit quantity is first sign-extended to 32 bits before it is used.

### Processor Speed

How fast does the MC68000 execute instructions? Because of the consistency of the microprocessor, the answer for addition instructions will serve as a guide for all arithmetic and logic instructions. A prefetching mechanism in the MC68000 keeps decoded instructions waiting to be executed. So while the timing information given refers only to the time it takes to pass through the adder, recall that the prefetcher will have fetched the next op code while the current op code is being executed.

The minimum time it takes the MC68000 microprocessor to access memory (to read or write) is 4 clock cycles. With a clock frequency of 8 MHz (the frequency used in the standard MC68000 microprocessor), this bus cycle will take 500 ns (nanoseconds). (All subsequent timings will be given in clock cycles, which is a meaningful measurement for all the MC68000-family microprocessors, regardless of the speed of their system clocks—8, 10, or 12.5 MHz.) Every instruction will take at least 4 clock cycles to complete because this is the time it takes to fetch the next op code.

The MC68000 has only one 16-bit

arithmetic and logic unit (ALU) for data operations. Therefore, 8- or 16-bit operations can be performed in a single pass through this unit; this takes 4 clock cycles. A 32-bit operation will require a second pass. Memory-addressing modes increase the time needed for an operation because the microprocessor requires more time to calculate the addresses, and a bus cycle is required for each 16 bits of addressing information or actual data that needs to be transferred. An indexed addressing mode, or anything with a displacement, for instance, will require 1 additional bus cycle for the address extension word and another to get the data (2 if the data is a long word); add about 8 more clock cycles (12 if the data is a long word) to the execution time of a given instruction that uses this mode. Some sample worst-case clock timings for various addition instructions are given in table 3.

Like the ADD instruction, other MC68000 arithmetic instructions come in several forms. The subtract instructions have forms analogous to the add instructions—SUB, SUBA, SUBI, SUBQ, and SUBX. Instructions for compare operations that are all similar (CMP, CMPA, CMPI) perform the subtractions without storing a result (the net effect is to set the appropriate status register bits). A memory-compare instruction

(CMPM) allows two strings of binary integers in memory to be compared by sequencing through them to higher memory. Two versions of the single-operand negate instruction, NEG and NEGX, ignore and include, respectively, the state of the X bit.

### Multiplication and Division

Two versions of multiply and divide instructions make fast work of more complex arithmetic. The two versions are unsigned (MULU and DIVU) and signed (MULS and DIVS) instructions; these versions interpret their operands as one's-complement and two's-complement numbers, respectively. All of these instructions can include immediate values as the multiplier or divisor so that variables can be operated on by constants.

The multiply instructions take two 16-bit operands (one from any memory location by any addressing mode or any data register, and the other from the lower 16 bits of any data register), multiply them, and place the resulting product into the full 32 bits of the same data register. The divide instructions take the dividend from any 32-bit data register and divide it by a 16-bit divisor, which may come from memory using any addressing mode or any data register. The quotient is placed in the lower 16 bits of the same 32-bit data register, while the 16-bit remainder is placed in

# stair war



AN ASTRONOMICAL VALUE AND  
*THE LOWEST PRICES*  
*IN THE GALAXY ON*

stair   
PRINTERS

CALL: (303) 279-2848 or (800) 525-7877



THE COMPUTER LINE, INC.

GOLDEN, COLORADO

Offer void outside the Milky Way



# The clever gift for computer lovers

**HIGH-TECH,  
MINI-SIZED  
COMPUTER  
TERMINAL**



**It's a bank!  
It's a planter!  
It's a personal caddy!**

Made of high quality molded plastic, measuring 4½" x 6" x 4¼", and available in assorted colors, each CompuGift has a clear acrylic screen which holds your favorite photo. The **Computer Caddy** stores pens, pencils, rulers and note pads. The **Computer Planter** looks great anywhere, and the **Computer Bank** provides an interesting place for loose change.



**Attractive  
gift item**



Only \$9.99 each plus \$2 each for shipping (\$6 maximum). (For Canada, Hawaii and Alaska, double shipping charges).

Colors available in  
a. Beige b. Dark Grey c. Yellow d. Magenta

Item	Color & Quantity			
	a	b	c	d
Computer Caddy				
Computer Bank				
Computer Planter				

Subtotal	
Tax (CA res.)	
Shipping	
Total	

Name \_\_\_\_\_  
 Address \_\_\_\_\_  
 City \_\_\_\_\_  
 State \_\_\_\_\_ Zip \_\_\_\_\_

Custom imprinting/inquire quantity discount

**CompuGift, Inc.**

27802 Perlees St. Dept. 0201  
 Mission Viejo, CA 92692  
 (714) 768-8223

Satisfaction Guaranteed

Listing 1: A short MC68000 assembly-language routine to multiply two 32-bit numbers.

**Input** register D0 contains 32-bit multiplicand  
 register D1 contains 32-bit multiplier

**Output** registers D0 and D1 contain the 64-bit result, with the most significant byte in D0

```

SUBU    #4,A7           initialise product area
CLR L   -(A7)
MOVE L  D0,-(A7)       save copy of multiplicand

MULU   D1,D0           multiply low-order parts
MOVE L  D0,8(A7)

MOVE W  (A7),D0        high-order multiplicand
MULU   D1,D0           times low-order multiplier
ADD L   D0,6(A7)

SWAP   D1              now use high-order multiplier
MOVE W 2(A7),D0        low-order multiplicand
MULU   D1,D0           times high-order multiplier
ADD L   D0,6(A7)

BCC    MUL32A          carry into high-order
ADDQ W  #1,4(A7)       word of product

MUL32A MOVE L  (A7)+,D0 high-order multiplicand
        SWAP  D0
        MULU  D1,D0     times high-order multiplier
        ADD L (A7)+,D0
        ADDU  #4,A7
        MOVE L (A7)+,D1 load low-order product
    
```

the upper 16 bits of the same register.

The divide instruction has two characteristics that may be undesirable and so are specially handled. All of us remember from high school and college that there just isn't any good way to divide by zero. The result is infinite if it's defined at all. Well, Motorola's designers didn't think they knew any better than the mathematicians, so if a zero divisor is detected, the divide instructions do not execute, and a special "trap" procedure is entered. Since the trap operation will be covered in part 3 of this article, let's just say that a "zero-divide trap" specially calls the operating system to decide what to do.

The other thing that could happen is that the divisor could be just too small for the dividend and the quotient could require more than 16 bits in which to be expressed. When this overflow condition is detected, the division is halted, the overflow (V) status register code bit is set, and the instruction is concluded without overwriting either of the original operands. Thus, following any divide instruction, you should check the overflow bit and act accordingly.

For a number of reasons, there are no instructions to multiply two 32-bit numbers or to divide a 64-bit number by a 32-bit number. First, the need for such instructions is very infrequent in most applications. Second, there are no other facilities in the machine to handle 64-bit quantities. Finally, because such instructions would take a lot of time to execute, the MC68000 would occasionally take much longer to respond to an interrupt—a situation the designers did not want to create.

The multiply instructions take fewer than 70 clock cycles to execute using register operands, and the divide instructions require fewer than 140 clock cycles for an unsigned operation (158 cycles for a signed operation); however, different combinations of 1s and 0s in the operands can make these operations take less than these times to execute. A short MC68000 routine that performs a 32-bit by 32-bit multiplication is shown in listing 1. It executes in about 60 microseconds, which is less time than that taken by the dedicated instruction that does the same thing in the Z8000.

Text continued on page 363

# On The Surface, All Diskettes Seem Alike.

DYSAN TESTS THE ENTIRE SURFACE

RECORD BAND .012"

GUARD BAND .008"

RECORD BAND .012"

## But They're Not.

Most diskette manufacturers claim that they 100% surface test their diskettes—and they do. But only on the tracks.

Dysan goes a bit further and tests not only on but between the tracks. By 100% testing both on-and-between-tracks, Dysan certifies that both the primary track and the guard band areas on every diskette are 100% bit error-free, totally void of missing or extra pulse. That can make quite a bit of difference in your system's performance. Temperature and humidity distortions or slight head misalignments won't cause the user to write on untested areas. That means fewer errors, greater data integrity, and more confidence with every keystroke.

### Background:

Magnetic tracks on the surface of the diskette are twelve thousandths of an inch (.012) in width and are separated on both sides by erased guard bands eight thousandths of an inch (.008) in width to protect the flux change information on the tracks.

### Other Benefits:

Dysan diskettes also incorporate a proprietary DY<sup>10</sup>™ lubricant which guards against signal loss caused by surface abrasion and resonance. Advanced burnishing techniques are used to flatten microscopic surface peaks. This provides optimum head-to-disc interface. On top of that an exclusive "hands-off" auto load certification system allows Dysan to test each and every diskette and eliminates any possibility of handling errors prior to packaging and shipment.

These superior product characteristics protect your true investment in a floppy diskette. The actual cost of a diskette is not just the purchase price, but the purchase price *plus* the time you spend to fully load the disc. That's a big investment. And that's why Dysan goes a bit further to make diskettes which are the finest that money can buy.



You can select from a complete line of premium 8" and 5 1/4" diskettes, single or double density, certified on one side or both sides, soft or hard sectored.

DY<sup>10</sup> is a trademark of Dysan Corporation.

**dy** **Dysan**  
CORPORATION

Corporate Headquarters:  
5201 Patrick Henry Drive  
Santa Clara, CA 95050  
(800) 551-9000

# One

First in a Series

100%  
Surface Testing



# QUADBOARD™

## 256K Memory Expansion

Expandable in 64K increments, Quadboard™ is socketed for 256K bytes of memory. Full parity and checking standard.

## Qspool™

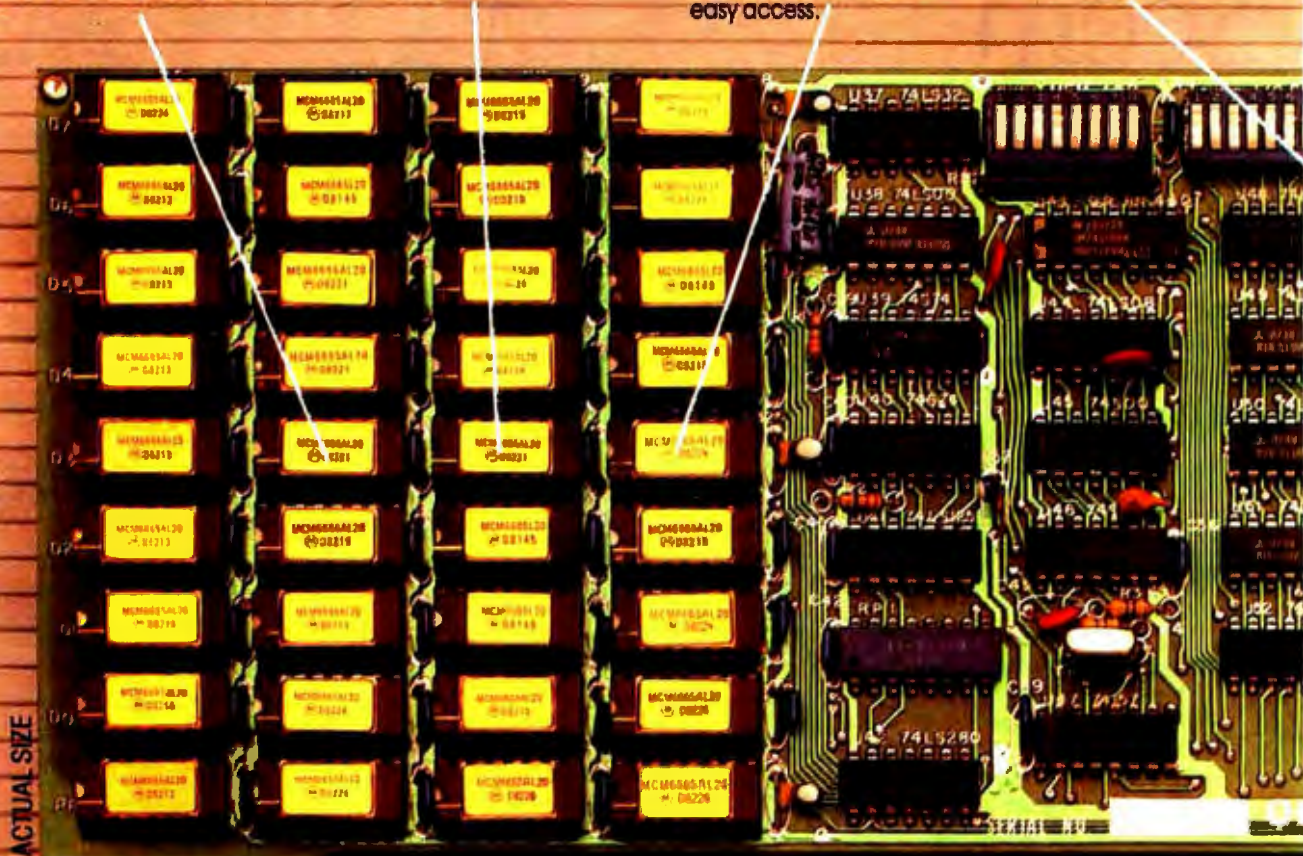
With Qspool, you can also use part of system memory as a software print buffer. Choose from 8K to 56K of memory and stop waiting for your printer.

## QuadRAM Drive™

This software program lets you use part of your total system memory as multiple disk drives. Super-fast drives that let you store important information for easy access.

## Chronograph

Quadboard features a real time chronograph to always keep your system's clock/calendar up-to-date. Even when your system's been off for months.



## THE FIRST AND ONLY BOARD YOUR IBM PC MAY EVER NEED.

Your IBM Personal Computer is very versatile. New functions and applications are being developed for it everyday. And now with Quadram's Quadboard, you can keep your PC options open for tomorrow's technology. In the tradition of Quadram Quality, six of the most needed PC functions have been com-

bined into one package, using only one expansion slot. Your remaining IBM slots are left free for future expansion needs.

## All-On-One-Board and Software, too.

Every board you may ever need for your IBM PC is in the Quadboard package. From serial port to print buffer. Plus, there's Quad-Master software, too. Included on this disk are utilities for ac-

curately setting the Quadboard's chronograph for time and date, and for performing diagnostics on all Quadboard functions. There's





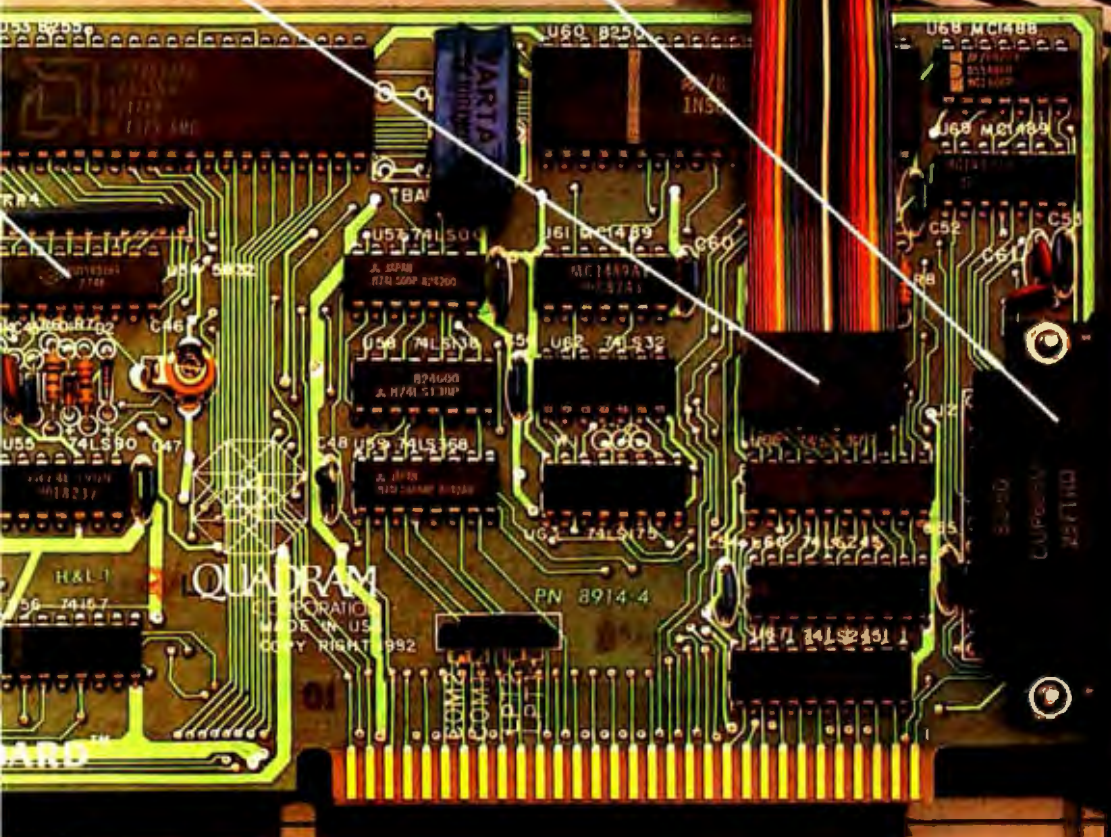
# BY QUADRAM™

## Parallel Port

There's a parallel I/O designed to operate most printers and parallel devices.

## Serial Port

Used for connecting modems, printers, and other serial devices, Quadboard's serial adapter can be configured as COM1 or COM2 and fully supports IBM PC communications software.



also Qswap™, the feature that lets you switch line printers one and two, back and forth, as your printing needs change.

## Proven Design

Quadboard is the number one IBM PC option board on the market today. Nothing even comes close, because Quadboard is designed with performance in mind. Engineered for dependability and built with only the finest components available. Each board has been thoroughly tested and "burned-in" for years of reliable service.

## INCREDIBLE PRICE, ASK YOUR DEALER.

Our full line of IBM PC accessories: Quadboard II, Quad 512+, Quadcolor, Quadchrome, Quadscreen, Quadjet, Quadmodem, Memory Board, Serial Board (Single or Dual ports), Parallel Board, Chronograph, and Microfazer.



All products are sold through local personal computer dealers. If yours does not stock Quadram, please ask him to call us at (404) 923-6666.

**QUADRAM**  
CORPORATION  
A Division of Intelligent Systems

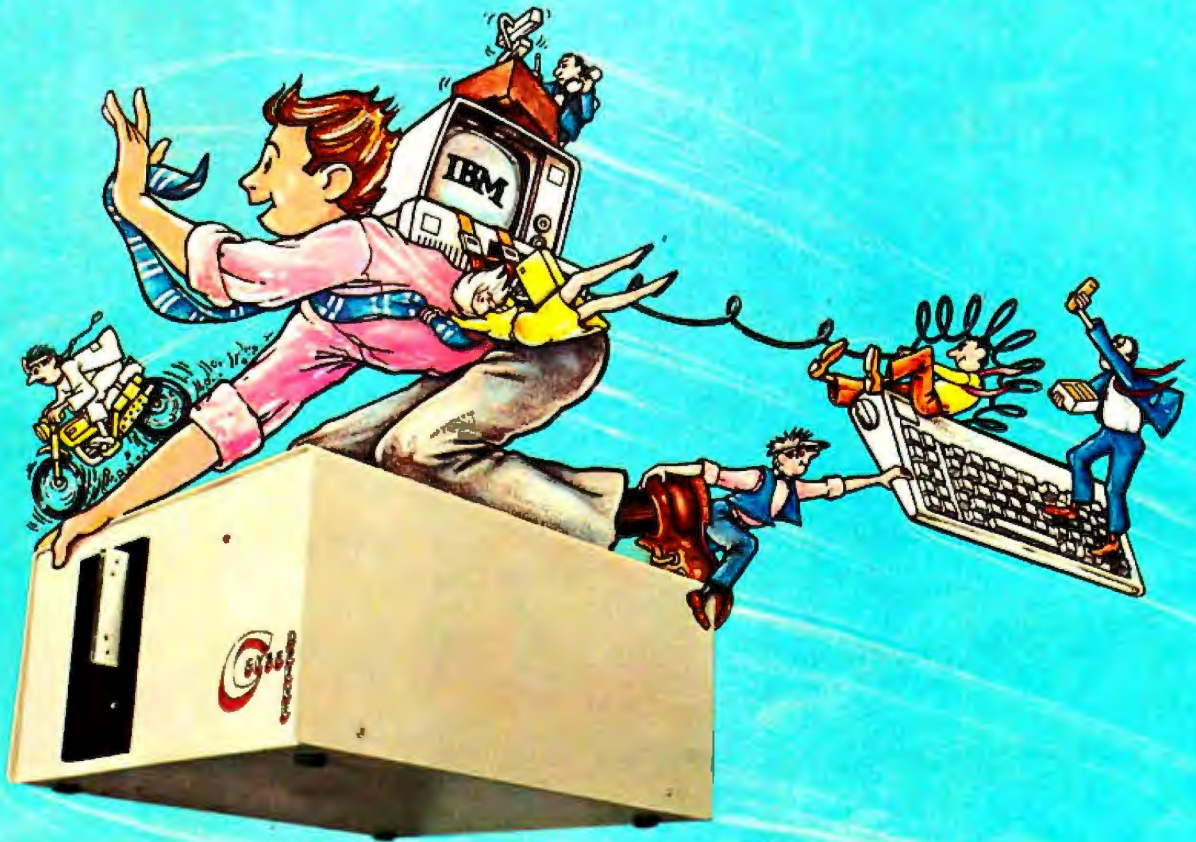


4357 Park Drive / Norcross, Ga. 30083 / (404) 923-6666  
TWX 810-766-4915 (QUADRAM NCBS)

Circle 385 on Inquiry card.



# Performance Breakthrough...



## ... the **CYBERDRIVE™** for the **IBM Personal Computer**

13.5 or 27 million bytes of disk capacity in a single cabinet with an integrated mini-cartridge tape for secure data backup.

Setting an exciting new microcomputer standard, the **CYBERDRIVE** combines a full package of features.

It offers new, higher performance levels, with an integrated business-oriented backup device.

As the **CYBERDRIVE** is made available for other systems, media transfer is assured regardless of the host hardware or Operating System.

The **CYBERDRIVE** slashes the seek time dramatically—e.g. the usual 5 Megabyte stepper-motor Winchester disk offers average seek time typically in the range of 100 to 200 milliseconds (incl. head settling).

With the **CYBERDRIVE**, the average seek time across more than five times as much data is only 33 milliseconds (incl. head settling).

This basic speed, coupled with disk cache buffering and a peak transfer rate of 1 million bytes per second, make the **CYBERDRIVE** a performance champ!

The integrated mini-cartridge tapes used for backup of data allow dumping of (for example) 10 million bytes of data in about 10 minutes... much faster than other tape or floppy disk backup techniques. Hardware read-after-write error checking is incorporated in the tape device.

... And don't fall to ask about our superb lineup of serious business software (also offered in **CYBERDRIVE** format) including:

**RM/COBOL<sup>2</sup>** compiler—the micro industry standard.

**MBSI<sup>3</sup> RM/COBOL** general business applications (derived from **MCBA<sup>4</sup>** minicomputer packages)... thousands in use... money back guarantee... source program license.

**CRTI<sup>5</sup>** from Cybernetics (**COBOL Reprogramming Tool!**)—Program generator for **RM/COBOL** to ease program development and maintenance... an alternative to a Data Base System.

**CBASIC<sup>6</sup> & CBASIC86<sup>6</sup>** compilers... for aficionados of a useful BASIC.

The software is available on a variety of industry-standard Operating Systems including **CP/M<sup>7</sup>-MP/M<sup>7</sup>** (both -80 & -86), **OASIS<sup>8</sup>**, **PCDOS**, and **UNIX<sup>7</sup>**. Inquire for specific details and prices.

Trademarks of:

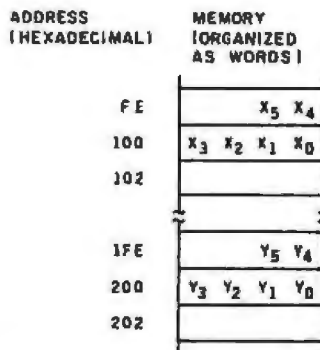
1 Cybernetics, Inc. 2 Ryan-McFarland Corp. 3 Micro Business Software, Inc.  
4 Mini-Computer Business Applications, Inc. 5 Digital Research, Inc. 6 Phase One Systems, Inc. 7 Bell Laboratories

**CYBERNETICS**  
IN  
CA

8041 NEWMAN AVE., SUITE 208  
HUNTINGTON BEACH, CA 92647  
714/848-1922



X<sub>BCD</sub> = X<sub>5</sub> X<sub>4</sub> X<sub>3</sub> X<sub>2</sub> X<sub>1</sub> X<sub>0</sub>  
 Y<sub>BCD</sub> = Y<sub>5</sub> Y<sub>4</sub> Y<sub>3</sub> Y<sub>2</sub> Y<sub>1</sub> Y<sub>0</sub>



CODE TO ADD X<sub>BCD</sub> TO Y<sub>BCD</sub>

```

MOVE L #102, A1    LOAD ADDRESS JUST PAST X IN A1
MOVE L #202, A2    LOAD ADDRESS JUST PAST Y IN A2
SUB   D1, D1       CLEAR X STATUS BIT AND SET Z STATUS BIT
ABCD  -(A1), -(A2) BCD ADDITION OF BOTTOM TWO DIGITS
ABCD  -(A1), -(A2) BCD ADDITION OF MIDDLE TWO DIGITS
ABCD  -(A1), -(A2) BCD ADDITION OF TOP TWO DIGITS
  
```

Figure 4: An example of multiple-precision binary-coded decimal (BCD) arithmetic. Because the predecrement addressing mode used ("ABCD-(A1), -(A2)") decrements the register pointers before performing the BCD addition, registers A1 and A2 must be loaded with a value that points to the byte immediately after the least significant byte of the number to be worked on.

## Binary-Coded Decimal Arithmetic

The final type of arithmetic instructions handles decimal digits. The most common form of human-interface data comes as *binary-coded decimal* or BCD data. This method of encoding numeric information as a string of bits stores each decimal digit of the number as a 4-bit binary number. Numbers are easily encoded into BCD form; once inside the computer, they are easily printable in human-readable form (much more so than numbers encoded in signed floating-point binary form). Because the BCD format is so useful, most microprocessors include instructions that operate on BCD numbers. To allow these BCD types of data to be manipulated, the MC68000 has three instructions that add (ABCD), subtract (SBCD), and negate (NBCD) packed digits. Each of these instructions works on two BCD digits packed into a byte.

Because BCD numbers may be many digits wide, the BCD instructions work as multiple-precision operations, which means they have the characteristics of the other multiple-precision instructions. The operands can be in data registers or in memory (in which case, they are

operated on using the predecrement addressing mode). The value of the X status register code bit is included in the BCD operations, and the Z status register bit is handled so that it properly reflects the state of the entire result, not just the final portion.

Once again, the best thing about these instructions is the simplicity with which they operate, especially when compared with the often mysterious code a programmer had to write to do BCD arithmetic on most older microprocessors. A glance at MC68000 code performing BCD functions (see figure 4) shows how simple such code is. Here, two 6-digit numbers need to be added. While a short loop might make the routine more generally useful, inline code is fastest and illustrates the point best. First, we must load the two address registers to be used as memory pointers with the correct values. The next instruction (SUB D1,D1) is a quick way of both setting the Z bit and clearing the X bit, though a MOVE #04,CCR would do virtually the same thing.

The three ABCD (add binary-coded-decimal) instructions begin at the least significant two digits and move toward the most significant;

## VOICE SYNTHESIZER Vocabulary Development System

Create custom vocabularies for TI-5220  
or GI SP-250 Speech Synthesizers

INCLUDES HARDWARE AND SOFTWARE FOR:

- DMA Voice Digitizing and Playback
- Parameter extraction and coding
- Screen Oriented Parameter Editor
- Voice Synthesis

USE YOUR S-100 SYSTEM, OR BUY OUR  
INTEGRATED SYSTEM BASED ON ZENITH Z-100

The Zenith Z-100 includes 8085/88 dual processor, 128K memory, two 5 1/4, 320K-byte drives, both CP/M80 and MS DOS and bit-mapped graphics, with CRT and keyboard in a convenient desktop model.

VPP-696: PC cards, software and documentation - \$3900

VPP-696Z: Includes VP-696 fully integrated to Z-100 with all cabling, software and documentation - \$6850

MULTIBUS VERSION FOR INTEL MDS AVAILABLE SOON

adisa corporation

APPLIED DIGITAL SIGNAL ANALYSIS  
P.O. Box 1364 Palo Alto, CA 94301 (415) 326-7303

Circle 522 on inquiry card.

## TELEVIDEO DEALERS & DIST.

Our general accounting programs operate on CP/M<sup>1</sup> & MP/M<sup>2</sup> compatible systems, including TurboDos<sup>3</sup> and MMMost<sup>4</sup>.

1. C.A.T.S. (3 levels of user help - Computer Assisted Tutorial Software).
2. OUTSTANDING DOCUMENTATION.
3. MULTI-USER (w/file & record lock).
4. MULTI-COMPANY (w/consolidation).
5. FULLY INTEGRATED w/single source entry (or stand alone).

### MONEY BACK GUARANTEE

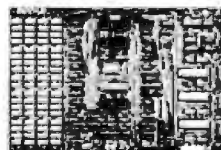
COUGAR MOUNTAIN SOFTWARE

10 S. Latah Box 6846  
Boise, Idaho 83707  
208-344-2540

TM 1 & 2: Digital Research, 3: Software 2000, 4: TeleVideo

Circle 139 on inquiry card.

## The Mega Super Computer



Free Computer with a Purchase of a RAM Disk

• 2808 Running at 5MHz, • Versatile CPU, • Math chip 9511 or 7512 AMD, • 80 Pin Ports on Mega Expansion BUS, • CTC, DMA, • 2 Parallel Ports—with hand shaking, • Serial Port—open or without hand shaking runs 150 to 1192 Baud from word terminals, printers, and modems.

• HIGH CPU 3.0  
• Hard Disk Interface hooks directly to Prim Drives  
• Floppy Disk Controller—Handles Single Density IBM compatible disks and Dual Density 1 or 2 sided supports, 8" or 5 1/4" in various combinations—3 Drives equal over 4 Mega Bytes of Storage WD7797

• 512k Bytes of RAM Drives with parity reorganizable as a HIGH SPEED ELECTRONIC DISK of 8 Banks of 64K for multitudes of countless other applications.

• All this on a state-of-the-art 4 layer card—with accurate documentation—10" x 15"

• Prices, Base Based with Documentation: ..... \$399  
40K Base System A & F ..... \$395  
512K Base System A & F ..... \$1593  
CPU 2.2 System A & F ..... \$125  
512K Base Kit ..... \$1299  
Manual ..... \$75  
Mega ..... \$325

MEGA CO.

2710 S. Park Street Modesto, CA 95213 (530) 255-7400

Circle 534 on inquiry card.



Status Register Instruction	Register						Status Register Codes		
							C	X	V
ASR.B #3,D3	(D3 before)	10111010	01011111	01100101	10101100		x	x	x
	(D3 after)	10111010	01011111	01100101	11110101	(12 clock cycles)	1	1	0
ASL.L #5,D1	(D1 before)	11101100	10100010	11011101	00101111		x	x	x
	(D1 after)	10010100	01011011	10100101	11100000	(18 clock cycles)	1	1	1
LSL.W D5,D7	(D5 before)	00101000	10001100	11101001	00101001		x	x	x
	(D7 before)	10111010	01011111	01100101	00010101		x	x	x
	(D7 after)	10111010	01011111	00101010	00000000	(24 clock cycles)	0	0	0
ROLL D2,D1	(D2 before)	01100101	00101010	10111110	01110100		x	x	x
	(D1 before)	10010101	00101000	01000101	10010100		x	x	x
	(D1 after)	01011001	01001001	01010010	10000100	(48 clock cycles)	0	x	0
ROXR.W #4,D6	(D6 before)	10111010	01011111	01100101	00010101		x	P	x
	(D6 after)	10111010	01011111	10110110	01010001	(14 clock cycles)	0	0	0
ROR \$A0000	(word A0000 before)		10011100	10101001			x	x	x
	(word A0000 after)		11001110	01010100			1	x	0

Notes:

1. An "x" status-register bit may represent either a 0 or 1 value.
2. Notice that in the LSL.W and ROLL examples the bottom six bits of the source operand (D5 and D2, respectively) are used as the number of bits to be shifted or rotated.
3. The "P" status-register bit in the "ROXR.W #4,D6" example is specially marked to show that it is shifted into the body of the D6 register as a result of the ROXR.W instruction. Note that .W causes only the bottom 16 bits of the register to be rotated.

Table 4: Examples of shift and rotate instructions and their effect on registers and memory.

this must be done to get accurate results from use of the extend bit. The result replaces the BCD number pointed to by A2; when the routine has finished, A2 points to the first byte of the BCD result (which is stored in order of most to least significant digit). Similar subtraction and negation operations can be built in the same way.

### Logic Instructions

The MC68000 logic instructions are simple but powerful. The AND, OR, exclusive-or (EOR), and NOT instructions, like the arithmetic instructions, allow 8-, 16-, and 32-bit quantities in data registers or in memory to be operated on with any data register or an immediate constant, or to be inverted. These instructions are just as fast as the arithmetic instructions. Additionally, ANDI, ORI, and EORI instructions are used to clear, set, and toggle individual status register code bits.

A serial shifter in the MC68000 can be moved any number of bits to allow for shifting of 8-, 16-, and 32-bit data. The arithmetic-shift-right instruction (ASR) shifts the least significant bit to

the X and C status bits while duplicating the most significant bit before moving it to the right. In the arithmetic shift left (ASL), the logical shift right (LSR), and the logical shift left (LSL), the bit shifted out of the data area goes into the X and C bits, while the bit into which no bit is being shifted is filled with a 0.

The rotate instructions shift bits around in a circular manner so that bits shifted out of one end of an operand are shifted in the other end, with the bit being shifted out of the data area also being copied into the C status register code bit and, optionally, the X bit. The rotate instructions are rotate right and rotate left (ROR and ROL); the ROXR and ROXL instructions are used when you want to update both the X and C bits.

One single shift or rotate instruction can move register data as many as 31 bit positions in the selected direction. You can specify this count value either statically (as a value between 1 and 8 encoded into the instruction op code) when the instruction is written or dynamically (as a value between 0 and 63 stored in a specified data register) when the in-

struction is executed. For simplicity, memory operands to be shifted or rotated are limited to displacements of 1 bit and operations on word-sized data only. Table 4 illustrates some shift and rotate instructions, their timing, and their effects.

An important aspect of programming that until the MC68000 was quite limited is that of individual bit manipulation, the ability to single out bits of memory, test them, set them, and clear them. Such operations are useful; in I/O, for instance, you frequently need to sense the state of a single input line, drive a particular output line high, or turn a servo-mechanism off. These operations involve only a single bit associated with a latch, peripheral, or memory location.

In the past, most of us have done the best we could by executing AND, OR, and EOR instructions to the desired location. But the difficulty with these operations is their crudeness. Sure, they allow us to change more than 1 bit at a time, but it turns out that much more secure code can be written when single events or conditions affect single outputs. Also,

**YOU  
CAN MAKE  
A FORTUNE  
IN MICROS!**

# THE MICRO COMPUTER BUSINESS WILL GROW FROM \$10 TO \$100 BILLION IN THE NEXT EIGHT YEARS! ARE YOU READY TO CASH IN?

The micro computer business is predicted to grow from its present \$10 billion to \$100 billion before 1990! Imagine the possibilities this opens for you! No matter where you live, if you're starting up or presently in business, no other industry offers you more opportunities!

Now, finally, all the inside information you need to secure a prosperous future in this dynamic industry is available in one place - **THE COMPUTER ENTREPRENEUR MANUAL!** - An immense information source, compiled by our inquisitive research team, aided by a panel of experts and business people from all areas of the computer industry!

We present the inside story of more than 100 lucrative computer businesses you can enter, where you'll find the real opportunities for the eighties: from one man operations like Programming Author, Word Processing Center or Consulting, to Systems House, Service Bureau, Computer Store etc! Many at little or no investment! All the invaluable facts and figures: How to start, Capital needs, Profit estimates and Margins, How to Sell and Market, How missing technical or business experience need not stand in your way, Source of Suppliers, etc! Details that could take years to find out on your own!

We'll show you inside tricks, like how to never again pay retail for computer products and consumer electronics, even for one item - right now, while you're starting your business! How to get free merchandise and trade show invitations, etc. This alone will more than pay for the manual! You'll read actual case histories of other computer entrepreneurs, so you can learn from their mistakes, and profit from their success stories! Where you'll be one year from now depends on your actions today! Let us show you how to take the first crucial steps!

Order now and take advantage of our limited introduction special, **THE COMPUTER ENTREPRENEUR MANUAL**, and a six month subscription to **THE COMPUTER ENTREPRENEUR REPORT/NEWSLETTER** (so you're always up-to-date with the industry), both for only \$29.95! You must be convinced on how easy you can strike it rich in the micro computer business - or you may return the manual for a full refund within thirty days! **USE OUR TOLL FREE NUMBER TO ORDER!**

## EVERYTHING YOU NEED TO KNOW TO SUCCEED IN THE COMPUTER BUSINESS IS ALL IN THIS MANUAL!

**THE COMPUTER ENTREPRENEUR MANUAL** has the answers to all your questions about selecting, starting and successfully running a computer business! There has never been such a comprehensive collection of know-how and information about this business in one place! All the facts you need to plan and achieve your goals in easy-to-follow, step-by-step instructions!

These are some of the 100-plus businesses covered in **PART ONE** of the manual with the facts on How to start and run, Start-up Cost (Even how to operate on a shoestring), What profits to expect, Wholesale prices, Mark-ups, Suppliers, future outlook, case histories for each, etc:

Systems House, Software Author (who to sell to and who to avoid), Service Bureau, Software Publisher (How to find programs that sell), Word Processing Service, Consulting and Consultant Broker (use your skills or those of others - make \$150 - \$1000 a day!), The Incredible Games Business, Computer Store (Franchises: Pro and Contra, or a low inventory store in your home!), OEM, Hardware Mfg, Data base and Teletext Service (big prospect!), Used Computers, Repairs, Rent-A-Computer, Promote Fests and Trade Shows, Turnkey Systems.

Bartering, Mail Order, Compile and rent mailing lists, Specialized Data Headhunting and Temp Help Service, Tech Writer Shop, Custom Engineering, The highly profitable Seminars and Training Business, and many more!

Many new ideas and ground floor opportunities! Interviews and success stories on companies of all sizes! Privy info on the profits made: How some computer store operators net \$100 - \$250,000! Little known outfits that made their owners millionaires, one of these low-key companies making simple boards went from nil to \$20,000,000 and 100 employees in four years! Programmers that make \$300,000, Thousands of micro millionaires in the making etc!

Whatever your goal is - Silicon Valley Tycoon, or just a business at home - we guarantee you'll find a business to suit you - or your money back!

**PART TWO** of the manual is loaded with the know-how and "streetfighting" savvy you need, both as a novice or business veteran, to get started, to stay and to prosper in the micro computer business! A goldmine of information in clear and easy-to-use instructions: How to prepare your Business Plan, Outside financing, The mistakes you must avoid, How to hire and manage employees, Incorporation (when and how to do it cheaply), Surviving bad times, Record Keeping, how to estimate your market before you start, Use multiple locations to maximize profits, how to promote and stay steps ahead of the competition! How to get free advertising, free merchandise, free advice, Power negotiating with suppliers to double your profit margins, etc! Even how to keep a present job while starting a business part time!

Don't miss this opportunity to be part of this great industry - the next success story could be your own! Order the manual today! Part one and two bound in a deluxe ring binder, where you can also collect our newsletter (free for six months with the manual - a \$32.50 value!) - all for only \$29.95!



### THE COMPUTER ENTREPRENEUR NEWSLETTER - ALL THE LATEST INSIDE BUSINESS NEWS! NOW! SIX MONTHS FREE WITH YOUR MANUAL!

You're always attuned to the industry and your manual kept up-to-date, with our newsletter! Each issue has the latest business news, ideas, new suppliers, our indispensable "watchdog" column on profits, discounts (don't miss mtg's promos like recently when top video monitor sold at \$80 - that's half wholesale - one third of the retail price!), the competition, the big deals, etc! Feature stories with start-up info and case histories on new micro businesses!

You'll get invitations to trade shows and conventions the usage of our advisory service and our discount buying service for your purchases!

You'll find many items in our newsletter that will save you the cost of your manual many times over!



**CALL TOLL FREE!  
CHARGE IT!**  
Credit Card Orders  
(MC, VISA only)  
accepted 24 hours/day  
1-800-227-3800  
Ask for extension 1135  
In California call  
1-800-792-0980



Order by phone (Credit cards only), or use the coupon:

Mail to **THE COMPUTER ENTREPRENEUR PUBLISHING CO**  
PO BOX 458, Grand Central Station, New York, N.Y. 10163

Please send me **THE COMPUTER ENTREPRENEUR MANUAL**, and the six month free subscription to **THE COMPUTER ENTREPRENEUR REPORT/NEWSLETTER** All for only \$29.95, plus \$3 for postage/handling (NY residents, add \$2.64 for sales tax) If I decide not to keep the manual, I may return it within 30 days for a full refund.

NAME: \_\_\_\_\_

ADDRESS: \_\_\_\_\_

CITY, STATE, ZIP: \_\_\_\_\_

Check or M.O. enclosed Charge to  VISA  MC

CARD # \_\_\_\_\_

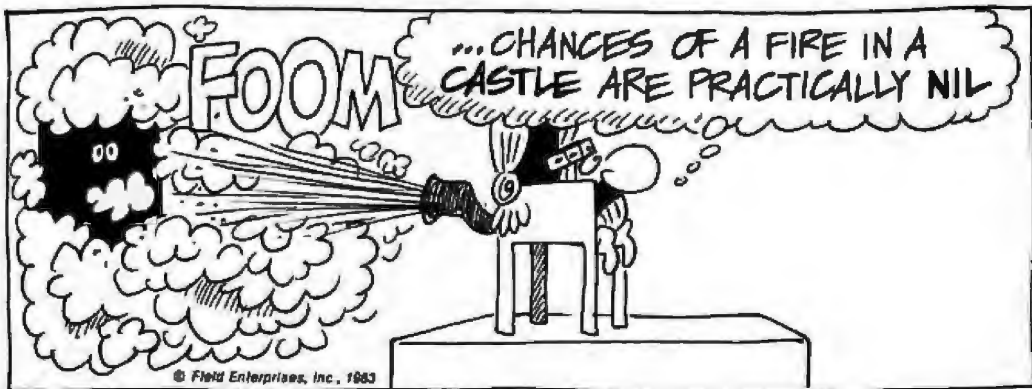
Exp. Date: \_\_\_\_\_

SIGNATURE: \_\_\_\_\_

B 0583



# Last year our fire protection systems kept the heat off a lot of business owners.



It's sheer wizardry the way Fenwal's suppression systems spot fire and snuff it out instantly. Our systems use the fastest way known of stopping fire, Halon 1301. It's perfectly clean and people-safe. That keeps downtime to an absolute minimum.

We've been building and perfecting our systems for more than 20 years. There are thousands installed around the world. Because Fenwal manufactures all its own major system components, you get a system with components built to work together and backed by single source responsibility.

Plus the attention of a *local* factory trained wizard who's knowledgeable in cost efficient system configuration.

Whatever you want to protect—valuable documents, computer rooms, communication centers, control rooms, switching rooms, anything at all that you can't afford to be without—we can do the job.

For the name of your local Fenwal wizard, look in the Yellow Pages under "Fire Protection," or contact the Castle at (617) 881-2000. Fenwal Incorporated, Ashland, MA 01721. A Division of Kidde, Inc.

## FENWAL®

because it is impossible to sense the state of more than one input at a time, nothing is gained by the ability of such instructions to work on multiple bits.

Four powerful MC68000 instructions make all bit-manipulation functions far simpler. They are the bit test (BTST), bit test and set (BSET), bit test and clear (BCLR), and bit test and change (BCHG) instructions. How will you specify the target bit? The MC68000 uses two methods, similar to those used for shift and rotate instructions. Either a data register or a series of bits in the bit-instruction op code names the bit to be affected; in this case, however, the bit number can be from 0 to 31 if a register is affected, or from 0 to 7 if the area affected is a memory location. (In the MC68000, bits in memory are identified by the bit number of the *byte* in which they reside.)

With true bit-manipulation instructions, not crude logic instructions, bit-manipulation operations—sensing the state of inputs, driving outputs, setting register bits, setting attribute

bits, transposing bit matrices, or just building special data types—are straightforward tasks, not the chores they usually are with other microprocessors. The MC68000 makes it very easy to specify precisely the bit to be changed.

### Conclusions

The computation and data-movement instructions that perform the major work in any MC68000 program are numerous, comprehensive, and, perhaps most important, straightforward and easy to use. The versatile MOVE instruction on the MC68000 replaces a confusing variety of data-movement instructions on other microprocessors. Flexible add, subtract, compare, negate, multiply, and divide instructions operate on any register, with constants, on stacks, and in memory using any addressing mode. For digital data rather than binary data, pairs of BCD numbers can be added, subtracted, and negated. The common logic operations of AND, OR, exclusive-or, and NOT can similarly operate on data

registers and constants, and in memory.

When data needs to be shifted about, it can be arithmetic-shifted, logic-shifted, or rotated left or right. It can also be shifted or rotated multiple bit positions, with the count of the movement either predetermined and constant, or variable and dependent upon other data.

Individual bits in data or I/O can be separately tested to determine their state; they can also be set, reset, or toggled. The bit to be worked on can be chosen either when the instruction is written or, based on other data, when it is run.

All the above instructions can operate on 8-, 16-, or 32-bit data, with a uniform yet flexible set of addressing modes. This combination of good instruction set design, computational power, and ease of use make the MC68000 microprocessor an excellent one for assembly-language programming. Next month, I'll discuss program-control instructions and several advanced instruction groups. ■



GRAPHICS-PLUS is a field installable enhancement board for the popular Zenith Z19 video terminal adding many powerful features found only on terminals costing much more. GRAPHICS-PLUS provides Tektronix<sup>2</sup> 4010 compatible vector drawing graphics, VT100<sup>3</sup> compatible 80 and 132 column display formats, off-screen scrolling memory, programmable function keys, "Plain English" menu-driven Set-up mode, and a host of other enhancements. Installation can be accomplished within 15 minutes using only a screwdriver.

## GRAPHICS-PLUS an enhancement For Z19 Terminals from Northwest Digital Systems

- Tektronix<sup>2</sup> 4010 Compatible Graphics
- 512 Horiz by 250 Vert Resolution
- 80/132 Col and 24/49 Line Text Displays
- Seven Page Off-Screen Text Memory
- Menu-driven "Plain English" Set-up Mode
- 16 Programmable Keys- 128 Chars Each
- Optional Hardcopy Port
- Simple Field Installation

1 TM Zenith  
2 TM Tektronix  
3 TM DEC

GP-19 Upgrade for Z-19 Terminal	\$ 849
Z-19 Terminal With GP-19 Installed	\$ 1495

Northwest Digital Systems

P.O. Box 15288, Seattle, WA 98115 (206) 362-6937



# Building a Hard-Disk Interface for an S-100 System

## Part 3: Software

*How to alter the CP/M operating system so that it will accommodate a Winchester disk drive and controller.*

---

Andrew C. Cruce and Scott A. Alexander  
ASC Associates Inc.  
POB 615  
Lexington Park, MD 20653

---

In part 1 of this series we described Winchester disk technology in general and the benefits it would provide for microcomputer systems. We then gave an overview of the work that would be required to add such a disk to an existing computer system. In part 2 we discussed the rationale you should use in choosing a particular Winchester disk drive and disk controller (we decided on a Miniscribe disk drive and a Xebec controller). We then described in detail the construction of the hardware interface—the host computer adapter—required to integrate the disk drive into the S-100 system. In this last article of the series we will describe the final ingredient needed for our Winchester disk-drive subsystem: the software.

First we'll review the operation of the CP/M basic disk operating system (BDOS) and basic input/output system (BIOS) software. Specifically

we will describe the process through which application programs use the BDOS to access disk file information and how the BDOS uses the BIOS to obtain specific information from a particular peripheral. This will highlight what has to be done to write a BIOS to handle the Winchester disk system.

Next we will describe the operation of the disk drive and controller as accessed through the host computer adapter (HCA). We'll show how disk commands are initiated from software and what commands are available from the disk controller. With this background out of the way, we will identify requirements for a Winchester disk-subsystem BIOS and how these requirements can be satisfied. We will then describe how a BIOS is structured and how the BIOS routines for the Winchester disk system can be included with the original system BIOS routines to support the other peripherals. Finally, we will briefly review the CP/M procedures required to include the combined BIOS in a new CP/M system.

This will essentially complete the integration process. However, we can improve system performance even further by putting the system's bootstrap routine on the Winchester disk. We'll describe how a bootstrap pro-

gram operates and how you can develop a new bootstrap and install it on the Winchester disk drive. We'll also spend some time discussing various debugging techniques that will probably be very helpful when you integrate the hardware and software.

### BDOS and BIOS

The CP/M operating system basically consists of two separate elements called the BDOS and the BIOS. The BDOS is supplied by Digital Research Inc. and is the essence of the CP/M operating system. In addition to the BDOS, however, the system requires a set of routines known as the BIOS to handle the hardware-peculiar functions of each peripheral in the system. These routines are usually supplied by the disk-drive manufacturer and must be modified by the user to include other system peripherals.

Accesses to disks and other peripherals by application programs are usually handled by calls to the BDOS. These calls are made by loading specified registers with information required by the BDOS and then performing a call to location 05. In the case of disk accesses you must load a function code into the C register and a pointer to the file control

---

### About the Authors

Andrew Cruce has a Ph.D. in Aeronautical Engineering and has recently received an S.M. degree in management as a Sloan Fellow at MIT. Scott Alexander has an M.S. in Electrical Engineering. Both have extensive design and implementation experience with small computers and are full partners in the firm of ASC Associates, which markets the hardware described in this series of articles.

---

# Free Genius In Every Box.

The people at **CompuPro** put a little genius into each system they make. For instance, some CPUs can babble in 8-bit lingo, some in 16-bit; **CompuPro's** brainchildren speak both - fluently.

Let *our* genius multiply *your* genius: When you need to stretch your mental powers, **CompuPro** systems are the cost-effective answer. And you don't have to be a genius to see that.

**System 816/A.** Single-user, expandable to multi-user. Includes dual processor, 128K bytes of static RAM (expandable to 1 megabyte), 4 serial ports, constant voltage power supply, CP/M® 2.2, CP/M-86™, M-Drive™, SuperCalc-86™ and dBase II™.

**System 816/B.** Ultra-high performance single-user, expandable to multi-user. Includes 256K bytes of static RAM, 6 serial ports, same software as System 816/A.

**System 816/C.** Multi-user, running 8- and 16-bit programs simultaneously. Includes 384K bytes of static RAM, 9 serial ports, same software as System 816/A.

**System 86/87.** Multi-user. Includes 512K bytes of 16-bit memory, 1.5 megabytes of M-Drive/H™, high performance dual processor, clock switching circuit for running slave boards, CP/M-86™, MP/M-86™, SuperCalc-86™ and SuperWriter™.

**System 68K.** Single-user, expandable to multi-user. Especially for FORTH fans, including 256K bytes of 16-bit memory, 1.5 megabytes of M-Drive/H™, CP/M-68K™, mapFORTH and C languages.

**System Oasis-8.** Multi-user. Includes 208K bytes of static RAM, 512K of M-Drive/H™, Oasis operating system.

**System Oasis-16.** Multi-user. Includes 10 MHz CPU 8086, 512K bytes of static RAM, 1.5 megabytes of M-Drive/H™, Oasis-16 operating system.

For the location of your nearest **Full Service CompuPro System Center**, call (415) 562-0638.

CP/M is a registered trademark and CP/M 86, CP/M-68K and MP/M 86 are trademarks of Digital Research. SuperCalc-86 and SuperWriter 86 are trademarks of Sorcim. dBase II is a trademark of Ashton-Tate. M-Drive/H is a trademark of CompuPro.



CompuPro, a Godbout company, Box 2355, Oakland Airport, CA 94614.



BYTE	DESCRIPTION
00	POINTER TO SELECTED DISK
01 : 08	FILE NAME
09 : 11	FILE TYPE
12	CURRENT EXTENT NUMBER OF FILE
13 14	RESERVED FOR SYSTEM USE
15	READ COUNT FOR EXTENT
16 : 32	DISK ALLOCATION INFORMATION
33 : 35	OPTIONAL RANDOM RECORD NUMBER FOR DIRECT-ACCESS INPUT/OUTPUT

Figure 1: A diagram of the file control block (FCB) format used by CP/M.

block (FCB) of the desired file into the DE register pair. With this information, the BDOS determines what functions are to be performed and calls appropriate entry points in the BIOS with the information required

to execute requested functions.

The BDOS disk functions are described in the standard CP/M documentation and include such functions as Open a File, Close a File, Read Next Record, and Write Next Record. The data structure that drives all these operations is the FCB, which is initially created by the application program and is updated by various BDOS functions. Figure 1 shows the structure of the FCB, which includes, among other things, the file name and file type along with 16 bytes of data that are used by CP/M in the calculation of a physical device address for access to the requested data. Additional data in the FCB is used to keep track of the drive the FCB is currently active on, a pointer to the current record, and a pointer to the current extent. If you are not familiar with the FCB construct, you can find additional information on it and the normal BDOS disk I/O functions in Digital Research's *CP/M Interface Guide*.

In order to understand the require-

ments for the Winchester disk BIOS, it is necessary to understand how this BIOS is used during the normal access of data from files contained on the Winchester disk. Figure 2 illustrates the steps that are performed in opening an existing disk file and reading the first 128 bytes of data from this file. This process is representative of the majority of the communications that occur between the BDOS and the BIOS during normal disk operations.

The process starts with the application program establishing which disk is to be active in the subsequent operations by loading the appropriate information in the C and E registers, as shown in the figure, and then calling the BDOS. The BDOS takes this information and passes it on to the BIOS, which then returns to the BDOS the address of a table that defines the physical characteristics of the disk that was selected. At this point, control is returned to the application program.

Next, the application program defines a DMA (direct memory access) buffer for subsequent disk operations by loading the DE register pair with the DMA buffer address, loading register C with 1A hexadecimal, and calling the BDOS. The BDOS in turn passes the DMA address to the BIOS for use in subsequent disk read/write operations.

After setting up the DMA buffer, the application program next opens the file that is to be read. First, the application program constructs an FCB for that file by reserving the required amount of space for the FCB, filling in the file-name and file-type portions of the FCB, and setting the Current Extent and Next Record fields to zero. The application program then calls the BDOS with the DE register pair pointing to the FCB and register C containing 0F hexadecimal. The BDOS must now search the file directory on the selected disk to determine if the file mentioned in the FCB is actually contained on the disk. In doing this the BDOS uses the BIOS to read each sector of the selected disk directory into memory and then searches for a match with the requested file name. When a match is found, the BDOS uses the information contained

## COMPUTER SCIENCE PRESS

### ESSENTIALS OF COBOL PROGRAMMING: A STRUCTURED APPROACH

Gerald N. Pitts and Barry L. Baleman

The COBOL language is presented in an easy-to-understand progression in this well-organized new book, providing a knowledge of the language and an understanding of how the various aspects of COBOL are interrelated. Questions at the end of each chapter make this an excellent choice for independent study. 1982. \$14.95. 0-914894-34-X.

### DESIGN OF COMPUTER DATA FILES

Owen Hanson

This excellent new book explains how to design files for optimum performance and minimum cost. Intended for students of programming, data processing, and systems analysis, or as a reference work for practicing designers, this book brings together all the latest information necessary for the design of computer data files. 1983. \$24.95. 0-914894-17-X.

### UNDERSTANDING COMPUTER SYSTEMS

Harold Lawson

Learning about computers can be enjoyable, as proved by this interesting new book by Harold Lawson. The author draws parallels between computing procedures and familiar everyday events to help the reader learn how computers work. A must for those who want to learn more about computer systems. 1982. \$11.95. 0-914894-31-5.

### WRITE FOR A FREE CATALOG

All prices are subject to change without notice. Postage and handling is \$1.50 for the first book, 50¢ for each additional book. Residents of Maryland add 5% sales tax.

### COMPUTER SCIENCE PRESS, INC.

11 Taft Court, Dept. BY583

Rockville, Maryland 20850

(301) 251-9050

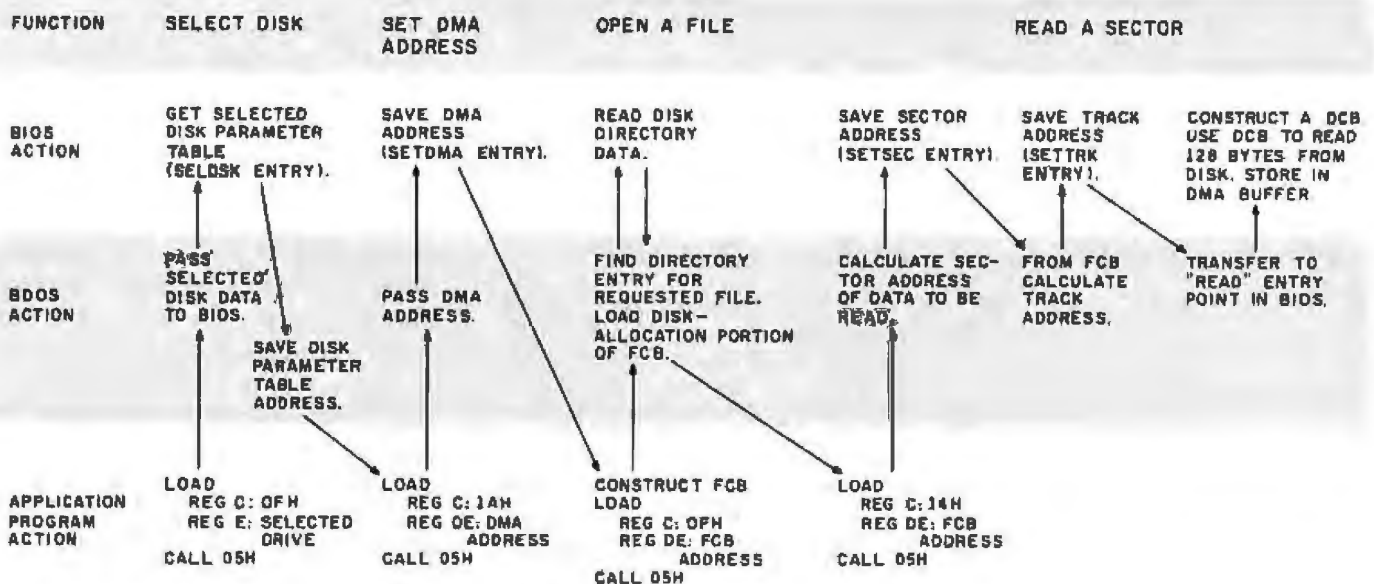


Figure 2: A diagram of the input/output process for the Winchester disk subsystem.

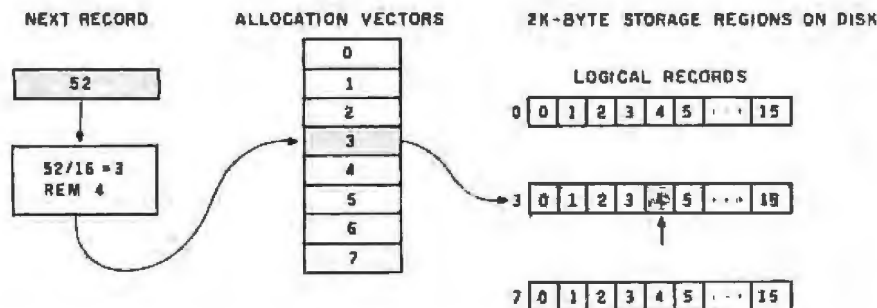


Figure 3: A diagram showing how the Winchester disk address is calculated. First, the value of the Next Record field is divided by 16. The resulting quotient points to one of eight allocation vectors, which in turn points to one of several 2K-byte regions on the disk. The remainder of the division points to one of the 16 logical records in each 2K-byte region.

in the directory entry to load the disk-allocation portion of the FCB. After filling in the required information in the FCB, the BDOS returns control to the application program.

The function of the disk-allocation portion of the FCB is to determine the physical disk address of particular records within a disk file. In the case of our Winchester disk system, the 16 bytes of disk-allocation information correspond to eight pointers, each containing 16 bits. These pointers refer to 2K-byte storage areas on the disk. Each of these 2K-byte storage areas is in turn made up of sixteen 128-byte logical sectors of disk information as required by CP/M. When a particular record is accessed, the

value in the Next Record field of the FCB is divided by 16 to determine which disk-allocation vector to use in the disk-address calculation, and the remainder from this division is used to determine which logical sector in the storage region is required. This process is shown in more detail in Figure 3. It should be noted that a single file entry only provides access to 16K bytes on the disk. To access a larger file you must use extents, which are duplicate file entries containing unique pointers for different portions of the file.

The information derived from these calculations is used by the BDOS when the application program next issues the Read command to the

BDOS. In this case the DE register pair is loaded with the address of the FCB, and register C is loaded with 14 hexadecimal when the BDOS is called. The BDOS then uses the data in the FCB to calculate a sector and track address for the requested data. First it passes the sector-address information to the BIOS (through the SETSEC entry point) followed by the track address information (through the SETTRK entry point). We'll discuss the design of the BIOS and the required entry points later. After the sector and track information have been passed, the BDOS then asks the BIOS to perform a Read operation of the identified sector.

At this point the BIOS takes the sector- and track-address information and constructs a device control block (DCB) that commands the Xebec controller to read the data from the requested sector of the disk. As we explained earlier in this series, the commands go from the computer, through the host computer adapter (HCA), to the disk controller. The disk controller then performs the requested Read operation from the disk, placing the data in a local memory area on the controller card. The BIOS can then begin to access the data being read from the disk and move it to the DMA memory buffer specified by the original SETDMA command. Once



Disk Primitive	Operation
SELDSK	Selects a particular disk in the system as the "active" disk. The routine must keep track of which disk is selected and pass the address of a disk-characteristics table describing the selected disk to the BDOS.
SETTRK	Sets the track number for the next Read or Write operation.
SETSEC	Sets the sector number for the next Read or Write operation.
SETDMA	Defines the 128-byte buffer that is to be used to get data during disk-write operations or receive data during disk-read operations.
READ	Reads 128 bytes of data from the selected track and sector in the DMA buffer area.
WRITE	Writes 128 bytes of data from the DMA buffer area into the selected track and sector.
SECTRAN	Performs logical-to-physical sector translation to improve overall CP/M disk response.
HOME	Moves the head on the selected disk to sector 0, track 0.

**Table 1:** A list of disk-related primitive functions that have to be performed by the Winchester disk BIOS in order to be compatible with CP/M.

all 128 bytes of the requested logical sector are moved into the DMA area, the Read operation is complete and control is returned to the application program.

In this overview of the combined operation of an application program, the BDOS, and the BIOS in accessing and reading information contained on the disk, some of the intricacies of the process, such as extents of disk files and detailed operation of the BDOS, have been glossed over. However, the illustration should provide enough information for you to understand the design and construction of a BIOS for a Winchester disk subsystem, and we refer you to CP/M documentation to gain a more in-depth understanding of the CP/M file control services (FCS) and the operation of the BDOS.

As you can see from the above example, only a few primitive functions have to be performed by a Winchester disk BIOS for it to be compatible with a CP/M system. Table 1 presents a complete list of these primitive functions along with a brief description of each function. In a complete BIOS, each of these functions is a separate entry point into the BIOS, and all you have to do to establish a BIOS is write code for each entry point to perform the necessary function. But first you must

understand the hardware operation and software interface to the Winchester disk, which is our next topic.

### Hardware Operation and Software Interface

As we discussed last month, the communications interface between the BIOS routines for the Winchester disk drive and the drive itself consists of four I/O ports on the S-100 bus. The addresses of these ports are selected in a contiguous block of four ports by switch settings on the HCA card. We will refer to ports 0 through 3 to indicate particular ports in this block.

Commands and data are sent to the controller by writing to these ports. The HCA retrieves data from the controller by reading from these ports. Each command to the controller consists of a block of 6 bytes of command information. This 6-byte block is the device control block mentioned earlier. Figure 4 shows the general format of the DCB and how this format is used for three different disk commands. The DCB always contains the op code and command types as shown in the general description of the data structure. In addition, the DCB may contain up to 21 bits of physical address information when an actual Read or Write operation is being performed. It also may contain

additional control information specifying such things as the number of retry operations to perform in the event that an error condition is detected. For more information on the details of the DCB, see the Xebec controller manual. For a Write command, the 6 bytes of the DCB are sent to the controller followed by the 256 bytes of data to be written into the physical disk sector specified in the command. After receiving the 256 bytes of data, the controller returns 2 bytes of error status information to the HCA. A Read operation works similarly in that the 6 bytes of the DCB are sent to the disk, which then returns 256 bytes of data from the sector specified in the command block. The controller also tags on an extra 2 bytes of error status information at the end of the transfer. In addition, the Xebec controller offers a Request Sense Status function that returns 4 bytes of more detailed error status information at the end of the command.

In typical operation, the disk and controller would be reset on a cold boot by performing an output to port 3. Once this is completed, the disk controller would be put in a command mode by outputting a 1 to the data port (port 0) followed by a Write to the status port (port 1), which activates the SEL signal. (This and many of the signals referred to in this section were described last month.) The disk-access routine then examines the REQ line by performing an input from port 1 and testing the proper status line. When the REQ line becomes active the routine outputs the first of the 6 command bytes to port 0. This output automatically generates the ACK signal to complete the handshake between the HCA and the controller. The software then monitors the REQ line until it again becomes active and then sends the second command byte. This process is repeated until all 6 command bytes have been sent to the disk controller. The routine then uses the same process to read or write the appropriate number of data bytes at port 0 depending on the particular command that was sent. In the case of a BIOS routine, the disk address that is to be accessed is derived by the BDOS from

(4a)

## GENERAL DCB FORMAT

		BIT							
		7	6	5	4	3	2	1	0
BYTE	0	COMMAND CLASS				OP CODE			
	1	LUN				HIGH ADDRESS			
	2	MIDDLE ADDRESS							
	3	LOW ADDRESS							
	4	SECTOR COUNT							
	5	CONTROL FIELD							

(4b)

## DCB FOR A READ OPERATION

		BIT								
		7	6	5	4	3	2	1	0	
BYTE	0	0	0	0	0	1	0	0	0	-CLASS = 0, OP CODE = 8
	1	0	0	0	HIGH ADDRESS					-0 = 0 OR 1 FOR SELECTED DRIVE
	2	MIDDLE ADDRESS								
	3	LOW ADDRESS								
	4	0	0	0	0	0	0	0	1	-READ A SINGLE SECTOR
	5	0	0	0	0	0	0	0	0	

(4c)

## DCB FOR A WRITE OPERATION

		BIT								
		7	6	5	4	3	2	1	0	
BYTE	0	0	0	0	0	1	0	1	0	-CLASS = 0, OP CODE = AH
	1	0	0	0	HIGH ADDRESS					
	2	MIDDLE ADDRESS								
	3	LOW ADDRESS								
	4	0	0	0	0	0	0	0	1	-WRITE A SINGLE SECTOR
	5	0	0	0	0	0	0	0	0	

(4d)

## DCB FOR A REQUEST SENSE STATUS COMMAND

		BIT								
		7	6	5	4	3	2	1	0	
BYTE	0	0	0	0	0	0	0	1	1	-CLASS = 0, OP CODE = 13
	1	0	0	0						} NOT USED
	2									
	3									
	4									
	5									

Figure 4: The device control block (DCB) used by the Xebec hard-disk controller. Figure 4a shows the general format for the DCB. Figures 4b through 4d show how the DCB is used for a Read operation, a Write operation, and a Request Sense Status command, respectively. Byte 0 contains information on the Command Class and the Op Code. LUN (logical unit number) indicates which drive you have selected of the two possible drives that can be connected to the controller. The high, middle, and low addresses form a 21-bit physical sector address. Byte 4 indicates the number of sectors to be read or written (for CP/M this is always 1). Byte 5 contains the following control fields: bit 7, when set, disables the four re-tries by the controller on all disk-access commands (during normal use, this is always 0); bits 3 through 6 are not yet used and are set to 0; and bits 0 through 2 select half-step options for other disk drives (for the Miniscribe drive, this is set to 0).

the information contained in the FCB. This information is then passed to the BIOS routines at the SETTRK and SETSEC entry points and the BIOS uses this information to construct the DCB for the actual disk access.

### Generating a Combined BIOS

The BIOS structure is very simple. A table of jump vectors is placed at the beginning of the BIOS code. This includes jumps to each of the primitive functions that the BIOS performs. Table 2 shows that these functions include the disk-oriented primitives presented in more detail in table 1 as well as the necessary functions to handle the other peripherals in the system, such as terminals and printers. The BIOS routines for peripherals other than disks are used without modification in the construction of a new combined BIOS. The existing disk and boot functions are augmented as shown in figure 5. The cold boot functions for both the existing disk system and the new Win-

chester disk are combined to ensure that all peripherals on the system are properly initialized when the system is booted. A new SELDSK function is written that keeps track of which disk system is selected and passes the proper disk-definition-table address back to the BDOS. Finally, a series of disk-handling routines are written for the Winchester disk. These routines are used as the initial vector addresses for the initial jump table. Depending on the particular entry point, these routines either perform the indicated function for the Winchester drive and then transfer to the appropriate function for the existing floppy drive or test to see which drive is selected and simply transfer control to the appropriate routine for the selected drive. An example of the first case is the SETDMA function, which causes the DMA buffer address to be set for both the Winchester and any other disk drives in the system. In the case of an actual READ function, however, a test is made for the selected

disk and then control is passed to the proper disk-read routine. Listing 1 on page 386 presents a skeleton of a combined BIOS that includes all the BIOS routines for the Winchester disk drive and comments indicating where routines from an existing BIOS should be placed.

The code presented in listing 1 has been tested and will operate with a Xebec controller connected to a Miniscribe disk using the HCA described in last month's article. The SELDSK entry point keeps track of which disk is selected and uses register pair HL to pass the address pointer of the selected disk characteristics table to the BDOS. This table is located at DPBASE in the BIOS code and has been created using two macros, DISKS and DISKDEF, supplied by Digital Research. These macros and the structure of this table are described in Digital Research's *CP/M System Alteration Guide*. The code for the cold boot entry point, BOOT, assumes that a new copy of the sys-







# 5 star hotels in the Middle East... that's the Sheraton style<sup>SM</sup>

The Sheraton style is offering today's business traveller more 5-star hotels in the growing business centers of the Middle East than anyone else. So for unparalleled service and the best business facilities in 5-star luxury — experience Sheraton's style in the Middle East.



**Abu Dhabi Sheraton** — The height of luxury on the Gulf. Centrally located to business and right on the beach. Experience superb cuisine at the Zafeer Supper Club or exotic specialties at Mouzaira's.



**Dubai Sheraton** — Convenient to the commercial district and overlooking the water, the Dubai Sheraton is a major architectural achievement. Dine at Lou Lou's, renowned for its sumptuous food and attentive service.



**Bahrain Sheraton** — This 1st Class luxury hotel has it all — tennis courts, health club, and gourmet dining at the Al Bustan. Here in the heart of the business center, you'll be only minutes away from Government House and the best shops.



**Doha Sheraton** — A soaring atrium garden lobby and the finest conference facilities in Qatar are among the big attractions at this new landmark of luxury. You can relax and enjoy swimming, sailing, windsurfing, tennis, and fishing.

**Sheraton Hotels Worldwide © 800-325-3535**

Or call your travel agent.

Circle 412 on Inquiry card.



not uncommon for a disk to have several bad sectors. The test program reads all sectors on the disk and saves the location of any bad sectors identified during the Read process. The routine then identifies these bad sectors to the controller, which constructs an alternate track assignment for each of the bad sectors on the disk. After this alternate assignment is complete, the existence of bad sectors on the disk is transparent to the system. The controller keeps the alternate-track data on the disk and, when a disk access is made to a bad sector, the controller automatically switches to the alternate track to read or write the data.

The second utility, the system-generation program, is used to write the new operating system to the Winchester drive or to read an existing operating system from the Winchester drive into memory. Installation procedures for a combined Winchester drive BIOS are the same as for any typical CP/M BIOS and will be covered in the next section. At the

end of the configuration process, a system image will reside in memory starting at location 900 hexadecimal. The locations 900 to 980 hexadecimal contain the system loader, and the locations from 980 hexadecimal on contain the newly configured operating system. A WRITE routine must be designed to take the data from these

**No matter how careful you are in building the system, something is bound to be wrong.**

locations in memory and write them to the Winchester disk drive starting at track 0, sector 0. Similarly, a READ routine must be designed to take information from track 0 of the disk and place it into memory starting at location 900 hexadecimal.

#### Building a New BIOS

One other program must be written before a new BIOS can be built and

installed in a CP/M system. This is the system loader that is used to initially read in the system from the disk. This program is written to run at location 80 hexadecimal and is restricted to 128 bytes in length. It is used to load the system during the bootstrap process that we will describe later. The program is designed to read the system starting at track 0, sector 1 of the Winchester disk and, when the load is complete, to transfer control to the proper entry point of CP/M to start the operating system running.

Once the system loader and the BIOS code are complete, the next step is to assemble both of these programs and remove any assembly or syntax errors. In the case of the BIOS, the symbolic variable MSIZE must also be defined before assembly to correspond to the size of the system being generated. Assuming that you have achieved an error-free assembly, the next step is to build a new CP/M system that contains the new system loader and BIOS and to write this

# PICK A SYSTEM!

◀ COMPLETE ▶

We're offering you our SB-80 system in either 5 1/4" or 8" disk drives, your choice. Either way your system comes with a full size (12" diagonal) non-glare tilttable green screen with 24 lines by 80 character format. Its multi-character set offers blinking cursor, underlining, reverse video, and half and zero intensity. The movable, detachable keyboard has a numeric pad with cursor control and function keys.

- Single Board Technology ■ CP/M® Operating System
- 4 MHz Z80A CPU ■ 64K 200ns Main Memory
- 8-Inch Dual Density Floppy Drives
- 5 1/4-Inch Dual Density Floppy Drives
- 2-Serial Ports ■ 2-Parallel Ports
- 4-Counter/Timers ■ Expandable

For further information about this limited offer call or write:



*Nationwide on-site and depot repair service through the professionals at INDESERV.*

©CP/M is a registered trademark of Digital Research, Inc.

Colonial Data Services Corp., 105 Sanford Street, Hamden, Conn. 06514 • (203) 288-2524 • Telex: 956014



## “A Database That Catches Mistakes? That's My Qbase.”

**Presenting Qbase,<sup>™</sup> The Personal Database And Reporting System  
That Prevents Mistakes Before They Become Expensive. Just \$189 Complete.**

There's no question that databases are useful tools for storing and retrieving information. Thousands of professionals use databases to monitor inventory, manage mail lists, record fixed assets, and keep track of personnel records.

So what's the problem?

### **NOT ALL DATABASES ARE CREATED EQUAL**

In hundreds of personal computer applications, users agree on one thing: there's nothing more aggravating than a database that lacks all the features to do the job that needs to get done.

And of all the database features used by experienced users, none is more often called for than data entry checking.

Why is that so important? Because experienced users know how many aggravating hours they can waste fixing mistakes that their database should have caught.

**For Use With IBM PC and APPLE II**

Fortunately there's Qbase, the only full-feature database in its price range that can substantially reduce common input errors.

### **PREVENT DATABASE CONTAMINATION**

Qbase uses sophisticated data checking features normally found on large systems. Functions that catch invalid alpha-numeric sequences. Check for minimum/maximum number lengths. Enforce data inputs where mandatory. Require date formats. Allow for yes/no replies. And verify that alphabetic and numeric values lie within pre-specified ranges.

And then we added an embedded calculator that automatically computes taxes and commissions. It even accepts credits and debits against balances due.

And reports? Qbase includes a powerful reporting facility—at no extra charge. With it, you can produce sorted reports with sub-totals AND totals. Moreover, all report definitions are fully documented and stored in a library. So there's no guessing which report does what. Just call for your favorite report and it's done.

Write or call for your free brochure, "How To Keep Errors Out Of A Database." See for yourself what data checking can do to save you time and aggravation. Write to:

**Applied Software Technology  
14125 Capri Drive  
Los Gatos, CA 95030  
or call 408/370-2662**

NAME \_\_\_\_\_

COMPANY \_\_\_\_\_

ADDRESS \_\_\_\_\_

CITY \_\_\_\_\_

STATE \_\_\_\_\_

ZIP \_\_\_\_\_

PHONE (AREA CODE) \_\_\_\_\_



**Qbase**  
Personal Database/  
Reports



RESULT READS CP/M FROM DISK AND RELOCATES IT TO NEW POSITION. SAVE RELOCATED CP/M ON DISK. LOADS RELOCATED CP/M INTO MEMORY. LOADS NEW BIOS AND OVERLAYS EXISTING BIOS. READS NEW LOADER AND OVERLAYS EXISTING LOADER. WRITES NEW SYSTEM TO FIRST TRACK OF HARD DISK

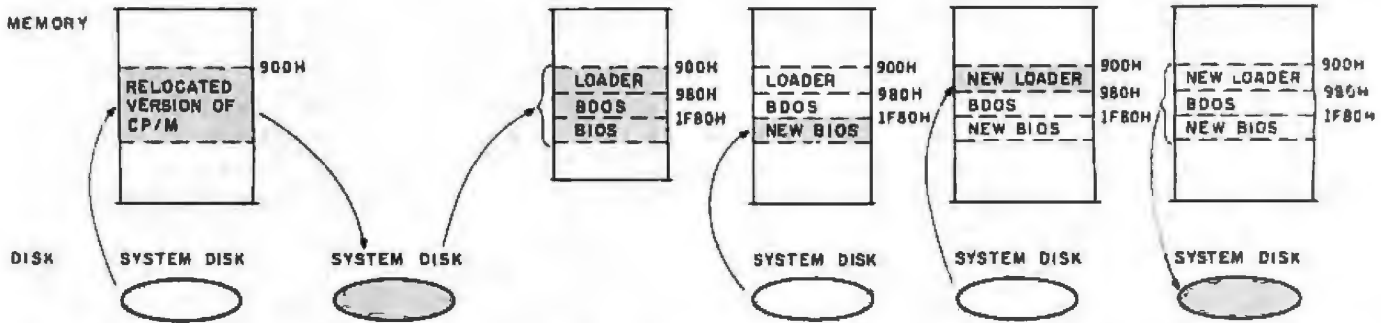


Figure 6: Installing the new operating system. First, the MOVCPM instruction reads the current version of CP/M from the disk into memory at location 900 hexadecimal and relocates it to run at a location specified in the command. The SAVE instruction then places the relocated version of CP/M onto the disk under the filename CPMNN.COM. The DDT command reloads the relocated version of CP/M into memory at location 900 hexadecimal and transfers control to the DDT program. Next, the command I NEWBIOS.HEX reads the new BIOS from the disk and overlays the existing BIOS. The command I NEWLDR.HEX then reads the new system loader from the disk and overlays the existing loader. Finally, the WRITE utility program writes the properly configured operating system to the first track of the Winchester disk.

new system to the Winchester disk drive starting at track 0, sector 0. In this process you should first use the MOVCPM utility (provided by

CP/M) to create a new copy of CP/M that is properly sized for the system. Then, as instructed in the MOVCPM utility, this new copy of the operating

system must be saved on the disk for later retrieval by using CP/M's standard SAVE utility. Once the new copy of the system is saved, the next

From Computer Plus to YOU ...

## PLUS after PLUS after PLUS

**BUY DIRECT** Here are just a few of our fine offers... call TOLL FREE for full information.

<b>COMPUTERS</b>	Model 12 1 Drive \$2699 2 Drive \$3375	Color Computer 16K 1335 w/16K 1st basic 1305 w/32K 1st basic 1420	Model III 16K 1099 Model III 48K 2 Disk & R5232 c 11549
Okidata 82 1328 Okidata 82A 1299 Okidata 92 1540	Color Computer Disk Drive Drive 0 1470 Drive 1 1299	Smith Corona TP Daisy Wheel 1565	

**BUY DIRECT** Here are just a few of our fine offers... call TOLL FREE for full information.

<b>COMPUTERS</b>	Model 12 1 Drive \$2699 Model 12 2 Drive \$3375 Model III 48K 794 Model III 48K 794 2 Disk & R5232 c 1549 Color Computer 16K 1335 Color Computer 16K w/extended basic 1305 Color Computer 32K-48K w/extended basic 1420 Packet Computer 2 168 Model 16 12R 1258 Model 16 2DR 1288 DT-1 Data Terminal 499 RT 310 Portable Terminal 779	<b>MODEMS</b> 1 Year Direct Connect Modem 238 Hayes Smart Modem II 238 Hayes Smart Modem 1200 268 Navigation Smartmodem 1200 489 Navigation J-CAT 125	<b>PRINTERS</b> Daisy Wheel II 1745 DWP-410 1320 Smith Corona TP Daisy Wheel 866 Cott 101 Epson FX80 999 Epson MX100 1538 COP-118 109 DMP-100 315 DMP-200 369 DMP-400 904 DMP-500 1538 DMP 2100 1778 Okidata 80 320 Okidata 82A 399 Okidata 82A 455 Okidata 84 Postscript 999 Okidata 92 510 Okidata 92 689 P.C. Prober Printer 180	<b>DISK DRIVES</b> R.S. Model III 151 Drive 650 Tandon 40 160K II 280 Color Computer Drive I 299 Color Computer Drive II 470 Primary Hard Disk 16 3990 Primary Hard Disk 16II 2199	<b>ETC.</b> CCR-81 recorder 62 C. G. Jaywicka 32 16K RAM II C. 200-H3 chip 25 64K Rom Chip 75 Coco III, Plus D C 5 69.95 32K Microcomputer Printer 229
------------------	---	--	--	--	--

Since 1973 - We have the lowest possible Fully Warranted Prices AND a full complement of Radio Shack Software.

Prices subject to change without notice. Not responsible for typographical errors. R.S. is a registered trademark of Radio Corp.

**TOLL FREE 1-800-343-8124**

**computer plus**

P.O. Box 1094  
480 King Street  
Littleton, MA 01460  
917-485-3193

**PopCom**™

PERSONAL COMMUNICATIONS

© BRICKER ASSOCIATES 1983

# Is 42 seconds worth \$10000?



The new Transtar 130 daisy wheel printer generates a full-page letter in 78 seconds. The least expensive 40 cps printer does it in 36. Only 42 seconds difference...for twice the price.

At only \$895, the Transtar 130 letter-quality printer makes speed its only compromise. Shannon-text rated at 16 cps, the Transtar 130 gives you better printing quality than any 40 cps printer. It allows you the full range of word-processing functions such as proportional spacing, superscript, subscript, under-scoring and a true boldface. The 130 is "plug and go" compatible with the best-

selling word processing packages. It's quiet: only 65dB. It's durable. It boasts a unique new autoloader feature that automatically loads paper to one of four pre-selected positions with the touch of a button. And, as if that weren't enough, its end-user warranty runs a full six months—twice that of most of its competitors.

Affordable and loaded with all the features of printers costing twice as much, the Transtar 130 letter-quality printer retails for less than \$900. But it's up to you: Is 42 seconds really worth \$10000?

## Transtar

Box C-96975, Bellevue, Washington 98009



step is to read the system back into memory using the DDT utility. If the system was saved under the name CPMNN.COM you can use the following CP/M command to initiate DDT and read the new copy of the system into memory:

DDT CPMNN.COM

After this command is executed, the new system will be located in memory starting at location 900 hexadecimal,

and DDT will be running. The next step is to overlay the new system loader and new BIOS on top of the copy of CP/M in memory by using two DDT commands: I (insert) and R (read). These commands place the new system loader into memory at location 900 hexadecimal and place the BIOS at location 1F80 hexadecimal. Once these overlays are complete, the system is properly configured for the Winchester disk drive. Next we must get out of DDT and

return to CP/M while leaving the newly created copy of the system in memory. First, issue a G0 command to DDT that transfers control to CP/M. Once you are back in CP/M, the final remaining task is to run the system-generation utility to load the newly constructed system, which now resides in memory starting at location 900 hexadecimal, onto the Winchester disk starting at track 0, sector 0. Figure 6 graphically summarizes these steps.

### Building a New Bootstrap

At the completion of the process we just described, a copy of a properly configured CP/M system and system loader is on the first track of the Winchester disk. The one remaining task is to develop the software to bootstrap this system into memory and to configure the hardware so that this bootstrap is executed when a hardware boot command occurs. The actual bootstrap code is very simple. All it has to do is read the first 128 bytes from track 0, sector 0 on the Winchester disk drive into memory starting at location 80 hexadecimal and, when the read is complete, transfer control to the beginning of this code. This bootstrap code should be written to run at whatever location is going to be assigned to the PROM (programmable read-only memory) chip on the HCA, which we mentioned last month. When properly assembled and linked, the bootstrap code is burned into the HCA PROM and the software installation is essentially complete. The processor board is then "restrapped" so that the bootstrap address corresponds to the beginning of the PROM on the HCA.

Once this modification has been completed, a hardware boot command (i.e., pressing the RESET button) results in the sequence of events presented in Figure 7. At the boot command, the processor begins executing code at the beginning of the HCA PROM. This code reads the first 128 bytes of data from the first physical sector of the first track on the disk into memory starting at location 80 hexadecimal. When the read is complete, the code in the PROM

# THE BENCHMARK<sup>®</sup>

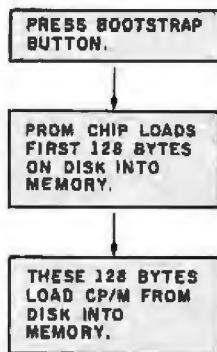
## A Word Processor Worthy of Comparison . . .

FEATURE	BENCHMARK	Wordstar	BENCHMARK
	2.0	3.21	3.0
Ease of Operation	YES	NO	YES
Plain English Commands	YES	NO	YES
Use Cursor Keys	YES	NO	YES
Control Characters	NO	YES	NO
Function Keys	YES	NO	YES
Computer Aided Tutorial	YES	YES	YES
Descriptive Directory	YES	NO	YES
29 Character Title	YES	NO	YES
Author & Operator ID	YES	NO	YES
Document Size	YES	NO	YES
Creation Date	YES	NO	YES
Revision Time & Date	YES	NO	YES
Standard Editing Features	YES	YES	YES
Go To Any Page	YES	NO	YES
Interactive Printing	YES	NO	YES
Automatic Reformatting	YES	NO	YES
Automatic Repagination	YES	NO	YES
Headings and Footings	YES	YES	YES
Multi-line	YES	NO	YES
Keyboard Phrases	YES	NO	YES
Proportional Printing	NO	NO	YES
Business Graphics	NO	NO	YES
Paragraph Assembly	NO	NO	YES
Edit Marking	NO	NO	YES
Auto Widow/Orphan Protect	NO	NO	YES
Auto Footnoting	NO	NO	YES
Built In Calculator	NO	NO	YES
Price	\$249	\$495	\$499

## DEMAND A COMPARISON!

Call or Write

Metasoft Corporation, 711 E. Cottonwood, Suite E, Casa Grande, AZ 85222 • (602) 961-0003



**Figure 7: The Bootstrap process.** Pressing the hardware bootstrap (Reset) button causes the microprocessor to transfer control to the PROM chip on the host computer adapter. The code in the PROM reads the first 128 bytes of data from track 0 of the hard disk into memory starting at location 80 hexadecimal and then transfers control to that location. This code in turn loads the CP/M system off the first track of the Winchester disk. Then, when the load is complete, the code transfers control to location 0 hexadecimal to start CP/M running.

transfers control to location 80 hexadecimal, which now contains the system loader. This code now reads the remainder of the CP/M system from the first track on the disk into memory and then transfers control to the CP/M system. The result is that a properly configured system, which includes the Winchester disk drive, is left running in memory, waiting to respond to any user commands.

### System Debugging

No matter how careful you are in building the hardware and software we have just finished describing, it is a fact of life that when plugged into the system there will be something wrong. This is when the really interesting portion of the system integration process begins, namely, finding and correcting the inevitable bugs in the hardware and software. This debugging process can be broken into three separate areas. The first is debugging the HCA. The second is debugging and examining the HCA, disk controller, and disk system. The last is debugging the CP/M interface software. We will now describe some of the techniques that can be used in each of these areas.

## Make your spooling network sing in six-port harmony.

### Add MultiSpool – the hardware spooler that's truly flexible.

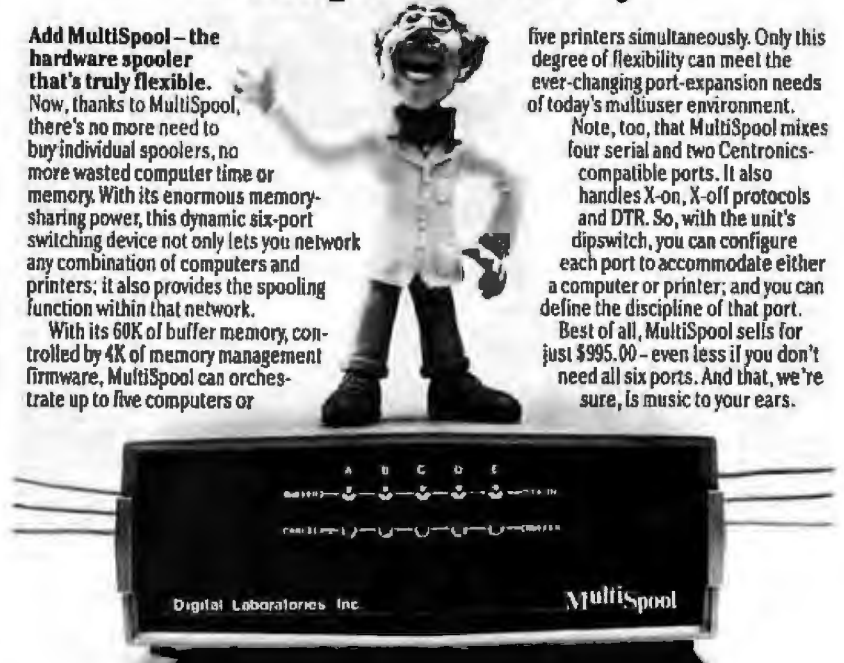
Now, thanks to MultiSpool, there's no more need to buy individual spoolers, no more wasted computer time or memory. With its enormous memory-sharing power, this dynamic six-port switching device not only lets you network any combination of computers and printers; it also provides the spooling function within that network.

With its 60K of buffer memory, controlled by 4K of memory management firmware, MultiSpool can orchestrate up to five computers or

five printers simultaneously. Only this degree of flexibility can meet the ever-changing port-expansion needs of today's multiuser environment.

Note, too, that MultiSpool mixes four serial and two Centronics-compatible ports. It also handles X-on, X-off protocols and DTR. So, with the unit's dipswitch, you can configure each port to accommodate either a computer or printer; and you can define the discipline of that port.

Best of all, MultiSpool sells for just \$995.00 – even less if you don't need all six ports. And that, we're sure, is music to your ears.



## Digital Laboratories Inc.

600 Pleasant Street, Watertown, MA 02172. (617) 924-1680

# BUY MONITORS DIRECT!!

**\$109<sup>95</sup>**  
plus \$4.75  
shipping

### Model TM-12PC-GX 12" P31 GRAPHICS

- ★ 1200 line resolution
- ★ 18.9 MHz band width
- ® Apple III is a registered trademark of Apple Computer.

Monitors by:



VISA, MasterCard & American Express accepted. No C.O.D.

**\$299<sup>95</sup>**  
plus \$9.50  
shipping

### Model TM-1440 13" RGB COLOR

- ★ 360/230 lines resolution
- ★ Up to 80 characters
- ★ Apple III and IBM customers please add \$29.50 for factory installed mod board and cable for 16 colors.



Call Toll Free 1-800-258-6370  
18 Bridge Street, Salem, NH 03079



The first thing to debug is the HCA card. Debugging this device involves making sure that the various combinations of possible input conditions result in the expected outputs to the disk controller. You can do this most efficiently by writing a set of driver routines in assembly language to write messages to the various output ports on the HCA. If you write these routines to loop continuously, you can use an oscilloscope to check the output registers on the HCA to ensure that the card is acting properly.

When you've verified proper operation of the HCA to the maximum extent possible, next connect the disk controller and the Winchester disk drive to the HCA. This simple connection begins the debugging process for the Miniscribe disk drive, which has extensive self-test features and continuously monitors its own operation to check for faults. If a fault is detected, the drive communicates with the user by flashing a Morse code letter (using the drive select light) to identify the particular fault that was detected. Once the disk is

operating properly, the way to debug and test the rest of this total system is to pass various DCBs to the disk controller and see if the disk responds to these DCB inputs as expected. For example, you can test the disk by performing a controller self-test, formatting the disk, writing information to a particular sector, reading the information back, and testing for error conditions. This type of testing not only verifies proper disk operation but also provides you with valuable insight into the disk operation, which you can use during the remainder of the integration process.

Once the disk subsystem hardware is operating properly, the next step is to integrate the software. We described this integration process earlier. However, during the initial testing it is convenient to modify this procedure to allow use of some of the CP/M debugging tools to debug the interface software. To do this, you should create a "false" CP/M system that runs inside (i.e., at a lower memory address than) the current CP/M system running on the computer.

This keeps the initial user system intact and allows you to run the new CP/M system under control of an existing debugged CP/M system, so you have access to the standard debugging tools from CP/M, such as DDT, to aid in debugging the new version of the BIOS.

### Conclusion

We have now described the entire process of adding a Winchester disk subsystem to an S-100 computer system running CP/M. As we have tried to show, this is a rather substantial undertaking and should not be started lightly. The main advantage in performing such an integration project is the learning that takes place during the project. If your main goal is to obtain additional storage capability for a microcomputer, you could obtain this storage less expensively and certainly with less effort by buying a commercially available unit such as the one we manufacture. Because of quantity pricing and volume discounts, complete Winchester disk-drive subsystems are commercially available at a cost comparable to what a hobbyist would spend for the hardware portion of the system alone.

However, if you are interested in doing the work yourself and you have the necessary time and expertise, we encourage you to attempt this project and use this series of articles as a guide. ■

*The Winchester disk drive subsystem described in this series of articles is available as a completely assembled unit from ASC Associates of Lexington Park, Maryland. In addition to the S-100 version discussed, versions are also available for TRS-80 and Apple computers. The disk-drive systems for these computers use the same drive and controller hardware as the S-100 version but use a different host computer adapter and interface software. Until a nationwide dealer distribution network is established, these systems will be available by mail order for \$1995. To order or obtain further information, write to ASC Associates Inc., POB 615, Lexington Park, MD 20653, or phone (301) 863-6784.*

## DOCUMATE/PLUS<sup>TM</sup>

### Indexes and Sorts WordStar<sup>TM</sup>

#### DocuMate/Plus<sup>TM</sup> Features . . .

- 16 Level Indexing
- Table of Contents Generation
- Self-Contained Sort Feature
- "See" and "See Also" References
- Output Format Control
- Cross-Document Index Generation

DocuMate/Plus generates completely collated tables of contents and alphabetical multi-level indexes from WordStar<sup>TM</sup> text files of any length as detailed as you desire.

DocuMate/Plus is refreshingly easy to use, and its internal sort feature can save you the cost of an expensive stand-alone sort program. Just type simple DocuMate commands right into your text file. DocuMate/Plus automatically finds and places all index references in a separate work file for sorting and collating.

DocuMate/Plus builds master indexes for many documents, such as research notes, books and articles, speeches, hardware and software documentation, and business correspondence.

#### DocuMate/Plus is Today's Most Flexible Text-Based Indexing System for Professional and Business Information Processing.

Try DocuMate/Plus at your local Osborne Computer Dealer, or call us for the name of your local authorized Orthocode textware dealer.

DocuMate/Plus is available on standard 8" CP/M and 5 1/4" Apple, Northstar, Osborne and Otrona diskettes.

- DocuMate/Plus Program with Manual . . . . . \$165.00
- Manual Only . . . . . \$ 25.00

**ORTHO**CODE  
The Textware Company

THE ORTHOCODE CORPORATION  
P.O. Box 6191 • Albany, CA 94705  
(415) 753-3222

• WordStar is a trademark of MicroPro International • CP/M is a trademark of Digital Research

# We're building the world's third largest computer company.

## Come join us.



We're Victor Technologies, Inc., a most dramatic force in the computer industry today, with our powerful 16-bit desktop microcomputer, the Victor 9000.

You probably recognize the name Victor . . . a respected name in office products for 65 years. We've built a worldwide sales, service and support system unsurpassed in our industry. Now we're combining that experience with innovative technology for the office of the future.

We're aggressively expanding our local dealer network. We're planning substantial new product offerings and support for all our office systems. Now we're focusing our efforts on securing major national accounts, and we're looking for people with fresh ideas and initiative to make it happen!

### **National Accounts Computer Salespersons**

Sell and support the Victor 9000, our powerful 16-bit desktop microcomputer, directly to Fortune 1000 companies. You must have a successful sales track record in a microcomputer hardware and software support environment, and the enthusiasm and initiative to contribute to our goal.

### **Technical Support Persons**

Support business applications software, both third-party and internal; communications; graphics; operating systems; general accounting and word processing packages for end users and dealers. Good verbal communications skills necessary. BSCS and at least 4 years experience in a similar environment required. Support languages include BASIC, COBOL, Pascal, FORTRAN.

Our goal is to build the third largest computer company in the world. We're off to a fast start with the Victor 9000. We have the commitment of Victor's experience, stability and financial strength.

Come join us! Call or write **Ian Reay at Victor Technologies, Inc., 5321 Scotts Valley Drive, #102, Dept. B-5, Scotts Valley, CA 95066. (408) 438-1144.** We are an equal opportunity employer.

# **VICTOR**

Circle 472 on Inquiry card.



# Take the New Encyclopedia of Computer Science and Engineering an \$87.50 value for only

# \$2.95

when you join the **Library of Computer and Information Sciences.**

You simply agree to buy 3 more books  
—at handsome discounts—  
within the next 12 months.

Thoroughly  
revised,  
updated and  
reorganized.

This up-to-date Second Edition contains:

- Over 1,870 pages of revised, expanded, and updated text
- 550 articles on virtually every aspect of the computer sciences
- Written by 301 distinguished authorities
- Over 300 photos, and over 250 diagrams, graphs and charts

Just published, the **ENCYCLOPEDIA OF COMPUTER SCIENCE AND ENGINEERING** is the most complete computer information resource available. Indispensable to consultants, business people, data processing professionals, and enthusiasts, it is a veritable data base of information on:

- Hardware
- Software
- Programming languages
- Artificial intelligence
- Operating systems
- Computer applications
- Personal computing
- and much more!

The Encyclopedia is organized to make finding and using its wealth of information an ease. Articles are alphabetically arranged and are cross-referenced to related articles and to specific subject

matter. The clear and expanded appendices include abbreviations, acronyms, special notation and terminology, as well as numerical tables, the mainstay of applied technologies. A complete 5,000-term index contains references to sub-categories, doubles as a computer science dictionary, and is an invaluable tool for locating specific information. An international glossary lists terms in five languages—English, French, German, Spanish and Russian.

#### **Praise For the First Edition:**

Called "Impressive... comprehensive... well done" by *Datamation*, and "...a real treasure cache" by *Business Management*, the new Second Edition

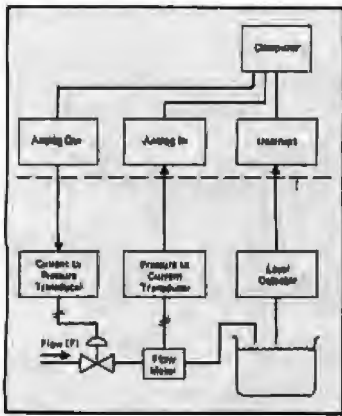
promises to eclipse *Computer Management's* statement on the original of "There isn't another book like it."

Send for your free 10-day trial look today.

**The Library of Computer and Information Sciences** is the oldest and largest book club especially designed for the computer professional. In the incredibly fast-moving world of data processing, where up-to-date knowledge is essential, we make it easy for you to keep totally informed on all areas of the information sciences. In addition, books are offered at discounts up to 30% off publishers' prices.

Begin enjoying the club's benefits today!

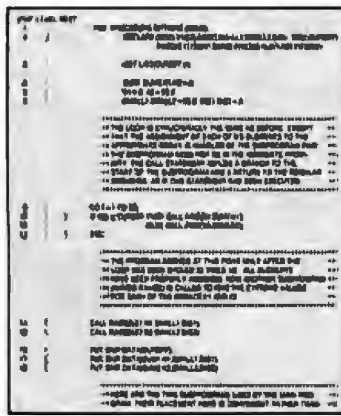
# The Encyclopedia gives you information on:



## SPECIAL PURPOSE COMPUTERS

You'll see how computers can be designed and constructed to serve specific application purposes. There's information on configuration special-purpose machines... industrial control computers directly connected to physical processes, along with an indication of the specialized subsystems they require... analog input... ultra-high availability computers, such as NASA's computer interconnection for the Space Shuttle.

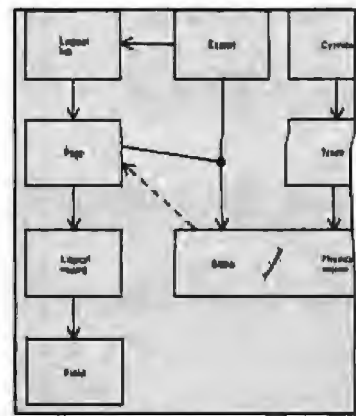
There's also a look at pipeline and array processors... computational special-purpose computers... vector processors versus scalar processors... algorithmic processors... parallel processors... associative processors... plus a look at the future of special-purpose architecture and the cost justifications for these large, specialized machines.



## PROCEDURE-ORIENTED LANGUAGES

The ENCYCLOPEDIA offers an in-depth look at both the advantages and drawbacks of procedure-oriented languages. There are discussions of compilers. Program transportability from computer to computer. Programming styles and techniques. Modular construction of programs. Subroutine handling. Tracing. Decisions and decision structures.

Furthermore, there are overviews of the major procedure-oriented languages in use today, including FORTRAN... COBOL, with an example, ... ALGOL... PASCAL... PL/1... BASIC... and APL. In addition, there is a discussion of the future of procedure-oriented languages and a look at the new languages that are being developed for future use.

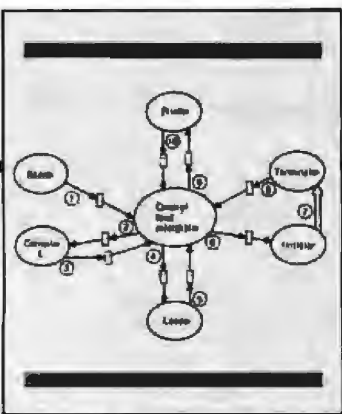


## SMALL COMPUTERS

Q. Where can you find a concise overview of the booming small computer field?

A. The Encyclopedia shows you how microcomputers developed and how they may become even more powerful in the future. There are details on personal computing software packages and how new applications can be developed on small computers—including coverage of everything from financial software to speech synthesis to computer games.

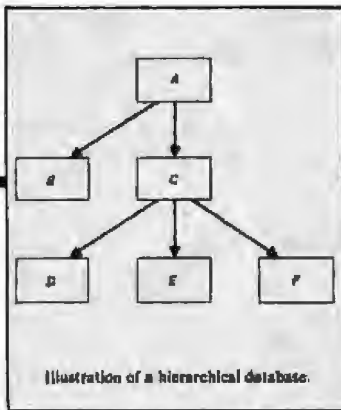
Also spelled out are the basic functional units of a microcomputer... storage techniques such as bubble memory and magnetic diskettes... the use and application of microcomputers in controlling industrial processes... the small computer as an intelligent terminal... and much more.



## OPERATING SYSTEMS

The Encyclopedia introduces a survey article on the features and functions of operating systems. You'll find fingertip access to details on CPU's, memory, and peripheral devices... I/O buffering, library routines, file handling, system logging... multiprogramming... memory protection and relocatability... spooling and off-line processes.

Further topics covered include: an overview of commercially-available systems... system types (dedicated transaction, interactive, extensible)... multitask capabilities... interrupt-based systems... task dispatching and control... file storage... distributed operating systems... and more.



## DATABASE MANAGEMENT

The Encyclopedia examines database concepts... record types and their physical and logical relationships... structure diagrams... and optional relationships. You'll find coverage of generalized database management system (DBMS) software... network, hierarchical, and relational databases... how DBMS facilities are provided... and ways in which designers can integrate separate applications in one database.

Further articles examine the role of the database administrator... the design and construction of distributed databases which support computer networks... on-line database organization... new advances in database technology... and much more.

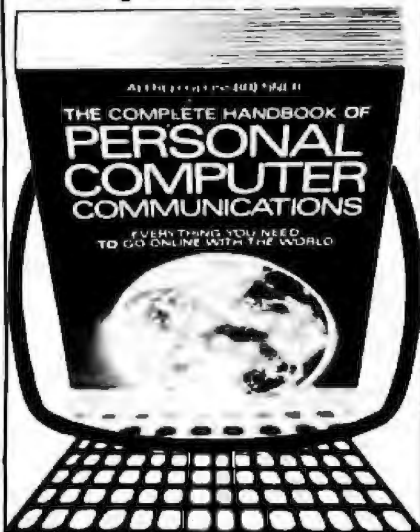
## 4 Good Reasons to Join

- 1. The Finest Books.** Of the hundreds of books submitted to us each year, only the very finest are selected and offered. Moreover, our books are always of equal quality to publishers' editions, never economy editions.
- 2. Big Savings.** In addition to getting the ENCYCLOPEDIA OF COMPUTER SCIENCE AND ENGINEERING for \$2.95 when you join, you keep saving substantially—up to 30% and occasionally even more. (For example, your total savings as a trial member—including this introductory offer—can easily be over 50%. That's like getting every other book free!)
- 3. Bonus Books.** Also, you will immediately become eligible to participate in our Bonus Book Plan, with savings up to 70% off the publishers' prices.
- 4. Convenient Service.** At 3-4 week intervals (16 times per year) you will receive the Book Club News, describing the Main Selection and Alternate Selections, together with a dated reply card. If you want the Main Selection do nothing and it will be sent to you automatically. If you prefer another selection, or no book at all, simply indicate your choice on the card, and return it by the date specified. You will have at least 10 days to decide. If, because of late mail delivery of the News, you should receive a book you do not want, we guarantee return postage.

If the reply card has been removed, please write to The Library of Computer and Information Sciences Dept. 7-BS2, Riverside, N.J. 08075 to obtain membership information and an application



Bring thousands of dollars worth of information home for only \$14.95!



"The best reason to buy a computer. Packed with useful information—it's an absolute must for computer owners everywhere."  
—Gary G. Reibsam, Vice-President of NewsNet Inc.

Your passport to the electronic universe—how to turn any personal computer or word processor into a communication/information machine of incredible versatility and power, even without a knowledge of programming. Here's just a sampling of what you get—\* How to select a modem and communications software \* How to send electronic letters, telexes and MailGrams™ \* Money-saving techniques for using The Source, Dow Jones News/Retrieval, DIALOG, BRS and more \* Get free software! Download thousands of programs \* Get privileged information from \$30,000 worth of newsletters \* Get discounts of 10% to 40% by shopping on-line \* Trouble-shooter's guide to problem-free communications \* Hundreds of free computer bulletin boards (CBBS) \* Access vast libraries (Library of Congress, N.Y. Times, magazines, and whole encyclopedias) \* Get real-time computer games and tournaments \* Electronic banking, investment management, and then barter \* Get toll-free numbers, valuable short-cut commands \* Get on-line advice from experienced users of your equipment.

Plus much more! In just two days you'll see what this unique handbook can do for you—but we'll give you two weeks to decide. Send for your copy now; if you're not satisfied return it in two weeks for a full refund.

Main Selection of The Small Computer Book Club  
Alternate Book-of-the-Month Club/Science Selection

Please return this coupon to your bookseller or direct to:  
St. Martin's Press  
175 Fifth Avenue, New York, N.Y. 10010 Attn: ML

Please send me \_\_\_\_\_ copy(ies) of The Complete Handbook of Personal Computer Communications (a \$14.95 paperback each). Please add \$1.50 per book for postage and handling. My check or money order is enclosed in the amount of \$\_\_\_\_\_. I may examine the book for two weeks and, if not 100% satisfied, I can return it for a complete refund.

Name \_\_\_\_\_  
Address \_\_\_\_\_  
City \_\_\_\_\_  
State \_\_\_\_\_ Zip \_\_\_\_\_

Listing 1: A complete listing of the BIOS needed to integrate a Winchester disk drive into a CP/M-based microcomputer.

```

CP/M MACRO ASSEM 2.0      0001      BIOS FOR A.S.C. ASSOC. HARD DISK SUBSYSTEM. 7/18/82

TITLE 'BIOS FOR A.S.C. ASSOC. HARD DISK SUBSYSTEM. 7/18/82'
;
; COMBINED BIOS INDICATES WHERE THE USER IS TO UPDATE
; SPECIFIC SUBROUTINES IN ORDER TO MERGE HIS EXISTING
; CP/M BIOS WITH THE A.S.C. ASSOCIATES CUSTOM BIOS.
;
; COPYRIGHT (C) A.S.C. ASSOCIATES 1982
;
; THIS BIOS USES THE DIGITAL RESEARCH CBIOS, DISKDEF LIB, AND
; SECTOR BLOCKING AND DEBLOCKING ROUTINES SUPPLIED WITH THE
; STANDARD CP/M 2.1 SOFTWARE PACKAGE AND IS THEN COMBINED WITH
; THE A.S.C. ASSOCIATES HARD DISK SOFTWARE DRIVERS.
;
; THROUGHOUT THIS CODE COMMENTS DELIMITED USING THE FOLLOWING
; FORMAT ARE TO BE CHANGED WHEN ADDING USER DISK ROUTINES.
;
; >>>> COMMENT <<<<<

003A = MSIZE EQU 58 ;CP/M VERSION MEMORY SIZE IN KILOBYTES
;
;
9800 = BIAS EQU (MSIZE-20)*1024
CC00 = CCP EQU 3400H+BIAS ;BASE OF CCP
D406 = BOOS EQU CCP+806H ;BASE OF BOOS
E200 = BIOS EQU CCP+1600H ;BASE OF BIOS
0004 = CDISK EQU 0004H ;CURRENT DISK NUMBER 0=A,...,15=E
0003 = IOBYTE EQU 0003H ;INTEL I/O BYTE
0001 = NUDISKS EQU 1 ;NUMBER OF DISKS IN SYSTEM
;
;
E200 = ORG BIOS ;ORIGIN OF THIS PROGRAM
002C = NSECTS EQU (BIOS-CCP)/128 ;WARM START SECTOR COUNT
;
;
; JUMP VECTOR FOR INDIVIDUAL SUBROUTINES
E200 C385E2 JMP BOOT ;COLD START
E203 C394E2 WBOOT: JMP WBOOT ;WARM START
E206 C3F3E2 JMP CONST ;CONSOLE STATUS
E209 C3F6E2 JMP CONIN ;CONSOLE CHARACTER IN
E20C C3F9E2 JMP CONOUT ;CONSOLE CHARACTER OUT
E20F C3FCE2 JMP LIST ;LIST CHARACTER OUT
E212 C302E3 JMP PUNCH ;PUNCH CHARACTER OUT
E215 C305E3 JMP READER ;READER CHARACTER OUT
E218 C308E3 JMP HOME ;MOVE HEAD TO HOME POSITION
E21B C30BE3 JMP SELDSK ;SELECT DISK
E21E C32AE3 JMP SETTRK ;SET TRACK NUMBER
E221 C332E3 JMP SETSEC ;SET SECTOR NUMBER
E224 C339E3 JMP SETDMA ;SET DMA ADDRESS
E227 C348E3 JMP READ ;READ DISK
E22A C366E3 JMP WRITE ;WRITE DISK
E22D C3F6E2 JMP LISTST ;RETURN LIST STATUS
E230 C341E3 JMP SECTRN ;SECTOR TRANSLATE
;
; DUMMY LIST OF JUMP VECTORS, USED TO TRANSFER CALLS TO USERS FLOPPY
; DISK SYSTEM. THIS TABLE IS OVERLAYED WITH THE USERS JUMP TABLE
;
; >>>> REMOVE THIS SECTION OF DUMMY JUMP VECTORS. <<<<<
;
;
E233 0000C9 XBOOT: NOP|NOP|IRET ;COLD START
E236 0000C9 XWBOOT: NOP|NOP|IRET ;WARM START
E239 0000C9 XCONST: NOP|NOP|IRET ;CONSOLE STATUS
E23C 0000C9 XCONIN: NOP|NOP|IRET ;CONSOLE CHARACTER IN
E23F 0000C9 XCONOUT: NOP|NOP|IRET ;CONSOLE CHARACTER OUT
E242 0000C9 XLIST: NOP|NOP|IRET ;LIST CHARACTER OUT
E245 0000C9 XPUNCH: NOP|NOP|IRET ;PUNCH CHARACTER OUT
E248 0000C9 XREADR: NOP|NOP|IRET ;READER CHARACTER OUT
E24B 0000C9 XHOME: NOP|NOP|IRET ;MOVE HEAD TO HOME POSITION
E24E 0000C9 XSLDSK: NOP|NOP|IRET ;SELECT DISK
E251 0000C9 XSETRE: NOP|NOP|IRET ;SET TRACK NUMBER
E254 0000C9 XSETSEC: NOP|NOP|IRET ;SET SECTOR NUMBER
E257 0000C9 XSETDMA: NOP|NOP|IRET ;SET DMA ADDRESS
E25A 0000C9 XREAD: NOP|NOP|IRET ;READ DISK
E25D 0000C9 XWRITE: NOP|NOP|IRET ;WRITE DISK
E260 0000C9 XLSTST: NOP|NOP|IRET ;RETURN LIST STATUS
E263 0000C9 XSECTRN: NOP|NOP|IRET ;SECTOR TRANSLATE
;
;
; NACLIB DISKDEF
E266 += DPBASE EQU 5 ;BASE OF DISK PARAMETER BLOCKS
E266+00000000 DP0: DW KLTO,0000H ;TRANSLATE TABLE
E26A+00000000 DW 0000H,0000H ;SCRATCH AREA
E26E+85E676E2 DW DIRBUF,DPB0 ;DIR SUPP,PARM BLOCK
E272+99E935B7 DW CSV0,ALV0 ;CHECK, ALLOC VECTORS
;
E276 += DPB0 EQU 5 ;DISK PARM BLOCK
E276+4000 DW 64 ;SEC PER TRACK
E278+04 DB 4 ;BLOCK SHIFT
E279+0F DB 15 ;BLOCK MASK
E27A+00 DB 0 ;EXTNT MASK
E27B+1F13 DW 4895 ;DISK SIZE-1
E27D+6302 DW 611 ;DIRECTORY MAX
E27F+FF DB 255 ;ALLOCO
E280+C0 DB 192 ;ALLOCI

```

Listing 1 continued on page 388



# OVERSEAS FAX. THE BEST WAY TO GIVE THEM THE PICTURE.

An exact copy. Fax is the only system that sends it most anywhere in the world. Speed. Economy. Confidentiality. Fax puts it together like no other system can.

All you need to send hard copy overseas is a telephone and a facsimile machine. The same machine you may already be using domestically. The price of a Fax transmission is the price of a call. And our 1-minute overseas minimum makes it more economical than ever. See the chart for sample rates.

Send signed documents. Graphs. Pictures. Fax transmits an exact duplicate from your original. Sending them requires no special training or personnel. Send them any time.

Many terminals can receive without an operator. Send them with Fax. It's the only way for hard copy to travel.

For a free brochure, call toll free 1 800 874-8000 or write: Fax Facts, P.O. Box 397, East Brunswick, NJ 08816-0397.

Times and costs to transmit a 400-word page to Europe\*

TRANSMISSION TIMES**	COST		
	Std. Tel Rate (7am-1pm)	Dis Tel Rate (1pm-6pm)	Econ Tel Rate (6pm-7am)
1 MINUTE	\$2.37	\$1.78	\$1.42
3 MINUTES	\$5.03	\$3.78	\$3.02
6 MINUTES	\$9.02	\$6.78	\$5.42

\*Similar attractive rates to other areas.

\*\*Transmission times vary depending on type of equipment used.



Another reason the world is sold on Bell.





# "SUPER SIX",™

## ITS POWER IS AWESOME!

- 6MHz Z-80B CPU
- S-100 IEEE-696 Compatible
- 6MHz Z-80 SIO, PIO
- 128KBytes Bank Selectable RAM
- Floppy Disk Controller, Simultaneous Operation of 5-1/4 and 8-inch Drives
- DMA Controller
- CTC Interrupt Clock
- CPM\* 3.0 (Plus), TurboDos\* and MPM II\* Compatible

We **ASTONISHED** the industry when we introduced **SUPER QUAD\***, the first single board S-100 computer. Now you're going to be **AMAZED** when you discover "**SUPER SIX**"™. It's power, it's speed, it's **AWESOME**.

The **SUPER SIX** runs 1-1/2 times faster than any other S-100 computer available today. 128KBytes of RAM with DMA is standard. So is simultaneous operation of 5-1/4 and 8-inch

floppies. No more worries about non-standard 5-1/4 inch formats.

Combine the power and speed of the **SUPER SIX** as the Master and the proven performance of **SUPER SLAVE**™ processor boards, and you've got a multi-processor, multi-user system that is nothing short of **AWESOME**.

**SPEED UP WITH SUPER SIX** . . . see the **SUPER SIX** at your quality local dealer or contact:

\*CPM and MPM are trademarks of Digital Research Corp

TurboDos is a trademark of Software 2000 Inc.

**SUPER SIX**, **SUPER QUAD**, and **SUPER SLAVE** are trademarks of Advanced Digital Corp.



12700-B Knott Avenue

Garden Grove, California 92641

TEL: 714-891-4004

TELEX: 678401 TABIRIN

"VISIT OUR OPEN HOUSE DURING NCC 8:30-5:00 PM DAILY MAY 16-19, 1983"



# !!!!FANTASTIC PRICES!!!! FROM DIGITAL DIMENSIONS

## OKIDATA

- ML-80..80 COL., 80 CPS.....\$317
- ML-82A..80 COL., 120 CPS.....\$395
- \*ML-83A..136 COL., 120 CPS.....\$639
- \*ML-84..PARALLEL, 136 COL., 200 CPS....\$969
- \*ML-84..SERIAL, 136 COL., 200 CPS.....\$1,083
- \*\*ML-92..80 COL., 160 CPS.....\$509
- \*\*ML-92..SERIAL, 80 COL., 160 CPS.....CALL
- \*ML-93..136 COL., 160 CPS.....\$832
- \*ML-93..SERIAL, 136 COL., 160 CPS.....CALL
- PACEMARK 2410..350 CPS.....CALL
- PACEMARK 2350..SERIAL, 350 CPS.....CALL
- "Includes TRACTOR FEED
- "Inc.,OKIGRAPH" DOT ADDRESSABLE GRAPHICS

## IDS

- PRISM 80..3.4K & 200 Sprint.....\$1,036
- Inc. sheet feed, color & graphics.....\$1,429
- PRISM 132..3.4K & 200 Sprint.....\$1,195
- Inc. sheet feed, color & graphics.....\$1,591
- MICROPRISM 480.....\$569

## STAR MICRONICS

- GEMINI-10..100 CPS, 2.3K BUFFER.....\$409
- GEMINI-15.....\$519

## C. ITOH

- Printer 30 Col. 120 CPS, Parallel.....\$395
- Printer 2.80 Col. 120 CPS, Parallel.....\$570
- Stapler F-10 40 CPS.....\$425
- Printer F-10.55 CPS.....\$1,595

## SMITH CORONA

- TP-L, 12 CPS.....\$649

## MODEMS

- Hayes 300 Baud Smart Modem.....\$219
- Hayes 1200 Baud Smart Modem.....\$515

## BUFFERS

- Quadram Microfazer
- 16K Parallel to Parallel.....\$189
- 32K Parallel to Parallel.....\$189

## MONITORS

- AMDEK Color I.....\$319
- AMDEK Color II.....\$719
- NEC JB1201 Green.....\$189

## INTERFACES

- Practical Peripherals
- Grappler Plus.....\$149
- Buffer Board 84K.....\$135

## FOR THE IBM P.C.

- NEC Spinwriter 3550..33CPS.....\$2,045
- Quadram Quadboard w/84k.....\$469
- Quadram Quadboard w/128K.....\$519
- Quadram Quadboard w/192k.....\$609
- Quadram Quadboard w/256k.....\$699
- Monte Carlo Card 84K.....\$429

## E-Z COLOR BOARD

- For the Apple II or Apple II Plus.
- Includes demo software and
- E-Z COLOR Editor.....\$199
- S-100 Systems.....\$279
- TRS-80.....\$239

## INTEX TALKER text-to-speech synthesizer.

- Serial and parallel interface included.....\$380

# DIGITAL DIMENSIONS

190 Chapel Rd., Manchester, CT 06040  
Info & Orders Call 203-649-3611  
Orders Only 1-800-243-5222

C.O.D. Welcome Allow 2-3 Weeks For Checks. MC/MSA OK.  
All Prices Include UPS Ground Freight In U.S.  
CT Residents Add 7 1/2% Sales Tax  
Prices Subject To Change Without Notice.

## Listing 1 continued:

```

E2C0 C294E2      JNE   WBOOT      ;WHY THE ENTIRE BOOT IS AN ERROR (WHY)
                  ;
                  ; NO ERROR, MOVE TO NEXT SECTOR
E2C3 E1          POP   B          ;RECALL DMA ADDRESS
E2C4 118000      LXI   D,12H      ;DMA=DMA+12H
E2C7 19          DAD   B          ;NEW DMA ADDRESS IS IN H,L
E2C8 D1          POP   D          ;RECALL SECTOR ADDRESS
E2C9 C1          POP   B          ;NUMBER OF SECTORS REMAINING, CURRENT TRK
E2CA 05          DCR   B          ;SECTORS-SECTORS-1
E2CB CAD2E2      JX     GOCPM      ;TRANSFER TO CP/M IF AID HAVI (KRN (MADR))
                  ;
E2CE 14          INR   D          ;
E2CF C3AFE2      JMP   LOAD1      ;LOAD MORE BDOS CODE
                  ;
                  ; GOCPM:
E2D2 3EC3        ; END OF LOAD OPERATION, SET PARAMETERS AND GO TO CP/M
E2D4 328000      MVI   A,0C3H     ;C3 IS A JMP INSTRUCTION
E2D7 2103E2      STA   0          ;FOR JMP TO WBOOT
E2D8 2103E2      LXI   H,WBOOT     ;WBOOT ENTRY POINT
E2DA 220100      SHLD  1          ;SET ADDRESS FIELD FOR JMP AT 0
                  ;
E2DD 320500      STA   5          ;FOR JMP TO BDOS
E2DE 2106D4      LXI   H,BDOS     ;BDOS ENTRY POINT
E2E3 220600      SHLD  6          ;ADDRESS FIELD OF JUMP AT 5 TO BDOS
                  ;
E2E6 018000      TRAP  LXI   B,80H     ;DEFAULT DMA ADDRESS IS 80H
E2E9 CD19E3      CALL  SETDMA
                  ;
E2EC 3A0400      LDA   COISK     ;GET CURRENT DISK NUMBER
E2EF 4F          MOV   C,A          ;SEND TO THE CCP
E2F0 C300CC      JMP   CCP        ;GO TO CP/M FOR FURTHER PROCESSING
                  ;
                  ;
                  ; >>>> THE FOLLOWING SIMPLE I/O ROUTINES MUST BE <<<<<
                  ; >>>> FILLED WITH THE USERS OWN SYSTEM ROUTINES <<<<<
                  ;
CONST:           ;CONSOLE STATUS, RETURN OFFH IF CHARACTER READY, 00H IF NOT
                  JMP   XCONST    ;SENT TO USER JMP VECTOR
                  ;
CONIN:          ;CONSOLE CHARACTER INTO REGISTER A
                  JMP   XCONIN    ;SEND TO USER JMP VECTOR
                  ;
CONOUT:         ;CONSOLE CHARACTER OUTPUT FROM REGISTER C
                  JMP   XCONOUT   ;SEND TO USER JMP VECTOR
E2F9 C31FE2      ;
                  ;
LIST:           ;LIST CHARACTER FROM REGISTER C
E2FC C342E2      JMP   XLIST    ;SEND TO USER JMP VECTOR
                  ;
LISTST:         ;RETURN LIST STATUS (0 IF NOT READY, 1 IF READY)
E2FF C360E2      JMP   XLISTST  ;SEND TO USER JMP VECTOR
                  ;
PUNCH:         ;PUNCH CHARACTER FROM REGISTER C
E302 C345E2      JMP   XPUNCH   ;SEND TO USER JMP VECTOR
                  ;
READER:        ;READ CHARACTER INTO REGISTER A FROM READER DEVICE
E305 C348E2      JMP   XREADR   ;SEND TO USER JMP VECTOR
                  ;
                  ;
                  ; I/O DRIVERS FOR THE DISK FOLLOW
                  ; FOR NOW, WE WILL SIMPLY STORE THE PARAMETERS AWAY FOR USE
                  ; IN THE READ AND WRITE SUBROUTINES
                  ;
NONE:          ;MOVE TO THE TRACK 00 POSITION OF CURRENT DRIVE
                  ; TRANSLATE THIS CALL INTO A SETTRK CALL WITH PARAMETER 00
E308 010000      LXI   B,0          ;SELECT TRACK 0
E30B C32AE3      JMP   SETTRK  ;WE WILL MOVE TO 00 ON FIRST READ/WRITE
                  ;
SELDSK:        ;SELECT DISK
E30E 79          MOV   A,C          ;SELECTED DISK NUMBER
E30F 3298E5      STA   SEKDSK    ;SEEK DISK NUMBER
E312 0D          DCR   C          ;LOAD ALTERNATE DRIVE
E313 B7          ORA   A          ;CHECK FOR HARD DISK
E314 C24EB2      JNE   XSELDSK   ;GO SELECT ALTERNATE DRIVE
E317 0C          INR   C          ;RESTORE HARD DISK NUMBER
E318 210000      LXI   H,0000     ;LOAD ERROR CODE
E319 FE01        CPI   NUDISK5   ;CHECK AGAINST MAX # DISKS
E31D 00          RNC          ;NO CARRY IF GREATER
E31E 6F          MOV   L,A          ;DISK NUMBER TO HL
E31P 2600        MVI   B,0          ;
                  SEPT  4          ;MULTIPLY BY 16
                  DAD   B          ;
                  ENDM
E321+29          DAD   H          ;
E322+29          DAD   H          ;
E323+29          DAD   H          ;
E324+29          DAD   H          ;
E325 1166E2      LXI   D,DPBASE   ;BASE OF PARM BLOCK
E328 19          DAD   D          ;BL=-DPB(CURDSK)
E329 C9          RET
                  ;
SETTRK:        ;SET TRACK GIVEN BY REGISTERS BC
E32A 80          MOV   H,B          ;
E32B 69          MOV   L,C          ;
E32C 229CE5      SHLD  SEKTRK    ;TRACK TO SEEK
                  ;
                  ;
                  ; >>>> ENTER YOUR SYSTEM SET TRACK ROUTINE HERE <<<<<
E2B1 E5          PUSH  B          ;SAVE DMA ADDRESS
E2B2 4A          MOV   C,D          ;GET SECTOR ADDRESS TO REGISTER C
E2B3 CD32E3      CALL  SETSEC    ;SET SECTOR ADDRESS FROM REGISTER C
    
```

# It's True — We Did It!

We have met or have beaten most advertised prices.

Don't be foolish. Buy Direct!



## NORTHSTAR

### ADVANTAGE

### HORIZON

- Multi User System
  - Z80A Operating System
  - S-100 Bus
  - 5Mb-18Mb Hard Disc Available
- Super Super Super \$2,495.00

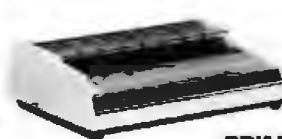
- 64K, Z80A Operating System
  - 2 Quad Capacity Floppy Drives
  - Business Graphics Software
  - 12" Green Phosphorus Screen
  - Bit Mapped Graphics
  - 6 I/O Business Slots
- Super Super Super \$2,619.00



## IDS

- Proportional Spacing
- 200 CPS Bi Directional
- Sheet Feed
- 8 Character Styles
- Color Optional
- Graphics

Prism 80 W/Sprint \$899.00  
 Prism 80 Loaded W/Color \$1,239.00  
 Prism 132 W/Sprint \$1,039.00  
 Prism 132 Loaded W/Color \$1,395.00



## PRINTEK

- Dot Graphics 144x144
- Correspondence Quality
- 8 Character Pitches
- 1 Year Warranty
- 8 Foreign Character Sets
- Serial Interface Standard

Model 910 200 Cps \$1,329.00  
 Model 920 340 Cps \$1,889.00



ALTOS  
 ZENITH  
 TELEVIDEO  
 SANYO

FRANKLIN  
 HAYES  
 NOVATION  
 UDS

OMNITEC  
 VENTEL  
 AMDEK  
 BMC

TAXAN  
 DIABLO  
 NEC  
 EPSON

OKIDATA  
 OSBORNE  
 COMREX  
 DAISYWRITER

GTC  
 ADDS  
 DEC  
 MANY OTHERS

For FREE Information and Price Quotes Call:

# 1-800-328-8905

In Arizona Call:  
 602-941-3191

411 South Madison  
 Tempe, Arizona 85256  
 (Mail Order Only)

## LIBERTY COMPUTER SALES



Everything In  
 computer related  
 products:

- Computers
- Modems
- Printers
- Software
- Monitors
- Terminals
- Accessories
- Paper
- Ribbons
- Diskettes
- Office Furniture

Prices listed reflect a cash discount and are subject to change without notice. We welcome Certified and Cashiers Checks, Bank Wires and Money Orders. Allow 2 to 3 weeks for personal checks to clear. No C O D's. Product is subject to availability. Equipment is in factory sealed boxes with manufacturer's warranty. There will be a restocking charge for returned merchandise. Call first for an RMA number. Software not warranted for suitability. No return of Software which has been opened. Add 2% for shipping charges (minimum \$2.50). Z80A is a registered trademark of Zilog, Inc.



# HOT PRICES!

## COMPUTERS

K-Pro w/ software ..... **\$1649**  
 Superbrain Jr. S/S, D/D. .... **\$1875**  
 Superbrain QD. D/S, D/D ..... **\$2250**  
 Franklin Ace 1000. .... **\$1049**  
 NEC A.P.C. .... **Call**

## DISK DRIVES

Tandon 100-2 (IBM) ..... **\$269**  
 Apple Compatible w/cabinet. .... **\$239**  
 Corona 10MB/IBM HD ..... **\$1799**  
 Corona 5MB HD ..... **\$1719**

## MONITORS

NEC JB1201 HI Res Green. .... **\$169**  
 BMC Green 12" ..... **\$85**  
 Princeton Graphics R6B ..... **\$629**  
 Taxan I R6B. .... **\$315**  
 Amdek Amber ..... **\$159**

## PRINTERS

Gemini 10 100cps. .... **\$359**  
 Gemini 15 100cps ..... **\$519**  
 Okidata 92. 160cps ..... **\$529**  
 NEC 771D, 7730 ..... **\$2190**  
 IDS Prism 132. .... **\$1179**  
 Daisywriter ..... **\$1099**  
 Brother HR-1 ..... **\$829**  
 Other Brands ..... **Call**

## EXPANSION PRODUCTS

AST Boards 64k, Ser, Par, clock **\$389**  
 Mountain Computer ..... **Call**  
 Practical Peripherals ..... **Call**  
 Micro Soft ..... **Call**

## MODEMS

Hayes Smartmodem ..... **\$219**  
 Hayes 1200 baud modem ..... **\$529**

**ORDERS ONLY 1-800-531-3133**  
 INFORMATION: (206) 641-7233  
 Mail & Phone Orders Only.  
 Prices reflect 3% cash discount.  
 Sorry, no COD's.

# PACIFIC COMPUTERS

13256 Northup Way #7  
 Bellevue, WA 98005


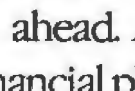
### Listing 1 continued:


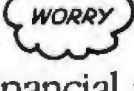
```



E286 C1          POP      B          ;RECALL DMA ADDRESS TO B,C
E287 C5          PUSH     B          ;REPLACE ON STACK FOR LATER RECALL
E288 CD39E3     CALL     SETDMA      ;SET DMA ADDRESS FROM B,C
;
;
; DRIVE SET TO 0, TRACK SET, SECTOR SET, DMA ADDRESS SET
E28B CD4BE3     CALL     READ        ;GET DISK NUMBER
E28E FE00       CPI      00H        ;ANY ERRORS?
;
;MAYBE THIS CALL IS FOR ANOTHER DRIVE
;BETTER GO SET THE TRACK NUMBER
E32F C351E2     JMP      XSETRK
;
;SETSEC:
E332 79         MOV      A,C          ;SET SECTOR GIVEN BY REGISTER C
E333 329EE5     STA     SEKSEC       ;SECTOR TO SEEK
;
;
; >>>> PLACE YOUR SYSTEM SET SECTOR ROUTINE HERE. <<<<<
;
;MAYBE THIS CALL IS FOR ANOTHER DRIVE
;BETTER GO SET THE SECTOR NUMBER
E336 C354E2     JMP      XSTSEC
;
;SETDMA:
E339 60         MOV      H,B          ;SET DMA ADDRESS GIVEN BY BC
E33A 69         MOV      L,C          ;GET DISK NUMBER
E33B 23B3E5     SHLD   DMAADR        ;LOAD DMA ADDRESS
;
;
; >>>> PLACE YOUR SYSTEM SET DMA ROUTINE HERE. <<<<<
;
;MAYBE THIS CALL IS FOR ANOTHER DRIVE
;BETTER GO SET THE DMA ADDRESS
E33E C357E2     JMP      XSTDMA
;
;SECTRAM:
E341 3A9BE5     LDA     SEKDSK       ;TRANSLATE SECTOR NUMBER BC
E344 B7         ORA     A             ;CHECK FOR HARD DISK
;
;
; >>>> CHANGE THE FOLLOWING JMP XSECTRN CODE TO JUMP TO <<<<<
; >>>> YOUR SYSTEM SECTOR TRANSLATION ROUTINE. <<<<<
;
E345 C263E2     JNZ    XSECTRN      ;TRANSLATE OTHER SECTOR NUMBER
E348 60         MOV      H,B
E349 69         MOV      L,C
E34A C9         RET
;
;
;*****
;*
;* THE READ ENTRY POINT TAKES THE PLACE OF
;* THE PREVIOUS BIOS DEFINITION FOR READ.
;*
;*****
;READ:
E34B 3A9BE5     LDA     SEKDSK       ;READ THE SELECTED CP/M SECTOR
E34E B7         ORA     A             ;CHECK FOR HARD DISK A:
;
;
; >>>> CHANGE THE FOLLOWING JMP XREAD TO JUMP TO YOUR <<<<<
; >>>> SYSTEM READ ROUTINE. <<<<<
;
E34F C25AE2     JNZ    XREAD        ;READ ALTERNATE DISK
E352 AF         XRA     A
E353 32A6E5     STA     UNACNT
E356 3E01       MVI     A,1
E358 32B1E5     STA     READOP      ;READ OPERATION
E35B 32B0E5     STA     RSFLAG      ;MUST READ DATA
E35E 3E02       MVI     A,WRUAL
E360 32B2E5     STA     WRTYPE      ;TREAT AS UNALLOC
E363 C3D8E3     JMP     RWOPER      ;TO PERFORM THE READ
;
;
;*****
;*
;* THE WRITE ENTRY POINT TAKES THE PLACE OF
;* THE PREVIOUS BIOS DEFINITION FOR WRITE.
;*
;*****
;WRITE:
E366 3A9BE5     LDA     SEKDSK       ;WRITE THE SELECTED CP/M SECTOR
E369 B7         ORA     A             ;CHECK FOR HARD DISK A:
;
;
; >>>> CHANGE THE FOLLOWING JMP XWRITE CODE TO JUMP TO <<<<<
; >>>> YOUR SYSTEM WRITE ROUTINE. <<<<<
;
E36A C25DE2     JNZ    XWRITE       ;WRITE ALTERNATE DISK
E36D AF         XRA     A            ;0 TO ACCUMULATOR
E36E 32B1E5     STA     READOP      ;NOT A READ OPERATION
E371 79         MOV      A,C          ;WRITE TYPE IN C
E372 32B1E5     STA     WRTYPE
E375 FE02       CPI      02H        ;WRITE UNALLOCATED?
E377 C291E3     JNZ    CHKUNA       ;CHECK FOR UNALLOC
;
;
; WRITE TO UNALLOCATED, SET PARAMETERS
E37A 3E10       MVI     A,BLKSI2/128 ;NEXT UNALLOC RECS
E37C 32A6E5     STA     UNACNT
E37F 3A9BE5     LDA     SEKDSK       ;DISK TO SEEK
E382 32A7E5     STA     UNADSK      ;UNADSK = SEKDSK
E385 2A9CE5     LHL    SEKTRK
E388 22A8E5     SHLD   UNATRK       ;UNATRK = SEKTRK
E38B 3A9EE5     LDA     SEKSEC
E38E 32AAE5     STA     UNASEC      ;UNASEC = SEKSEC
;
;
;CHKUNA:
    
```



# TAKE A LOAD OFF YOUR MIND WITH A FREE FINANCIAL PLANNING GUIDE FROM IDS.

Financial worries can spoil your appetite in a lot of ways. Interest rates fluctuate, tax laws change and inflation hasn't disappeared. Banks, brokers and insurance companies all seem to give conflicting advice. It's confusing. What you need is a carefully thought-out,  completely objective plan that's flexible enough to work in the years  ahead. And that's where IDS comes in. We're offering you a free guide to financial planning that explains what a financial plan is and how it can diminish your money worries.

An IDS representative can help you  develop a personal financial plan to achieve your financial goals. You'll be  talking to a career professional who understands the importance of financial planning. Someone who will regularly review your progress.

And because  IDS offers over 50 different financial products and services, you'll get timely  ideas to help you reach your goals.

Begin taking a load off your mind.  
Send for your free 24-page guide  
to personal financial planning.  
Or call toll-free 1-800-437-4332.



Yes, see that I receive my free 24-page guide to personal financial planning.

Name \_\_\_\_\_

Address \_\_\_\_\_

City \_\_\_\_\_ State \_\_\_\_\_ Zip \_\_\_\_\_

Mail to: IDS, Dept. 583, IDS Tower, Minneapolis,  
MN 55402. Or call toll-free 1-800-IDS-IDEA,  
that's 1-800-437-4332.

60-52-382-191-001-C





# Main/Frames

# Main/Frames

from  
**\$200**

- 30 Models of Enclosures
- Assembled and tested
- Quasi-Coax Motherboards
- Power Supply
- Card cage and guides
- Fan, line, cord, fuse, power & reset switches



8" Floppy Main/Frame  
**\$482**



8" Disc Enclosure  
**\$250**



Phase/80 8" Floppy Mainframe  
**\$525**



Phase/80 Desk + Mainframe  
**\$900**

Write or call for our brochure which includes our application note:  
"Building Computers — A Recipe"

## INTEGRAND

8620 Roosevelt Ave. • Visalia, CA 93291  
209/651-1203

We accept BankAmericard/Visa and MasterCard

Listing 1 continued:

```

E391 3AA6E5 ;CHECK FOR WRITE TO UNALLOCATED SECTOR
E394 B7 LDA UNACNT ;ANY UNALLOC REMAIN?
E395 CADDE3 ORA A
JZ ALLOC ;SKIP IF NOT

;
; MORE UNALLOCATED RECORDS REMAIN
E398 3D DCR A ;UNACNT = UNACNT-1
E399 32A6E5 STA UNACNT
E39C 3A9BE5 LDA SENDSK ;SAME DISK?
E39P 21A7E5 LXI H,UNADSK
E3A2 BE CMP M ;SEKDSK = UNADSK?
E3AJ C2D0E3 JNZ ALLOC ;SKIP IF NOT

;
; DISKS ARE THE SAME
E3A6 21A8E5 LXI H,UNATRK
E3A9 CD73E4 CALL SEKTRKCMF ;SEKTRK = UNATRK?
E3AC C2D0E3 JNZ ALLOC ;SKIP IF NOT

;
; TRACKS ARE THE SAME
E3AF 3A9EE5 LDA SEKSEK ;SAME SECTOR?
E3B2 21AAE5 LXI H,UNASEC
E3B5 BE CMP M ;SEKSEC = UNASEC?
E3B6 C2D0E3 JNZ ALLOC ;SKIP IF NOT

;
; MATCH, MOVE TO NEXT SECTOR FOR FUTURE REF
E3B9 34 INR M ;UNASEC = UNASEC+1
E3BA 7E MOV A,M ;END OF TRACK?
E3BB PE40 CPI CPNSET ;COUNT CP/M SECTORS
E3BD DAC9E3 JC NOOVF ;SKIP IF NO OVERFLOW

;
; OVERFLOW TO NEXT TRACK
E3C0 3600 MVI M,D ;UNASEC = 0
E3C2 2AA8E5 LHLD UNATRK
E3C5 23 INX H
E3C6 22A8E5 SHLD UNATRK ;UNATRK = UNATRK+1

;
; NOOVF:
E3C9 AF ;MATCH FOUND, MARK AS UNNECESSARY READ
E3CA 32B0E5 XRA A ;0 TO ACCUMULATOR
E3CD C3D8E3 STA RSFLAG ;RSFLAG = 0
JMP ROPER ;TO PERFORM THE WRITE

;
; ALLOC:
E3D0 AF ;NOT AN UNALLOCATED RECORD, REQUIRES PRE-READ
E3D1 32A6E5 XRA A ;0 TO ACCUM
E3D4 3C STA UNACNT ;UNACNT = 0
E3D5 32B0E5 INR A ;1 TO ACCUM
STA RSFLAG ;RSFLAG = 1

;
; *****
; * COMMON CODE FOR READ AND WRITE FOLLOWS *
; * *****
;
; ROPER:
E3D8 AF ;ENTER HERE TO PERFORM THE READ/WRITE
E3D9 32AFE5 XRA A ;ZERO TO ACCUM
E3DC 3A9EE5 STA ERFLAG ;NO ERRORS (YET)
LDA SEKSEK ;COMPUTE HOST SECTOR
REPT SECSEK
ORA A ;CARRY = 0
RAR ;SHIFT RIGHT
ENDM
ORA A ;CARRY = 0
RAR ;SHIFT RIGHT
STA SEKHST ;HOST SECTOR TO SEEK

;
; ACTIVE HOST SECTOR?
E3E4 21A4E5 LXI H,HSTACT ;HOST ACTIVE FLAG
E3E7 7E MOV A,M
E3E8 3601 MVI M,1 ;ALWAYS BECOMES 1
E3EA B7 ORA A ;WAS IT ALREADY?
E3EB CA12E4 JZ FILHST ;FILL HOST IF NOT

;
; HOST BUFFER ACTIVE, SAME AS SEEK DUFFER?
E3EE 3A9BE5 LDA SEKDSK
E3F1 219PE5 LXI H,HSTDISK ;SAME DISK?
E3F4 BE CMP M ;SEKDSK = HSTDISK?
E3F5 C2D0E4 JNZ NOMATCH

;
; SAME DISK, SAME TRACK?
E3FB 21A0E5 LXI H,HSTTRK
E3FD CD73E4 CALL SEKTRKCMF ;SEKTRK = HSTTRK?
E3FE C2D0E4 JNZ NOMATCH

;
; SAME DISK, SAME TRACK, SAME BUFFER?
E401 3AA3E5 LDA SEKHST
E404 21A2E5 LXI H,HSTSEC ;SEKHST = HSTSEC?
E407 BE CMP M
E408 CA2FE4 JZ MATCH ;SKIP IF MATCH

;
; NOMATCH:
E40B 3AA5E5 LDA HSTWRT ;PROPER DISK, BUT NOT CORRECT SECTOR
E40E B7 ORA A ;HOST WRITTEN?
E40F C47FE4 CNZ WRITERST ;CLEAR HOST BUFF

;
; FILHST:
E412 3A9BE5 LDA SEKDSK
E415 329PE5 STA HSTDISK
E418 2A9CE5 LHLD SEKTRK
E41B 22A0E5 SHLD HSTTRK
E41E 3AA3E5 LDA SEKHST
E421 32A2E5 STA HSTSEC
    
```

# Our Prices Will Get Your Attention. Our Service Will Keep It.

ORDER NO. DESCRIPTION LIST A/E PRICE ORDER NO. DESCRIPTION LIST A/E PRICE ORDER NO. DESCRIPTION LIST A/E PRICE

## FRANKLIN

Franklin ACE 1000 ..... 1330 Call

## TELEVIDEO SYSTEMS

TS-802 Integrated Single User Computer ..... 3295 2632  
 TS-802H Integrated Hard Disk Computer ..... 5995 Call  
 TS-803 Computer ..... Call  
 TS-1602G 16 Bit 802 Type Computer ..... 4495 Call  
 TS-1602GH 16 Bit 802H Type Computer ..... 6995 Call  
 TS-806-20 Multi-User Computer ..... 7195 Call  
 TS-816 Multi-User Computer ..... 8995 Call  
 TV-910-P Televideo 910 Plus ..... 699 573  
 TV-910 Televideo 910 ..... 699 573  
 TV-912 Televideo 912C ..... 925 685  
 TV-920 Televideo 920C ..... 995 737  
 TV-925 Televideo 925 ..... 995 745  
 TV-950 Televideo 950 ..... 1195 921  
 TV-970 Televideo 970 ..... Call  
 TV-9010 Second Page Option 912/920 ..... 80 50  
 TV-9051 One Additional Page for 925/950 ..... 95 62  
 TV-MM Three Additional Pages for 950 ..... 120 95  
 TS-24-001 For Any Televideo Terminal TeleSolutions WardStar - CalcStar ..... 790 Call  
 TS-1W 20 MB Expansion for TS-806 Telewriter - NEC 3500 ..... 2948 1629

## NORTHSTAR

NS-94404 Adv-262-64K Computer .. 3599 Call  
 NS-97404 Adv-1G-64K-HD-5 Computer ..... 4999 Call  
 NS-94401 Hz-2G-64K Horizon ..... 3599 Call  
 NS-97401 Hz-1G-64K-HD-5MB ..... 4999 Call  
 PLUS OTHER NORTH-STAR PRODUCTS

## ZENITH

ZVM-121 Green Screen Monitor .. 160 99  
 Z-19-CN Z-19 Terminal ..... 895 672  
 ZI-1-A Auto-Dial Terminal ..... 699 526  
 Z-25-AA Z-25 Dot Matrix Printer ..... 1499 1198  
 Z-89-B1 Z-89 Computer System ..... 1995 Call  
 Z-90-B2 Z-90 Computer System .. 2799 2176  
 Z-89-X Z-89 w/o Integral Drive .. 2495 1749  
 Z-90-B0 Z-90 w/o Integral Drive .. 2895 1950  
 Z-37 Z-37 Dual 5" Disk Drives .. 1995 1593  
 Z-87-89 Z87 Dual 5" Disk Drives .. 999 898  
 Z-87-90 Same Disk add 400K to Z-90 ..... 999 898  
 ZS-67 Z-67 Winchester - Floppy Drive ..... 5995 4747  
 Z-47-DA Z47 Dual 8" Disk Drives .. 3495 Call

## NEC PRINTERS

NE-3510-1 NEC 3510 Spinwriter R/O Serial 35 CPS ..... 1895 Call  
 NE-3515-1 NEC 3515 Spinwriter R/O Serial Diablo Compatible ..... 1925 Call  
 NE-3530-1 NEC 3530 Spinwriter ..... 1995 Call  
 NE-3550-1 NEC 3550 Spinwriter R/O Parallel IBM Compatible ..... 2350 Call  
 NE-35-TRAC Bi-directional Tractor ..... 265 Call  
 NE-7710-1 NEC 7710 Spinwriter R/O Serial 55 CPS ..... 2795 Call  
 NE-7715-1 NEC 7715 Spinwriter R/O Serial Diablo Comp. .... 2825 Call  
 NE-7720-1 NEC 7720 Spinwriter KSR Serial 55 CPS ..... 3610 Call  
 NE-7725-1 NEC 7725 Spinwriter KSR Serial Diablo Comp. .... 3710 Call  
 NE-7730-1 NEC 7730 Spinwriter ..... 2795 Call  
 NE-PC-8023 Parallel ..... 695 Call  
 PLUS OTHER ACCESSORIES

## STAR MICRONICS

DP-8480-TP 80 Column Dot Matrix Printer - Parallel ..... 449 Call  
 DP-8480-IS 80 Column Dot Matrix Printer - Serial ..... 464 Call  
 Gemini-10 10" Carriage - Parallel ..... 309 Call  
 Gemini-15 15" Carriage - Parallel ..... 649 Call  
 Serial Interface Card ..... 85 Call  
 DP-8240 40 Column Dot Matrix - Parallel or Serial ..... 250 Call

## OKIDATA

OK-82A Okidata Microline 82A with Tractor Feed ..... 719 486  
 OK-83A Okidata Microline 83A .. 1195 713  
 OK-84A-P Okidata Microline 84A - Parallel ..... 1395 Call  
 OK-84A-S Okidata Microline 84A - Serial ..... 1495 Call  
 OK-G-82 Okigraph I for 82A ..... 99 45  
 OK-G-83 Okigraph I for 83A ..... 99 45  
 OK-2K 2K Buffer/Serial 80 all Models ..... 140 119

## MANNESMANN TALLY

MT1605 Serial 200 CPS ..... 1695 1441  
 MT1602 Parallel 200 CPS ..... 1695 1441  
 MT1805 Serial - 200 CPS or 50 CPS ..... 1995 Call  
 MT1802 Parallel - 200 CPS or 50 CPS ..... 1995 Call  
 MT160L 5 or P - 160 CPS ..... 990 809

PLUS: MORROW • ALTOS • EAGLE • NEC PERSONAL • ANADEX • C-ITOH • DIABLO • COMREX • TOSHIBA  
 ALSO AVAILABLE: MODEMS • DISKETTE STORAGE BOXES • DISKETTES • CLIPSTRIP • RIBBONS

## SYSTEM SOFTWARE AVAILABLE

Altos CP/M 5 1/4" .....  
 Apple DOS - Cassette .....  
 Apple DOS - Diskette .....  
 Atari 400/800 Diskette .....  
 Atari Cartridge .....  
 Atari Cassette .....  
 Basic 4 CP/M 5 1/4" .....  
 CP/M-86 Display Writer .....  
 Cromemco CP/M 5 1/4" .....  
 DEC V1-180 CP/M 5 1/4" .....  
 Eagle CP/M 5 1/4" .....  
 Heath Z-90 CP/M 5 1/4" .....  
 Heath Zenith CP/M 5 1/4" .....  
 Hewlett Packard 125 CP/M 5 1/4" .....  
 Hewlett Packard 87 CP/M 5 1/4" .....  
 IBM PC CP/M 86 .....  
 IBM PC DOS .....  
 NEC CP/M 5 1/4" .....  
 Northstar Advantage CP/M 5 1/4" .....  
 Northstar Horizon CP/M 5 1/4" .....  
 Ohio Scientific C-3 CP/M 5 1/4" .....  
 Osborne CP/M 5 1/4" .....  
 Oriona CP/M 5 1/4" .....  
 QD-Micropolis Mod II/Vector Graphic .....  
 Sonyo 1000 CP/M 5 1/4" .....  
 Strius Victor 5 1/4" .....  
 Software for 8086 Computers .....  
 Standard CP/M 8" .....  
 Superbrain 5 1/4" .....  
 TImex/SInclair ZX81 .....  
 TRS-80 Cassette Models I & II .....  
 TRS-80 Diskette Models I & II .....  
 TRS-80 Model II CP/M .....  
 Televideo CP/M 5 1/4" .....  
 Vic 20 .....  
 Wang CP/M 5 1/4" 8" .....  
 Xerox 820 CP/M 5 1/4" .....

CALL FOR CURRENT PRICING

NEW ITEMS  
 Polonix Word Processor w/Multitap ... 450 Call  
 For use with Apple II (64K) CPM.... 350 Call

## MAY SPECIAL

TELEVIDEO™ 910  
 TERMINAL

ONLY \$555<sup>00</sup>

- 4 Switchable Emulations
- 4 Strappable Languages
- Up to 19.2 baud
- 8 x 10 character set

These prices prepared 3/83

Prices change daily — call for current pricing and shipping charges.



CALL TOLL FREE:

800-854-7635

IN CALIFORNIA CALL:  
 (619) 562-7571

**AUTOMATED EQUIPMENT, INC.**

8775 Olive Lane, Suites I & J • Sanjee, CA 92071



## GUARANTEE

- PROVEN PRODUCTS
- SYSTEM DESIGN HELP
- BENCH TESTING AND CONFIGURING
- TECHNICAL SUPPORT STAFF
- SERVICE AFTER SALE:

(800) 854-7635 TECHNICAL SERVICE SUPPORT  
 We will pay the freight — both ways — for repair on verified returns within 30 days of sale.

### TERMS AND CONDITIONS

Prices change daily. Call for current pricing and availability. Prices based on prepaid cash orders. We accept cashiers checks, money orders, bank wires, or personal checks (10 days to order). C.O.D. — standard charges plus 2% handling for orders outside California. MasterCard & Visa — 5% handling. California residents add state and local sales tax.



NO LIMIT **Epson** NO LIMIT  
**Giveaway**

Epson MX70/80 Cartridges

**\$500 EACH**

Min. 3 of same color

Reloads \$2.50 each Min. 12  
\$30.00 a Doz. of Same Color

Cartridges and Reloads Available  
in Black, Red, Green, Blue, Brown



B.T. Enterprises  
Dept. 15C  
108 Carlough Rd.  
Bohemia, N.Y. 11716

Order Toll Free 1-800-445-1165 NYS Orders Call 516-587-4565

Prices Subject to Change

NYS Residents Add Tax Add \$2.00 Shipping & Handling  
© 1987 Enterprises is a division of Bi-Tech Enterprises Inc.

Circle 74 on inquiry card.

**ELIZA IS HERE!**

AT LAST! A FULL IMPLEMENTATION of the original ELIZA program is now available to run on your microcomputer.

Created at MIT in 1966, ELIZA has become the world's most celebrated artificial intelligence demonstration program. ELIZA is a non-directive psychotherapist who analyzes each statement as you type it in and then responds with her own comment or question — and her remarks are often startlingly appropriate!

Designed to run on a large mainframe, ELIZA has hitherto been unavailable to personal computer users except in greatly stripped down versions lacking the sophistication which made the original program so fascinating.

Now, our new microcomputer version possessing the FULL power and range of expression of the original is being offered at the introductory price of only \$25. And if you want to find out how she does it (or teach her to do more), we will include the complete Source Program for only \$50 additional!

Order your copy of ELIZA today and you'll never again wonder how to respond when you hear someone say "Okay, let's see what this computer of yours can actually do!"

ELIZA IS AVAILABLE IN THE FOLLOWING DISK FORMATS:

- 1 Standard 5 1/4 inch single density for all CP/M based computers \$25 for ELIZA COM - add \$20 for Microsoft BASIC-80 Source
- 2 5 1/4 inch CP/M for Apple II equipped with 2-80 SoftCard \$25 for ELIZA COM - add \$20 for Microsoft BASIC-80 Source
- 3 5 1/4 inch for IBM Apple II with AppleSoft ROM and DOS 3.3 \$25 for Protected Flo - add \$30 for AppleSoft Source
- 4 5 1/4 inch for IBM Personal Computer \$25 for Protected Flo - add \$30 for IBM Disk BASIC Source
- 5 5 1/4 inch for Osborne I Microcomputer \$25 for Protected Flo - add \$30 for Microsoft BASIC-80 Source

ARTIFICIAL INTELLIGENCE RESEARCH GROUP

821 NORTH LA JOLLA AVENUE  
LOS ANGELES, CALIFORNIA 90048  
(213) 696-7288 (213) 884-2214  
MC, VISA and CHECKS ACCEPTED

Circle 48 on inquiry card.

**5 1/4" Floppy Disk Drives**

(Direct IBM® Plug-in)

TANDON Model TM 100-1 \$189\* ea.

TANDON Model TM 100-2 \$249\* ea.

12" Green Phosphor Zenith Monitor \$109\* ea.

**IBM EXPANSION  
BOARDS**

64K Memory ..... \$275\* ea.

128K Memory ..... \$375\* ea.

192K Memory ..... \$450\* ea.

256K Memory ..... \$510\* ea.

Floppy Controller ..... \$180\* ea.

16K System BD Memory . \$ 25\* ea.

MC / VISA or C.O.D. with certified check  
or money order. Arkansas residents add  
sales tax.

For information or orders, call  
**501-777-9859**

G-H Computer Systems, Inc.  
P.O. Box 871 • Hope, AR 71801

\* Plus Shipping

Circle 203 on inquiry card.

Listing 1 continued:

```
E424 3AB0E5 LDA R8FLAG ;NEED TO READ?
E427 B7 ORA A
E428 C487E4 CNZ A READHST ;YES, IF 1
E42B AF XRA A ;0 TO ACCUM
E42C 32A5E5 STA HSTWRT ;NO PENDING WRITE
```

? MATCH:

```
E42F 3A9EE5 ;COPY DATA TO OR FROM BUFFER
E432 E601 LDA BEXSEC ;MASK BUFFER NUMBER
E434 6F ANI SECMSK ;LEAST SIGNIF BITS
E435 2600 MOV L,A ;READY TO SHIFT
MVI B,0 ;DOUBLE COUNT
REPT 7 ;SHIFT LEFT 7
DAD H
```

```
E437+29 DAD H
E438+29 DAD H
E439+29 DAD H
E43A+29 DAD H
E43B+29 DAD H
E43C+29 DAD H
E43D+29 DAD H
```

```
? HL HAS RELATIVE HOST BUFFER ADDRESS
E43E 11B5E5 LXI D,HSTBUF
E441 19 DAD D ;HL = HOST ADDRESS
E442 2B XCHG ;NOW IN DE
E443 2AB3E5 LHLD DMAADR ;GET/PUT CP/M DATA
E446 E080 MVI C,128 ;LENGTH OF MOVE
E448 3AB1E5 LDA READOP ;WHICH WAY?
E44B B7 ORA A
E44C C255E4 JNZ RMWVE ;SKIP IF READ
```

```
? WRITE OPERATION, MARK AND SWITCH DIRECTION
E44F 3E01 MVI A,1
E451 32A5E5 STA HSTWRT ;HSTWRT = 1
E454 EB XCHG ;SOURCE/DEST SWAP
```

? RMWVE:

```
? C INITIALLY 128, DE IS SOURCE, HL IS DEST
E455 1A LDAX D ;SOURCE CHARACTER
E456 13 INX D
E457 77 MOV M,A ;TO DEST
E458 23 INX H
E459 0D DCR C ;LOOP 128 TIMES
E45A C255E4 JNZ RMWVE
```

```
? DATA HAS BEEN MOVED TO/FROM HOST BUFFER
E45D 3AB2E5 LDA WRTYPE ;WRITE TYPE
E460 FE01 CPI WRDIR ;TO DIRECTORY?
E462 3AAPF5 LDA ERFLAG ;IN CASE OF ERRORS
E465 C0 RNZ ;NO FURTHER PROCESSING
```

```
? CLEAR HOST BUFFER FOR DIRECTORY WRITE
E466 B7 ORA A ;ERRORS?
E467 C0 RNE ;SKIP IF 50
E468 AF XRA A ;0 TO ACCUM
E469 32A5E5 STA HSTWRT ;BUFFER WRITTEN
E46C CD7FE4 CALL WRITEST
E46F 3AAPF5 LDA ERFLAG
E472 C9 RET
```

UTILITY SUBROUTINE FOR 16-BIT COMPARE

SENTRKCM:

```
E473 EB ;HL = .UNATRK OR .HSTTRK, COMPARE WITH SENTRK
E474 219CE5 XCHG
E477 1A LXI H,SENTRK
E478 BE LDAX D ;LOW BYTE COMPARE
E479 C0 CMP M ;SAME?
RNE ;RETURN IF NOT
```

```
? LOW BYTES EQUAL, TEST HIGH IS
E47A 13 INX D
E47B 23 INX H
E47C 1A LDAX D
E47D BE CMP M ;SETS FLAGS
E47E C9 RET
```

WRITEST PERFORMS THE PHYSICAL WRITE TO  
THE HOST DISK, READHST READS THE PHYSICAL  
DISK.

WRITEST:

```
;HSTDSK = HOST DISK #, HSTTRK = HOST TRACK #,  
;HSTSEC = HOST SECT #. WRITE "HSTSI2" BYTES  
;FROM HSTBUF AND RETURN ERROR FLAG IN ERFLAG.  
;RETURN ERFLAG NON-ZERO IF ERROR
E47F 3E0A MVI A,WRTCMD ;LOAD WRITE COMMAND
E481 C08FE4 CALL COMCODE ;SEND COMMAND TO CONTROLLER
```

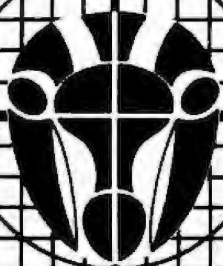
WRTBUF:

```
;THIS LOOP SENDS BUFFER TO CONTROLLER  
E484 C3CE4 JMP OUTLOOP ;SEND OUT THE BUFFER
```

? READHST:

```
;HSTDSK = HOST DISK #, HSTTRK = HOST TRACK #,  
;HSTSEC = HOST SECT #. READ "HSTSI2" BYTES  
;INTO HSTBUF AND RETURN ERROR FLAG IN ERFLAG.
```

Listing 1 continued on page 398



# Oryx systems inc.

## QUALITY DISCOUNTS

for a complete selection of microcomputer hardware, software and accessories.

### Apple/Franklin

Hayes Smartmodem, Serial Card, Dow Jones Analyzer — or — Micromodem & Dow Jones Analyzer Reg 779 . . . NOW \$ 619

**ASHTON-TATE**  
D-Base II . . . \$ 450

**ASPEN SOFTWARE**  
Grammatik . . . \$ 60  
Proofreader . . . 42

**CONDOR III Data Base** \$455

**CONTINENTAL SOFTWARE**  
Home Accountant . . . \$ 65

**CHARLES MANN**  
Basic Teacher . . . \$ 30  
Teacher Plus . . . 32  
Medical II . . . 879

**CDEX**  
\*Visicalc Training . . . \$ 45

**DENVER SOFTWARE**  
\*Easy (Exec. Alt'g) . . . \$ 535  
Financial Partner . . . 188  
Pascal Tutor . . . 97  
Pascal Programmer . . . 220

**DOW JONES**  
Market Analyzer . . . \$ 279  
Market Manager . . . 240  
Microscope . . . 569

**HOWARD SOFTWARE**  
Real Estate Analyzer . . . \$ 145  
Tax Preparer '83 . . . 175

**KRELL CO. Logo** . . . \$ 75

**LINK SYSTEMS**  
Datafax . . . \$Call  
DataLink . . . 79

**MICROPRO**  
WordStar (Reg. CP/M) . . . \$Call  
Mailmerge . . . 149  
CalcStar . . . 99  
SpellStar . . . 149  
SuperSort . . . 149  
Word Pak (Special) . . . 299

**MICROSOFT**  
Basic Compiler . . . \$ 295  
Cobol 80 . . . 550  
Fortran-80 . . . 155  
Time Manager . . . 125  
TASC Compiler . . . 135  
A.L.D.S. . . . 99  
Multiplan (DOS) . . . 215

**OMEGA**  
Locksmith . . . \$ 79  
Inspector . . . 47  
Watson . . . 44

**PEACHTREE**  
Peachpak 40 G/L + A/R + A/P (Special) . . . \$ 359  
Series 40  
G/L, A/R, A/P ea . . . 225  
Inventory . . . 225  
Series 9  
Peachcalc . . . 279  
Telecommunications . . . 279

**PENGUIN SOFTWARE**  
Complete Graphics . . . \$ 57  
Graphics Magician . . . 48

**TERRAPIN Logo** . . . \$ 135

**VISICORP**  
Visicalc . . . \$ 185  
Visischedule . . . 219

**MISC.**  
ISM Mathemagic . . . \$ 80  
ISA Spellguard . . . 199  
LJK Edit 6502 . . . 82  
On-Line Screen Writer II . . . 95  
PFS: Filing, Report or Graph . . . 112

### CP/M

**ASHTON-TATE**  
\*D-Base II . . . \$ 450

**SOFTWAREBANC**  
D-Base User's Guide  
w/ D-Base Purchase . . . \$ 15  
w/ D-Base Purchase . . . 20

**COMPUVIEW**  
V-Edit 8080 Z80, IBM PCs 130  
V-Edit CP/M86, MS DOS 165

**DIGITAL RESEARCH**  
Pascal M1 + W/SP . . . \$ 389  
MAC . . . 85  
SID (8080 Debugger) . . . 65  
ZSID (Z80 Debugger) . . . 90  
CP/M 2.2 - DD . . . 170  
C Basic 2 . . . 125  
PL/1-80 . . . 439

**FOX AND GELLER**  
Quick Screen . . . \$ 125  
Quick Code . . . 222  
D-Ull . . . 89

**MARK OF UNICORN**  
\*Final Word . . . \$ 245

**MICROPRO**  
\*WordStar . . . \$Call  
\*MailMerge . . . 149  
\*CalcStar . . . 99  
\*SpellStar . . . 149  
\*SuperSort . . . 99  
\*InfoStar . . . 250  
3-Pack . . . 399  
WordStar/Mailmerge . . . 340

**MICROSOFT**  
Basic 80 . . . \$ 275  
Basic Compiler . . . 289  
Cobol 80 . . . 345  
Fortran 80 . . . 550  
Macro 80 . . . 150  
Multiplan/MuSimp . . . 199  
Multiplan . . . 215

**OASIS**  
\*The Word Plus . . . \$ 120  
\*Punctuation and Style . . . 99

**PEACHTREE**  
\*Peachpak 4 (G/L, A/R, A/P) (Special) . . . \$ 359  
General Ledger Series 4  
Accounts Receivable Series 4 . . . 399  
Accounts Payable Series 4 . . . 399  
Inventory Series 4 . . . 399  
CPA Client Write-up . . . 799  
Series 8 Modules each . . . 425  
Peachtext . . . 350  
Pickles & Trout . . . 170

**PROTEM SOFTWARE**  
\*Footnote . . . \$ 105

**REVASCO**  
Z80 Disassembler . . . \$ 85

**SORCIM**  
Supercalc . . . \$ 225  
Trans 86 . . . 115  
Act . . . 155

**STAR COMPUTER SYSTEM**  
G/L, A/R, A/P or Pay . . . \$ 350  
Legal Time, Billing . . . 845  
Property Management . . . 845

**SUPERSOFT**  
Diagnostic II . . . \$ 89  
Disk Doctor . . . 84  
Fortran 4 (DOS/8088) . . . 299  
Basic-8088 . . . 225  
Lisp . . . 120  
Z8000 Assembler . . . 400  
C Cross Assembler . . . 400  
\*ScratchPad . . . 219

### IBM PC

\*Please see CP/M listing for products with a "\*" All programs with a "\*" will run on PC DOS.

**Peachpak 4 (G/L-AR-AP)** \$ 359  
Graphic Software  
"Charlman II" . . . 345  
Multiplan (Microsoft) . . . 199  
IUS EasyWriter II . . . 199  
IUS EasySpeller . . . 129  
IUS Accounting Module . . . 399  
Alpha DataBase Manager . . . 170

Alpha Mailing List . . . 85  
Woolf Move II . . . 125  
Sorcim Spellguard . . . 247  
Lifetree Volkswriter . . . 145  
Ecosoft Microstat . . . 257  
Northwest Statpak . . . 397  
Organic Software  
Milestones . . . 269  
Datebook II . . . 269  
\*Microsoft Crosslink . . . 139  
Copy II Plus . . . 34

**SYSTEMS PLUS**  
Landlord (prop. mgmt.) \$ 375

### GAMES

Sir-Tech, InfoCom, Broderbund Hayden etc.

### Accessories/Hardware

**BOARDS**  
**APPLE/FRANKLIN**  
CoProcessors 88 card . . . \$ 795  
Softcard (Z80 CP/M) . . . 245  
Applescope (your Apple as an Oscilloscope) . . . 595  
Video 80 Col. Board . . . 247  
Microsoft Premium Pak . . . 599  
Video Enhancer I . . . 149  
K & D Enhancer . . . 115  
ALS Smarterm . . . 379  
ALS 2-card . . . 269  
Vscanard . . . 160  
Bit 3 Dual Comm-plus . . . 209  
16K RAM WIZARD . . . 79  
Microsoft 16K RAM . . . 89  
Echo II Speech Synthesizer . . . 159  
East Side Software Wild Card . . . 110

**IBM PC**  
BYAD DS-1 (64K, Z80, CP/M) . . . \$ 599  
Datamac 64K . . . 399  
Zedex Baby Blue . . . 495  
Quadram Quad Board . . . 445  
Quadram 128K Ram . . . 495  
AST Combo + 64K w/serial & parallel port . . . 350  
Hercules Graphics Board . . . 555  
Orchid Monochrome Graphic Adptr . . . 432  
OuCaS Big Blue . . . 499  
Vista Maxicard 64K . . . 325

**MISCELLANEOUS**  
Percom Doubler II . . . \$ 167  
Synlec Light Pen (IBM PC) . . . 140

Synlec Light Pen (AP/III) . . . 200  
Microglazer BK Printer Buffer . . . 135  
Maynard Floppy Drive Controller w/Par Port (IBMPC) . . . 229  
Prometheus (64K upgrade) Apple Surance . . . 120  
64K Upgrade . . . 75

### COMPUTERS

**Franklin/Televideo**  
Nac/Xerox — Call for Price Information

**MONITORS & TERMINALS**  
PGS RGB Color . . . \$Call  
Amdek Video 300 . . . 160  
Amdek RGB Color . . . 699  
NEC 12" Hires Green . . . 159  
Sanyo 12" Hires Green . . . 199  
USI Hi-RLS 12" Amber . . . 199  
Zenith ZVM 12" Green . . . 115

**MODEMS**  
Novation Apple-Cat II . . . \$ 289  
Novation 212 Auto Cat . . . 585  
Hayes Smartmodem . . . 225  
Hayes Smart Modem 1200 . . . 520  
Micromodem II . . . 319  
Hayes Chronograph . . . 189  
US Robotics Auto-Dial (Full Auto300/1200) . . . 439  
Auto-Line (Auto Answer300/1200) . . . 399

**PRINTERS**  
Epson FX-80 . . . \$Call  
C. Itoh Starwriter . . . 1450  
C. Itoh Frowriter . . . 485  
Generic Prowriter . . . 425  
NEC 3530 . . . 1850  
NEC 3550 . . . \$Call  
NEC 8123A . . . 489  
Okidata Microline 82A . . . 480  
Okidata Microline 83A . . . 685  
Prism 80 (w/4 options) color . . . 1399  
Prism 132 (w/4 options) . . . 1547  
Smith-Corona TP-1 . . . 625

**DISK DRIVES**  
Rana Elite I (AP II) (Special) . . . \$ 299  
Rana Elite II . . . 420  
Rana Elite III . . . 550  
Rana Controller (AP II) . . . 90  
Micro Sci A35 (AP II) . . . 399  
Tandon 100-2 . . . 290  
CDC 1800 . . . 299  
... and many more!

ORDER TOLL FREE - Outside WI - 1-800-826-1589

Please: • Wisconsin residents — add 5% for sales tax.  
• Add \$3.50 for shipping per software and small items. Call regarding others.  
• Foreign — add 15% handling & shipping for small items & software.  
• Prices subject to change without notice.  
• All items subject to availability.

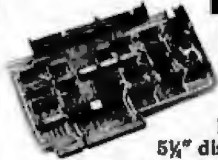
We welcome: • Visa, Mastercharge — (Add 4%)  
• Checks (Allow 1-2 weeks for clearing)  
• COD (Add \$1.50 per shipment)  
Working Hours: Mon.-Th. 8:30-5:30 • Fri. 8:30-6:30 • Sat. 10:00-2:00  
For technical information & in Wisconsin: 715-948-2322  
Store prices differ from mail order  
Int'l Telex — 280181 ORYX SYS WAU

Oryx systems inc. • 205 Scott St. • P.O. Box 1981 • Wausau, WI 54401





# ZENITH/ Heath Users



Double Your  
5 1/4" disk storage  
capacity without adding a drive.

Get twice as much from your H88 or H89 microcomputer. Our FDC-880H floppy disk controller, in conjunction with your 5 1/4" drives, for example, expands memory capacity from 256 bytes to 512 bytes per sector.

And it handles single and double-sided, single and double-density, 8" and 5 1/4" drives — simultaneously.



C. D. R. Systems Inc.

Controlled Data Recording Systems Inc.  
7210 Clairmont Mesa Blvd., San Diego, CA 92111  
(714) 560-1272

Circle 89 on Inquiry card.

## MicroFrame has new life

New Sources of S-100 Bus  
Mainframes & Disk  
Enclosures

Power Regulation  
meeting previous standards

Ann Arbor Terminals

60 Lines Display  
48 Programmable Keys  
1,499 prepaid

CALL FOR PRICES

MICRO MIDWEST

10205 W. 69 TERR.  
MERRIAM, KS. 66203  
913-362-3462

Circle 299 on Inquiry card.

## TeleVideo™ USERS!

COGITATE Fast Dump/Restore System for TS  
802K, 806.

- Back-up files twice as fast as PIP.
- Double the storage, up to 700K/diskette, with multiple diskette capability. **\$90.00**

COGITATE Type Ahead With Print Screen

- Print key prints screen.
- 64 character type ahead buffer. **\$90.00**

TurboDOS

- MULTI-USER **\$750.00**
- SEMINARS **\$250.00**

CP/M™ is registered trademark of Digital Research, Inc.  
TurboDOS is a registered trademark of Software 2000, Inc.  
**PLUS OTHER GOOD TELEVIDEO STUFF!**

**COGITATE, Inc.**

SPECIALISTS IN UNIQUE TELEVIDEO SOFTWARE  
24000 Telegraph Road, Southfield, MI 48034  
(313) 352-2345  
VISA/MASTER CARD Accepted

Circle 87 on Inquiry card.

Listing 1 continued:

```

E487 3E08      MVI      A, READCMD      ;GET READ COMMAND
E489 CD8FE4    CALL     CONCODE        ;SEND COMMAND TO CONTROLLER

READBUF:
E48C C3FD84    JMP      INLOOP        ;ROUTINE READS DATA INTO BUFFER
                          ;READ THE DATA

;
; CONCODE:
E48F 3295E5    ;COMMON CODE FOR READ AND WRITE TO CONTROLLER
E492 3A9FE5    STA     CMDBYT0        ;STORE COMMAND BYTE
                      LDA     HSTDSR      ;GET DISK NUMBER
                      REPT     5         ;MOVE TO BIT POSITION
                      RAL
                      ENDM
E495+17        RAL
E496+17        RAL
E497+17        RAL
E498+17        RAL
E499+17        RAL
E49A E6E0      ANI     0E0H           ;MASK OFF HI ADDRESS DATA
E49C 3296E5    STA     CMDBYT1        ;SAVE IN COMMAND BLOCK
E49F 2AA0E5    LRLD   HSTTRK         ;GET TRACK NUMBER
                      REPT     5         ; * 32 SECTOR/TRACK =# SECTORS
                      DAD     R
                      ENDM

E4A2+29        DAD     H
E4A3+29        DAD     H
E4A4+29        DAD     H
E4A5+29        DAD     H
E4A6+29        DAD     H
E4A7 3AA2E5    LDA     HSTSEC        ;GET SECTOR #
E4AA 5F        MOV     E,A           ;SET UP FOR ADD
E4AB AF        XRA     A
E4AC 57        MOV     D,A
E4AD 19        DAD     D
E4AE 7D        MOV     A,L
E4AF 3298E5    STA     CMDBYT3        ;SAVE IN COMMAND BLOCK
E4B2 7C        MOV     A,R           ;MSB OF ADDRESS
E4B3 3297B5    STA     CMDBYT2        ;SAVE IN COMMAND BLOCK
E4B6 3E01      MVI     A,01
E4B8 3299E5    STA     CMDBYT4        ;LOAD SECTOR COUNT
E4BB AF        XRA     A
E4BC 329AE5    STA     CMDBYT5        ;Deselect HALF STEP OPTION
E4BF 2195E5    LXI     H,CMDBYT0     ;SELECT HALF STEP OPTION
E4C2 CDCC2A    CALL   SENDCMD        ;START OF COMMAND BLOCK
E4C5 CDDFE4    CALL   CLR CMD        ;SEND COMMAND BLOCK TO CONTROLLER
E4C8 21B5E5    LXI     H,HSTBUF      ;CLEAR THE COMMAND BUFFER
E4CB C9        RET                    ;POINT TO TRANSFER BUFFER

; SENDCMD:
E4CC CD11E5    ;SEND THE COMMAND BLOCK POINTED TO BY HL
E4CF CD26E5    CALL   SELECT         ;SELECT THE CONTROLLER
E4D2 0606     CALL   WAIT           ;WAIT FOR REQUEST
                      MVI     B,6        ;COMMAND BYTE COUNT

; SENDC:
E4D4 7E        MOV     A,M           ;GET COMMAND BYTE
E4D5 D3A1     OUT    DATA         ;SEND IT TO CONTROLLER
E4D7 23        INX    R
E4D8 05        DCR    B
E4D9 C2D4E4    JNE   SENDCD        ;NEXT BYTE
E4DC C326E5    JMP   WAIT           ;KEEP TRACK
                      ;WAIT FOR REQUEST

; CLR CMD:
E4DF AF        ;CLEAR COMMAND BLOCK
E4E0 0606     XRA     A
E4E2 2195E5    MVI     B,6
                      LXI     H,CMDBYT0 ;LOAD ZERO
                      ;BYTE COUNT
                      ;POINT TO FIRST BYTE

E4E5 77        CLR CMD1:
E4E6 23        MOV     M,A           ;CLEAR BYTE
E4E7 05        INX    R
E4E8 C2E5E4    DCR    B
E4EB C9        JNE   CLR CMD1     ;SUB COUNT
                      ;

; OUTLOOP:
E4EC DBA0     ;SEND OUT DATA UNTIL C/D BIT SIGNALS FINISH
E4EE E602     IN     CNTRL         ;READ STATUS
E4F0 CA2EE5   ANI     CNDAT        ;CHECK C/D BIT
E4F3 7E        JZ     CKERR        ;DONE, CHECK FOR ERRORS
E4F4 7E        MOV     A,M           ;GET OUTPUT BYTE
E4F5 D3A1     OUT    DATA         ;TO CONTROLLER
E4F6 C2D6E5   CALL   WAIT         ;REQUEST
E4F9 23        INX    R
E4FA C3CE2A   JMP   OUTLOOP       ;NEXT BYTE
                      ;KEEP LOOPING

; INLOOP:
E4FD DBA0     ;READ DATA UNTIL C/D BIT SIGNALS FINISH
E4FF E602     IN     CNTRL         ;READ STATUS
E501 CA2EE5   ANI     CNDAT        ;CHECK C/D BIT
E504 DBA1     JZ     CKERR        ;CHECK FOR ERRORS
E506 77        IN     DATA         ;READ BYTE
E507 C2D6E5   MOV     M,A           ;TO MEMORY
E50A 23        CALL   WAIT         ;REQUEST
E50B C3FDE4   INX    R
                      JMP   INLOOP     ;NEXT LOCATION
                      ;KEEP LOOPING

; RESET:
E50E D3A3     ;RESET THE XEDEC DISK CONTROLLER
E510 C9        OUT    RSTPT        ;SEND ANYTHING TO THE RESET PORT
                      RET

; SELECT:
E510 C9        ;SELECT DISK 0 OF THE XEDEC CONTROLLER

```

# WILD HARE REPROGRAMS THE TORTOISE



## MORE GREAT NEWS FOR DATA GENERAL USERS!

**Speedy Hardware puts you out front.** Our Enhancer Hardware series is designed to dramatically improve the overall response and throughput of your Data General systems. Designed to look like an incredibly fast disk drive to your operating system, it accesses its 1 MB of data in 2.5 microseconds and transfers it at 2 megabytes/second. Make ICOS (CS/COBOL), RDOS and INFOS streak with a 30-day trial run. AOS/Enhancer available soon!

**Productive Software wins the race!** In the race for productivity, Wild Hare gives you that extra edge by multiplying the capabilities of your Data General system. Wild Hare's TSS operating system enhancements give Data General NOVA and ECLIPSE users the most from their system. TSS allows you to transform RDOS, ICOS (CS/COBOL) and INFOS into true multilingual, multi-user Time Sharing Systems.

This state-of-the-art system accommodates up to 26 users. Each user can independently edit, compile and execute programs using the language of his choice, like FORTRAN, ALGOL, BASIC, COBOL, Pascal, Assembler and more.

TSS combines RDOS, INFOS and ICOS compatibilities with AOS capabilities at a mere fraction of the cost. Try a 30-day trial run and get an even greater run for your money.

**Wild Hare wins the marathon.** Wild Hare has a new hardware/software scheme. It allows you to take advantage of the latest hardware and software technology, yet lets you preserve your valuable Data General user software investment. Our new "Hare Brain Scheme" is on the starting line, so watch for the latest solutions from Wild Hare. Our good ideas keep multiplying.



**wild hare**  
COMPUTER SYSTEMS INC.



# COM-STAR F/T

Tractor  
Friction  
Printer

only **\$299**

**FREE**  
Box of printer paper and  
demo tape with purchase.



- Lowest price quality tractor friction printer in the U.S.A. • Fast 80 characters per second
- 40, 46, 66, 80, 96, or 132 characters per line spacing • Prints labels, letters, graphs, and tables
- List your programs • Print out data from modem services

## Deluxe COMSTAR F/T PRINTER — \$299.00

The Comstar is an excellent addition to any micro-computer system. (Interfaces are available for Apple, VIC-20, Commodore-64, Pet, Atari 400 and 800, and Hewlett Packard) At only \$299, the Comstar gives you print quality and features found only on printers costing twice as much. Compare these features.

• **BI-DIRECTIONAL PRINTING** with a LOGIC SEEKING CARRIAGE CONTROL for higher through-put in actual text printing. 80 characters per second.

• **PRINTING VERSATILITY:** standard 96 ASCII character set plus block graphics and International scripts. An EPROM character generator includes up to 224 characters.

• **INTERFACE FLEXIBILITY:** Centronics is standard. Options include EIA RS232C, 20mA Current Loop. (Add \$20.00 for RS232)

• **LONG LIFE PRINT HEAD:** 100 million character life expectancy.

• **THREE SELECTABLE CHARACTER PITCHES:** • 10, 12 or 18.5 characters per inch, 132 columns maximum. Double-width font also is standard for each character pitch.

• **THREE SELECTABLE LINE SPACINGS:** 6, 8 or 12 lines per inch.

• **PROGRAMMABLE LINE FEED:** programmable length from 1/144 to 255/144 inches.

### COMSTAR FT

ABCDEFGHIJKLMN O PQRSTU VWXYZ abcdefghijkl  
lmnopqrstuvwxyz 1234567890  
ABCDEFGHIJKLMN O PQRSTU VWXYZ abcdefghijklmnopqrstuvwxyz 1234567890

### SUPER-10"

ABCDEFGHIJKLMN O PQRSTU VWXYZ  
ABCDEFGHIJKLMN O PQRSTU VWXYZ 1234567890

• **VERTICAL FORMAT CONTROL:** programmable form length up to 127 lines, useful for short or over-sized preprinted forms.

• **FRICION AND TRACTOR FEED:** will accept single sheet paper.

• **224 TOTAL CHARACTERS**

• **USES STANDARD SIZE PAPER**

if you want more try —

## Premium Quality COMSTAR F/T SUPER-10" PRINTER — \$389.00

More Features Than MX-80  
For \$250 Less

For \$389.00 you get all of the features of the Comstar plus 10" carriage, 100 cps, 9 x 9 dot matrix with double strike capability for 18 x 18 dotmatrix. High resolution bit image (120 x 144 dot matrix), underlining, backspacing, 2.3K buffer, left and right margin settings, true lower descenders, with super and subscripts, and prints standard, Italic, Block Graphics, special characters, plus 2K of user definable characters. For the ultimate in price performance the Comstar F/T Super 10" leads the pack!

### WE HAVE THE LOWEST PRICES

We sell to customers and you save the profit margin normally made by computer stores, department stores and distributors, we are willing to take a smaller margin to develop volume. WE LOVE OUR CUSTOMERS — OUR PRICES PROVE IT!

## Double Immediate Replacement Warranty

We have doubled the normal 90 day warranty to 180 days. Therefore if your printer fails within "180 days" from the date of purchase you simply send your printer to us via United Parcel Service, prepaid. We will IMMEDIATELY send you a replacement printer at no charge via United Parcel Service, prepaid. This warranty, once again, proves that WE LOVE OUR CUSTOMERS!

## 15 DAY FREE TRIAL OTHER OPTIONS

Extra Ribbons ..... \$ 5.95  
Roll Paper Holder ..... 32.95  
Roll Paper..... 4.95  
5000 Labels ..... 19.95  
1100 Sheets Fan Fold Paper..... 13.95

Add \$20.00 shipping, handling and insurance. Illinois residents please add 8% tax. Add \$40.00 for CANADA, PUERTO RICO, HAWAII, ALASKA orders. WE DO NOT EXPORT TO OTHER COUNTRIES. Enclose cashiers check, money order or personal check. Allow 14 days for delivery, 2 to 7 days for phone orders, 1 day express mail available!! Canada orders must be in U.S. dollars.

**PROTECTO**  
**ENTERPRIZES** (FACTORY DIRECT)  
BOX 550, BARRINGTON, ILLINOIS 60010  
Phone 312/382-5244 to order

# VIC-20

(a real computer at the price of a toy)

## \$134.<sup>00</sup>

(when you buy 6 programs)

You get the Commodore VIC-20 computer for only \$134.00 when you buy 6 tape programs on sale for only \$59.00. These 6 programs list for \$100.00 to \$132.00. You can choose one of three packs: 6 games pack, 6 home finance pack, or 6 small business pack. The VIC-20 computer includes a full size 86 key typewriter professional keyboard, color command keys, upper/lower case, full screen editor, 16K level II microsoft basic, color, sound and music, real time, floating point decimal, easy to read self teaching instruction book, connects to any TV, includes console case.

### 33K COMMODORE VIC \$199.00 with 2½ times more power

You get the VIC-20 computer plus we expand the total memory to 33,000 bytes to give you 2½ times more programming power.

### 41K COMMODORE VIC \$249.00 with 4 times more power

### 49K COMMODORE VIC \$299.00 with 6 times more power

### 49K COMMODORE VIC PROFESSIONAL WORDPROCESSOR \$299.

You get the powerful VIC-20 computer with expanded memory — plus we add The Quick Brown Fox professional wordprocessor. This combination gives you a 49K professional wordprocessor. (80 column formatting and mailmerge \$100 extra).

### TRACTION FRICTION PRINTER \$299.00

Comstar F/T deluxe line printer, prints 8½x11 full size, single sheet, roll or fan fold paper, labels etc. 40, 66, 80, 132 columns. Impact dot matrix, bi-directional, 80 CPS.

### 60K MEMORY EXPANDER \$79.00

Sixslot — Switch selectable — Reset button — Ribbon cable. A must to get the most out of your VIC-20 computer.

### VOICE SYNTHESIZER \$79.00

Makes your VIC-20 talk, VOTRAX based plus features found only in \$295 versions.

## COMPUTER AND SOFTWARE SALE

# COMMODORE 64

(more power than Apple II at half the price)

## \$300.<sup>00</sup> FREE PROFESSIONAL SOFTWARE

(when you buy the Commodore-64 Computer for \$595.00)

You get the extra powerful Commodore-64 computer (64,000 bytes RAM plus 20,000 bytes ROM). Full size 86 key typewriter keyboard, 320 x 200 high resolution graphics, text is 40 columns by 25 lines. 1000 displayable characters, 8 moveable sprites, programmable synthesizer (4 wave forms, full ASDR). In addition to these features we give you FREE PROFESSIONAL SOFTWARE VALUED OVER \$300.00.

### PROFESSIONAL WORDPROCESSING PACKAGE

This wordprocessor is specially designed for the Commodore-64 utilizing the latest techniques. Allows powerful text editing capabilities without long hours of orientation or training. Complete cursor and insert/delete key controls are used. Block movement and/or duplication, line insertion and/or deletion, automatic centering, margin settings, tab settings, copy, disk or tape handling, and all printer types. Up to 99 continuous pages of text can be output to the printer. List \$89.00.

### COMPLETE DATABASE PACKAGE

A user friendly data base system that makes information easy to find and store. You can add, change, delete, and search for data. Print the information on a printer in any format desired. When combined with the word processor pack you have a powerful merge program that allows custom documents and personalized mailing lists. List \$89.00.

### COMPLETE ACCOUNTING PACKAGE (Home or Small Business)

This general ledger program is perfect for small business as well as home. It utilizes a double entry bookkeeping system. You only need enter one transaction and the computer will handle the other. All accounts are user definable and will build for 1 year, resulting in a file of all transactions by account number, month and year to date. Each month a current month's transactions can be viewed at any time (99 accounts 187 entries per month). With this accounting program you will be able to monitor your financial growth as well as your expenses. List \$59.00.

### COMMODORE-64 PROGRAMMERS REFERENCE GUIDE

This is the in-depth guide that goes into the heart of the 64. All aspects of the basic and machine language are covered. (A must for anyone wishing to program the Commodore-64). List \$20.95.

## VIC20 PERSONAL COMPUTER

### TOP 10 ARCADE GAMES

VIC-20 TAPE PROGRAM SALE!!

Rank	Name	Sale
1	Suber Paratrooper (Fantastic)	\$19.95
2	Extremator Plus (Better than Centipede)	\$19.95
3	Crisal (Better than Frogger)	\$19.95
4	Snackman (Better than Pacman)	\$19.95
5	Galactic Crossfire (you in the middle)	\$19.95
6	Anti-Matter Speller (Nuclear Disaster)	\$19.95
7	Bug Blast (Creepy)	\$19.95
8	Bombs Away (Great)	\$19.95
9	J-D Maze-Escape	\$14.95
10.	Krazy Kong	\$14.95

BUY ANY FOUR — DEDUCT 10% MORE

### VIC-20 PROGRAMMING AIDS!!

	Sale
• Introduction to basic programming (manual and tapes)	\$22.95
• Advanced basic programming (manual and tapes)	22.95
• Programmer's reference manual (288 pages — you must have this!)	19.95
• Programmer's easy reference card (tables, hints drawings)	3.95
• VIC 20 Revealed (267 pages of VIC secrets)	11.95
• 6502 Machine Language Assembler	24.95
• 16K Programming cartridge (gives 400% more programming power — get \$24.95 16K adventure game free!)	79.00

## Commodore 64 Computer

### PROFESSIONAL SOFTWARE

Name	Sale
word processing pack	\$69.00
complete Data Base pack (includes Mailmerge)	\$69.00
Electronic spreadsheet pack (like Visicalc)	\$69.00
Accounting pack (personal & business)	\$49.00
Programmers Helper	\$59.00
Programming Reference guide	\$19.95
Basic Tutor	\$19.95
Typing Tutor	\$19.95

## 80 column BOARD

80 characters per line on the screen at one time. Includes word processing pack (list \$89.00), complete data base pack (list \$89.00), Electronic spreadsheet pack (list \$69.00). ALL FOR ONLY \$275.

We have over 300 Programs for the Commodore 64 Computer

WE LOVE OUR CUSTOMERS

• LOWEST PRICES • 15 DAY FREE TRIAL • 90 DAY FREE REPLACEMENT WARRANTY  
• BEST SERVICE IN U.S.A. • ONE DAY EXPRESS MAIL • OVER 500 PROGRAMS • FREE CATALOGS

Add \$10.00 for shipping, handling and insurance. Illinois residents please add 6% tax. Add \$20.00 for CANADA, PUERTO RICO, HAWAII orders. WE DO NOT EXPORT TO OTHER COUNTRIES.

Enclose Cashiers Check, Money Order or Personal Check. Allow 14 days for delivery. 2 to 7 days for phone orders, 1 day express mail! Canada orders must be in U.S. dollars.

# PROTECTO ENTERPRIZES (WE LOVE OUR CUSTOMERS)

BOX 550, BARRINGTON, ILLINOIS 60010  
Phone 312/382-5244 to order



# Using IBM's Marvelous Keyboard

*It's simple to change IBM's keyboard to the Dvorak layout or use the keyboard with other computers and software.*

---

David B. Glasco  
Murray Sargent III  
Optical Sciences Center  
University of Arizona  
Tucson, AZ 85721

---

Perhaps the most stunning feature of IBM's Personal Computer is its beautiful streamlined keyboard. Slim, solid, artistic, and versatile, it defines a new standard in keyboard design. Where did its unique layout come from, and is it superior to others? Can you obtain just the keyboard itself, and how can it be used with other computers? In this article, we'll study the IBM keyboard from the inside out to answer those questions. You'll see how to take full advantage of its power, and we'll show IBM Personal Computer owners a simple way to redefine the keyboard using the operating system. This will allow you to switch to the more efficient Dvorak keyboard layout, or to create your own layout that better suits special needs, such as entry of foreign-language and mathematical text.

Solidly built and with excellent tac-

---

## Acknowledgments

*We thank Mike Aronson, Curtis Feigel, Rick Shoemaker, and Mark Tiddens for helpful suggestions.*

---

## About the Authors

*Murray Sargent III is a professor of optical sciences at the University of Arizona and an author of textbooks on laser physics and microcomputer interfacing. David B. Glasco, a microcomputer owner, is a senior at Canyon Del Oro High School.*

---

tile feel, the futuristic IBM Personal Computer keyboard can rest on a flat surface or be inclined and is detached from the main case of the Personal Computer so you can move it around to suit your mood. The choice of characters includes the English letters, Arabic digits, complete ASCII (American National Standard Code for Information Interchange) punctuation characters, 10 special-function keys (labeled F1 to F10), three shift keys (Ctrl, shift, and Alt), two shiftlock keys (Caps Lock and Num Lock), and 15 "cursor/ numeric keypad" keys. One badly needed key that isn't provided is a key labeled "Help." What might be accomplished by typing a Help key depends on software, but user-friendly systems should support such a key. Because the IBM Personal Computer lacks this key, the use of F1 as the Help key is becoming standard procedure in a lot of software.

## The Layout

A fair amount of controversy exists concerning IBM's placement of some keys—specifically the shift, backslash, carriage-return, and delete keys. The latter two are often thought to be a bit farther from standard positions than desired, considering the high use they are likely to get. The location of the backslash (between the left shift key and the Z key) is

heavily lamented in the U.S.A. because touch-typists are used to finding one large shift key that starts in the backslash position. A point partially justifying IBM's choice is that it's symmetric. On standard keyboards, e.g., the IBM Selectric typewriter, the forward slash occupies the position between the right shift key and the period, so why not have the backslash intervene between the Z and the left shift key? Furthermore, the right little finger has to move the same distance to reach its shift key as the left little finger does to reach its on the IBM Personal Computer keyboard.

The design follows the German DIN (Deutsche Industrie Norm) standards, for which extensive ergonomic studies were made to determine the most comfortable way for people to type. The backslash (or some other) character is often found between the left shift key and the Z on European keyboards, so Europeans feel this is quite natural. At any rate, after a few hours of experience, the backslash no longer presents a problem for a touch-typist (and it never did for anyone else; if this placement really bothers you, the programs provided here show how to change the keys to any order you desire). In addition, the standards specify labeling the backspace, tab, shift, and carriage-return keys with various arrows,

which is a bit confusing at first and presents typographical problems when one writes about these keys. Curiously enough, the IBM Personal Computer is only just now being marketed in Europe, despite the support of special foreign-language characters on the display screen.

### Of Keyboards and Codes

IBM sells just the keyboard itself for \$279. But, as with other components of the Personal Computer, the keyboard has been "cloned" by other manufacturers; it is available from Key Tronic, of Spokane, Washington, for \$212, so you have more than one source for this kind of keyboard.

The Key Tronic version of the IBM Personal Computer keyboard has the same layout and comes with a variety of encoding options. One, called "IBM Personal Computer plug-compatible," works fine with the IBM Personal Computer. This particular model has small red indicators that light up when the Caps Lock or Num Lock functions have been activated. The keys have a very different feel from the IBM keys. As you press one of the Key Tronic keys, it offers almost no initial resistance, then when contact is made, it offers substantial resistance, thus giving a nice tactile feedback. If desired, you can continue to push down against this increased resistance until the bottom of travel is reached. With some practice, this keyboard requires less effort to type on than the IBM keyboard. In addition, it is less expensive and substantially quieter (you can type away while on the telephone without offending the other party). On the other hand, the keyboard doesn't feel or look as solidly built as the IBM version and lacks the IBM's convenient ledge that is useful for storing pencils and for supporting dust covers. Having used both fairly extensively, we prefer the IBM version somewhat but feel the Key Tronic is better than virtually any other keyboard we've used (and the people at Key Tronic would probably be willing to add a Help key).

One super feature of the IBM keyboard (and the Key Tronic clone) is

that you can cause any key combination to create any code you want. To understand how this is done, let's examine the key-encoding scheme. The keyboard contains an Intel 8048 single-chip microcomputer that constantly scans all the keys. It sends out a serial pattern of bits (called the *make code*) when a key makes contact, and a similar pattern (the same pattern but with the high-order bit set, called the *break code*) when the

---

## Like other components of the PC, the keyboard has been "cloned" by other manufacturers.

---

contact is broken. If the contact is present for more than 1/2 second, the keyboard sends out the make code repetitively 10 times a second.

Each key is treated identically by the keyboard; any key could represent a shift key, a number, or a special function. And, because the duration of the depression of a key is reported precisely, you can use the keyboard for playing music and simulating simple joysticks, in addition to the usual typewriter applications. Meanwhile, the main computer doesn't have to waste time monitoring and "debouncing" the keyboard—that's all done by the dedicated 8048 microcomputer. The penalty one pays for this completely general flexibility is that the main computer does have to translate the make and break codes into standard ASCII, but that seems a minor price to pay.

### The Joy of Software

Because of the great flexibility of the keyboard, you're really limited only by software—specifically, by the operating system. In this connection, perhaps the most significant improvement of PC-DOS over the 8-bit versions of CP/M is run-time extensibility. You can run a program that defines or redefines some capability in the system and leave it resident until the system is reloaded. Furthermore, when PC-DOS is reloaded, it

automatically executes programs named in the AUTOEXEC.BAT file, so that you can bring up a substantially modified operating system with very little effort.

One example of run-time extension is the program in listing 1; it can redefine the keyboard to your specifications. The incoming make code or break code may be translated into any other make code or break code, so that any key can be made to play the role of any other. Then, if neither the Ctrl nor the Alt key is pressed, control is transferred to an appropriate point in the ROM BIOS (read-only memory basic input/output system) to finish the processing, translate the key's code into ASCII, or perform the function specified by the key.

If the Ctrl key is pressed, a couple of special values are checked to give meaning to Ctrl-uparrow and Ctrl-downarrow combinations. For these cases, the jump into the ROM BIOS occurs after all ROM translation and just before the final bit pattern is stored in the keyboard buffer. If the Alt key is pressed, a second table lookup translates the code into any desired 8-bit value and jumps to the ROM BIOS to store the new code in the keyboard buffer. (It is easy to convert our Z80 translator in listing 2 to run on the IBM and bypass the ROM BIOS routine altogether; however, it requires somewhat more memory, so we prefer this hybrid version.)

For the sake of demonstration, the program is initialized to set up the infamous backslash key as a shift key and the cursor pad's minus key as the backslash key. In practice, we've decided we really prefer to leave these keys alone so that they do what they are labeled to do. When running the program, you can switch to a Dvorak key layout by typing a Ctrl-enter combination. (This layout was proposed by Dr. A. Dvorak and his associates after carrying out extensive research on the relative use and sequences of letters. In particular, they placed the keys A, O, E, U, I, and D, H, T, N, S under the left-hand and right-hand standard positions, respectively. Because these characters

Text continued on page 408



**Listing 1:** This program takes over the IBM PC keyboard interrupt (INT 9), translating input codes to values given in the internal tables. Initially, the layout is changed as detailed in the text. Typing a Ctrl-Enter combination switches the computer to the Dvorak keyboard layout; a Ctrl-Esc combination returns to the initial layout. Ctrl-backtab, Ctrl-uparrow, and Ctrl-downarrow combinations are translated to O, U, and J for use with the Pmate screen editor. Certain uppercase and lowercase letters are given alternate values. Control is then passed to the ROM routines for further processing.

```

kb_data equ 60h ;Keyboard data port
kb_ctl equ 61h ;Keyboard control port

data segment at 40h
org 17h
kb_flag label byte ;RAM keyboard flag byte (see Tech Ref Man, p. A-2)
data ends

cseg segment
assume cs:cseg,ds:data

dvorak db ? ;Dvorak flag
org 100h

start: mov dx,5Ch ;Set DS:DX to loc. 5Ch in program prefix
mov al,9 ;Set the keyboard interrupt (INT 9)
mov ah,25h ; to DS:DX via DOS function call
int 21h
mov di,dx ;Move keyboard routine down so it starts
mov si,keyadr ; at loc. 5Ch in program prefix
mov cx,keylen ; (saves space)
jmp finish

;Keyboard interrupt routine. Copy beginning of IBM PC ROM routine to
;allow easy jump to later ROM code

keybrd: push ax ;Save registers used
push bx
push cx
push dx
push si
push di
push ds
cld
mov ax,data
mov ds,ax
sti
in al,kb_data ;Get key code
push ax
in al,kb_ctl ;Restore keyboard
mov ah,al
or al,80h
out kb_ctl,al
xchg ah,al
out kb_ctl,al

```

```

pop ax
mov ah,al ;Save key code

;End of copied ROM code. Start special translations

cmp al,0ffh ;Overrun?
jz romkey

mov di,tabadr ;Translate key code
cmp cs:dvorak,28 ;Use Dvorak table?
jnz keybr0
mov di,tabaddr ;Yep
and al,7fh ;Kill make/break bit
call trans
test ah,80h ;Break code?
jnz romky0

test kb_flag,4 ;No. Ctrl key pressed?
mov di,ctadr
jz altran
cmp al,28 ;Yep. Enter key? (Use Dvorak!)
jz keybr1
cmp al,1 ;Escape key? (Leave Dvorak?)
jnz keybr2
mov cs:dvorak,al
jmp far ptr k26 ;Restore regs and reti

altran: test kb_flag,8 ;Alt key pressed?
jz romkey
mov di,oaltlc
test kb_flag,43h ;Shift?
jz tran
mov di,oaltuc

tran: call trans
jnz romkey
jmp far ptr k61

romky0: or al,80h
romkey: mov ah,al
jmp far ptr romadr

;Translate routine. Replaces byte in string [di] by byte following
;matched byte. Returns Z if no match found; NZ if match found.

trans: cmp al,cs:[di]
jz xfnd
inc di
inc di
cmp byte ptr cs:[di],0
jnz trans
or al,al
ret ;RNZ

xfnd: mov al,cs:[di]
ret ;RZ

```

Listing 1 continued:

```

finish:  rep    movsb
         mov    dx,di      ;End program but leave keybrd resident
         int    27h

table   db    43,42,74,43,0 ;backslash -> left shift, keypad- -> backslash

;For a Dvorak keyboard use

tabled  db    16,40,17,51,18,52,19,25,20,21,21,33,22,34,23,46,24,19,25,38,26,53
         db    30,30,31,24,32,18,33,22,34,23,35,32,36,35,37,20,38,49,39,31,40,12
         db    44,39,45,16,46,36,47,37,48,45,49,48,50,50,51,17,52,47,53,44,0

ctable  db    15,15,72,21  ;^backtab -> ^O, ^uparrow -> ^U
         db    80,10,0     ;^downarrow -> ^N}

altlc   db    30,132,46,135,18,130,49,164,24,148,22,129,23,161,51,174,52,175
         db    02,173,53,168,03,253,13,240,32,235,0

altuc   db    30,142,46,128,18,138,49,165,24,153,22,154,02,173,53,168,05,156
         db    41,247,13,241,32,127,0

keyend:

cseg    ends

rom     segment at 0f000h ;IBM ROM BIOS keyboard entry points
        assume cs:rom
romadr  label   far       ;Perform all but initial processing
        org    0e9a8h
k26     label   far       ;Restore registers and return
        org    0ea81h
k1234   label   far       ;Reboot (Ctrl-Alt-Del addr)
        org    0ec0ch
k61     label   far       ;Store char in keyboard buffer and return
rom     ends

keyadr  equ    (offset keybrd - offset start) + 100h
keylen  equ    offset keyend - offset keybrd
tabadr  equ    (offset table - offset keybrd) + 5Ch
tabddr  equ    (offset tabled - offset keybrd) + 5Ch
ctadr   equ    (offset ctable - offset keybrd) + 5Ch
oaltlc  equ    (offset altlc - offset keybrd) + 5Ch
oaltuc  equ    (offset altuc - offset keybrd) + 5Ch

        end    start
    
```

Listing 2: KYBRD is a program to convert IBM PC keyboard codes, given by call to KEYR, into extended ASCII codes (returned in A with extension code in C). Standard keys work as they do for regular ASCII, with ASCII code returned in A and C equal to 0. If the Alt key is pressed, bit 7 of A is set. Special-function keys, TAB, BS, CR, and cursor-pad keys return a code in A (the ASCII code if relevant) with C equal to hexadecimal FE for TAB, BS and CR, and C equal to hexadecimal FF for all others. For these special keys, pressing Alt sets bit 7 of A, pressing Ctrl sets bit 6 of A, and pressing the shift key sets bit 5 (so that the numeric keypad works reasonably). The program includes the routines (starting with KEYR) to time the keyboard waveforms using a TRS-80 (printer-port pin 28). For practical use, one should use a UART to read the keyboard and preferably incorporate KYBRD as part of an interrupt-handling routine.

```

;Z80
;radix    16

;comment 1KYBRD is a program to convert IBM PC keyboard codes given by call to KEYR
into extended ASCII codes (returned in A with extension code in C). Standard keys work as
for regular ASCII, with ASCII code returned in A and C=0. If the Alt key is depressed, bit
7 of A is set. Special function keys, TAB, BS, CR, and cursor pad keys return a code in A
(the ASCII code if relevant) with C=0feh for TAB, BS, and CR, and C=0ffh for all others.
For these special keys, Alt depressed sets bit 7 of A, Ctrl depressed sets bit 6 of A, and
SHIFT depressed sets bit 5 (so that numeric keypad works reasonably). The program below
includes the routines (starting with KEYR) to time the keyboard waveforms using a TRS-80
(printer port pin 28). For practical use, one should use a UART to read the keyboard and
preferably incorporate KYBRD as part of an interrupt handling routine.
    
```

;Test program

```

START:  xor    a          ;Turn off shift bits
        ld    (SHIFT),a
LOOP:   call   KYBRD      ;Get next character
        or    c          ;Test for null in c
        jr    z,LOOP3    ;Display char alone if c=0
        inc  c
        ld    c,'$'      ;0ffh codes are displayed following "$"
        jr    z,LOOP2    ;0feh codes are displayed following "#"
LOOP2:  push   af
        call co
        pop  af
LOOP3:  ld    c,a
        call co
        jr   LOOP        ;Continue
    
```

;Main decode routine

```

KYBRD:  call   KEYR      ;Get next code
        ld    c,a        ;Save it
        or    a
        ret    z
        res  7,a         ;Turn off break bit
        ld    N,TAB1-1  ;Point to TABLE1
        ld    d,0        ;Clear d
    
```

Listing 2 continued on page 406



## Listing 2 continued:

```

ld      e,a
add     hl,de      ;Index table
ld      a,(hl)    ;Get ASCII code
ld      e,a       ;Save key code

ld      hl,SHIFT  ;Check for shift keys
cp      83        ;Alt key?
ld      b,80
jr      z,SHF
cp      82        ;Ctrl key?
ld      b,40
jr      z,SHF
cp      81        ;Left SHIFT key?
ld      b,2
jr      z,SHF
cp      80        ;Right SHIFT key?
ld      b,4
jr      z,SHF

bit     7,c       ;Ignore break codes for shift locks
jr      nz,RET3  ; and all non-shift codes

cp      84        ;NumLock key?
ld      b,20
jr      z,SHFL
cp      85        ;CapsLock key?
ld      b,1
jr      z,SHFL

;Process non-shift keys

cp      1f        ;Special char?
jr      c,SPEC
cp      7b        ;No. Letter?
jr      nc,OTHER
cp      61
jr      c,OTHER
ld      a,(hl)   ;Yes. Check shifts
bit     0,a      ;CapsLock?
jr      z,KYBRD1
and     6        ;Yes. Shift if neither shift key depressed
ld      a,e
jr      z,KYBRD2
jr      RET

KYBRD1: and     6        ;No CapsLock. Shift key depressed?
ld      a,e
jr      z,RET

KYBRD2: res     5,a      ;Shift character
jr      RET

OTHER:  ld      a,(hl) ;Not letter, shift, or special
and     6        ;Must be number or punctuation
ld      a,e      ;Shift?
jr      z,RET
cp      60        ;Yes. ***?

```

```

jr      z,OTH2
cp      5a        ;Test for code above uc letters
jr      nc,OTH1  ;Go if above letter
ld      hl,TAB2  ;Between '*' and '='. Point to shift table
sub     ""       ;Move lowest code to zero
jr      c,RET
ld      d,0      ;Clear d
ld      e,a      ;Put code in e
add     hl,de    ;Index table
ld      a,(hl)  ;Get shifted code
jr      RET

OTH1:   set     5,a ;Between 'Z' and 'a'
jr      ret

OTH2:   ld      a,7e ;Shift '*' to '*'

RET:    ld      c,0 ;Clear c (non-special char)
ld      hl,SHIFT ;Point to shift status
bit     6,(hl)   ;Is Ctrl on?
jr      and     1f ;Yes. Turn off bits 5 and 6

RET1:   bit     7,(hl) ;Is Alt on?
ret     z
set     7,a      ;Yes. Turn on high bit

;Process shift keys

SHF:    bit     7,c ;Test for break
SHF1:   ld      a,b
jr      nz,SHFOFF ;Reset shift bit if break code
or      (hl)     ;Set shift bit
SHF2:   ld      (hl),a ;Update shift bits
RET3:   xor     a ;Return a=0
ret

SHFOFF: cpl
and     (hl)     ;Turn shift bit off
jr      SHF2    ;Go update

SHFL:   ld      a,b ;Toggle SHIFT Lock keys. Load bit into a
and     (hl)
jr      SHF1

;Process function and cursor pad keys

SPEC:   cp      11    ;NumLockable key (digit)?
ld      a,(hl)    ;Get shift codes
jr      c,SPEC0
bit     5,a       ;Yes. NumLock on?
jr      z,SPEC0
and     6        ;Yes. Shift?
ld      a,e
jr      nz,SPEC2
jr      SPEC1
SPEC0:  and     6    ;No. Convert to number
SPEC2:  and     6    ;No NumLock. Shift?

```

```

ld      a,e
jr      z,SPEC2
SPEC1:  set      5,a      ;Yep. Convert to number
SPEC2:  bit      6,(hl)   ;Ctrl on?
jr      z,SPEC3
SPEC3:  set      6,a      ;Yep. Set control bit in code
ld      e,a      ;Save code
ld      a,c
ld      c,0feh    ;Load return code for TAB, BS, and CR
cp      0e      ;BS?
jr      z,SPEC4
cp      0f      ;TAB?
jr      z,SPEC4
cp      7c      ;CR?
jr      z,SPEC4
inc     c      ;Offh is return code for all others
SPEC4:  ld      a,e
jr      RET1     ;Choose Alt bit and return
    
```

**;TRS-80 waveform decode programs**

```

DATA    equ     0f8    ;Input port of keyboard (printer handshake port
                    ; on TRS-80)

KEYR:   in      a,(DATA) ;Get keyboard byte
bit     7,a      ;Is bit keyboard bit high (Change this bit check to
                    ;the bit you are inputting the keyboard signal on)
jr      nz,KEYR   ;Try again if not high
di      ;Disable interrupts

STALL:  djnz   STALL   ;Stall until next bit is ready
ld      c,6
ld      b,8

GETIT:  in      a,(DATA) ;Get bit
rr      ;Shift into carry
rr      ;Shift carry into c
call    DELAY    ;Delay until next bit is ready
djnz   GETIT    ;Read 8 bits
ld      a,c      ;Put code in a
cpl    ;Reenable interrupts
ei      ;
ret

co:     ret      ;Console display routine

DELAY:  id     a,b
DELAY0: dec     a      ;Delay for 1 bit period
jr      nz,DELAY0
ret

SHIFT:  db     1      ;Shift byte: B0=CapsLock, B1=SHIFT, B2=SHIFT
                    ;B3= , B4= , B5=Ctrl, B6=NumLock, B7=Alt
    
```

.comment ¶Key code translation table. Translates ASCII characters into ASCII, shift characters into codes 80-84 and special characters into codes 1-19H. These codes are

further processed by the program. Key changes can be made by substituting desired translated codes for those in table. The appropriate table rows for the Dvorak keyboard are given as comments following the table.

```

TAB1:   ;For key code value, add units and decade
;Key code units:
;
;          Esc  1  2  3  4  5  6  7  8  9
;          db   1b,31,32,33,34,35,36,37,38 ;00 (Code decade)
;
;          9  0  -  =  BS TB  q  w  e  r
;          db   39,30,2d,3d,08,09,71,77,65,72 ;10
;          t  y  u  i  o  p  [  ] CR Ctrl
;          db   74,79,75,69,6f,70,5b,5d,0d,82 ;20
;
;          a  s  d  f  g  h  j  k  l  ;
;          db   61,73,64,66,67,68,6a,6b,6c,3b ;30
;          '  ° SH  @  z  x  c  v  b  n
;          db   27,60,81,5c,7a,78,63,76,62,6e ;40
;
;          m  ,  -  / SH PS AL  CL F1
;          db   6d,2c,2e,2f,80,0f,83,20,85,01 ;50
;
;          F2 F3 F4 F5 F6 F7 F8 F9 F0 NL
;          db   02,03,04,05,06,07,08,09,0a,84 ;60
;
;          SL K7 K8 K9 K- K4 K5 K6 K+ K1
;          db   0c,17,18,19,0d,14,15,16,0b,11 ;70
;
;          K2 K3 K0 Del
;          db   12,13,10,0e ;80
    
```

.comment ¶The Dvorak keyboard is given by substituting the following lines for the corresponding lines above (identified by the decade code at the end of each line)

```

;
;          9  0  -  =  BS TB  '  ,  °  p
;          db   39,30,2d,3d,08,09,27,2c,2e,70 ;10
;
;          y  f  g  c  r  l  /  [ CR Ctrl
;          db   79,66,67,63,72,6c,2f,5b,0d,82 ;20
;
;          a  o  e  u  l  d  h  t  n  s
;          db   61,6f,65,75,69,64,68,74,6e,73 ;30
;
;          ]  ° SH  @  ;  q  j  k  x  b
;          db   5d,60,81,7a,3b,71,6a,6b,78,62 ;40
;
;          m  w  v  z SH PS AL  CL F1
;          db   6d,77,76,7a,80,0f,83,20,85,01 ;50
    
```

**Shift table for punctuation and numbers follows**

```

;
;          '  (  )  *  +  ,  -  -  /  0
TAB2:   db   22,00,00,00,00,3c,5f,3e,3f,29 ;Char to be shifted
                    ;Shifts codes 27H
                    ;to 3dH ('=*')
;
;          1  2  3  4  5  6  7  8  9  :
;          db   21,40,23,24,25,36,26,2a,28,00
;
;          ;  <  =
;          db   3a,00,2b
;
end     START
    
```



Text continued from page 403:

occur more than 75 percent of the time in English text, this arrangement contributes to very efficient typing.) Entering a Ctrl-Esc combination returns you to the initial mode, so you can switch back and forth at any time. See figures 1a and 1b for a comparison of these two keyboard layouts.

You can also assign alternate values for a number of keys. For example, the alternates for A, O, and U

are Å, Ö, and Ü. Similar translations are made for Spanish and French characters. The choices are dependent on values stored in the program, and so require a little work to change, but the program does show how to modify the keyboard output. In our technical word-processing system, we assign alternates that correspond to the characters on the IBM Selectric symbol type ball. Along with a screen character-generator change, this

allows you to edit mathematical text on screen. The program takes over the keyboard interrupt (number 17) accessed by PC DOS. Hence all standard software receives character codes set up by the routine (this method is very powerful). See the references for detailed information on these techniques.

### Encoding

With this overview in mind, let's

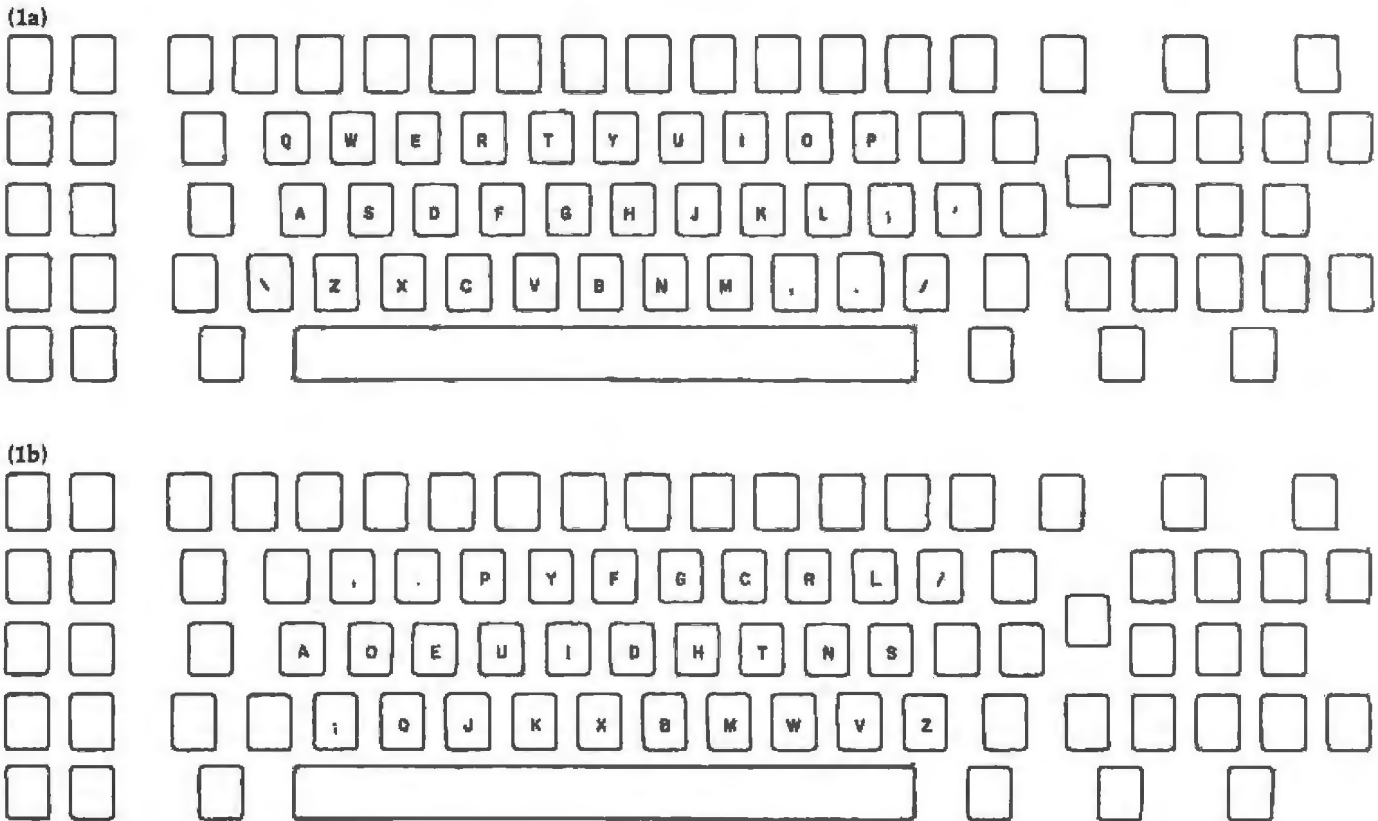


Figure 1: Comparison of the standard layout (1a) and the Dvorak layout (1b) on the IBM Personal Computer.

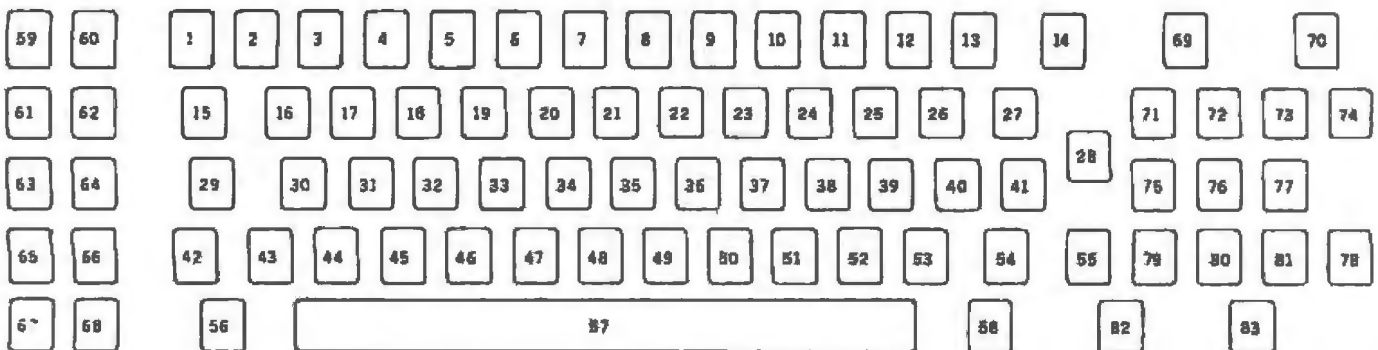


Figure 2: Make codes, expressed in decimal. When a key contact is made, the keyboard transmits the corresponding code serially as an 8-bit binary number. The same code, but with the high bit set to 1, is sent when a contact is broken.

now consider the encoding scheme in detail. Figure 2 shows the decimal values of each key's make code. The corresponding code when the key closure is broken (break code) is the same code plus 128. In binary, this corresponds to setting the high-order bit of a byte to 1.

Internally the keyboard generates this bit stream using the Intel 8048 as diagrammed in figure 3a. Five output bits from the 8048 cause a data-

distributor circuit to pull one of 23 normally high lines to a low level. A particular key connects one of these lines to one of four interrogation lines that run to a data-selector circuit read by the 8048. The 8048 scans the keyboard-switch array by continually checking the four lines one at a time to see if any are low. When it finds a closure, it waits a few milliseconds (ms) to let the contacts stop bouncing. The 8048 then stores the make

code in a buffer for transmission to the remote computer.

Similarly, if the 8048 notices that a key closure is broken, it stores the break code. The codes are sent out serially as described above. The 8048 also automatically repeats any key that remains down for longer than 1/2 second. The circuit in figure 3a includes a clock output line used by the IBM Personal Computer interface, reproduced in figure 3b, and an input

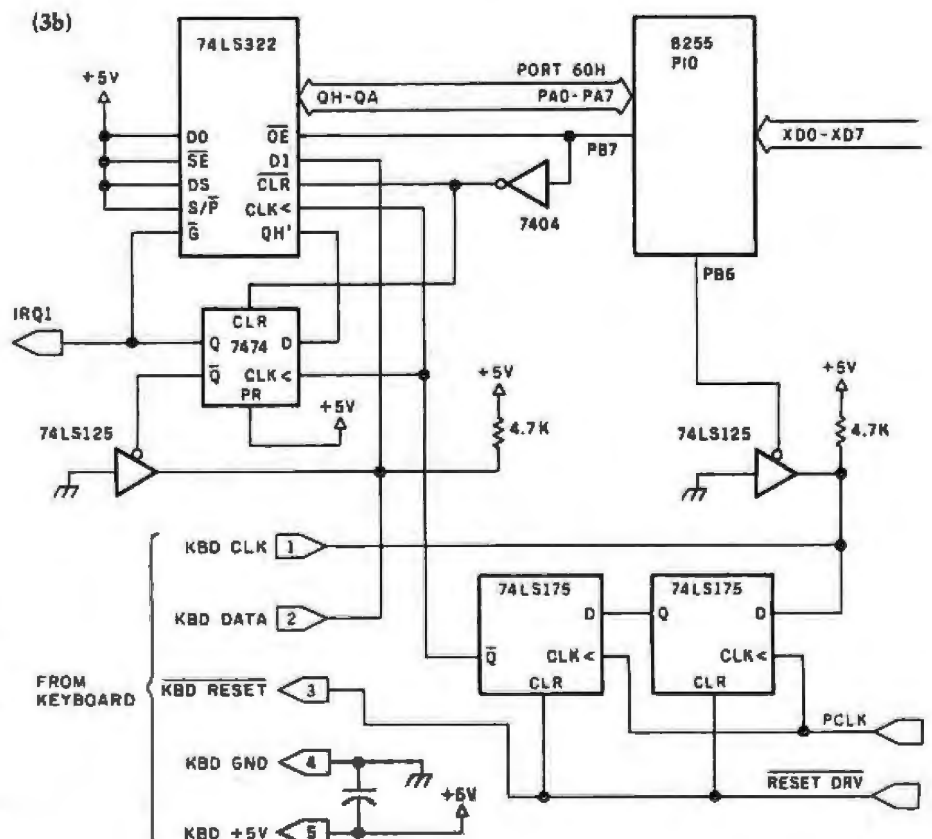
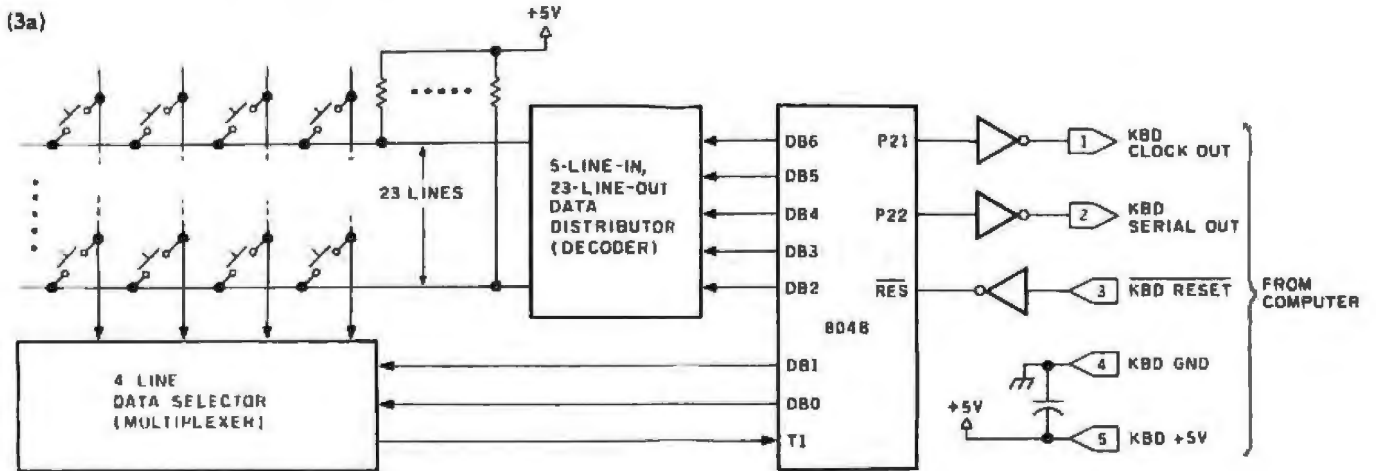


Figure 3: Interface circuitry used by IBM. Figure 3a is a partial diagram of the transmission circuitry used by IBM in its keyboard, as shown on page D-12 of the IBM Personal Computer Technical Reference Manual. The Personal Computer's keyboard input-port interface, from page D-10 of the manual, is shown in figure 3b.



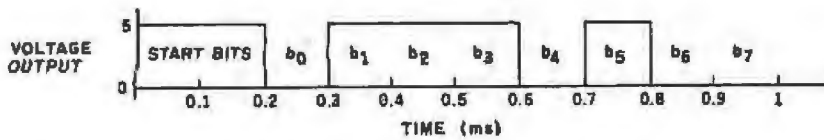


Figure 4: Diagram of the serial bit stream generated by the IBM PC keyboard when a key is pressed. The graph shows the voltage output (pin 2) versus time, starting when the C key (code 46 decimal, or 00101110 binary) is pressed. The voltage levels are TTL-compatible. In the absence of transmission, the keyboard sends a 0-V level. Two +5-V (high) "start bits" define the start of a character. Eight bits follow, each lasting 0.1 ms, except for the last, which is slightly shorter.

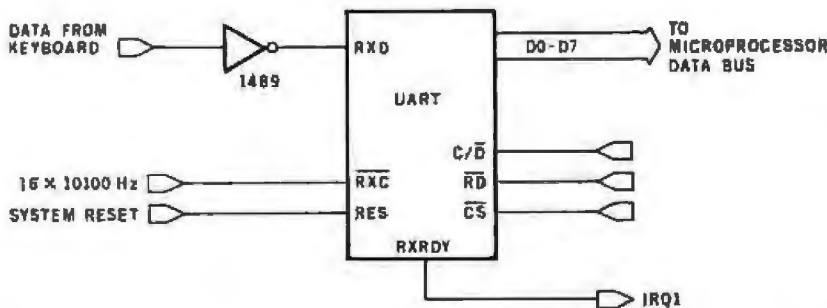


Figure 5: Interface circuit for using the IBM keyboard with another computer. The 1489-type inverting buffer changes the signal levels from the keyboard for use with the UART, which then changes the serial data to parallel format.

reset line. (The reset line is toggled by the restart routines of the IBM Personal Computer, but it's not necessary. The Key Tronic keyboard does require toggling of this line to function. The effect is that you can disconnect your IBM keyboard and reconnect it with no problem, but you have to perform a power-on restart before expecting the Key Tronic keyboard to continue after unplugging it.)

You can unscrew the covers of either keyboard to examine the circuits inside. This is necessary to exercise the many options available inside the Key Tronic but, as far as the IBM goes, will only satisfy your curiosity about how the IBM looks—there's nothing to change. The Key Tronic options allow interchanging the codes of certain keys and other features. We prefer to implement most of these options in software rather than by modifying jumpers inside the enclosure.

Figure 4 represents how the IBM keyboard transmits a code serially. When no code is being sent, the output remains low (0 volts). To indicate the start of a code, the keyboard output line goes high for 0.2 ms. The 8-bit pattern then follows at 0.1 ms per bit, low-order bit first.

This serial encoding is similar to that used on standard serial terminals. For these, an LSI (large-scale integration) circuit called a UART (universal asynchronous receiver/transmitter) is typically used to translate between the parallel and serial formats. One difference, however, is that the UART output stays high in the absence of character transmission—the opposite of the IBM Personal Computer keyboard. Also, UARTs start a character with a low signal for one bit period, whereas the IBM keyboard uses two high bit periods. But the IBM keyboard does send low-order bits first, followed by a parity bit.

## Interfacing to Other Hardware

Fortunately, you can easily take care of these differences. Although IBM did not choose to do so, the serial output of the keyboard can be read using a UART, provided you invert the signal. The keyboard's output is, in fact, very close to the EIA's (Electronic Industries Association) RS-232C voltage convention; effectively, the voltage polarity of the bit stream is inverted by this convention: a 1 is represented by a signal in the range of  $-3\text{ V}$  to  $-15\text{ V}$ , while a 0 falls between  $+3\text{ V}$  and  $+15\text{ V}$ . This convention is so common that standard integrated circuits (ICs) are manufactured to convert UART levels to the RS-232C standard.

The 1489-type quad line receiver yields a high for any signal less than about 0.8 V, and a low for any signal greater than about 1.7 V. To use the IBM keyboard with an RS-232C serial port, simply use the connection shown in figure 5. The data-transfer rate is usually 10,100 bps (bits per second, slightly less than 0.1 ms per bit period) because the break bit is a little shorter than 0.1 ms in duration. Except for the breaks, 9600 bps would work fine.

The next problem is that the "start bit" from the IBM keyboard is 2 bit periods long (hence you must disregard what the UART perceives as the low-order bit). Meanwhile, 8 significant bits follow, but the UART accepts only as many as 8 bits plus a parity bit, so we've developed the program in listing 3. It ignores the low-order bit, shifts all the more significant bits down one place, and replaces the high-order bit with the parity bit. (You can run this program and use a standard IBM serial port with the data rate set to 10,100 bps, but be very careful not to plug the output of the keyboard directly into an RS-232C line, or you'll destroy the output driver.) This method can also be used for the Key Tronic keyboard, which uses a data rate of 30,000 bps.

Other methods of reading the serial stream come to mind. You can copy the circuit used in the IBM Personal Computer itself, since it's published in the *IBM Personal Computer Technical Reference Manual* on page

D-10. This manual is a must for working with the keyboard because it gives the internal schematic of the keyboard. Figure 3b shows this circuitry but includes only those lines and integrated circuits that pertain to keyboard functions. (One advantage to using a UART is that it can communicate directly on a computer system's bus and requires no intervening parallel-port hardware.)

Very quickly, the operation of the circuit is as follows: The KBD CLK clock line from the keyboard is delayed two system clock periods and inverted by the pair of 74LS175 latches. This new signal is used to shift the KBD DATA bits into the

---

**The bit stream is quite simple and can be decoded directly.**

---

74LS322 serial-parallel shift register. When 8 bits have been shifted in, the 74LS322 carry is latched to provide an interrupt on the IRQ1 line. This calls IBM's INT 9 interrupt handler to read the character through the 8255 parallel input/output (I/O) circuit and to clear the interrupt. No data rate needs to be specified because the data is shifted in synchronously with the KBD CLK generated by the keyboard 8048 microprocessor.

Because the bit stream is quite simple, it can also be decoded directly using a single input line of a parallel port. To do this successfully, the computer must begin reading immediately after the start bit is sent. To avoid wasting time waiting for start bits, the rising edge of the start bit should be used to interrupt the computer. This interrupt should have the highest priority of all interrupts and require that the other interrupts be disabled for the 1 ms required for decoding the bit stream. (Such an interrupt-driven scheme is not undesirable; keyboards are substantially more powerful when interrupt driven, as described in references 1 and 2. In particular, you don't lose

Listing 3: UART decode program.

```

title    ra232 decoder
.z80
.radix 16

STATUS equ 1      ;Status port of UART
DATA   equ 0      ;Data port of UART

CI:     in        a,(STATUS)    ;Get status of UART
        ld        b,a          ;Put status byte into b
        and       2            ;Is a character waiting
        jr        z,CI         ;Wait if no character
        ld        a,37
        out      (STATUS),a    ;Clear status port
        in        a,(DATA)     ;Get character
        or        a
        jp       e,EVEN       ;Go if even parity in a
        bit      3,b          ;Check for a parity error
        jr        nz,CONT      ;Go if no error
        jr        STC         ;Go if error
EVEN:   bit      3,b          ;Check for parity error
        jr        z,CONT      ;Go if no error
STC:    scf                ;Set carry
CONT:   rra                ;Rotate carry into high bit of character
        cpl                ;Complement a
        push     af           ;Save character
        ld      e,37
        out    (STATUS),a    ;Clear status
        pop     af           ;Get character back
        ret
end

```

Listing 4: Parallel-bit decode subroutine.

```

DATA    equ 7          ;Port being used

WAIT:   in        a,(DATA)    ;Input from port
        bit      2,a          ;Is input bit high
        jr        z,WAIT      ;Wait if not high
        di                ;Disable interrupts. If interrupt-
                             ;driven, this is already done
        ld      b,38        ;Stall through two start bits
STALL:  djnz     STALL
        ld      c,6
        ld      b,8         ;Number of bits
GETIT:  in        a,(DATA)    ;Input bit
        rra                ;Rotate into carry
        rra                ;Use one rra for input bit zero
        rra                ;Two for input bit one, etc.
        rr
        call    DELAY       ;Stall until next bit is ready
        djnz   GETIT       ;Continue until all 8 bits received
        ld      a,c         ;Put character into a
        ret
DELAY:  ld      a,8         ;Delay, ld a with 8 for 4 MHz clock
DELAYO: dec     a
        jr     nz,DELAYO
        ret
end

```



**TOP QUALITY 5 1/4 DISKETTES**  
SPECIFY SOFT 10 or 18 SECTORS

- wabash**

	\$/10	\$/50	\$/100
SSDD (M13A411X)	23.45	112.00	218.00
DSDD (M14A411X)	30.43	146.00	286.00
- control data**

SSDD (CDC1242-00)	23.00	112.00	215.00
DSDD (CDC1244-00)	32.00	156.00	295.00
- verbatim**

SSDD (MD525-01-18158)	27.20	134.00	265.00
DSDD (MD550-01-18188)	40.00	196.00	385.00
- 3M scotch**

SSDD (3M 744D-0)	26.00	125.00	233.00
DSDD (3M 745-0)	36.00	175.00	309.00
- dysan**

SSDD (DYS 104-1D)	40.40	188.00	361.00
DSDD (DYS 104-2D)	47.30	231.00	426.50

**CALL TOLL FREE 800-824-7888**  
OPERATOR 906

**Creativity Unlimited FREE CATALOG**

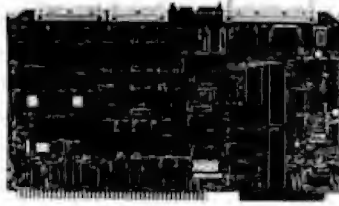
\* CHECKS MO VISA MC AND ST BE SHIPPING \* CA RESIDENTS ADD 6% SALES TAX

\* CHECKS MO VISA MC AND ST BE SHIPPING \* CA RESIDENTS ADD 6% SALES TAX

P.O. BOX 3304  
SARASOTA, FL 34201  
(408) 552-4210

Circle 141 on Inquiry card.

**EDGE-86**  
AN INDUSTRIAL QUALITY 8086 OEM SYSTEM



- HARDWARE**
  - A Multibus<sup>®</sup> COMPATIBLE 8086 CPU BOARD WITH DMA FLOPPY CONTROLLER, INTERRUPT CONTROLLER, PROGRAMMABLE TIMERS, 3 SERIAL PORTS, TWO PARALLEL I/O PORTS, AND 8K BYTES OF PROM WITH BOOT STRAP LOADER FOR CPM86<sup>™</sup>.
  - 128K BYTES DYNAMIC RAM BOARD.
  - 4-SLOT MULTIBUS CARD CAGE, WITH COMPLETE DOCUMENTATION AND SCHEMATICS; ALL FOR \$1299
- SOFTWARE**
  - CPM86 O.S. WITH COMPLETE UTILITIES. \$250
  - OFF THE SHELF DELIVERY—

**EDGE MICRO SYSTEMS**  
195 W. EL CAMINO REAL, SUNNYVALE, CA 94088  
TELEPHONE: 408-738-4728

\* Multibus TM of Intel, \*CPM86 TM of Digital Research

Circle 183 on Inquiry card.

**TIMEX-SINCLAIR**  
ZX81 1000



**1983 Directory**

- \* Where to find: Disk Drives, RAM Extensions, Printers, Modems, Keyboards, Game & Serious Software, Books, Periodicals, Programming Aids, and other Exciting Accessories!
- \* Articles on: Special applications like Control Circuitry, Enhanced Graphics, Voice Generation, Music Synthesis, Video Inversion, Light Pens, Joysticks, etc.
- \* Complete Descriptions: We'll tell you what it is, what it does, how much it costs, and where to buy it.
- \* Jam-packed w/photographs: We knew you'd want to see what these products look like. So, we got pictures and put them in!

**Only \$5.00 ... Postpaid!**

To Order: Send check, money order, or VISA/MC number and expiration date. MN residents add 6% sales tax.

Dealer Inquiries Welcome.

**E. Arthur Brown Company**  
Dept. BM-2 1702 Oak Knoll Drive  
Alexandria, MN 56308 Ph: 612/762-8847

(6a)

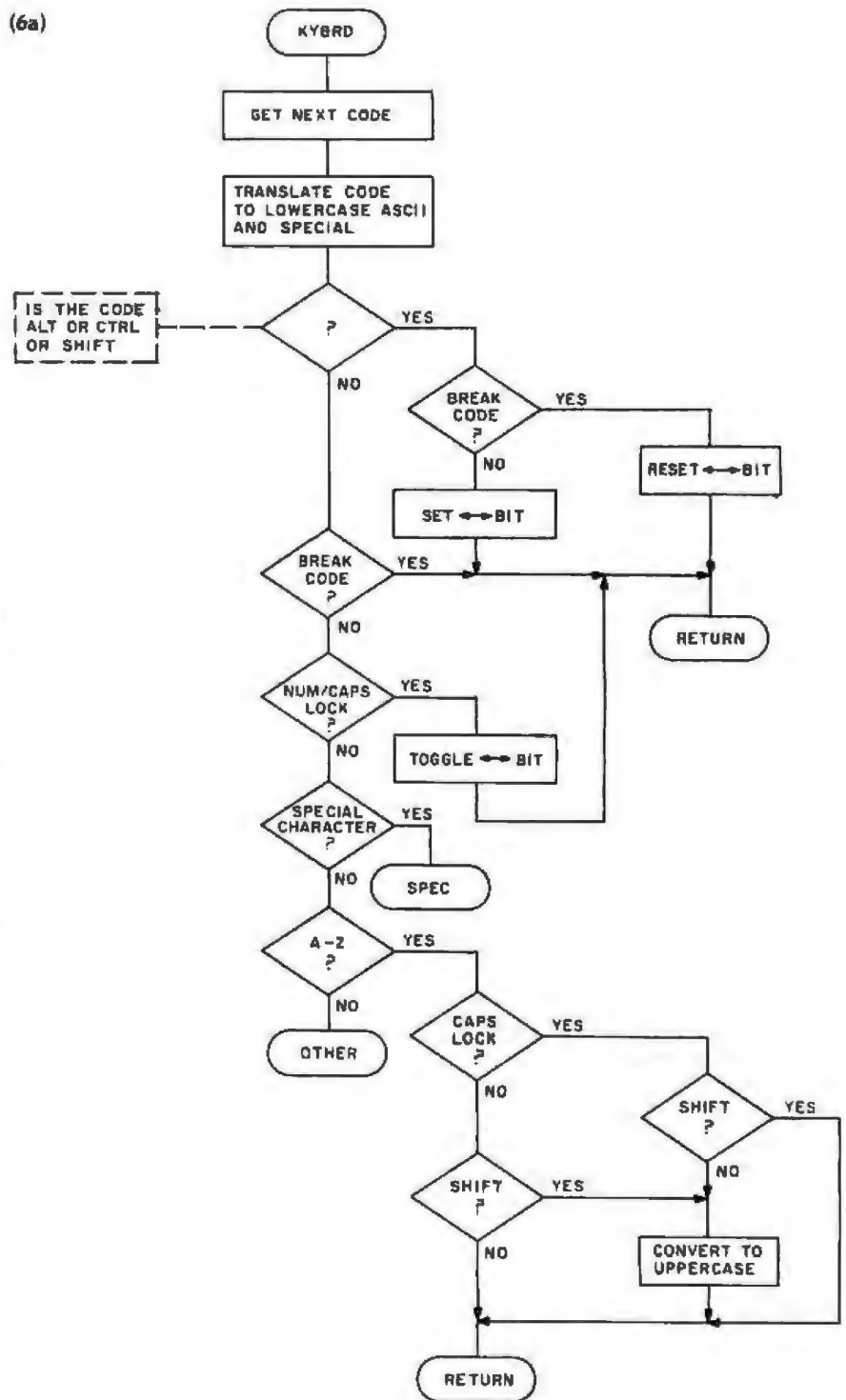


Figure 6: Flowchart of complete keyboard-encoder program shown in listing 2.

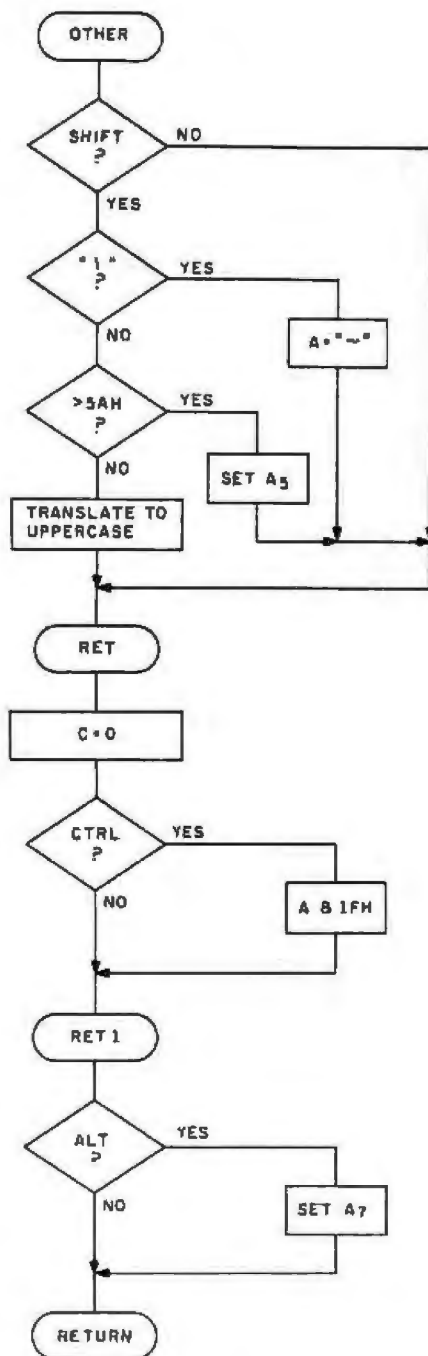
characters when you type faster than a program can process, and you can stop a program gone haywire to examine things with a machine-language monitor.) The IBM Personal Computer itself has several hardware interrupts, including the one for the keyboard, and is all the more powerful because of them. A program to

decode the serial stream is shown in listing 4.

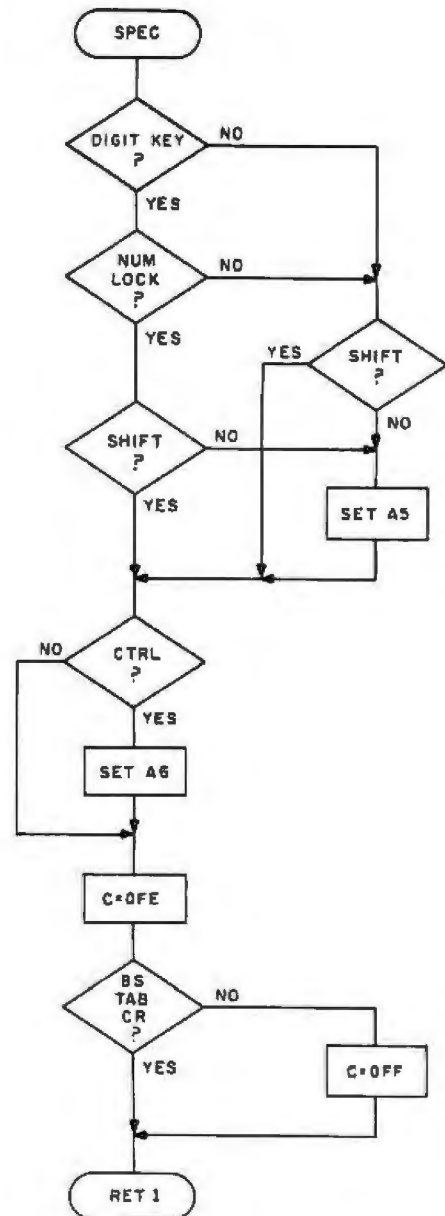
### Interfacing to Other Software

To perform truly useful functions, you must translate the complete set of make codes and break codes into the standard ASCII codes and useful extensions. Our translation scheme

(6b)



(6c)



works the same way as the IBM Personal Computer's for the ASCII subset but differs with respect to the special-function keys and the Alt key. The incompatibilities can be removed easily. Our algorithm is more powerful, simpler to understand and implement than IBM's, and one third as long. In any event, it illustrates how one can go about translations in general. IBM's program is published for the Intel 8086 microprocessor in the technical reference manual star-

ting on page A-24.

Figure 6 shows the flowchart for a keyboard translator written for the Z80 microprocessor using the Microsoft M80 assembler. (The program itself is given in listing 2.) The 128 standard ASCII codes are returned in the accumulator (the A register) with values given in table 1. If the Alt key is pressed when one of these codes is deciphered, bit 7 of the accumulator is set to 1. This immediately produces an alternate set of codes that round

out the 256 possibilities available with 8 bits. We often make the alternate set correspond to a second daisy wheel for printing mathematical documents. The alternate set plays the role of the IBM Selectric symbol ball, but other uses abound.

These 256 standard-key codes are returned in register A with a value of 0 in register C. The codes returned by the special-function and cursor-pad keys are also returned in A but with register C equal to hexadecimal OFF.



hexadecimal decimal			hexadecimal decimal			hexadecimal decimal			hexadecimal decimal		
0	0	0	space	20	32	@	40	64	`	60	96
1	1	1		21	33	A	41	65	a	61	97
2	2	2	"	22	34	B	42	66	b	62	98
3	3	3	#	23	35	C	43	67	c	63	99
4	4	4	\$	24	36	D	44	68	d	64	100
5	5	5	%	25	37	E	45	69	e	65	101
6	6	6	&	26	38	F	46	70	f	66	102
7	7	7	'	27	39	G	47	71	g	67	103
8	8	8	(	28	40	H	48	72	h	68	104
9	9	9	)	29	41	I	49	73	i	69	105
0A	10	10	[	2A	42	J	4A	74	j	6A	106
0B	11	11	+	2B	43	K	4B	75	k	6B	107
0C	12	12	,	2C	44	L	4C	76	l	6C	108
0D	13	13	-	2D	45	M	4D	77	m	6D	109
0E	14	14	.	2E	46	N	4E	78	n	6E	110
0F	15	15	/	2F	47	O	4F	79	o	6F	111
P	10	16	0	30	48	P	50	80	p	70	112
Q	11	17	1	31	49	Q	51	81	q	71	113
R	12	18	2	32	50	R	52	82	r	72	114
S	13	19	3	33	51	S	53	83	s	73	115
T	14	20	4	34	52	T	54	84	t	74	116
U	15	21	5	35	53	U	55	85	u	75	117
V	16	22	6	36	54	V	56	86	v	76	118
W	17	23	7	37	55	W	57	87	w	77	119
X	18	24	8	38	56	X	58	88	x	78	120
Y	19	25	9	39	57	Y	59	89	y	79	121
1A	26	26	:	3A	58	Z	5A	90	z	7A	122
1B	27	27	;	3B	59	[	5B	91	{	7B	123
1C	28	28	<	3C	60	\	5C	92		7C	124
1D	29	29	=	3D	61	]	5D	93	}	7D	125
1E	30	30	>	3E	62	^	5E	94	~	7E	126
1F	31	31	?	3F	63	_	5F	95	Del	7F	127

**Table 1: The ASCII table of character codes.** The program in listing 2 returns these codes in the Z80 accumulator (A) and returns a value of 0 in the C register, indicating a code from the regular keyboard. The symbol "~" indicates the Ctrl key has been pressed while another key was pressed. Capital letters are returned when a shift key is pressed. The same codes with bit 7 set to 1 are returned if the Alt key is pressed as well. See table 2 for codes returned from the special-function keys and the cursor/numeric keypad.

Their values are given in table 2. As for the codes in table 1, if the Alt key is depressed, bit 7 of the code is set to 1. The shift and Ctrl keys set bit 5 and bit 6, respectively. This somewhat strange (relative to ASCII) choice was made so that the codes correspond to their names. For example, the numeric keypad's numeral keys should return their ASCII codes when the shift key is depressed, in contrast to their counterparts on the typewriter portion of the keyboard, which return the ASCII codes while unshifted.

The special-function keys F1 through F10 correspond to codes 1 through hexadecimal 0A (decimal 10), and the numerals 0 through 9 correspond to codes hexadecimal 10 through 19, allowing you to

remember them easily. The back-space, tab, and carriage-return (enter) keys give the values 8, 9, and D, respectively; but, unlike their counterparts Ctrl-H, Ctrl-I, and Ctrl-M, the value hexadecimal 0FE is returned in the C register. This allows you to distinguish between the control characters, the function keys, and these special keys—a very useful feature for word-processing systems.

Because any combination of Ctrl, shift, and Alt keys are returned along with the special keys, many combinations are available for word processing and other applications. In particular, the software used by the IBM Personal Computer doesn't return anything for Ctrl-uparrow. This is too bad because text editors typically use Ctrl-leftarrow to mean move

back a word and Ctrl-rightarrow to mean move forward a word, and similarly, you'd like Ctrl-uparrow to mean move up a few lines, and Ctrl-downarrow to mean move down a few lines. In this connection, it's interesting to note that touch-typists typically find the regular control characters easier to use for cursor motion than cursor-pad or special-function keys because the regular keys can be touch-typed without departing from the usual typing position. For example, this article was written using the super Pmate context/screen editor, which fully supports both the regular control characters and all IBM's special keys. However, we seldom use the special keys because they require looking at the keyboard.

## PC/FORTH™

Complete FORTH program development systems for the IBM® Personal Computer. Packages include interpreter/compiler with virtual memory management, line editor, custom screen editor, assembler, decompiler, utilities, file and record access modules, and many demonstration programs. 150 page user manual. .... \$100.00

Software floating point, Intel 8087 support, color graphics extensions, and target compiler available at additional cost.

Specify PC-DOS or CP/M-86®. One disk drive and 48 kbytes RAM required. Software supplied on 5¼ inch single sided soft sector double density diskettes.

### Laboratory Microsystems

4147 Beethoven Street  
Los Angeles, CA 90066  
(213) 386-7412

IBM is a registered trademark of International Business Machines Corp.  
CP/M is a registered trademark of Digital Research Inc.

Circle 514 on inquiry card.

## APPLE® COMPATIBLE SYSTEM SALES

A W/P Package Incl:  
APPLE® COMPATIBLE W/64K  
RAMA ELITE ONE W/CNTR  
12" AMBER MONITOR  
SMITH/CORONA TP-1 PRINTER  
WORD PROCESSING SOFT

**ON SALE \$1899**

**AND MORE—Savings & Selection**

Apple IIe	CALL
KeyPro II	\$1499
Franklin Ace 1000	\$ 929
Colt mbia MPC	\$2295
Syscom 2	\$ 649
IBM P/C	On Sale
Smith-Corona TP-1	\$ 558
Gemini 10 Dot Matrix	\$ 329

For Complete Selection and  
Lowest Prices — Free Catalog

## COMPUTERS and more

2420 University Ave., Suite 3, San Diego, Ca. 92104  
(619) 291-1442, Telex 887120, Datamax Attr: Dept. 322

Circle 513 on inquiry card.

## MediScript

MediScript I is a powerful word processor designed for the IBM-PC and newcomer to word processing. Simple to use yet has all common functions (such as word wrap and paragraph relocations). Additional functions in MediScript II include right justification, character graphics, fielded forms, and mailing list generation.

MediScript I	\$49.50
MediScript II	\$99.50

(plus 6% in CA) 30 day satisfaction guaranteed or your money back, minus \$4.00 for shipping and handling

**MediSoft**



Medical Professions Building  
1595 Soquel Drive, Suite 350  
Santa Cruz, CA 95065

Circle 515 on inquiry card.

Key	Value	Shift value	Ctrl value	Alt value
	00	20	40	80
F1	01	21	41	81
F2	02	22	42	82
F3	03	23	43	83
F4	04	24	44	84
F5	05	25	45	85
F6	06	26	46	86
F7	07	27	47	87
F8	08	28	48	88
F9	09	29	49	89
F10	0A	2A	4A	8A
+	0B	2B	4B	8B
Scroll Lock	0C	2C	4C	8C
-	0D	2D	4D	8D
.	0E	2E	4E	8E
	0F	2F	4F	8F
0	10	30	50	90
1	11	31	51	91
2	12	32	52	92
3	13	33	53	93
4	14	34	54	94
5	15	35	55	95
6	16	36	56	96
7	17	37	57	97
8	18	38	58	98
9	19	39	59	99
	1A	3A	5A	9A
	1B	3B	5B	9B
	1C	3C	5C	9C
	1D	3D	5D	9D
	1E	3E	5E	9E
BS	08	28	48	88
TAB	09	29	49	89
CR	0D	2D	4D	8D

**Table 2: Hexadecimal key values returned in register A for special-function and cursor/numeric keys with no shift keys pressed, or one alone. Additional combinations can be made by pressing two or three shift keys simultaneously, e.g., shift-Ctrl-F1 yields 61. Shift sets bit 5, Ctrl sets bit 6, and Alt sets bit 7. Register C returns with hexadecimal 0FF for all combinations except BS, TAB, and CR, for which C equals hexadecimal 0FE (so as not to be identical to F8, F9, and -). BS stands for back-arrow, and CR stands for carriage return. Note that codes returned in A for keys like the regular keyboard keys (e.g., the shifted digits 0 through 9) are the same as the ASCII values. The value in register C allows the user to differentiate between these codes.**

### Finishing Up

We've described the aesthetic and practical features of the IBM Personal Computer keyboard, showing how the keyboard both looks and acts like the leader in the field. We've shown how you can tailor the keyboard input driver to suit your needs, including an implementation of the Dvorak keyboard layout. The keyboard plays a significant role in making the IBM Personal Computer such a pleasure to use. With the simple interfacing described in this article, you can increase the pleasure of using other computers. ■

### References

1. Sargent, M., III, and R. L. Shoemaker. *The IBM Personal Computer from the Inside Out*. Reading, MA: Addison-Wesley, 1983. This book contains a program that turns the IBM PC keyboard into a piano keyboard, with the shift keys shifting up an octave and the Alt and Caps Lock Keys shifting down an octave.
2. For further discussion, see M. Sargent III and R. L. Shoemaker, *Interfacing Microcomputers to the Real World*. Reading, MA: Addison-Wesley, 1981
3. *The IBM Personal Computer Technical Reference Manual*, available wherever IBM Personal Computers are sold.



# At Palomar Graduate

# to Lower Prices!

And get an Advanced Degree of (1) expert technical advice, (2) fast response on orders, (3) in-house service repairs, and (4) guaranteed satisfaction.



Many items are not listed. Please call our 800 number if you don't see what you're looking for.



## APPLE SYSTEMS SPECIAL

Apple-Compatible 48K Computer with Super 5 Disk Drive and Controller, BMC 12" Green Screen Monitor ... **NOW—\$1,255.00**

Same system with a 64K Franklin Ace 1000 ..... \$1525.00  
Same system with a 48K Apple II e ..... \$1595.00

## PERSONAL COMPUTERS

<b>ALTOS</b> ACS 8000-2 ACS 8000-15	3199.00 4399.00	<b>MORROW</b> Micro Decision with Terminal & 1 Drive Micro Decision with Terminal & 2 Drives	CALL CALL
<b>APPLE</b> Apple II Plus Disk II D.O.S. 3 Disk II	CALL CALL CALL	<b>OSBORNE</b> Osborne I Portable, Includes \$200 Extras With Double Density Drives	1795.00 1995.00
<b>BASIS</b> 108-0003 (64K) 108-0004 (128K)	CALL CALL	<b>TELEVIDEO</b> TS 802 TS 806 TS 818	3119.00 5735.00 10365.00
<b>CHAMELEON</b> IBM-Compatible	1895.00	<b>XEROX</b> 820 with CP/M, Wordstar	1995.00
<b>FRANKLIN</b> ACE 1000 (64K) ACE 10, Disk Drive	CALL CALL	<b>VICTOR</b> 9000 (SS) 2 Single-sided Drives 9000 (DS) 2 Double-sided Drives 9000 (HD) 1 Double-sided Drive, 10 Mb Hard Disk	CALL CALL CALL
<b>IBM</b> IBM PC	CALL		
<b>SANYO</b> MB1000	1795.00		

## MODEMS

<b>HAYES</b> Micromodem II (Apple II) Micromodem II With Terminal Program Micromodem 100 (\$-100) Smartmodem 1200 Baud Chronograph (RS-232) Terminal Program	289.00 315.00 339.00 599.00 195.00 75.00	<b>NOVATION</b> CAT (Acoustic) D-CAT J-CAT Smart CAT 103/212 212 Auto CAT Apple CAT II 212 Apple CAT	145.00 159.00 139.00 205.00 599.00 299.00 609.00
---	---	---	--

## DISK DRIVES

Disk II With Controller Card Media Distributing 11 Mb Winchester Subsystem Media Distributing 22 Mb Winchester Subsystem Media Distributing 44 Mb Winchester Subsystem Microsci A35 With Controller Card Microsci Controller Card Rana Disk Drive Rana Controller	CALL 2595.00 3495.00 4270.00 375.00 99.00 319.00 109.00	Super 5 Disc Drive Super 5 Controller Card Super 5 Double-sided Disk Drive Super 5 Controller Card for Double-sided Disk Drive Corona 5MB Winchester Corona 10MB Winchester	299.00 89.00 429.00 109.00 CALL CALL
---	--	--	---



# APPLE

## HARDWARE

ALS Z Card	159.00	Mountain Computer Rampus (32K)	179.00
ALS CP/M Card	379.00	MPC Serial Printer Card	89.00
ALS CP/M Card with SuperCalc	595.00	M & R Super Fan	40.00
Apple II Plus	CALL	Nikrom Master Diagnostics	45.00
CCS IEEE Card	175.00	Novation Apple Cat	299.00
CCS Analog/Digital Card	105.00	Novation Expansion Module	35.00
Computer Peripherals		Novation J-Cat	139.00
Octopus 16K Buffer	165.00	Novation Handset	27.00
CPS Multifunction Card	179.00	Numeric Key Pad	150.00
Echo II Speech Synthesizer	125.00	Paymar Lower Case Adapters.	
EDP AC Surge Protector	49.00	Old (Rev. 1-5)	29.00
EDP EMI-RFI Filter	39.00	New (Rev. 7)	19.00
Expandaport-6 Ports With Speaker	55.00	PCPI Appli-card, Multifunction	
Hayes Micromodem II	299.00	Z 80 Card	249.00
Microbuffer II 16K	219.00	PCPI 88 Card-16K CPU	659.00
Microbuffer II 32K	245.00	Softworks R.O.S.	559.00
Microsoft Z80 Softcard with CR/M	265.00	STB 64K Expansion Card	239.00
Microtek 16K Ram Card	79.00	STB 128K Memory Card	399.00
Microtek Parallel Printer Card	69.00	System Saver-Fan/Outlets/Switch	79.00
Microtek Graphics Card	109.00	TG Game Paddles	29.00
Microtek Graphics Card-16K	185.00	TG Joy Sticks	45.00
Microtek Graphics Card-(32K)	235.00	TG Select-A-Port	45.00
Microtek Graphics Card-(64K)	305.00	Videx 80 Column Card	279.00
Microtek Q Disk (128K)	399.00	Videx Enhancer II (Rev. 7)	119.00
Microtek Magnum 80-Column Card	209.00	Videx Function Strip	65.00
Mountain Computer Romwriter	145.00	Viewmax 80	199.00

Palomar features a complete selection of Apple and IBM Software. Call for details.

# IBM

## HARDWARE

IBM PC	CALL	Computer Peripherals 64 I/O	
Amdek Color II RGB Monitor	799.00	Memory Card	299.00
Amdek 3" Dual Disk Drive	785.00	Computer Peripherals Octopus	
BMC 12" Green Monitor	149.00	Printer Buffer	165.00
BMC Color Composite Monitor		Computer Peripherals	
with Sound	399.00	64K Memory Card	199.00
BMC Hi-Res RGB Monitor	759.00	MPI 320K Drive	299.00
Computer Peripherals 64K Ram	199.00	PSS Hi-Res RGB 12" Monitor	759.00
Computer Peripherals I/O Printer		PMC Disk Drive	199.00
Interface (4 Ports)	159.00	Ram Plus Quad Board	415.00

# MONITORS

<b>BMC</b>		<b>ZENITH</b>	
BM-12AU 12" Green	89.00	12" Green	119.00
BM 12AU 12" Amber	99.00	<b>NEC</b>	
BM-12 EUN 12" Green	149.00	PC-8041A-12" Green	159.00
BM-1401 RGB with Card		<b>AMDEK</b>	
and/or Cable	399.00	Video 300-12" Green	165.00
BM-AU919U Color. Composite		Color I -13" Color Composite	349.00
Sound	399.00	Color II -Hi Res. RGB	749.00
BM-AU9191U RGB for IBM-PC	759.00	Color III -Lo Res. RGB	439.00
<b>COMREX</b>		RGB Apple II Card	165.00
CR 5500-12" Green	155.00	<b>SANYO</b>	
CR 6500-13" Composite	315.00	9" Hi Res. Green	159.00
CR 6600-13" RGB	429.00	12" Green Screen	135.00
<b>ELECTROHOME</b>		12" Hi Res. Green	209.00
13" RGB	339.00	13" Color	419.00
13" Hi Res. RGB	589.00	13" Hi Res. Color	899.00
Apple II Interface	199.00	<b>U.S.I.</b>	
IBM 15 Color Cable	35	9" Green Screen	119.00
<b>TAXAN</b>		9" Amber Screen	155.00
KG 12H-12" Green	CALL	12" Green Screen	155.00
KA 12N-12" Amber	CALL	12" Amber Screen	175.00
RGB Vision I-12" RGB	CALL	<b>P.G.S.</b>	
RGB Vision II-12" RGB	CALL	12" Hi-Res RGB for IBM	759.00
RGB Apple II Card	CALL		

# PRINTERS

<b>BMC</b>		<b>OKIDATA</b>	
BM/PB101 Parallel	825.00	Microline 82-A	489.00
<b>EPSON</b>		Microline 83-A	689.00
ASAP 2K Serial	59.00	Microline 84-S	1199.00
Comrex 4K Serial Buffer	139.00	Microline 84-P	1059.00
Microbuffer-16K Parallel	139.00	2K Parallel Interface	129.00
Microbuffer-8K Serial	138.00	Forms Tractor (82-A)	55.00
<b>FACIT</b>		<b>OLYMPIA</b>	
4510	635.00	COMPACT Serial Interface	849.00
<b>NEC</b>		ES 100 KRO	949.00
3510 RO Serial	1515.00	ES 100	899.00
3520 KSR Serial	2100.00	Serial/Parallel Interface	250.00
3530 RO Parallel	1695.00	CCS Apple Serial Card	135.00
3550 RO IBM	1880.00	<b>SMITH CORONA</b>	
7710 RO Serial	2325.00	TP-1	599.00
7730 RO Parallel	2395.00	<b>STAR MICRONICS</b>	
8023-A Dot Matrix	489.00	Gemin 10	CALL
Bi-Directional Tractor (3500)	230.00	Gemin 15	CALL
Cut Sheet Guide (3500)	90.00	<b>TEC</b>	
Envelope Handler (3500)	270.00	PMC 8510 Parallel	465.00
Horizontal Tractor (7700)	150.00	PMC 8510 Serial	585.00
Bi-Directional Tractor (7700)	345.00	ITOH 8510-A Parallel	469.00
Friction Attachment (7700)	35.00	ITOH 8510-A Serial	619.00
<b>NOVELL</b>		ITOH 1550 Parallel	750.00
Image 600	999.00	ITOH 1550 Serial	789.00
		ITOH F-10-40	1395.00
		ITOH F-10-55	1795.00



Palomar makes buying easy ...



# ORDER TOLL-FREE! Call 800-237-3333

In California call 800-338-5555

Telex 697120-150

**TERMS OF SALE:** Cash, Check, money order, bank wire transfer, credit card, or purchase orders from qualified firms and institutions. Please include telephone number with order and expiration date on credit card orders. California residents add 6% sales tax. Advertised prices are for prepaid orders F.O.B. shipping point. Add 3% or \$3.00 minimum for shipping in the U.S. Pricing and availability subject to change without notice. Address written orders to:

910-105 W. San Marcos Blvd., San Marcos, CA 92069  
Telephone (619) 744-7314

# PALOMAR

COMPUTER PRODUCTS



# Strongly Typed Languages

*Ada, Pascal, and other new languages let you define your own data types*

In recent years, new programming languages have introduced the concept of strongly typed data—a novel idea for persons experienced in the earlier, weakly typed languages such as FORTRAN, COBOL, BASIC, and PL/I. This article explains the reasons behind the strongly typed concept and how it can be used to the programmer's advantage.

## Background

All high-level programming languages define a set of basic data types, such as INTEGER or REAL, and operations appropriate for those types. A data type and the set of legal operations for that type have come to be known as a *data abstraction*. Abstraction is not used here in the sense of complex or difficult; it merely means the essential feature of a datum, such as the fact that it is an integer quantity. This is an extremely useful concept because it lets programmers concentrate on the problem at hand, rather than on the details of its solution.

First-generation languages such as FORTRAN, COBOL, and PL/I support useful and powerful data ab-

---

Earl E. McCoy  
71 Cedar Hill Rd.  
Newtown, CT 06470

---

stractions. In FORTRAN-77, for example, a character-string operation, say concatenation, cannot be legally applied to data of type REAL. If this were attempted, the compiler would indicate an error.

Many problems, however, can snare the unwary programmer. For example, the FORTRAN data abstractions for REAL and INTEGER types are ambiguous: they use the same symbols for most operations. Both types, for example, use the slash symbol (/) for division, but its meaning differs in each case. This results in the common error of 1 divided by 2 returning 0 when 0.5 was expected. An experienced programmer is aware of the problems resulting from poorly defined data abstractions and avoids them.

The problem with data abstraction in first-generation languages, however, goes even deeper. First-generation data types are too abstract. It is possible, for example, to add INTEGER variables, even though they represent different classes of objects, such as apples and oranges. Because the language does not recognize such concrete data types, it cannot warn the programmer when they are incor-

rectly combined. In listing 1, for example, a FORTRAN compiler cannot prevent the addition and assignment operations because it is not "apples" and "oranges" being summed, but rather integer values for which addition and assignment are legally defined. Note that in this values problem, FORTRAN would allow the identifiers to assume negative values, even though such values might be meaningless. Programmers are expected to recognize and avoid such illogical operations. The result is usually a longer and more tedious debugging phase than would otherwise be necessary.

## A Solution

Problems such as these have led to the extension of the data-abstraction concept into a more powerful form in a new generation of strongly typed languages of which Pascal and Ada are representative examples. Developed as a teaching tool, Pascal is widely available and is used at most universities as the language of choice among computer science faculty and students. Ada, an extension and generalization of Pascal, was sponsored by the Department of Defense and is expected to attain wide use in both civilian and military applications. Ada is more strongly typed than Pascal; some examples discussed in this article apply only to Ada.

---

## About the Author

Earl E. McCoy is a professor at Central Connecticut State College in New Britain. He teaches courses in computer science and management-information systems.

---

Nobody offers you a wider variety of computer printers and printer experience than Facit/Dataroyal... all the way from low cost (\$695 list) matrix printers, to sophisticated graphics and color matrix printers, to models that print variable size characters and bar codes, to "daisy wheels" and a multimode near letter-quality printer. Industry standard parallel and RS232C serial interfaces are available in all printers.

Our products are built to perform day after day in the most rugged

environments. We achieve that kind of reliability by incorporating modern, trouble-free LSI circuitry, and fewer moving mechanical parts along with a high level of quality control.

Hundreds of computer systems manufacturers choose Facit/Dataroyal products with confidence, as do a great number of Fortune 500 companies who use Facit/Dataroyal peripherals with their systems.

If you want a trouble-free printer, contact your local computer

printer dealer or Facit/Dataroyal, 235 Main Dunstable Road, P.O. Box 828, Nashua, NH 03061, (603) 883-4157.



**FACIT  
DATAROYAL**

Circle 151 on Inquiry card.

**Printers, printers, and more printers.**





**Listing 1: Defining an integer identifier in FORTRAN.**

```

.
.
.
INTEGER apples, oranges, pears
.
.
pears = apples + oranges
.
.

```

**Listing 2: Ada allows a programmer to define new data types derived from built-in types.**

```

TYPE apples IS NEW INTEGER RANGE
  0..1000;
TYPE oranges IS NEW INTEGER RANGE
  0..1000;
redapples, greenapples, totalapples :
  apples;
florida, california : oranges;
.
totalapples := redapples + greenapples;
--legal
(florida := redapples + california; --illegal)
.

```

**Listing 3: This Ada subprogram defines a data type for digital images and specifies valid operations for the new type.**

```

TYPE size IS NEW INTEGER RANGE
  0..255;
TYPE pixel IS NEW INTEGER RANGE
  0..63;
TYPE picture IS ARRAY (size, size) OF
  pixel;
frame1, frame2, frame3 : picture;
.
PROCEDURE contrast (a : IN picture, b :
  OUT picture);
.
END contrast;
PROCEDURE edgedetect (a : IN picture, b :
  OUT picture);
.
END edgedetect;
PROCEDURE brighten (a : IN picture, b :
  OUT picture);
.
END brighten;
.

```

A strongly typed language like Ada helps programmers avoid contextual logic errors by allowing them to define their own data types. The Ada program shown in listing 2, for example, uses the TYPE statement to define two new data types, "apples" and "oranges," which may have integer values ranging from 0 to 1000. Because both types are instances of the predefined type INTEGER, they inherit all the operations allowable for integers. Thus, all identifiers of the type "apples" may be added among themselves; so too may all identifiers of type "oranges." However, identifiers of type "apples" and type "oranges" may *not* be added together because they are of a different type. Identifiers of differing types may not be operated upon, even though they may be of the same underlying primitive type, as in this case. Thus, the data-abstraction concept provides a mechanism for enforcing logical correctness upon a program.

For this enforcement policy, a penalty must be paid in processing overhead. For instance, subrange values must be checked during program execution, which slows down the program somewhat. However, if the subrange check guarantees correct operation of the program, it's probably worth the price. Moreover, most type checking can be done at compile time, which exacts a small penalty for the benefit returned.

Programmers may avoid the overhead penalty. For example, in listing 2, a programmer could have avoided the subrange checking by not specifying a range in the TYPE statement. To eliminate the compile-time type check, the programmer could omit the TYPE statements entirely and simply declare the identifiers as integers, as is done in FORTRAN.

### More Data Abstractions

In addition to inheriting operations from primitive data types, user-defined types can also specify new operations. This allows a programmer to define a data abstraction in the full sense of the term.

In an image-processing program, a programmer might want to opera-

**Listing 4: Ada's enumerated types make for more readable programs.**

```

TYPE automobile IS (ford, chevy, buick,
  datsun);
TYPE emissions IS (clean, dirty);
cars : ARRAY (automobile, emissions) OF
  INTEGER
air : emissions;
.
cars(ford, clean) := cars(ford, clean) + 1;
.

```

tionally limit contrast enhance, edge detect, and brighten digitally encoded "pictures." In Ada, this may be accomplished by first defining a type "picture" in terms of more primitive types as shown in listing 3. Specifically, a picture datum is defined as a 256 by 256 array of picture elements (pixels), each having 64 possible gray levels.

The type "picture" does not inherit any of the operations valid for an array because it is defined (implicitly) as a private type (a special feature of Ada). Instead, the programmer defines the operations valid for picture data via the subprogram units shown in listing 3.

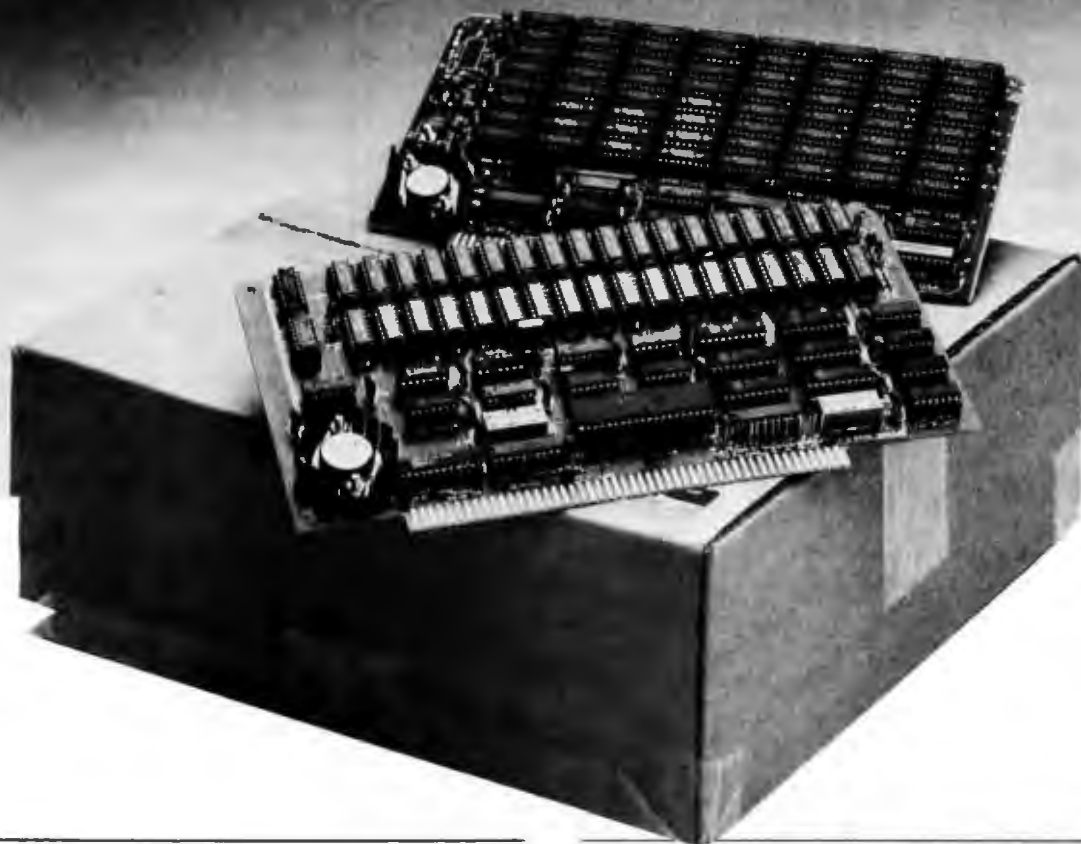
The advantage of user-defined data types is that they enable the computer to ensure that procedures process only data of the correct type. For example, defining a data structure as in listing 3 enables the computer to ensure that only pictures with the proper size, picture elements, and valid shades of gray are passed to the picture-processing procedures. Weakly typed languages can offer such protection only for predefined primitive data types.

### New Primitive Data Types

Complementing the usual predefined primitive data types, such as INTEGER, CHARACTER, and REAL, Pascal and Ada have a new data type, called *scalar* in Pascal and *enumerated* in Ada.

Enumerated types make for more readable programs. Identifiers of this type may assume only those values listed by the programmer (see listing 4). The enumerated values may be

# RAMS TO GO.



**During the month of May, we are offering special pricing on two of our quality RAM products: RAM67 and RAM128/256.**

	Reg. Price	Special Price
RAM67	\$ 1200.	<b>\$ 1095</b>
RAM256	795.	<b>695</b>
RAM128	495.	<b>395</b>

RAM67 provides the high performance you expect from a static RAM, but also, provides low power and high density usually associated with a dynamic RAM. The CMOS RAM insures long, cool reliable service. RAM128/256 provides high density and a low price. Our dynamic RAM is ideally suited to memory intensive sixteen bit application and RAM disk emulations. Both LDP boards meet the specifications of IEEE 696 and are backed by our one year guarantee.

To order your RAM, call LDP or one of our authorized dealers—but, don't delay... special pricing ends May 31, 1983.

Lomas Data Products offers a full line of quality S100 bus products... systems, software and other "no-nonsense" boards.

Dealer and OEM inquiries invited.

# LDP

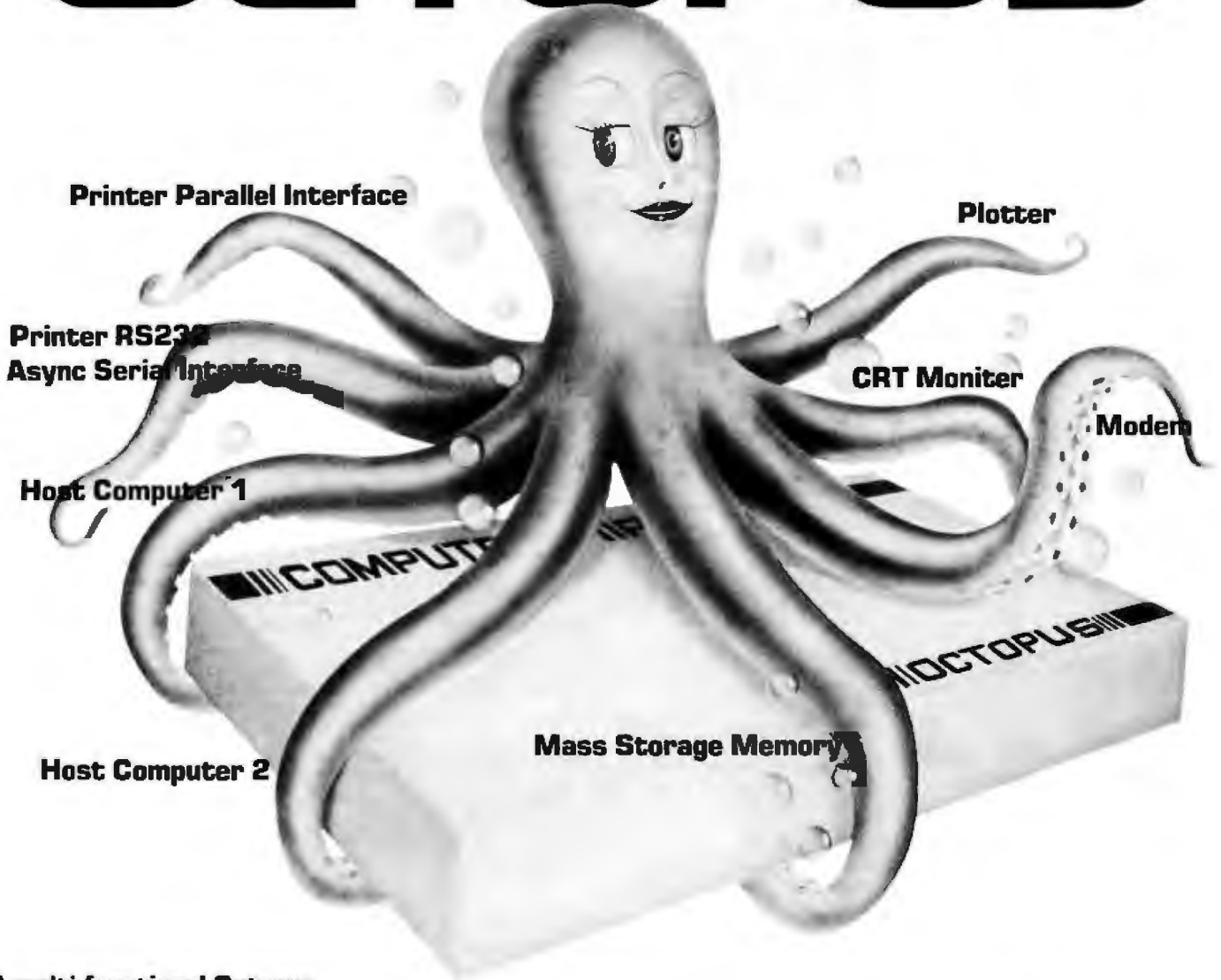
LOMAS DATA PRODUCTS, INC. □ 66 Hopkinton Road, Westboro, Mass. 01581 □ (617) 366-6434

Circle 265 on Inquiry card.





# OCTOPUS



## A multi-functional Octopus

It's a printer buffer, a printer spooler, frees computer time and enables copying capability.

## A data protocol translator:

parallel to parallel    parallel to serial  
serial to parallel    serial to serial

## A multitask data channel controller:

- enables host computer to communicate to multiple peripherals simultaneously.
- enables multiple computers to communicate with multiple peripherals simultaneously.
- compatible to most interface protocols.

**All in one for only \$197.50.**

## Standard product includes: Z80 CPU

One parallel input port (centronic printer and IBM PC compatible), one parallel output port (centronic printer and IBM PC compatible), two Serial RS232 Asynchronous ports, 8KB resident memory.

## Options include:

Up to 256KB upgradable memory  
Graphic enhancements.  
Modem with Auto Dial capability.  
Two additional parallel ports  
Two additional Serial RS232 Asynchronous ports.  
Customized software enhancements.

**computer peripherals**

1117 Venice Boulevard Los Angeles CA 90015 Call Collect (213) 298-1297 Telex: 194561 LSA



# computer mail order

computer mail order west

### PRINTERS SMITH CORONA

TP-1	\$569.00
Tractor Feed	\$129.00
Ultramic 1 Typewriter	\$429.00

### C.I.TOH (TSC)

Printer 551BP	\$389.00
Printer 551OS	\$379.00
Printer 1580P	\$699.00
Printer 1580S	\$749.00
Starwriter F10-40	\$1259.00
ProMaster F10-55	\$1649.00

### OKIDATA

82A	\$419.00
83A	\$459.00
M (Parallel)	\$1049.00
M (Serial)	\$1149.00
M2	\$599.00
87	\$899.00

### IOB

MoreProm	\$449.00
123 (Fully Configured)	\$1399.00
80 (Fully Configured)	\$1399.00

Call for other configurations

### STAR

Genstat 10	\$349.00
Genstat 15	\$489.00
Serial Board	\$75.00

### DAISYWRITER

9080 (Letter Quality)	\$999.00
Tractor Feed	\$109.00

### DIABLO

620	\$999.00
630	\$1749.00

### TeleVideo

#### TERMINALS

910	\$639.00
913C	\$689.00
930C	\$739.00
933C	\$719.00
950	\$939.00

#### COMPUTERS

800A	\$1259.00
805	\$2649.00
802H	\$4695.00
806-20	\$4949.00
810-00	\$8999.00
603	\$1949.00
1680G	\$3399.00
1603	CALL

### NEC

#### COMPUTERS

4000	CALL
8001A	\$719.00
8031	\$719.00
8012	\$549.00

#### PRINTERS

8023	\$459.00
7740/7720	\$3249.00
3510/3530	\$1549.00

#### MONITORS

JB-1200	\$119.00
JB-1201	\$149.00
JC-1212	\$299.00
JC-12-202	\$299.00
JC-1203	\$599.00

### EAGLE



Call on Eagle 8 Bit & 16 Bit Computers and Software

#### MODEMS HAYES

Smart	\$219.00
Smart II 1200 (1200 Baud)	\$249.00
Chromograph	\$199.00
Microcommod 100	\$309.00
Microcommod II	\$279.00
Microcommod II (with tone)	\$299.00

#### NOVATION

JL of	\$119.00
Car	\$144.00
Dat. or	\$159.00
103 Smart Car	\$189.00
Apple Car II	\$279.00
103/812 Smart Car	\$439.00
312 Apple Car II	\$609.00
Apple Car II 312 Upgrade	\$309.00

#### ANCHOR

Mark I (MS-232)	\$79.00
Mark II (Atari)	\$79.00
Mark III (TI-99)	\$109.00
Mark IV (C/IBM/PE.T)	\$125.00
Mark V (Xbox/Apple)	\$95.00
Mark VI (IBM-PC)	\$179.00
Mark VII (Home Answer Call)	\$119.00
TRS-80 Color Computers	\$99.00
9 Vult Power Supply	\$9.00
Mark VIII	CALL

#### MONITORS AMDEK

300G	\$159.00
300A	\$169.00
310G	\$179.00
310A	\$169.00
Color I	\$299.00
Color II	\$499.00
Color III A	\$799.00
Color III	\$649.00

#### BMC

12Au 13" Green	\$79.99
1001 12" Color (Mid. Res.)	\$349.00
9191U 12" Composite	\$329.00

#### TAXAN

RGB I (Hi-Res)	\$299.00
RGB II	\$499.00
12 N Green	\$119.00
12 A Amber	\$125.00

#### ZENITH

ZVM 121	\$99.00
ZT-1 Terminal	\$369.00

#### SHARP

12" Color TV	\$269.00
19" Color TV	\$339.00

#### U.S.I.

P 1, 9" Green	\$79.99
P 2, 13" Green	\$119.00
P 3, 12" Amber	\$159.00
P 4, 9" Amber	\$129.00
1608C 14" Color	\$599.00

### IBM

#### NEC 3850 PRINTER... \$1999

#### PERCOM/TANDOM DRIVES

5 1/4" 10MB Disk Drive	\$299.00
5 1/4" 20MB Disk Drive	\$299.00

#### AMDEK

318A Amber Monitor	\$149.00
318G Green Monitor	\$179.00
Amdek 13" Drive	\$679.00
XV Monitor	\$649.00
Color II	\$599.00

#### AST

Combo Card 64K	\$429.00
----------------	----------

#### GUSIE

PC Keyboard	\$219.00
-------------	----------

#### SOFTWARE

Micro Pro Word Star Mail Merge	\$349.00
11.5 EasyWriter II	\$249.00
11.5 EasyWriter	\$199.00
Proch Package (GL/AP/AR)	\$419.00

#### PROFESSIONAL SOFTWARE

IBM-PC Word Processing	\$319.00
------------------------	----------

#### CONTINENTAL SOFTWARE

1st Class Mail/Forms Letter	\$89.00
The Home Accountant Plus	\$189.00

#### SYNAPSE

File Manager	\$119.00
--------------	----------

#### IMMS

Printer Photo	\$239.00
---------------	----------

#### READY FORMS

1 1/2" Address Labels (Tractor Feed)	\$9.95
1 1/2" Report (Edge) (Tractor Feed)	\$24.95
8 1/2" Blank White Paper (vertical feed)	\$19.95
8 1/2" Blank Envelope (Tractor Feed)	\$14.95

### SANYO

MS 1000 Computer	\$1399.00
INCLUDES FREE SOFTWARE:	
MICROPRO-Wordstar, Calculator, Mail Merge & Report Star	
MS 140 Add on Drive	\$539.00
3500 Letter Quality Printer	\$699.00

### TIMEX SINCLAIR 1000

\$64.95

16K Memory Module	\$44.95
Vu-Calc	\$17.95
Check Book Manager	\$13.95
The Organizer	\$14.95
The Budgeter	\$13.95
Stock Option	\$14.95
Loan & Mortgage Analyzer	\$12.95
Minicost Printer	\$199.00

ORBYTE SOFTWARE	
Graphs	\$13.99
Money Budgeter	\$12.99
Money Inventory	\$12.99
Surveyor Fun	\$14.99
Algebra Mind	\$14.99
Sales	\$12.99
The Quiz	\$12.99
Words	\$12.99

### Commodore



CBM 64  
\$399

VIC 20  
\$139

1520 Color Printer/Printer	\$169.00
1525 80 Col Printer	\$329.00
1520 Diskette	\$69.00
1541 Single Disk Drive	\$329.00
1600 VIC Modem	\$95.00
1618 VIC Term 48	\$49.00
1650 AD/AA Modem	\$129.00
1701 16" Color Monitor	\$349.00
1311 Joystick (each)	\$6.99
1312 Paddles	\$11.99
1110 VIC HK	\$48.00
1111 VIC 16K	\$49.00
1011 NRS22 Interface	\$42.00
1311 Super Expander	\$33.00
1908 Super Alarm	\$23.00
1919 Radar Rat Race	\$23.00
1917 VooDoo Castle	\$29.00
1922 Cosmic Crunches	\$35.00
1923 Gurl	\$29.90
1928 Omega Race	\$30.00
110 VIC 20 Reference Guide	\$12.00
CBM 64 Reference Guide	\$18.00

#### EASY BUSINESS SERIES-64

Easy File	\$79.00
Easy Finance	\$39.00
Easy Mail	\$39.00
Easy Script	\$79.00
Word Machine/Name Machine	\$23.00

#### PROGRAMMER SERIES-64

Assembler	\$39.00
Logo	\$79.00
Pilot	\$79.00
Pat Emulator	\$25.00
Screen Editor	\$25.00
Video/Music Support	\$39.00

#### ART AND MUSIC SERIES-64

Music Machine	\$25.00
Music Computers	\$25.00
Meta Music I	\$79.00

#### COMMERCIAL DATA

Master Monitor/IB	\$23.00
Compdate/20	\$23.00
Fragepro/20	\$23.00
Fragepro/64	\$23.00

#### CREATIVE SOFTWARE

Auto Blitz	\$32.00
March Hide	\$12.00
Trashman	\$32.00
Home Finance	\$27.00
Home Inventory	\$13.00

#### UMI

Amok	\$39.00
Nature Run	\$40.00
Alban Blitz	\$30.00
Verum A	\$14.00
The Alien	\$34.00

### SHARP



PC-1600  
POCKET COMPUTER

\$169.

PC-1250... \$86.00	
CE150 Printer, Printer and Cass. Interface Unit	\$172.00
CE153 Cass Recorder	\$62.00
CE155 8K Ram Expans. Mod.	\$4.00
CE125 Printer/Micro Cass.	\$129.00

8039	\$1839.00
4032	\$729.00
8096 Upgrade Kit	\$269.00
9000	\$1649.00
2031	\$449.00
6040	\$949.00
8058	\$1279.00
8156	\$1639.00
9068 (5 Meg. HD)	\$1999.00
9006 (7.5 Meg. HD)	\$3199.00
4033	\$289.00
8023	\$359.00
6300	\$1499.00
Spell Master	\$99.00
2 Rom add. CP/MS & 44K	\$549.00
Siltron Office	749.00
Calc Result	\$189.00
The Manager	\$209.00
The Sub Ram	\$129.00
Janus	CALL
ADA 1600 CBM to Parallel Interf	\$89.00
ADA 1650 CBM to Serial Interf	\$99.00

#### PROFESSIONAL SOFTWARE

Power	\$79.00
Auto Proc	\$319.00
Word Pro 2 plus	\$199.00
Word Pro 3 plus	\$199.00
Word Pro 4 plus	\$299.00
Word Pro 5 plus	\$399.00
Administrators	\$379.00
Word Pro 64	\$79.95

#### CARDCO VIC 20 & CBM 64

Light Pro	\$32.00
Parallel Interface	\$39.00
Comat1 Printer Interface	\$64.00
3 Slot Expans Interface (20 only)	\$32.00
6 Slot Expans Interface (20 only)	\$79.00

#### RES

Phenax (ROM)	\$29.00
Protector (ROM)	\$32.00
Robot Panic (ROM)	\$29.00
Pirates (ROM)	\$29.00
RES Wreath (ROM)	\$29.00

Call on our  
Large Selection of  
VIC 20 and CBM 64  
Software, such as:  
**EPYX, Microscope  
and Kansas City  
Software.**

#### PANASONIC

JR2001 32K Pro Computer	\$269.00
MONITORS	
TR-120 12" Hi-Res Green	\$159.00
CT-160 16" Dual Mode Color	\$299.00
DT-D1000 10" RGB	\$349.00
DT-D1300 13" RGB/Composite	\$429.00

computer mail order west  
**800-648-3311**

IN NV. CALL (702)588-6654

DEPT. 501, P.O. BOX 6688, STATELINE, NV 89448 Circle 123 on Inquiry card.

INTERNATIONAL ORDERS: All shipments outside the Continental United States must be pre-paid by certified check only (include 3% (minimum \$3.00) shipping and handling)  
EDUCATIONAL DISCOUNTS: Additional discounts are available from both Computer Mail Order Inc. and its qualified educational institutions.  
APO & FPO: Add minimum \$5.00 shipping on all orders.

# computer mail order



Call on FRANKLIN Computers. Disk Drives, Software and Special System Offers!

**MICRO-BCI**  
DISK DRIVES FOR APPLE & FRANKLIN

A2	\$269.00
A70	\$349.00
A40	\$459.00
C3 Controller	\$79.00
C47 Controller	\$89.00

**RANA DISK DRIVES**  
for 1 plus Apple/Franklin CALL 080 (Atari) \$349.00

**SYBCOM**  
48K Color Computer APPLE COMPATIBLE \$629

**VIBICORP**  
for Apple, IBM & Franklin

Visuals	\$189.00
Visible	\$189.00
Vinput	\$159.00
Voutput	\$89.00
Vdisplay/Plot	\$229.00
Vdisplay/Plot	\$229.00
Vdisplay/Plot	\$189.00
Vdisplay/Plot	\$189.00
Vdisplay/Plot	\$179.00

**BRODERBOND**

Apple Panic	\$23.00
Apple's Magic	\$27.00
Star Blazer	\$25.00
Arcade Machine	\$34.00
Chopsticks	\$37.00
Serpentine	\$37.00

**INFOCOM**

Deadline (Apple, Atari, IBM)	\$35.00
Star Cross	\$29.00
Task L. II in III	\$29.00

**MPC**  
Bambak (128K Non-Video) \$649.00

**AXLON**  
Applet/Visible 128K Rom \$399.00  
Apple/Franklin Rom Disk \$999.00

**KRAFT**  
Apple Jaystack \$44.00

**CONTINENTAL**

Two Advantage (Apple/Atari)	\$45.00
Home Area (Apple/Atari)	\$59.00
Int Class Mail/Trans Letter (Apple)	\$79.00
The Book of Apple	\$14.95
The Book of Atari	\$14.95
The Book of Apple Graphics	\$14.95

## PERCOM

**DISKDRIVES FOR ATARI**

AT 88-51	\$399.00
AT 88-A1	\$299.00
AT 88-52	\$649.00
RFD 40-51	\$549.00
RFD 40-A1	\$349.00
RFD 40-52	\$689.00
RFD 44-51	\$679.00
RFD 44-52	\$999.00

**FLOPPY DISKS MAXELL**

MD 180s of 10	\$32.00
MD H (Box of 10)	\$44.00
FD 1 (8")	\$40.00
FD H (8")	\$50.00

**VERBATUM**

5 1/4" 5.5 DD	\$26.00
5 1/4" DS DD	\$36.00

**ELEPHANT**

5 1/4" 5.5 DD	\$19.99
5 1/4" 5.5 DS	\$24.99
5 1/4" DS DD	\$29.99

**HEAD**  
Disk Head Cleaner \$14.95

**SIRIUS**

Bondale (Apple)	\$28.00
Born Run (Apple)	\$24.00
Free Fall (Apple)	\$24.00
Terminator (Apple)	\$24.00
Snake Bye (Apple)	\$24.00
Few Fiddle (Atari)	\$21.00
Terminal (Atari)	\$21.00
Deadly Dash (VIC)	\$21.00

**INTERFACES & ACCESSORIES**

80 Col Apple Card	\$139.00
Apple Parallel Printer Interface	\$69.00
Atari 850 to Parallel Printer Cable	\$29.00
RN232-RS232 Cables	\$39.00
4 various Parallel-Parallel Cables	\$29.00
Call on IBM, Osborne, Datamaster, Acats I, Commodore, Apple and Franklin Interface Cards, Labels and accessories.	



**HEWLETT PACKARD**  
41CV \$209

**HP 75.....\$748.**

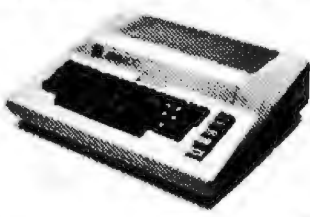
HP 41C (Free Memory Module)	\$169.00
HP 10C	\$59.00
HP 11C	\$72.00
HP 12C	\$99.00
HP 15C	\$99.00
HP 16C	\$89.00

**For HP 41C/41CV**

HPIL Module	\$99.00
HPIL Cassette w/ Printer	\$359.00
Card Reader	\$144.00
Extended Functions Module	\$64.00
Time Module	\$64.00
Mathematics Pac	\$26.50
Reel Estate Pac	\$40.00

## HOME COMPUTERS

**ATARI 800**  
48K  
**\$489**



**ATARI 800-16K ATARI 1200-64K**  
Call for price and availability on these two new Computers from Atari.

**810 Disk Drive** \$479.00  
**Instant Keyboard (for Atari) 400** \$99.00  
**1010 Program Recorder** \$14.00  
**1020 40 Col Printer/Plotter** \$249.00  
**1025 80 Col Printer** \$699.00  
**838 Acoustic Modem** \$154.00  
**850 Interface Module** \$169.00  
**CK40 Pr. Jaystack** \$16.00  
**CK618 Home Manager Kit** \$64.00  
**CK619 Bookkeeper Kit** \$193.00  
**CK682 Educator Kit** \$129.00  
**CK682 Programmer Kit** \$54.00  
**CK688 Communicator Kit** \$229.00  
**CK7101 Entertainment Kit** \$69.00  
**Invitation to Programming I** \$19.00  
**Invitation to Programming II** \$29.00  
**Invitation to Programming III** \$47.00  
**4002 Basic Language** \$47.00  
**6003 Assembler Editor** \$47.00  
**8121 Micro Assembler** \$69.00  
**8126 Micro Sub** \$69.00  
**405 Plot (Lab 1)** \$105.00  
**4018 Plot (Biomat)** \$72.00  
**8036 Atari Vision** \$79.00  
**804 Word Processor** \$119.00  
**5059 Wordstar** \$159.00

**ATARI**

Portman	\$33.00
Crusade	\$33.00
Defender	\$33.00
Galsiana	\$33.00
Master Command	\$33.00
Star Raiders	\$33.00
Casebook of Mars	\$33.00
Dig Dug	\$33.00
Danby King	\$41.00
E.T. Phone Home	\$39.00
Eastern Front (1941)	\$33.00
CHX	\$33.00
Nightman II	\$33.00
Star Trek	\$33.00
Systems	\$33.00
Donkey Kong	\$33.00
Computer Chess	\$33.00
Juggles House	\$33.00
My First Alphabet	\$29.00

**APX**

Trail Encounters	\$11.50
Family Budgets	\$11.50
Eastern Front	\$24.00
Family Cash	\$19.50
Jobber	\$13.50
Drawn Out	\$16.50
Letterlog	\$16.50
Moby Grail	\$24.00
Player Piano	\$16.50
HPIL Oregon	\$16.50
Numbers Blast	\$13.50
Freemaster	\$16.50
747 Land Simulator	\$16.50
Shampoo Pool	\$13.50

**ON-LINE**

Leadsheets	\$27.00
Subplan	\$27.00
Wizard and Princess	\$29.00
The Next Step	\$31.00
Windows Around	\$22.00
Monkstarfish	\$31.00
Logger	\$31.00
Crime Fix (MCM)	\$36.00
Some (M-LM) Products are also available for Apple and IBM. Call for information.	

**SYNAPSE**

File Manager 800 plus	\$69.00
Charbon (MCM)	\$34.00
Parole Passages (MCM)	\$34.00
Life Jump (MCM)	\$34.00
Slime (MCM)	\$34.00
Shamus (MCM)	\$34.00
Potterton (MCM)	\$34.00
Design Race (W/D)	\$24.00
Nashua K (D)	\$29.00
Shadow World (K/D)	\$29.00
Servius (L/M)	\$26.00
Droids (K/D)	\$26.00
Persepolis (L/D)	\$26.00
Pharaoh's Curse (L/D)	\$26.00
Fort Apocalypse (L/D)	\$26.00
Page A	\$19.00
Assembler	\$36.00
Disk Manager	\$24.00

**DATASOFT**

Parallel Lead Highway	\$25.00
Campus Climber	\$25.00
Tombler Bays	\$25.00
Shooting Stars	\$25.00
Chromo and Rollions	\$25.00
Leopold Messing	\$33.00
Graphic Generator	\$13.00
Micro Painter	\$25.00
Text Wizard	\$24.00
Spell Wizard	\$64.00
Barbap's Square	\$25.00
Sands of Egypt	\$25.00
Mean Streets	\$24.00
Funcom	\$24.00

**ALIEN**

Atari Video Box	\$119.00
Apple Video Box	\$149.00

**MEMORY**

Axlon 32K Ram	\$89.00
Axlon 64K Ram	\$129.00
Axlon 128K Ram	\$199.00
Inter 32K Board	\$74.00
Inter 64K Board	\$99.00
Inter 128K Board (1000 only)	\$149.00

**WICO**

Jaystack	\$24.95
Amigo Bird Ball	\$26.95
Apple Tractorball	\$59.00
Atari/VIC Tractorball	\$55.00
Apple Adapter	\$16.00

**ATARI 400**

16K.....	\$148
32K.....	\$274
48K.....	\$299
64K.....	\$359

**CBS**

Krazy School Bus	\$32.00
Krazy Restless	\$32.00
Krazy Antics	\$32.00
Krazy Patrol	\$32.00
Krazy School	\$5.99

**EPYK**

1 Inch 1/2 Inch & 1/4 Inch	\$24.00
1 Page of the Federal	\$24.00
1 Year of the	\$16.00
1 Year of the	\$16.00
1 Year of the	\$16.00
1 Year of the	\$16.00
1 Year of the	\$16.00
1 Year of the	\$16.00
1 Year of the	\$16.00
1 Year of the	\$16.00
1 Year of the	\$16.00

**SPINNAKER**

Amigo Tractorball	\$34.00
Amigo Tractorball	\$34.00
Amigo Tractorball	\$34.00
Amigo Tractorball	\$34.00
Amigo Tractorball	\$34.00
Amigo Tractorball	\$34.00
Amigo Tractorball	\$34.00
Amigo Tractorball	\$34.00
Amigo Tractorball	\$34.00
Amigo Tractorball	\$34.00

**ROKLAN**

Wizard of War (MCM)	\$24.00
Wizard of War (MCM)	\$24.00
Wizard of War (MCM)	\$24.00

**FIRST STAR**  
Atari 1 base \$25.00

**BIG B**  
Atari 400 \$33.00

**GAMESTAR**  
Base Druggs \$24.95  
Football \$24.95

**BUDGECO.**  
Narrow Navigator \$24.95

**L.J.K.**

Letter Perfect 68/80s of Ink	\$109.00
Letter Perfect 40's of Ink	\$179.00
Letter Perfect 80's of Ink	\$179.00
Letter Perfect 40/80's of Ink	\$79.00
Mail Merge	\$31.95
1 ALL FORM APPLE/1 J.K. PROGRAM TS	

**BITZ**  
80 Col Card for Atari 800 \$279.00

We also stock software by: Adventure International, Edware, Creative Software, Dorsett Educational, IDSI, Romox and Artworx. Call for details and prices.

# computer mail order east

## 800-233-8950

IN PA. CALL (717)327-9675  
DEPT 501, 477 E. Third St. Williamsport, PA 17701 Circle 123 on Inquiry card.

For each mail order on C.O.D. orders. Pre-paid orders receive free shipping within the UPS Continental United States Delivery Zone, with no waiting period for certified checks or money orders. Add 3% (minimum \$3.00) shipping and handling on all C.O.D. orders. Larger shipments may require additional charges. NY and PA residents add sales tax. All items subject to availability and price change. NOTE: We stock manufacturer's and third party software for most all computers on the market. Call today for our new catalog.

computer mail order east



# Solarsoft

## A Design Package for Solar Buildings

---

Winslow H. Fuller  
Equinox Inc.  
The Granite Block  
Peterborough, NH 03458

---

Designing efficient passive solar residences and small office buildings is a complicated process. Although the basic principles of passive solar design are simple, their successful execution requires a thorough understanding of their physics and practical application. The four programs in the Solarsoft package enable the experienced architect/engineer or owner/builder to fine-tune the design of any passive solar building. The following is a review of the four programs.

### Sunpas

Sunpas is an interactive program that can quickly estimate the auxiliary (or backup) heating requirement and solar contribution ("percent solar") of a passive solar building. The program uses monthly correlations developed at the Los Alamos Scientific Laboratory (LASL) in Albuquerque, New Mexico. This Solar Load Ratio method has become the standard estimation technique in the solar industry and is described in detail in the *Passive Solar Design Handbook*, vol. 2. (DOE/CS-0127/2), available from NTIS (National Technical Information Service), 5285 Port Royal Rd., Springfield, Virginia 22161.

The method uses the Solar Load Ratio (SLR) as the main parameter for estimating building performance. The SLR is the ratio of solar gains absorbed by a building in a given period of time (usually a month) to the heat lost during the same period. From this, the program cal-

culates the Solar Savings Fraction (SSF), which yields the auxiliary heating requirement. The SSF is the building's "solar savings" divided by its "net reference thermal load." For most buildings, the net reference thermal load is the load on an equivalent building without the passive system, and thus the SSF is in fact the percent that the solar system contributes toward the heating of the building.

Sunpas is menu driven. A setup menu specifies the required input data, including building heat loss, internal heat gains, shading, and location information.

The "climate responsive takeoff" menu asks the user to define each building surface as to type (solar or nonsolar), area (width and height), and overall u-factor (heat-loss coefficient). If a surface is solar, the user must specify its azimuth and tilt, solar absorption, night insulation R-value (resistance, or measurement of the tendency of a material to retard the flow of heat), two key fixed shading overhang parameters, and one of five user-defined monthly shading patterns.

The "ground responsive" heat-loss menu allows the designer to specify heat loss with reference to a constant temperature source such as the earth—a nice feature. Although the heat-loss value may not be entirely accurate, it gives a good approximation of basement heat loss when the ground temperature is accurately estimated.

The "infiltration and perimeter" menu asks only for the total building volume and the average air infiltration rate in air changes per hour (AC/hr). The AC/hr value is important because it is generally a large part of the total heat loss. Average uninsulated houses have values approaching 1.0 AC/hr, while superinsulated houses are near 0.2 AC/hr. If there is a slab instead of a basement or crawl space, the perimeter heat loss can be defined in this menu section by the length of the exposed perimeter and a single heat-loss coefficient.

---

### About the Author

Winslow H. Fuller is a licensed professional engineer and a principal in the architectural and engineering firm of Equinox Inc. in Peterborough, New Hampshire. He has analyzed hundreds of passive solar buildings for Equinox and for several state and national design competitions.

---

# COMPUTER & EQUIPMENT

DISCOUNT PRICES \* BUY DIRECT

It's simple. . . .

CALL & SAVE MONEY

**1-800-841-0860**  
CONVENIENT ORDER ENTRY

Since 1978

**MICRO MANAGEMENT SYSTEMS**

PARCEL DIVISION DEPT. NO. 1  
2803 THOMASVILLE RD. E.  
CAIRO, GA. 31728  
GA. INFO. 912-377-7120

GA. INFO **912-377-7120**



**commodore**

VIC 64 COMPUTER..... \$CALL  
VIC 20 COMPUTER..... \$CALL  
VIC 1541 DISK DRIVE..... \$CALL  
VIC 1530 DATASETTE..... \$CALL  
VIC 1525 PRINTER..... \$CALL

We carry many more products..... \$CALL

**Verbatim®**  
DATALIFE  
DISKETTES..... \$CALL

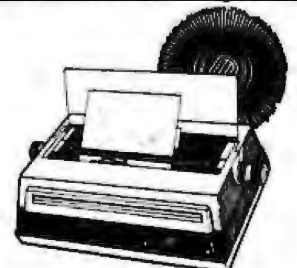
**TRS-80  
COMPUTERS**

MODEL 12..... \$CALL  
MODEL 16..... \$CALL  
MODEL III..... \$CALL  
COLOR COMPUTER..... \$CALL

We carry complete line of TRS-80 Computers.  
ALL TRS-80'S ARE PURE RADIO SHACK EQUIP.

**EPSON**  
PRINTERS

MX-80 PRINTER..... \$CALL  
FX-80 PRINTER..... \$CALL  
MX-100 PRINTER..... \$CALL



**SCM SMITH CORONA**

**OKIDATA**

PRINTERS

ML 80..... \$CALL      ML 92P..... \$CALL  
ML 82A..... \$CALL      ML 93P..... \$CALL  
ML 83A..... \$CALL      PM 2350... \$CALL  
ML 84P..... \$CALL      PM 2410... \$CALL

**TP-I DAISY WHEEL PRINTER**

- LOWCOST • 12 CPS
- Microprocessor Electronics
- 10 or 12 Pitch
- Simple, reliable mechanism

**\$CALL**

**Novation**

MODEMS..... \$CALL

**Panasonic.**  
COLOR MONITORS... \$CALL

**Hayes®**  
MODEMS.... \$CALL

**ATARI**  
ATARI 800 COMPUTER..... \$CALL  
ATARI 1200 COMPUTER..... \$CALL

**QUADRAM CORPORATION**

APPLE PARALLEL CARD/CABLE..... \$CALL  
IBM PC PARALLEL CARD/CABLE..... \$CALL  
MICROFAZER PRINTER BUFFERS..... \$CALL

**brother®**

DAISY WHEEL PRINTERS.... \$CALL



**FRANKLIN**  
COMPUTER CORPORATION

ACE 1000..... \$CALL  
ACE 1200..... \$CALL

**FREE UPON REQUEST**

- Complete Discount Price List
  - Copy of MFR Warranty
- Prices and products subject to change without notice.



## At a Glance

### Name

Sunpas, Sunop, Tswing, and Solgain

### Type

Monthly SLR correlation method and economic analysis of passive solar buildings

### Manufacturer

Solarsoft Inc.  
POB 124  
Snowmass, CO 81654  
(303) 927-4411

### Price

\$700 for all four programs together; \$395 for Sunpas and Sunop only; \$395 for Tswing and Solgain only

### Format

5 1/4-inch floppy disk

### Language

Applesoft BASIC

### Computer Needed

Apple II Plus with 48K bytes and two disk drives with an optional 80-column printer

### Documentation

160 pages, in 3-ring binder (includes 11 complete examples)

### Audience

Architect/engineers and owner/builders involved in design of passive solar buildings.

ting would yield an average of about 65°F. This value has a pronounced effect on the total heating load of a building and should therefore be selected with care.

Before running the analysis, the user must ensure that the disk contains monthly average climatic data for the building site. The data includes the latitude and altitude of the site, the monthly average ambient temperatures and daily swing (needed to calculate monthly average degree-days for any base temperature), and the average daily solar radiation. (This information is available for some 200 cities in the U.S. and Canada in the DOE handbook previously mentioned. The data disk of examples supplied with the software has approximately 15 cities on it.)

You run the program from the analysis set of menus. During the calculation phase, the program periodically delivers messages of its status so that the user is not left in the dark. The calculations usually take less than a minute, although the execution time may be longer if a large number of passive systems are present. The results can be printed directly and saved on disk as well.

The analysis menu lists three printing options for the computed results: the "complete print," which gives detailed information for each passive system specified; a "partial print," which repeats all important input data and all total building results (table 1); and "final results," which gives only the monthly SSF and auxiliary heating values.

I find that the "partial print" option is the best, because it repeats the input values and gives a nice breakdown of heat-loss sources and a summary of the monthly solar radiation absorbed. The final monthly results lists the net backup fuel requirement, the yearly total auxiliary use, and solar saving fraction. The complete printout gives the same information, but with the solar radiation data listed for each system.

A Sunpas graphics routine, available from the general graphics menu, produces a bar chart of the monthly auxiliary heating load, with the solar contribution highlighted. Title labeling requires user-supplied graphics text-editing software. Figure 1 shows what is possible.

### Sunop

Sunop accepts input from the Sunpas program and either calculates life-cycle costs of the passive solar system or determines the optimal mix of energy conservation and passive solar features for particular design and system cost regimes. Additionally, Sunop can graph a variety of parameters for presentation. Economic variables and analysis menus are used to set up and run the program.

The economic-variables menu allows the user to enter or edit default economic values, including financial period, down payment fraction, mortgage term, annual loan interest rate, discount rate, inflation rate, fuel inflation rate, taxes, maintenance and insurance costs, and fixed and variable system costs. The analysis follows the method found in the *Passive Solar Design Handbook* (see chapter H and appendix E of that publication for defini-

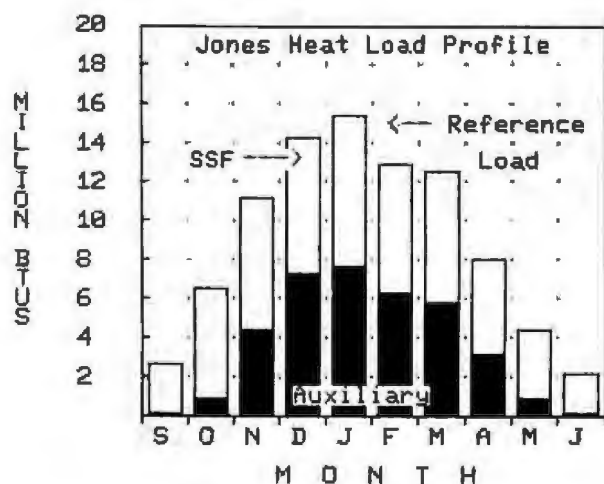


Figure 1: Sunpas can produce a bar chart of the monthly auxiliary heating load and solar saving fraction.

The "internal gains" menu allows the user to specify the average daily level of internal heat gains from people, lights, and appliances. These gains partially reduce the heating load. The menu also asks for the average thermostat setpoint. This is the setting, weighted hourly, of the thermostat. For instance, a 68°F day and 60°F night set-

# NEW! 3 $\frac{1}{4}$ " MICRO CP/M® SYSTEM

## \$1295



The **Micro-One** is a professional computer that takes advantage of the CP/M® 2.2 Operating System to give the user access to thousands of business programs. Its excellent hardware capabilities are matched only by its outstanding software package valued alone at more than \$1600.

All these features, coupled with its remarkable size of 2.75"x8"x12" and light weight of only 5 lbs., makes it an offer hard to beat.

### Micro-One Hardware Features

- 4MHZ Z80A® CPU
- 64K bytes RAM memory
- 500K bytes 3 $\frac{1}{4}$ " disk drive
- Two RS-232 serial ports
- Centronics parallel printer port
- Hard disk interface port

### Micro-One Software Features

- CP/M® 2.2 DOS
- Perfect Writer™ word processor program
- Perfect Speller™ spelling checker program
- Perfect Calc™ spread sheet program
- Perfect Filer™ information filing program

### Optional Features

- Additional disk drives
- 6MHZ Z80B® CPU operation
- Additional serial port
- Additional modem port
- Additional software
- CRT Terminal (available soon)
- Hard disk drive (available soon)

**EMS** Educational  
Microcomputer  
Systems

P.O. Box 16115 • Irvine, CA 92713 • (714) 553-0133

Circle 184 on Inquiry card.



## HEAT LOSS BREAKDOWN

### CLIMATE RESPONSIVE

HEAT LOSS (INCL. GLASS) = 712 BTU/HR-F  
 HEAT LOSS (NO GLASS) = 549 BTU/HR-F

SURFACE	BTU/HR-F	% WITH GLASS	% WITHOUT GLASS
S WALL	17.2	2.4	3.1
TROMBE WINDOW	57.6	8.1	0.0
WINDOW	134.4	18.9	0.0
WINDOW	56.0	7.9	0.0
W WALL	19.1	2.7	3.5
DOOR	2.9	0.4	0.5
E WALL	17.9	2.5	3.3
WINDOW	20.2	2.8	0.0
WINDOW	8.4	1.2	0.0
N WALL	21.3	3.0	3.9
DOOR	2.9	0.4	0.5
WINDOW	6.7	0.9	1.2
WINDOW	13.4	1.9	2.4
GABLES	17.6	2.5	3.2
S ROOF	54.7	7.7	10.0
N ROOF	86.0	12.1	15.7

Table 1: A typical partial print report from Sunpas.

### Net Present Value vs. the Area of Glazing

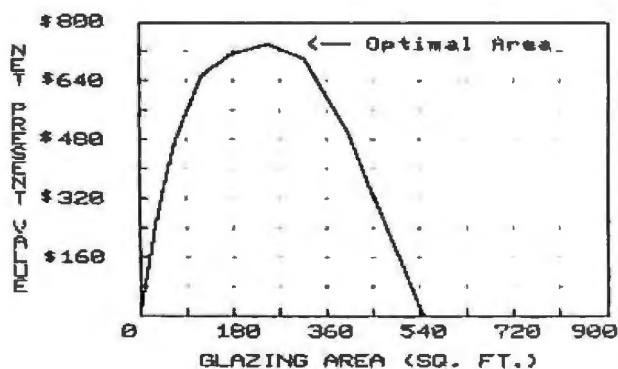


Figure 2: Graphic output of one of Sunop's life-cycle cost runs.

tion of terms and method of economic analysis). To perform the optimization routine, a builder's cost file must be created. In it, a user specifies different levels of insulation and their costs for each building component (wall, ceiling, etc.). From this information, Sunop can determine whether it is more cost-effective to add insulation or passive solar area.

Sunop will output results either in table or graph form. Figure 2 shows probably the most useful presentation for

life-cycle results. It is a plot of the *net present value* (discounted savings at current dollars) of a particular passive solar system versus the area of the passive system. For the building in this example, Sunop shows the optimal size of a passive solar system, given the economic assumptions in this program run. Another useful option is a printed table of annual cash flows for a particular system.

### Tswing

Tswing is a thermal network analysis program that calculates the temperature at different locations throughout a passive solar building on an hourly basis. These locations are known as *nodal points*. A heating and cooling thermostat can be associated with any node (a maximum of two). Engineers will recognize this technique of network or nodal analysis as a generalized method for solving transient heat flow problems by the *implicit finite difference technique*. (In fact, this program is general enough to solve many nonsolar heat transfer problems.)

A thermal network consists of a system of interconnected nodes (figure 3). The user must specify the capacitance (ability to store heat) of each node and the conductance (rate of heat transfer between nodes) of each interconnection. In addition, the user must define heat gains from external sources such as sunlight, lights, and appliances. Tswing is able to calculate the hourly temperatures of each node for up to 14 days and plot any node over a 24-hour period. Graphic overlays are also possible.

Tswing is an ideal program for fine-tuning the thermal storage mass in passive buildings. In particular, it allows the designer to check for living space overheating and potential freezing problems in unheated areas such as sunspaces.

### Tswing Submenus

Tswing contains five submenus that help the user to input data and run the program. From the main menu, the user can describe the building either node by node or zone by zone. Most novices choose the zone menu because it prompts the user for specific values and then automatically creates the matrix for the analysis. The experienced user usually selects the node-by-node menu because it is quicker. The user must define, in addition to building-related data, the weather data through the weather menu. Finally, the run menu is used to set up and perform the actual hour-by-hour analysis.

The zone menu is divided into three sections. The zone section prompts for such data as number of zones, floor area, thermal capacitance, exposed-wall area, volume, and heat-transfer coefficients. The mass section prompts for the number of nonwater thermal mass units and the number of their layers and amount of surface area, as well as the heat-transfer coefficient between them and the house air. The water section asks for the number of water mass units and their diameter and height, as well as various heat-transfer details.

The node menu requires that the user enter data via the submenus of capacitances, conductances, and constant

# The Rixon PC212A... The Perfect Modem For Your IBM® PC ...Only \$495

The Rixon® PC212A offers you the only 300/1200 BPS full duplex card modem with auto dial and auto answer that plugs directly into any of the IBM PC®\* card slots. Because the Rixon PC212A was designed specifically for the IBM PC, it is loaded with user benefits.

The PC212A eliminates the need for an asynchronous communications adapter card and external modem cable, this alone saves you approximately \$190. The PC212A provides an extra 25 pin EIA RS232 interface connector, a telephone jack for alternate voice operation, and a telephone line jack for connection to the dial network.

Without question, the PC212A is the most user friendly, most reliable, and best performing modem for your IBM PC. An internal microprocessor allows total control, operation, and optioning of the PC212A from the keyboard.

A user friendly HELP list of all interactive commands is stored in modem memory for instant screen display. Just a few of the internal features are auto/manual dialing from the keyboard, auto dial the next number if the first number is busy and instant redial once or until answered.

In the event of power disruption a battery back-up protects all memory in the PC212A. In addition, the PC212A is compatible with all of the communication programs written for the Hayes Smartmodem™\*\*such as

CROSSTALK.™† Also available for use with the PC212A is the Rixon PC COM I,™‡ a communications software program (Diskette) and instruction manual to enhance the capabilities of the PC212A and the IBM PC. PC COM I operates with or replaces the need for the IBM

Asynchronous Communications Support Program. The program is very user friendly and provides single key stroke control of auto log on to multiple database services (such as The Source<sup>SM&</sup>), as well as log to printer, log to file transfer and flow control (automatic inband or manual control). PC COM I is only \$59.00 if purchased at the same time as the PC212A. The PC212A comes with a 2 year warranty. For more information contact your nearest computer store or Rixon direct at 800-368-2773 and ask for Jon Wilson at Ext. 472.


## **RIXON** INC.

2120 Industrial Pky., Silver Spring, Md. 20904  
301-622-2121 TWX 710-825-0071 TLX 89-8347

## **The Rixon PC212A Card Modem**

**Another Modem Good Enough To Be Called RIXON**

Circle 395 on Inquiry card.

- 
- \* IBM is a registered trademark of the International Business Machine Corp.
  - \*\* Hayes Smartmodem is a product of the Hayes Stack™ series, a registered trademark of Hayes Microcomputer Products Inc.
  - † CROSSTALK is a trademark of Microstuf Inc.
  - ‡ PC COM I is a trademark of Rixon Inc.
  - § The Source is a servicemark of Source Telecomputing Corp.

RIXON INC. 1983 3043



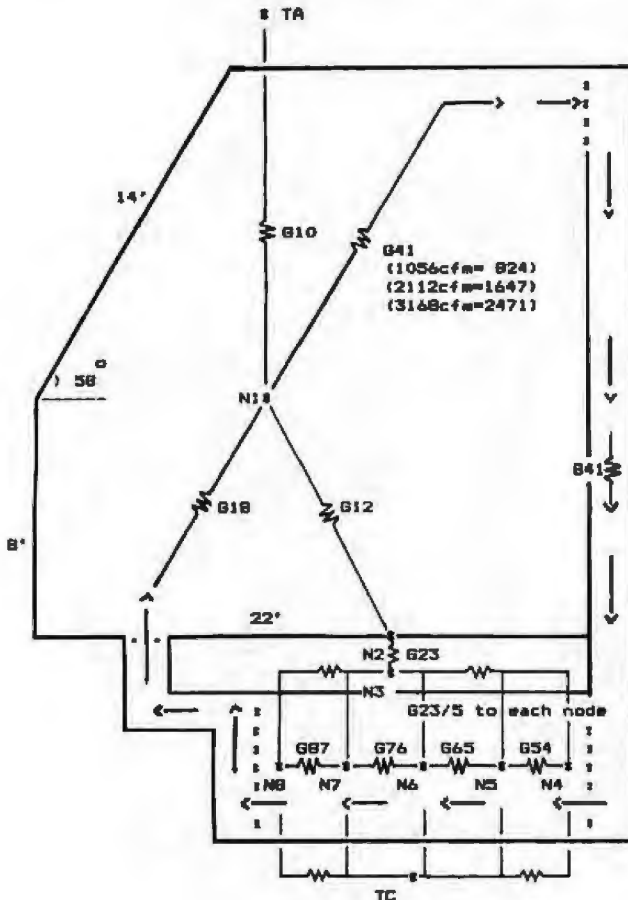


Figure 3: *Tswing* describes a building as a thermal network of heat conductances and capacitances.

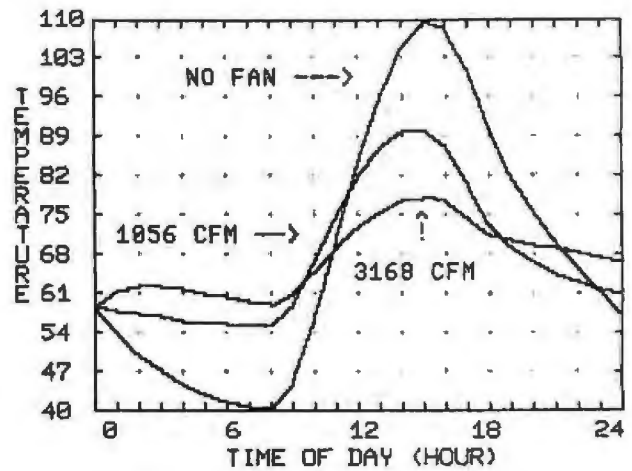


Figure 4: *Tswing* enables a user to test the effect of various parameters such as airflow rate on a solar design.

loss. Next, the user defines other important parameters that describe the operation of the building through the following submenus: movable night insulation, internal heat gains, thermostat setpoint, and solar distribution patterns.

A nice feature of *Tswing* is that as many as five different solar distribution patterns can be defined and then varied in the run sequences. Thus one pattern may consist of radiation for a south-facing window with an overhang, another for a south-facing window without an overhang, another for a 30-degree skylight, another for an east-facing window, etc.

The weather menu requires the user to define the ambient temperatures and solar radiation for as many as fourteen days. In the solar radiation section, the user is able to enter hourly radiation values from sunrise to sunset for each of five different surfaces. These surfaces

## a message to our subscribers

From time to time we make the *BYTE* subscriber list available to other companies who wish to send our subscribers material about their products. We take great care to screen these companies, choosing only those who are reputable, and whose products, services, or information we feel would be of interest to you. Direct mail is an efficient medium for presenting the latest personal computer goods and services to our subscribers.

Many *BYTE* subscribers appreciate this controlled use of our mailing list, and look forward to finding information of interest to them in the mail. Used are our subscribers' names and addresses only (no other information we may have is ever given).

While we believe the distribution of this information is of benefit to our subscribers, we firmly respect the wishes of any subscriber who does not want to receive such promotional literature. Should you wish to restrict the use of your name, simply send your request to the following address.

BYTE Publications Inc  
Attn: Circulation Department  
70 Main St  
Peterborough NH  
03458



# Micro The Computer Book Club®

"The ONLY Book Club for micro users"

Play games . . . develop new programming skills . . . organize your finances . . . earn extra income . . . even build your own microcomputer . . .

## HAVE IT ALL FOR ONLY \$2.95

### Select any 5 books, (values to \$103.75) for only \$2.95 when you join The Computer Book Club®!



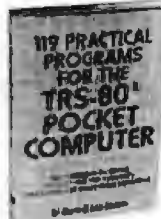
1281  
List \$17.95



1280  
List \$13.95



1455  
List \$15.95



1350  
List \$16.95



1338  
List \$14.95



1228  
List \$14.95



1407  
List \$17.95



1813  
List \$10.95



337  
List \$18.95



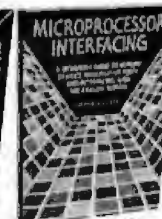
1496  
List \$17.95



1278  
List \$16.95



1108  
List \$14.95



1396  
List \$13.95



1330  
List \$16.95



1485  
List \$21.95



1288  
List \$16.95



1277  
List \$19.95



335  
List \$14.95



1369  
List \$21.95



1062  
List \$13.95



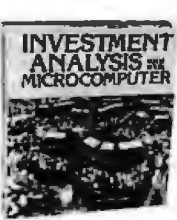
1163  
List \$14.95



1422  
List \$14.95



1521  
List \$17.95



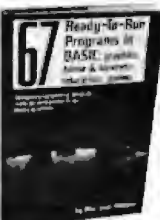
1479  
List \$19.95



1332  
List \$10.95



1406  
List \$17.95



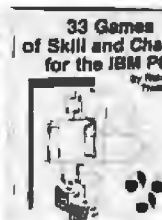
1195  
List \$13.95



1208  
List \$16.95



334  
List \$16.95



1526  
List \$18.95

## 7 very good reasons to try The Computer Book Club®

Blue Ridge Summit, PA 17214

- **Reduced Member Prices.** Save 20% to 75% on books sure to increase your computer know-how
- **Satisfaction Guaranteed.** All books returnable within 10 days without obligation
- **Club News Bulletins.** All about current selections—mains, alternates, extras—plus bonus offers. Comes 13 times a year with dozens of up-to-the-minute titles you can pick from
- **"Automatic Order."** Do nothing, and the Main selection will be shipped automatically! But . . . if you want an Alternate Selection—or no books at all—we'll follow the instructions you give on the reply form provided with every News Bulletin
- **Continuing Benefits.** Get a Dividend Certificate with every book purchased after fulfilling membership obligation, and qualify for discounts on many other volumes
- **Extra Bonuses.** Take advantage of added-value promotions, plus special discounts; on software, games, and more
- **Exceptional Quality.** All books are first-rate publisher's editions, filled with useful, up-to-the-minute information



## Micro The Computer Book Club®

Blue Ridge Summit, PA 17214

Please accept my membership in The Computer Book Club® and send the 5 volumes circled below, billing me \$2.95 plus shipping and handling charges. If not satisfied, I may return the books within ten days without obligation and have my membership cancelled. I agree to purchase 4 or more books at reduced Club prices (plus shipping/handling) during the next 12 months, and may resign any time thereafter.

334 335 337 338 1062 1108 1160 1183  
 1195 1205 1228 1278 1277 1295 1330  
 1332 1350 1369 1391 1396 1408 1407 1422  
 1455 1479 1485 1496 1513 1521 1526

Name \_\_\_\_\_ Phone \_\_\_\_\_

Address \_\_\_\_\_

City \_\_\_\_\_

State \_\_\_\_\_ Zip \_\_\_\_\_

Valid for new members only. (Orders outside U.S. or Canada must be prepaid in International Money Orders in U.S. dollars. Canada must remit in U.S. dollars.) This order subject to acceptance by The Computer Book Club® BY-583



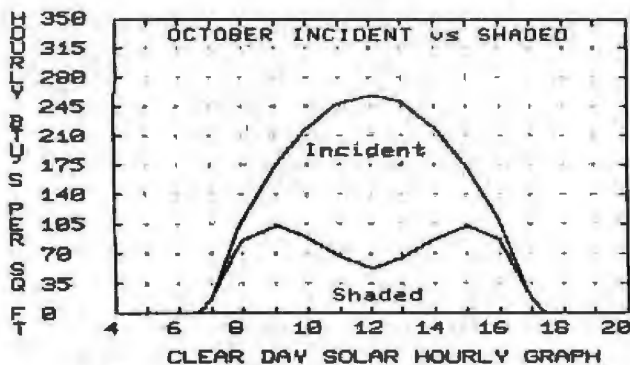


Figure 5: Solgain computes the heat gained by a building as a result of the sun's rays passing through its windows.

must correspond to the five different solar distribution patterns mentioned above. Actually, a user needs to enter only the total daily radiation and the number of sunlight hours. Tswing will compute the values automatically in a sine-wave pattern with the peak at noon. The hourly ambient temperatures are entered in a similar fashion. The same sine-wave auto-entry feature can be used here as well. The user needs to enter only the average temperature and the daily temperature swing.

Before the actual simulation can start, the user must first define the initial temperatures of each node (default values are 65°F), the number of days in the simulation, and the specific display format on either the screen or the printer. The selection of the number and type of days is very crucial. For instance, the user can define a clear, cold day and a cloudy, cold day, etc. Then by simply changing the order or number of days, the user can quickly "see" the building's performance in all possible weather scenarios.

At this point, the user is ready to begin the simulation. The best way to do this is to print the results first (selected nodal hourly temperatures and net backup heat-

ing and/or cooling load) and then rerun selected parts of the simulation for graphic presentation. An unfortunate limitation of the software is that only one day can be graphed. It is possible, however, to overlay different simulations (as in a parametric study) on one graph (figure 4). This is an excellent feature to have when you are presenting different options of a design to a client for review.

### Solgain

Solgain calculates the clear-day solar gains on the twenty-first of each month. It calculates, from the horizontal and overhang size, incident and transmitted radiation through single- or double-glazed windows, with varying shading coefficients, orientation, and tilt. Solgain menus prompt for some 16 input parameters. These include the window's latitude, angle from the horizontal, azimuth, shading coefficient, heat-transfer factor, dimensions, and fixed and adjustable overhang details and dimensions.

Solgain displays results either graphically or in table form. A nice feature is its ability to plot hourly solar gains (figure 5). The user has the choice of selecting any two of the following solar radiation components: incident, incident (shaded), transmitted, or transmitted (shaded).

### Conclusion

The Solarsoft package is a tour de force for quantifying passive solar building performance. The Sunpas, Sunop, Tswing, and Solgain programs are the state of the art in microcomputer estimation techniques. Our architectural and engineering firm regularly uses the Sunpas and Tswing programs to analyze and fine-tune the passive solar buildings we design and are consulted about. They are a quick and inexpensive alternative to mainframe simulation methods. ■

# WHY YOU SHOULD MAKE A CORPORATE CONTRIBUTION TO THE AD COUNCIL

The Advertising Council is the biggest advertiser in the world. Last year, with the cooperation of all media, the Council placed almost six hundred million dollars of public service advertising. Yet its total operating expense budget was only \$1,147,000 which makes its advertising programs one of America's greatest bargains... for every \$1 cash outlay the Council is generating over \$600 of advertising.

U.S. business and associated groups contributed the dollars the Ad Council needs to create and manage this remarkable program. Advertisers, advertising agencies, and the media contributed the space and time.

Your company can play a role. If you believe in supporting public service efforts to help meet the challenges which face our nation today, then your company can do as many hundreds of

others—large and small—have done. You can make a tax-deductible contribution to the Advertising Council.

At the very least you can, quite easily, find out more about how the Council works and what it does. Simply write to: Robert P. Keim, President, The Advertising Council, Inc., 825 Third Avenue, New York, New York 10022.



A Public Service of This Magazine & The Advertising Council.

The cost of preparation of this advertisement was paid for by the American Business Press, the association of specialized business publications. This space was donated by this magazine.

# TCS Heart of TEXAS COMPUTER SYSTEMS

**LEADER in MAIL ORDER DISCOUNTS!**  
**800 433-5184**  
 Texas 817/274-5625

## IBM Personal Computer

**INTERNAL DISKS FOR IBM**  
 Tandon Internal Disk-160K SCALL  
 Tandon Internal Disk-320K SCALL

**HARD DISKS FOR IBM**  
 Complete 5 Meg Systems from \$1550  
 Multi-computer Network Systems

**QUADBOARD FOR IBM**  
 Includes 64K to 256K additional memory  
 Serial & Parallel Port and Calendar Clock

**PRINTERS FOR IBM**  
 STAR and EPSON SCALL  
 NEC 3550 Spinwriter SCALL

**MONITORS**  
 Med Hi Res-Green Comrex \$89  
 High Res-Green BMC from \$89  
 High Res-Color PGS SCALL  
 Matches IBM PC  
 Low Res-Color-Taxon Vision 1 SCALL  
 High Res-Color-Taxon Vision 1 SCALL  
 High Res-Green-Taxon SCALL

## APPLE

First DISK DRIVE includes controller, DOS 3.3, cables and manual SCALL  
 Second DISK DRIVE with cable SCALL

APPLE to EPSON card and cable  
 APPLE TO GEMINI card and cable  
 Z 80 CARD SCALL  
 RAM CARD SCALL  
 Printer Interface Cards SCALL  
 Graphic Printer Interface Card SCALL  
 Graphic Spooler Interface Card available with 16K to 64K



FOR IBM, APPLE II AND APPLE III  
**SPECIFY INTERNAL/EXTERNAL**  
 5 megabyte hard drive SCALL  
 12 megabyte hard drive SCALL

## CORVUS

5 Megabyte Hard Drive SCALL  
 10 Megabyte Hard Drive SCALL  
 20 Megabyte Hard Drive SCALL

Add 5, 10 or 20 Megabytes of storage to your TRS-80 Model 1 Model II Model III  
 Model 12 IBM, Apple, Atari, Heath Zenith, Interlec, S100 Osborne, Eagle  
 Commodore 64 Xerox Superbrain Z89/90 DEC LSI-11 NEC PC-8001 and more

One or several computers can share A HARD DISK  
 Ask about OMNINET for your Apple or IBM PC.



Dedicated  
 To Being No. 1!

## FEATURES

- 100 CPS
- 9X9 Dot Matrix
- True Decenders
- Super Scripts-Subscript-Underlining
- Friction and Tractor
- Programable Line Spacing
- 99% Compatible with software written for No. 1 Printer
- High Res. Bit Image Block Graphics
- Backspacing-Doublstrike-And More
- 5, 6, 8 1/2, 10, 12 and 17 Pitch
- Free 23K Buffer

Extended Six (6) Month Factory Warranty—FREE

Gemin 10 (9 inch Carriage) Friction and Tractor SCALL  
 Gemin 15 (15 inch Carriage) Friction and Tractor SCALL  
 Serial Interface SCALL  
 Apple Card and Cable SCALL  
 Commodore Interface SCALL

Call and ask about the new High Speed Printers By Star Micronics

## COMMODORE 64

VIC 20--DISK DRIVES--MONITORS  
 DATASETTES--SOFTWARE  
 ACCESSORIES

Call For Current Pricing Information.

## PRINTERS

TCS has the LOWEST PRICES on IN-STOCK PRINTERS

### LETTER QUALITY PRINTERS

CITOH F-10 (40 CPS)  
 DAISY WHEEL II (RS)  
 NEC 3510-3550  
 NEC 7710 7730  
 BROTHER COMREX

**MATRIX PRINTERS**  
 EPSON-MX & FX MODELS  
 CITOH 8510, TEC/PNC

DMP 100  
 DMP 200  
 DMP 400  
 DMP 500  
 DMP 2100  
 ANADEX 9501-A  
 CENTRONICS 352/353  
 OKIDATA PRINTERS

PRINTER CABLES AND INTERFACES AVAILABLE.  
 CALL FOR CURRENT PRICING INFORMATION.

## TCS MODEL III 48K 2 DISK

Systems come with 180 day warranty.

**\$1444**

With standard 40 track  
 double density drives  
 Over 340,000 bytes  
 includes TDOS

**\$1644**

With 2 dual headed 40  
 track dbl density drives  
 Over 730,000 bytes  
 Includes DOSPLUS 3.4  
 (\$150 value)

Fully assembled and tested systems that are software compatible and functionally identical to Radio Shack units sold at computer stores for \$hundreds more

- CONTROLLER BOARDS are high quality double sided epoxy boards with gold plated contacts
- POWER SUPPLY is the finest switching type available.
- MOUNTING HARDWARE includes power and data cables.
- DISK DRIVES are Tandon, the same ones used by Radio Shack 40 track double density, with a 5 millisecond stepping rate

## TCS MODEL III DISK EXPANSION KITS

- 1 Controller, Power Supply, Mounting Hardware & Instruction \$279
- 2 Controller, Power Supply, Mounting Hardware & one 40 track Tandon Drive \$478
- 3 Controller, Power Supply, Mounting Hardware & two 40 track Tandon Drive \$677
- 3A Kit 3 but with two 80 track drives (dual 40's) \$879
- 3B Kit 3 but with two 160 track drives (dual 80's) \$1099

## TCS Model III and Color Computer

Ask about the Green or Amber CRT for your customized Model III

## TRS-80

## Model III and Color Computer

With Original 90 day Manufacturer's Limited Warranty  
 Call for current pricing information on the

## Model II...Model 16...Model 12...Model 4

All Radio Shack Equipment shipped from our store in  
 Brady, Texas.

## Tandon

TCS DRIVE CABINET is industrial grade heavy gauge metal, safety fused, and comes with gold plated external connector with extender cable

## 1 DRIVE in Cabinet

40 track single sided \$249  
 80 track (dual sided 40 track) \$329  
 160 track (dual sided 80 track) \$449

## 1 DRIVE/Double Cabinet

40 track single sided \$289  
 80 track (dual sided 40 track) \$389  
 160 track (dual sided 80 track) \$499

## 2 DRIVES/Double Cabinet

40 track single sided \$489  
 80 track (dual sided 40 track) \$639  
 160 track (dual sided 80 track) \$849

Drives in cabinets come assembled/tested with power supply Order cable separately

## BARE DRIVES ONLY

40 track single sided SCALL  
 80 track (dual sided 40 track) SCALL  
 160 track (dual sided 80 track) SCALL  
 8 inch Slimline sqi dbl sided SCALL  
 Winchester Hard Drives 5-30 Meg SCALL

## Smith-Corona® TP-1

Parallel/Serial . . . . . \$535

## TEXAS COMPUTER SYSTEMS

P.O. Box 1327 Arlington, Texas 76004-1327

TECHNICAL ASSISTANCE 817/274-9221

ORDER STATUS 817/277-1913

TELEX/TWX/Easylink ELN 62100790

★ **800 433-5184**

No tax out of state. Texans add 5%. Prices subject to change at any time.



# Some of our biggest ideas aren't very big.



Datamaster

## Small Systems from IBM.

In business, it's often the little things that count. And you can count on IBM for a lot of them.

That is, we make a wide range of low-cost, easy-to-use small computers to help businesses of all types and sizes solve big problems.

Like inventory control, for instance. IBM small systems can tell you what's what with your widgets: How many you have on hand. How many you need to fill existing orders. Where to ship and when.

If you want to improve customer

service, we're at your service.

With small systems that help your sales force match orders to inventory, figure a price and guarantee a delivery date. (All of which helps guarantee a sale.)

IBM small systems can help your marketing manager make price changes quickly. And your billing department improve cash flow by invoicing customers more efficiently.

When you write your customers, you can get letters and reports out faster.

But that's just the beginning. IBM has office



Personal Computer

administrative systems that take the work out of paperwork. As well as distributed systems that simplify and speed up the process of sending information back and forth between several locations.

The point is, whatever your problem—sales forecasting and analysis, billing, payroll, job estimating, order processing,



System/38

easy to learn and use. So you can put them to work quickly.

As your business grows, so can your IBM system with more storage capacity, work stations, printers and communication lines.



System/34

### IBM Small Systems come with a special feature. IBM.

IBM small systems come with a lot of excellent features. But the best feature of all is that they come from IBM. Which means you can get IBM education, service and support.

production control, and even energy management—it's no problem for IBM.

We have the right small system for the right job. And an IBM professional to recommend the one best for you.

What's more, our small systems are designed to be



Displaywriter

For further information on IBM small computers for your business, call your local representative or IBM's toll-free number below.

We'll show you that an idea doesn't have to be big to be great.



Call **IBM Direct** 1 800 631-5582 Ext. 104. In Hawaii/Alaska 1 800 526-2484 Ext. 104.

(Or write IBM 7AC/S22, Dept. NQ-104, 400 Parson's Pond Drive, Franklin Lakes, N.J. 07417.)



# The Ins and Outs of the TRS-80 Color Computer

*Find out how the Color Computer interfaces with the outside world.*

---

Colin J. Stearman  
143 Ash St.  
Hopkinton, MA 01748

---

My TRS-80 Color Computer was not home long before I was searching through back issues of *BYTE* to find out what was known about the internal workings of the unit. My interest aroused by a few excellent articles (see references 1 and 2), I was soon "peeking" and "poking" around inside my new purchase to find out more.

This article should further whet your appetite for exploration by giving you details on how the Color Computer interfaces with the outside world. I have also included some other tidbits of information to help you on your way to a better understanding of the internal workings.

## The Peripheral Interface Adapter

The MC6809E microprocessor interfaces with the outside world (and some other internal devices) through a PIA (peripheral interface adapter) integrated circuit (IC), numbered MC6821 by Motorola. The MC6821 pin configuration is shown in figure 1.

The purpose of the PIA is to enable the microprocessor to receive and transmit signals and interrupts from the outside world. Because these needs vary so much with each application, the MC6821 has been designed with maximum flexibility in mind. The IC contains two independent interface circuits, which are nearly identical in operation. Each circuit can receive or transmit as many as eight digital signals in any combination (three in, five out; one in, seven out; etc.). In addition, each has two

control lines, one dedicated to input and the other selectable as either input or output.

There are actually two PIAs in the Color Computer, one mainly for accepting keyboard entry (PIA1) and the other for external communication (PIA2). Each PIA is assigned four memory locations; PIA1 has hexadecimal addresses FF00 through FF03 and PIA2 has hexadecimal addresses at FF20 through FF23. In fact, only the least significant 2 bits of the address are used, along with the "chip-select" signal, making hexadecimal addresses FF04 and FF08 through FF1C for PIA1 equivalent to hexadecimal FF00. Also, only the least significant 2 bits are used with the other PIA1 and PIA2 addresses.

A block diagram of the input/output (I/O) components in the Color Computer is shown in figure 2. The PIAs receive and transmit signals to the digital-to-analog (D/A) converter, keyboard, joysticks, joystick fire buttons, cassette port, RS-232C port, video-display generator IC, analog comparator, audio-output selector, single-bit sound output (produces sound by switching one bit on and off rapidly), memory size jumpers, and interrupts used for timing purposes.

Figure 3 shows the allocation of the I/O and control lines of the two PIAs. The function of each of the identified lines is given in the following sections.

## The Cassette Interface

Both the incoming and outgoing audio signals are passed through signal-conditioning circuits. Data is recorded on tape by a frequency-shift-keying (FSK) technique. This circuit can be used for many purposes not related to cassette storage. The output of the D/A converter is connected to lines PA1 through PA7 of PIA1 via

---

### About the Author

Colin Stearman is a field engineering manager for Boston Digital Corporation.

---

# CRUNCH!

**The inventor of VisiCalc®, the world's leading software product, introduces TK!Solver™—the revolutionary way to crunch problems on a personal computer.**

With VisiCalc, Software Arts™ created an entirely new application for personal computers—the electronic spreadsheet.

Now Software Arts has developed TK!Solver, another entirely new and different application for personal computers—the problem solver. Business and financial problems. Scientific and engineering problems. Architectural and building design problems. Any kind of problem you can dream up, in any area.

What's so revolutionary about that? Simply this: the power of the TK!Solver program comes from the ease with which you can set up problems, vary assumptions, find solutions, and display results. All the facilities needed to solve the problems—simple or complex—are built-in, and need not be developed. Once you



have stated your problem, simply enter the known values, then solve the problem with a single keystroke.

For even easier problem solving use a TK!SolverPack™ in which models for solving common problems in such areas as finance, engineering and education have already been formulated by professionals in these fields.

There is no software product in existence that solves problems as quickly, flexibly, and easily as TK!Solver—The Problem Cruncher™. In fact, no other software product even works the way TK!Solver does. It

is a necessity for personal computer owners. See for yourself. Visit your nearest computer store for a demonstration and find out how much you can do with a personal computer when it thinks as flexibly as you do.

**Software Arts™**

27 Mica Lane, Wellesley, MA 02181

TK!Solver, TK!SolverPack and TK!Solver—The Problem Cruncher are trademarks of Software Arts, Inc. Software Arts is a trademark of Software Arts, Inc. and Software Arts Products Corp. VisiCalc is a trademark of VisiCorp. Copyright © 1983. Software Arts, Inc. All rights reserved.



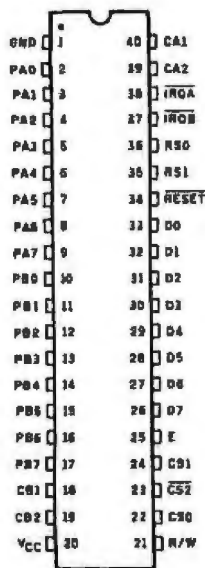


Figure 1: The peripheral interface adapter (MC6821) provides a flexible general-purpose interface between any of the 6800 series microprocessors and the outside world.

a scaling circuit. This results in an analog voltage at pin 5 of the cassette socket. This voltage varies from 55 millivolts (mV) to 1.126 volts (V) in 17-mV steps. Outputting numbers from 0 to 63 onto the upper 6 lines of PIA2 will set the voltage. To demonstrate this, connect a voltmeter or oscilloscope (set to direct-current coupling) to the cassette output, pin 5. Then enter and run this BASIC program:

```

10 FOR I=0 TO 63
20 POKE 65312,(PEEK(65312) AND 3) OR (I*4)
40 NEXT I
50 GOTO 10

```

Your meter or oscilloscope will show a slowly rising direct current (DC) voltage, which will suddenly fall to 0 and then start rising again. The result will be a positive-going sawtooth waveform. The slowness is due to the relative slowness of the BASIC interpreter. A machine-code routine would be much faster.

In line 20, multiplying I by 4 shifts the value of I to bits 2 through 7. Using the AND function with 3 and the current contents of the address returns the value of bits 0 and 1. Use the OR function with the result and the desired number, and put the final result back into the PIA. This is an important technique that you will see used elsewhere in this article. It allows modification of selected I/O lines without interfering with others.

Remember that this output is a voltage signal and that no power can be drawn from it. However, it can be interfaced with operational amplifiers and other analog devices to perform an unlimited number of control functions, enabling your Color Computer to control a variety of analog hardware with the right interface circuit. Possibilities include temperature control, model train

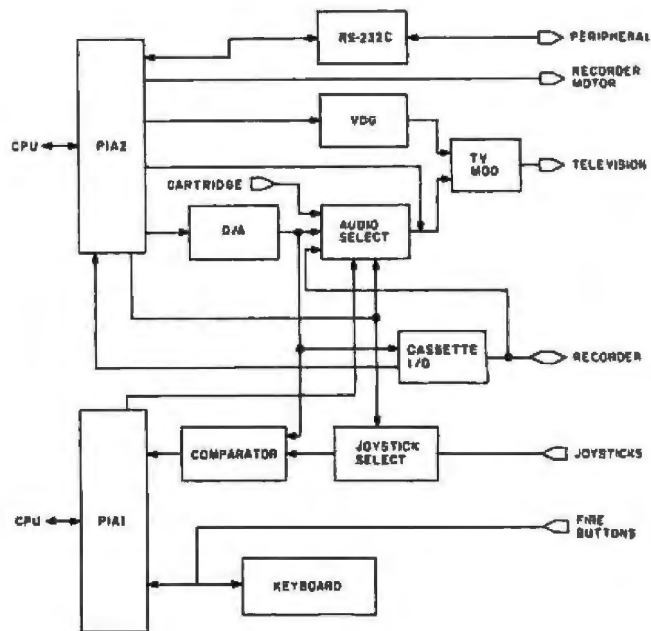
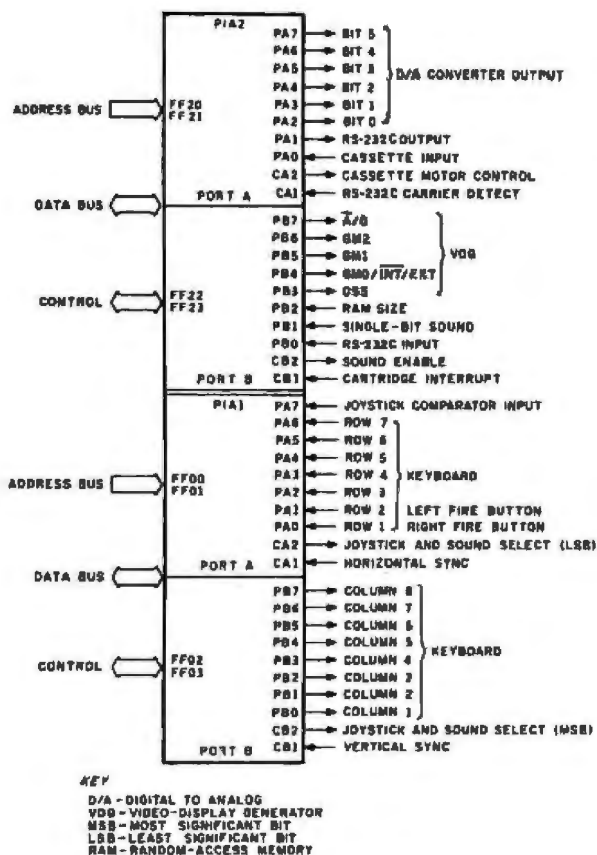


Figure 2: The TRS-80 Color Computer input/output system. The two PIAs are efficiently used to perform all of the I/O tasks needed by the Color Computer. The PIAs pass signals that are used for functions ranging from keyboard entry to cassette-recorder control to graphic-display control.



KEY  
D/A - DIGITAL TO ANALOG  
VDG - VIDEO-DISPLAY GENERATOR  
MSB - MOST SIGNIFICANT BIT  
LSB - LEAST SIGNIFICANT BIT  
RAM - RANDOM-ACCESS MEMORY

Figure 3: The PIA pin assignments. All available connections to the two PIAs are used, in some cases for more than one purpose. The great flexibility of the MC6821 makes this efficiency possible.

# THE PRICE SLASHER!

**FRANKLIN ACE1200 . . . . call**



**The Professional Personal Computer**



**FRANKLIN**  
COMPUTER CORPORATION

- TEXAS INSTRUMENTS . . . . CALL
- ALTOS . . . . . CALL
- ATARI . . . . . CALL
- COMMODORE . . . . . CALL

**DISK DRIVES**

- HARD DISKS AVAILABLE . . . . CALL**
- APPLE COMPATIBLE**
- Single w/Power Supp & Shugart Dr . . . . \$299.
- Double w/Power Supp & Shugart Dr . . . . 599.
- Controller card . . . . 85.
- MICRO SCI**
- A35 w/Controller . . . . 399.
- A40 w/Controller . . . . 466.
- A70 w/Controller . . . . 593.

**PRINTERS**

- OKIDATA**
- Microline 80A . . . . \$399.
- Microline 82A . . . . 459.
- Microline 83A . . . . 720.
- Microline 84(PAR) . . . . 1149.
- Microline 2410P . . . . 2599.
- Microline 92 . . . . 599.
- Microline 93 . . . . CALL
- BROTHER**
- HR-1 Daisy Wheel Parallel . . . . 889.
- HR-1 Daisy Wheel Serial . . . . 969.
- Forms Tractor . . . . 149.
- STAR MICRONICS**
- GEMINI 10 . . . . 399.
- GEMINI 15 . . . . 559.
- DIABLO**
- 630, RB-232, Daisy Wheel . . . . 1995.
- 630 API-Apple, IBM TRS 80 . . . . 1795.
- 620 . . . . 1324.
- MANNESMANN TALLY PRINTERS**
- MT 160 L . . . . 879

**MONITORS & TERMINALS**

- USI**
- 12" Hi Res Green . . . . \$149.
- 12" Amber . . . . 159.
- SANYO**
- 12" Black & White . . . . 123.
- 12" Green Screen . . . . 135.
- 13" Color . . . . 420.
- 13" Color Hi-Res . . . . 685.
- HAZELTINE**
- Espirit . . . . 585.
- Espirit II . . . . 649.
- AMOEK**
- 12" Green . . . . 169.
- 13" Color I . . . . 355.
- Color II Hi-Res . . . . 649.
- Color III RGB Color . . . . 475.
- TELEVIDEO**
- 910 . . . . 839.
- 912 . . . . 745.
- 925 . . . . 825.
- 950 . . . . 989.

- NEC**
- JB 1260 12" Econo Green Hi-Res . . . . 120.
- JB 1201 12" Green Screen Hi-Res w/Sound . . . . 169.
- JC 1201 12" Color . . . . 349.
- JC 1203 12" Hi-Res Color for IBM PC . . . . 799.
- Cable for IBM PC . . . . 19.

**ACCESSORIES**

- SORRENTO VALLEY ASSOCIATES**
- App-L-cache 256K Memory \$995.
- SSM**
- AS10 Apple Serial I/O Card . . . . 129.
- AP10 Apple Parallel I/O Card . . . . 75.
- AIO-II . . . . 164.
- TG PRODUCTS**
- Game Paddles . . . . 32.
- Joy Stick . . . . 44.
- ORANGE MICRO**
- GRAPPLER PLUS . . . . 139.
- KRAFT SYSTEMS**
- JOYSTICK . . . . 49.

**MPC PERIPHERALS**

- Bubble Memory . . . . NEW . . . . 579.
- 16K Memory Board for Apple II . . . . 82.
- 32K Memory Board for Apple II . . . . 139.
- Parallel Printer Card for Apple II . . . . 72.
- Upper and Lower Case ROM PROM-IT. Eprom for the Apple II . . . . 98.
- Serial Input/Output Card for Apple II . . . . 119.
- 16/32K Expansion Memory Board . . . . 125.

**M&R ENTERPRISES**

- SUP R TERMINAL 80 Column Video Board . . . . 269.
- PRACTICAL PERIPHERALS**
- Microbuffer II 16K for Apple II . . . . 239.
- Microbuffer II 32K for Apple II . . . . 279.
- 8K Serial Buffer for Epson Printer . . . . 129.
- 16K Parallel Interface for Epson Printer . . . . 129.
- MICROSOFT**
- 2-80 Softcard for Apple . . . . 249.
- MOUNTAIN COMPUTER**
- CPS Multifunction for Apple . . . . 185.
- The Clock for Apple . . . . 235.
- Romplus 16K for Apple . . . . 135.
- Romplus 32K for Apple . . . . 152.
- Music System for Apple . . . . 319.
- Rom Writer for Apple . . . . 139.
- SEATTLE COMPUTER**
- 64K RAM + for the IBM PC . . . . 385.
- 128K RAM + for the IBM PC . . . . 529.
- 256K RAM + for the IBM PC . . . . 789.
- CALIFORNIA COMPUTER SYSTEMS**
- Asynchronous Serial Interface . . . . 145.
- VIDEX, INC.**
- Videaerm . . . . 259.
- Softvideo Switch . . . . 29.
- Inverse Chip . . . . 24.
- Enhancer II . . . . 119.

**SOFTWARE FOR CP/M**

- Crosstalk . . . . MICROSTUF . \$162.
- Supercalc . . . . SORCIM . . . . 205.
- The Word Plus . . . . OASIS . . . . 119.
- Spellbinder . . . . LEXISOFT . . . . 279.
- T/Maker II . . . . LIFEBOAT . . . . 219.
- Supervyze . . . . EPIC SOFTWARE 115.
- Condor III . . . . CONDOR . . . . 799.
- ASHTON-TATE**
- dBase II . . . . 499.
- MICROPRO**
- Wordstar . . . . CALL
- Mailmerge . . . . CALL
- Calcstar . . . . CALL
- Dalastar . . . . CALL
- Supersort . . . . CALL
- Spellstar . . . . CALL
- Infostar . . . . CALL
- Reportstar . . . . CALL
- MICROSOFT**
- Fortran 80 . . . . 369.
- Macro 80 . . . . 189.
- Basic Compiler . . . . 319.
- mu/MATH/mu/SIMP 80 . . . . 219.
- Cobol 80 . . . . 595.
- Basic 80 . . . . 299.
- EdII 80 . . . . 96.
- mu/LISP/mu/STAR 80 . . . . 175.
- MultII Plan . . . . \*Also Available For Apple . . . . 205.
- SOFTWARE DIMENSIONS, INC.**
- Accounting Plus . . . . CALL

**SOFTWARE FOR IBM**

- Write On . . . . DATAMOST . . . . 599.
- Condor II . . . . CONDOR . . . . 449.
- Crosstalk . . . . MICROSTUF . . . . 165.
- MathMagic . . . . ISM . . . . 75.
- The Tax Manager . . . . MICROLAB . . . . 195.
- dBase II . . . . ASHTON-TATE 499.
- SORCIM**
- Supercalc . . . . 205.
- SuperWriter . . . . 295.
- Spellguard . . . . 229.
- SELECT INFORMATION SYSTEMS**
- Select Word Processor w/Superspell . . . . 389.
- VISICORP**
- Visicalc 256K Version . . . . 185.
- Visitrend/Visiplot . . . . 235.
- Visidex . . . . 185.
- VisiFile . . . . 235.
- Desktop Plan I . . . . 249.
- MICROPRO**
- Wordstar . . . . CALL
- Mailmerge . . . . CALL
- Spellstar . . . . CALL
- I.U.S.**
- Easyapper . . . . 139.
- Easyfiller . . . . 289.
- Easywriter II . . . . 269.
- SOFTWARE DIMENSIONS, INC.**
- Accounting Plus . . . . CALL
- CONTINENTAL SOFTWARE**
- The Home Accountant Plus . . . . 119.

**SOFTWARE FOR APPLE**

- BRODERBUND**
  - Serpentine . . . . \$29.
  - Chop/Iter . . . . 29.
  - MICROSOFT**
  - Typing Tutor II . . . . 18.
  - Adventure . . . . 26.
  - \*Fortran 80 . . . . 185.
  - A.L.D.S. . . . . 100.
  - \*Basic Compiler . . . . 315.
  - mu/MATH/mu/SIMP 80 . . . . 200.
  - Olympic Decathlon . . . . 26.
  - \*Cobol 80 . . . . 595.
  - M/Sort . . . . 156.
  - Softcard Premium System . . . . 599.
  - Time Manager . . . . 119.
  - VISICORP**
  - Viaicac . . . . 209.
  - Visiterm . . . . 89.
  - Visiplot . . . . 165.
  - Visidex . . . . 209.
  - Visitrend/Visiplot . . . . 249.
  - VisiFile . . . . 209.
  - Viaischedule . . . . 249.
  - Desktop Plan II . . . . 209.
  - MICROPRO**
  - \*Calcstar . . . . CALL
  - \*Dalastar . . . . CALL
  - \*Supersort . . . . CALL
  - \*Wordstar . . . . CALL
  - \*Mailmerge . . . . CALL
  - \*Spellstar . . . . CALL
  - Infostar . . . . CALL
  - Reportstar . . . . CALL
  - SORCIM**
  - Spellguard . . . . 229.
  - SOUTHEASTERN SOFTWARE**
  - Data Capture 4.0 . . . . 58.
  - EDU-WARE**
  - Step by Step. PROG DESIGN . . . . 59.
  - Datalax . . . . LINK SYSTEMS 148.
  - dBase I . . . . ASHTON-TATE 499.
- CALL FOR MORE APPLE SOFTWARE!!**
- Note: Apple is a registered trademark of Apple Computer, Inc. CP/M is a registered trademark of Digital Research
- MODEMS**
  - HAYES MICROCOMPUTER PRODUCTS**
  - Smartmodem . . . . \$229.
  - Smartmodem 1200 . . . . 599.
  - Micromodem II w/Term. Pgm . . . . 310.
  - Micromodem 100 . . . . 325.
  - Chronograph . . . . 199.
  - NOVATION**
  - Cat . . . . 169.
  - O-Cat . . . . 185.
  - Auto Cat . . . . 293.
  - Apple Cat II . . . . 309.
  - Apple Cat II - 212 . . . . CALL
  - J-Cat . . . . 135.
  - 103/212 Smart Cat . . . . 499.

WE ACCEPT • MONEY ORDER • O.O.D. • CASHIERS or CERTIFIED CHECK  
 • PERSONAL CHECK (allow 10 days to clear) • BANK WIRE TRANSFERS  
 • VISA MASTERCARD (add 2%)  
 Add 3% for shipping, handling & insurance (\$5 min.) Calif. residents add 6% tax. All equipment is new, comes with manufacturer's guarantee. PLUS we guarantee it for 30 days and pay shipping charges on any returns. All equipment subject to price change & availability without notice. Check quantity discounts.



9434 Chesapeake Drive • San Diego, CA 92123

**ORDERS ONLY: 800-752-1341**  
**CALIFORNIA ORDERS: 619-277-8002**  
**INFORMATION: 619-277-8006**



# BYTEK's SECOND GENERATION UNIVERSAL (E)PROM PROGRAMMER—SYSTEM 15

**Features:**

- Bipolar PROMS.
- Micras - (8748 & 8749)
- I/O - 6 baud rates, 13 formats including Intellec, Tetrax and Motorola.
- EPROMs, (2708 - 27128)
- Gang option - programs eight at once.
- Remote control option.

**\$645**  
**\$15-P**



**PROGRAMS**  
**OVER 250**  
**DEVICE TYPES**

**FUNCTIONS:**

- DISPLAY DEVICE DATA
- EDIT RAM DATA
- DEVICE PROGRAM
- TYPE SELECTION

- CRC-RAM
- LOAD DATA
- COMPARE FIELDS
- FILL MEMORY FIELD
- BLOCK MOVE
- DIAGNOSTICS
- and more.



**COMPUTER SYSTEMS CORP**

2283 S. Federal Hwy. Delray Beach, FL 33444 (305) 272-2052

## DECADES OF SERVICE

### Washington Computer Services

97 Spring St., New York, NY 10012 an affiliate of WASHINGTON ELECTRIC COMPANY since 1972

**TO ORDER:** Call our toll-free number: (800) 221-5416. In N.Y. State and for technical information: (212) 226-2121. Hours: 9 AM-5:30 PM (EST) Monday-Friday TELEX: 12-5606 CABLE: WASHCOMP NYK



The Professional's Workstation

## NEC APC

8086, 16 bit processor; Two 8" DSDD disk drives; 128K RAM (to 840K); green or RGB color screen.

- PERFECT FOR
- Word Processing
- CAD/CAM graphics (1024x1024 resolution)
- DataBase Management
- Accounting
- Chang Lab's Microplan
- IBM emulations
- CP/M-86, MSDOS, UCSD P.

**This new state-of-the-art workstation out-performs all others near its price range.**

PRICES START BELOW  
**\$3300.00**  
(One disk drive, green)

**NEC COMPUTERS AND MONITORS** On N.Y.S. Contract #P-07220

**PLEASE!** Do not confuse us with mail order dealers. We are a full service distributor serving the data processing & installation needs of business & industry from micros to mainframes. System houses, educational institutions & governmental agencies given special consideration. Leasing available. N.Y. State agencies, municipalities, and schools - call us for information on our O.G.S. term contracts on hardware & software.

Please call to make an appointment for demonstration of this extraordinary computer at our showroom. Prices subject to change without notice, call for latest prices. Prices include 3% cash discount. N.Y. residents add sales tax. CP/M® is a trademark of Digital Research. All sales subject to our standard sale conditions (available on request). Above prices do not include customization or installation.

speed regulation, and servomechanical-positioning systems. Applications are limited only by your imagination.

The cassette port also contains a relay contact for starting and stopping the recorder. The contact is rated at 0.5 amperes (A) at 6 V. It is completely isolated from all other computer circuits and can therefore perform any on/off function you wish, within the current and voltage limitations just noted. Figure 3 shows the PIA connection for this relay. To close the relay use:

POKE 65313,PEEK(65313) OR 8

And to open it use:

POKE 65313,PEEK(65313) AND 247

All kinds of possibilities should spring to mind for this simple digital output, including "reaction-timing" games and on/off control of lights, motors, and other electrical devices through interfacing relays.

### The RS-232C Interface

This port interfaces with the outside world in a serial fashion, as does the cassette port. However, the voltage levels are consistent with the EIA (Electronic Industries Association) Standard, which says that a 1 is any voltage from -3 to -25 V and a 0 is any voltage from +3 to +25 V. (However, RS-232C inputs to the Color Computer should not exceed plus or minus 12 V.) Figure 3 shows you where the RS-232C lines connect. Notice that Carrier Detect is on an interrupt line. The associated control register could be configured to enable this signal to cause an interrupt, if it were necessary for your program.

The Color Computer has a subset of the available signals in the RS-232C standard. They are Data Transmit, Data Receive, Carrier Detect, and Signal Ground. The Color Computer owner's manual will give you the pin locations. Transmitted signals from the Color Computer are at approximately plus or minus 10-V levels.

The functions of all signals, with the exception of Carrier Detect, are implied by their names. Carrier Detect is a signal sent to the Color Computer by the other device (modem, etc.) to say that the device is there and ready.

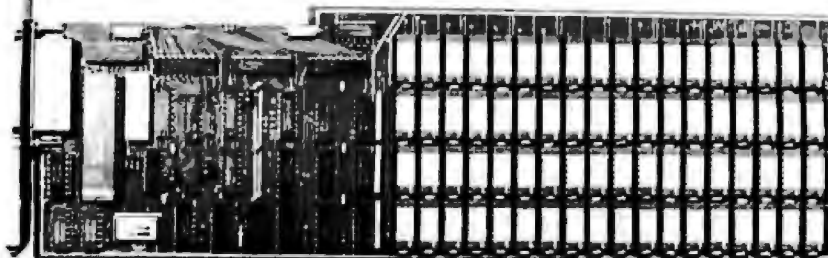
You can output data through the port by connecting a 9-V battery between Signal Ground and Data Receive. Put the negative side of the battery to Signal Ground. Then, type LLIST to output your program through the port output line (put your oscilloscope on the line if you have one), and the OK prompt will reappear. If the program is long, it might take a while because transmit speed is only 600 bps (bits per second, or about 60 characters per second) using LLIST.

RS-232C data is transmitted serially as one 0 start bit, seven data bits (least significant bits first), a 0 for bit 8, and two 1 stop bits. A total of 11 bits are sent for each character. The "at-rest" condition of the line is a 1.

On power up, the serial-transmission rate is set at 600

**NEW  
UP TO 2MB  
ON  
A SINGLE  
CARD!**

# STATE OF THE ART MEMORY SYSTEMS

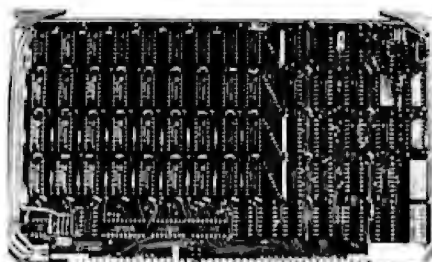


## 512KB SINGLE BOARD IBM MEMORY W/RS232-C PORT

- Addressable as a contiguous block in 64KB increments thru 1 megabyte.
- On board parity with interrupt on parity error.

**SINGLE QTY. PRICE: \$795.00**

**MEMDISK 1** Allows memory to emulate disks. Increases system performance!  
FREE with purchase of memory.

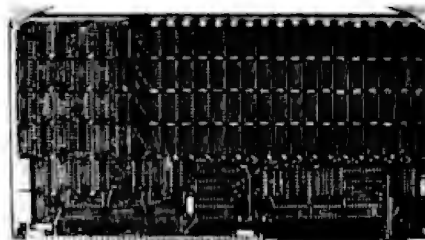


## 64KB SINGLE BOARD EXORCISER I, II, AND ROCKWELL SYSTEMS 65 MEMORY

- Parity checker on board.
- Addressable as a contiguous block in 4K increments with respect to VXA or VUA.
- Pin to Pin compatibility.

**SINGLE QTY. PRICE: \$250.00**

**NEW**

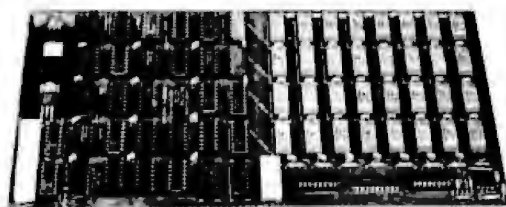


## 512MB TO 2MB SINGLE BOARD MULTIBUS MEMORY

- Pin to Pin MULTIBUS compatibility for both 8 bit and 16 bit systems.
- On board parity with selectable interrupt on parity ERROR.
- Addressable up to 16 megabytes.

**SINGLE QTY. PRICE:**

512KB	\$ 895.00
1MB	\$4495.00
2MB	\$8700.00

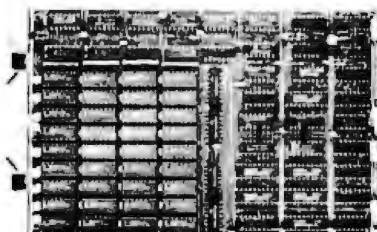


## 64KB SINGLE BOARD S100 MEMORY

- Addressable as a contiguous block in 4K word increments.
- Battery back-up capability.
- Functions with on-board refresh.

**SINGLE QTY. PRICE: \$250.00**

**NEW**



## 256KB TO 1 MB SINGLE BOARD LSI 11 MEMORY

- On board parity generator checker.
- Addressable as contiguous block in 256KB increments through 4 megabytes.
- Battery back-up mode.

**SINGLE QTY. PRICE:**

256KB	\$ 595.00
512KB	\$2650.00
1MB	\$3995.00

**DON'T ASK WHY WE CHARGE SO LITTLE, ASK WHY THEY CHARGE SO MUCH.**



# Chrislin Industries, Inc.

31352 Via Colinas • Westlake Village, CA 91362 • 213-991-2254  
TWX 910-494-1253 (CHRISLIN WKVG)



bps to be compatible with Radio Shack printers. You can change this rate by putting parameters into hexadecimal addresses 0095 and 0096. The first holds the most significant byte. Initially the value is 87 (0 in 0095, and 87 in 0096), generating 600 bps. Experiment with different numbers, and you'll find that the speed can be varied from 110 to at least 4800 bps. An 18 will give 2400 bps, and 180 results in 300 bps, for example.

Many RS-232C interfaces are commonly implemented using a universal asynchronous receiver/transmitter (UART) IC. This takes care of all timing and synchronizing. A UART has the capability of receiving and transmitting data simultaneously. But the Color Computer doesn't have a UART, so these functions must be performed by software, requiring some pretty fancy programming. However, I can demonstrate here that the Color Computer is capable of transmitting at various rates through the RS-232C port.

The program in listing 1 is in machine code and will continuously send a character you type, at the rate you

select. It uses a machine-code loading technique described in the Color Computer BASIC manual. No heed is paid to the Carrier Detect or Data Receive lines for this demonstration. Repeating the character triggers your oscilloscope, allowing you to study the waveform of the data. Remember, it transmits the character in ASCII (American National Standard Code for Information Interchange).

Study the flow diagram in figures 4a and b to see how the program works. Delays are developed using loops in machine code similar to FOR...NEXT in BASIC. Small delays can also be created using the NOP (no operation) machine-code instruction, which causes the microprocessor to do nothing for two machine cycles, or the BRN 00 (branch never) instruction, which uses up three machine cycles.

The Color Computer runs at 0.895 MHz, making each cycle last 1.117 microseconds ( $\mu$ s). The machine-code routine must delay the program for 93 machine-code cycles times the bps code, between outputs of each bit. A

**Listing 1: Variable-bps-rate RS-232C transmitter.** This demonstration program polls the keyboard for a depression and continually transmits the ASCII code for that character via the RS-232C port. An oscilloscope lets you study the resulting waveform.

```

5 CLEAR 25,3950
6 DIM RATE(7)
7 FOR I=1 TO 7: READ RATE(I): NEXT
8 DATA 64,32,16,8,4,2,1
9 A=3957
10 AA=A
11 DATA AD,9F,A0,00
12 DATA 27,0F
13 DATA 81,03
14 DATA 26,04
15 DATA 4F
16 DATA 7E,B4,F4
17 DATA A7,8C,6A
18 DATA A6,8C,67
19 DATA A7,8C,66
20 DATA 69,8C,63
21 DATA 4F
22 DATA A7,F1,20
23 DATA 26,00
24 DATA 26,00
25 DATA 26,00
26 DATA 26,00
27 DATA AD,8C,32
28 DATA 10,8E,00,0B
29 DATA A6,8C,4D
30 DATA 84,02
31 DATA B7,FE,20
32 DATA AD,8C,23
33 DATA 66,8C,42
34 DATA 31,A2
35 DATA 26,EF
36 DATA 26,00
37 DATA 12
38 DATA 86,02
39 DATA B7,FF,20
40 DATA 26,00
41 DATA 8F,00,04
42 DATA 26,00
43 DATA 30,82
44 DATA 26,FA
45 DATA AD,8C,06
46 DATA AD,8C,03
47 DATA 6E,8C,A5
48 DATA 8E,00,03,12,12,30,82
49 DATA 26,FA,E6,8C,15,C0,01
50 DATA 27,0E,2E,00,6E,00,06
51 DATA 12,12,30,82,26,FA,6E
52 DATA 8C,EE,39
53 DATA LAST
54 PRINT "LOADING MACHINE CODE...."
55 READ HEXS
56 IF HEXS="LAST" THEN GOTO 150
57 GOSUB 1000
58 PRINT "ADDRESS: ";A,"DATA: ";HEXS;" / ";BYTE
59 POKE A,BYTE
60 A=A+1
61 IF A>4095 THEN PRINT "OUT OF MEMORY":END
62 GOTO 100
63 B=INT(AA/256)
64 POKE 275,B
65 POKE 276,AA-B*256
66 PRINT "CODE ENTRY COMPLETE"
67 INPUT "<RETURN> TO CONTINUE";AS
68 CLS:PRINT "BAUD RATE SELECTION"
69 PRINT@36,"0 - STOP":PRINT@68,"1 - 150"
70 PRINT@100,"2 - 300"
71 PRINT@132,"3 - 600"
72 PRINT@164,"4 - 1200"
73 PRINT@196,"5 - 2400"
74 PRINT@228,"6 - 4800":PRINT@260,"7 - 9600"
75 PRINT@320,"SPEED";
76 INPUT BD
77 IF BD<0 OR BD>7 THEN 177
78 IF BD=0 THEN CLS:END
79 CLS
80 PRINT@230,"PRESS ANY KEY TC"
81 PRINT@262,"TRANSMIT ITS CODE"
82 PRINT@292,"<BREAK> TO SET SPEED"
83 POKE 4081,BATE(BD)
84 A=USR(0)
85 GOTO 170
86 IF LEN(HEXS)>2 THEN PRINT "DATA ERROR":END
87 UP=ASC(HEXS)
88 LO=ASC(RIGHTS(HEXS,1))
89 BYTE=0
90 IF UP>64 AND UP<71 THEN BYTE=(UP-55)*16:GOTO1050
91 IF UP>47 AND UP<58 THEN BYTE=(UP-48)*16:GOTO1050
92 PRINT "DATA ERROR: ";HEXS
93 END
94 IF LO>64 AND LO<71 THEN BYTE=BYTE+(LO-55):RETURN
95 IF LO>47 AND LO<58 THEN BYTE=BYTE+(LO-48):RETURN
96 GOTO 1030

```

Presenting the  
**ONE PRINTER**  
for letter-quality work, high-speed drafts, and graphics, too.



**P1350** Toshiba's unique 24-pin matrix printer works with most micros on the market to deliver capabilities you won't outgrow. At 100 CPS, it's twice as fast as a daisy wheel printer and turns out perfectly formed characters with

*The P1350 with Toshiba's quick, quiet, accurate sheet feeder.*



our fine 8-mil pins and overlapping dots. Draft quality output climbs to 192 CPS. And our all-purpose printer also creates high-resolution graphics that are dot-addressable at 180 x 180 per inch.

You get crisp originals and up to 4 copies on letter sheet paper or continuous forms from 5" to 15" wide. Of course, the P1350 with Qume Sprint 5 emulation has all the industry-standard features including multiple fonts, pitches and line spaces. And any feeding system, including our optional integrated sheet feeder.

See this high-performance, ultra-reliable, reasonably-priced printer in action at your Toshiba dealer. Or contact us for details.

1-800-648-5000  
Ask for Operator #198  
In Nevada, call  
1-702-329-9411

In Touch with Tomorrow

**TOSHIBA**



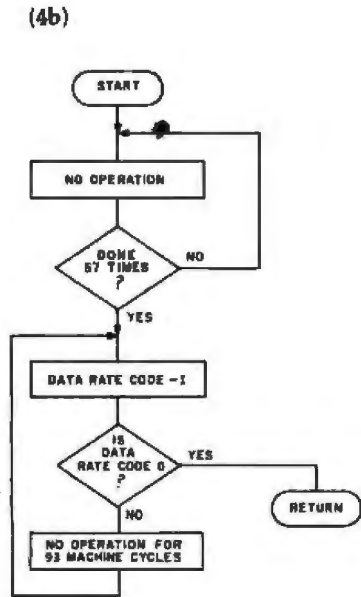
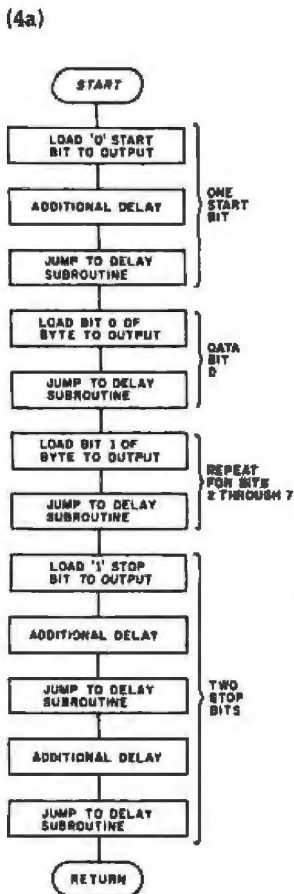


Figure 4a and b: Variable-bps-rate flow diagram showing a variable delay subroutine (4b) used to minimize storage space consumption. The main routine (4a) could be modified to transmit one stop bit if desired.

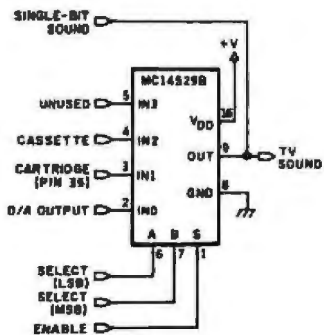


Figure 5: Audio-signal-select multiplexer. A solid-state analog switching IC is used to route audio signals from one of three sources to the television modulator. The second half of the IC is used for selection of the joystick signals.

subroutine is used to create this time delay, resulting in the equation:

$$\text{bps code} \times 93 \times 1.117 = \text{delay in microseconds}$$

The bps code for each desired rate is computed by:

$$\text{bps code} = \text{maximum bps/required bps}$$

In this program, the maximum bps is 9600. The variable bit rates and codes are shown in the following table. After each bit is loaded into the output port, this delay is called and the associated data-rate output results.

Data Rate	Bps Code	Required Delay	Actual Delay
150	64	6.67 ms	6.65 ms
300	32	3.33 ms	3.32 ms
600	16	1.67 ms	1.66 ms
1200	8	0.833 ms	0.831 ms
2400	4	0.417 ms	0.416 ms
4800	2	0.208 ms	0.208 ms
9600	1	0.104 ms	0.104 ms

### The Audio Interface

When you use Color BASIC's sound-producing instructions, audible signals are routed through the television modulator to your television speaker. Complex sounds generated by the game cartridges may also be directed to the speaker. The switching is performed by one half of a dual four-channel analog multiplexer (Motorola MC14529B). The other half is used for the joystick inputs described later. The MC14529B selects one of four analog sources to switch to the output, based upon a 2-bit binary code. The IC can also be totally disabled by making PIA2, line CB2, equal to 0. Figure 3 shows the PIA outputs that feed to this IC. Figure 5 shows the logic circuit that accomplishes this switching.

There are only three sources of audio signals (AUDIO ON, SOUND, and a game cartridge), so the fourth line is unused. To select the audio multiplexer, PIA2, line CB2, must be a 1, and the right code must be output from PIA1, lines CA2 and CB2. The following table shows the audio-selection-code combinations and their effects.

PIA2 CB2	PIA1 CA2	PIA1 CB2	Resulting Output To Television
1	0	0	D/A converter
1	0	1	cartridge
1	1	0	cassette
1	1	1	not used

To set and clear PIA2, line CB2, use:

POKE 65315,(PEEK(65315) OR 8)  
POKE 65315,(PEEK(65315) AND 247)

# DAWN OF A NEW GENERATION



## CMC 8/16 SuperSystem

- TurboDOS\*, CP/M\*\* and CP/M-86\*\* operating systems
- Floppy and hard disk drives
- SuperNet, local area networking, accommodates up to 16 users with 6 MB to 52 MB storage
- All stand-alone models utilize 750K to 19 MB storage and can be field-upgraded to SuperNet status

## RELIABLE EFFICIENT UPGRADABLE

- All 8-bit SuperSystems are easily upgraded to our new 8/16-bit system which features Intel's 80186 Processor and full CP/M-86 compatibility
- "Perfect Writer" word processing standard with all models.
- Generous dealer and OEM discounts
- 6 month warranty
- National on-site service in over 150 cities

**CMC INTERNATIONAL**

11058 Main Bellevue, WA 98004 (206) 453-9777 Telex: 152556 SEATAC

\*TurboDOS is a registered Trademark of Software 2000

\*\*CP/M is a registered Trademark of Digital Research, Inc

Circle 95 on Inquiry card.

BYTE May 1983 447



**Listing 2:** BASIC sound-generator program. The D/A converter may be used to produce audible sounds if you switch the digital number fed to it. This program demonstrates the technique.

```
10 POKE 65495,0
12 POKE 65315,PEEK(65315) OR 8
14 POKE 65281,PEEK(65281) AND 247
16 POKE 65283,PEEK(65283) AND 247
20 POKE 65312,0
30 POKE 65312,252
40 GOTO 20
```

To set and clear PIA1, line CA2, use:

```
POKE 65281,(PEEK(65281) OR 8)
POKE 65281,(PEEK(65281) AND 247)
```

To set and clear PIA1, line CB2, use:

```
POKE 65283,(PEEK(65283) OR 8)
POKE 65283,(PEEK(65283) AND 247)
```

Listing 2 shows a demonstration of the use of the D/A converter to generate a sound. This program switches the D/A converter lines from 0 to 255 and sends the resulting square wave to the television speaker. To increase the frequency of the sound (BASIC is rather slow), the microprocessor is run at the dual speed, as described in the articles in the references. (This technique may not work on your Color Computer and should never be used on disk-based systems.) Even so, the resulting sound is a low-frequency buzz and not the clean sound made by the machine-coded SOUND instruction.

Finally, it's worth mentioning the existence of a single-bit sound output. PIA2, line PB1, is normally configured as an input. However, it is connected to the same point as the audio multiplexer output, as shown in figure 5. Therefore it is possible to reconfigure the port to make PB1 an output and send bit-stream sound to the television. Imaginative programming in machine code should create some interesting sounds from this output. Care should be taken when using this feature to prevent conflicts between this output and the one from the multiplexer.

### The Joystick Interface

In the section on the cassette interface, I discussed how an analog signal can be obtained from the Color Computer under program control. It may have occurred to you that it would be nice to also have the unit read in an analog signal from outside. Not only can your Color Computer do this, but it can do it for four different analog signals! This is because the joysticks develop two analog signals each, depending upon the up-down, left-right position of the stick. But the range of the analog input signal is 0 to +5 V, so care should be taken not to exceed either of these limits.

If analog signals are to be read in by the Color Computer, they can be connected to the joystick pins and read by the JOYSTK instruction. Don't forget, though, that you must execute a JOYSTK(0) before reading any other joystick input (see the Color Computer BASIC manual).

The joystick selection is made by PIA1, lines CA2 and CB2, as shown in the following table of joystick input selection codes.

PIA2		Resulting Input From
CA2	CB2	
0	0	right joystick (side-to-side motion)
0	1	right joystick (up-and-down motion)
1	0	left joystick (side-to-side motion)
1	1	left joystick (up-and-down motion)

With the information in the preceding table, you should be able to write a BASIC routine to perform the successive-approximation A/D conversion and read the analog value at any one of the analog ports. The possibilities for this capability are endless. Some that quickly come to mind include using your Color Computer to monitor indoor/outdoor temperature, monitor and analyze weather variables, and digitize and display analog waveforms like an oscilloscope wave.

Just as the cassette output provided a digital output signal via the motor control relay, the two joystick inputs can be used to enter digital inputs to the Color Computer. The "fire" push buttons on each joystick change the contents of address FF00 from 255 (or 127) to 254 (or 126), as described in the Color BASIC manual. The alternates to each number are due to the comparator being input into PA7 (the most significant bit) of this address; this bit could be a 1 or a 0.

The push buttons ground the input lines when pressed and are therefore digital inputs. Any digital input that goes from short to open (such as a relay contact) can be connected to these inputs and read by a program in the same way as described for the push buttons. Because there are two inputs of this type, the Color Computer could be made to read any 2-bit digital input, thus giving you four possible combinations.

### Conclusion

From this article you should have some insight into how the Color Computer connects to the outside world. The microprocessor in the Color Computer is a powerful device, capable of performing many interesting and useful tasks. A better understanding of the I/O structure is essential if you want to take full advantage of these capabilities. ■

### References

1. Ahrens, Tim, Jack Browne, and Hunter Scales. "What's Inside Radio Shack's Color Computer?" March 1981 BYTE, page 90-130.
2. Baker, Woody. "A Closer Look at the TRS-80 Color Computer." October 1981 BYTE, page 334-340.

# Lycy Computer Marketing & Consultants

TO ORDER

CALL US

TOLL FREE 800-233-8760

In PA 1-717-398-4079

## FREE

DUST COVER  
with Purchase of

ATARI 800 48K .... \$489.00

ATARI 400 64K .... \$349.00

FREE CATALOG with over 60 manuf. for ATARI

ATARI 1200 64K RAM... \$CALL \$



A Warner Communications Company

### ATARI HARDWARE

810 DISK DRIVE ..... \$419.00  
410 RECORDER ..... \$75.00  
1010 RECORDER ..... \$75.00  
850 INTERFACE ..... \$164.00

#### PACKAGES

CX482 EDUCATOR ..... \$119.00  
CX 483 PROGRAMMER ..... \$54.00  
CX488 COMMUNICATOR ..... \$219.00  
CX419 BOOKEEPER ..... \$189.00  
KX7104 ENTERTAINER ..... \$69.00

#### NEW RELEASES

MINER 2049er ..... \$29.75  
ZAXXON ..... \$29.75  
CHOPLIFTER ROM... \$32.75  
CRISIS MOUNTAIN... \$25.95  
WARLOCKS REVENGE... \$25.95  
HOME ACCOUNTANT... \$59.75  
MONKEY WRENCH 2 ..... \$52.75

### MONITORS

NEC JB1260 ..... \$125.00  
NEC JB1201 ..... \$165.00  
NEC TC1201 ..... \$315.00  
AMDEK 30DG ..... \$159.00  
AMDEK COLOR I ..... \$329.00

### MODEMS

ANCHOR MARK I ..... \$79.00  
ANCHOR MARK II ..... \$79.00  
HAYES SMART ..... \$239.00  
HAYES MICRO II ..... \$309.00  
CAT ..... \$144.00  
J-CAT ..... \$CALL \$

## PERCOM DISK DRIVES

SINGLE DRIVE AT88 ..... \$359.00  
ADD ON ..... \$289.00  
SINGLE DRIVE 40S1 ..... \$479.00  
ADD ON ..... \$329.00  
DUAL DRIVE 40S2 ..... \$845.00  
DUAL HEAD SINGLE DRIVE 44S1 ... \$649.00  
DUAL HEAD DUAL DRIVE 44S2 ... \$989.00

## SAVE on these in-stock PRINTERS

PROWRITER ..... \$375.00  
NEC 8023A ..... \$439.00  
SMITH CORONA TP1 ... \$569.00

VIC 20 & VIC64 INTERFACING AVAILABLE

STARWRITER ..... \$1475.00  
PRINTMASTER ..... \$1675.00

OKIDATA B2A ..... \$419.00  
OKIDATA B3A ..... \$639.00  
OKIDATA B4 ..... \$1029.00  
OKIDATA TRACTOR ..... \$83.00

### PRINTER CABLES

for Atari

CITOH ..... \$35.00  
EPSON ..... \$35.00  
NEC ..... \$35.00  
OKIDATA ..... \$35.00  
SMITH CORONA ..... \$35.00

### DISKETTES : In Stock

ELEPHANT ..... \$19.25  
MAXELL MDI ..... \$32.75  
MAXELL MDII ..... \$44.00

### BUSINESS SOFTWARE

VISICALC ..... \$159.75  
LETTER PERFECT ..... \$115.75  
LETTER PERFECT ... ROM ... \$169.75  
DATA PERFECT ..... \$75.75  
TEXT WIZZARD ..... \$79.75  
SPELL WIZZARD ..... \$64.75  
FILE MANAGER 800 ..... \$89.75  
ATARI WORD PRO ..... \$109.75



POLICY  
DURING APRIL



In-Stock items shipped within 24 hours of order. Personal checks require four weeks clearance before shipping. No deposit for COD orders. PA residents add sales tax. All products subject to availability and price change. Advertised prices show 4% discount offered for cash. Add 4% for Mastercard and Visa.

TO ORDER  
CALL TOLL FREE  
**800-233-8760**  
In PA 1-717-398-4079  
or send order to  
Lycy Computer  
P.O. Box 5088  
Jersey Shore, PA 17740



In the beginning, there was the printer.

And right on its heels came the first printer breakdown.

Unfortunately, the first printer service call didn't happen nearly so quickly, thus creating downtime – a problem that still plagues users today.

What's the answer? Non-Stop-Printing from Trilog.

### **Two heads are better than one.**

Most dot-matrix line printers use only a single print head. That's fine – unless something goes wrong with the head. Then you're out of business until a service representative shows up.

On the other hand, the Trilog TIP-300 uses an exclusive two-headed system. Both 150 lpm print heads run simultaneously. Giving

you a total output of 300 lpm.

Should one print head temporarily fail, the user simply flips a switch and the remaining head continues printing at 150 lpm.

Now that's Non-Stop-Printing!

Dual heads offer another advantage, too. Instead of being pushed to capacity like most single heads, each Trilog head runs at a 50% duty cycle. This makes them much

# Non-Stop-Printing advance since the p



more reliable than conventional print heads.

**Advanced innovation isn't just in our heads.**

That's why we also gave Trilog printers dual tractors. They not only stabilize the paper and minimize friction, but allow the paper to move forward and backward. This gives you plotting capability and lets you generate forms. You can also print

bar codes. Plus business and engineering graphics.

**Five printers for the price of one.**

Besides graphics, the TIP-300 gives you four other types of printing: standard data processing characters. Letter quality characters that approach the sharpness of fully formed characters. And two versions of compressed characters for paper

savings and special formats.

For more information contact: Trilog, Inc., 17391 Murphy Ave., Irvine, CA 92714. Or call toll free in the continental U.S., except California: (800) 421-7164. In California call (714) 549-4079. TWX (910) 595-2798.

**Non-Stop-Printing starts with**

**TRILOG®**

# The single greatest printer was invented.



See us at NCC Booth A3109

For more information  
circle 462

For a sales contact circle 463



# A Conceptual Approach to Real-Time Programming

*You can use various real-time programming techniques to turn a lazy computer into a real worker*

---

Craig R. Wyss  
Department of Physiology, SJ-40  
University of Washington  
Seattle, WA 98195

---

If you have worked with a word processor or played a game of Asteroids, then you have used a real-time program. And if you have ever wanted to collect data in your home or laboratory or control something using a computer, then you've needed a real-time program.

Indeed, any situation in which events happening in the logical world of the computer must interact in a timely fashion with events happening in the outside world requires real-time programming. Furthermore, using efficient real-time programming techniques even when a particular job does not absolutely require them is always good practice. A program that spends equal time on computation and output can run almost twice as fast if it's based on a real-time approach. A well-crafted real-time program can be written in a high-level language, do its job, and still be loafing while a poorly designed assembly-language program doing the same job barely keeps up. Finally, skills developed in writing real-time applications

programs can be transferred directly to systems programming—all multi-user operating systems are real-time programs.

This article presents a conceptual approach for defining real-time problems and specific programming techniques for solving them. All real-time programming jobs involve three or more of the following subjob types:

- Data collection—This subjob class includes reading the keyboard, reading analog and digital inputs, etc. All real-time programs collect at least some data, and usually this task is their first priority.

- Data analysis—Analysis may be as simple as monitoring the input data for special values or as complex as performing Fourier transforms on blocks of data. As a general rule, the time required for data analysis depends on the input data: for example, in a word processor the time required to deal with an input character calling for a block move is much greater than the time necessary for data analysis on most characters.

- Data display—Display includes not only output to a video display or printer but also any outputs—digital

or analog—used to control events in the real world. Outputting results may be a high-priority job (if, for example, the computer is in a control loop) or a low-priority job (as in word processing, where keeping up with the keyboard is much more important than displaying characters).

- Data storage—Writing results to a mass-storage device is logically equivalent to displaying data, but it is practically different in that data typically has to be transferred in blocks. Thus, data storage is an ultra-high-priority task during the actual transfer but is at the bottom of the pecking order most of the time.

## Batch-Programming Approach

The normal or batch-programming approach to these four subjobs is to do them serially, i.e., wait for input, analyze it, and provide an output. The problem with this approach is twofold. First, peripherals are much slower than microprocessors so that a vast amount of time is wasted waiting for input or output devices to set their READY flags. Second, a batch program that may have plenty of time to analyze data, output results, and get back to the top of its loop when deal-

---

### About the Author

*Craig Wyss is a cardiovascular physiologist. He began writing real-time programs in 1969 using a Digital Equipment Corporation PDP-8.*

# How Can A Software Make Operating Your CP/M™ Micro Easier?

## Plug In MENU/POWER!®

CP/M is a fantastic operating system. Too bad it's so hard to use.

If you're like most new owners of CP/M-based computers, just learning how to use the fundamental commands is hard enough—let alone trying to get extra handholding and learning sessions from your busy dealer. That's frustrating!

Solution. Plug in a brand new, exciting software called MENU/POWER! It simplifies CP/M commands and utilities so much, even a first-time computer user won't be embarrassed to put his hands onto the keyboard.

## What MENU/POWER! Does.

It's an ingenious menu-driven utility package that demystifies CP/M, doing all the housekeeping for you.

No more PIP, STAT and other undecipherable commands to deal with.

No more typing errors with alphabet-soup file names again. MENU/POWER! numbers all the disk files. All the user has to do is pick the file number and CP/M is fed the file names.

And no more glitched disks, too.

## In Plain English!

From a screen menu of about 20 commands, you pick the number to COPY, ERASE, SPACE, TEST, RECOVER, RENAME, RUN, COMPARE, TYPE, SIZE, PROTECT, UNPROTECT, etc. Your computer feeds the file name automatically. No more typing errors. And you can even run programs from the numbered menu.

MENU/POWER! includes a special program that lets you lock sensitive files, so that only you can access them. Without the secret PASSWORD which you can create and change at will, no prying eyes will ever know your secret file even exists.

## Making Friends With Your Computer.

Let's face it. Whether you're a beginner or veteran computer-user, you bought your CP/M-based computer to make life and business easier for yourself.

What better reason for buying MENU/POWER! It makes friends with the CP/M operating system for you, controlling it to let you enjoy the ease of computer use every day of the year.

Just plug in the MENU/POWER! disk and it's ready to go. The menus are automatic, so there's no set up or installation needed.

## How To Get MENU/POWER! Fast.

You don't have to spend another day wrestling with CP/M.

**MENU/POWER! costs only \$149.** (In Calif. add 6½% sales tax). COD, VISA and MasterCard orders are welcome. Call our toll free number today. (MENU/POWER! is available for all CP/M-based computers and CP/M conversions, including IBM PC.)

COMPUTING! also offers a more powerful software package of over 50 utilities, called POWER!, which costs only \$169.

## Call Today!

**Toll Free: (800) 428-7825 Ext. 96H**

**In CA: (800) 428-7824 Ext. 96H**

**Dealers and Oem's: (415) 567-1634**

**Ext. H.**

**COMPUTING!**

2519 Greenwich,  
San Francisco, CA 94123



# Call For MENU/POWER!®



ing with most inputs can have real trouble when it encounters input data requiring more extensive analysis. The efforts of the real-time programmer are directed at figuring out how to do useful work when the typical batch program is inactive while waiting for peripherals or performing only simple data analysis.

The basic ingredients necessary for writing efficient real-time programs are two powerful programming tools: *buffering* and *coprocessing*. To il-

lustrate these techniques I will show how *any* real-time task could be accomplished efficiently in an ideal hardware environment. The secret of success is to allow each of the subjobs to execute independently, and the easiest way to do that is to assign one processor to each subjob, as indicated here:

- Processor #1 collects data as it becomes available from an input device and stores it in a first-in/first-out

(FIFO) buffer. A FIFO buffer can be thought of as a pipeline: one device puts data into one end of the pipe, while another takes data out of the other end.

- Processor #2 gets data, as the data is needed or as it becomes available, from the FIFO, which is fed by processor #1. Processor #2 then analyzes the data and passes results to FIFO buffers for display and storage.

- Processor #3 displays the data placed in its buffer by processor #2.

- Processor #4 transfers into a local buffer data from the buffer that is fed by processor #2. When its local buffer is full, processor #4 writes the buffer contents to the storage device and then returns to collect any data that processor #2 provided while processor #4 was busy. An alternate and more efficient approach involves having two or more local buffers for processor #4, which can tell processor #2 which buffer is available for receiving data.

This scheme is worth studying in some detail because it is more subtle than it appears. Note that everything works asynchronously. Processors are doing their job, waiting for a peripheral or waiting for data to appear in their input buffers. Processors may be temporarily ahead of or behind each other (as, for example, when processor #4 needs to write to the storage device or when processor #2 is performing an especially long analysis), but the FIFO buffers take up any slack. The only constraints are that the FIFO buffers must be big enough to absorb all the data generated by a source processor while the receiving processor is doing whatever jobs keep it from servicing its input buffer and that *on the average* each receiving processor must be fast enough to process its input data; time lost on long jobs must be made up later. Thus, if we all had multiprocessor computers, real-time problems could be solved simply by parceling out jobs and providing interprocessor-communication buffers. Unfortunately, most computer systems have only one processor; the rest of this article describes techniques for making one processor act like many.

**\* \* WE ARE BYTE MAGAZINE'S THIRD OLDEST ADVERTISER \* \***

**COMPLETE SYSTEMS FOR A WIDE RANGE OF APPLICATIONS, FOR VARIED LEVELS OF SOPHISTICATION. 8 & 16 BIT, S-100 AND NON S-100, SINGLE AND/OR MULTI USER, FLOPPY AND HARD DISK CAPABILITY, SOFTWARE, PERIPHERALS, SERVICE AND SUPPORT.**

**COMPUPRO/GODBOUT SPOKEN HERE:** We are proud of our recent designation as CompuPro Systems Center! We feature the high performance, versatile 8085/8088 dual processor 816 systems with unique version of MP/M that allows simultaneous use of both processors.



**NEC APC:** The best 8086 system on the market! Gives you more for your money! For under \$4,000: 8086 processor, two double sided, double density 8" drives, 128K RAM, elegant keyboard and monochrome display (color optional), MS DOS and/or CP/M 86.

**EPSON QX 10:** Truly user friendly. Our entire staff loves this system. You can draw pie charts and bar graphs in two minutes with no prior computer experience! Incredibly easy and satisfying to work with. For under \$3,000: 256K RAM, complete VALDOCS software, HASCII keyboard. We also stock HX20, new FX80 printer.

**MASTER MAX:** Z80, S-100 with dual 8" drives (Winchester option). Uses Intercontinental Micro CPZ48000 single card computer. 4 DMA channels & universal interrupt controller give great versatility and speed. \$2740 includes CP/M. OPTIONS: double sided drives, TURBODOS, ICMS slave cards, 220v/50HZ operation.

**IMS MULTI USER SYSTEMS WITH TURBODOS:** Z80, S-100 CP/M compatible. Slave cards give each user Z80 CPU, 64K RAM, 2 I/O. No speed degradation as users are added! Nationwide service depots.

**GRAPHICS: MICROANGELO (S-100) OR MIRAGE (RS232).** Monochrome or color. AUTOCAD: Interactive graphics software for architects, engineers, others. HOUSTON INSTRUMENTS digitizer and plotters.

**ESQ 1:** Legal time and billing software implemented on our MASTERMAX, IMS or GODBOUT. On site training and complete software for NY quad state area.

**PERIPHERALS:** CRTS (Televideo, WYSE, Hazeltine); dot matrix and letter quality printers, S-100 boards & mainframes, floppy disk subsystems (Shugart, Qume, Tandon, Per Sci). Full line of RAM and accessories for IBM PC.

**SINGLE OR DUAL WINCHESTER SUBSYSTEMS:** Dual version solves back up problems! Implemented for CP/M, Turbodos, TRS 80, IBM PC, Osborne, Apple, many others. Very low prices.

**CROMEMCO DUAL PROCESSOR:** Z80/68000. Also Z80 C10 p.c.

**MODEMS:** US ROBOTICS DC Hayes compatible modems at lower prices.

**HAZELTINE ESPRIT III:** \$795. Televideo 950 emulator, comparable performance for \$200 less! Quantity, OEM and dealer discounts.

**3270 NETWORK:** Teletype controllers, printers and terminals. Cost effective.

CALL OR WRITE FOR FREE PRODUCT SPECS ON ANY ITEM WE CARRY

**WE EXPORT**

Overseas Callers: Phone (212) 448-6298  
TWX 710 588 2844 or Cable: OWENASSOC

**JOHN D. OWENS Associates, Inc.**

12 Schubert Street, Staten Island, New York 10305

(212) 448-6283 (212) 448-2913 (212) 448-6298

**We speak  
your language  
and translate  
your software needs  
into efficient and  
Quality Services...**

DMA products operate  
on the full range of 8080-8088  
processors, including the IBM-PC

Here's what you can do!

**Data Base Management  
The FORMULA.**

**The Application Generator™**

This unique software package lets you create sophisticated business application software without programming. The FORMULA builds files, reports, updates, sorts, and menus and links them all according to the user's specifications. It incorporates features of a data base manager, a word processor, and a compiler into the first "system language" for microcomputers.

**Communications**

**ASCOM™**

ASCOM™ is the most versatile asynchronous communication package for microcomputers on the market. It features interactive, menu-driven, and batch operations; supports auto-answer and auto-dial modems; includes most popular protocols; provides network simulation; and many other options. Xerox Corporation, NCR, Monroe Systems for Business, and the big 8 accounting firms use ASCOM.

**Utilities**

**EM80/86™**

This software emulator lets you use eight bit software on sixteen bit microcomputers without hardware modifications.

**UT-86™**

This package of user-friendly utilities for the IBM Personal Computer and similar systems includes copying, directory sorting, patching, and a general purpose file print utility.

**Coming Soon**

**DMA. "C"™** — A "C" language compiler which will generate either Z80 or 8086 assembly language code. Due to a unique optimization routine which is based upon a functional "P-code" model, the efficiency of DMA. "C" will far exceed that of existing compilers.

**SYNC/COM™** — A bisynchronous communication package that will be configurable for a variety of systems and include a flexible interface to the operating system.

**The 8086 O. S. Converter™** — A program which will permit programs written for Digital Research's CP/M-86™ to execute under IBM's PC DOS.

**DMA DMA DMA**

**WE SPEAK YOUR LANGUAGE WE SPEAK YOUR LANGUAGE WE SPEAK YOUR LANGUAGE**

DYNAMIC MICROPROCESSOR ASSOCIATES, INC.

545 FIFTH AVENUE, NY, NY 10017

Dealer Inquiries only • (212) 687-7115

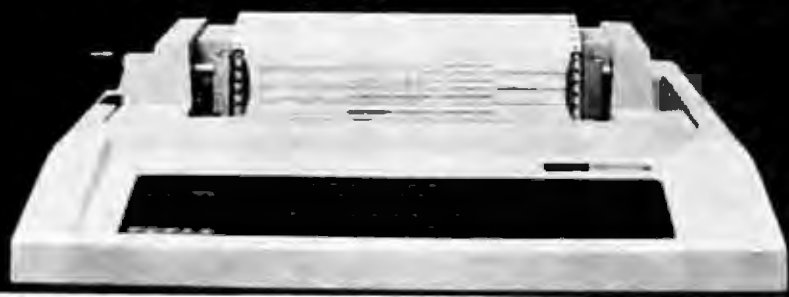


To map the general real-time algorithm onto only one processor, you can set up a number of logically independent subprograms that pass control of the processor back and forth under either software or hardware control. These subprograms may be either subroutines or coroutines in actual structure, but it is best to think of them as coroutines in order to keep close to the multiprocessor model. Many programmers are unfamiliar with the concept of a co-

routine, but it is basically simple. Coroutines differ from subroutines both conceptually and structurally: Conceptually, coroutines can be thought of as equal partners in performing a job rather than as master and slave. Structurally, coroutines differ from subroutines in that control of the microprocessor may be relinquished at any point in the coroutine and then resumed at that point when other coroutines return control; in contrast, subroutines are initiated at their be-

ginning every time they are called. To logically model multiple processors, you set up multiple coroutines that relinquish control of the microprocessor when they are waiting for a peripheral, waiting for data to appear in their input buffer, or performing a low-priority task. The exact programming techniques to use depend on whether input/output (I/O) is programmed, interrupt driven, or under direct-memory-access (DMA) control.

## Tune up your LA36

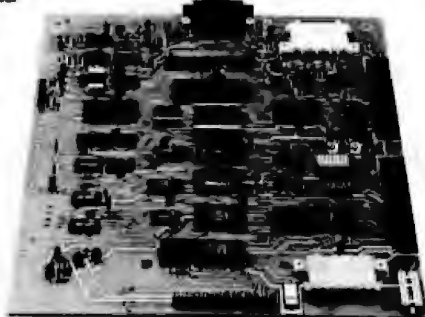


### The DS120 Terminal Controller makes your LA36 perform like a DECwriter® III.

The Datasouth DS120 gives your DECwriter® II the high speed printing and versatile performance features of the DECwriter® III at only a fraction of the cost. The DS120 is a plug compatible replacement for your LA36 logic board which can be installed in minutes. Standard features include:

- 165 cps bidirectional printing
- Horizontal & Vertical Tabs
- Page Length Selection
- 110-4800 baud operation
- 1000 character print buffer
- X-on, X-off protocol
- Self Test
- RS232 interface
- 20 mA Current Loop interface
- Top of Form
- Adjustable Margins
- Double wide characters
- Parity selection
- Optional APL character set

Over 5,000 DS120 units are now being used by customers ranging from the Fortune 500 to personal computing enthusiasts. In numerous installations, entire networks of terminals have been upgraded to take advantage of today's higher speed data communications services. LSI microprocessor electronics and strict quality control ensure dependable performance for years to come. When service is required, we will respond promptly and effectively. Best of all, we can deliver immediately through our nationwide network of distributors. Just give us a call for all the details.



### datasouth computer corporation

4216 Stuart Andrew Blvd. • Charlotte, North Carolina 28210 • 704/523-8500

### Programmed I/O

When I/O is programmed, the microprocessor directly monitors the state of peripherals by reading status registers and doing conditional branches as appropriate. The big advantage of this approach is that programs can be written in a virtually hardware independent manner; for example, all commercially available programs designed to run under CP/M use programmed I/O. Some very sophisticated real-time programs have been written this way; Wordstar, a word processor, can concurrently print a file, monitor the keyboard, and update the screen display in real time. Unfortunately, the disadvantages of using programmed I/O for real-time programs are enormous. The major problem is that implementation of any useful real-time algorithm requires tricky and hard-to-modify programming because the program must always check flags fast enough to catch desired inputs; these checks must be done at frequent intervals, *no matter what path the program takes*.

As an example of a solution to a real-time problem in a programmed I/O environment, listing 1 (see page 464) outlines a program that periodically reads analog data, analyzes it, and outputs results to a printer. Written in Pascal, the program uses three coroutines (the main routine, CHECK\_A\_TO\_D, and ANALYZE\_DATA) and two subroutines (OUTPUT\_RESULTS and CHECK\_KEYBOARD), all operating asynchronously and passing data to each other via FIFO buffers. In looking at the listing, note how awkwardly the coroutines are imple-





mented necessarily (using CASE statements) and how the programmer must anticipate the execution time required for each program segment. Hardware interrupts can eliminate these problems.

### Interrupt-Driven I/O

Almost all micro- and minicomputers support hardware interrupts. An interrupt is a subroutine CALL initiated at the request of a peripheral device; modern computers have

vector-interrupt schemes that allow each interrupting peripheral device to initiate a CALL to its own service routine. Most bus standards specify a priority-interrupt arrangement whereby a high-priority device may interrupt the service routine of a lower-priority device. The main program usually does the lowest-priority tasks (i.e., any device may interrupt it), but the interrupts may be disabled (locked out) when it has a high-priority job to do or when intertask

communication buffers are being updated.

The advantages of using interrupt-driven I/O for real-time jobs are substantial: first, the technique greatly reduces time lags in servicing input devices; this feature is especially important when you are sampling analog data at supposedly regular intervals. Second, programs run faster because they require little overhead for switching between coroutines or reading status registers. Third, devices requiring frequent servicing may be accommodated while the microprocessor is still doing useful data analysis. And last, clean real-time programs practically fall out of an interrupt-driven I/O environment; the main routine (usually doing the job of processor #2, data analysis) and the interrupt service routines can be thought of as coroutines doing one of the four types of subjobs in the general algorithm. The disadvantage of interrupt-driven programs is that they are hardware dependent, an insuperable problem for commercial CP/M programs unless a hardware package is provided with the software. Listing 2 (page 467) shows the same real-time problem treated in listing 1, but in listing 2, it is solved using interrupt-driven I/O. I have tried to illustrate most of the tricks you will need and pitfalls you will encounter in setting up an interrupt-driven program; in particular, remember that you rarely know when any peripheral is going to request service.

In my discussion so far I have avoided one of the biggest real-time programming headaches—writing to mass-storage devices. I mentioned earlier the schizophrenic nature of the data-storage function: a low-priority job most of the time, it's absolutely unintermittible during the actual data transfer (an 8-inch double-density floppy disk must get a new byte every 16 microseconds when writing a sector). And most storage-device-handling routines do not even allow interrupts during noncritical operations (e.g., when a disk is seeking a new track), thus further compounding the problem. There are, however, several solutions.

# DECADES OF SERVICE

## Washington Computer Services

97 Spring Street  
New York, New York 10012

TO ORDER: CALL OUR TOLL-FREE NUMBER: (800)221-5416

In N.Y. State and for technical information: (212) 226-2121

HOURS: 9:30 AM—5:30 PM (EST) Monday-Friday

an affiliate of **WASHINGTON ELECTRIC COMPANY** est. 1912  
CUSTOM COMPUTER ROOM WIRING SINCE 1960

TELEX: 12-5606 CABLE: WASHCOMP NYK

### FULLY CONFIGURED BUSINESS SYSTEMS

The following are some examples of the fully assembled and tested business and scientific computer systems which we offer:

**IMS** The Premier Multi-User Computer System  
8000 8X multi-processor Turbo DOS  
CPM 2.2 FULL 2 YEAR WARRANTY\*  
5000 IS, S-100 desk top mainframe  
8000 B up to 16 user  
3270 Software Available  
On-Site Service Contracts Available

CALL FOR  
COMPLETION

**NEC** APC-8006, 16 bit, 128K, 8" DRIVES, Optional 9024 x 1024 Color  
Graphic, 32 bit FP Proc., MS DOS, CP/M 86  
**PC-8800 Personal Computer**  
The Professional's Work Station



Our most flexible high performance system! Z-80 standard, 8088 16-bit processor optional, ROM Basic (8/16 bit), Graphic RAM, 64K user RAM standard, supports up to 256K. Both 5 1/4 and 8" floppies. Most sophisticated graphics include 3 individually-controlled windows, 640x200 pixel resolution, overall text & graphics, RGB or composite display, serial & parallel ports, cassette interface  
NEC on N.Y.S. Contract #P-07230

**EPSON** NEW QX-10 Micro with  
VALUOSOFT software: \$2995.

68000 16 bit multi-user, S-100 UNIX V. 7

8000 16 bit, 128K RAM, S-100, Gazelle

**System Group** **ALTOS** **MORROW DESIGNS**

Callifornia Computer Systems **BOBBOUT** **8 & 16 BIT BOARD & SYSTEMS**

InterSystems **NorthStar**

SCION Microtagete Hi Res Graphics Systems

Similar savings on IBM, DELTA, BYNABYTE, TELEVIDEO, DIBAC, ADAS, DEC, OXIA GEN., ATAN, TECHMAN, EPSON, ZENITH, MINORNA AND MANY OTHERS

Where Do You Turn To Solve Your Computer Puzzle?



### TURN TO US!

We'll show you the easiest way to put the pieces together.

Matched, Compatible, Proven—Use Someone Else's Engineering To Supplement Yours.

### SOFTWARE

Over 2000 business scientific, professional applications & educational packages are available. Call with your requirements for our advice or a quotation. We feature DBase II & Fox & Gate

**8" DISK DRIVE SALE NOW!**  
8" SHUGART SARDIN \$385 8" SHUGART SA 801R \$540 2 for \$1025  
QUME DATATRACK 8 or MITSUBISHI \$580 2 for \$1080  
Enclosure, power supply for 2 8" drives A & T \$350  
MORROW DISCUS 20 + CP/M MICROSOFT BASIC, CONT. \$350  
VISTA \$CALL

**TERMINALS**  
TELETYPE AMPLEX QUME  
TELEVIDEO ADAS (IBM 3101)  
LEARN SIEGLER ANN ARBOR DIGITAL EQUIP. CORP.  
VISUAL HAZELTINE

**PRINTERS**  
Teletype 48L 300 LPM-typewrite quality RS-232C from Only \$3200  
Teletype 43 This quality printer is available in every configuration including hard access, quantized case, etc. from \$999

**ANADEX** **DIABLO** **MANNESMANN TALLY**  
**CENTRONICS** **EPSON** **NEC AMERICA**  
**C. ITOH** **FACIT** **QUME**  
**DATA PRODUCTS** **OKIDATA** **TOSHIBA**  
**DIGITAL EQUIP. CORP.** **OLIVETTI** **TELETYPE**  
**INTERGRAL DATA SYS.** **QANTEX** **TEXAS INSTRUMENTS**

**PLEASE!** Do not confuse us with mail order dealers. We are a full service distributor serving the data processing & installation needs of business & industry from micros to mainframes. System houses, educational institutions & governmental agencies given special consideration. Leasing available.

N. Y. State agencies, municipalities, and schools — call us for information on our O.G.S. term contracts on hardware & software.

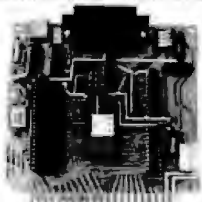
### DEALER and INTERNATIONAL INQUIRIES WELCOME

For fast delivery, send certified check, money order or call to arrange direct bank wire transfer. Personal or company checks require two to three weeks to clear. Prices subject to change without notice. Call for latest prices. Prices include 3% cash discount. N.Y. residents add sales tax. Centex is a trademark of North Atlantic Industries, Inc. CP/M is a trademark of Digital Research. All sales subject to our standard sale conditions (available on request). Call for shipping charges. Above prices do not include customization or installation. DBase II is a trademark of Ashton Tate. P.O.'s accepted upon our credit approval; call for prices and terms.

# Micromint will put both a computer development system and an OEM dedicated controller in the palm of your hand for as little as \$127.\*

The Z8 Basic Computer/Controller represents a milestone in microcomputer price-performance. The entire computer is 4" by 4 1/2" and includes a tiny BASIC interpreter, 4K bytes of program memory, one RS-232 serial port and two parallel ports plus a variety of other features. The Z8 microcomputer board is completely self-contained and optimized for use as a dedicated controller. Can be battery operated. Comes with over 200 pages of documentation.

## Z8 BASIC COMPUTER/CONTROLLER

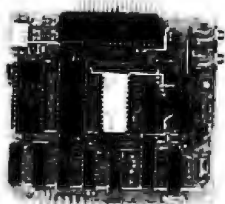


- Uses Zilog Z8671 single chip microcomputer
- On board tiny BASIC interpreter
- 2 parallel ports plus serial I/O port.
- Just connect a CRT terminal and write control programs in BASIC
- 4K bytes of RAM. EPROM pin compatible
- Baud rates 110-9600 BPS
- Data and address buses available for 124K memory and I/O expansion
- Consumes only 1.5 watts at +5, +12 & -12v.

**BCC01 Z8 Basic Computer**  
Assembled & Tested .. \$199.00  
**BCC02 Z8 Basic Computer**  
Kit ..... \$169.00

**COMING SOON**  
A/D Converter 8 Channel 8 Bit  
AC I/O Board  
• 4 Channel 115Vac inputs  
• 4 Channel 115Vac outputs  
20 MA ADAPTER

## Z8 MEMORY, I/O EXPANSION & CASSETTE INTERFACE



The Z8 Memory, I/O Expansion & Cassette Interface Board (Z8 Expansion Board for short) allows you to add up to 8K of additional memory plus three 8-bit parallel ports to your Z8 Basic Computer/Controller. The memory expansion will support any combination of byte wide RAM memory chips or 2716 or 2732 EPROM. The cassette interface is 300 baud Kansas City Standard (2400Hz/1200Hz).

**BCC03 Z8 Expansion Board**  
w/4K memory ..... \$140.00  
**BCC04 Z8 Expansion Board**  
w/8K memory .. \$170.00

## Z8 EPROM PROGRAMMER

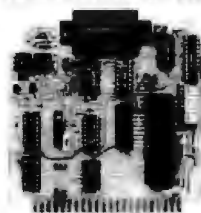


The EPROM Programmer board allows you to transfer application programs in BASIC or Assembly language directly from RAM to either 2716 or 2732 EPROMS. Requires Z8 Basic Expansion Board for operation.

NOTE: We recommend the higher current UPS03 or UPS04 power supply when using the EPROM Programmer.

**BCC07 Z8 EPROM Programmer**  
Assembled & Tested  
... \$145.00

## Z8 SERIAL EXPANSION BOARD



The Serial Expansion Board adds an additional RS-232C serial port to the Z8 system. It runs at 75 to 19,200 baud in all standard protocols. The 20 ma. current loop is opto-isolated for reliability and protection.

**BCC08 Z8 Serial Board**  
Assembled & Tested ... \$180.00

## MOTHER-BOARD

**MB02 Z8 Mother Board**  
with 5 connectors (Gold)  
Assembled & Tested .... \$81.00

## UNIVERSAL POWER SUPPLY

+5 @ 300 ma. +12 & -12V @ 50 ma.  
**UPS01 Assembled and**

Tested ..... \$ 35.00  
**UPS02 Kit** ..... \$ 27.00

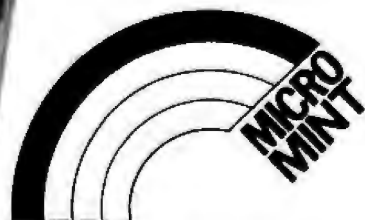
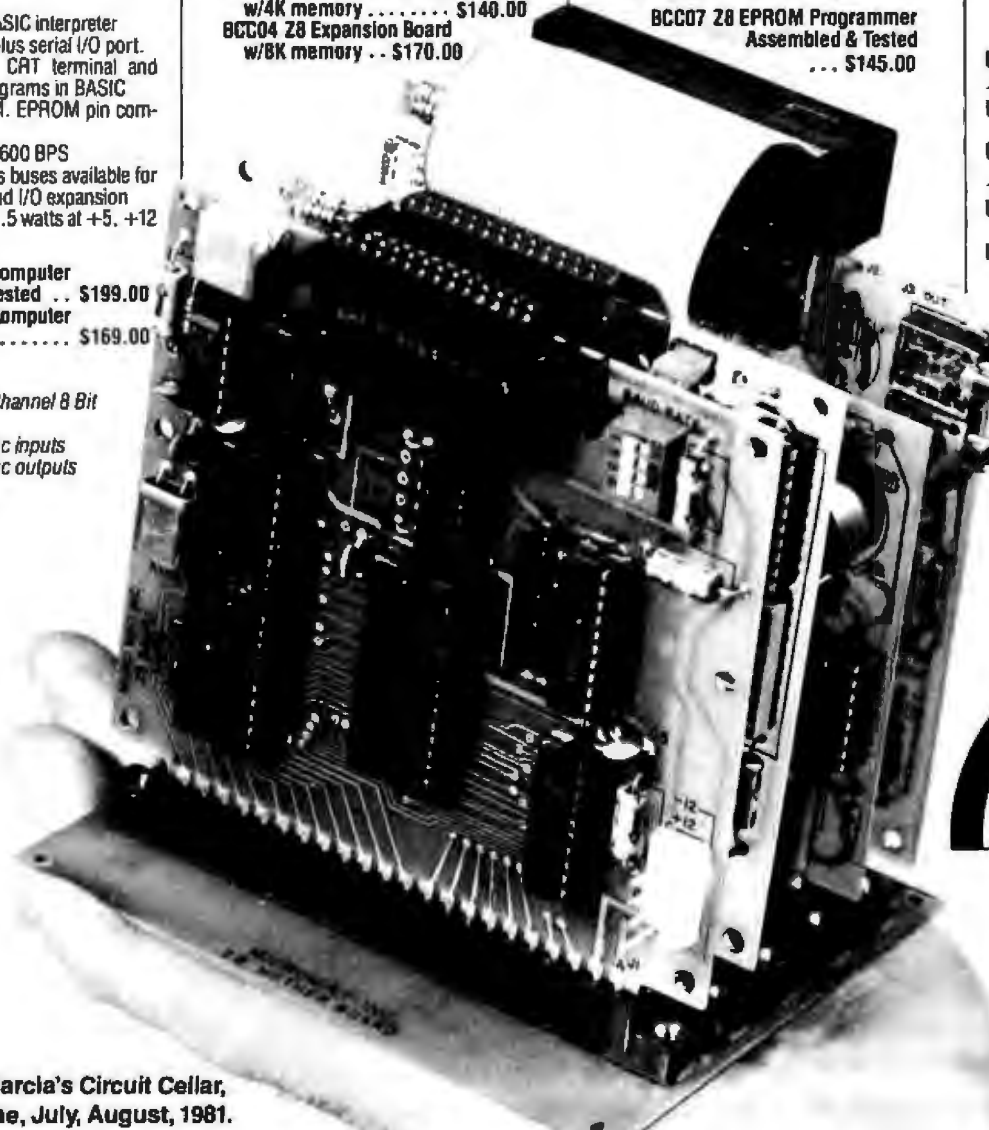
+5 @ 1 amp. +12 & -12V @ 50 ma.  
**UPS03 Assembled and**

Tested ..... \$ 60.00  
**UPS04 Kit** ..... \$ 50.00

## Z8 CROSS ASSEMBLERS

FROM ALLEN ASHLEY  
**XAS01** For TRS-80 Mod I \$ 75.00  
**XAS02** For TRS-80 Mod III \$ 75.00  
**XAS03** For CP/M-8" .... \$150.00

FROM MICRO RESOURCES  
**MR01** CP/M-8" Diskette . \$ 75.00  
**MR02** APPLE II CP/M 5 1/4" \$ 75.00



**MICROMINT INC.**  
561 Willow Avenue  
Cedarhurst, NY 11516

**To Order:**  
Call Toll Free  
1-800-645-3479  
**For Information Call:**  
1-516-374-6793

Circle 300 on Inquiry card.

as featured in Clarica's Circuit Cellar,  
Byte Magazine, July, August, 1981.

\*8 is a trademark of Zilog Inc

CP/M is a trademark of Digital Research

\*In quantities of 100



The only solution available in a programmed I/O environment is just to work around the problem: output a Control-G to beep the console and write "stop typing" to the console before beginning any disk I/O; save the time when you start the write (if you have a clock), read the time when you get back, and then somehow deal with the gap in your input data. In an interrupt-driven I/O environment, two other solutions are available when floppy disks are the storage

media: the first involves getting into your disk driver and moving the disable-interrupt instruction (DI) so that it executes just before the actual write command (after completion of all that time-consuming seeking); in this case, only 167 milliseconds (ms), at most, will be unavailable for interrupts (one revolution of the disk). If your peripherals interrupt infrequently, you can employ an alternate solution: remove all DI instructions from the disk driver. Occasionally a pe-

ripheral will interrupt when an actual data transfer is in progress, but such an interrupt generates only a soft error (a lost-data error condition set in the disk-controller status register) for most disk drivers. Data transfer should succeed on one of the error retries. I am somewhat ashamed to even suggest these stopgap measures, since the only proper solution is to buy, borrow, steal, or manufacture direct-memory-access hardware for your mass-storage devices (hereafter assumed to be floppy disks).

### Direct-Memory-Access I/O

A peripheral with DMA capability can be set up to act exactly like an independent coprocessor for the all-important fast-data-transfer task. It works like this: before sending a write command to the disk controller, the microprocessor tells the DMA controller where its buffer is located and how many bytes it needs to transfer. Then the write command is initiated, and the microprocessor goes on about its business. When the disk controller has found the proper sector it sets a flag indicating that it's ready for data. The DMA controller responds to the flag by requesting control of the bus from the microprocessor. At the end of its current memory cycle, the microprocessor relinquishes control of the bus and acknowledges the bus request. Upon receiving bus acknowledgment, the DMA controller reads a data byte from its buffer and transfers the data byte to the disk controller. The DMA controller then returns the bus to the microprocessor and increments its buffer address and byte count. If the byte count is exhausted, the DMA controller sets status flags and generates an interrupt if it has been so programmed (usually the disk controller is allowed to do the interrupt for end of transfer because the write command might abort on an error before transfer is complete). The whole process takes only a few microseconds for each byte; the microprocessor is hardly slowed down at all, and an interrupt can safely occur *any* time during the transfer.

A number of disk controllers with DMA capability are now available

ALL

SOFTWARE

# 1/3 off

**Software Catalog. FREE.** Get the lowest price on every software program you need. 1/3 off list price *guaranteed*. And look what else you get from ITM:

**Unlimited Consultation!** ITM's consultants work with an amazing database indexed with over 300 software selection criteria — plus thousands of in-depth product reviews. You'll get the programs that are right for you. Quickly. Easily. It's the most sophisticated consultation service in the industry. Call toll free!

**Over 2,000 programs to choose from.** Hundreds added every month. All categories. All formats

**See any program demonstrated.** Order any non-entertainment program for a *risk-free, thirty-day trial*. Full refund if not completely satisfied.

**No minimum order.** Buy just one program if you like. Quick shipments.

Call ITM now. Or, mail the coupon today and receive our FREE Software Catalog. Save hundreds—even thousands—of dollars on all of your software purchases with ITM.

American Express, Visa, or MasterCard honored

Call toll-free today

**(800) 334-3404**

In California (415) 284-7540

**Software Catalog. FREE.**

BYTE 583

YES. Send complete information for my review. Please include a free copy of ITM's Software Catalog.

NAME \_\_\_\_\_

COMPANY NAME \_\_\_\_\_

ADDRESS \_\_\_\_\_

CITY/STATE/ZIP \_\_\_\_\_

PHONE \_\_\_\_\_

Individual  Dealer  Consultant  Company

## ITM

Software Division

We make software buying simple.

Attn: Stevan Cloudtree  
936 Dewing Ave., Suite E  
Lafayette, CA 94549-4292  
(800) 334-3404 or  
(415) 284-7540

## DISKULATOR

THE MOST VERSATILE AND EXPANDABLE MEMORY BOARD FOR THE APPLE IIe COMPUTER IN THE WORLD 64K-512K NOW SHIPPING!

The DISKULATOR allows operation of virtually all software developed for use with other memory boards. By simple user selection you can operate the board in different modes.

The DISKULATOR will allow you to start BIG and get even BIGGER! Buy the 64/128K board now and arrange for an upgrade later to a higher size if you then need more memory.

The DISKULATOR has no cable and will operate like a language card in your Apple II or IIe.

If you already have a memory board, don't despair - DISKULATOR software allows you to combine boards from different manufacturers.

Incredible NEW utility software supplied includes

- \* MACRODISK-MULTI which automatically handles boards of different sizes or bank-select standards, and allows you to set the size and number of RAM-DISKS (up to 3) in 16K increments. Also supplied are MACRODISK for Pascal and CP/M.

- \* MACROSPEED, the fantastic HIGH-SPEED COPY program you've been waiting for. Multiple copies are now quick and easy!

- \* UPLOAD/DOWNLOAD programs which enable high speed backup and retrieval of a whole disk automatically or under program control.

- \* MEMORY DIAGNOSTICS

Dealers, distributors and software developers - you cannot afford to ignore the most expandable and flexible memory board on the market. Contact us today!

DISKULATOR, MACRODISK - tm of MACROTECH Computer Products Ltd. Apple II, Apple IIe are trademarks of Apple Computer Inc. CP/M is a trademark of Digital Research Inc.

Canada: 1370 Marine Drive, N. Vancouver, B.C. V7P 1T4 (604) 984-9305  
USA: 3249 Hackett Ave., Long Beach, CA 90808.

## MACROTECH Computer Products Ltd.

# START YOUR OWN COMPUTER CO.

**HOW TO START YOUR OWN SYSTEMS HOUSE** \$36.  
7th edition, November 1981

Written by the founder of a successful systems house, this fact-filled 220-page manual covers virtually all aspects of starting and operating a small systems company. Contracts, proposals, agreements and a complete business plan are included in full, and may be used immediately. Proven, field-tested solutions to the many problems facing small turnkey vendors are presented.

**HOW TO BECOME A SUCCESSFUL COMPUTER CONSULTANT** \$28.  
By Leslie Nelson, 4th revised edition, December 1981

The rewards of the consultant can be high: freedom, more satisfying work and doubled or tripled income. This manual provides comprehensive background information and step-by-step directions for those interested to explore this lucrative field.

**HOW TO START YOUR OWN COMPUTER STORE** \$145.  
1st printing, April 1983

Computer store strategies. Optimum product mix. Brands to avoid. Working with distributors. Software selection. When to consider franchises. Where to find good personnel. Selecting the right location. The start-up plan. The seven best promotion strategies. Financial plan. Three low budget approaches.

**HOW TO START YOUR OWN WORD PROCESSING SERVICE** \$48.  
By Leslie Nelson, 2nd edition, November 1982

Turn a small investment into a steady, money making business that adds \$10,000, \$50,000 or \$100,000 to your income. Detailed start-up, marketing and operations plans are included.

**HOW TO SELL YOUR MICRO SOFTWARE** \$19.95  
By B.J. Korites, Ph.D., May 1982

The best practical guide for those with software to sell. Detailed discussion of the eight best marketing strategies. How to sell through distributors, brokers, computer manufacturers. Advertising techniques. Pricing. Software security.

Send check, money order, VISA, MasterCard or American Express # and exp. date. Publisher pays 4th class shipping. Add \$1.00 per book for UPS shipping (USA only). NJ residents add 6% sales tax. For faster shipment on credit card orders call (201) 783-6940.

ESSEX PUBLISHING CO. Dept. 2  
285 Bloomfield Avenue • Caldwell, N.J. 07005



Star Gemini-10 100 CPS, 9x9 in. mono graphic, friction/friction feed, 80 column, Parallel interface. SCALL Gemini 15 15" carriage. SCALL



The new Epson MX-100 in stock now. 160 CPS top speed plus all the features of the MX-80 and more. SCAL

C. Tech ProWriter 8510AP, 120 CPS, 80 col., Graphics, Parallel ... \$389  
C. Tech ProWriter-II 1650, 120 CPS, 136 col., 2K buffer, parallel ... \$699



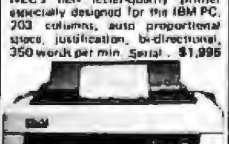
Okidata ML80P, 80 CPS, 90 col., dot-matrix graphics, pin & friction feed, Parallel interface ... \$329

Okidata ML82A, 120 CPS, 80 col. graphics, parallel & serial ... \$399  
Okidata ML83A, 120 CPS, 136 col., bi-directional, friction/friction feed, dual parallel/serial interface ... \$699  
Okidata ML84, 200 CPS, 136 col., bi-directional, friction/friction feed, parallel interface ... \$899  
Okidata ML84E, same as ML84 but serial interface ... \$1,099

Okidata ML82, The newest! 80 col., 180 CPS, friction/friction feed, graphics, parallel interface ... \$399  
Okidata ML93, The newest! 160 CPS, 136 col., tractor/friction feed, bi-directional, parallel ... \$899

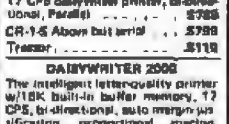


NEC's new letter-quality printer especially designed for the IBM PC. 703 columns, auto proportional spacing, justification, bi-directional, 350 words per min. Serial ... \$1,995



BROTHER HR-1 Letter quality daisy-wheel printer 15 CPS, bi-directional, friction feed, parallel interface. Street value \$799. Serial interface ... \$829  
Tractor ... \$118

COMREX CR-1-C 17 CPS daisy-wheel printer, bi-directional, Parallel ... \$785  
CR-1-S Above but serial ... \$788  
Tractor ... \$118



DATAMASTER 2000 The intelligent letter-quality printer w/18K built-in buffer memory, 17 CPS, bi-directional, auto margin justification, proportional spacing, auto baud rate selection from 50-18,200 baud. Dot-matrix graphics include absolute and relative vector plotting for charts & graphs. Four universal interfaces ... \$1,095  
Tractor for Datamaster 2000 ... \$129  
Cut sheet feeder ... \$725



C. Tech F-10 StarWriter 40 CPS daisy-wheel (parallel) SCALL 35 CPS daisy-wheel (parallel) \$1,575  
Tractor for F-10 ... \$225

### AST Multi-Function Cards for IBM PC and XT New Low Prices!

ComboPlus Cards offer a maximum of 8 features. User expandable parity checked memory from 64K to 256K. The new cards now come with a battery-backed up clock/calendar, a serial port and a parallel port as standard features. Printer buffer, electronic disk emulator and clock utility programs are included on diskette along with an extensive User's manual. Amount of memory installed on card: 64K 128K 192K 256K with all options (serial, parallel ports & clock) - \$329 \$386 \$468 \$539

MemuPlus Cards offer a maximum of 8 features. User expandable parity memory from 64K to 512K. Serial port No. 1 and clock/calendar included with each card. Disk emulator & Print spooler programs are also included. Amount of memory installed on card: 64K 128K 192K 256K w/ standard features indicated above: \$330 \$400 \$470 \$540 w/ either parallel or additional serial port No. 2 \$410 \$480 \$550 \$620 w/ both parallel and additional serial port No. 2 \$410 \$480 \$560 \$620 MemuPlus - expands a fully populated MegaPlus card to 512K ... \$320

I/O Plus Cards - Standard features include a serial port (S1), and a clock. Printer buffer, clock utility and disk emulator programs are also included. Options can be added: Game port (G), Parallel port (P), Serial Port (S2). Standard card w/one serial port (S1) and clock/calendar ... \$145 with ONE additional option (G, P, or S2) ... \$185 with TWO additional options (GP, GS2, or PS2) ... \$225 with all THREE additional options (GPS2) ... \$265



### DATAMAG HARD DISKS

DATAMAG "Add-on" Winchester Disk System includes hard disk, disk controller card, cable, software, auxiliary power supply which mounts neatly behind IBM PC system unit, and all necessary documentation to insure ease of installation. System is fully buffered with automatic error correction code. All hard disks will fit neatly into the right-hand slot of the IBM PC. 6 MB (5 MB formatted) ... \$1,599 12 MB (10 MB formatted) ... \$1,999 18 MB (15 MB formatted) ... \$2,999



ComboPlus Cards offer a maximum of 8 features. User expandable parity checked memory from 64K to 256K. The new cards now come with a battery-backed up clock/calendar, a serial port and a parallel port as standard features. Printer buffer, electronic disk emulator and clock utility programs are included on diskette along with an extensive User's manual. Amount of memory installed on card: 64K 128K 192K 256K with all options (serial, parallel ports & clock) - \$329 \$386 \$468 \$539

MemuPlus Cards offer a maximum of 8 features. User expandable parity memory from 64K to 512K. Serial port No. 1 and clock/calendar included with each card. Disk emulator & Print spooler programs are also included. Amount of memory installed on card: 64K 128K 192K 256K w/ standard features indicated above: \$330 \$400 \$470 \$540 w/ either parallel or additional serial port No. 2 \$410 \$480 \$550 \$620 w/ both parallel and additional serial port No. 2 \$410 \$480 \$560 \$620 MemuPlus - expands a fully populated MegaPlus card to 512K ... \$320

I/O Plus Cards - Standard features include a serial port (S1), and a clock. Printer buffer, clock utility and disk emulator programs are also included. Options can be added: Game port (G), Parallel port (P), Serial Port (S2). Standard card w/one serial port (S1) and clock/calendar ... \$145 with ONE additional option (G, P, or S2) ... \$185 with TWO additional options (GP, GS2, or PS2) ... \$225 with all THREE additional options (GPS2) ... \$265



### HERCULES GRAPHICS CARD

This card will give high resolution bit mapped graphics (720x4348) on the IBM monochrome display. Complete with parallel printer port. Both text and graphics can be displayed simultaneously. SCALL



Hayes Smart Modem 300 ... \$225 1200 ... \$639



GREEN SCREEN  
Dynex GM-120, 12" green, 600 line 20 MHz. Made by JVC. Excellent! List \$200.00 ... \$129.00  
Toscan KG-120, 12" green 800-dot, List \$199.00 ... \$149.99  
Zenith ZVM121, 12" green, 15MHz List \$199.00 ... \$119.00  
Amdak 300G, 12" green, 900 line, 18 MHz ... \$175

AMBER SCREEN  
DyneX AM121, 12" amber 800-dot 70 MHz. Made by JVC. Excellent! List \$250.00 ... \$149.00  
Toscan KA124, 12" amber, 800-dot, List \$205.00 ... \$150.00

RGB COLOR  
EMC BM-AUB1918RU, 12" RGB color, w/ cabinet cable to match IBM (as shown above) ... \$649



Princeton HX-12, 12" RGB color, 890 dots, 80 char x 25 lines (optional IBM) cabinet. Most pleasing & best price performance monitor for your IBM PC. List \$199.00 ... \$135.00  
Toscan RGBvision II, 12", 880-dot, 18 MHz, 2,000 char. (5x7 dots). List \$389.00 ... \$385.00  
Toscan RGBvision III, 12", 510-dot, 18 MHz, 2,000 char. (5x7 dots). List \$899.00 ... \$549.00  
Toscan RGBvision III, 12", 630-dot, 18 MHz, 16 colors, \$840.00  
Cable: Toscan to IBM or Apple III ... \$195



### IBM Personal Computers

The new XT Model available now. Call for prices & configurations.

### SOFTWARE FOR IBM PC

- 1-2-3 (Req. DS drive) ... \$495 \$368
- IBASE II ... \$700 \$468
- TK Solver ... \$345
- T.M. III ... \$495 \$349
- WordStar ... \$495 \$339
- MainMerge ... \$250 \$180
- SpellStar ... \$5250 \$170
- VisiCalc/759K ... \$750 \$170
- VisiFile ... \$300 \$219
- VisiData ... \$250 \$199
- VisiSchedule ... \$300 \$225
- Business Forecast Model ... \$100 \$89
- Desk Top Plan ... \$300 \$229
- VisiWord ... \$375 \$296
- VisiSpell ... \$225 \$195
- VisiTrend/Print ... \$300 \$229
- SuperCalc ... \$295 \$198
- Spellguard ... \$395 \$279
- Spelling ... \$195 \$149
- Verbatim ... \$389 \$259
- PrachPack (GL/AR/AP) ... \$595 \$395
- The Tax Manager ... \$280 \$179
- Home Accountant Plus ... \$150 \$100
- 1st City Mail ... \$125 \$99



### 5 1/4 INCH DRIVES

The newest IBM PC compatible. Installation instruction included. T8100-1A, 5.5DD 160K ... \$195  
T8100-2A, 5.5DD 320K ... \$269

**EASTERN ENTERPRISES, INC.** 2937 S. VAIL AVE., LOS ANGELES, CALIF. 90040  
TOLL-FREE ORDERS ONLY (800)392-7081 Call, Alaska, Hawaii & all info Call (213)725-3080

To order, please send money order or cashier's check. Personal or company checks require 2-3 weeks to clear. Prices reflect 3% cash discount. Visa/Mastercard accepted. Shipping, insurance & handling charges are 3% of total order value by UPS Surface, 5% by UPS Air or Parcel Post. COD's require 20% deposit. California residents add sales tax. No sales tax on out-of-state orders. Prices & availability subject to change without notice. Send for catalog of other items at similar savings.



for the S-100 bus and are definitely worth the extra \$100 if you ever plan to write a real-time program. Most manufacturers supply software, but to get to know a machine inside out, you should try writing an interrupt and DMA-driven disk I/O routine. Furthermore, standard software routines wait while the write takes place to prevent the calling program from corrupting the buffer area before the transfer is done. If the manufacturer supplies a listing of its software, a

little creative tinkering can defeat the wait and enable one of the coroutines in the calling program to monitor the transfer to see when the buffer is free for more data; alternatively, you could alter the end-of-transfer interrupt service routine to perform whatever services your data storage subjob needs then. Poor or enthusiastic hardware hobbyists might want to experiment with the powerful DMA controller chips available for most microprocessors.

## Final Words and Warnings

There are some tricky spots where you should watch your step. Because the key to good real-time programming is buffering and asynchronous processing, some strange time relationships can develop between events in the real world and events in the logical worlds of the coroutines. In fact, the term *real-time* is misleading because all programs work on data that was collected at some prior real-world time. Consider, for example, a 500-byte input buffer filled at a one-byte-per-second rate by an analog/digital-converter service routine; if the data analysis routine got temporarily behind for some reason (e.g., it needed to do a lengthy calculation), real-time for the data-analysis routine might be several minutes behind real-time from the point of view of a keyboard service routine. Normally, these time shifts are advantageous because they allow more useful work to be wrung out of the computer while still catching all input data. But they can cause problems in some situations. For example, if the computer is used as a smart controller in a feedback loop, then both data input and control output must have high priority; time-consuming tasks in the data-analysis routine should not interfere with delivery of timely control data to the output routine (two data-analysis coroutines might be appropriate in this case: one to compute and pass along control data and a second to do other lower-priority analysis).

While data buffering occasionally can have some confusing side effects, it also comes with a bonus. After a program has been running awhile, the input buffer contains a log of the input data. Thus, any data-analysis routine can detect an event and then look back to see what led up to it. (This ability is the primary selling point for digital oscilloscopes and logic analyzers, devices that are just real-time-programmed digital processors.)

If you follow the general rules outlined here, you will find real-time programming to be a creative and rewarding activity. ■

**Send now for FREE McGraw-Hill computer catalog**

**Books, software, film, and other media on...**

- Programming Languages
- Advanced Computing
- Users Guides
- General Interest
- Introductory Computing
- Information Systems
- Word Processing
- Software

**...for all levels of computer users**

**McGraw-Hill the professional's publisher**

Mail coupon today to:

McGraw-Hill Book Co. • Marketing Services Dept. • 5-1, Hightstown/Princeton Road • Hightstown, New Jersey 08520

Yes, send me a copy of the new 1983 McGraw-Hill Computer Catalog

Name \_\_\_\_\_ Title \_\_\_\_\_

Company \_\_\_\_\_ Address \_\_\_\_\_

City \_\_\_\_\_ State \_\_\_\_\_ Zip \_\_\_\_\_ Tel # \_\_\_\_\_

I own a personal computer:  Yes  No If yes, which? \_\_\_\_\_

I am a  first-time user  hobbyist  engineer  businessperson  programmer/analyst

DP professional  computer designer  educator  other \_\_\_\_\_

1-CC-700-4440-3

**Smith-Corona TP-1 Daisy Wheel Printer**

only **\$499<sup>00</sup>**

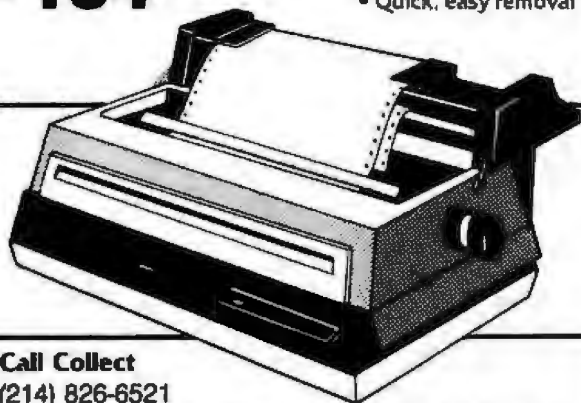
**UNBELIEVABLE!**

- fully-formed characters
- compatible with most micro-computers
- serial or parallel interface
- choice of 10 or 12 CPI models

Also for your TP-1 letter quality printer —  
**the Smith-Corona Tractor Feed**

**\$134<sup>95</sup>**

- Adjustable tractor widths
- For continuous forms
- Quick, easy removal



**Call Collect**  
(214) 826-6521

**FIGURE-LOGIC BUSINESS EQUIPMENT, INC.**  
6408 Gaston Avenue / Dallas, Texas 75214

**QUALITY  
SERVICE  
AVAILABILITY**



**ACTIVE, YOUR  
NUMBER ONE  
CHOICE**

**Active Electronics**

**WE ARE THE LARGEST BECAUSE WE ARE THE BEST.**  
Over \$40 million in stock. The world's most complete hobbyist inventory.

Active Electronics is your one stop source for the widest variety of top quality semiconductors, microprocessors, memories, microcomputer systems, peripherals and electronic components.

**NEW — 1983 IC MASTER**

The FIRST and ONLY complete guide to IC's, Microcomputer Boards and Development Systems. Deluxe 3-volume set 3300 pages. Regular Price: \$95.00

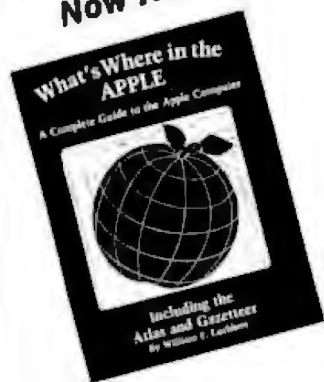


Call or write for our FREE comprehensive catalogue. If you work with electronics you shouldn't be without it!

**ACTIVE'S PRICE  
ONLY \$79.95**

Circle No. 6 on free information card or write:  
P.O. Box 8000, Westboro, Mass. 01581  
**CALL TOLL FREE: 1-800-343-0874**  
MASS. customers call (617) 366-0500

**Revised Edition  
Now Available!**



**All New Text Added To The Original Atlas And Gazetteer...**

**“What's Where in the Apple”  
A Complete Guide to the Apple Computer.**

This revised edition of the famous Apple Atlas will:

- provide you with more information on the Apple's memory than is available elsewhere
- guide you with a numerical Atlas and an alphabetical Gazetteer — to over 2000 memory locations of PEEKs, POKEs and CALLs
- give you names and locations of various Monitor, DOS, Integer BASIC and Applesoft routines and tells you what they're used for
- enable you to move easily between BASIC and machine language
- guide you through the inner workings and hidden mechanisms of the Apple

All Apple users will find this book helpful in understanding their machine and essential for mastering it. The Atlas and the All New Guide are now available in one 256-page Wire-O-Bound book for only \$24.95.

If you own the original What's Where in the Apple purchase The Guide to complete your edition. This 128-page Wire-O-Bound version contains all the new material to be used with the memory map and atlas. Don't miss this opportunity to complete your edition of What's Where in the Apple. Order your copy of The Guide now...only \$9.95

Please Rush  What's Where in the Apple @ \$24.95 (plus \$2.00 s/h)  
 The Guide @ \$9.95 (plus \$2.00 s/h)

I'm paying by  Check  MO  VISA  MasterCard

Name \_\_\_\_\_

Credit Card # \_\_\_\_\_

Address \_\_\_\_\_

Card Expires \_\_\_\_\_ Total Enclosed \$ \_\_\_\_\_

City \_\_\_\_\_ State \_\_\_\_\_ Zip \_\_\_\_\_

(MA residents add 5% tax)

**MICRO, 34 Chelmsford Street, P.O. Box 6502, Chelmsford, MA 01824**

**Call Toll-Free 1-800-345-8188 (In PA 1-800-662-2444)**



**Listing 1: Furnishing an example of a solution to a real-time problem in a programmed-I/O environment, this program periodically reads analog data, analyzes it, and outputs results to a printer.**

PROGRAM MEASURE\_ANALOG\_PULSE;

(\* This listing illustrates a solution to a real-time task using programmed input-output; the program is not complete since hardware or implementation dependent procedures are shown as stubs only.

The task that this program executes is as follows:

- 1) An A-D converter is read every time a clock flag is set by a programmable clock. The A-D converter is assumed to return values from 0 to 4095 (i.e. a 12 bit converter).
- 2) If the analog value is greater than some threshold (initially set to 2000) then the program keeps track of how many sample periods it remains supra-threshold and keeps a running sum of the values.
- 3) When the analog value then drops below the threshold value, the duration of the supra-threshold pulse and the average analog value during the pulse are printed to a listing device.
- 4) The threshold may be changed at any time by hitting one of the keys '0' through '9' to set the threshold from 400 to 4000 in increments of 400 (e.g. '5' sets the threshold to 2400). Whenever the threshold is changed the new value is printed on the listing device. Hitting any key other than '0' to '9' terminates execution.

At no time should keyboard input be missed, and all analog values should be read within a few ms of each clock pulse. These conditions should continue to be met even during periods when analog pulses occur frequently.

The program is largely self-documenting. \*)

(\* Three FIFO buffers are used: one for the A-D values, one for keyboard input, and one for lister output. The first part of the definitions is related to implementing these buffers. \*)

CONST

```
A_D_BUF_LENGTH = 100;
KEY_BUF_LENGTH = 20;
OUT_BUF_LENGTH = 200;
LONGEST_BUFFER = 200;
```

TYPE

```
BUFFER_HEADER = RECORD
  INPUT_POINTER,
  OUTPUT_POINTER,
  BUFFER_LENGTH : INTEGER;
  BUFFER_FULL,
  BUFFER_EMPTY : BOOLEAN
END;
```

(\* The Buffer Header keeps the current status of a FIFO buffer. The input pointer points to the next location to be filled, and the output pointer is the next location to be read from the buffer. \*)

```
FIFO_BUFFER = ARRAY[1..LONGEST_BUFFER] OF INTEGER;
STRING20 = ARRAY[1..20] OF CHAR;
```

VAR

```
A_D_HEADER,
KEY_HEADER,
OUT_HEADER : BUFFER_HEADER;
A_D_BUFFER,
KEY_BUFFER,
OUT_BUFFER : FIFO_BUFFER; (* In this example all buffers occupy the
```

same amount of storage space even though their lengths are different. I had to do it this way here because of the strong type checking of standard Pascal; there are a number of ways around this problem in most implementations (e.g. use the NEW function to allocate space at run time and rewrite the buffer handling procedures to use accesses with true pointer type variables). \*)

(\* End of buffer definitions

& start of Globals needed by other procedures. \*)

```
LIST_FILE : TEXT; (* File var for the listing device *)
```

```
A_D_SEGMENT,
```

```
ANALYZE_SEGMENT : INTEGER; (* Used to control flow of the Coroutines *)
```

```
ERBOK, DONE : BOOLEAN; (* Booleans to control program termination *)
```

(\* The following variables are used in the data analysis \*)

```
THRESHOLD, PULSE_COUNT : INTEGER;
```

```
PULSE_SUM, AVERAGE_PULSE_HEIGHT : REAL;
```

```
LAST_VALUE_WAS_OVER_THRESHOLD : BOOLEAN;
```

(\* The following three procedures implement the FIFO buffers \*)

```
PROCEDURE INIT_BUFFER(VAR B_HEADER : BUFFER_HEADER; B_LENGTH : INTEGER);
BEGIN
```

```
  WITH B_HEADER DO BEGIN
```

```
    INPUT_POINTER:=1; (* Next location to be filled *)
```

```
    OUTPUT_POINTER:=1; (* Next location to be read *)
```

```
    BUFFER_LENGTH:= B_LENGTH;
```

```
    BUFFER_FULL:= FALSE;
```

```
    BUFFER_EMPTY:= TRUE
```

```
  END
```

```
END;
```

```
PROCEDURE STORE(VAR B_HEADER : BUFFER_HEADER;
```

```
  VAR BUFFER : FIFO_BUFFER;
```

```
  VALUE : INTEGER);
```

```
BEGIN
```

```
  WITH B_HEADER DO IF NOT BUFFER_FULL THEN BEGIN
```

```
    BUFFER[INPUT_POINTER]:= VALUE;
```

```
    IF INPUT_POINTER = BUFFER_LENGTH
```

```
      THEN INPUT_POINTER:= 1
```

```
      ELSE INPUT_POINTER:= INPUT_POINTER+1;
```

```
    BUFFER_FULL:= INPUT_POINTER = OUTPUT_POINTER;
```

```
    BUFFER_EMPTY:= FALSE
```

```
  END
```

```
END;
```

```
FUNCTION RETRIEVE(VAR B_HEADER : BUFFER_HEADER;
```

```
  VAR BUFFER : FIFO_BUFFER) : INTEGER;
```

```
BEGIN
```

```
  WITH B_HEADER DO IF NOT BUFFER_EMPTY THEN BEGIN
```

```
    RETRIEVE:= BUFFER[OUTPUT_POINTER];
```

```
    IF OUTPUT_POINTER = BUFFER_LENGTH
```

```
      THEN OUTPUT_POINTER:= 1
```

```
      ELSE OUTPUT_POINTER:= OUTPUT_POINTER+1;
```

```
    BUFFER_EMPTY:= OUTPUT_POINTER = INPUT_POINTER;
```

```
    BUFFER_FULL:= FALSE
```

```
  END
```

```
END;
```

(\* The following procedures are all implementation dependent and are shown as stubs with a description of what they have to do. \*)

```
PROCEDURE INIT_LIST_FILE;
```

```
BEGIN
```

*Listing 1 continued:*

```
  (* This procedure should initialize the file variable, LIST_FILE,
  to the listing device; e.g. ASSIGN(LIST_FILE,'LST:'); etc... *)
END;

PROCEDURE START_CLOCK;
BEGIN
  (* Set up the clock to set a flag whenever the A-D needs to be read,
  and start the clock *)
END;

FUNCTION CLOCK_FLAG_SET : BOOLEAN;
BEGIN
  (* Returns TRUE if clock flag is set, FALSE otherwise. *)
END;

PROCEDURE START_A_TO_D;
BEGIN
  (* Initiate an analog to digital conversion. *)
END;

FUNCTION READ_A_TO_D : INTEGER;
BEGIN
  (* Reads the A-D and returns a value from 0 to 4095 *)
END;

FUNCTION KEY_HIT : BOOLEAN;
BEGIN
  (* Returns TRUE if KRDY flag is set from the keyboard DART *)
END;

FUNCTION LST_DEVICE_READY : BOOLEAN;
BEGIN
  (* Returns TRUE if the list device is ready for a character *)
END;

PROCEDURE WRITE_STRING_TO_OUT_BUFFER(VAR STRING : STRING20);
(* This procedure puts the characters into the output buffer until
it encounters a "$". *)
VAR   I : INTEGER;
      C : CHAR;
BEGIN
  I:=1;
  REPEAT
    C:= STRING[I];
    I:= I+1;
  IF C <> '$' THEN BEGIN
    ERROR:= ERROR OR OUT_HEADER.BUFFER_FULL;
    STORE(OUT_HEADER.OUT_BUFFER,ORD(C))
  END
  UNTIL (I=21) OR (C='$') OR ERROR
END;

PROCEDURE WRITE_CRLF_TO_OUT_BUFFER;
VAR   LOCAL_STRING : STRING20;
BEGIN
  LOCAL_STRING[1]:= CHR(13); (* Carriage return *)
  LOCAL_STRING[2]:= CHR(10); (* Line feed *)
  LOCAL_STRING[3]:= '$'; (* String terminator *)
  WRITE_STRING_TO_OUT_BUFFER(LOCAL_STRING)
END;

PROCEDURE WRITE_INTEGER_TO_OUT_BUFFER(VALUE : INTEGER);
```

```
VAR   LOCAL_STRING : STRING20;
BEGIN
  (* You need to work out some way here to write the character
  string conversion of a binary integer VALUE to the variable
  LOCAL_STRING. Most Pascal compilers allow some way of doing
  "redirected I-O" so you don't have to write the integer conversion
  routines yourself.
  In this routine, the integer character string, followed by a space,
  and a "$" should be written to LOCAL_STRING. Then: *)
  WRITE_STRING_TO_OUT_BUFFER(LOCAL_STRING)
END;

(* The following procedure sets everything up and is only called once *)

PROCEDURE INITIALIZE_PROGRAM;
BEGIN
  INIT_BUFFER(A_D_HEADER,A_D_BUF_LENGTH);
  INIT_BUFFER(KEY_HEADER,KEY_BUF_LENGTH);
  INIT_BUFFER(OUT_HEADER,OUT_BUF_LENGTH);
  (* Initialize variables *)
  A_D_SEGMENT:= 1;
  ANALYZE_SEGMENT:= 1;
  INIT_LIST_FILE;
  DONE:= FALSE;
  ERROR:= FALSE;
  LAST_VALUE_WAS_OVER_THRESHOLD:= FALSE;
  THRESHOLD:= 2000;
  PULSE_SUM:= 0.0;
  PULSE_COUNT:= 0;
  WRITE('Hit RETURN when ready to start'); (* File var OUTPUT is assumed
  to be the console screen *)
  READLN; (* File var INPUT is assumed to be the keyboard *)
  START_CLOCK
END;

(* The following procedure is the first coroutine. It monitors the clock,
reads the A-D when necessary, and puts the value in the A_D buffer.
This procedure performs the highest priority task and is called as often
as possible. The coroutine function is implemented using the CASE
statement and the variable A_D_SEGMENT to control the flow. *)

PROCEDURE CHECK_A_TO_D;
VAR   VALUE : INTEGER;
BEGIN
  CASE A_D_SEGMENT OF
    1 : IF CLOCK_FLAG_SET THEN BEGIN
        START_A_TO_D; (* but we don't need to wait for conversion *)
        A_D_SEGMENT:= 2 (* set up for next section of coroutine *)
      END;
    2 : BEGIN
        VALUE:= READ_A_TO_D; (* plenty of time for conversion by now *)
        ERROR:= ERROR OR A_D_HEADER.BUFFER_FULL;
        STORE(A_D_HEADER.A_D_BUFFER,VALUE);
        A_D_SEGMENT:= 1 (* set up for 1st section of coroutine again *)
      END
  END (* of CASE statement *)
END;

(* The following procedures are subroutines to check and read the keyboard
and to output results. Both routines just check peripheral status flags
and do the data transfer as necessary. This is a simple, one-step task
so they are implemented as subroutines rather than coroutines. *)
```



Listing 1 continued:

```

PROCEDURE READ_KEYBOARD;
VAR   C : CHAR;
BEGIN
  IF KEY_HIT THEN BEGIN
    READ(C);
    ERROR:= ERROR OR KEY_HEADER.BUFFER_FULL;
    STORE(KEY_HEADER,KEY_BUFFER,ORD(C))
  END
END;

PROCEDURE OUTPUT_RESULTS;
BEGIN
  IF NOT OUT_HEADER.BUFFER_EMPTY AND LST_DEVICE_READY THEN
    WRITE(LIST_FILE,CHR(RETRIEVE(OUT_HEADER,OUT_BUFFER)))
END;

(* The following procedure is the coroutine that does all of the data
analysis. The coroutine structure is implemented with the case statement.
Note now the data analysis function has been broken up so that this
procedure does not hog the CPU while doing complex data analysis. The
coroutine relinquishes control whenever its buffers are empty and at
short intervals during data analysis; the whole idea is to make sure
the clock gets serviced at frequent intervals so that analog data is
sampled at close to the proper time. Note also that the amount of data
analysis necessary is highly dependent on the input data; e.g., a whole
bunch of stuff needs to be done when the analog value falls below the
threshold value. *)

PROCEDURE ANALYZE_DATA;
VAR   C : CHAR;
      END_PULSE,
      SUPRA_THRESHOLD : BOOLEAN;
      A_D_VALUE : INTEGER;
BEGIN
  CASE ANALYZE_SEGMENT OF
    (* Case 1 checks our input buffers to see if we have any data to
deal with. Some minimal analysis is done in case 1 if we have data. *)
    1 : IF NOT KEY_HEADER.BUFFER_EMPTY THEN BEGIN
        C:=CHR(RETRIEVE(KEY_HEADER,KEY_BUFFER));
        DONE:= NOT (C IN ('0'..'9'));
        IF NOT DONE THEN
          THRESHOLD:= (ORD(C)-ORD('0')+1)*400;
          ANALYZE_SEGMENT:= 5 (* We relinquish control here because
we've already spent a long time figuring out the new threshold.
The coroutine transfers to case 5 where the new threshold is
printed out (via the output buffer, of course). *)
        END
      ELSE (* If no data in keyboard buffer, we check A-D buffer. *)
        IF NOT A_D_HEADER.BUFFER_EMPTY THEN BEGIN
          A_D_VALUE:= RETRIEVE(A_D_HEADER,A_D_BUFFER);
          SUPRA_THRESHOLD:= A_D_VALUE >= THRESHOLD;
          END_PULSE:= LAST_VALUE WAS OVER THRESHOLD
                    AND NOT SUPRA_THRESHOLD;
          LAST_VALUE WAS OVER THRESHOLD:= SUPRA_THRESHOLD;
          IF END_PULSE THEN ANALYZE_SEGMENT:= 2
        ELSE IF SUPRA_THRESHOLD THEN BEGIN
          PULSE_COUNT:= PULSE_COUNT+1;
          PULSE_SUM:= PULSE_SUM + A_D_VALUE
        END
      END;
END;

```

```

(* Cases 2 through 4 are the segments of the coroutine that analyze
the data at the end of a pulse and output results. Case 2 does
a time consuming floating point division and then relinquishes
control; analysis is taken up again at case 3 which outputs the
pulse length; integer to string conversion is time consuming so
case 3 relinquishes control and analysis continues later at case 4
where the average pulse height (computed in case 2) is output.
Control then returns to case one to catch up on any keyboard activity
and accumulated analog values. *)
2 : BEGIN
  AVERAGE_PULSE_HEIGHT:= PULSE_SUM/PULSE_COUNT;
  ANALYZE_SEGMENT:= 3
  END;
3 : BEGIN
  WRITE_INTEGER_TO_OUT_BUFFER(PULSE_COUNT);
  ANALYZE_SEGMENT:= 4
  END;
4 : BEGIN
  WRITE_INTEGER_TO_OUT_BUFFER(ROUND(AVERAGE_PULSE_HEIGHT));
  WRITE_CRLF_TO_OUT_BUFFER;
  PULSE_COUNT:= 0;
  PULSE_SUM:= 0.0;
  ANALYZE_SEGMENT:= 1
  END;
(* Case 5 is a continuation of the analysis that occurs when a new
threshold is specified from the keyboard. It outputs the new
threshold value (already computed in case 1). *)
5 : BEGIN
  WRITE_STRING_TO_OUT_BUFFER('New Threshold= $ ');
  (* Note that the string had to be filled out to 20 chars
to satisfy Pascal's type checking *)
  WRITE_INTEGER_TO_OUT_BUFFER(THRESHOLD);
  WRITE_CRLF_TO_OUT_BUFFER;
  ANALYZE_SEGMENT:= }
  END
END (* of case statement *)
END;

```

(\* The following is the main program of MEASURE\_ANALOG\_PULSE. It should properly be thought of as a coroutine whose function is to pass control around to the other coroutines and subroutines on a priority weighted basis. Note that the high priority routine, CHECK\_A\_TO\_D, is given control as often as possible. \*)

```

BEGIN
  INITIALIZE_PROGRAM;
  REPEAT
    CHECK_A_TO_D;
    ANALYZE_DATA;
    CHECK_A_TO_D;
    OUTPUT_RESULTS;
    CHECK_A_TO_D;
    READ_KEYBOARD
  UNTIL DONE OR ERROR;
  IF ERROR THEN WRITELN('buffer overflow abort.')
```

END.

(\* The reader may have noticed that there are alternate ways to accomplish the job of MEASURE\_ANALOG\_PULSE without the unusual CASE statement constructs. For example, the procedure ANALYZE\_DATA could have been written in a straightforward manner and then sprinkled with calls to a procedure CHECK\_PERIPHERALS to make sure that peripherals

Listing 1 continued:

were serviced in a timely fashion (see Listing 2 where this is done automatically by hardware interrupts).

I used the approach shown here because it more clearly illustrates the concept of a coroutine and because a cleaner program structure can be developed if interlaced procedure calls are avoided. This program could be easily modified to do different or more extensive data analysis. \*)

Listing 2: Able to handle the data-collection task outlined in listing 1, this program is based on interrupt-driven-I/O techniques.

PROGRAM MEASURE\_ANALOG\_PULSE\_USING\_INTERRUPTS;

(\* This listing illustrates a solution to the same real-time problem treated in Listing 1, but here we use interrupt driven I-O rather than programmed I-O. Three types of interrupt situations are illustrated: 1) A case where random inputs must be captured (the keyboard input in the present example). 2) A case where a peripheral is allowed to interrupt when there is work for it to do, but not allowed to interrupt otherwise (outputting results to a listing device here). 3) A case where an interrupt from one device (the clock in our example) sets up another device (the A-D converter) to interrupt later.

The program is written in Pascal for general readability and because it should be every programmer's goal to do as much programming as possible in high level languages. However, interrupts are intimately associated with the hardware in a system, so there are restrictions on the types of high level languages that can be used in an interrupt driven environment. First, you must have some way of including assembly language instructions and/or procedures in your program. Second, the language should be of the direct compiling type since interpreters (e.g., p-code interpreters) are normally not written using reentrant code (in this case, interrupt service routines have to be written entirely in machine code so they won't trash the interpreter temporary storage locations). Third, if you are using a multi-user operating system or any other operating system designed to run with the interrupt on (e.g., RT-11 for the LSI-11 CPU's) then you must respect and understand the operating system's interrupt environment.

In this example, I have assumed that a direct compiling Pascal (such as Pascal/Z or Pascal/MT+) is being used with an operating system that does not support interrupt driven I-O (e.g., standard CP/M). I have further assumed that there is a priority interrupt scheme such that the clock interrupts have the highest priority. \*)

(\* Three FIFO buffers are used: one for the A-D values, one for keyboard input, and one for lister output. The first part of the definitions is related to implementing these buffers. Buffers are implemented exactly as in Listing 1. \*)

```
CONST
  A_D_BUF_LENGTH = 100;
  KEY_BUF_LENGTH = 20;
  OUT_BUF_LENGTH = 200;
  LONGEST_BUFFER = 200;

TYPE
  BUFFER_HEADER = RECORD
    INPUT_POINTER,
    OUTPUT_POINTER,
    BUFFER_LENGTH : INTEGER;
    BUFFER_FULL,
    BUFFER_EMPTY : BOOLEAN
  END;
```

(\* The Buffer Header keeps the current status of a FIFO buffer. The input pointer points to the next location to be filled, and the output pointer is the next location to be read from the buffer. \*)

```
FIFO_BUFFER = ARRAY[1..LONGEST_BUFFER] OF INTEGER;
STRING20 = ARRAY[1..20] OF CHAR;
```

VAR

```
A_D_HEADER,
KEY_HEADER,
OUT_HEADER : BUFFER_HEADER;
A_D_BUFFER,
KEY_BUFFER,
OUT_BUFFER : FIFO_BUFFER;
```

(\* End of buffer definitions & start of Globals needed by other procedures. \*)

```
LIST_FILE : TEXT; (* File var for the listing device *)
```

```
LISTER_INTERRUPT_OFF, (* Boolean used control list device interrupts *)
```

```
ERROR, DONE : BOOLEAN; (* Booleans to control program termination *)
```

(\* The following variables are used in the data analysis \*)

```
THRESHOLD, PULSE_COUNT : INTEGER;
```

```
PULSE_SUM, AVERAGE_PULSE_HEIGHT : REAL;
```

```
LAST_VALUE_WAS_OVER_THRESHOLD : BOOLEAN;
```

(\* The following three procedures implement the FIFO buffers \*)

```
PROCEDURE INIT_BUFFER(VAR B_HEADER : BUFFER_HEADER; B_LENGTH : INTEGER);
```

BEGIN

```
  WITH B_HEADER DO BEGIN
```

```
    INPUT_POINTER:=1; (* Next location to be filled *)
```

```
    OUTPUT_POINTER:=1; (* Next location to be read *)
```

```
    BUFFER_LENGTH:= B_LENGTH;
```

```
    BUFFER_FULL:= FALSE;
```

```
    BUFFER_EMPTY:= TRUE
```

```
  END
```

END;

```
PROCEDURE STORE(VAR B_HEADER : BUFFER_HEADER;
```

```
  VAR BUFFER : FIFO_BUFFER;
```

```
  VALUE : INTEGER);
```

BEGIN

```
  WITH B_HEADER DO IF NOT BUFFER_FULL THEN BEGIN
```

```
    BUFFER[INPUT_POINTER]:= VALUE;
```

```
    IF INPUT_POINTER = BUFFER_LENGTH
```

```
      THEN INPUT_POINTER:= 1
```

```
      ELSE INPUT_POINTER:= INPUT_POINTER+1;
```

```
    BUFFER_FULL:= INPUT_POINTER = OUTPUT_POINTER;
```

```
    BUFFER_EMPTY:= FALSE
```

```
  END
```

END;

```
FUNCTION RETRIEVE(VAR B_HEADER : BUFFER_HEADER;
```

```
  VAR BUFFER : FIFO_BUFFER) : INTEGER;
```

BEGIN

```
  WITH B_HEADER DO IF NOT BUFFER_EMPTY THEN BEGIN
```

```
    RETRIEVE:= BUFFER[OUTPUT_POINTER];
```

```
    IF OUTPUT_POINTER = BUFFER_LENGTH
```

```
      THEN OUTPUT_POINTER:= 1
```

```
      ELSE OUTPUT_POINTER:= OUTPUT_POINTER+1;
```

```
    BUFFER_EMPTY:= OUTPUT_POINTER = INPUT_POINTER;
```

```
    BUFFER_FULL:= FALSE
```

```
  END
```

END;



## Listing 2 continued:

(\* All procedures from here to WRITE\_CHAR\_TO\_OUT\_BUFFER are hardware and/or implementation dependent. Most are shown as stubs with descriptions of what they have to do, but necessary code is also shown. \*)

PROCEDURE INIT\_LIST\_FILE;

BEGIN

(\* This procedure should initialize the file variable, LIST\_FILE, to the listing device; e.g. ASSIGN(LIST\_FILE,'LST:'); etc... \*)

END;

(\* The procedures shown from here to RESET\_ALL\_PERIPHERALS are device dependent. These procedures set up the peripherals to generate interrupts to the proper service routine. The setup routines usually must: 1) give the peripheral device its interrupt vector location, 2) place the address of the service routine in memory at the proper vector location, and 3) send command code(s) to the peripheral to set it in the proper operating mode. For those devices where the interrupt must be turned on and off by the program, setup still takes place as above except the command that enables the peripheral interrupt is placed in a separate procedure. Example, the Z80 PIO (parallel I-O) chip interrupt can be enabled by the command byte 83 hex and disabled by 03 hex without interfering with its already programmed operating mode. \*)

PROCEDURE SET\_CPU\_INTERRUPT\_MODE;

BEGIN

(\* Some CPU's (the Z80, for example) have different interrupt modes or have to be initialized in some special way to deal with interrupts. For an 8080 CPU nothing needs to be done here since that processor has only one interrupt mode. \*)

END;

PROCEDURE START\_CLOCK;

BEGIN

(\* Set up the clock to generate an interrupt to the procedure SERVICE\_CLOCK whenever the A-D needs to be read, and start the clock \*)

END;

PROCEDURE SET\_UP\_A\_TO\_D;

BEGIN

(\* Set up the A-D so that it generates an interrupt to the procedure SERVICE\_A\_TO\_D at end of conversion. No conversion is started here, however. \*)

END;

PROCEDURE START\_A\_TO\_D;

BEGIN

(\* Initiate an analog to digital conversion. \*)

END;

FUNCTION READ\_A\_TO\_D : INTEGER;

BEGIN

(\* Reads the A-D and returns a value from 0 to 4095 \*)

END;

PROCEDURE SET\_UP\_KEYBOARD;

BEGIN

(\* Set up the keyboard interface so that it generates an interrupt to the procedure SERVICE\_KEYBOARD whenever a character is received from the keyboard. \*)

END;

PROCEDURE SET\_UP\_LISTER;

BEGIN

(\* Set up the list device interface so that it is capable of generating an interrupt to the procedure SERVICE\_LISTER when the listing device is ready for another character, but do not actually enable lister interrupts here since we won't have anything to print until later when some results are generated. The global Boolean variable LISTER\_INTERRUPT\_OFF lets the output routine know when the interrupt needs to be turned on. Thus, \*)

LISTER\_INTERRUPT\_OFF:= TRUE

END;

PROCEDURE PRINT\_CHAR\_AND\_ENABLE\_LISTER\_INTERRUPT( C : CHAR);

BEGIN

(\* This procedure is called when the list device interrupt is not enabled and we want to start listing results. Here we print a character to get things going (the list device will always be ready to print when this procedure is called), and then enable the lister interface so that it interrupts to SERVICE\_LISTER when it's ready for another character. \*)

WRITE(LIST\_FILE,C);

(\* Enable lister interrupts here \*)

LISTER\_INTERRUPT\_OFF:= FALSE

END;

PROCEDURE TURN\_OFF\_LISTER\_INTERRUPTS;

BEGIN

(\* This procedure is called by the lister interrupt service routine when it gets an interrupt but has nothing left to print in its buffer. The procedure just disables list device interrupts, and: \*)

LISTER\_INTERRUPT\_OFF:= TRUE

END;

PROCEDURE RESET\_ALL\_PERIPHERALS;

BEGIN

(\* This procedure is called just before the end of the program. It should set up all peripherals so that they are as the normal operating system expects to find them (e.g., keyboard interrupts should be disabled for most operating systems). \*)

END;

(\* The following procedures are utility routines that are needed to deal with interrupts. They will generally have to be written in assembly language; most Pascal compilers allow you to insert in-line assembly code into programs and most allow you to externally compile assembly language procedures. \*)

PROCEDURE ENABLE\_INTERRUPTS;

BEGIN

(\* Enable CPU interrupt \*acknowledge. Always a single assembly language instruction (e.g., EI in 8080 and Z80 assembly language). \*)

END;

PROCEDURE DISABLE\_INTERRUPTS;

BEGIN

(\* Disable CPU interrupt acknowledge ( DI in 8080 and Z80 code). \*)

END;

PROCEDURE SAVE\_REGISTERS;

BEGIN

(\* This is a crucial procedure. Its function is to save CPU registers and any temporary locations used by both the main routines and by

interrupt service routines. This procedure should also do whatever your CPU and peripherals need to let them know that the interrupt is being serviced. If more than one device can interrupt at a time (i.e., if a priority interrupt scheme is used, as assumed in this example) then the registers need to be saved on a stack rather than in local variables. As an example, the following would work for Z80 CPU's:

```

EX      (SP),HL ;Get our return address & push (i.e., save) HL.
PUSH   AF      ;Save A reg & flags
PUSH   BC      ;Save BC
PUSH   DE      ;& DE.
PUSH   HL      ;Now push our return address back on the stack, &
RET     ;let peripherals know interrupt is being serviced.

```

Note that the above takes 10 bytes of stack space, plus whatever stack space the service routine uses, plus whatever stack space any routine that interrupts this one uses. In other words, you must ALWAYS have lots of extra stack available (Pascal is good about this, but operating systems sometimes switch to a small local stack when performing services for you); or you can switch to a local stack pointer here.

Most CPU's turn the interrupt off when servicing an interrupt; we'll turn it on later before returning from the interrupt service routines. \*)

END;

PROCEDURE RESTORE\_REGISTERS;

BEGIN

(\* This procedure is called just before returning from an interrupt service routine to put the machine back into its original state:

I.e.,

```

POP     HL      ;First get this routine's return address off stack.
POP     DE      ;Next, we get reg's off stack in reverse order
POP     BC
POP     AF
EX      (SP),HL ;Finally, get old HL & push current return address.
RET     ;We already did the RETI in SAVE_REGISTERS. *)

```

END;

(\* The following procedures are the interrupt service routines; they are presented in order from the simplest to the trickiest.

There are a few general rules for interrupt service routines that will avoid most common pitfalls. First, you never know where the main program is going to be interrupted, so save all registers and avoid calling non-reentrant routines that are also used elsewhere (e.g., multiple run-time routines are typically not written in reentrant code even if the Pascal procedures themselves are reentrant; avoid doing anything in the service routine that does not generate in-line code). Second, where the same procedures must be called from both the main program and interrupt routines (as in the calls to the buffer handling routines in this program) make sure to turn off the interrupt in the main program around sections of code where the same variables might be accessed by a service routine; don't be afraid to bracket short sections of code with disable-enable interrupt instructions - better safe than sorry. Third, in a priority interrupt scheme, remember that a service routine might be interrupted by a higher priority device. Lastly, for devices capable of interrupting frequently, make sure that the device does not interrupt its own service routine; the service routine itself may be reentrant (the ones shown here are) but the FIFO buffers are not! - A device interrupting its own service routine will either corrupt the buffer pointers or will put data into the buffer in the wrong order. \*)

PROCEDURE SERVICE\_KEYBOARD;

VAR C : CHAR;

BEGIN

SAVE\_REGISTERS;

```

READ(C); (* Leave interrupts off until we finish the read since
the operating system routines might be short on free stack. *)
ENABLE_INTERRUPTS; (* We can allow higher priority devices to
interrupt this service routine now if they need to. *)
ERROR:= ERROR OR KEY HEADER.BUFFER_FULL;
STORE(KEY_HEADER,KEY_BUFFER,ORD(C)); (* No need to turn interrupts off
around this call since any routine that interrupts this one and wants to
use the buffer handling routines will be using a different buffer header.
The FIFO buffer routines are reentrant with respect to separate buffers. *)
RESTORE_REGISTERS

```

END;

PROCEDURE SERVICE\_LISTER;

VAR C : CHAR;

BEGIN

(\* This procedure is called on a list device ready interrupt. If the output buffer is empty then the lister interrupts are turned off, otherwise the next character is printed. \*)

SAVE\_REGISTERS;

ENABLE\_INTERRUPTS; (\* Clock can interrupt now if it wants \*)

IF OUT HEADER.BUFFER\_EMPTY

THEN TURN\_OFF\_LISTER\_INTERRUPTS

ELSE BEGIN

C:= CHR(RETRIEVE(OUT\_HEADER,OUT\_BUFFER));

DISABLE\_INTERRUPTS; (\* No interrupts while using operating system services due to possible shortage of stack space. \*)

WRITE(LIST\_FILE,C);

ENABLE\_INTERRUPTS

END;

RESTORE\_REGISTERS

END;

PROCEDURE SERVICE\_CLOCK;

BEGIN

(\* This is the highest priority device; it will interrupt the main program or any other service routine whenever it needs to, if CPU interrupts are enabled. All it does is start the A-D conversion; reading the A-D is done by the A-D interrupt service routine when conversion is complete. \*)

SAVE\_REGISTERS;

START A TO D;

ENABLE\_INTERRUPTS;

RESTORE\_REGISTERS

END;

PROCEDURE SERVICE\_A\_TO\_D;

VAR A\_D\_VALUE : INTEGER;

BEGIN

SAVE\_REGISTERS;

A\_D\_VALUE:= READ A TO D;

(\* If multiple A-D channels were being sampled, a new conversion could be started here to read the next channel. \*)

ENABLE\_INTERRUPTS;

ERROR:= ERROR OR A\_D HEADER.BUFFER\_FULL;

STORE(A\_D HEADER,A\_D\_BUFFER,A\_D\_VALUE);

RESTORE\_REGISTERS

END;

(\* The following three procedures set up the output buffer for the listing device; they are implementation, but not hardware, dependent. \*)



## Listing 2 continued:

```

PROCEDURE WRITE_STRING_TO_OUT_BUFFER(VAR STRING : STRING20);
(* This procedure puts the characters into the output buffer until
it encounters a "$". *)
VAR   I : INTEGER;
      C : CHAR;
BEGIN
  I:=1;
  REPEAT
    C:= STRING[I];
    I:= I+1;
    IF C <> '$' THEN BEGIN
      ERROR:= ERROR OR OUT_HEADER.BUFFER_FULL;
      DISABLE INTERRUPTS; (* We cannot let the printer interrupt
while the output buffer pointers are being updated. *)
      STORE(OUT_HEADER.OUT_BUFFER,ORD(C));
      ENABLE INTERRUPTS
    END
  UNTIL (I=21) OR (C='$') OR ERROR;
(* Now we need to start printing if we actually put something in the
output buffer and the lister isn't already going. *)
IF NOT OUT_HEADER.BUFFER_EMPTY AND LISTER_INTERRUPT_OFF
  THEN PRINT_CHAR_AND_ENABLE_LISTER_INTERRUPT
    (CHR(RETRIEVE(OUT_HEADER,OUT_BUFFER)))
END;

PROCEDURE WRITE_CRLF_TO_OUT_BUFFER;
VAR   LOCAL_STRING : STRING20;
BEGIN
  LOCAL_STRING[1]:= CHR(13); (* Carriage return *)
  LOCAL_STRING[2]:= CHR(10); (* Line feed *)
  LOCAL_STRING[3]:= '$'; (* String terminator *)
  WRITE_STRING_TO_OUTPUT_BUFFER(LOCAL_STRING)
END;

PROCEDURE WRITE_INTEGER_TO_OUT_BUFFER(VALUE : INTEGER);
VAR   LOCAL_STRING : STRING20;
BEGIN
  (* In this routine, the integer character string, followed by a space,
and a "$" should be written to LOCAL_STRING. Then: *)
  WRITE_STRING_TO_OUT_BUFFER(LOCAL_STRING)
END;

(* The following procedure sets everything up and is only called once *)

PROCEDURE INITIALIZE_PROGRAM;
BEGIN
  INIT_BUFFER(A_D_HEADER,A_D_BUF_LENGTH);
  INIT_BUFFER(KEY_HEADER,KEY_BUF_LENGTH);
  INIT_BUFFER(OUT_HEADER,OUT_BUF_LENGTH);
(* Initialize variables *)
  INIT_LIST_FILE;
  DONE:= FALSE;
  ERROR:= FALSE;
  LAST_VALUE_WAS_OVER_THRESHOLD:= FALSE;
  THRESHOLD:= 2000;
  PULSE_SUM:= 0.0;
  PULSE_COUNT:= 0;
  WRITE('Hit RETURN when ready to start'); (* File var OUTPUT is assumed
to be the console screen *)
  READLN; (* File var INPUT is assumed to be the keyboard *)
  START_CLOCK;

```

```

  SET_UP_A_TO_D;
  SET_UP_KEYBOARD;
  SET_UP_LISTER;
  SET_CPU_INTERRUPT_MODE;
  ENABLE_INTERRUPTS
END;

PROCEDURE ANALYZE_DATA;
VAR   C : CHAR;
      END_PULSE,
      SUPRA_THRESHOLD : BOOLEAN;
      A_D_VALUE : INTEGER;

PROCEDURE DO_END_PULSE_DATA_ANALYSIS;
BEGIN
  AVERAGE_PULSE_HEIGHT:= PULSE_SUM/PULSE_COUNT;
  WRITE_INTEGER_TO_OUT_BUFFER(PULSE_COUNT);
  WRITE_INTEGER_TO_OUT_BUFFER(ROUND(AVERAGE_PULSE_HEIGHT));
  WRITE_CRLF_TO_OUT_BUFFER;
  PULSE_COUNT:= 0;
  PULSE_SUM:= 0.0
END;

BEGIN
  IF NOT KEY_HEADER.BUFFER_EMPTY THEN BEGIN
    C:=CHR(RETRIEVE(KEY_HEADER,KEY_BUFFER));
    DONE:= NOT (C IN ['0'..'9']);
    IF NOT DONE THEN BEGIN
      THRESHOLD:= (ORD(C)-ORD('0')+1)*400;
      WRITE_STRING_TO_OUT_BUFFER('New Threshold= $ ');
      WRITE_INTEGER_TO_OUT_BUFFER(THRESHOLD);
      WRITE_CRLF_TO_OUT_BUFFER
    END
  END;
  IF NOT A_D_HEADER.BUFFER_EMPTY THEN BEGIN
    DISABLE INTERRUPTS; (* We cannot have the A-D interrupting
and trying to update the pointers in the A-D buffer while
we are trying to do the same thing here. *)
    A_D_VALUE:= RETRIEVE(A_D_HEADER,A_D_BUFFER);
    ENABLE INTERRUPTS;
    SUPRA_THRESHOLD:= A_D_VALUE >= THRESHOLD;
    END_PULSE:= LAST_VALUE_WAS_OVER_THRESHOLD AND NOT SUPRA_THRESHOLD;
    LAST_VALUE_WAS_OVER_THRESHOLD:= SUPRA_THRESHOLD;
    IF END_PULSE THEN DO_END_PULSE_DATA_ANALYSIS
  ELSE IF SUPRA_THRESHOLD THEN BEGIN
    PULSE_COUNT:= PULSE_COUNT+1;
    PULSE_SUM:= PULSE_SUM + A_D_VALUE
  END
END;

BEGIN
  INITIALIZE_PROGRAM;
  REPEAT
    ANALYZE_DATA
  UNTIL DONE OR ERROR;
  WHILE NOT LISTER_INTERRUPT_OFF DO ; (* Loop til all printing is done. *)
  DISABLE INTERRUPTS;
  RESET_ALL_PERIPHERALS; (* So the operating system finds them as it expects *)
  IF ERROR THEN WRITELN('Buffer overflow abort.')
```

# FREE CP/M PLUS

SAVE \$350 WITH SPECIAL TARBELL PACKAGE

Buy Tarbell's Z-80A S-100 CPU/IO board and Double Density Floppy Disk interface, and get free new Digital Research CP/M Plus.

CP/M Plus features:  high performance file system  CP/M 2.2 compatible  time and date stamps on files  automatic disk login of removable media  support for 1-to-16 banks of RAM and 1-to-16 drives up to 512 megabytes each  easy to use system utilities with HELP facility  banked or non-banked memory and  high speed loading.

Total price is \$945. Ask nearest Tarbell dealer for demo.

**CURRENT EMPIRE OWNERS:** Special low prices for upgrading your unit to CP/M Plus. Call for details.

*Tarbell*  
Electronics

950 Dohlen Place  
Suite B  
Carson, CA 90746  
(213) 538-4251

# CHANGE YOUR LETTER WRITING DRUDGERY INTO PUSHBUTTON LUXURY.

If you're still writing all your business letters yourself, you're spending a lot of time, energy and money on needless drudgery.

You need LetterBANK™.

The inexpensive word processing applications package designed to free you from all that - while making your essential day-to-day correspondence appear more businesslike and professional than ever.

LetterBANK is no ordinary form letter package. It's a sophisticated piece of applications software with over 200 professionally written letters you can use as is, expand, modify or even rewrite to exactly fit your needs.

There are letters for hiring and firing, sales promos, product introductions, collection of overdue accounts, information requests, internal memos, news releases - you name it and there's a LetterBANK letter to cover it.

Best of all, LetterBANK is a luxury you can afford. Because the entire package costs just \$99.

Ask for it wherever you buy business computer software. Or order direct by calling 1-800-972-5600 (in NH 431-4800). C.O.D., VISA, and MasterCard accepted.

## LetterBANK

If you're not using LetterBANK, you're not really using your word processor.

A product of The Wyndham Group, Ltd.  
Business Applications Software / 135 Mirona Road / Portsmouth, NH 03801 / (603) 431-4800

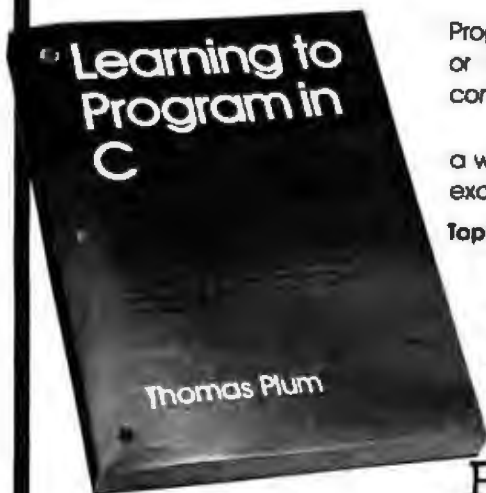
## From Plum Hall, an introductory Book on C.

It has been several years in the making and now it is here. Learning to Program in C, by Thomas Plum, teaches C language from the ground up. With or without previous programming experience, anyone acquainted with computers will find a clear description of how C works.

You will find guidelines for writing portable programs that will run on a wide variety of modern computers - micro, mini, and mainframe, with excellent efficiency in all these environments.

Topic areas include:

- Environmental details - starting C
- Data and variables - using the memory
- Operators and expressions - intuitive reasons for C precedence.
- Control structure - readability rules
- Functions - print and scan made easy
- Case study - full Blackjack source, from design to documentation
- Pointer, struct clarified



- explains C step-by-step
- practical "how to" approach
- describes what happens inside the computer

372 pp. 7½"x10", Price \$25.

### PLUM HALL

1 Spruce Ave, Cardiff, NJ 08232  
Phone orders: 609-927-3770

- Send information on Plum Hall Seminars on C and UNIX™
- Check  
 Mastercard  Visa  
 American Express

Please send me \_\_\_\_\_ copies of "Learning to Program in C" at \$25. each. (N.J. resident add 6%) enclosed find \$\_\_\_\_\_

NAME \_\_\_\_\_

COMPANY \_\_\_\_\_

ADDRESS \_\_\_\_\_

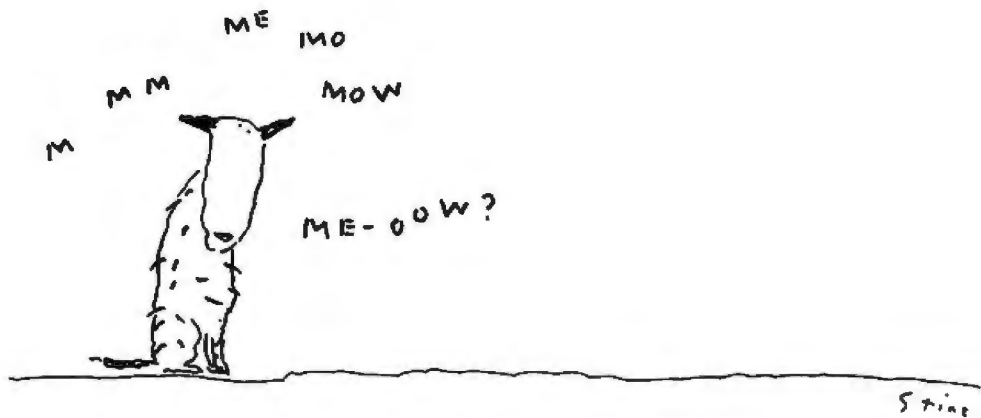
CITY \_\_\_\_\_ STATE \_\_\_\_\_ ZIP \_\_\_\_\_

Expiration Date \_\_\_\_\_ Card No. \_\_\_\_\_

Signature \_\_\_\_\_



Dogged attempt to learn a second language.



IBM, Apple and CP/M are registered trademarks of IBM Corp., Apple Computer Inc. and Digital Research Corp. respectively.

For the name of the dealer nearest you, phone (800) 227-2400, ext. 948; in California, (800) 772-2666, ext. 948. For more information

# And now, InfoStar.™

## The first DBMS you can use without speaking programmerese.

So put away your GO TOs and DO WHILEs.

InfoStar is one microcomputer data base system that doesn't ask you to write in code. Or learn a programming language. Instead you make selections from an on-screen menu written in one easy language. English.

Which means you don't have to be a programmer or computer jock to use it. But, in case you are, there's something in it for you, too.

With InfoStar, you can generate a custom application four times faster than with other DBMS software.

Reason being it has a lot of the features that made WordStar® the standard of the industry. For instance, select-as-you-go menus prompt you through all procedures. And to format a data entry form or report, you simply draw it on the screen.

We've said it before: what you see is what you get.

But, of course, that's not all you get. Fact is, InfoStar has more informative (and self-documenting)

capabilities than you've come to expect from any microcomputer DBMS.

Starting with report writing. A custom report feature—complete with transactional updating and exception processing abilities—lets you format, manipulate and merge countless different ways. And a quick report feature lets you finish faster than you can count them—usually in 60 seconds or less.

Not that you have to slow down to sort things out either. Because InfoStar can sort five to six times faster than any other DBMS in its class.

And for data entry, there are high-end minicomputer features. Like batch editing. And 200 editing mask combinations, to name a few.

All that's required of you is that you have an IBM PC, Apple II or CP/M® based computer. And that you take a trip over to your local computer store to ask about InfoStar.

They don't speak programmerese.

But they're happy to talk business.



**MicroPro**®

The Microcomputer Software Company



# Regression Fitting to Economic Indexes

*An Apple II program can help determine base rates of inflation through analysis of the Consumer Price Index.*

---

Dr. John R. Merrill  
Hendrix College  
Conway, AR 72032

---

An interesting application of regression analysis fits an exponential curve to indexes such as the Consumer Price Index (CPI). Such fits provide historical information on prices and can also be used to extrapolate from recent behavior to future performance. Working with such regression analyses demonstrates determining the base rate of inflation despite variations on top of the base rate. The method and the program also suit analysis of many other interesting national indexes.

## The Program

Although written for an Apple II computer with 48K bytes of RAM (random-access read/write memory), the program (see listing 1) can run with less RAM if you limit the amount of historical data stored or if you choose not to plot the results. This latter option releases the high-resolution memory space.

In the program, the matrix designated CPI(26,12) stores 26 years'

worth (1955 through 1980) of monthly CPI data (lines 570 through 820), here taken from the *Business Conditions Digest*, published by the Bureau of Economic Analysis, U.S. Department of Commerce. The vector Y(26) stores the years of the data.

Lines 40 through 60 read in the values of the CPI and the corresponding years. Line 70 allows you to choose just to fit the data or to fit and plot it. Lines 90 and 100 allow selection of the starting and ending months and years, thereby permitting a subset of data values to be used in calculations.

Lines 170 through 320 form the subroutine that fits the best compound-interest curve to the chosen data. The routine's analysis is based on a linear-regression fit to the natural logarithms of the CPI data. In a sense, the analysis fits the best exponential curve to the raw CPI data for the years and months chosen, using logarithmic weighting factors.

Program variable XS sums the time, measured in years; YS sums the natural logarithms of the corresponding CPI values. Variable XY sums the products of times and logarithms; X2 sums the squares of the times. Lines 280 and 290 use these variables to calculate the best values of the slope M and the intercept B of the straight line representing the logarithm of the

CPI as a function of time. The variable R is the best value, according to the least-squares criterion, of the compound rate of increase.

Lines 330 through 520 form a subroutine that plots the chosen data in high-resolution graphics. Note that line 340 finds the best-fit curve using the subroutine beginning at line 170. C0 and C9 are the bottom and top values for the graph. In lines 450 and 460, the variables X9 and Y9 are the points to be plotted. Again notice that the graph is a plot of the natural logarithms of the CPI against time. Lines 490 through 510 plot the best-fit line calculated by the line 170 subroutine.

## The Regression Fit

Using a least-squares criterion, the program fits the logarithms of the CPI to a straight line. This fit is equivalent to fitting, by a regression analysis, the raw CPI data to an exponential curve,  $y = Ce^{Mt}$ , where C and M are the best-fit constants and t is the time.

This fit is equivalent to fitting the data to a compound-interest curve,  $y = C(1 + R)^t$ , where C is the same constant (notice the values at  $t = 0$ ) and R is the compound-interest rate. If  $Ce^{Mt} = C(1 + R)^t$ , then  $\log(C) + Mt = \log(C) + t \log(1 + R)$ , where log stands for the natural

---

## About the Author

John Merrill has used computers in his teaching at Dartmouth, Florida State, and Hendrix. He has published a book, *Using Computers in Physics, and several monographs and journal articles. His present interests are uses of DEC VAX-11 systems and microcomputer systems.*

---

logarithm, matching the BASIC notation. Thus,  $M = \log(1 + R)$ , so that  $R = e^M - 1$ , which is the equation used in program line 300. In program line 290, the variable B is the best value of  $\log(C)$ .

The details of linear-regression analysis, including information on how to calculate the best values of M and B, are discussed in many statistical-analysis books. One such source is Hugh D. Young's *Statistical Treatment of Experimental Data* (McGraw-Hill, 1962), pages 145 and 146.

### Program Results

Figures 1 and 2 illustrate program results. Figure 1 shows the fit of (the natural logarithm of) the CPI from January 1955 through December 1980. Because the CPI has several very different base rates of increase over that period of time, the best-fit line (a compound rate of increase of 4.2 percent per year) does not represent the data very well.

Figure 2, on the other hand, shows a fit for January 1955 through June 1956 (a period with little change in the CPI), and were the corresponding graph displayed, this fit would represent the CPI variation quite well with a compound rate of increase of 0.7 percent per year. The second half of the run in figure 2 and the plot shown there are the fit of the CPI from June 1978 through December 1980. Here, the compound rate of increase is 12.7 percent per year, and the straight line is a good representation of the actual base rate of inflation throughout this period. You can also see the relatively small variations around the base-rate line. A number of the points, which represent the raw CPI values, are covered by the best-fit line. This covering is quite clear on the video screen because the program plots the monthly points and then draws the line right over them. To estimate where the covered points lie, remember that the CPI values come in equal steps in time (every month).

### Conclusion

The program reported in this note represents one illustration of an instructive application of regression

# INVESTMENT ANALYSIS FROM CENTENNIAL

CENTENNIAL SOFTWARE / 410 17TH ST. SUITE 1375 / DENVER, CO 80202 / (303) 595-8193

### STOCK-FOCUS

Find out how low is low and how high is high Using capital structure and performance data. Stock-focus objectively calculates the underlying value of a stock. The system was first developed by the management science department of a major money center bank, and is now in use by investment advisors, trust companies and brokerage houses. On your screen, Stock-focus will plot an estimate of lowest value, highest value and the current price. You then decide what to buy, sell or hold.

### REAL-FOCUS

Exhaustively analyze potential real estate investments using the Wharton School's approach to real estate analysis. In minutes you can project profit, costs, and IRR for any project over a 10 year period. Real-focus accounts for amortization, debt, income, operating expenses, taxes, depreciation, and cash flows for both after-tax holding and the results of sale. With Real-focus you can analyze any potential investment from a single building project to a complex time-phased planned unit development.

### THE FOCUS TECHNIQUE

FOCUS is CENTENNIAL SOFTWARE's new approach to Program Architecture, providing a natural interaction between microcomputers and users. It provides worksheet style input screens, free access to all program segments, and the ability to com-

bine individual results files for portfolio analysis. You also receive a usable reference manual, menu helps, a program glossary, multiple report formats and spooling. With our FOCUS technique even the most complex programs are versatile and easy to use.

COMPUTER	MEMORY-K	REAL-FOCUS	STOCK-FOCUS
IBM PC	64	\$179.00	\$189.00
Apple (plus) II	48	149.00	159.00
TRS-80 I	48	149.00	159.00
TRS-80 II	64	179.00	189.00
TRS-80 III	48	149.00	159.00

### ALL PROGRAMS IN DISK BASIC

(IBM is a trademark of IBM. Apple is a trademark of Apple Computer Corp., TRS-80 is a trademark of Tandy Corporation)

ORDER NOW! FILL IN OR CALL 800-525-2003 (Toll Free)

PROGRAM NAME \_\_\_\_\_ COMPUTER \_\_\_\_\_ MEMORY \_\_\_\_\_  
 NAME \_\_\_\_\_ PHONE # \_\_\_\_\_  
 ADDRESS \_\_\_\_\_      
 ACCOUNT # \_\_\_\_\_ EXP. DATE \_\_\_\_\_

## How to make dBase II™ work magic. It's a snap with Autocode™.

Finally, the first practical application of artificial intelligence in personal computer software. Autocode 1 is a powerful program generator for dBASE II. No prior knowledge of programming required.

### AUTOCODE 1

- Automatic menus & sub menus
- Automatic data entry screens
- Automatic data entry routines
- String, numeric, date & calculated fields
- Automatic multiple reports
- Automatic programs in dBASE II code with interactive screens
- No prior knowledge of dBASE II required
- CP/M & MS DOS operating systems
- Handy pocket size manual
- Average learning time only 4 hours

ONLY \$200

## STEMMOS LTD.

666 Howard Street, San Francisco, CA 94105

Just send the following to address above today.

- Your diskette format & hardware
- How many Autocodes you want at \$200 each\*
- Your name & complete address
- A check or money order

ORDER TOLL FREE 800-227-1617 (Ext. 417) IN CA CALL 800-772-3545 (Ext. 417)

Credit card buyers may substitute their card number and expiration date for the check. Or call us toll free and save the trip to the mail box.



U.S. Address: 666 Howard St. San Francisco CA 94105 / U.K. Address: 344 Kensington High Street, London W8J  
 Tel: (415) 777-3800 Dealer Inquiries invited Tel: 01 602 6242

dBASE II is a trademark of Borland.

In California call 800-772-3545 for

Autocode 1 - Stemmoss Ltd.



**J & L SOFTWARE  
MEANS BUSINESS  
FOR THE  
COMMODORE 64  
AND SAVINGS FOR YOU!**  
GENERAL LEDGER \$ 64

- Audit Trail
- Financial Statements
- Reports
- Automatic Balancing

**ACCOUNTS RECEIVABLE \$ 64**

- Statements
- Invoicing
- Aging Reports
- Balancing Forwarding

**DATA BASE MANAGER \$ 64**

- Variable Fields
- Arithmetic Operations
- Formatted Reports
- Sort/Search on all Fields

**GET ALL 3 FOR \$150**

Send Check or Money Order to:

**J & L SOFTWARE  
P.O. BOX 177  
STATE COLLEGE, PA.  
PA. RESIDENTS INCLUDE 6% SALES TAX**

Commodore 64 is a trademark of Commodore Business Machines, Inc.

These programs are available for Apple II as a trademark of the Apple Corp.

Circle 518 on inquiry card.

**Wasting Money! We Have the World's Most Cost Effective Development System.**



- Includes HexKit 1.0, a powerful 100% machine code editor / debugger utility program that makes coding for 8-bit Micros a snap.
- Program from Commodore VIC-20 keyboard into built-in 4K ROM emulator
- Jumper to target ROM socket
- Test programs in circuit
- Built-in EPROM programmer and power supply
- Burns & runs EPROMs for the Commodore VIC-20, too
- Comprehensive manuals
- Fits EXPANSION PORT

**PROMQUEEN CARTRIDGE ONLY \$199**

Send for Free Brochure

Distributed in U.S. by Arvinco Tech Sell, Inc., 470 Meridian, Suite 214, Bellingham, WA 98225. Phone 800-699-1252. In Washington 206-725-0603. Distributed in Canada by IBC/Distributors Canada, 4047 Cambie St, Vancouver, BC V5Z 2G8. Phone 604-675-7817.

VISA AND MASTERCARD ACCEPTED

**Commodore approved product**

Prices	U.S.	CAN.
PROMQUEEN 64	\$299.00	\$399.00
8K board with 1 EPROM	\$29.95	\$39.95
16K board with 1 EPROM	\$39.95	\$49.95
8K board with 1 EPROM-C64	\$39.95	\$49.95

Circle 518 on inquiry card.

**MicroScript™ \$99**

State of the Art Text Formatter

- generic markup
- fully definable page with multiple columns
- multiline headers, footers, and footnotes
- automatic widow and orphan suppression
- automatic section numbering
- automatic table of contents and index
- automatic bullet, number and definition lists
- floating figures
- text alignment to left, center, right, or justify
- left and right indentation with delay and duration
- bold, underline, and proportional spacing
- macros and symbols
- multiple input files of unlimited size
- direct printer control
- DOS, Qume, Diablo, NEC, C.I.TOM, and all TTY

**MicroEd™ \$49**

Customizable Full Screen Editor

- full cursor control by character, word, or line
- position to top or bottom of window or file
- scroll by line, half window, or full window
- global or selective find and replace
- delete by character, word, line, or block
- read external files into current file
- copy, move, and write blocks of text
- insert, overlay, or wordwrap text
- all cursor addressable VDTs

Package with U.S. model 2.2 and 3.0 CA models cost \$74.  
\* \$49.95 (CPM-64) and CPM-64C \$59.95 (CPM-64C)

**MicroType™**

6631 Crown Blvd., Suite 3A, San Jose, CA 95120  
(408) 887-5026

\* CPM-64, CPM-64C and trademarks of Digital Research. PC-DOS is a trademark of IBM Corporation.

Circle 517 on inquiry card.

**Listing 1: This Apple II BASIC program fits the natural logarithms of Consumer Price Index data to a straight line and displays the results. Plotting is user-selectable.**

```

10 REM CONSUMER PRICE INDEX
20 DIM CPI(26,12),Y(26)
30 REM READ IN CPI DATA; NYR=# OF YRS OF DATA; YR0=1ST YEAR
40 NYR = 26
50 FOR I = 1 TO NYR: READ Y(I): FOR J = 1 TO 12: READ CPI(I,J)
60 NEXT J: NEXT I:YR0 = Y(I)
70 PRINT : INPUT "STOP(0), FIT EXPONENT(1), PLOT(2)?":CC
80 IF CC = 0 THEN END
90 PRINT : INPUT "1ST MO, YR (I.E. 6,1965)?":M1,Y1
100 INPUT "2ND MO, YR (YR2>YR1)?":M2,Y2
110 PRINT "FROM ";M1;"/";Y1" TO ";M2;"/";Y2;"
120 Y1 = Y1 - YR0 + 1:Y2 = Y2 - YR0 + 1
130 IF Y2 <= Y1 THEN PRINT "CAN'T DO.":GOTO 90
140 IF CC = 1 THEN GOSUB 170:GOTO 70
150 IF CC = 2 THEN GOSUB 330:GOTO 70
160 GOTO 70
170 REM SUBROUTINE TO CALC BEST LINE
180 T = 0:XS = 0:YS = 0:XY = 0:X2 = 0
190 FOR I = Y1 TO Y2: FOR J = 1 TO 12
200 IF (I = Y1) AND (J < M1) THEN 260
210 IF (I = Y2) AND (J > M2) THEN 260
220 T = T + 1:X = T / 12:Y = LOG (CPI(I,J))
230 XS = XS + X:YS = YS + Y:XY = XY + X * Y:X2 = X2 + X * X
240 IF (I = Y1) AND (J = M1) THEN X6 = X
250 IF (I = Y2) AND (J = M2) THEN X7 = X
260 NEXT J: NEXT I
270 REM M='BEST' SLOPE; S='BEST' INTERCEPT
280 M = (T * XY - XS * YS) / (T * X2 - XS * XS)
290 B = (YS * X2 - XY * XS) / (T * X2 - XS * XS)
300 R = INT (1000 * (EXP (M) - 1) * .5) / 10
310 PRINT " EFF. COMPOUND ANNUAL RATE = ";R;" %"
320 RETURN
330 REM SUBROUTINE TO PLOT LN(CPI) VS TIME
340 GOSUB 180
350 REM CO=BOTTOM OF GRAPH; C9=TOP OF GRAPH
360 CO = LOG ( INT (CPI(Y1,M1))) : IF CO < (M * X6 + B) THEN 380
370 CO = LOG ( INT ( EXP (M * X6 + B)))
380 C9 = LOG ( INT (CPI(Y2,M2) + 1)) : IF C9 > (M * X7 + B) THEN 400
390 C9 = LOG ( INT ( EXP (M * X7 + B) + 1))
400 HGR : HCOLOR= 3: HPLOT 0,0 TO 279,0 TO 279,159 TO 0,159 TO 0,0
410 PRINT "Y SCALE: LOG("; EXP (CO);") TO LOG("; EXP (C9);")."
420 T = 0: FOR I = Y1 TO Y2: FOR J = 1 TO 12
430 IF (I = Y1) AND (J < M1) THEN 480
440 IF (I = Y2) AND (J > M2) THEN 480
450 T = T + 1:X9 = (T / 12) - X6 / (X7 - X6)
460 Y9 = ( LOG (CPI(I,J)) - CO) / (C9 - CO)
470 HPLOT 279 * X9,159 - 159 * Y9
480 NEXT J: NEXT I
490 Y6 = ((M * X6 + B) - CO) / (C9 - CO)
500 Y7 = ((M * X7 + B) - CO) / (C9 - CO)
510 HPLOT 0,159 - 159 * Y6 TO 279,159 - 159 * Y7
520 INPUT " PRESS RETURN FOR NEW COMMAND.":Y9: TEXT : RETURN
530 REM CPI DATA; EACH ROW: YEAR,12 MONTHLY VALUES
540 REM VALUES FROM 1/1955 THROUGH 12/1980
550 REM VALUES FROM 'BUSINESS CONDITIONS DIGEST'
560 REM US DEPT OF COMMERCE, BUREAU OF ECONOMIC ANALYSIS
570 DATA 1955,80.1,80.1,80.1,80.1,80.1,80.1,80.1,80.2,80.5,80.5,80.6,80.4
580 DATA 1956,80.3,80.3,80.4,80.5,80.9,81.4,82,81.9,82,82.5,82.5,82.7
590 DATA 1957,82.8,83.1,83.3,83.6,83.8,84.3,84.7,84.8,84.9,84.9,85.2,85.2
600 DATA 1958,85.7,85.8,86.4,86.6,86.6,86.7,86.8,86.7,86.7,86.8,86.7
610 DATA 1959,86.8,86.7,86.7,86.8,86.9,87.3,87.5,87.4,87.7,88,88,88

```

Listing 1 continued:

```

620 DATA 1960,87.9,88.88,88.5,88.5,88.7,88.7,88.8,89.2,89.3,89.3
630 DATA 1961,89.3,89.3,89.3,89.3,89.3,89.4,89.8,89.7,89.9,89.9,89.9
640 DATA 1962,89.9,90.1,90.3,90.5,90.5,90.5,90.7,90.7,91.2,91.1,91.1,91
650 DATA 1963,91.1,91.2,91.3,91.3,91.3,91.7,92.1,92.1,92.1,92.2,92.3,92.5
660 DATA 1964,92.6,92.5,92.6,92.7,92.7,92.9,93.1,93.2,93.3,93.5,93.6
670 DATA 1965,93.6,93.6,93.7,94.94.2,94.7,94.8,94.6,94.8,94.9,95.1,95.4
680 DATA 1966,95.4,96.96.3,96.7,96.8,97.1,97.4,97.9,98.1,98.5,98.5,98.6
690 DATA 1967,98.6,98.7,98.9,99.1,99.4,99.7,100.2,100.5,100.7,101.1,101.3,101.6
700 DATA 1968,102.1,102.3,102.8,103.1,103.4,104.104.5,104.8,105.1,105.7,106.1,106.4
710 DATA 1969,106.7,107.1,108.108.7,109.109.7,110.2,110.7,111.2,111.6,112.2,112.9
720 DATA 1970,113.3,113.9,114.5,115.2,115.7,116.3,116.7,116.9,117.5,118.1,118.5,119.1
730 DATA 1971,119.2,119.4,119.8,120.2,120.8,121.5,121.8,122.1,122.2,122.4,122.6,123.1
740 DATA 1972,123.2,123.8,124.124.3,124.7,125.125.5,125.7,126.2,126.6,126.9,127.3
750 DATA 1973,127.7,128.6,129.8,130.7,131.5,132.4,132.7,135.1,135.5,136.6,137.6,138.5
760 DATA 1974,139.7,141.5,143.1,143.9,145.5,146.9,148.149.9,151.7,153,154.3,155.4
770 DATA 1975,156.1,157.2,157.8,158.6,159.3,160.6,162.3,162.8,163.6,164.4,165.6,166.3
780 DATA 1976,166.7,167.1,167.5,168.2,169.2,170.1,171.1,171.9,172.6,173.3,173.8,174.3
790 DATA 1977,175.3,177.1,178.2,179.6,180.6,181.8,182.6,183.3,184.184.5,185.4,186.1
800 DATA 1978,187.2,188.4,189.8,191.5,193.3,195.3,196.7,197.8,199.3,200.9,202,202.9
810 DATA 1979,204.7,207.1,209.1,211.5,214.1,216.6,218.9,221.1,223.4,225.4,227.5,229.9
820 DATA 1980,233.2,236.4,239.8,242.5,244.9,247.6,247.8,249.4,251.7,253.9,256.2,258.4
830 REM COPYRIGHT (C) HENDRIX COLLEGE 1980
840 REM ALL RIGHTS RESERVED. PLEASE GIVE APPROPRIATE CREDITS.
850 END
    
```

```

(1a)
RUN
STOP(0), FIT EXPONENT(1), PLOT(2)?2
1ST MO, YR (I.E. 6,1965)?1,1955
2ND MO, YR (YR2)YR1)?12,1980
FROM 1/1955 TO 12/1980:
EFF. COMPOUND ANNUAL RATE = 4.2 %
Y SCALE: LOG(68) TO LOG(259).
PRESS RETURN FOR NEW COMMAND.
    
```

```

STOP(0), FIT EXPONENT(1), PLOT(2)?0
    
```

1

(1b)

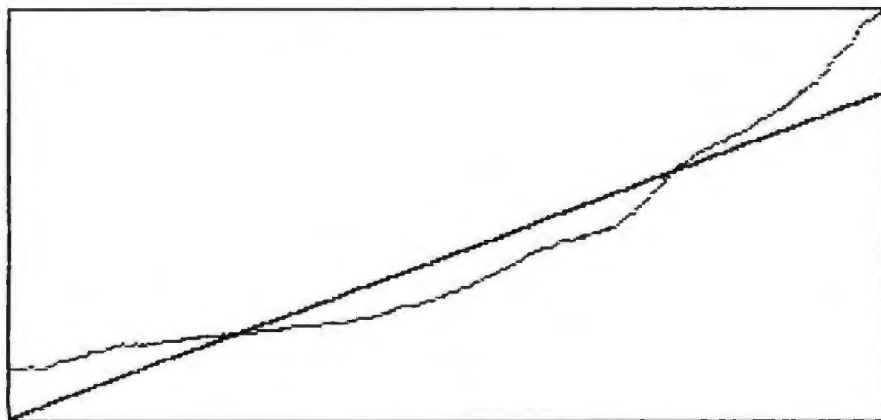


Figure 1: The computer prompting messages and operator responses shown in (1a) produce the plot shown in (1b). This plot results from running the listing 1 program using Consumer Price Index data from January 1955 through December 1980. The best-fit line represents a 4.2 percent-per-year compound rate of increase.

## What makes a streetwise kid from New York want to help rice farmers in the tropics?

Meet Mike Harvey. He's not out to change the world, just to understand it a little better. And because he thinks that underneath all the differences people are basically alike, he feels he can help.

It's what today's Peace Corps is all about. Americans from every kind of background, of all ages, making a commitment to live and work with people around the world to meet basic human needs.



You won't be asked to move mountains but you'll understand what volunteers like Mike Harvey mean when they talk of small miracles. Why they want to work hard at a challenge unique to the Peace Corps.

Above all, you'll be learning something about the world, making friends with people you can help. And that's what life should be all about.

For further information, call toll free 800-424-8580. Or write Peace Corps, Washington, D.C. 20525.

## Peace Corps

The toughest job you'll ever love.



A Public Service of This Magazine & The Advertising Council



(2a)  
JRUN

STOP(0), FIT EXPONENT(1), PLOT(2)?1

1ST MO, YR (I.E. 6,1965)?1,1955  
2ND MO, YR (YR2>YR1)?6,1956  
FROM 1/1955 TO 6/1956:  
EFF. COMPOUND ANNUAL RATE = .7 %

STOP(0), FIT EXPONENT(1), PLOT(2)?2  
(2b)

1ST MO, YR (I.E. 6,1965)?6,1978  
2ND MO, YR (YR2>YR1)?12,1980  
FROM 6/1978 TO 12/1980:  
EFF. COMPOUND ANNUAL RATE = 12.7 %  
Y SCALE: LOG(192) TO LOG(260),  
PRESS RETURN FOR NEW COMMAND.

STOP(0), FIT EXPONENT(1), PLOT(2)?0

1

(2c)

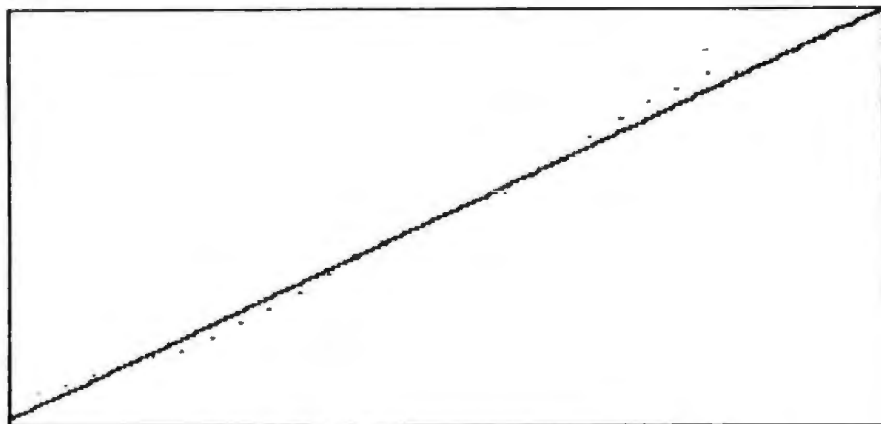
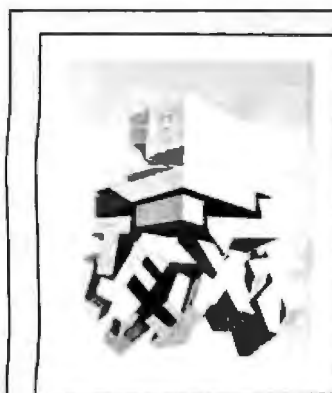


Figure 2: Demonstrating use of the listing 1 program, the prompting and response messages in (2a) and (2b), respectively, show program operation for Consumer Price Index data from January 1955 through June 1956 (at a 0.7 percent-per-year compound rate of increase) and June 1978 through December 1980 (12.7 percent-per-year compound rate of increase). The graph in (2c) results from the (2b) inputs; the discrete points are individual Consumer Price Index values.

analysis to curves of general interest. This regression analysis is actually a nonlinear, least-squares fit to an exponential curve representing a compound-interest function. However, the nonlinear regression is accomplished using well-known results from linear-regression analysis by fitting the best straight line to the natural logarithms of the particular index used, the CPI.

Using the program demonstrates the complexity of the CPI as a function of time. Such use also demonstrates that the CPI behavior in specific segments of time can be reasonably well represented by compound-interest curves with differing base annual inflation rates. Furthermore, using the program shows the relatively small variations on top of the base inflation rates in the different epochs.

Such an instructive analysis then leads to the questions that simple data manipulations are unlikely to answer—fundamental questions such as, "What occurred during the various, distinct epochs to cause the quite different base inflation rates?" "Can you see the effects of the Vietnam War or the price increase from OPEC in the appropriate epochs?" or "Are the effects of such major influences as war or energy prices delayed in time and why?" The point of the instructive illustration furnished by this program is to get people to consider questions of progressively deeper levels and to be able to test reasonable hypotheses against the data itself. ■



Through the Trap Door  
March 1979—\$35



Breaking the Sound Barrier  
September 1977—\$35

## BYTE COVERS

The prints shown at left are beautiful Collector Edition Byte Covers, strictly limited to 750 prints each, and signed and numbered by the artist, Robert Tinney. Each print is 18 in. x 22 in., and is accompanied by its own Certificate of Authenticity. To order, use the coupon below. Visa and MasterCard orders may call 1-504-272-7266.

Please send \_\_\_\_\_ Through the  Visa  MasterCard  
Trap Door prints (\$35), \_\_\_\_\_  
Breaking the Sound Barrier  
prints (\$35), or \_\_\_\_\_ sets of both prints  
(\$55). I have included \$3 per order shipping  
and handling (\$8 overseas).  
 I have enclosed check or money order

Card No. \_\_\_\_\_  
Expires: \_\_\_\_\_  
Name \_\_\_\_\_  
Address: \_\_\_\_\_  
City: \_\_\_\_\_ State: \_\_\_\_\_ Zip: \_\_\_\_\_

Robert Tinney Graphics - 1864 N. Pamela Dr. - Baton Rouge, LA 70815

## WINCHESTER DISK SYSTEMS.



### A Complete Winchester/Floppy Disk System.

- S-100 (IEEE-696)
- Disk controller with 4 ports; supports 5 1/4" and 8" drives (floppy and/or Winchester) on same cable.
- Z80 CPU 4 or 6 MHz, 64KRAM, 2 serial I/O, 1 parallel, CTC.
- Supports BMB Amlyn floppy, CP/M<sup>®</sup> and BIOS included.
- Package price: \$1,195.00 (OEM pricing upon request). May be purchased separately. Winchester and floppy drives available.

### SIGEN Corporation

1800 Wyatt Dr., #6, Santa Clara, CA 95054  
 Contact: Allen Hauptman, 408/988-2527  
 CP/M is a trademark of Digital Research.



## "Q-PRO 4 blows dBASE II away"

We now complete complex applications in weeks instead of months. "

says Q-PRO 4 user,  
 Richard Pedrelli, President  
 Quantum Systems, Atlanta, GA



"As a dBASE II beta test site the past two years, we were reluctant to even try Q-PRO 4. Now we write all our commercial applications in Q-PRO 4. We find it to be an order of magnitude more powerful than dBASE II.

Q-PRO 4's 4th generation syntax is so efficient, we now complete complex jobs in weeks instead of months. Superb error trap and help screen capabilities make our finished applications far more user friendly. And our programs run much faster, too.

In my estimation, any application programmer still using outdated 3rd generation data base managers or worse, a 2nd generation language like BASIC, is ripping himself off. "

Q-PRO 4 - \$395. Ask about FREE trial offer. Call (215) 968-5966  
 Runs on 8 bit micros with CP/M, MP/M, TurboDOS<sup>™</sup>, MmmOST.  
 Author's lock up package available.

## Quic-n-easi products inc.

136 Granite Hill Court, Langhorne, PA 19047 (215) 968-5966

CP/M and MP/M are registered trademarks of Digital Research. TurboDOS is a trademark of Software 2000, Inc. MmmOST is a trademark of TeleVideo. dBASE II is a registered trademark of Ashton-Tate, Inc.

# DEVELOPING SOFTWARE UNDER CP/M? LIFT YOUR OUTPUT WITH MICROSHELL<sup>®</sup>



When you're into heavyweight software development you need more operating system power than CP/M can offer. MICROSHELL builds up CP/M with UNIX features that really help you put out software. Just for starters: MICROSHELL crunches long CP/M dialogs into one-line commands. Puts muscle and flexibility into SUBMIT commands. Captures CRT output and redirects it to CP/M files without retyping. Pulls programs from another disk drive or user number automatically (makes hard disk handling a snap). And it's ready for more work with no time-consuming warm-start after a program runs. MICROSHELL fits your system — uses just 8K of memory in any CP/M computer from Apple to Zenith. Check out MICROSHELL today and find out what a powerful partner it makes — at only \$150.

™CP/M, Digital Research, UNIX, Bell Laboratories; Apple, Apple Computer, Inc.

Order Toll Free: 800-368-3359  
 VISA, MasterCard accepted.  
 Overseas add \$20.00 for air mail.  
 Manual only: \$25.



**NEW  
 GENERATION  
 SYSTEMS, inc.**

2153 Golf Course Drive  
 Reston, VA 22091  
 (703) 476-9143

Circle 327 on Inquiry card.



# Go with McGraw-Hill's EXPERIENCE!

## TAKE ANY 3 BOOKS FOR ONLY \$100 EACH when you join McGraw-Hill's Electronics and Control Engineers' Book Club (Values up to \$87.00)\*

**INTUITIVE IC ELECTRONICS: A Sophisticated Primer for Engineers and Technicians.** By T. M. Frederiksen. 208 pp., illus. Covering both the simplest and the most complicated IC designs, this lively, easy-to-read volume provides a sophisticated, nonmathematical explanation of the basic internal mechanisms common to all semiconductor devices. 219/230 \$19.95

**RADIO HANDBOOK, 22/e.** By W. Orr. 1,136 pp., more than 1,300 illus. Here's the latest edition of what is universally regarded as the most useful reference in the industry. It's a "course" in communications, a fact-packed reference, and a how-to guide—all in a single book! 582442-6B \$39.95 (Counts as 2 of your 3 books)

**MICROWAVE SEMICONDUCTOR ENGINEERING.** By J. F. White. 558 pp., 319 illus. Packed with an awesome amount of never-before-published material, this reference contains a wealth of formulas, constants, and practical design techniques needed by everyone who works in the field of microwave engineering. 582553-8 \$26.50

**MANUAL OF ACTIVE FILTER DESIGN, 2/e.** By J. L. Hilburn and D. E. Johnson. 225 pp., 157 easy-to-use design graphs. This ingenious manual enables you to design filter circuits for virtually any application in minutes—without making a single computation! Covers all the latest designs. 287/694B \$37.50 (Counts as 2 of your 3 books)

**MICROPROCESSOR DATA BOOK.** By S. A. Money. 350 pp., 220 illus. Easily the most comprehensive collection of data on microprocessors and their support chips available anywhere! Provides important facts on a wide range of popular devices from American, European, and Japanese manufacturers. 427/082B \$35.00 (Counts as 2 of your 3 books)

**HANDBOOK OF SEMICONDUCTOR AND BUBBLE MEMORIES.** By W. A. Triebel and A. D. Chu. 416 pp., illus., over 50 worked-out problems. This detailed, comprehensive guide brings you right up to the minute on such newly developed devices as the PLA, FIFO, CAM, CCD, and magnetic bubble memory—as well as all the standard storage devices from ROMs and RAMs to shift registers. 582376-4 \$24.95

**INTRODUCTION TO RADAR SYSTEMS, 2/e.** By M. I. Skolnik. 698 pp., 244 illus. This new edition of a widely used text on radar from the systems engineer's point of view brings you full discussions of the many major changes that have occurred in the field recently. 579/091B \$39.95 (Counts as 2 of your 3 books)

*McGraw-Hill's long-established club that saves you BIG money on the important new books of all publishers!*

\*If you join now for a trial period and agree to purchase three more books—at handsome discounts—over the next year. (Publishers' prices shown)



**MAGNETIC CORE SELECTION FOR TRANSFORMERS AND INDUCTORS: A User's Guide to Practice and Specifications.** By W. T. McLyman. 768 pp., 400 illus. This giant volume is brimming with time-saving tips to help you select the right magnetic core for virtually any application. 582494-9A \$65.00 (Counts as 3 of your 3 books)

**ELECTRONIC COMMUNICATION, 4/e.** By R. L. Shrader. 801 pp., 870 illus. This thoroughly updated edition offers all the theory and fundamentals you need to prepare yourself for the FCC commercial and amateur grade license examinations—and pass them the first time! 571/503 \$26.95

**DIGITAL HARDWARE DESIGN.** By J. B. Peatman. 428 pp., over 400 illus. Taking you beyond the microcomputer, this guide reexamines traditional techniques and focuses on the design of circuitry too fast for the microcomputer alone. 491/321B \$35.50 (Counts as 2 of your 3 books)

**MICROPROCESSOR APPLICATIONS HANDBOOK.** Editor-in-Chief, D. F. Stout. 472 pp., 284 illus. At last—a reference guide to microprocessor applications to help you make your systems timely, versatile, and cost-effective. 617/988B \$35.00 (Counts as 2 of your 3 books)

**SIGNALS AND SYSTEMS.** By A. Oppenheim, A. Willsky, and I. Young. 869 pp., more than 350 illus. This unique volume presents a comprehensive discussion of methods for analyzing discrete-time systems. Includes a look at feedback, convolution, and other concepts not treated in depth elsewhere. 582674-7B \$32.50 (Counts as 2 of your 3 books)

**MODERN ELECTRONIC CIRCUITS REFERENCE MANUAL.** By J. Markus. 1,264 pp., 3,666 circuit diagrams. Complete with values of components and suggestions for revisions, plus the original source of each circuit in case you want additional performance or construction details. 404/461A \$57.95 (Counts as 3 of your 3 books)

**ELECTRONICS ENGINEERS' HANDBOOK, 2/e.** Edited by D. G. Fink & D. Christiansen. 2,272 pp., 2,189 illus. This updated and enlarged edition covers the latest knowledge in the field, including new advances in integrated circuits, pulsed and logic circuits, laser technology, telecommunications, and much more. 209/812A \$75.00 (Counts as 3 of your 3 books)

**PCM AND DIGITAL TRANSMISSION SYSTEMS.** By R. Owen. 320 pp., 186 illus. This useful volume allows newcomers to the field to familiarize themselves with its problems and equipment in two weeks, instead of the three months it would ordinarily take. 479/542B \$30.00 (Counts as 2 of your 3 books)

**ANTENNA THEORY: Analysis and Design.** By C. A. Balanis. 816 pp., illus. Packed with equations, design procedures, and plenty of nuts-and-bolts know-how, this is the first place to turn for answers to all your antenna design questions. 582493-0B \$39.50 (Counts as 2 of your 3 books)

**ELECTRONICS ENGINEERING FOR PROFESSIONAL ENGINEERS' EXAMINATIONS.** By C. R. Hafer. 336 pp., more than 200 illus. Actually two books in one—a quick preparation manual to help you pass your P.E. exams on the first try and a rich source of practical electronics engineering information and know-how.

254/303 \$27.50

**16-BIT MICROPROCESSOR SYSTEMS.** By Texas Instruments, Inc. 576 pp., illus. This broad-based guide presents a comprehensive overview—from basic concepts to advanced design principles. Covers programming methods, instruction sets, I/O design, memory design, and much more.

637/601B \$45.00  
(Counts as 2 of your 3 books)

**OPTICAL FIBER SYSTEMS: Technology, Design, and Applications.** By C. K. Kao. 197 pp., illus. From a basic explanation of optical fiber systems to the economic ramifications of their use, this volume provides full coverage of a rapidly developing field.

332/770 \$26.00

**DIGITAL CIRCUITS AND MICRO-PROCESSORS.** By H. Taub. 608 pp., heavily illus. This fast-paced, carefully written guide gives you thorough explanations of all the basic principles of digital systems and logic design—plus a solid introduction to microprocessors and microprocessor-based designs.

629/455B \$32.95  
(Counts as 2 of your 3 books)

**McGraw-Hill's NATIONAL ELECTRICAL CODE<sup>3</sup> HANDBOOK, 17/e.** By J. F. McPartland. 1,162 pp., 1,096 illus. Bigger and better than ever! This mammoth reference explains and clarifies the many complex provisions of the current (1981) Code<sup>3</sup> to help you meet rules exactly and pass inspections the very first time.

456/933 \$26.50

**INTEGRATED CIRCUIT FABRICATION TECHNOLOGY.** By D. J. Elliott. 480 pp., 220 illus. Covering every step in the transformation of a silicon chip to an integrated circuit, this is the first book to combine, in a single volume, a cohesive examination of the equipment, materials, and techniques of IC fabrication.

192/383 \$29.75

**NETWORK SYSTEMS.** By R. Sharma, P. DeSousa, and A. Ingle. 321 pp., illus. Here's the first book to describe, concisely and comprehensively, all current stored program-controlled (SPC) telecommunication network systems that use integrated modeling, analysis, and design techniques. Gives you the know-how you need to meet design specifications.

582557-0 \$29.95

**HANDBOOK OF ELECTRONIC PACKAGING DESIGN AND ENGINEERING.** By B. Matisoff. 480 pp., 312 illus. This handy volume examines the broad array of packaging techniques available today, providing the data you need to select the best one for a given application. Stresses the interplay between design criteria.

582515-5B \$32.50  
(Counts as 2 of your 3 books)

**STANDARD HANDBOOK FOR ELECTRICAL ENGINEERS, 11/e.** By D. G. Fink and H. Bealy. 2,448 pp., 1,414 illus. Today's most widely used source of electrical engineering information and data serves you as no other single work when you need detailed, timely, and reliable facts.

209/74XA \$65.95  
(Counts as 3 of your 3 books)

## Be sure to consider these important titles as well!

**RADAR TRANSMITTERS.** By G. W. Ewell. 198/438 \$26.95

**USER'S GUIDEBOOK OF DIGITAL CMOS INTEGRATED CIRCUITS.** By E. R. Hnatek. 290/679 \$29.00

**ELECTRONIC CIRCUITS NOTEBOOK: Proven Designs for Systems Applications.** Edited by S. Weber. 192/448B \$35.50  
(Counts as 2 of your 3 books)

**ELECTRONIC FILTER DESIGN HANDBOOK.** By A. B. Williams. 704/309B \$41.50  
(Counts as 2 of your 3 books)

**INTRODUCTION TO THE THEORY AND DESIGN OF ACTIVE FILTERS.** By L. P. Huelsman & P. E. Allen. 308/543B \$34.50  
(Counts as 2 of your 3 books)

**MICROELECTRONICS.** By J. Milman. 423/27XB \$35.95  
(Counts as 2 of your 3 books)

**HANDBOOK OF OPERATIONAL AMPLIFIER CIRCUIT DESIGN.** By D. E. Stout & M. Kaufman. 617/97XB \$38.00  
(Counts as 2 of your 3 books)

**MICROCOMPUTER-BASED DESIGN.** By J. Peatman. 491/280B \$35.95  
(Counts as 2 of your 3 books)

**BIT-SLICE MICROPROCESSOR DESIGN.** By J. Mich & J. Brick. 417/814 \$29.50

**DESIGNING WITH FIELD-EFFECT TRANSISTORS.** By Siliconix, Inc. 574/499 \$29.50

**ENGINEERING MATHEMATICS HANDBOOK, 2/e.** By J. J. Tuma. 654/298B \$31.25  
(Counts as 2 of your 3 books)



## Why YOU should join now!

■ **BEST AND NEWEST BOOKS IN YOUR FIELD!** Books are selected from a wide range of publishers by expert editors and consultants to give you continuing access to the best and latest books in your field.

■ **BIG SAVINGS!** Build your library and save money too! Savings ranging up to 30% or more off publishers' list prices—usually 20% to 25%.

**BONUS BOOKS!** You will immediately begin to participate in our Bonus Book Plan that allows you savings up to 80% off the publisher's prices of many professional and general interest books!

■ **CONVENIENCE!** 12-14 times a year (about once every 3-4 weeks) you receive the Club Bulletin FREE. It fully describes the Main Selection and alternate selections. A dated Reply Card is included. If you want the Main Selection, you simply do nothing—it will be shipped automatically. If you want an alternate selection—or no book at all—you simply indicate it on the Reply Card and return it by the date specified. You will have at least 10 days to decide. If, because of late delivery of the Bulletin you receive a Main Selection you do not want, you may return it for credit at the Club's expense.

As a Club Member you agree only to the purchase of three additional books during your first year of membership. Membership may be discontinued by either you or the Club at any time after you have purchased the three additional books.

**Other McGraw-Hill Book Clubs:** Accountants' and Controllers' Book Club • Architects' Book Club • Byte Book Club • Chemical Engineers' Book Club • Civil Engineers' Book Club • Mechanical Engineers' Book Club

For more information, write to:

McGraw-Hill Book Clubs • P.O. Box 582, Hightstown, NJ 08520

### MAIL THIS COUPON TODAY

McGraw-Hill Book Clubs  
Electronics and Control Engineers'  
Book Club  
P.O. Box 582, Hightstown, New Jersey 08520

Please enroll me as a member and send me the three choices I have listed below. Bill me only \$3.00 plus local tax, postage, and handling. If not satisfied, I may return the books within 10 days and my membership will be canceled. I agree to purchase a minimum of three additional books during my first year of membership as outlined under the Club plan described in this ad. A shipping and handling charge is added to all shipments. Indicate below by number the books you want. A few expensive books listed in the descriptions count as more than one choice.

Name \_\_\_\_\_

Address Apt \_\_\_\_\_

City/State/Zip \_\_\_\_\_

This order subject to acceptance by McGraw-Hill. All prices subject to change without notice. Offer good only to new members. Orders from outside the U.S. cannot be accepted.

E33585



# Sorting Algorithms for Microcomputers

*Programmer ingenuity and search of the existing literature can significantly improve sort performance.*

---

Terry Barron  
1901 East Lynn St.  
Seattle, WA 98112

George Diehr  
1500 38th Ave.  
Seattle, WA 98122

---

Many applications require organizing data into ascending or descending order—sorting. This can be an extremely time-consuming job, especially if a too simple algorithm is used. On a large machine the inefficiency may not be noticed—one second versus ten may not be worth worrying about. On a microcomputer, however, one *minute* versus ten may be quite important, especially if you're sitting at a terminal waiting for the results.

In this article we examine two fairly simple and closely related sorting algorithms: Shuttlesort and Shellsort. Shellsort is a generalization of Shuttlesort, requiring only a small added expenditure of programming

effort but yielding astounding improvements in performance.

In addition, we examine the sorts' performance on a variety of machine-language combinations to give some idea of their relative power on a common practical task.

When faced with a common problem such as sorting, someone has probably developed efficient methods—what you need to know is where to look. References 1, 2, 4, and 5 are convenient sources of sorting algorithms.

## Types of Sorts

If the sort program and all the data to be sorted fit into central memory, we can use an *internal sort*. If not, some kind of *external sort* must be used. Such sorts involve sorting parts of the data in central memory, writing these sorted parts to a disk, and then merging the parts together to create a file of sorted data. This article deals with internal sorts, which

can be used during the internal phase of an external sort.

Many internal sorting algorithms are available, each with advantages and disadvantages. Broadly speaking, we can classify the sorts by two characteristics: efficiency and complexity (see table 1).

Shellsort occupies an interesting position in this classification: it is in the same efficiency class as sorts such as Quicksort yet is easier to program. In addition, it is more efficient than the Shuttle/Bubble varieties yet no more difficult to program. This is only a small exaggeration. Shellsort is slightly more complicated than those in the Shuttle category. Also, it is slightly less efficient, at least theoretically, than Quicksort and Treesort. Nevertheless, in most situations Shellsort represents the best choice in trading machine time for complexity. Furthermore, Shellsort requires no more space than Shuttlesort while Quicksort does require additional space.

---

## About the Authors

Terry Barron is a doctoral candidate in the School of Business at the University of Washington. George Diehr is an Associate Professor of Quantitative Methods in the School of Business at the University of Washington.

---

Efficiency	Complexity of Algorithm		
	Low	Medium	High
Low	Shuttle Bubble Pair Exchange		
Medium	Shellsort	Quicksort Treesort	
High			Linear-Time Sort

**Table 1: Common sorting methods can be classified by two characteristics: efficiency and complexity.**

**Listing 1: This Applesoft version of Shuttlesort includes a GOSUB at line 20 to branch to code that generates data used to perform the tests described in the text. The sort proper is the code from line 50 through line 200.**

```

10 DIM X(1024)
19 REM BRANCH TO GENERATE N RANDOM VALUES
20 GOSUB 1000
50 FOR I = 1 TO N - 1
60 FOR J = I TO 1 STEP - 1
70 IF X(J) < = X(J + 1) THEN 200
80 TX = X(J);X(J) = X(J + 1);X(J + 1) = TX;
100 NEXT J
200 NEXT I

```

Because Shuttlesort serves as the starting point for Shellsort, we consider it first. It is useful for sorting small lists of items (e.g., up to 30 or so on a microcomputer). Shuttlesort is also used as part of more complex algorithms such as modified Quicksort. (Reference 5 is an excellent source for more information on all the sorts noted in the table except the linear-time sort, which is covered in reference 6.)

### Shuttlesort

For a concrete demonstration of the Shuttlesort algorithm, we will assume that we want to sort the following list of single characters into normal alphabetical order:

Location	1	2	3	4	5	6
Element	X	C	D	M	A	B

The Shuttlesort algorithm starts by comparing the first two items, X and C, and exchanges them if they are out of order. Because X should come after

C, they are exchanged. The algorithm next compares locations 2 and 3. Because X should come after D, they are exchanged.

The sort now determines how far up in the list the value D should be moved (to the left in our display). Therefore, C and D are compared. Because they are in the right order, no exchange is made. The comparisons resume at locations 3 and 4; X should come after M and they are swapped. The list is now

Location	1	2	3	4	5	6
Element	C	D	M	X	A	B

Values at locations 4 and 5 are compared next. Because X should come after A, they are exchanged; next, M and A are compared and another exchange occurs. Two more exchanges—D and A, then C and A—place A in location 1. The sort resumes by comparing X and B. B travels up the list until it stops at location 2, finishing the sort;



### WEAR IT WITH PRIDE! Computer Jewelry

Be identified as a micro professional  
Lapel Pins • Tie Tacks • Stick Pins  
Available in Sterling Silver or 18K over sterling  
Size: 1/2" square Silver \$10 • Gold \$12  
(Add \$2 for S/H) • (CA add sales tax)  
Visa • Mastercard or check payable to MC/N, Inc.  
Money Back Guarantee  
Dealer & Corporate Discounts Available  
Allow 2-3 weeks for delivery



MC/N, Inc.  
SIMMS CENTER/Box 9393  
San Rafael, CA 94912  
(415) 453-7033

Circle 502 on inquiry card.

### Touch Tone Decoding Modem

Convert Touch Tones to ASCII. The Touch Tone Decoder Modem offers a low cost solution to remote monitoring and data entry applications. It autoanswers and connects any host computer's asynchronous RS-232 port with the telephone system. Select 300, 600, or 1200 baud data rate or optional external audio input. \$500 single quantity. Touch Tone send/1200 baud receive terminal available.

the microperipheral corporation

2565 152nd Avenue NE  
Redmond, WA 98052  
(206) 881-7544

Circle 307 on inquiry card.

### CHIPS & DALE

THE INFLATION FIGHTERS!

- 4116 250ms 8/89.50 100+ 1.05 ea.
- 4118 200ms 8/810.00 100+ 1.05 ea.
- 4116 150ms 8/11.50 100+ 1.25 ea.
- 4116 120ms 8/114.50 100+ 1.30 ea.
- 4116 120ms 8/15.50 100+ 1.30 ea.
- 2114L 300ms 8/10.50
- 2114L 200ms 8/12.00
- \*4164 200ms 84.65 ea.
- \*4164 150ms 83.10 ea.
- \*6116 150ms 84.00 ea.
- \*6116 200ms 83.85 ea.
- \*6118LP 150ms 84.75 ea.
- \*1791 Disk Controller 820.00
- 1777 Disk Controller 817.80
- 280A, 280ACTC, 280A PIO 83.00 ea.
- 8285 84.25
- 2715-1 5V 350ms 8/84.25 ea. 85.00 ea.
- 2715 5V 450ms 83.00 ea.
- \*2732 5V 450ms 83.85 ea.
- \*2532 5V 450ms 84.25 ea.
- \*2764 5V 300ms 28 pin 89.00 ea.
- \*2764 5V 24 pin CALL
- \*2564 5V CALL
- \*\*8087 CALL
- 88000 CALL

Allow up to 3 wks. for personal checks to clear. Please include phone number. Prices subject to change without notice. Shipping & Handling for Chips 83.50; FOB Bellevue, WA, for all else. Wash. residents add 8.5% Sales Tax.

CHIPS & DALE 1-206-451-9770  
10655 N.E. 4th St., Suite 400  
Bellevue, WA 98004

Circle 93 on inquiry card.



## \$30 SOLVES THE BACKUP PROBLEM FOR CP/M 2.2

Qbax is a revolutionary new backup program which saves huge amounts of time for users of either floppies or hard disks by copying only files which have changed.



- Incremental backup for CP/M 2.2
- Copies only files rewritten since the last backup
- Handles multiple backups
- Change or report the backup status of files
- Redirectable I/O.



Amanuensis, Inc.  
R. D. #1 Box 236  
Grindstone, Pa. 15442  
(412) 785-2806

8" SSSD &  
popular 5 1/4" formats  
OEM inquiries invited

Qbax TM Amanuensis, Inc.  
CP/M Registered TM Digital Research

Location	1	2	3	4	5	6
Element	A	B	C	D	M	X

Although our example sorts single characters, the algorithm applies equally to real values, integers, or arbitrarily long strings. The performance tests presented here use randomly ordered real values.

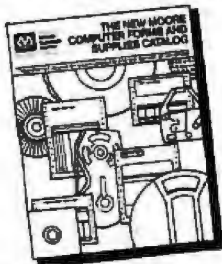
Listing 1 shows an Applesoft version of Shufflesort for real-valued data. The FOR loop from lines 50 to 200 controls the traversal down array X so that the first comparison for a given value of I is X(I) and X(I+1). The inner FOR loop, lines 60 through 100, moves the value at X(I) up the list until it encounters a smaller (or equal) value or until it reaches the top of the list. The exchange of X(J) and X(J+1) in line 80 moves data elements up the list.

As noted in table 1, Shufflesort is in the same class as the Bubble and Pair Exchange sorts. A sort shown in the *Apple BASIC Programming Reference Manual* (page 15) is a Pair Exchange sort. The efficiency of these sorts can be described by the increase in sorting time as the number of items to be sorted increases. If it takes T seconds to sort N items, these sorts will require about 4T seconds to sort 2N items: the sort time increases with the square of the number of items. Algorithms with this efficiency are said to be *order N-square* in performance. Sorting time can get out of hand very quickly with an order N-square sort. For example, if 100 items require 100 seconds to sort, 200 items will require 400 seconds. Sorting 1000 items becomes impractical—it would take about 3 hours.

A clue to this algorithm's inefficiency can be seen in our letter-sorting example. The value A starts in location 5 but belongs in location 1; Shufflesort needs four exchanges to move it to the top. Similarly, the movement of value B to location 2 also requires four exchanges. As the number of items to be sorted increases, the number of exchanges for each item increases. The total number of exchanges is proportional to the number of items times the number of exchanges for each—hence the order N-square performance.

# IT'S FREE!

Announcing the NEW, Summer 1983 Moore Computer Forms and Supplies Catalog



- Our new, 80-page Summer Catalog features more than 600 quality, brand-name products—all guaranteed to meet your 100% satisfaction or your money back
- For all your computer or word processor needs, a wide selection of magnetic media, disk storage, binders, ribbons and furniture
- Over 40 pages of multi-purpose computer forms and labels at low prices, including an ALL-NEW 34-page section of imprinted forms
- Unmatched customer services, like fast order processing, custom imprinting, emergency overnight delivery, plus exclusive toll-free Technical Product Assistance

Now with a NEW 34-page computer forms section!

Mail this coupon or call toll-free  
**1-800-323-6230**  
(In Illinois, Call (312) 459-0210)



Catalog Group  
**MOORE  
BUSINESS  
CENTER**

A Division of Moore Business Forms

P.O. Box 20  
Wheeling, IL 60090  
Dept. 119411

**YES!** Send me a FREE 80-page, full-color copy of the Summer 1983 Moore Catalog

YOUR NAME	TITLE	BUSINESS PHONE
COMPANY NAME		
ADDRESS		
CITY	STATE	ZIP
COMPUTER MAKE AND MODEL		
TYPE OF BUSINESS		NO. OF EMPLOYEES

Whole List	Before Sublist					After Sublist					Whole List
	1	2	3	4	5	1	2	3	4	5	
L W D U P T H N E A K	L	W	D	U	P	K	H	D	E	A	K H D E A L W N U P T
	T	H	N	E	A	L	W	N	U	P	
	K					T					

Figure 1: Shellsort creates five sublists when distance  $D=5$ ; each sublist is sorted with a Shuttlesort. Before refers to the data order before the Shellsort pass; After refers to the order resulting from the Shellsort pass.

Whole List	Before Sublist			After Sublist			Whole List
	1	2	3	1	2	3	
K H D E A L W N U P T	K	H	D	E	A	D	E A D K H L P N U W T
	E	A	L	K	H	L	
	W	N	U	P	N	U	
	P	T		W	T		

Figure 2: These three Shellsort sublists result when distance  $D=3$ . The Before list is identical to figure 1's After list; it results from the  $D=5$  Shellsort.

If Shuttlesort could move items more than one position at a time, it might be more efficient. One way to make larger moves is to compare items farther apart than just one location. This is the idea behind Shellsort; reference 7 discusses Shell's original work.

### Shellsort

Shellsort works by dividing the list of data into sublists. Shuttlesort is used to order each sublist and finally merge them into the final, completely sorted list. The final pass of Shellsort is identical to a Shuttlesort. Earlier passes try to move small values near the top of the list in large steps. On the final (Shuttlesort) pass values don't have far to move.

To demonstrate Shellsort, we use the larger list of data shown in figure

1. Instead of comparing immediate neighbors, the algorithm starts by comparing items some fixed distance apart, 5 for the first figure 1 pass. The Before section shows the original list of data and the five sublists that result when items five locations apart are compared. The algorithm effectively applies a Shuttlesort to each of these sublists. The After section shows the now-ordered sublists and the resulting whole list at the end of the pass. Note that only six comparisons have managed to move letters in the first half of the alphabet to the top half of the list and letters in the last half of the alphabet to the bottom half of the list.

The next pass uses a distance of 3, resulting in the three sublists shown in figure 2. Each sublist is sorted (using Shuttlesort) with the result in

the After section. The first quarter of the list now contains letters from the first quarter of the alphabet and so on. The list becomes partially ordered very quickly.

The final pass uses a distance of 1, resulting in only one sublist, the entire list of values. Clearly, applying Shuttlesort to that list assures that the final result is completely ordered. Note the small distance items need to move in this final pass to find their final position; no item need move more than two locations.

The changes required to convert Shuttlesort to Shellsort are minimal. First, lines 50 through 200 in listing 1 are modified to use distance  $D$  rather than the fixed distance 1. After each pass, the value of  $D$  reduces to  $\text{INT}(D/2)$  at line 230 of listing 2. When  $D$  is reduced to 0, we know that the pass just completed was the Shuttlesort on the whole list. Thus, the sort is complete.

### Determining Distances

How do we choose the distances? Although the algorithm's performance is known to be rather sensitive to the distances, there is no known way to select the ones that guarantee minimum sort time. However, the initial distance and all subsequent distances should be odd. One of the most commonly used set of distances with this property was developed by Hibbard (see reference 3). He uses an initial distance of

$$D = 2^{\text{INT}(\text{LOG}(N)/\text{LOG}(2))} - 1$$



Number of Items	Shuttlesort		Shellsort	
	Number of Comparisons	Number of Exchanges	Number of Comparisons	Number of Exchanges
32	280	251	159	70
64	1050	992	411	180
128	4186	4063	1142	555
256	16,802	18,552	2515	1108
512	64,781	64,255	6395	3089
1024	264,233	263,223	15,740	8131
2048	1,032,218	1,030,176	34,994	17,698
4096	4,141,646	4,137,563	84,969	46,277

**Table 2:** Comparing Shellsort with Shuttlesort illustrates the former algorithm's superiority.

**Listing 2:** Comparing this Applesoft version of Shellsort with the listing 1 program demonstrates that only two lines—45 and 230—need be added to a Shuttlesort program to form Shellsort. The variable *D* generalizes the distance between comparisons; this distance is fixed at 1 in Shuttlesort.

```

10 DIM X(1024)
19 REM  BRANCH TO GENERATE N RANDOM VALUES
20 GOSUB 1000
45 D = 2 ^ INT ( LOG (N) / LOG (2) ) - 1
50 FOR I = 1 TO N - D
60 FOR J = I TO 1 STEP - D
70 IF X(J) < = X(J + D) THEN 200
80 TX = X(J):X(J) = X(J + D):X(J + D) = TX
100 NEXT J
200 NEXT I
230 D = INT ( D / 2 ): IF D > 0 THEN 50

```

Each subsequent distance is

$$D = \text{INT}(D/2)$$

(Note that  $\text{LOG}(N)/\text{LOG}(2)$  is the base 2 logarithm of *N*.) The values of *D* are always of the form  $2^P - 1$  for some positive integer *P*. For example, if we have 100 items to sort, the initial *P* is 6 and the initial *D* is 63. In subsequent passes, *D* equals 31, 15, 7, 3, and 1. (For our little example, we should have used an initial distance of 7, but we chose 5 to make it a bit more interesting.)

We now have all the parts necessary for the algorithm. The Apple BASIC program is in listing 2.

### Performance Evaluation

We claimed in the beginning that Shellsort was well worth the minor programming changes. The acid test of this is the time required to sort. It

often turns out that an algorithm that has superior theoretical performance realizes its advantage over another algorithm only for very large values of *N*. For example, suppose we code an algorithm that is order *N*—that is, doubling the number of items to sort only doubles the time. But suppose it takes 1000 seconds to sort 100 items, while our order *N*-square algorithm takes 100 seconds. Sorting 200 items requires 2000 and 400 seconds respectively; sorting 500 items requires 5000 and 2500 seconds respectively. Only when we sort more than 1000 items will the order *N* algorithm be superior. In such situations, the choice of algorithm depends heavily on the number of items to sort.

Therefore, we compared timings for Shuttlesort and Shellsort for several machines and languages. In addition to time measurements, we also counted the number of exchanges and comparisons required by each

method. While the time will certainly differ for different hardware, the counts will not, so they provide insight into algorithm efficiency independent of hardware/software considerations.

Another measure for a sort algorithm is the amount of memory required. Each method requires only minimal extra memory beyond the list to be sorted. Furthermore, this extra space does not increase as the number of items increases. Thus, space use is order *N*. In contrast, algorithms that are slightly more efficient than Shellsort typically require significant extra space. For example, some require space for pointers—possibly two pointers per item.

For the performance comparisons, random real values were generated. This probably represents the most challenging type of data for both algorithms—with integers or strings, duplicate values are more likely to occur and sort time would be reduced for both.

Table 2 shows the number of comparisons and exchanges for the two algorithms for lists of size 32, 64, . . . 4096. The superiority of Shellsort is obvious throughout. Scanning the Comparisons and Exchanges columns under Shuttlesort reveals its order *N*-square nature—when *N* doubles, the number of operations increases fourfold. Also note how the number of exchanges is close to the number of comparisons. Exchanges are expensive—they require three LET statements.

The rate of growth of the number of comparisons and exchanges for

Number of Items	Sort time in seconds for:	
	Shuttlesort	Shellsort
32	7	3.5
64	26	7.5
128	103	20
256	413	51
512	(1652)	121
1024	(6608)	295
2048	(26,433)	(706)
4096	(105,730)	(1692)

Table 3: Comparison of sort times for Shuttlesort and Shellsort algorithms written in Applesoft BASIC support table 2's indication of Shellsort's superiority. The numbers in parentheses are estimated times.

Shellsort is far slower. Instead of an order  $N$ -square increase, it is approximately proportional to  $N^{1.26}$ . Thus, doubling  $N$  results in an increase of roughly 2.4 times in the number of operations. Furthermore, the number of exchanges is much less than the number of comparisons, usually about half. (Note that different data produce different counts, but the relationships remain approximately equal to those we measured.) These counts show the effectiveness of early passes in moving items a long way up and down the list with few comparisons and exchanges.

From the counts of comparisons and exchanges, Shellsort should be much faster. It is: table 3 shows sort times in seconds for the two algorithms using Applesoft interpreted BASIC. (Some of the times have been estimated because they are so long. The estimation method is described in the next section.) As you can see, as  $N$  grows Shuttlesort becomes impractical very quickly:

sorting just 256 values requires almost 7 minutes. By comparison, Shellsort can order four times as many values, 1024, in less time. Even though the Apple has enough memory to sort 4096 values, do you have the patience to wait out a Shuttlesort? The estimated time is about 29 hours.

Using Shellsort, it is practical to sit at the machine while it sorts 1024 values. Sorting 2048 values calls for a coffee break (12 minutes), while you might schedule a sort of 4096 values for a quick lunch (about 28 minutes).

#### Predicting Sort Times

It is quite easy to develop simple and accurate estimates for sort times for both algorithms. Based on the order of the methods, estimates of the following forms are used:

$$\text{Time(Shuttlesort)} = C N^2$$

$$\text{Time(Shellsort)} = K N^{1.26}$$

The constants  $C$  and  $K$  are estimated

from actual times from table 3. The estimates are usually better if larger values of  $N$  are used. For example, using  $N=256$  to estimate  $C$  gives

$$C = 413/256^2 = 0.006302$$

Using this value for  $C$  gives an estimate for  $N=128$  of

$$\begin{aligned} \text{Time(Shuttlesort)} &= \\ 0.006302 \cdot 128^2 &= 103.25 \end{aligned}$$

agreeing with our observed time. The estimate for 1024 items is

$$\begin{aligned} \text{Time(Shuttlesort)} &= \\ 0.006302 \cdot 1024^2 &= 6608 \text{ seconds} \end{aligned}$$

or almost 2 hours.

For Shellsort, the estimated  $K$  using  $N=1024$  is

$$K = 295/128^{1.26} = 0.0475$$

The estimate for sorting 128 values is

$$\begin{aligned} \text{Time(Shellsort)} &= \\ 0.0475 \cdot 128^{1.26} &= 21.5 \end{aligned}$$

agreeing fairly well with the observed 20 seconds.

#### Pushing Shellsort Further

Many algorithms can be "tuned" to give additional performance improvement, although often no improvement in order of performance. This is the case with Shellsort. We can reduce times by about 25 percent with the following change: when we find a value that is out of place, say  $X(I+D)$ , it is stored in  $TX$ .  $TX$  is then

## JAY WEINBERG: LIVING PROOF YOUR CONTRIBUTIONS COUNT.

These days, Jay Weinberg's most difficult battles take place on the tennis court. Five years ago, he had a different kind of fight on his hands: against one of the toughest forms of cancer.

Cancer research and treatment have made Jay's kind of recovery possible for almost 2 million people. Which means that your donations have helped buy Jay Weinberg a very beautiful gift: his life.

**CANCER CAN BE BEAT.**

**American  
Cancer Society** 



**Listing 3:** In an Applesoft version of Super-Shellsort, exchanges are delayed so that fewer LET statement executions are required than in the usual Shellsort algorithms. This program reduces sort times by about 25 percent compared with the listing 2 program.

```

10 DIM X(1024)
19 REM  BRANCH TO GENERATE N RANDOM VALUES
20 GOSUB 1000
45 D = 2 ^ INT ( LOG (N) / LOG (2) ) - 1
50 FOR I = 1 TO N - D
55 IF X(I) < = X(I + D) THEN 200
57 TX = X(I + D):X(I + D) = X(I)
58 IF I < = D THEN X(I) = TX: GOTO 200
60 FOR J = I - D TO 1 STEP - D
70 IF TX > = X(J) THEN 120
80 X(J + D) = X(J)
100 NEXT J
120 X(J + D) = TX
200 NEXT I
230 D = INT (D / 2): IF D > 0 THEN 50

```

compared up the list, moving displaced values down by distance D until the proper place for TX is found. Thus, moving a value up in M steps requires only M-1 moves and one exchange instead of M exchanges. (This improvement is discussed in reference 3.) This version of the program appears in listing 3.

This tuning reduces the time to sort 1024 values from 295 seconds to 223 seconds. The time to sort 4096 values is now about 20 minutes compared to about 28 minutes.

In theory, there are quicker algorithms than Shell's. For example, based on statistics reported in reference 5 (page A41), Quickersort

seems to be about three times faster. However, Quickersort involves significant manipulation of pointers and transfers of control, operations that are especially expensive with an interpreter. We once tried Quickersort on an 8080-based microcomputer using Microsoft BASIC. The results were miserable—the seconds required by Shellsort became minutes with Quickersort. We have not repeated the experiment with the Apple.

### The Apple versus IBM and Two of the Dwarfs

How powerful is the Apple? What is the performance gain from compiling? How do BASIC and FORTRAN compare in performance? We did not embark on an exhaustive performance comparison, but having several computer systems available and for some time having harbored suspicions about Grosch's law (explained later) we coded Shuttlesort and Shellsort on several machines using several languages:

- Apple with Applesoft BASIC
- Apple with Microsoft BASIC compiler
- IBM Personal Computer with Microsoft BASIC interpreter
- Digital Equipment Corporation VAX-11/780 with BASIC compiler
- DEC VAX with FORTRAN (compiled)
- Control Data Corporation Cyber 170-750 with BASIC compiler
- CDC Cyber with FORTRAN (optimizing FTN5 compiler)

Table 4 summarizes the results and shows the ratios of sort times for 1024 values using Shellsort. The underlined values represent comparisons that are probably the most accurate reflections of machine power as opposed to comparison of languages or compilers/interpreters. For example, row 2 indicates that the VAX is about 47 times faster than the Apple (both using compiled BASIC). The CDC is somewhere between 2.6 and 4.3 times faster than the VAX depending on whether we compare BASICs or FORTRANs.

If you have a BASIC compiler for your Apple, you probably know

## HARDWARE/SOFTWARE-WHOLESALE!

Purchase your Hardware and Software directly from an OEM/Systems Integrator. Take advantage of our buying power! We stock a full line of Board Level Components, Software, and Peripherals. Call for your needs. We'll give you the Lowest Prices, and the Technical Support and Know-How we are quickly becoming well-known for. Satisfied Customers Nationwide! The Nation's Custom Systems House for Business, Education, Science.

SOME OF OUR CURRENT SUPER-SPECIALS

**IMMEDIATE DELIVERY! MORROW MICRO DECISION ALL CCT TESTED! MORROW TERMINAL- \$499**  
**1 DRIVE-\$819 2 DRIVE-\$1149 2 DS DRIVE-\$1299**

MICROSOFT MBASIC-8" CP/M-\$199 • ASHTON-TATE dBASE II \$459  
 MICROPRO WORDSTAR-8" CP/M-\$259 • WYSE 100 TERMINAL-\$769  
 MITSUBISHI DSDD 8" DRIVES-FULL OR HALF HEIGHT-\$449 (THE BEST)  
 SIEMENS SSDD 8" DRIVES-\$239 • OKIDATA 82-\$419 / 83-\$679 / 84-\$1029

BOARDS/SYSTEMS **COMPUPRO** CUSTOM BUILT BUSINESS SYSTEMS

LIMITED SPECIAL: SYSTEM 816A-\$4395 816B-\$5595 816C-\$7195

M-DRIVE CP/M-128K-\$959 • DISK 1 W/CP/M-\$489 • M-DRIVE H-\$1395  
 8085/88-\$319 • 8086/87-\$519 • CPU-Z-\$229 • DISK 1-\$369 DISK 2-\$599  
 INTERFACER 1 OR 2-\$199 • INTERFACER 3-5-\$449/3-8-\$519 • INTERFACER 4-\$279  
 RAM 17 (12 MHZ)-\$359 • RAM 16 (12 MHZ)-\$399 • SYSTEM SUPPORT 1-\$309  
 ENCLOSE 2-DESK-\$659/RACK-\$699 • RAM 21-\$849 • CPU 68K-\$519  
 CP/M-\$149 • CP/M 86-\$259 • MP/M 8-16-\$769 • HARD DISKS, CABLES, ETC.-CALL US!

SIEMENS DUAL 8" SSDD SUBSYSTEM-\$699 MITSUBISHI DUAL 8" DSDD SUBSYSTEM-\$1099 w/AM Cabling!  
 20 MEG FUJITSU HARD DISK SUBSYSTEM W/DISK 2, BIOS, & ALL CABLES-\$3199

WE ARE THE LARGEST IN THE CUSTOM CONFIGURATION OF COMPLETE STATE-OF-THE-ART S-100 SYSTEMS, AT PACKAGE PRICING, WITH INTEGRATION, BURN-IN & PROGRAMMING. WE CUSTOM BUILD COMPUPRO SYSTEMS/HARD DISK SYSTEMS FOR BUSINESS APPLICATIONS.

WE NOW FEATURE A SPECIAL LEASE/OPTION AND FINANCING ON BUSINESS SYSTEMS-CALL!

**WOW!** 55 SPECIALS 55 GOOD THROUGH MONTH END. As supplies last. Rainchecks may be given if possible. Cash Sales Only!

## CUSTOM COMPUTER TECHNOLOGY

1 CRAFTSMAN COURT, BOX 4160, SEDONA, ARIZONA, 86340 (602) 282-6299

PRICES & AVAILABILITY SUBJECT TO CHANGE. ALL PRODUCTS NEW AND CARRY FULL MANUFACTURER'S WARRANTIES. CALL FOR CATALOGS. FREE TECHNICAL HELP TO ANYONE. WE CAN CONFIGURE BOARDS & SOFTWARE FOR YOUR SYSTEM. PLUG-IN & GO. AZ RESIDENTS ADD APPLICABLE SALES TAX. CP/M® DIGITAL RESEARCH

about the significant speed improvements it affords. Using the Microsoft BASIC compiler with integer variables for everything except the actual array of values to be sorted, 1024 values can be sorted in 33 seconds, and 4096 values require 166 seconds (there went your coffee break). The average improvement is a factor of about 7.5.

Now, what about Grosch's law? Herbert Grosch hypothesized a relationship between computer cost and performance that claimed a quadrupling of performance for a doubling of cost (a quadratic relationship). This seemed to hold true for many years, especially if performance was based on measures of raw computing power such as add times. Because internal sorting requires primarily brute computational power, as opposed to input/output operations, our performance measures should be a fair test of the law.

In order to make some sense of cost/performance trade-offs, we calculated for each machine the following quantity:

	Apple BASIC Com- piled	IBM PC BASIC	VAX BASIC	VAX FOR- TRAN	CDC BASIC	CDC FOR- TRAN
Applesoft	7.6	<u>1.46</u>	360	1100	952	4758
Apple BASIC Compiled		.19	<u>47</u>	145	125	626
IBM PC BASIC			247	753	<u>652</u>	3259
VAX BASIC				3.0	<u>2.6</u>	13.2
VAX FORTRAN					.87	<u>4.3</u>
CDC BASIC						5.0

Table 4: These relative performance comparisons of various hardware/software combinations are based on sorting 1024 values with Shellsort. Table entries are the ratio of the row-system sort time to the column-system sort time; for example, the VAX BASIC system runs Shellsort 47 times faster than the Apple BASIC Compiled system does. Underlined values are those most appropriate for comparisons of the relative power of different hardware.

System	Cost	Cost Index
Apple, BASIC	\$1500	1.00
VAX, BASIC	\$100,000	1.42
VAX, FORTRAN	\$100,000	0.47
CDC, BASIC	\$1,000,000	5.33
CDC, FORTRAN	\$1,000,000	1.06

Table 5: A comparison of the cost index of various computer systems.

# \*LASER™

micro systems inc.

Administrative Offices  
1321 N.W. 17th  
PORTLAND, OR 97209  
Telex: 340270  
Cable: WILL DPT PTL

Sales Office  
1885 W. Commonwealth  
Suite G  
FULLERTON, CALIF 92623  
714-525-7474

## OTHER PRODUCTS AVAILABLE NOW OR COMING

- Disc Drive Interface Card
- Printer Interface Card
- 16K Ram Card
- 5 1/4 "floppy" disc
- Monitors
- Bare 55A Drive
- 5MB Hard Disc Drive
- IBM 55B Drive

DISTRIBUTOR INQUIRIES WELCOME



- \* Teac drive 55A
- 48TPI, 163 KB formatted single side
- \* 40 Track
- \* Assembled and Tested in U.S.A.

# 5 1/4" SLIM LINE



cost index =  
cost of machine X / cost of Apple

performance of X / performance  
of Apple

Performance is 1/time to sort 1024 items. The results are shown in table 5. The cost index tells how many Apples you could buy for each unit of Apple performance obtained when using specific machine-language combinations. Even more to the point, if you could divide a job into pieces that

could be run simultaneously, this indicates that in all cases except the VAX/FORTRAN combination it would be cheaper to buy a bushel of Apples in place of the larger machine. For example, with the CDC/BASIC combination you could buy 5.33 Apples for each unit of Apple performance that the CDC provides. Because the CDC/BASIC combination sorted 1024 values 125 times faster than the Apple, you would spend  $125 \times \$1500 = \$187,000$  in Apples versus about \$1,000,000 for

the CDC.

Although this is certainly a crude comparison, it is quite interesting. If Grosch's law held, we should see the cost index dropping rapidly with increasing machine cost. Because the CDC costs about 667 times as much as the Apple, Grosch's law implies that its performance should be about 444,444 times better, that is,  $(1,000,000/1500)^2 = 444,444$ . In fact, the CDC performance is at best about 626 times better.

## Conclusions

Small changes in a program can yield dramatic performance gains. About the only good reason for ever using one of the order N-square sorting algorithms is for illustrative or educational purposes. Minor tuning can also give significant improvements.

If you do a significant amount of numerical computing and are using an interpreted BASIC, you should probably look into a compiler. The performance improvement is much greater than the gain possible by moving to a faster chip (e.g., a Z80 or 8088 in place of the 6502).

Finally, if you have a spare quarter of a million dollars, you can purchase a machine that will give you a proportional performance improvement over the Apple, but don't expect to reap much in the way of economies of scale. ■

## References

1. Association for Computing Machinery. *Communications*.
2. Association for Computing Machinery. *Collected Algorithms of the ACM*
3. Hibbard, T. N. "An Empirical Study of Minimal Storage Sorting." *Communications of the ACM*, Vol. 8, No. 5, pp. 206-213.
4. Knuth, D. E. *The Art of Computer Programming*. Reading, MA: Addison-Wesley, 1968, 1969, 1973.
5. Lorin, Harold. *Sorting and Sort Systems*. Reading, MA: Addison-Wesley, 1975.
6. Magalhaes, G. C. and A. L. Furtado. "A Linear Time Sort Algorithm Applicable to Data Base Management." *Monographs in Computer Science and Computer Applications*, No. 13/76, Pontificia Universidade Catolica do Rio de Janeiro.
7. Shell, D. L. "A High Speed Sorting Procedure." *Communications of the ACM*, Vol. 2, No. 7, pp. 30-33.

# Martin Marietta Aerospace

## Data Processing Opportunities

Martin Marietta Aerospace, NASA's prime Contractor for the Space Shuttle External Tank has immediate openings for Data Processing professionals. Because we actually manufacture the external tank, you'll get to see the actual results of your efforts.

### COMPUTER PROGRAMMER/ ANALYSTS

Immediate opportunities exist for individuals experienced in:

- UNIVAC 1100
- ASC11 COBOL
- DMS 1100
- DDL, SDDL, DMU
- DML, QLP
- DPS 1100, TIP
- D/B Editor

### • APPLICATION EXPERIENCE

Shop floor control,  
Scheduling, Manufac-  
turing, Inventory,  
Purchasing, Config-  
uration Management,  
Quality Engineering.

### • DATA BASE OPENINGS

Analyst, Design, Ad-  
ministrators with above  
hardware, software and  
applications experience.

These opportunities exist at our Michoud Assembly Facility located in suburban East New Orleans.

*Qualified candidates interested in learning more about these opportunities at Martin Marietta should forward resumes, including salary history to Martin Marietta Aerospace, Denver Glazier, BYTE-51, P.O. Box 29304, New Orleans, Louisiana 70189. We are an equal opportunity employer, m/f/h.*

**MARTIN MARIETTA**

# Maryman INDUSTRIES, INC.

In Texas Orders  
Questions & Answers  
1-713-392-0747

22511 Katy Freeway  
Katy (Houston) Texas 77450

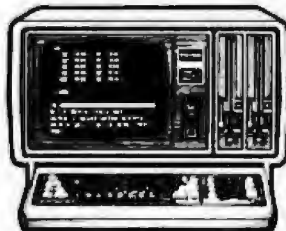
To Order  
1-800-231-3680  
800-231-3681

## SAVE BIG DOLLARS ON ALL TRS-80<sup>®</sup> HARDWARE & SOFTWARE

TRS-80<sup>®</sup> BY RADIO SHACK. Brand new in cartons delivered. Save state sales tax. Texas residents add only 5% sales tax. Open Mon.-Fri. 9-6, Sat. 9-1. We pay freight and insurance. Come by and see us. Call us for a reference in or near your city. Ref: Farmers State Bank, Brookshire, Texas.

### WE OFFER ON REQUEST

- Federal Express (Overnight Delivery)
- Houston Intercontinental Airport Delivery (Same Day)
- U.P.S. BLUE (Every Day)
- References from people who have bought computers from us probably in your city. We have thousands of satisfied customers. **WE WILL NOT BE UNDERSOLD!**



No Tax on Out of Texas Shipments!

**Save**  
**10% 15%**  
**OR MORE**

Telex 77-4132 (Fleks Hou)

\* TRS-80 is a Registered Trademark of Tandy Corp

### WE ALWAYS OFFER

- We accept Master Card, VISA, and American Express.
- We use Direct Freight Lines. No long waits.
- We always pay the freight and insurance
- Toll free order number
- Our capability to go to the giant TRS-80<sup>®</sup> Computer warehouse 5 hours away, in Ft. Worth, Texas, to keep you in stock.

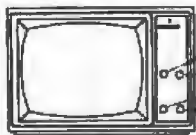
ED McMANUS



JOE McMANUS



### 12" B&W MONITOR



Contrast  
Power/Bright  
V-Hold  
H-Hold

VIDEO 100 by AMDEK

FULL  
FACTORY  
WARRANTY **\$79<sup>95</sup>**

for APPLE

### 16K RAM CARD

Language Transparent  
COEX FACTORY  
WARRANTY **\$59<sup>00</sup>**

### 5 1/4" Floppy DISKETTES

All Certified-100% Guaranteed

BOX of 100... **\$149<sup>00</sup>**  
Above with  
Hub Rings..... **\$169.00**

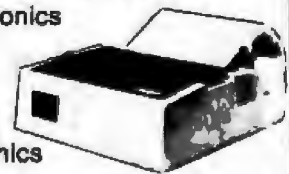
### FLOPPY DISK DRIVE

From Fourth Dimension Systems  
with • Track Zero Micro Switch  
• DOS 3.2.1 & DOS 3.3  
• CP/M and PASCAL

DESIGNED  
FOR YOUR **\$249<sup>00</sup>**  
APPLE™ .....  
Controller Card  
for above..... **\$99.00**

## COEX 80-FT DOT MATRIX PRINTER

- Interface with Apple™, Centronics RS-232, IEEE-488
- 9x7 Dot Matrix, 80 CPS, Bi-Directional Printing
- 2K Buffered Memory
- 80, 96, 132 Columns, Graphics and Block Printing
- Selectable Char Pitch, Line Spacing and Feed



COEX Interface Card to APPLE **\$39<sup>95</sup>**

**\$299<sup>00</sup>**

## VISION-80<sup>®</sup> \$249<sup>00</sup>

80x24 Video Display Card  
Vista Computer Company's new Vision-80 board is a sophisticated yet easy to use video display card for the Apple™ computer.

### PARALLEL INTERFACE EPSON TO APPLE

New From **\$39<sup>95</sup>** CABLE INCLUDED

### PROTOTYPING CARDS

for APPLE... **\$19.95**  
for I.B.M..... **\$49.95**

### EXTENDER CARDS

for APPLE... **\$16.95**  
for I.B.M..... **\$19.95**

"Have You Kissed Your Computer Lately?"

# Components Express, Inc.

1380 E. Edinger • Santa Ana, Calif. 92705 • 714/558-3972  
Terms of Sale: Cash, Checks, Credit Cards, M.O., C.O.D. Calif. residents add 6% sales tax.





# *"What can Lanier systems do for my company over the next five years?"*

To get the best value in office automation equipment, you need a system that allows you to buy just the right products and configurations for your office today. No more. No less. But your needs may change. So you need a system that can adapt to those changes. A system like Lanier.

In 1977 Lanier designed the first fully programmable word processor. So that our systems would never become obsolete. Instead, they'll keep increasing in capabilities and value, expanding with you as you grow. And they'll continue giving you the best performance for the best price.

**"What gives Lanier such a good price/performance ratio?"**

**"It's our tailor-made configurations. With Lanier, you can buy a system designed specifically for your users' current needs. With the right models and capabilities. Our flexibility means you don't overspend for excess capacity. It also means your users won't have to compromise by adapting to inappropriate systems. And since all our equipment is plug compatible, you won't have to replace whole systems if you want to expand. Just add on what your users need."**

**"Just how expandable are Lanier's systems?"**

**"There's no limit. With Lanier, you can start out**

**with standalone units and a variety of software capabilities. Then upgrade to a shared logic system, which keeps costs down by avoiding redundant pieces of hardware. Or, for users who need a common data base, we have shared resource systems. The transition is easy because recorded media is transferable from one configuration to another and documentation procedures are the same. However fast you grow, Lanier can keep pace with you. All the way to a fully integrated office automation system."**

**"When you enhance Lanier products, how do I know you'll anticipate what my users need?"**

**"We're known for doing just that. Lanier has a widely installed base. We're constantly in touch with people in multinational companies. We even conduct customer seminars to keep abreast of your changing needs. Drawing from this input, we can anticipate your future requirements with technological changes and improvements, implementing them smoothly and quickly. In all cases keeping user skills easy to learn."**

# "Increase in value."

Tom Anderson, National Marketing Manager,  
Electronic Office Systems Division

Office automation equipment is more than a purchase. It's an investment.

That's why you should consider Lanier. The return on your investment begins the day your Lanier systems are installed. As you grow, we make sure your investment appreciates in value with plug compatible products, easy to use capabilities and new technologies. And we make sure your equipment is running at peak performance with our guaranteed service and support. Which makes Lanier a very wise investment.

Send us this coupon, or call Jennifer Scott at (800) 241-1706 for more information about Lanier's electronic office systems. Except in Alaska and Hawaii. In Georgia, call collect: (404) 321-1244.

April '83 Byte 4 76 B D3

Send to:  
Lanier Business Products, Inc.  
1700 Chantilly Drive N.E.  
Atlanta, GA 30324  
Attn: Jennifer Scott

Name	
Title	
Phone	Best time to call
Fax	
Address	
City	Zip

We'll change your mind about the future  
Right here and now.

**LANIER**



## News and Speculation about Personal Computing

Conducted by Sol Libes

### Random Rumors:

American Bell is reportedly readying a desktop workstation computer running the Unix System 5 operating system; it may be introduced this summer. The firm is also expected to introduce a mini-computer in the same class as Digital Equipment Corporation's (DEC's) VAX, as well as several personal computer products. There are rumors that American Bell has had discussions with Fortune Systems to purchase manufacturing rights to the Fortune 32:16 system (see page 82 of this issue for Steven H. Barry's review of the 32:16). . . . Word has it that DEC is working on a desktop version of the VAX; already DEC has produced a "PDP-11-on-a-chip."

Apple Computer Inc. is believed to be working on a DOS (disk operating system) with a file format that will allow files to be moved between the Apple II, Apple IIe, Apple III, and Lisa.

Pick Systems may be close to releasing a version of its popular Pick Operating System for the IBM Personal Computer. . . . Several local telephone companies are reportedly seeking to sell personal computers in their telephone stores. . . . There are rumors that several low-cost portable computers are due here from Hong Kong and Taiwan. The portable market appears to be the hottest, considering the number of new units being introduced this year.

### Commodore News:

Commodore appears to have scrapped its 16-bit microprocessor, in development for over four years, and has entered into an agreement to manufacture the Zilog Z8000 and related peripheral chips.

Apparently, Commodore will use the Z8000 in a new 16-bit personal computer because the agreement allows the company to use the Z8000 chip in its own products only and precludes Commodore from selling it on the open market. The fact that both CP/M and an excellent version of Unix developed by Zilog are already available for the Z8000 may have prompted Commodore's decision; however, little applications software is available for that device.

### Apple Doings:

At Apple Computer's January stockholders' meetings, Apple formally introduced the Lisa and Apple IIe (see Gregg Williams's review "The Lisa Computer System" and Robin Moore's "Apple's Enhanced Computer: the Apple IIe," pages 33 and 68, respectively, in the February 1983 BYTE). The company disclosed that the last month of Apple II Plus sales (December 1982) was the best they ever had (45,000 units were sold) and that a total of 750,000 Apple IIs had been sold by the end of that month.

Steve Jobs, Apple chairman, announced that Apple would institute a plan to donate 10,000 Apple IIe systems to accredited schools in California. A similar effort to receive federal tax credits for a national program of gifts to schools failed to get through Congress last year.

Apple has also made a request to the U.S. International Trade Commission to investigate "unfair" competition by manufacturers in Hong Kong, Taiwan, Singapore, and Switzerland. Apple alleges patent and copyright infringement and is asking the ITC to bar imports of these Apple II look-alikes.

Despite the fact that the Customs Service has already seized a large number of these imports, more and more U.S. companies are importing them.

### Radio Shack News:

Tandy has announced that it will replace the present operating system used on the Model 16 with Xenix, the Unix-like operating system from Microsoft. It will be furnished to all owners of previously sold Model 16s. This will more than double the number of Xenix users. To run Xenix, a user will need 256K bytes of memory and a hard disk. The standard Unix utilities and software tools are extra. Thus a base-priced system will be over \$9000; still a low price for a Unix system. The two companies are also developing a single-user, floppy-disk-based Xenix for mid-1983.

Finally, Tandy, the last hold-out among major suppliers, has agreed to furnish Digital Research's CP/M operating system for the new TRS-80 Model 12 system.

### Is Integrated Software the Key to Success?

The next generation of personal computers will be here shortly, and it will be characterized by highly integrated software/hardware systems. The first two such systems have already been demonstrated and should be in users' hands in the next two to three months. I am talking about the Apple Lisa, Visicorp's Visi On system, and a new unnamed operating system I am expecting Microsoft to announce shortly.

The new-generation systems offer a high degree of integration between applications software, operating-system software, and hardware. As a

result, these systems will create an applications environment. Their common distinctive features are the new user interface, integration of applications programs, and greater reliance on graphics. Up until now, user interfaces have been geared to the programmer, a highly trained user willing to spend many hours studying cryptic manuals; but these new systems are designed with a degree of simplicity rarely seen before; networking and integration of multiple applications such as word processing, data handling, and spreadsheet use are also considered important. Many of these concepts were promoted by Xerox in its Alto system (built for internal use by researchers at Xerox's Palo Alto Research Center) but it now appears that personal computer designers will really bring them into wide use.

These systems encourage the user to view the graphics display as a desktop. Graphic representations of familiar objects (called icons) are visible on the desk, including sheets of paper on top of one another, in and out baskets, a mailbox, file folders, a printer, etc. These are actually windows allowing the user to view simultaneously the execution of multiple applications programs. Users can rearrange the overlapping papers to their hearts' delight and can point to a graphics representation of a desired function using a mouse. There is one icon that is always present, the Help icon. (The Visi On system as implemented on the IBM Personal Computer, with limited graphics capability, uses labeled, highlighted boxes instead of icons.)

Visicorp will no doubt be a leader in this area, if its product lives up to the recent

demonstrations made at shows around the country. With its applications packages of Visicalc, Visidex, Visi-file, Visiplan, Visiword (the new word processor), and a relational database manager (in development) integrated under Visi On (acting as the window manager), Visicorp appears to have the first low-cost system that will work on many different machines. Visihost, similar to the BIOS section of CP/M, acts as the interface software module to accommodate different hardware configurations. Visicorp is promising versions for the IBM Personal Computer and DEC professional computer initially, with versions expected to follow for other machines, including Unix-based machines.

Visi On will probably not be available until mid-summer. Experts who have seen the limited demonstration are impressed but question whether the actual product can run as fast. Visicorp has released few details about the system, but I believe that on the IBM Personal Computer it will require 512K bytes of memory and a hard disk. Add the cost of the software and mouse from Visicorp, and it is likely that the complete system will cost more than the Apple Lisa. Visicorp is not too concerned about this because it expects that most Visi On systems will be sold to people who already have IBM Personal Computers or DEC machines and are looking to upgrade their systems.

The Lisa, with its higher-resolution graphics and ability to run concurrent applications programs (Visi On supports only single tasks) and its integrated local-area networking facilities (still a question mark with Visi On), will most likely to appeal to businesses looking to purchase a complete system. However, there are still a lot of unknowns at this point, and it will be most interesting to watch how the competition develops.

The Apple Lisa will be sold with six integrated software

packages for just under \$10,000. Apple furnished prototype machines to Unisoft, Microsoft, and Digital Research, and the companies have already demonstrated Uniplus, Xenix, and CP/M-68K operating systems on the Lisa (with limited graphics). Apple has demonstrated Smalltalk on the Lisa and plans to release it. The company appears to be following the same policy that made the Apple II a huge success. Apple has made detailed information available to independent software houses and will soon offer a toolkit for the Lisa the way it did for the Apple II.

Lotus Development Corporation, with its 1-2-3 package, which integrates a sophisticated spreadsheet with many advanced features, a database manager, and a word processor, will also be a contender in this arena. And Microsoft, with its new version of MS-DOS, Multiplan (one of the most powerful spreadsheets currently available), the Multi-Tools family, and Xenix compatibility, is also expected to be a strong competitor in this area.

Digital Research, which recently added a SIGGRAPH-standard compatible graphics interface to CP/M and improvements such as concurrency and memory- and disk-management features, still relies on independent vendors for applications software; this has resulted in a distinct lack of integrated software under CP/M. (SIGGRAPH is the Association for Computing Machinery's Special Interest Group on Graphics.) Use of the standard will make it easier for outside software vendors to integrate their software; still, Digital Research seems to be missing the integrated-software boat.

It's still questionable whether the \$10,000-and-up prices for these integrated systems will limit their acceptance in the marketplace; after all, Xerox tried to pioneer this area two years ago with the Star (at a \$16,000 base price) and was

not successful. Will users be willing to pay \$10,000 to \$12,000 for these features? It may be that Apple is really counting on its Macintosh system, due for introduction later this year, that will have some of the Lisa features and a lower price.

**LAN Standard Endorsed:** Thirteen firms have endorsed the LAN (local-area network) standard currently being worked on by an IEEE (Institute of Electrical and Electronics Engineers) committee. Called the IEEE P802.3 draft standard for CSMA/CD (Carrier Sense, Multiple Access with Collision Detection), it integrates the Ethernet and ECMA (European Computer Manufacturers Association) specifications. The companies endorsing the proposed standard include Bridge Communications, Data General, DEC, Fujitsu America, Hewlett-Packard, Intel, Interlan, National Semiconductor, Siemens, Tektronix, 3Com, Ungermann-Bass, and Xerox.

**Prices Continue Dropping:** Toys 'R' Us, a large chain of toy stores, is opening computer sections that in some cases will occupy a quarter of a store's floor space. This is just a sign of the major changes occurring in the home computer marketplace.

The competition in the mass-merchandised personal computer market is getting fierce. I have already seen the Timex Sinclair 1000 advertised for \$66 minus a \$15 rebate (list price is \$79) and the Commodore VIC-20 for under \$135. Texas Instruments (TI), via its rebate program, has brought the model 99/4A down to under \$150, and now Atari has introduced a rebate for the model 400 that brings its price down to under \$200. The more powerful Atari 800 is now retailing for under \$500.

Mattel, Magnavox, Emerson, and Video Technology

are also entering the fray in the under-\$200 market. Emerson expects to do this by offering a keyboard attachment for the Atari 2600 video-game unit; however, Atari has announced its own keyboard for that unit. Mattel and Coleco are doing likewise for their game systems. Atari expects to double the number of stores carrying its units to 15,000 by the end of this year and to spend 50 percent more on advertising, with most going into television spots. Commodore has also dropped the price on its Model 64 and offered it for sale via mass merchandisers. The under-\$100 market, now currently dominated by Timex Computer Corporation, will soon see entries from Commodore, Sharp, and Casio.

**Personal Robotics:** Numbers of home experimenters have built personal robots during the last few years. Tod Loufbourrow, for example, wrote a book five years ago describing the construction details for his robot, which had a primitive sensory system and could respond to a limited set of commands in its master's voice. Over the last three years, several companies have introduced robotic arms controlled by personal computers; however, these are essentially expensive teaching tools, some costing as much as \$5000.

The introduction of the HERO-1 from Heath will have a profound impact on personal robotics (see "Heath's HERO-1 Robot" by Steven Leininger, January 1983 BYTE, page 86). Although still intended as an educational product, its \$1500 price (in kit form) puts it well within the range of many schools and home experimenters. Thus we can expect to see homebrewed improvements, added features, and peripherals for this and similar robotic kits; perhaps newer kits will be available at even lower cost. For example, Nolan Bushnell (founder



## SLUDER, THE COMPETITIVE EDGE

systems & subsystems since 1980  
 20-27% off list on Godbout, Lomas,  
 Teletek, and Seattle Components  
 SPECIALS - GODBOUT 816 SYSTEMS-CALL



GODBOUT 816 A&T \$8995.  
 Disk II A&T 695.  
 20MB HD 1.  
 TOTAL \$9691.

COMPLETELY INTEGRATED, ASSEMBLED & TESTED  
 COMPETITIVE EDGE BUDGET BOOT & RUN SYSTEMS  
 TELETEK w/2 floppys . . . . . from \$1995.  
 LOMAS 8086 w/2 floppys . . . . . from 3295.  
 85/88 sys w/2 floppys . . . . . from 2995.  
 Seattle w/2 floppys . . . . . from 3295.

OR, LET US CONFIGURE A SYSTEM TO YOUR NEEDS  
 GODBOUT CPU 2 6MHz \$199 20MB w/D-II & CP/M . . \$3495.  
 SEATTLE GAZELLE . . . . . 4695. 2 DSDD 8" Drs sub-sys . . .1095.  
 LOMAS 10MHz 8086 . . . . .520. Godbout 10MHz 86 or 68K . . 621.  
 DISK 1 w/CP/M . . . . .445. LOMAS LDP72 w/CPM-86 . . 415.  
 Teletext 925 . . . . .689. Teletek SYSTEMASTER . . 671.

DEALERS: GET THE COMPETITIVE EDGE, CALL OR WRITE  
 UNIVERSITY PURCHASE ORDERS ADD 5%  
 Prices subject to change. Tax & shipping extra.

CP/M is a trademark of Digital Research  
 COMPETITIVE EDGE/SLUDER (714) 895-1746  
 P.O. Box 951, Westminster, CA 92683-0951

### Model EP-2A-88 EPROM Programmer



Proven Reliability  
 Easy To Use  
 Remarkably Fast

Almost as fast as Jackrabbits  
 Recall that in Australia, two rabbits can reproduce over 13 million offspring in three years. Our EP-2A-88-2 being not quite as fast, (1105 seconds for 2716's) is capable of programming 1,892,160 Eproms in three years. Our new EP-2A-88-4 . . . Single push button control, checks if Eproms are erased, programs and verifies, retains many of the outstanding features of the EP-2A-88-2 selftest, diagnostics and audio prompt.  
 . . . And getting faster  
 The EP-2A-88-4 has typical programming times for the Intel 2764's, TI 2564's of only 50 and 80 seconds, just 100 seconds for the 27128. But that is not all since the EP-2A-88-4 can also do the 2716, 2732, 2732A, and 2532 Eproms.

Part No.	Description	Price
EP-2A-88-4	Eprom Programmer . . . . . 115V 50/60 HZ	\$550.00
	Non-standard voltage (220v, 240v, or 100v)	15.00

#### Copy Modules, Device Capability

CM-20 2732 . . . . .	\$25.00	CM-20A 2732A . . . . .	\$33.00
CM-40 2532 . . . . .	25.00	CM-50 2716, 2516 . . . . .	25.00
CM-642 2564 . . . . .	25.00	CM-643 2764 . . . . .	25.00
CM-645 27128 . . . . .	25.00	SE-64-2 Socket Expander for 2564	93.00

SE-64-3 Socket Expander for 2764, 27128 . . . . . 93.00

## Optimal Technology, Inc.

Phone (804) 973-5482

Blue Wood 138

Earlysville, Va 22936

## BYTELINES

of Atari) has formed a new company called Androbot, in Sunnyvale, California, that has announced two home robots. One is expected to sell for under \$1000 and use a radio link to a home computer; the second will be a \$2500 robot with onboard brains using three 8088 microprocessors and 3 megabytes of memory. The Robot Shack, of El Toro, California, is offering its 7-inch-high Droid for \$99 and a 38-inch-high PR-1 for \$499; both offer remote-controlled motion, speech recognition, and speech output.

We are at a point in personal robotics comparable to the situation in the early 1970s when home experimenters were building primitive computers with the Intel 8008 microprocessor. It took only another three to four years for these systems to move from basements to computer stores; by the end of the decade, computers were being mass merchandised. I therefore predict that by the end of this decade we will see personal robots mass merchandised just as personal computers are today.

### Japan Launches New Software Development Effort:

Japan is attempting to enter the software business by making a long-term commitment to supporting software houses. Following the same technique used in other fields, the Japanese government and industry are cooperating to provide the stimulus. Japan's Ministry of International Trade and Industry has launched a five-year project to create new operating-system software, software-development technology, and languages. Now in its third year, the project has \$192 million in funding, half coming from government and half from industry (participants include Nippon Electric Company [NEC], Hitachi, Fujitsu, Matsushita, Toshiba, Mitsubishi Electric, Oki, and Sharp). Of this sum, \$10.6 million was funneled to 2000 independent software houses.

Further, the Japanese government gave industry a 40 percent tax deferral on software revenues for the first four years of any developed program's life. Some of the larger companies, such as Hitachi, spun off their software operations into independent subsidiaries to make them less bureaucratic. Although most experts feel that Japan is still about 10 years behind the U.S. in software development, in some areas the Japanese have made significant strides. Japan has already developed banking and airline-reservation software considered equal to that used in the U.S. Further, its video games and robotics software are considered first rate.

### U.S. Firms Establish Foreign Software Operations:

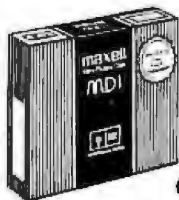
More and more U.S. computer makers are setting up software development operations outside the U.S., most notably in England and Europe. For example, DEC, Hewlett-Packard, Honeywell, Prime, Perkin-Elmer, and Modcomp all have established software operations near London. This has led to the creation of a large number of independent software shops. Packages for software development, games, database management, videotex, electronic mail, transaction processing, and packet-switched communications have already appeared from these operations. Increasing numbers of these software packages are being sold in this country. Most notable are packages for microcomputers, such as The Last One, Pearl, and CIS COBOL, all developed in England by independent software shops.

### Public-Domain Software:

It never ceases to amaze me how few personal computer users are aware of the existence of large libraries of public-domain software. That is, software that has not been copyrighted and thus can be legitimately copied. There are dozens of

# maxell

The Gold Standard.



## MDI

5 1/4" MINI  
SINGLE-SIDED  
SINGLE/DOUBLE DENSITY  
SOFT SECTORED

Special Buy!

**\$25<sup>95</sup>**  
BOX OF 10

LIMITED QUANTITY DEALER INQUIRIES INVITED

Call our Modem Hotline (anytime) - 619-268-4488 for exclusive monthly specials. Our free catalog contains more than 600 fantastic values.

## ABC Data Products

(formerly ABM)

8868 CLAIREMONT MESA BLVD.  
SAN DIEGO, CALIFORNIA 92123

ORDERS ONLY    ITT TELEX    INFORMATION  
800-854-1555    4992217    619-268-3537

# 2000 letters per hour via your personal computer



delivered in 48 hours or sooner  
at 26¢ a piece.

Whether it's credit and collection applications, announcements to your customers, or sales promotions for new services, our MAIL-COM software turns your personal computer into a one-button mailing house of enormous power. All you need is a modem, a personal computer, and our MAIL-COM software.

Our software allows you to link up with the U.S. Postal Service's new ECOM System. After receiving your letters via modem, the Postal Service will then print, stuff, seal and deliver the letters usually by the next day and guaranteed within 48 hours.

MAIL-COM is a complete, interactive package supporting all ECOM formats. Available now for the IBM PC (\$195.00), CP/M (\$195.00) and the Alpha Micro (\$495.00).

To order, call or write.

## Digisoft

Computers

1501 Third Avenue  
New York, NY 10028  
(212) 734-3875

# SuperBrain II™ - CompuStar™ Network Systems

- Excellent dealer & EOM discounts
- CMC's own national on-site service
- Toll-free Ordering & technical assistance
- Module replacement
- Advertising co-op
- After-sale support

### CMC ALSO OFFERS

- Six-month warranty
- High resolution graphics
- System support training in our facilities
- Optional green phosphor screen
- Enhanced DOS software with advanced files directory, diagnostics, disk editor, communications software and others

### SOFTWARE, PERIPHERALS FOR SUPERBRAIN COMPUSTAR

#### SOFTWARE

Accounting Plus  
Wordstar  
dBase II  
Microplan  
Profilplan  
Bisynch 80  
CBasic II

Microsoft  
MBasic  
Fortran 80  
Cobol 80  
M/T Pascal  
P/L I 80  
Spellguard  
Spellstar

#### PRINTERS

Datasouth  
Epson  
C. Itoh  
Okidata  
NEC  
Starwriter  
F10

#### MODEMS

Anderson-Jacobson  
CAT Novation

#### HARD DISKS

CMC Targa  
Corvus

#### MEDIA

Dysan  
Verbatim

#### MISC.

Line Filters  
Power Supplies

## CompuStar Hard Disk Systems

10mb, 32mb & 96mb

Control Data Corp.  
Phoenix Drives  
9448-96 CMD  
9448-32

**LOWEST PRICES  
ANYWHERE!**



## CMC INTERNATIONAL

A Division of Computer Marketing Corporation  
11056 Main Street, Suite 220  
Bellevue, Washington 98004  
TELEX: 152566 SEATAC

For Information Call (206)453-9777  
To Order, Call Toll-free 1-800-428-2963

DEALER INQUIRIES, GSA, GOVERNMENT, EDUCATIONAL DISCS INVITED

SuperBrain and CompuStar are registered trademarks of Intertec Data Systems Corporation



## BYTELINES

these libraries in existence, run mainly by computer clubs. Typically, these clubs gather software donations from their members or from exchanges with other clubs.

For example, the club that I belong to (the Amateur Computer Group of New Jersey—ACG-NJ) has a library of CP/M-compatible programs that fills over 100 disks. Each disk is packed with about 240K bytes of programs; in other words, there are over 24 megabytes of free software in the library. The club asks members to contribute \$1 each time they copy a "volume" (disk); if members wish, they may telephone a computer system maintained by the club that contains much of this software and is capable of downloading files. The club will furnish a printed catalog of its software offerings for just \$2 (request it from SIG/M, POB 97, Iselin, NJ 09930).

The ACG-NJ SIG/M and the CPMUG (CP/M User's Group, 1651 Third Ave, New York,

NY 10028) libraries are without doubt the largest such organizations in existence. For example, in their libraries, one will find 13 different language interpreters and compilers, many in source-code form so that those who wish to add enhancements or just want to study how a language is created can do so. Also available are BASIC (six versions), ALGOL, FOCAL, RATFOR (Relational FORTRAN), Pascal, STOIC (a FORTH-like language), PISTOL (Portably Implemented Stack Oriented Language), ACTOR, SAM (both string-processing languages) PILOT (Programmed Inquiry and Learning), PIDGIN, and TINCMP.

**East Bloc Personal Computing:** I have recently received some amateur-computer club newsletters from Hungary and Yugoslavia, two European socialist countries. From reading these newsletters it would appear that personal com-

puting is starting to take hold in these countries in much the same way as it started here in the U.S. These hobbyists appear to be about four to six years behind those in the U.S. Surprisingly, much of their equipment is either U.S.-made or copied from U.S. equipment. For example, the TRS-80 Model I and copies of it are popular.

**S-100 Update:** In the March 1983 BYTELINES (page 492), I estimated that there were 150 manufacturers of S-100 products making over 500 plug-in boards. A recent survey conducted by *Microsystems* magazine has turned up the fact that there are over 200 manufacturers making over 1000 different S-100 products. Thus, although the S-100 marketplace is very diverse, when taken as a single group, it represents the largest segment of the the current microcomputer-peripherals market.

**Z800 Update:** In my February 1983 column (page 430) I reported that Zilog expected to start offering samples of its new Z800 in the spring, with production expected in the fall. I regret to report that I was wrong; the firm expects to start supplying samples in the fall with

production expected early next year.

**Random News Bits:** The deregulation of the Bell System has allowed Western Electric, the manufacturing arm of AT & T, to go into the business of manufacturing components. Western Electric has hired salesmen to go out on the road to sell components that were previously available only within the Bell System. This will include a new 256K-bit semiconductor memory, bubble memory, and microprocessor parts. . . . Xerox has disclosed that its Office Products division, which sells the 820 desktop computer and the Star workstation, had a significant loss last year. . . . IBM has finally begun distributing the Personal Computer outside the U.S. The firm has also introduced an upgraded model of the Personal Computer, the XT (see page 520 for more on the new machine).

**MAIL:** I receive a large number of letters each month as a result of this column. If you write to me and wish a response, please include a self-addressed, stamped envelope.

**Sol Libes**  
c/o BYTE Publications  
POB 372  
Hancock, NH 03449 ■

## We will train you in UNIX™ and the "C" Language

...And, back it with 50 years of technical experience.

The leader in on-line data information equipment and applications for over 50 years, Bunker Ramo now provides a training course which gives you:

- A one terminal/one user classroom environment
- Proven hands-on learning techniques
- Comprehensive textbooks
- Complete course documentation
- State-of-the-art instructional methods
- Special group registration rates

Current course offerings include:

- Introduction to the UNIX environment (5 days)
- Introduction to "C" programming language (5 days)
- Advanced UNIX methods (5 days)
- Advanced "C" methods (5 days)

For a detailed prospectus, call or write:  
Bunker Ramo Information Systems  
Training Services Group  
35 Nutmeg Drive  
Trumbull, CT 06609  
(203) 386-2600



## BYTE's Bits

### Call for Papers on Industrial Electronics

Papers are being solicited for the International Conference on Industrial Electronics (IECON '83) to be held from November 7-11 at the Hyatt Regency Hotel in San Francisco. Send papers to R. C. Born, Eaton Corp.: Cutler Hammer, 4201 North 27th St., Milwaukee, WI 53216, (414) 449-7474.

### Comments on BASIC Standard Needed by July

The public comment period for the proposed

American National Standard for BASIC is now in effect. Copies of the draft may be obtained by writing to:

X3 Secretariat  
Computer and Business  
Equipment Manufacturers  
Association  
311 First St. NW  
Washington, DC 20001

Request document X3J2/82-17, called "Draft Proposed American National Standard for BASIC." The price is \$20 (check or money order). Comments should be sent to the same address by mid-July. ■

# Event Queue

**May 1983**

*May*

**Information Processing Seminars**, various sites throughout the U.S. Datapro Research Corporation offers more than 35 seminars about information processing. Among the titles are "User Friendly Information Delivery; Approaches to Online Systems Development," "The Personal Computer: Strategies for Managing," and "Productivity in MIS: Defining Measurements and Establishing Programs." These courses can be presented on an in-house basis. For a seminar catalog, contact Datapro Research Corp., 1805 Underwood Blvd., Delran, NJ 08075, (800) 257-9406; in New Jersey, (609) 764-0100.

*May-June*

**Computer Literacy for Lawyers**, various sites throughout the U.S. This seminar is intended to introduce attorneys to basic computer concepts and their application to the practice of law. Subjects covered include the specific uses, costs, and benefits of using computers in legal practice. The fee for each participant is \$550, which includes reference materials. Group discounts are available. For further information, contact Kathryn Mann, Center for Legal Studies, 1926 Arch St., Philadelphia, PA 19103, (215) 732-6999.

*May-June*

**Computer Showcase Expos**, various sites throughout the U.S. This popular show will bring together sellers and individual users of small computer systems. For details, contact The Interface Group, 160 Speen St., POB 927, Framingham, MA 01701.

(800) 225-4620; in Massachusetts, (617) 879-4502.

*May-June*

**Courses from Q.E.D. Information Sciences**, various sites throughout the U.S. Some of the courses listed are "Systems Analysis Workshop," "Project Management and Control," and "Data Analysis." Address inquiries to Priscilla Goudreault, Q.E.D. Information Sciences Inc., Q.E.D. Plaza, POB 181, Wellesley, MA 02181, (800) 343-4848; in Massachusetts, (617) 237-5656.

*May-June*

**Data Processing Courses**, the Hartford Graduate Center, Hartford, CT. Among the courses being offered are "ANS COBOL Programming Workshop 1" and "CICS/VS Command Level Coding Workshop." These data-processing courses are available for on-site presentation. For details, contact Don Florek, The Hartford Graduate Center, 275 Windsor St., Hartford, CT 06120, (203) 549-3600, ext. 252, 253, or 254.

*May-June*

**Intel Microcomputer Workshops**, various sites throughout the U.S. Among the workshops to be held are "Introduction to Microprocessors" and "IAPX 86, 88, 186 Microprocessors." Intel Customer Training courses are available for on-site presentation. For details, contact Intel Corp., Mail Stop SV3-1, 3065 Bowers Ave., Santa Clara, CA 95051.

*May-June*

**Intensive Seminars of Interest to Data Processing Professionals**, Boston metropolitan area. Among the two- to five-

day seminars offered are "Project Management" and "Systems Design." Registration fees range from \$495 to \$975. For a seminar bulletin, contact Ms. Ginny Bazarian, Office of Continuing Education, Higgins House, Worcester Polytechnic Institute, Worcester, MA 01609, (617) 793-5517.

*May-June*

**Management Development Programs**, Providence, RI, Boston, MA, and Hartford, CT. The Center for Management Development offers seminars on a variety of topics, including communications, industrial relations, and electronic data processing. Many of the Center's programs can be conducted on location for your organization. For complete information, contact The Center for Management Development, Bryant College, Smithfield, RI 02917, (401) 231-1200, ext. 314.

*May-June*

**Microprocessor Seminars**, Rochester Institute of Technology, Rochester, NY. Five one-week seminars are offered: "Basic 8085," "Advanced 8085," "Basic 6800," "Advanced 6800," and "Advanced Digital Electronics." Hands-on experience is provided. The fee is \$480. Contact Jeanne Berry or Stacy Jordan, Rochester Institute of Technology, Rochester, NY 14627, (716) 475-2915.

*May-June*

**Office Automation: Tee to Green**, various sites throughout the U.S. This three-day seminar for administrative and information-systems professionals addresses the complex production issues and opportunities presented by automation of the office

workplace. Seminar objectives include developing a productivity program, establishing long-range office systems plans, and developing integrated communications systems. The fee is \$385 for members of the Data Processing Management Association (DPMA/EF) or \$410 for non-members. For registration information, contact DPMA/EF Conferences, D. L. Hiller & Associates, 14536 Island Dr., Sterling Heights, MI 48078, (313) 247-8444.

*May-June*

**Professional Development Seminars**, various sites throughout the U.S. Data communications, database management, software and systems, and computer-aided design/manufacturing are some of the areas investigated in seminars offered by the Institute for Advanced Technology. For a detailed catalog, contact the Registrar, Institute for Advanced Technology, Control Data Corp., 6003 Executive Blvd., Rockville, MD 20852, (800) 638-6590; in Maryland, (301) 468-8576.

*May-June*

**Seminars in Simulation, Management, Statistics, and Computer Science**, various sites throughout the U.S. "Simulation Modeling for Decision Making," "Database Design," and "Satellite Communications Technology" are some of the topics to be presented. For information, contact the Institute for Professional Education, POB 756, Arlington, VA 22216, (703) 527-8700.

*May-July*

**Courses from Integrated Computer Systems**, various sites throughout the U.S. Course titles include "Com-



puter-Aided Design and Manufacturing," "Computer Graphics," "Hands-On Pascal Workshop," "Defining Software Requirements, Specifications, and Tests," and "Computerized Robots." Fees range from \$695 to \$845. For information, contact Ruth Dordick, Integrated Computer Systems, 3304 Pico Blvd., POB 5339, Santa Monica, CA 90405, or call (213) 450-2060.

### May-July

**Productivity '83**, various sites throughout the U.S. and Canada. This is Hewlett-Packard's hands-on showcase of more than 32 computer products and 17 seminars. It's designed to provide data-processing professionals and novices with answers to problems confronting the industry. For details, call (800) 453-9500.

### May-July

**Technical Courses from Zilog, Campbell, CA.** A wide variety of such courses as "Z80 Assembly Language" and "ZEUS/System 8000 User Course" are offered. Fees range from \$175 to \$875. For a complete schedule, con-

tact Zilog Inc., Training and Education Department, 1315 Dell Ave., Campbell, CA 95008, (408) 370-8092.

### May-August

**Courses in C Language and Unix**, various sites throughout the U.S. Three 5-day courses are offered by Plum Hall Inc. The "C Programming Workshop," a hands-on course, covers all aspects of the C language for individuals able to program in another language. The "Advanced C Topics Seminar" covers efficiency, portability, readability, debugging, packaging, and interfacing. The "Unix Workshop" is an introductory course that focuses on software development. For further details, contact Joan Hall, Plum Hall Inc., 1 Spruce Ave., Cardiff, NJ 08232, (609) 927-3770.

### May-December

**Courses from the AMA**, various sites throughout the U.S. The American Management Associations (AMA) offers an on-going series of seminars in such areas as human resources, information systems, and manufacturing and technology man-

agement. In-house development and training seminars can be arranged. For information on AMA membership or seminar particulars, contact the American Management Associations, 135 West 50th St., New York, NY 10020, (212) 586-8100.

### May-December

**IEEE Conferences and Meetings**, various sites around the world. The Institute for Electrical and Electronics Engineers (IEEE) sponsors conferences, meetings, and workshops covering high-technology issues. For details, contact the IEEE Computer Society, Suite 300, 1109 Spring St., Silver Spring, MD 20910, (301) 589-8142.

### May 10-11

**Selecting a Microcomputer for Scientific and Engineering Applications**, Golden, CO. This short course reviews hardware and software technology for potential buyers of microcomputers in relation to specific scientific and engineering applications. The fee is \$195. Contact the Space Office, Colorado School of Mines, Golden, CO 80401, (303) 273-3321.

### May 10-12

**Mini/Micro-Northwest**, Portland, OR. Running concurrently with Northcon/83, this show addresses such topics as aerospace electronics, laser applications, and semiconductor technology. Contact Electronic Conventions Inc., Suite 410, 999 North Sepulveda Blvd., El Segundo, CA 90245, (800) 421-6816; in California, (800) 262-4208 or (213) 772-2965.

### May 11-15

**Computa '83: The Third International Exhibition on Computer and Information Processing Technology**, World Trade Centre, Singapore, Republic of Singapore. Information is available from Kallman Associates, 5 Maple Court, Ridgewood, NJ 07450, (201) 652-7070.

### May 12-13

**The Fourth Annual Computer Law Institute**, University of Southern California Law Center, Los Angeles. This year's Institute will present a program on structuring agreements for the distribution of computer products domestically as well as inter-

# CompuPro

## 8 and/or 16 Bits.

A Full Service CompuPro System Center is much more than a computer store. When you're ready for professional level, state-of-the-art microcomputing, turn to the professionals listed below...they're ready for you.

### ARIZONA

S-100  
14425 N. 79th St. #B  
Scottsdale, AZ 85260  
(602) 991-7870

### CALIFORNIA

**Creative Computing Services**  
230 S. Montclair #103  
Bakersfield, CA 93309  
(805) 325-9877

**Computer Center, Inc.**  
1514 University Avenue  
Berkeley, CA 94703  
(415) 845-8368

**Mentzer Computer Systems**  
1441 Rollins Rd.  
Burlingame, CA 94010  
(415) 340-9363

**Creative Computing Services**  
20813 Soledad Canyon Rd.  
Canyon Country, CA 91351  
(805) 251-9877

**Logic Systems**  
5830 Jameson Ct.  
Carmichael, CA 95808  
(916) 971-3133

**Priority 1**  
8181 Dearing Ave.  
Chatsworth, CA 91311  
(213) 709-5484

**Byte Shop of Hayward**  
1122 B St.  
Hayward, CA 94541  
(415) 886-4732

**American Computers & Engineers**  
2001 S. Barrington Ave. #204  
Los Angeles, CA 90025  
(213) 477-8751

**Gifford Computers**  
2323 Corinth Ave.  
Los Angeles, CA 90064  
(213) 477-3921

**ACC**  
833 Steirlin Rd. #B110  
Mountain View, CA 94043  
(415) 966-4969

**Computer Center, Inc.**  
2100 Broadway St.  
Oakland, CA 94612  
(415) 839-3230

**System Interface Consultants**  
17440 Revello Dr.  
Pacific Palisades, CA 90272  
(213) 454-2100

**Advanced Information Mgmt.**  
145 Kentucky St.  
Petaluma, CA 94952  
(707) 763-7283

**Best Computer Stores**  
5518 Springdale Ave.  
Pleasanton, CA 94566  
(415) 463-2233

nationally. Other topics include proprietary rights, anti-trust issues, and major system procurements. An optional session on the basics of computer products and technology will be offered. Contact Ami Silverman, USC Law Center, University Park, Los Angeles, CA 90007, (213) 743-2582.

*May 13-15*

**Applefest**, Bayside Exposition Center, Boston, MA. This is the third annual Boston Applefest. More than 400 displays of Apple-compatible products will be featured. Complementing the exposition will be seminars, conferences, workshops, and panel discussions. Call or write Northeast Expositions, 826 Boylston St., Chestnut Hill, MA 02167, (800) 841-7000; in Massachusetts, (617) 739-2000.

*May 14-15*

**Toronto PET User's Group Conference**, George Brown College, Casa Loma campus, Toronto, Ontario, Canada. Speakers, workshops, a trader's corner for used equipment, and exhibits of hardware, software, and ac-

cessories highlight this event. Contact Chris Bennett, TPUG Corresponding Secretary, 381 Lawrence Ave. W, Toronto, Ontario M5M 1B9, Canada, (416) 782-9252.

*May 15-20*

**Problem-Solving Leadership**, San Francisco, CA. This workshop, designed to help managers and technical leaders enhance their problem-solving effectiveness, is sponsored by the Data Processing Management Association Education Foundation (DPMA/EF). Further information is available from Judy Cook, Weinberg & Weinberg, R R #2, Lincoln, NE 68505, (402) 781-2542.

*May 16-18*

**Computer Graphics for Engineering/Drafting Practice**, University of Texas, Austin. This course will stress developing the ability to prescribe and implement computer graphics equipment for specific engineering applications. A two-day hands-on workshop follows the course. Contact the College of Engineering, University of Texas, Austin, TX 78712, (512) 471-3396.

*May 16-18*

**Mini-Conferences and Professional Growth Seminars**, Loews Anatole, Dallas, TX. A special feature of this event will be the introduction of the data-entry certification program. Among the topics to be addressed are motivation, training, and interviewing. Contact Marilyn S. Bodek, Data Entry Management Association, POB 3231, Stamford, CT 06905, (203) 322-1166.

*May 16-19*

**National Computer Conference**, Anaheim and Disneyland Hotel Convention Centers, Anaheim, CA. This show features exhibits of computer products and services, technical sessions, seminars, and formal addresses. For complete information, contact the American Federation of Information Processing Societies Inc., 1815 North Lynn St., Arlington, VA 22209, (703) 558-3624.

*May 16-19*

**Patent Your Software for Profit**, Anaheim, CA. This

seminar, which runs concurrently with the National Computer Conference, will explore software patent examples and offer advice on patenting and licensing software. Patent reference materials will be provided. Full details are available from Delbert L. Keenon, Automation Inc., 3410 Mona Lee, Houston, TX 77080, (713) 462-4151.

*May 16-20*

**Auditing in the Contemporary Computer Environment**, New York, NY. This course is designed for internal auditors and financial and data-processing professionals. Participants will learn a comprehensive audit approach for computer-based systems, including how to evaluate controls and how to design a program of tests using questionnaires, checklists, software tools, and flowcharts. Contact Marge Umlor, EDP Auditors Foundation, 373 South Schmale Rd., Carol Stream, IL 60187, (312) 682-1200.

*May 16-20*

**Auditing Integrity Controls in the Contemporary Com-**

# Spoken Here...

**Gifford Computers**  
230 California St. #207  
San Francisco, CA 94104  
(415) 391-4570

**Gifford Computers**  
1922 Republic Ave.  
San Leandro, CA 94577  
(415) 895-0788

**Computer House**  
501 B St.  
San Rafael, CA 94901  
(415) 453-0865

**Data Bank**  
629 State St.  
Santa Barbara, CA 93101  
(805) 962-8489

**Data Bank**  
800 S. Broadway  
Santa Maria, CA 93456  
(805) 922-1333

**Matrix Computers**  
720 Mendocino Ave.  
Santa Rosa, CA 95401  
(707) 542-0571

**Pragmatic Designs, Inc.**  
850 Benicia Ave.  
Sunnyvale, CA 94086  
(408) 736-8870

## FLORIDA

**Micro Computer Technology**  
1549 W. Brandon Blvd.  
Brandon, FL 33511  
(813) 685-7659

## HAWAII

**Capacity Plus Computers**  
250 Alamaha St. N14  
Kahului Maui, HI 96732  
(808) 877-3496

## ILLINOIS

**Computers Plus**  
201 N. Main St.  
Athens, IL 62613  
(217) 836-8481

**Lillipute Computer Mart, Inc.**  
4448 Oakton St.  
Skokie, IL 60076  
(312) 674-1383

## INDIANA

**General Software, Inc.**  
1454 S. 25th St.  
Terre Haute, IN 47803  
(812) 234-8421

## MARYLAND

**JR Systems**  
8227 Woodmont Ave. #200  
Bethesda, MD 20814  
(301) 857-3598





## Event Queue

puter Environment, Washington, DC. This program is designed to provide an overview of the computer environment, its controls, and its interrelationships. It combines theoretical and practical approaches for electronic data-processing auditing, with an emphasis on integrity controls and related operational concerns. Further details are available from Marge Umlor, EDP Auditors Foundation, 373 South Schmale Rd., Carol Stream, IL 60187, (312) 682-1200.

### May 16-20

Session '83, Skyline Hotel, Ottawa, Ontario, Canada. The theme of this annual conference of the Canadian Information Processing Society (CIPS) is "Converging Technologies." Des Cunningham, president of Gandalf Technologies, will be the keynote speaker. For further details, write Session '83, POB 2577, Station D, Ottawa, Ontario K1P 5W7, Canada, or call Ron Elliott, (613) 234-4333.

### May 17-20

Technology/Invention New Product Expo, Expo Mart,

Monroeville, PA. This show will feature everything from diesel fuel-injection systems to spring-loaded fly swatters. Further details can be obtained from Gary F. Brown, Technology/Inpex, Suite 400, 701 Smithfield St., Pittsburgh, PA 15222, (412) 288-1344.

### May 18-19

Third Annual Computer Conference, Iona College, New Rochelle, NY. This conference is devoted to the newest developments in the use of microcomputers, with an emphasis on education and business. Seminars, workshops, formal papers, and product exhibits will be featured. The fee is \$35 per day. Contact Mr. McCallion, Iona College, New Rochelle, NY 10801, (914) 636-2100.

### May 18-20

The Fifth National Conference of the Cognitive Science Society, University of Rochester, Rochester, NY. This conference will consist of lectures, panels, commentaries, and papers. Contact the Cognitive Science Conference, Dewey Hall, University of

Rochester, Rochester, NY 14627, (716) 275-5402.

### May 18-20

Man Machine Interface, Palo Alto, CA. For full details, contact the Continuing Education Institute, Oliver's Carriage House, 5410 Leaf Treader Way, Columbia, MD 21044, (301) 596-0111; on the West Coast, call (213) 824-9545.

### May 18-20

Mipro-83: The Sixth Microprocessors/Microcomputers Course/Conference, Congress Center, Hotel Adriatic, Opatija, Yugoslavia. The theme for this conference is "Advanced Microcomputer Application Techniques and New Trends." It is geared toward hardware and software specialists and managers involved with the development, production, and management of microcomputer-based systems. For details, contact Mr. P. Dragojlović, Mipro Secretariat, Trg P. Togliatti 4, 51000 Rijeka, Yugoslavia.

### May 19-20

Computers in Construction, Denver, CO. This seminar

is designed to assist construction contractors and construction management firms in acquiring computer systems. The registration fee is \$395. For further information, contact CIP Information Services Inc., 1105-F Spring St., Silver Spring, MD 20910, (301) 589-7933.

### May 19-22

Maryland Computer Show and Office Equipment Exposition, Convention Center, Baltimore, MD. Address inquiries to Dee Harris, Computer Expositions Inc., POB 3315, Annapolis, MD 21403, (800) 368-2066; in Maryland, (301) 263-8044.

### May 20-22

Computers and Personal Values: Sharing from Experience, Sign of the Dove, Temple, NH. This workshop offers individuals in the computer community the opportunity to examine personal, ethical, or moral questions associated with their work and with the impact of computers on society. The format includes small and large discussion groups and invited speakers. The cost is \$150.

# ...And Here.

## MASSACHUSETTS

New England Electronic Exch.  
138 Arlington St.  
Boston, MA 02116  
(617) 491-3000

Key Micro Systems  
822 Boylston St.  
Chestnut Hill, MA 02167  
(617) 738-7308

## NEW YORK

John D. Owens Associates, Inc.  
12 Schubert St.  
Staten Island, NY 10305  
(212) 448-6283

## NORTH CAROLINA

General Semantics, Inc.  
127 S. Elm St., Dixie Bldg.  
Greensboro, NC 27402  
(919) 288-1117

## OKLAHOMA

Gifford Computers  
6161 N. May #177  
Oklahoma City, OK 73112  
(405) 840-1175

## OREGON

Microwest Computer Products  
811 E. Burnside #117  
Portland, OR 97214  
(503) 238-6274

## RHODE ISLAND

Key Micro Systems  
1806 Nooseneck  
Coventry, RI 02816  
(401) 828-7270

## WISCONSIN

Byte Shop of Milwaukee  
4840 S. 78th St.  
Greenfield, WI 53220  
(414) 281-7004

## CANADA

Dynacomp Business Computers Ltd.  
3258 Beta Ave.  
Burnaby, British Columbia V5G 4K4  
(604) 289-3747

MDI Micro Distributing, Inc.  
2403 Canoe Ave.  
Coquitlam, British Columbia V3K 6A8  
(604) 941-0822

## UNITED KINGDOM

Comcen Technology Ltd.  
45/46 Wychtree St., Morrilton  
Swansea SA6 8EX  
(0792) 796000



CompuPro, a wholly owned subsidiary of Godbout Electronics  
Box 2355, Oakland Airport, CA 94614

For more information, contact Arthur Fink, Prince St., Box 614, Wilton, NH 03086, (603) 654-6518.

*May 21*

**The Sixth Annual Spring Microcomputer Show & Tell Conference**, University of Oklahoma, Norman. This conference is designed to let computer enthusiasts share ideas and information. Speakers will demonstrate their devices and field questions from the audience in six show and tell periods. Also featured is an on-the-spot programming contest. For additional information, contact Dr. Richard V. Andree, Mathematics Department, University of Oklahoma, Norman, OK 73019, (405) 325-3410.

*May 22-25*

**The Eighteenth Annual Meeting and Exhibit Program of the AAMI**, Loews Anatole, Dallas, TX. Topics on the docket include anesthesia instrumentation and technology, computer applications, personnel management, and technology transfer. Roundtable discussions, tutorials, and an exhibit program will be featured. For details, contact the Association for the Advancement of Medical Instrumentation, Suite 602, 1901 North Fort Meyer Dr., Arlington, VA 22209, (703) 525-4890.

*May 22-26*

**Annual Industrial Engineering Conference and Exposition**, Galt House Hotel and Commonwealth Conference Center, Louisville, KY. "Racing for Productivity" is the theme of this event sponsored by the Institute of Industrial Engineers (IIE). More than 130 educational sessions will address a broad range of issues; computer hardware and software, material handling equipment and systems, and process-control equip-

ment will be shown. Pre-conference seminars will be held from May 19 to 22. Registration fees are \$240 for IIE members and \$290 for non-members. Contact the Registrar, Conference Department, IIE, 25 Technology Park/Atlanta, Norcross, GA 30092, (404) 449-0460.

*May 23-25*

**The Technology of Personnel Conference**, Grand Hyatt Hotel, New York, NY. Sponsored by the Association of Human Resource Systems Professionals (HRSP), this conference will offer a range of presentations and workshops covering human resource technology and the social and psychological implications of this technology on workers and organizations. Contact HRSP Inc., Mills Square Tower, 100 South Ellsworth Ave., San Mateo, CA 94401, (415) 593-4461.

*May 23-27*

**Auditing Integrity Controls in the Contemporary Computer Environment**, New York, NY. For details, see May 16-20.

*May 24-26*

**Microprocessor Background for Management Personnel**, Palo Alto, CA. The fee for this course is \$565, which includes text and program materials. Contact Continuing Education in Engineering, Department 532N, University of California Extension, 2223 Fulton St., Berkeley, CA 94720, (415) 642-4151.

*May 24-27*

**Interact**, Hilton Hotel, Denver, CO. This convention is for members of the international users group of Management Science America's (MSA's) Human Resource System. More than 1200 payroll, personnel, and data-processing professionals are expected to attend. Contact

MSA Inc., Suite 1300, 3445 Peachtree Rd. NE, Atlanta, GA 30326.

*May 31-June 2*

**The Second Canadian Computer-Aided Design/Computer-Aided Manufacturing and Robotics Exposition and Conference**, International Centre of Commerce, Toronto, Ontario, Canada. Leading international companies will demonstrate industrial robots, automatic assembly equipment, optical scanners, and numerically controlled machine tools. Technical papers will focus on such topics as robot-vision systems and design analysis. For information, contact Hugh F. Macgregor & Associates, 662 Queen St. W, Toronto, Ontario M6J 1E5, Canada, (416) 363-2201.

*May 31-June 4*

**The Twelfth Annual MUMPS Users' Group Meeting**, Hilton Hotel, San Francisco, CA. Introductory and advanced tutorials, workshops, roundtable discussions, site visits, and hardware, software, and systems demonstrations and exhibits all relating to the MUMPS computer language will be offered. Registration information is available from Charles White, Professional Associates, 2012 Big Bend Blvd., St. Louis, MO 63117.

---

## June 1983

---

*June*

**Continuing Engineering Education Courses**, George Washington University, Washington, DC. Among the courses available are "Database and File Management for Microcomputers," "Computer Communications Systems and Networks," and "A Phased Approach to Software Conversion." Course fees range from \$625 to \$855. For information, contact

Douglas Green, Continuing Engineering Education, George Washington University, Washington, DC 20052, (800) 424-9773; in the District of Columbia, (202) 676-8512.

*June 1-4*

**The First Annual Sunbelt Educational Computing Conference**, Texas Tech University, Lubbock. The theme for this conference is "Practical Applications and Current Issues in Educational Computing." For details, write to Dr. Cleborne D. Maddux, College of Education, Texas Tech University, POB 4560, Lubbock, TX 79409.

*June 2-4*

**Personal Computer Interfacing and Scientific Instrument Automation**, Charlotte, NC. This workshop provides each participant with hands-on experience in wiring and testing interfaces. The fee is \$395. Call or write Dr. Linda Leffel, C.E.C., Virginia Polytechnic Institute and State University, Blacksburg, VA 24061, (703) 961-4848.

*June 5-8*

**Consumer Electronics Show (CES)**, McCormick Place, Chicago, IL. This show is sponsored by the Electronic Industries Association (EIA). For information on this popular event, contact the CES Shows Office, Suite 1607, Two Illinois Center, 233 North Michigan Ave., Chicago, IL 60601, (312) 861-1040.

*June 5-8*

**Mini-Conferences and Professional Growth Seminars**, Registry Resort Hotel, Scottsdale, AZ. For details, see May 16-18.

*June 5-9*

**The Twelfth Annual International Software AG Users' Conference**, Fairmont and Royal Sonesta Hotels, New Orleans, LA. This conference will feature speakers, presen-



# UV EPROM ERASER

- ★ Erases over 15 EPROMS - 15 minutes erase time
- ★ Element life 7700 hours
- ★ Intensity: 12W/cm<sup>2</sup> at 1"
- ★ Erases all UV EPROMS (2716, 2732, 2516, 2532, etc.)

## \$49.95\*

\*HOBBY MODEL

**INDUSTRIAL MODEL**  
QUV-T8 / 2N

\$68.95

**WITH TIMER AND SAFETY SWITCH**

QUV-T8 / 2T

\$97.50

**INTELLIGENT PROGRAMMER STAND ALONE RS-232**

- ★ RELIABLE
- ★ EASY COPY (4th external experiment needed)
- ★ USER FRIENDLY

COMPATIBLE:  
IBM PC, TRS-80, APPLE, CPM, FLEX, TEXTRONICS, MDS

**(MCS-48)**

PROGRAMMING  
PRICE INCLUDES PERSONALITY MODULE

\$489.00



PROGRAMS: 2508, 2516, 2532, 2716, 27C16, 27C32, 2732, 2732A, 2758, 8748, 8749H, 8748H

OPTIONAL MODULES: 2564, 2764, 8755A, 8741

- ★ STAND ALONE, CRT, OR COMPUTER CONTROL
- ★ UPLOAD/DOWNLOAD IN MOTOROLA OR INTEL HEX FORMAT
- ★ MICROPROCESSOR BASED • 4 K INTERNAL RAM
- ★ 90 DAY PARTS & LABOR WARRANTY ON ALL PRODUCTS

SOON TO BE RELEASED:

PROMPRO-8 128K Version \$689.

**MONEY BACK GUARANTEE**

**LOGICAL DEVICES INC.**

781 W OAKLAND PARK BLVD. • FT. LAUDERDALE, FL 33311

Phone Orders (305) 974-0967 • TWX: 510-955-9496

SEE US AT COMDEX SPRING • BOOTH #3019

## Event Queue

tations, workshops, and tutorials. For details, contact Paula J. Brooks, Software AG of North America Inc., 11800 Sunrise Valley Dr., Reston, VA 22091, (703) 860-5050, ext. 578.

June 6

**New Trends in Rapid IC Processing Techniques: Lasers, Electron Beams, and Incoherent Sources**, Hyatt Palo Alto Hotel, Palo Alto, CA. The fee for this engineering course is \$195. Registration details are available from Continuing Education in Engineering, Department 564N, University of California Extension, 2223 Fulton St., Berkeley, CA 94720, (415) 642-4151.

June 6-8

**The Fifth Annual National Educational Computing Conference-NECC 83**, Towson State University, Baltimore, MD. This conference provides a broad forum for discussion among individuals at all levels who share an interest in educational computing. Papers will be presented; tutorials will be held; and demonstrations and exhibits will emphasize computer uses in instruction. For registration forms, contact Doris K. Lidtke, NECC 83, Department of Mathematics and Computer Science, Towson State University, Baltimore, MD 21204.

June 6-8

**The Sixth International Conference on Computers and the Humanities-ICCH/83**, North Carolina State University, Raleigh, NC. This conference serves as a forum for the exchange of ideas on the use of computers in all areas of the humanities. Features include formal sessions, discussion groups, tutorials, workshops, and exhibits. For details, write to Dr. Sarah K. Burton, Department of

English, POB 5308, North Carolina State University, Raleigh, NC 27650.

June 7

**Materials Characterization for Ion Implantation**, Hyatt Palo Alto Hotel, Palo Alto, CA. The fee for this engineering course is \$195. Registration details are available from Continuing Education in Engineering, Department 564N, University of California Extension, 2223 Fulton St., Berkeley, CA 94720, (415) 642-4151.

June 7-8

**International Conference on the Use of Micros in Fluid Engineering**, Tara Hotel, London, England. All aspects of the use of microcomputers and microprocessors in fluid engineering will be covered. Subjects of interest include developing software for fluid-engineering design, rapid response controllers, and data-acquisition and analysis on-site. Full details are available from the Organizing Secretary, Micros in Fluid Engineering, BHRA Fluid Engineering, Cranfield, Bedford MK43 0AJ, England; tel: (0234) 750422; Telex: 825059.

June 7-9

**International Computer Show**, Velodrome, Olympic site, Montreal, Quebec, Canada. This trade show is designed for businesses wishing to identify or compare computers and equipment for automating the office or for industrial activities. For details, contact Industrial Trade Shows of Canada, 20 Butterick Rd., Toronto, Ontario M8W 3Z8, Canada, (416) 252-7791.

June 7-9

**Maptek Europe 1983: Annual Strategy Conference**, Hotel Excelsior, Venice, Italy. This meeting will provide detailed market forecasts and strategic

# And then there were none.



The list of already extinct animals grows . . . the great auk, the Texas gray wolf, the Badlands bighorn, the sea mink, the passenger pigeon . . .

What happens if civilization continues to slowly choke out wildlife species by species?

Man cannot live on a planet unfit for animals.

Join an organization that's doing something about preserving our endangered species. Get involved. Write

the National Wildlife Federation,  
Department 105, 1412 16th Street, NW, Washington, DC 20036.

It's not too late.







## Event Queue

neering, University of Texas, Austin, TX 78712, (512) 471-3396.

June 14-16

**Ohmcon/83, High-Technology Electronics Exhibition and Convention**, Cobo Hall, Detroit, MI. For details, contact Electronic Conventions Inc., 999 North Sepulveda Blvd., El Segundo, CA 90245, (800) 421-6816; in California, (213) 772-2965.

June 14-16

**Technology Opportunity Conference**, Washington, DC. This conference will focus on the convergence of optical-storage, videodisc, and computer technologies. For full details, contact Technology Opportunity Conference, POB 14817, San Francisco, CA 94114, (415) 626-1133.

June 14-18

**Tectronica**, Earls Court Exhibition Centre, London, England. This exhibition on laboratory technology aims to show the latest in instrumentation, equipment, and services for life and physical sciences. For details, contact Good Relations Ltd., 15 Adeline Place, London WC1B 3AJ, England; tel: (01) 636-6561; Telex: 265903.

June 15-17

**Basics of Power Electronics**, Los Angeles, CA. For information on this course, contact Teslaco, Suite 6, 490 South Rosemead Blvd., Pasadena, CA 91107, (213) 795-1699.

June 15-17

**The Twenty-first Annual Meeting of the Association**

for **Computational Linguistics**, Massachusetts Institute of Technology, Cambridge, MA. Papers to be presented will address syntax, the representation of knowledge, machine and machine-aided translation, and other linguistically and computationally significant topics. Information is available from Don Walker, Artificial Intelligence Center, SRI International EJ278, Menlo Park, CA 94025, (415) 859-3071.

June 16-17

**Clinical Laboratory Computers: Symposium 1983**, Towsley Center for Continuing Medical Education, Ann Arbor, MI. Course credit will be offered. Contact the Office of Continuing Medical Education, Towsley Center Box 057, University of

Michigan Medical School, Ann Arbor, MI 48109, (313) 763-1400.

June 16-18

**Personal Computer Interfacing and Scientific Instrument Automation**, Reston, VA. For details, see June 2-4.

June 17-19

**PC '83/West**, Brooks Hall/Civic Center Complex, San Francisco, CA. This show will bring together users, developers, distributors, and retailers of products that are compatible with the IBM Personal Computer. Seminars, workshops, demonstrations, and a conference program will aim to educate users on product features and capabilities. Further conference information is available from Northeast Expositions, 826 Boylston St., Chestnut Hill,

# BYTE back issues for sale

	1976	1977	1978	1979	1980	1981	1982	1983
Jan.		\$2.00		\$2.75	\$3.25	\$3.25		\$3.70
Feb.			\$2.75	\$2.75	\$3.25	\$3.25	\$3.70	\$3.70
March			\$2.75	\$2.75	\$3.25	\$3.25	\$3.70	\$3.70
April			\$2.75	\$2.75	\$3.25	\$3.25	\$3.70	\$3.70
May		\$2.00	\$2.75	\$2.75	\$3.25	\$3.25	\$3.70	
June		\$2.00	\$2.75	\$2.75	\$3.25	\$3.25	\$3.70	

	1976	1977	1978	1979	1980	1981	1982	1983
July	\$2.00	\$2.00	\$2.75	\$2.75	\$3.25	\$3.25	\$3.70	
Aug.	\$2.00	\$2.00	\$2.75	\$2.75	\$3.25	\$3.25	\$3.70	
Sept.		\$2.75	\$2.75	\$2.75	\$3.25	\$3.25	\$3.70	
Oct.			\$2.75	\$2.75	\$3.25	\$3.25		
Nov.	\$2.00	\$2.75		\$3.25	\$3.25	\$3.25	\$3.70	
Dec.	\$2.00	\$2.75	\$2.75	\$3.25	\$3.25	\$3.25	\$3.70	

Circle and send requests with payment to:  
**BYTE Back Issues**  
**P.O. Box 328**  
**Hancock, NH 03449**

Please allow 4 weeks for domestic delivery and 8 weeks for foreign delivery.

name \_\_\_\_\_  
 address \_\_\_\_\_  
 city \_\_\_\_\_  
 state \_\_\_\_\_ zip \_\_\_\_\_

The above prices include postage in the US. Please add \$.50 per copy for Canada and Mexico; and \$2.00 per copy to foreign countries.

Check enclosed

Payments from foreign countries must be made in US funds payable at a US bank.

VISA  Master Card  
 Card # \_\_\_\_\_ Exp. \_\_\_\_\_

Signature \_\_\_\_\_

MA 02167, (800) 841-7000; in Massachusetts, (617) 739-2000.

June 19-23

**Conference on Computer Vision and Pattern Recognition-CVPR '83**, Crystal City Hyatt, Arlington, VA. This program, formerly known as the Pattern Recognition and Image Processing Conference, provides a forum for the presentation of papers on vision, pattern recognition, and image processing. For full details, write to CVPR '83, POB 639, Silver Spring, MD 20901.

June 19-24

**Problem Solving Leadership**, Washington, DC. For details, see May 15-20.

June 20-July 15

**Computers in Education '83-CE '83**, Rutgers State University, New Brunswick, NJ. The theme of this conference is "Necessary Direction for Computer Education: Navigational Aids for the 80s." The focus will be on the impact of microcomputers on elementary, secondary, and college-level education. Conference highlights include presentations, special-interest sessions, a software exchange, and a film festival.

Running concurrently with CE '83, the Summer Institute for educators offers 40 short courses, ranging in length from one to twelve days. Topics include "The Turtle is the Teacher: An Introduction to Logo," "Using Computers in the Elementary School," and "Algorithm Design." Courses are \$95 per day. Conference registration is \$145. For more information, contact Dr. Mitchell E. Batoff, Director CE '83, Institute for Professional Development, Suite D, 245 Nassau St., Princeton, NJ 08540, (609) 924-8333.

June 23

**The Twenty-second Annual Technical Symposium of the Washington DC Chapter of the Association for Computing Machinery**, National Bureau of Standards, Gaithersburg, MD. The theme for this event is "Microcomputer Systems: Tools or Toys?" Topics of interest include systems software, human factors, and office systems. For further details, contact Howard Weeks Associates, 15201 Shady Grove Rd., Rockville, MD 20850.

June 27-30

**The World of CAD/CAM**, Marriott Resort, Newport Beach, CA. This seminar provides an overview of how manufacturing will change as the automated factory becomes a reality. It will consist of four one-day presentations in computer-aided engineering, design, manufacturing, and computer-integrated manufacturing. For a brochure, write or call the Center for Manufacturing Technology, 4170 Crossgate Dr., Cincinnati, OH 45236, (513) 791-8801.

June 27-July 1

**Auditing Integrity Controls in the Contemporary Computer Environment**, San Diego, CA. For details, see May 16-20.

June 28-30

**National Educational Computer Conference**, New York Statler Hotel, New York, NY. The theme of this conference is "Higher Instructional Techniques in Education." Seminars, exhibits, hands-on demonstrations, and workshops will highlight this event. Additional information is available from the National Educational Computer Library, POB 293, New Milford, CT 06776, (203) 354-7760.

June 29-July 1

**Microcomputers, Electronic Toys, and Genius Machines in Early Childhood Education**, Teachers College, Columbia University, New York, NY. This conference will examine the effect of the growing use of the new technology on the entertainment and education of children. Events will include panel discussions, workshops, a computer fair, and a film festival. Participants can attend on a noncredit basis for \$125 or for graduate credit at \$240 per point. For further information, contact the Program in Early Childhood Education, Box 9, Teachers College, Columbia University, New York, NY 10027, (212) 678-3971.

June 29-July 1

**Tertiary Education for the Age of Communications**, Royal Melbourne Institute of Technology, Melbourne, Australia. Formal presentations will focus on the educational implications of new technologies as they reflect both on the needs of industry and the requirements of curriculum development. Areas of interest include telecommunications, engineering, and computer and information sciences. For details, contact the International Conference on Communications, Royal Melbourne Institute of Technology, G.P.O. Box 2476V, Melbourne, Victoria 3001, Australia; tel: 3452822; Telex: AA36406.

---

## July 1983

---

July

**Continuing Engineering Education Courses**, George Washington University,

Washington, DC. Among the courses offered are "An Applications-Oriented Approach to Artificial Intelligence," "Reliability of Computer Software and Computing Networks," and "Computer Memory Systems." Fees range from \$625 to \$855. Contact Douglas Green, Continuing Engineering Education, George Washington University, Washington, DC 20052, (800) 424-9773; in the District of Columbia, (202) 676-8512.

July-October

**Repair of Microcomputer-based Equipment**, various sites throughout the U.S. and Canada. This seminar describes general servicing practices that are applied to the subsystems of any microprocessor family. This lecture/laboratory sequence is intended for field-service personnel, engineers, and technical writers. For details, contact the Registrar, Testek Consultants Inc., 1000 North Patton St., Arlington Heights, IL 60004, (312) 577-2134.

July 5-7

**Technology Opportunity Conference**, London, England. For details, see June 14-16.

July 8-10

**Computerfest '83: The Eighth Annual Midwest Affiliation of Computer Clubs Computerfest**, Harbourfront, Toronto, Ontario, Canada. Talks, exhibits, and sessions on computers and children will be held. Carl Helmers, editor of *Robotics Age* magazine, is the featured speaker. Further information is available from the Toronto Region Association of Computer Enthusiasts, POB 6922, Toronto, Ontario M5W 1X6, Canada.



July 10-11

**The Role of Microcomputers in Music Education.** Triton College, River Grove, IL. Seminars, workshops, demonstrations, and manufacturer displays will highlight this event. Topics of interest include ear training, improvisation, computer basics for the teacher, choosing the right computer, and using computers in music for the handicapped. The fee is \$25 a day; \$40 for both days. Contact Michael Ferrelli, Triton College, 2000 Fifth Ave., River Grove, IL 60171.

July 11-13

**The 1983 Summer Computer Simulation Conference.** Hyatt Regency, Vancouver, British Columbia, Canada. Full details are available from

the Society for Computer Simulation, POB 2228, La Jolla, CA 92038, (714) 459-3888.

July 11-15

**Technology Opportunity Conference.** Los Angeles, CA. For details, see June 14-16.

July 12-14

**Audio-Visual America.** Hyatt Regency Hotel, Chicago, IL. The second annual Audio-Visual America will feature hardware and software exhibits, screenings of shows, and approximately 60 workshops on planning, production, and management. For more information, contact A-V America, IF Associates, 3150 Spring St., Fairfax, VA 22031, (703) 273-8272.

July 14-16

**Personal Computer Interfacing and Scientific Instrument Automation.** Charleston, SC. For details, see June 2-4.

July 18-28

**Microcomputer-based Instrumentation for Schools.** Middletown, OH. This workshop is designed for secondary school and college science and mathematics teachers. Participants will learn how to construct and use simple, low-cost analog-to-digital (A/D) and digital-to-analog (D/A) converters for monitoring and controlling physical phenomena in the classroom and laboratory. Contact Bill Rouse, 301E McGuffey Hall, Miami University, Oxford, OH 45056, (513) 529-2141.

July 25-28

**The World of CAD/CAM.** Dunfee's Resort, Hyannis, MA. For details, see June 27-30.

July 25-29

**Robot Manipulators, Computer Vision, and Automated Assembly.** Artificial Intelligence Laboratory, Massachusetts Institute of Technology, Cambridge, MA. The emphasis of this short course will be on developing strategies for the solution of problems that will arise in advanced automation: sensing, spatial reasoning, and manipulation. The use of current industrial robots and binary vision systems will be covered. For details, contact the Director of the Summer Session, Room E19-356, Massachusetts Institute of Technology, Cambridge, MA 02139.

July 20-21

**Token-based Local Networks.** Washington, DC. This program is the second of four parts in the Architecture Technology Corporation's 1983 Forum Series. The series will bring together manufacturers and users of local network schemes to exchange information in an informal setting. The format includes presentations, panel discussions, and a technological summary. The fee is \$395 per person. For details, contact the Architecture Technology Corp., POB 24344, Minneapolis, MN 55424, (612) 935-2035.

July 25-29

**SIGGRAPH '83.** Detroit, MI. This is the tenth annual conference on computer graphics and interactive techniques sponsored by the Special-Interest Group on Computer Graphics of the Association for Computing Machinery (SIGGRAPH ACM). This show features tutorials, films and video tapes, exhibits of computing equipment, and a formal technical program. For full details, contact the SIGGRAPH '83 Conference Office, 111 East Wacker Dr., Chicago, IL 60601, (312) 644-6610. ■

## MICROSTAT® - Release 3.0

### MICROSTAT® + baZic® = PERFORMANCE

The best just got better! MICROSTAT has been the leader in the statistics field for microcomputers since 1979, and the new release 3.0 outperforms and is noticeably faster than previous versions. Just a few of the features include:

#### GREATER ACCURACY

BCD with up to 14 digit precision;

#### PROGRAM ENHANCEMENTS

Missing data capabilities and many more;

#### FASTER EXECUTION

Calculation time greatly reduced;

#### DYNAMIC FILE ALLOCATION

Data can be inserted, added, or deleted;

#### SPECIAL PRICE:

For a limited time get MICROSTAT plus baZic complete with program disk and documentation for each for \$395.00, save \$50.00!

The MICROSTAT - baZic version requires: a Z80 CPU, CP/M™ and 48K of memory. Available formats: 8" SD disk or 5¼" North Star only. Check with your dealer for other formats. Also available for: Microsoft's Basic-80™, North Star DOS and IBM. For more information, call or write:

### ECOSOFT INC.

P.O. Box 88602  
Indianapolis, IN 46268-0602  
(317) 255-6476



MICROSTAT is a registered trademark of ECOSOFT, INC  
baZic is a registered trademark of MICROMIKES, INC  
CP/M is a registered trademark of DIGITAL RESEARCH  
Basic-80 is a registered trademark of MICROSOFT

In order to gain optimal coverage of your organization's computer conferences, seminars, workshops, courses, etc, notice should reach our office at least three months in advance of the date of the event. Entries should be sent to: Event Queue, BYTE Publications, POB 372, Hancock NH 03449. Each month we publish the current contents of the queue for the month of the cover date and the two following calendar months. Thus a given event may appear as many as three times in this section if it is sent to us far enough in advance.

# Software Received

## Apple

**Bolo**, an arcade-type game. You must maneuver your tank through the maze to avoid or destroy enemy tank bases. This game features nine levels of play and five maze densities. For the Apple II; floppy disk, \$34.95. Synergistic Software, Suite 201, 830 North Riverside Dr., Renton, WA 98055.

**Graphical Analysis**. With this graphics-utility program, you can plot graphs based on numerical data in high-resolution graphics. This program is designed to be especially useful for science classes. For the Apple II; floppy disk, \$24.95. Vernier Software, 2920 Southwest 89th St., Portland, OR 97225.

**Killer T-Cell**, an educational-maze game based on biomedical discoveries in cancer research. You control the movements of a T-lymphocyte, a type of white blood cell that destroys cancer cells. All proceeds will fund cancer research at the University of Texas System Cancer Center. For the Apple II; floppy disk, \$20. Killer T-Cell, M. D. Anderson Hospital and Tumor Institute, Texas Medical Center, Box 6, 6723 Bertner Ave., Houston, TX 77030.

**LIMITS Programs for Calculus Students**, an introductory calculus course that covers the fundamentals of the derivative and integral with graphics, drills, and explanations. For the Apple II Plus; floppy disk, \$65. Dale T. Hoffman, Division of Science and Mathematics, College of the Virgin Islands, St. Thomas, U.S. Virgin Islands 00801.

**Math I**, a tutorial program

that covers basic mathematical skills up to simple algebra for grades 1 through 8. For the Apple II Plus; floppy disk, \$38. Personal Computer Art, 1007 Far Hills Dr., East Peoria, IL 61611.

**Nutritionist**. Using interactive graphics, this diet-analysis program helps you develop nutritionally balanced meals and diets for both personal and professional uses. For the Apple II; floppy disk, \$145. N-Squared Computing, 5318 Forest Ridge Rd., Silverton, OR 97381.

**Precision Timer**. Using auxiliary equipment, this utility program turns the computer into a flexible laboratory timer. Save timing data on disk and analyze it later. For the Apple II; floppy disk, \$39.95. Vernier Software (see address above).

**Ray Tracer**, a program on the laws of geometrical optics. See how light behaves when you place various interfaces and optical devices on the screen and produce ray diagrams. For the Apple II; floppy disk, \$24.95. Vernier Software (see address above).

**Secur-A-Text**, a data-encryption/decryption program that prevents files from being loaded into your computer unless you know the master- and local-code key numbers for access. For the Apple II; floppy disk, \$49.95. T & F Software Co., 10902 Riverside Dr., North Hollywood, CA 91602.

**Stan**, a statistical-analysis system. You can enter data to analyze for variance or regression coefficients and produce a graph. For the Apple II; floppy disk, \$300. Statistical Consultants, Park Plaza Office Bldg., 462 East High St., Lexington, KY 40508.

**Taxmode**, a tax-planning program. You can compute the components of individual federal income tax liability for the years from 1980 to 1985 according to current tax laws. For the Apple II Plus; floppy disk, \$250. J. P. Sawhney & Co. Inc., 888 Seventh Ave., New York, NY 10106.

**Trickster Coyote**, an educational word game that will help increase a child's vocabulary. With animations in high-resolution graphics and sound, this program is for four players age 8 and older and includes a built-in dictionary. For the Apple II; floppy disk, \$48.96. Reader's Digest Services Inc., Micro-computer Software Div., Pleasantville, NY 10570.

**Word Attack**, a four-part educational word-game program helps build vocabulary skills by displaying up to 675 words in illustrative sentences for students age 8 through adult. For the Apple II Plus; floppy disk, \$49.95. Davidson & Associates, 6069 Groveoak Place #12, Rancho Palos Verdes, CA 90274.

## Atari

**P.M.P. 2000**, a property-management program. This program is a template for Visicalc to help you maintain status reports, invoicing, and income/expense schedules on rental properties. For the Atari 800; floppy disk, \$219.95. T & F Software Co., 10902 Riverside Dr., North Hollywood, CA 91602.

**Reactor**, an arcade-type game. Your ship is trapped in a nuclear reactor. You must bounce dangerous nuclear particles into the control rods to prevent a meltdown of the reactor. For the Atari Video

Game System; cartridge, \$30. Parker Brothers, POB 1012, Beverly, MA 01915.

**Slot Trivia**, a question-and-answer game. If you can answer a trivia question in one of eleven categories, the slot machine will pay off. For two players. For the Atari 400/800; floppy disk, \$29.95. T & F Software Co. (see address above).

**Survival of the Fittest**, a strategy game. You and another player design colonies of organisms and fight for resources and space in a struggle for survival. For the Atari 400/800; cartridge, \$39.95. Innovative Design Software Inc., POB 1658, Las Cruces, NM 88004.

## CP/M

**Buysel**, several mathematical-analysis programs. This package is designed to help investors decide what to buy and sell in the stock, commodities, and options markets. For CP/M-based systems; floppy disk, \$125 (Canadian funds). Software City, 35 Downsview Cres., Nepean, Ontario K2G 0A4, Canada.

**Calendar/1**, a calendar-generation program that lets you print out a personalized calendar displaying your events planned for each day. Formatting commands allow for customized calendar designs. For CP/M-based systems; floppy disk, \$60. Clear Systems, Suite 404, 309 Santa Monica Blvd., Santa Monica, CA 90401.

**E/T**, a text-oriented screen editor. This program offers all essential editing features. It can be reconfigured for different terminals and automatically backs up your files. For



CP/M-based systems; 8-inch floppy disk, \$95. Softwest Products, 11379 Kelowna Rd., San Diego, CA 92126.

M/PC, a custom disassembler. This program will disassemble an unmodified version of CP/M 2.2. It also provides a source code complete with labels and comments keyed to each address. For CP/M-based systems; 8-inch floppy disk, \$35. C. C. Software, 2564 Walnut Blvd. #106, Walnut Creek, CA 94598.

Mailmate, a database-management program. Any of 15 fields of data entry in this program can be used for a sort or search. It also maintains mailing-label and customer lists, and can merge with some word-processing programs. For CP/M-based systems; floppy disk, \$99. Computerworks Inc., 4010-A Carlisle NE, Albuquerque, NM 87107.

Micro Pascal, a Pascal subset compiler that is specifically designed for control and interface applications. It requires 24K bytes of memory and includes a runtime program. For CP/M-based systems; floppy disk, \$175. Muson Engineering, 417 Montana Circle, Ojai, CA 93023.

Pathfinder, a project-planning and scheduling system. This set of four programs uses the critical path method to assist in the scheduling of up to 500 activities. For CP/M-based systems; 8-inch floppy disk, \$500. Garland Publishing Inc., 136 Madison Ave., New York, NY 10016.

RXWRITER, a prescription-writing program for physicians that maintains a list of drugs, prints two copies of each prescription, and creates a patient/pre-

scription file. For CP/M-based systems; 8-inch floppy disk, \$50. Hall Design, 250 Maple St., Wilmette, IL 60091.

Rhesus is an erased-file recovery program that recovers accidentally erased files not yet overwritten by other disk operations. It features both automatic- or user-controlled functions and help screens. For CP/M-based systems; floppy disk, \$65. Olsen Software, POB 91, Van Nuys, CA 91408.

---

### Commodore

Cosmic Bandit, an arcade-type game in which your task is to prevent the alien hordes from freeing their compatriots locked in the space jail. For the Commodore PET/CBM; floppy disk, £6. Supersoft, Winchester House, Canning Rd., Wealdstone, Harrow, Middlesex HA3 7SJ, England.

Cosmic Lemmings, an arcade-type game. Your mission is to destroy the aliens as they drop toward you from their mother ship. For the Commodore PET/CBM; floppy disk, £8. Supersoft (see address above).

The Cracks of Doom, an adventure-type game loosely based on *Lord of the Rings*. Features include a help command that may tell you something useful. For the Commodore PET/CBM; floppy disk, £16. Supersoft (see address above).

Goblin Towers. Designed as a starter game, this adventure will teach you many of the skills necessary to try more difficult games. For the Commodore PET/CBM; floppy disk, £14. Supersoft (see address above).

Lemuria, an adventure-type game. Lemuria and Atlantis, two superpowers of the ancient world, have ended diplomatic relations. You are able to plan their destinies. For the Commodore 64; cassette, \$8.95. RSVP Inc., 1332 Old Bridge Rd., Fort Myers, FL 33903.

Sidebar. This utility program lets you construct, edit, and save horizontal bar graphs with up to 17 variables. Graphs may then be reviewed, edited, and stored on tape. For the Commodore VIC-20; cassette, \$9.60. MFJ Electro Enterprises, POB 13076, Kanata, Ontario K2K 1X3, Canada.

Super Gloop, an arcade-type game. Four glooper eaters chase you around the maze as you gather dots to increase your score. If you eat a large dot, you can eat all of the gloopers. For the Commodore PET/CBM; floppy disk, £8. Supersoft (see address above).

Tank Zone, an arcade-type game. It's kill or be killed in this simulation of desert warfare. You must avoid the tanks and missiles that are trying to destroy you. For the Commodore PET/CBM; floppy disk, £8. Supersoft (see address above).

Typing Package. This touch-typing instructional program can be used alone or in a classroom. It includes a warm-up, type drill, and typing test. For the Commodore VIC-20; cassette, \$12.75. MFJ Electro Enterprises (see address above).

VIC-20 Games Pack, a set of five arcade-type games that includes Alien Blitz, Invaders, Ground Attack, Storm, and Space Rocks. For the Commodore VIC-20; cassette, \$14.95. Melbourne House Software Inc., 333

East 46th St., New York, NY 10017.

Word Search, an educational word game. You have 10 minutes to find 20 different words in any of three puzzles: Animals, Jumbled, or States and Capitals. For the Commodore VIC-20; cassette, \$19.95. T & F Software Co., 10902 Riverside Dr., North Hollywood, CA 91602.

---

### IBM Personal Computer

Buysel, several mathematical-analysis programs (see description under CP/M). For the IBM Personal Computer; floppy disk, \$125 (Canadian funds). Software City, 35 Downsview Cres., Nepean, Ontario K2G 0A4, Canada.

Cosmic Crusader, an arcade-type game in which your mission is to prevent a fleet of alien ships from reaching Earth. You must track them down, dodge their torpedoes, and destroy each ship. For the IBM Personal Computer; floppy disk, \$38.95. Fantastic Inc., 5-12 Wilde Ave., Drexel Hill, PA 19026.

Curvfit-3D, a polynomial surface-fitting program. High-resolution graphics permit 2-dimensional or 3-dimensional isometric plotting for visual analysis of statistical data. For the IBM Personal Computer; floppy disk, \$90. Petrospec, POB 3122, Richardson, TX 75080.

Easywriter II. Different from the IBM-distributed Easywriter 1.1, this word-processing program allows you to type in and edit text in a page- and mode-oriented environment. A utility pro-

gram is provided to transfer files to and from single-sided PC-DOS disks. For the IBM Personal Computer; floppy disk, \$350. Information Unlimited Software Inc., 2401 Marinship Way, Sausalito, CA 94965.

**Edix**, a text-editing program to be used in conjunction with the Wordix formatting program. Edix offers four on-screen editing windows and online tutorial lessons that teach you how to use editing commands such as flexible pattern search. For the IBM Personal Computer with PC-DOS; floppy disk, \$195. Emerging Technology Consultants Inc., 2031 Broadway, Boulder, CO 80302.

**The Final Word**, version 1.1, a word-processing program. A recent addition to a series of programs inspired by Richard Stallman's EMACS, this program offers multiple text buffers, two editing windows, and versatile formatting capabilities. A swap file on disk preserves text in the event of a system crash. For the IBM Personal Computer with PC-DOS; floppy disk, \$300. Mark of the Unicorn Inc., POB 423, Arlington, MA 02174.

**General Ledger**, this accounting package is part of a series of accounting packages that helps you establish and maintain a general ledger. For the IBM Personal Computer; floppy disk, \$199. Micro Architect Inc., 96 Dothan St., Arlington, MA 02174.

**Pmate**. Suitable for program source-code-file and general text editing, this text-editing program offers a full selection of primitive functions that can be combined into macrocommands to perform high-level tasks. For the IBM Personal Computer with PC-DOS; floppy disk, \$225.

Lifeboat Associates, 1651 Third Ave., New York, NY 10028.

**Powertext**, version 1.8, a word-processing program. Based on the editing structure of the UCSD p-System, Powertext provides extensive capabilities for putting text into different formats. Form letter, document, and memo are a few of the possible files. For the IBM Personal Computer; floppy disk, \$399. Beaman Porter Inc., Pleasant Ridge Rd., Harrison, NY 10528.

**Newkeys**, a utility program that lets you reconfigure the functions of your IBM PC keyboard by transforming it into a standard IBM Selectric or the Dvorak layout. For the IBM Personal Computer; floppy disk, \$19.95. Magi Software, 564 Chinquapin Dr., Eglin, FL 32542.

**Nutritionist**, a diet-analysis program (see description under Apple). For the IBM Personal Computer; floppy disk, \$145. N-Squared Computing, 5318 Forest Ridge Rd., Silverton, OR 97381.

**Versatext**, a word-processing and database system that includes the modules PCWriter, PCProcessor, PCBase, and PCGiant. For the IBM Personal Computer with PC-DOS; floppy disk, \$199.95. Texasoft, 1028 North Madison Ave., Dallas, TX 75208.

**Volkswriter**, version 1.2, a word-processing program. This program provides a variety of fast editing functions for beginners using word processing. Function keys are used for editing commands; other commands are invoked from on-screen menus. For the IBM Personal Computer with PC-DOS; floppy disk, \$195. Lifetree Software Inc.,

Suite 342, 177 Webster St., Monterey, CA 93940.

**Word Attack**, an educational word game (see description under Apple). For the IBM Personal Computer; floppy disk, \$49.95. Davidson & Associates, 6069 Groveoak Place #12, Rancho Palos Verdes, CA 90274.

**Word Wand**, a word-processing program. This page-oriented program supports the French-language character set. For the IBM Personal Computer with Monochrome Display Adapter and PC-DOS; floppy disk, \$340 (\$400 Canadian funds). Tanda Software Inc., POB 244, Orleans, Ontario K1C 1S7, Canada.

**Wordstar**, version 3.2, a word-processing program. This well-known product has been adapted from its CP/M-80 version with few changes. It features a multiple-menu command structure and on-screen text formatting. For the IBM Personal Computer with PC-DOS; floppy disk, \$495. Micropro International Corp., 33 San Pablo Ave., San Rafael, CA 94903.

---

## Texas Instruments

**Digger Duck**, an interactive maze game that requires strategy and patience. For the TI-99/4A; cassette, \$13.99. Vaughn Software, 5460 Harlan #84, Arvada, CO 80002.

**Mariner**, a maze-type puzzle game. As a seafaring adventurer, you must navigate through waters of changing depths using sight and sonar. For the TI-99/4A; cassette, \$16.99. Vaughn Software (see address above).

**Submarine Warrior**, an arcade-type game. You pilot a submarine through enemy waters diving and surfacing to avoid mines, whales, and depth changes. You can fire your missiles at targets for a high score. For the TI 99/4A; cassette, \$11.95. JW Software, 814 West Main St., Urbana, IL 61801.

---

## Timex/Sinclair

**Catacombs**, an adventure-type game. You are lost in one of several levels of the catacombs. In your struggle to survive you must locate food and gold while avoiding phantoms and monsters. For the Timex/Sinclair 1000 and ZX81; cassette, \$14.95. Melbourne House Software Inc., 333 East 46th St., New York, NY 10017.

**Gamestape 1**, a set of 11 game programs that includes Klingons, Crash Landing, Simon, UFO, Code, Asteroids, Bomber, Guillotine, Breakout, and others. For the Timex/Sinclair 1000 and ZX81; cassette, \$14.95. Melbourne House Software Inc. (see address above).

**Gamestape 2**, a set of three programs. Included are Starfighter, a space battle game; Pyramid, a strategy game; and Artist, a graphics-design program. For the Timex/Sinclair 1000 and ZX81; cassette, \$14.95. Melbourne House Software Inc. (see address above).

**3D Monster Maze**, an arcade-type game. See if you can find your way out of the maze with a Tyrannosaurus Rex chasing you. For the Timex/Sinclair 1000 and ZX81; cassette, \$14.95. Melbourne House Software Inc. (see address above).



**3D Orbiter**, an arcade-type game. You command the last surviving craft of your army. To defend your civilization you must battle against marauding invaders as you climb, bank, and dive in outer space. For the Timex/Sinclair 1000 and ZX81; cassette, \$14.95. Melbourne House Software Inc. (see address above).

**Videocalc**, an electronic-spreadsheet program that lets you input data and mathematical formulas and immediately see the answers. The program uses Sinclair BASIC functions. For the Timex/Sinclair 1000 and ZX81; cassette, \$9.95. P & B Software, 1155 East Malibu Dr., Tempe, AZ 85282.

**ZXAD**, an assembler/debugger. Assembler uses the entire Z80 instruction set and standard mnemonics. Source statements are entered as BASIC remark statements. Debugger displays or alters memory. For the Timex/Sinclair 1000 and ZX81; cassette, \$14.95. Scientific Software, 6 West 61 Terrace, Kansas City, MO 64113.

### TRS-80

**Arachnid Plus**, a set of three arcade-type games. In Arachnid you fight against a spider-like creature. In Warzone you must trap your opponent in a maze of squares. In Baja you race your dune buggy across a treacherous desert course. For the TRS-80 Models I and III; floppy disk, \$24.95. Computer Shack, 1691 Eason, Pontiac, MI 48054.

**Assault**, an arcade-type game. You must struggle to prevent various creatures from stealing your bags of

gold. For the TRS-80 Models I and III; floppy disk, \$24.95. Computer Shack (see address above).

**Cyborg**, an arcade-type game. Try to collect all 12 signal modules in your complex while avoiding or killing threatening robots. If you succeed, you can move on to more difficult complexes. For the TRS-80 Models I and III; floppy disk, \$24.95. Computer Shack (see address above).

**Deadline**, an interactive game. You are a detective who must solve a murder within 12 game hours. The program gives you all the clues you need. For the TRS-80 Model III; 5¼- and 8-inch floppy-disk formats, \$49.95 and \$59.95, respectively. For information, contact Infocom, 55 Wheeler St., Cambridge, MA 02138.

**Financial Planning for Visicalc**, a set of 17 templates for use with the Visicalc electronic-spreadsheet system. For the TRS-80 Model II; floppy disk, \$59.95. Howard W. Sams & Co. Inc., 4300 West 62nd St., POB 7092, Indianapolis, IN 46206.

**Hexman**, a disk-management system. The Hexman program runs under LDOS and can monitor file activity for easier storage and retrieval. It also makes daily backups of modified files. For the TRS-80 Models I and III; floppy disk, \$169. Hexagon Systems, POB 397, Station A, Vancouver, British Columbia V6C 2N2, Canada.

**Jovian**, an arcade-type game. The Jovians are arch-enemies of Earth and must be stopped. If you can hit their space stations with your rapid-fire plasma bullets you will destroy them. For the TRS-80 Models I and III; floppy disk, \$24.95. Com-

puter Shack (see address above).

**Liberator**, an arcade-type game. Your robot has gone berserk and hidden your four assistants in a hazardous industrial park. Rescue your assistants while avoiding the robot. For the TRS-80 Models I and III; floppy disk, \$24.95. Computer Shack (see address above).

**Listmaker**, a database-management program that can handle lists for business, home, or school; personalize and print form letters; and sort and search on one or multiple fields. For the TRS-80 Models I and III; floppy disk, \$97.50. Reader's Digest Services Inc., Micro-computer Software Division, Pleasantville, NY 10570.

**Starcross**, an adventure-type game. Your ship has found a gigantic alien starship. In order to discover its treasures, you must dock and explore its mysterious interior. For the TRS-80 Model III; 5¼- and 8-inch floppy-disk formats, \$39.95 and \$49.95 respectively. For information, contact Infocom, 55 Wheeler St., Cambridge, MA 02138.

**T.B.B.S.**, an electronic bulletin-board system. You can custom design your own system format without writing a program code. Set up your own computerized message board from 25 types. For the TRS-80 Models I and III; floppy disk, \$149.95. Ebert Personal Computers Inc., 4122 South Parker Rd., Aurora, CO 80014.

### Other Computers

**Buyssel**, several mathematical-analysis programs (see description under CP/M). For CDOS/Cromix; floppy disk, \$125 (Canadian funds). Software City, 35 Downsview Cres., Nepean, Ontario K2G 0A4, Canada.

**Portfolio Manager**, a stock-management program. Enter current stock prices and you receive a one-page report showing 19 classes of information about your stock. For the Heath/Zenith H-/Z-89; floppy disk, \$25. RCK Associates, 640 Trephanny Lane, Wayne, PA 19087. ■

This is a list of software packages that have been received by BYTE Publications during the past month. The list is correct to the best of our knowledge, but it is not meant to be a full description of the product or the forms in which the product is available. In particular, some packages may be sold for several machines or in both cassette and floppy-disk format; the product listed here is the version received by BYTE Publications.

This is an all-inclusive list that makes no comment on the quality or usefulness of the software listed. We regret that we cannot review every software package we receive. Instead, this list is meant to be a monthly acknowledgment of these packages and the companies that sent them. All software received is considered to be on loan to BYTE and is returned to the manufacturer after a set period of time. Companies sending software packages should be sure to include the list price of the packages and (where appropriate) the alternate forms in which they are available.

# Books Received

*Apple Files*, David Miller. Reston, VA: Reston Publishing Co., 1982; 414 pages, 38 by 56 cm, hardcover, ISBN 0-8359-0192-0, \$19.95.

*Atari PILOT for Beginners*, Jim Conlan and Tracy Deliman. Reston, VA: Reston Publishing Co., 1983; 229 pages, 36 by 54 cm, softcover, ISBN 0-8359-0301-X, \$14.95.

*Atari Sound and Graphics, A Self-Teaching Guide*, Herb Moore, Judy Lower, and Bob Albrecht. New York: John Wiley & Sons, 1982; 234 pages, 40.6 by 60 cm, softcover, ISBN 0-471-09593-1, \$9.95.

*BASIC Exercises for the IBM Personal Computer*, J. P. Lamoitier. Berkeley, CA: Sybex, 1982; 251 pages, 42 by 54 cm, softcover, ISBN 0-89588-088-1, \$13.95.

*A BASIC Programmer's Guide to Pascal*, Mark J. Borgerson. New York: John Wiley & Sons, 1982; 118 pages, 40.6 by 60 cm, softcover, ISBN 0-471-09293-2, \$9.95.

*CICS/VS Command Level with ANS COBOL Examples*, Pacifico A. Lim. New York: Van Nostrand Reinhold, 1982; 576 pages, 38 by 56 cm, hardcover, ISBN 0-442-22607-1, \$29.95.

*Communications and the Future, Prospects, Promises, and Problems*, Howard F. Didsbury Jr., ed. Bethesda, MD: World Future Society (4916 St. Elmo Ave.), 1982; 357 pages, 36 by 54 cm, softcover, ISBN 0-930242-16-5, \$14.50.

*Computer Simulation in Business*, Hugh J. Watson. New York: John Wiley & Sons, 1981; 358 pages, 46 by 56 cm, hardcover, ISBN 0-471-03638-2, \$28.95.

*The Creative Apple*, Mark Pelczarski and Joe Tate, eds. Morristown, NJ: Creative Computing Press (POB 789M), 1982; 448 pages, 50 by

65.6 cm, softcover, ISBN 0-916688-25-9, \$15.95.

*The DP Professional's Guide to Writing Effective Technical Communications*, J. Van Duyn. New York: John Wiley & Sons, 1982; 218 pages, 40 by 57 cm, hardcover, ISBN 0-471-05843-2, \$22.95.

*Fast BASIC, Beyond TRS-80 BASIC*, George A. Gratzner with Thomas G. Gratzner. New York: John Wiley & Sons, 1982; 278 pages, 40.6 by 60 cm, softcover, ISBN 0-471-09849-3, \$14.95.

*Handbook of Advanced Robotics*, Edward L. Safford Jr., Blue Ridge Summit, PA: Tab Books, 1982; 468 pages, 31 by 49.6 cm, softcover, ISBN 0-8306-1421-4, \$15.95.

*How to Buy a Personal Computer*, Carlton Shrum. Sherman Oaks, CA: Alfred Publishing Co. (POB 5964), 1982; 64 pages, 25.6 by 66 cm, softcover, ISBN 0-88284-188-2, \$2.95.

*How to Select a Business Computer*, Billie Cayot, David Campbell, and Norm Stone. Oakland, CA: Oasis Press (POB 6836), 1982; 215 pages, 63 by 70 cm, hardcover, ISBN 0-916378-17-9, \$29.95.

*The Illustrated Word Processing Dictionary*, Russell A. Stultz. Englewood Cliffs, NJ: Prentice-Hall, 1983; 170 pages, 37 by 56 cm, hardcover, ISBN 0-13-450726-6, \$17.95.

*Information Resource Management, Opportunities and Strategies for the 1980s*, William R. Synnott and William H. Gruber. New York: John Wiley & Sons, 1981; 356 pages, 40 by 57 cm, hardcover, ISBN 0-471-09451-X, \$27.95.

*Inside CP/M*, David E. Cortesi. New York: Holt, Rinehart and Winston, 1982; 571 pages, 44.6 by 55.6 cm,

softcover, ISBN 0-03-059558-4, \$23.95.

*Introduction to BASIC Programming*, Gary B. Shelly and Thomas J. Cashman. Brea, CA: Anaheim Publishing Co. (2632 Saturn St.), 1982; 406 pages, 44 by 55 cm, softcover, ISBN 0-88236-118-X, \$14.95. Includes transparency masters.

*An Introduction to Computers and Information Processing*, Robert A. Stern and Nancy Stern. New York: John Wiley & Sons, 1982; 637 pages, 45.6 by 56.6 cm, hardcover, ISBN 0-471-08723-8, \$20.95.

*Introduction to Computer Architecture and Organization*, Harold Lorin. New York: John Wiley & Sons, 1982; 311 pages, 40 by 57 cm, hardcover, ISBN 0-471-86679-2, \$25.

*Learning BASIC Step by Step*, Vern McDermott and Diana Fisher. Rockville, MD: Computer Science Press, 1982; 139 pages, 52 by 32 cm, hardcover, ISBN 0-914894-49-8, \$15.95.

*The Microcomputer Builders' Bible*, Chris Johnston. Blue Ridge Summit, PA: Tab Books, 1982; 314 pages, 30.6 by 49.6 cm, softcover, ISBN 0-8306-1473-7, \$12.95.

*1983 Classroom Computer News Directory of Educational Computing Resources*. Watertown, MA: Intentional Educations (341 Mt. Auburn St.), 1982; 201 pages, 50 by 66 cm, softcover, ISBN 0-9607970-0-9, \$14.95.

*The Power of Multiplan*, Robert E. Williams. Portland, OR: Management Information Source (3543 Northeast Broadway), 1982; 168 pages,

## Epson, OKI, IDS, NEC, Diablo, Qume



### ACOUSTIC ENCLOSURES

- Reduces Noise Up to 90%
- Heavy Duty Acrylic Cover
- Bottom Feed Capability
- Woodgrain Finish



### Micro Printercenter™

Dealer & Ordering Info  
800-343-4311

Master Charge and VISA Accepted  
Shipping & Handling Charge Additional

### CAB-TEK, Inc.

Riverside St. Nashua, NH 03062  
CIVILIZING COMPUTERS

MPC I \$99 (MK 80) MPC II \$129 (OKI82)  
MPC III \$179 (83A, MK100) MCP IV \$199 (Daisy Printer)  
Power Control & Ventilation 580  
Paper Rack 530 Bottom Feed Brackets 530  
MPC I SHOW





IBM-PC SPECIALS:

AST Research Exp. Board 64K—\$279, 128K—\$369, 192K—\$489, 256K—\$569. Combo/Mega Plus available. Quadram 256K par...

CP/M SPECIALS:

Televideo TS 802 64K, 4MHz, Z80A, 5 1/4" Dual Floppies—\$2639 Cromemco C-10SP—\$1698 Teletek Systemaster I—\$674 Scion...

APPLE SPECIALS:

Microsoft Prem Pak—\$469 MicroSci Drive—\$289 Controller—\$85 J-Cat Modem—\$119 Advance Logic CP/M Plus—\$299

Epson MX 100—\$629 Citih Prowriter—\$429 Citih F-10 Parallel or Serial—\$1325 NEC 3550 Printer—\$1965, Ribbons

SPECIAL DEPARTMENT FOR UNIVERSITIES, ASK FOR ANNE. WE ACCEPT LIMITED PO'S. ALL PRICES FOB, EL TORO, CA AND SUBJECT TO CHANGE— PLEASE CALL FIRST.



Suite #186 • 25422 Trabuco Rd., #105 El Toro, CA 92630 (714) 768-8114

RadioShack TRS-80's Full Line



YOU CAN SAVE money when you buy Radio Shack TRS-80 Computers from Pan American Electronics. Pan American Electronics went into business in 1976 and led the way in bringing consumers original Radio Shack TRS-80 Computers at reduced prices.

Pan American Electronics

TOLL FREE NUMBER 800/531-7466

1117 Conway Avenue • Department B Mission, Texas 78572 Phone: 512/581-2766 Telex Number 767339

TM — Trademark of Tandy Corporation

Books Received

51 by 64.6 cm, softcover, ISBN 0-13-687343-X, \$14.95.

Practical BASIC Programs: IBM Personal Computer Edition, Lon Poole, ed. Berkeley, CA: Osborne/McGraw-Hill, 1982; 170 pages, 50 by 65 cm, softcover, ISBN 0-931988-80-2, \$15.99.

Programming the IBM Personal Computer: BASIC, Neill Graham. New York: Holt, Rinehart and Winston, 1982; 287 pages, 42 by 55 cm, softcover, ISBN 0-03-061911-4, \$16.95.

Programming the TI-59 & the HP-41 Calculators, Paul Garrison. Blue Ridge Summit, PA: Tab Books, 1982; 294 pages, 31 by 50 cm, softcover, ISBN 0-8306-1442-7, \$12.95.

Science and Engineering Sourcebook, Cass R. Lewart. Englewood Cliffs, NJ: Prentice-Hall, 1982; 96 pages, 36 by 54 cm, softcover, ISBN 0-942412-02-8, \$9.95.

Software Blueprint and Examples, Yaohan Chu. Lexington, MA: Lexington Books, 1982; 519 pages, 40 by 56 cm, hardcover, ISBN 0-669-05329-5, \$39.95.

Structured Programming Using PL/I, 2nd ed., J. N. P. Hume and R. C. Holt. Reston, VA: Reston Publishing Co., 1982; 400 pages, 43.6 by 57 cm, hardcover, ISBN 0-8359-7133-3, \$19.95.

TRS-80 Color Basic, Bob Albrecht. New York: John Wiley & Sons, 1982; 378 pages, 40.6 by 60 cm, softcover, ISBN 0-471-09644-X, \$9.95.

Understanding BASIC, Richard G. Peddicord. Sherman Oaks, CA: Alfred Publishing Co. (POB 5964), 1981; 48 pages, 25.6 by 66 cm, softcover, ISBN 0-88284-146-7, \$2.95.

Understanding COBOL, Richard G. Peddicord. Sherman Oaks, CA: Alfred Publishing Co. (POB 5964), 1981; 47 pages, 25.6 by 66 cm, softcover, ISBN 0-88284-147-5, \$2.95.

Understanding Computers,

Donald D. Spencer. Ormond Beach, FL: Camelot Publishing Co. (POB 1357), 1982; 400 pages, 36 by 54 cm, softcover, ISBN 0-89218-057-9, \$13.95.

Understanding Computers, What Managers and Users Need to Know, Myles E. Walsh. New York: John Wiley & Sons, 1982; 266 pages, 35 by 54 cm, softcover, ISBN 0-471-87417-5, \$14.95.

Understanding Data Base Management, Michael J. Freiling. Sherman Oaks, CA: Alfred Publishing Co. (POB 5964), 1982; 63 pages, 25.6 by 66 cm, softcover, ISBN 0-88284-221-8, \$2.95.

Understanding FORTRAN, Herbert R. Ludwig. Sherman Oaks, CA: Alfred Publishing Co. (POB 5964), 1981; 63 pages, 25.6 by 66 cm, softcover, ISBN 0-88284-148-3, \$2.95.

Up the EDP Pyramid, The Complete Job Hunting Manual for Computer Professionals, Jack French. New York: John Wiley & Sons, 1982; 185 pages, 35 by 54 cm, softcover, ISBN 0-471-87117-6, \$12.50.

Visicalc by the User for the User, Jim Englander, ed. Scarsdale, NY: Intercalc (POB 254), 1982; 80 pages, 51 by 66 cm, softcover, ISBN 0-911095, \$10.

Word Processing Handbook, Ivan Flores. New York: Van Nostrand Reinhold, 1983; 552 pages, 38 by 56 cm, hardcover, ISBN 0-442-22526-1, \$34.50. ■

This is a list of books received at BYTE Publications during this past month. Although the list is not meant to be exhaustive, its purpose is to acquaint BYTE readers with recently published titles in computer science and related fields. We regret that we cannot review or comment on all the books we receive; instead, this list is meant to be a monthly acknowledgment of these books and the publishers who sent them.

Conducted by Steve Clarcla

## Traveling Computers

Dear Steve,

We are considering buying a personal computer and have been looking for information in BYTE. We currently live in the Philippines, which makes comparison shopping difficult: information is limited and somewhat dated. We will be home on leave in the fall and hope to bring a computer back with us. We would appreciate any information, advice, or suggestions you might give us on computers, peripherals, and so on. We would like a computer for the following:

- Word processing, especially letter-quality printing. Is there a dot-matrix impact printer that would be satisfactory, or are formed characters necessary?
- We play complex strategy/tactics games, such as recreating World War II battles. Which computer has the best, most complex games of this type? Do you know any company besides Avalon Hill that makes this type of game?
- Educational programs for a ninth grader.
- Color graphics and color video monitor are a must. Is a color monitor suitable for word processing? designing needlepoint?
- We'd like to catalog a stamp collection, keep track of constantly changing titles in a small library, and have a typing tutor.
- What about future expansion?

We would like to stay under \$4000. Size and weight are important. How necessary are two disk drives? Would a double-sided double-density disk drive be worth the extra cost? Shape is also a factor.

Three of us have to bring it back on a plane. Reliability is most important; service here is nonexistent or of dubious quality. We will probably not be back in the States for at least two years.

In the Philippines, there are power fluctuations and outages. We have air conditioning, but with the power out, it's hot and humid. There are lots of insects and dust. If these conditions don't prohibit a computer, how do we protect it?

Finally, can an 8-bit computer have more than 64K bytes of user memory? Thank you for your help,  
Ronald A. Alasin  
Philippines

*Choosing a computer for your applications is not half as difficult as determining the reliability of such a unit in the environment you describe. Let's address that aspect first.*

*Any computer that you purchase in the States will be designed to run off of 120 V (volts) at 60 Hz (hertz) AC. If your power in the Philippines is different than this, you will need a power converter and possibly a means to change the line frequency. One way around this would be to obtain a power inverter that would convert 12 V DC to 120 V AC at 60 Hz. This unit could then be powered by either battery or a 12-V DC supply designed for the local power requirements.*

*If power outages and fluctuations are frequent, you must assess the impact on your computing tasks. If you are greatly inconvenienced by fluctuations and outages (which cause the computer to crash), then an uninterruptible power supply may be required. This is a unit that instantly (for all practical pur-*

*poses) switches from line to battery power in the event of an outage.*

*Insects and dust will be detrimental to your disks unless you take proper precautions. The heat may or may not be a problem, depending on the length of time that the computer is in use and whether or not it has a built-in fan.*

*As far as reliability is concerned, one must examine the record of the computers now on the market. Certainly, those that have been in production for awhile have had time to establish a reputation.*

*Because high-resolution graphics and color are requirements, and a large variety of software is suggested, I would lean toward either the Apple II or Apple IIe computer. You may need several accessory boards to drive a printer and an 80-column screen, but for your price range, it is a good choice. The Apple II has been around long enough to establish its reliability. One disk drive should suffice for most applications, but an extra drive adds convenience. Double-sided, double-density disks are not worth the extra price, in my opinion. Many disk manufacturers frown on using both sides of a disk because it adds extra abrasion to the data on the first side. In your dusty environment, it is not worth the chance.*

*For letter-quality printing, a high-quality dot-matrix printer should suffice, but this is a personal choice. Some pretty good letter-quality daisy-wheel printers costing less than \$1000 are on the market. They are not terribly fast, but their reliability seems to be acceptable.*

*An 8-bit computer can have more than 64K bytes of memory, but it addresses only 64K bytes at any one time. A tech-*

*nique known as bank selecting is used to enable one of several 64K-byte blocks of memory.*

*Finally, Strategic Simulations (Suite 108, 465 Fairchild Dr., Mountain View, CA 94043) has a variety of complex strategy/tactic games for the Apple II. I hope that this gives you some guidelines on your purchases. Buy before you leave and run all units for as long as possible then so that any premature failures can be corrected. . . . Steve*

## Inside Level II ROMs

Dear Steve,

I have a TRS-80 Model I Level II. I presently write 99% of my programs in machine-language. As you know, there are a lot of programs in the Model I's ROM (read-only memory) that handle, for example, the keyboard. I called Radio Shack to get a source-code listing of those programs, but they are not available. Can you tell me where I can get those listings?  
Francois Paquin  
Sarnia, Ontario, Canada

*Mumford Micro Systems has a book that explains the inner workings of the Radio Shack TRS-80 Models I and III Level II ROMs. It contains information on set-ups, calling sequences, and variable passage for number conversion, arithmetic operations, etc. In addition, it is a very useful reference manual with information on RAM usage, relocation of BASIC programs, USR call expansion, and creating system tapes of your programs. The book, Inside Level II—The Programmer's Guide to the TRS-80 ROMs, costs \$15.95 (plus \$2 postage) and can be ordered from Mumford Micro Systems, POB 400-D, Summer-*



**DISK DRIVE WOES?  
PRINTER INTERACTION?  
MEMORY LOSS?  
ERRATIC OPERATION?**

# Don't Blame The Software!



Power Line Spikes, Surges & Hash could be the culprit! Floppies, printers, memory & processor often interact! Our patented ISOLATORS eliminate equipment interaction AND curb damaging Power Line Spikes, Surges and Hash. **MONEY BACK GUARANTEE!**

- ISOLATOR (ISO-1) 3 filter isolated 3-prong sockets; integral Surge/Spike Suppression; 1875 W Maximum load, 1 KW load any socket ..... \$78.95
- ISOLATOR (ISO-2) 2 filter isolated 3-prong socket banks; (6 sockets total); integral Spike/Surge Suppression; 1875 W Max load, 1 KW either bank ..... \$78.95
- SUPER ISOLATOR (ISO-3) similar to ISO-1 except double Isolation & Suppression ..... \$115.95
- SUPER ISOLATOR (ISO-11) similar to ISO-2 except double Isolation & Suppression ..... \$115.95
- MAGNUM ISOLATOR (ISO-17) 4 Quad isolated sockets; For ULTRA-SENSITIVE Systems ..... \$200.95
- CIRCUIT BREAKER, any model (Add-CB) ..... Add \$10.00
- REMOTE SWITCH, any model (Add-RS) ..... Add \$18.00

AT YOUR DEALERS

MasterCard, Visa, American Express  
ORDER TOLL FREE 1-800-225-4878  
(except AK, HI, PR & Canada)

**ESP Electronic Specialists, Inc.**  
171 South Main Street, Box 388, Natick, Mass. 01760  
(617) 655-1532

## Ask BYTE

land, CA 93067, (805) 969-4557. . . . Steve

compiler for the 6809. . . . Steve

### Colorful Computer Questions

Dear Steve,

I'm wondering if you, or some of your readers, could answer a couple of questions regarding the Radio Shack Color Computer.

1. Is there any way to get more than 32 characters per line? I bet someone is working on it, but I haven't seen any solutions except that achieved by Cognitec in its Telewriter word-processing program.
2. Have you any information on a BASIC compiler for the Motorola 6809 in the Color Computer (or does the type of processor make very much difference anyway)? It sure would be handy.

Thanks.  
Duff Kennedy  
Santa Barbara, CA

The video-display format for the Radio Shack Color Computer is controlled by the Motorola 6847 Video Display Generator chip, and the number of characters per line that are displayed on the screen is a function of the mode that the chip is in. For alphanumeric, the format is 16 lines of 32 characters each. Using the high-resolution graphics mode of 256 by 192 pixels, an alternate character set can be graphically defined and more characters obtained. For example, if a 5 by 7 font is used with one blank dot between characters, then  $256/6=42$  characters per line. See "What's Inside Radio Shack's Color Computer," by Ahrens, Browne, and Scales (March 1981 BYTE, page 90).  
I'm sorry but I don't have any information on a BASIC

### More Colorful Questions

Dear Steve,

In the May 1982 BYTE, you answered a question about video-display problems on the TRS-80 Color Computer (see "TV Jitter Bugs," page 398). You did not comment on one proposed solution to the problem of interference: is it possible to remove the RF (radio-frequency) modulator and go directly to a video monitor? What about the sound? Because most monitors have a sound input, is it possible to tie that output directly to a monitor?

Thanks for the help.  
Mark Ososki  
Mount Clemens, MI

If the interference problem referred to in that Ask BYTE letter was caused by the vertical synchronization signal being slightly off frequency, removing the RF modulator will not solve the problem. The modulator only takes the composite-video signal (video, horizontal synchronization, and vertical synchronization) and superimposes a carrier signal upon it so that the video may be received on a television set.

The RF modulator can be removed from the Color Computer. The composite-video signal is then available at pin 1 of the modulator unit and the sound is at pin 3. These outputs can then be fed into the sound and video inputs of a monitor. Of course, the standard caution of voiding the warranty by tampering with the computer applies. . . . Steve

### ZX81 Power Backup

Dear Steve,

One rainy day, when just finishing a perfect program on

# SCOTT ADAMS' ADVENTURES

NOW FOR **NEW**

## Northstar, CP/M (Z-80) & Model II TRSDOS

The bestselling Adventure series by Scott Adams is now available for Northstar, CP/M (Z-80) and Model II TRSDOS users! This is the original Adventure series which has received rave reviews in every major computer magazine. Order now! 8" Disk of ALL 12 Adventures \$129.95

Minimum 24K • Single density • Soft sector • Single side  
Converted to run under CP/M by Russ Wetmore  
A Division of Scott Adams, Inc.  
Adventure International • Box 3435 • Longwood, FL 32760  
TOLL-FREE ORDER NUMBER: (800) 327-7172  
NO FLORIDA SALES TAX

**Dealer Inquiries Invited**

Please Specify CP/M or TRSDOS

my ZX81, the power went out and I lost my program. I want to prevent this from happening again. Do you know of any way to add battery backup to the ZX81 without spending a lot of time and money?

The ZX81 requires 9.75 V (volts) at 650 milliamperes (mA); however, my multimeter indicates that the AC line adapter puts out 15 V without the computer connected. Also, what is the amperage available from a common 9-V battery?

Z. Smith  
West Grove, PA

One way to prevent power loss to your Sinclair ZX81 is to use a 12-V DC supply with an automotive storage battery in parallel across it. The ZX81 has a 5-V regulator inside to drop the input voltage to the necessary 5 V, and with a 12-V input, only a little extra heat will be generated. If this is undesirable, a series-dropping resistor between the power supply and the ZX81 will restore original conditions. In the event of a power failure, the computer will continue to run from the storage battery. When power is restored, the DC supply will take over and also recharge the battery.

A common 9-V battery has a current output of 20 to 40 mA; many would need to be paralleled to drive the computer. The AC line adapter output measures 15-V because there is no load in the circuit. If you put a load (such as the computer) across the supply, the voltage will drop to the specified range. . . . Steve

### Hot and Cold Computers

Dear Steve,

Have briefcase computers been tested in variable temperature situations? Going from a 75° F house to the car

in the winter at -25° F might cause some type of electronic damage or damage to the floppy disks that are stored in the units (as in the Osborne). I live in Wisconsin. Considering the wide temperature range, should I buy a portable computer?

Paschal A. Frigo  
Green Bay, WI

You raise an interesting question. Shugart, for example, specifies an ambient operating temperature range for its Model SA 400 floppy-disk drive of 40° to 115° F. As the temperature drops, the potential for mechanical sluggishness increases and this may result in erratic data transfers.

Floppy disks have a storage requirement of 50° to 125° F. One can only guess as to the flexibility of a disk at extremely low temperatures. If there is valuable data on the disk, I would not leave it exposed to low temperatures.


The electrical functioning should be less sensitive, but a general rule would be to allow the unit to warm to approximately room temperature before powering up. The thermal change in going from a warm building to a cold car should cause no problem, assuming that the car has a heater which will be in use. The short time at the temperature extremes will not markedly affect the unit's internal temperature. . . . Steve

### Follow-up and Music to His Ears

Dear Steve,

This letter is a follow-up to my letter about adding lowercase display characters to a Lear Siegler ADM 3A terminal. (See "ADM 3 Lowercase Conversion," October 1982 BYTE, page 453.) You kindly referred me to an article published in the March

**NEW BREAKTHROUGH IMMEDIATE DELIVERY**



**SPECIAL - 450**  
(LIST \$695)

**SPECIAL - 495**  
(LIST \$695)

**SPECIAL - 695**  
(LIST \$895)

**SPECIAL INTRODUCTORY PRICE  
LIMIT TWO MODEMS PER CUSTOMER**

### INCOMM MODEM FAMILY- BELL COMPATIBLE 300/1200 AND MORE, SUCH AS SINGLE AUTO DIALING (SMART) AND MULTIPLE AUTO DIALING (SUPER SMART)

- INCOMM 300/200 Data Modem, is a 300/1200 bps Modem (Bell 103/212A Compatible) Western Electric licensed \$450.00 Special
- INCOMM Auto Dial 212A Data Modem, is a 300/1200 bps Semi-Intelligent Modem with Microcomputer of terminal keyboard dialing (Bell 103/212A Compatible) \$495.00 Special
- INCOMM Multidial 300/1200 Modem, is a 300/1200 Super-Intelligent auto dialing Modem storing 10 numbers of 20 digits each, which can be dialed by simple commands from a microcomputer or terminal keyboard (Bell 103/212A Compatible), and also has many other exclusive features \$695.00 Special
- Ask for our complete short form catalog

**DEALER/RESELLER INQUIRIES INVITED  
VERY GENEREOUS DISCOUNTS**

**CALL COLLECT TO ORDER (312-459-8874)  
(BANK CARDS ACCEPTED)**

115 N. WOLF RD. **INCOMM** WHEELING, IL  
**312-459-8881** 60090

## Reliable Business Software

DATASMITH software requires no previous computer experience, so it can be used effectively by your present office staff. The menu-driven systems feature extensive error detection and correction facilities, so they are "friendly" to the user.

- **GENERAL LEDGER.** Everything you need to keep the books. Features easy-to-use data entry and error correction, trial balance, fast post, and a variety of comprehensive reports. Automatic error detection keeps the books in balance. Writes checks and makes journal entries in one operation.
- **PAYROLL.** A very flexible system that adapts to a wide variety of needs. Features Federal, state, and local tax calculations, EI credit, and special pay and deduction amounts. Prints all necessary reports, paychecks, and W-2 forms.
- **DATA MANAGER.** A powerful generalized data management system that lets you define, enter, update, sort, select, and print reports from a database of your own design. Applicable to almost any job where records must be kept, this system can replace literally hundreds of programs.

Put your computer to work with these sophisticated systems now. Programs are available for 48K or larger two-disk systems in your choice of code for Microsoft BASIC-80® under CP/M®, IBM® Personal Computer BASIC, or Micropolis® BASIC.

**DATASMITH**

Box 8036, Shawnee Mission, KS 66208. (913) 381-9118



1979 BYTE and suggested that I get the 2513 ROM (read-only memory) from Active Electronics. I tried to do this, but they were back ordered.

I then noticed a ROM sold by Advanced Computer Products in Santa Ana, California, called the 2513-ADM. When I called the company, the only information I could get was that it was made by General Instrument. Upon calling that company, I received a firm denial that General Instrument ever made a ROM with inverted outputs as needed by the ADM 3A. I decided to take a chance and ordered the chip for \$14.95, along with the specification sheet.

The specification sheet sent with the chip was for a 2513-RO-3, not for the 2513-102 as labeled on the chip. Thoroughly confused, I boldly put the chip in the socket in the ADM 3A and—lo and behold—lowercase characters appeared without any soldering or tinkering!

I have gone into such detail on this issue because I thought your readers might be interested in knowing about this orphan chip that no one claims (although it is marked as being made by General Instrument) and that no one knows anything about.

I'd like to ask you another completely unrelated question. I would imagine that many people engrossed in computers are like me in that they started out with electronics as a result of an interest in high-fidelity and music. A few years back, all my spare cash went for buying high-fidelity equipment; now all of it goes for buying computer equipment. I would love to have my high-fi controlled by my computer (e.g., changing music sources from tape to tuner, adjusting the volume, switching speakers). The first and last are relatively easy, but I have not seen any-

thing on the control of an analog circuit by a computer—especially one sensitive to noise. Could you suggest a circuit, or point me in the direction of one? I am a neophyte when it comes to electronics.

Thank you for your time and help. It's greatly appreciated.

Rich Bucholz  
Hamden, CT

*Thanks for the follow-up.*

*Controlling audio devices by means of a microcomputer is a relatively easy process, requiring the use of D/A (digital-to-analog) converters. A unit made by Analog Devices, the AD 7110 is a CMOS (complementary metal-oxide semiconductor) digitally controlled audio attenuator with an attenuation range of 88.5 dB (decibels), plus full muting capability. Its 6-bit digital input covers the attenuation range in 1.5 dB increments. Such a unit could control the audio amplitude in your stereo system.*

*The ADG201 is a CMOS-protected quad SPST (single-pole, single-throw) analog switch that can be toggled by a TTL- (transistor-transistor logic-) or CMOS-level logic input. It features a make-before-break switching action and has overvoltage protection to 25 volts above the supply voltage. In its "ON" state, it looks like a 100-ohm resistor. This can switch low-level signals in your system.*

*The data sheets for both these devices give an indication of their use. Handle them with extreme care because they are static sensitive. I have no circuits immediately available as the application of these devices to audio control is usually unique to each user. Write Analog Devices for further information and data sheets. The address is Analog Devices, Route One Industrial Park, POB 280, Norwood,*

MA 02062, (617) 329-4700.

... Steve

### Home Security 6502 Style

Dear Steve,

I am trying to implement that neat home-security system you outlined. (See "Build a Computer-Controlled Security System for Your Home," Part 1, January 1979 BYTE, page 56; Part 2, February 1979 BYTE, page 162; Part 3, March 1979 BYTE, page 150). Not being familiar with the 8080 series of processors, I am using a SYM-1 single-board computer, which is based on the 6502 microprocessor.

Because the flowcharts in the article are so clear and easy to program from, it occurred to me that there must be some literature describing in more detail the development of such "event processor" programs. If you could steer me toward some books or articles about this type of programming, I would be most grateful.

Eric A. Lowhar  
Venice, CA

*An excellent book on programming the 6502 microprocessor, with emphasis on interfacing and controlling applications, is Programming & Interfacing the 6502, With Experiments, by Marvin L. De Jong (Howard W. Sams & Co. Inc., 4300 West 62nd St., POB 7092, Indianapolis, IN 46206). It costs \$16.95. This book specifically addresses the SYM-1, AIM-65, and KIM-1 single-board computers. It should be in your reference library.*

*An article in the October 1977 issue of Kilobaud (page 84), "Dedicated Controllers" by Michael J. Myers, describes a specific application of a KIM-1 computer as a process controller. The software is described and should be of*

some help to you. . . . Steve

### Upgrading Homebrew to CP/M

Dear Steve,

I have an 8080A-based microcomputer that I designed and built. I am redesigning it with a Z80 and several refinements. It occurred to me that machine language was perhaps going to be a bit of a drag once I was past the development stage (are we ever?). What sort of hardware/bootstrap configuration would I need so that I could eventually add floppy-disk drives and run CP/M? I know that the boot-loader program must be limited to 256 bytes, and I'm familiar with the term BIOS, but that is about it.

I'm in Korea, and there is an acute lack of serious material on microcomputers. Can you give me any clues as to where to look? I would like to find out about necessary design changes before I wire-wrap the whole thing. Any help would be appreciated.

Sergeant Dale L. Botkin  
South Korea

*I would suggest that you configure your computer around the S-100 bus so as to take advantage of this simple means of adding a disk controller and CP/M to your system. Many of the S-100 disk-controller boards on the market are designed for CP/M and include a bootstrap PROM (programmable read-only memory) as part of the package or as an option.*

*Some of the disk-controller cards with this feature are the CCS Model 2422 (California Computer Systems), the Versafloppy (SD Systems), the Double-D (Jade), and the Disk 1 (Compupro).*

*These units can be obtained from Jade Computer Products, 4901 West Rosecrans Ave., Hawthorne, CA 90250,*

and Priority 1 Electronics, 9161 Deering Ave., Chatsworth, CA 91311. Write for their catalogs. They also carry an extensive selection of books on microcomputers.

... Steve

## Rounding Off Square Roots = Gray Hairs

Dear Steve,

A friend called me and asked me to do a short program on my Apple II Plus. He wanted a program that printed out the Pythagorean triplets between 1 and 20. After some work, I found that my Apple has some trouble calculating square roots.

The program shown in listing 1 should work, but it doesn't. The problem is in line 40. I found that the Apple has trouble with IF, THEN, and SQR functions when they are used together.

I went through a test program and I found something very unusual. First, I typed in LET X = SQR(100). We all know that X should equal 10, but just in case, I entered PRINT X. The computer responded with 10, but then came the problem. I entered

print X = 10. If that statement is true, the computer should respond with 1, but it doesn't, it prints 0 (i.e., the statement is false). Now computers are likely to make some errors, but even my little brother knows that one!

I was wondering if you could tell me what was the cause of this. This error has kept me from doing quite a few programs for algebra and other classes of mine. Is it a flaw in the Apple, or is it just that my particular computer is messed up?

Joel Kozikowski  
Indianapolis, IN

*The problem that you have with the SQR function is not an error in Applesoft BASIC. In fact, it is not an error at all. You are correct in assuming that the problem is in line 40 of your program, but for the wrong reason. After taking the square root, you test for those values that are integers. The problem is that none of the square roots are integers due to the way that square roots are calculated.*

*Remember the pocket calculators that would give you ).9999999 for the square root*

## Listing 1

```
10 FOR A = 1 TO 20
20 FOR B = A TO 20
30 LET C = SQR ( A*A + B*B)
40 IF C < > INT (C) THEN 60
50 PRINT A,B,C
60 NEXT B
70 NEXT A
```

## Listing 2

```
40 IF C = ABS(C - INT (C)) > .00000001 THEN 60
```

*of 4? This is exactly what is happening in the Apple II. The algorithm that calculates square roots rounds off to a fixed number of significant digits. Because line 40 branches to line 60 if not an integer, your program just runs the nested loops and then ends.*

*Change line 40 to what's shown in listing 2, and your program will run correctly. This line tests to see how close C is to an integer value. If the*

*difference between C and the integer C is very, very small, then it is an integer and will be printed. Otherwise, your computer will look for the next set of values.*

*Also, when you apply the test PRINT X = 10, the answer is false because X does not equal 10. It may equal 9.999999999 or 10.00000001 etc. and not 10.0000000000. This is a subtle mistake that creates lots of gray hairs for programmers. . . . Steve*

## FCC Requires Testing Lab's Approval

Dear Steve,

I am an avid reader of yours. Your projects really seem to hit home with my interests. I enjoyed listening to you speak at the Trenton Computer Festival last year and your comments concerning answering letters has prompted me to write.

I have experimented with adding devices to the telephone line. My interface, for the most part, consists of a

1-megohm resistor in series with the phone line and a 100k-ohm and 0.1 microfarad ( $\mu$ F) capacitor tied in parallel.

How can I get FCC approval for a device that connects to the phone? I would really like to sell these designs to a company that would be interested in building and marketing my prototypes.

Mark Kantrowitz  
Rockaway, NJ

*FCC approval requires the passage of tests that are best conducted by an independent*

*testing laboratory. These laboratories are also familiar with the paperwork that must accompany such testing. One testing lab that I have used*

*and can recommend is Art Schulze, 8807 Mobud Dr., Houston, TX 77036.*

... Steve

In "Ask BYTE," Steve Ciarcia answers questions on any area of microcomputing. The most representative questions received each month will be answered and published. Do you have a nagging problem? Send your inquiry to:

Ask BYTE  
c/o Steve Ciarcia  
POB 582  
Glastonbury CT 06033

If you are a subscriber to The Source, chat with Steve (TEC317) directly. Due to the high volume of inquiries, personal replies cannot be given. Be sure to include "Ask BYTE" in the address.



## IBM Unveils Top-of-the-Line Personal Computer

IBM recently unveiled its top-of-the-line microcomputer: the IBM Personal Computer XT. The XT, an extended version of the popular IBM PC, comes with a 10-megabyte hard-disk drive, 128K bytes of RAM (random-access read/write memory) that's expandable to 640K bytes, one 360K-byte floppy-disk drive, an asynchronous communications adapter, and eight expansion slots. It lists for \$4995. Externally, it looks the same as its predecessor, and it still uses the 8088 microprocessor, but the XT is not the radical new computer that rumors had predicted. Nonetheless, it's a fine, conservative machine.

At the same time that the IBM Personal Computer XT was announced, company spokesmen also took the wraps off several optional accessories and enhancements for the Personal Computer line. IBM now offers expansion units for both the PC and the XT (with a hard disk and eight input/output slots), a high-resolution color display, and an enhanced version of Microsoft's disk operating system, DOS 2.0.

The basic XT provides a roomy storage area with its 10-megabyte hard-disk drive, allowing you to work with large data files and eliminating the need to swap around disks and programs. The availability of the IBM hard disk sets the stage for software developers who want to create new applications that require the greater storage capacity and faster access time of a hard disk.

The 360K-byte floppy-disk drive provides an easy way to transfer programs and data to or from the hard-disk system. Why IBM chose this new floppy-disk format with 180K bytes (single-sided) or 360K bytes (double-sided) per disk is somewhat perplexing because it doesn't offer much more space than the 160K- to 320K-byte-per-disk format on the PC. IBM DOS 2.0 supports this new disk format with nine sectors instead of eight. It is upward-compatible with PC-DOS 1.0 and 1.1 and can read and write all previous disk formats.

Backing up the hard disk to floppy disks is supported by a couple of new commands. A menu of several options lets

you choose between copying the entire disk, selected files (via a wildcard format), all files created after a certain date, or only the files changed since the last backup.

Eight system expansion slots are an improvement over the IBM PC's five slots, but three slots are already taken up by adapters for the hard disk, the floppy disk, and asynchronous communications. If you get the expansion unit, a fourth slot will be used for an attachment card to link the two units together.

Only six of the eight slots in the IBM PC XT are for full-sized accessory cards. Because of space limitations, two slots are behind the disk drives. These slots accept smaller cards, such as the asynchronous communications, game controller, and printer adapters, or the attachment cards.

The IBM PC XT includes an asynchronous communications adapter that can be used to connect a serial printer or to communicate with IBM PCs, larger IBM mainframe systems, or other information sources via a modem.

The optional expansion unit with a 10-megabyte hard disk and eight more I/O slots comes in two configurations: one for the IBM PC and the other for the IBM PC XT. The expansion unit for the regular IBM PC differs only in that it contains a hard-disk adapter and is therefore more expensive. A single hard-disk adapter can handle two hard-disk drives, but each drive has to be in the same unit because of cabling requirements.

One of the full-sized slots will be used by the hard-disk adapter when it is moved from the IBM PC XT system unit to the expansion unit to handle the two hard disks. The expansion unit has an automatic, power-on self-test of the components, like the system unit does, and is not available without the hard disk.

For the first time, IBM is offering a color display monitor for its personal computers. This 16-color 12¼-inch display is aggressively priced at \$680 and provides resolution of up to 640 by 200 dots. Text can be shown in 25 lines of either 40 or 80 characters. A separate color/graphics monitor adapter controls the monitor.

A version of MS-DOS 2.0 for IBM's

personal computers was also released. The IBM DOS 2.0 disk includes BASIC 2.0, which supports some of the new functions available under DOS 2.0, such as the hierarchical file directories and new graphics, music, and function-key enhancements.

Immediate price reductions on the IBM Personal Computer averaging 15 percent were also disclosed. The only items actually lowered in price are the system unit, disk drives, memory card, color/graphics monitor adapter, and asynchronous communications adapter. The IBM PC with 16K bytes of memory has been discontinued, and now 64K bytes of memory is the minimum configuration.

To make communications with corporate IBM mainframe computers easier, synchronous data-link control (SDLC) and binary synchronous communications (BSC) adapters are available. These adapters allow the IBM Personal Computers to emulate common IBM terminals.

For those companies that already have IBM 3270-type terminals and would like to add personal-computer capabilities, IBM has come out with the 3270 Personal Computer attachment. This allows you to use the 3270 keyboard and display as a terminal to a central computer, then switch to using the 3270 terminal as an IBM Personal Computer compatible with other IBM microcomputers.

By typing the alternate key with another key, you can jump back and forth between the two modes. You can even get data from the host computer and analyze it locally in the personal-computer mode.

The 3270 Personal Computer attachment consists of the 3278 Personal Computer adapter (an IBM PC system unit with disk drives), which is installed by an IBM service representative, and the Personal Computer 3278 attachment option, a card that you can plug into one of the unit's slots. If you have both a 3278 terminal and an IBM Personal Computer, you only need to purchase the attachment option to hook the two together.

IBM is making swift strides to integrate all of its lines of computers and bring the IBM Personal Computers into the corporate fold.—Bruce Roberts

## Clubs and Newsletters

### News from Budapest, Hungary

Members of a Hungarian home computer club meet to develop low-cost systems, lecture on computer techniques, and assist beginners with construction projects. Club members exhibit homebrew computers, programs, and peripherals at microcomputer symposiums held each year in Budapest, Hungary. For details, write to Dr. Endre Simonyi, 19 Trencsenyi, Budapest H-1125, Hungary.

### Take the Buss

*Buss*, the Independent Newsletter of Heath Company Computers, contains tips, new programs, and news updates for Heath/Zenith owners. Each issue is numbered and has a table of contents for quick reference. A single issue is \$2, a year's subscription (12 issues) costs \$20, and an overseas subscription is \$25. For more information, write to *Buss*, 716 E St. SE, Washington, DC 20003, or call (202) 544-0900.

### Electronic Opportunity

Each monthly issue of the *Micro Moonlighter Newsletter* contains features on how to profit from home-based businesses using personal computers. An annual subscription is \$25 in the U.S. and \$29 in Canada. For details, write to the *Micro Moonlighter Newsletter*, 2115 Bernard Ave., Nashville, TN 37212.

### Telecommunications in Engineering

The monthly newsletter produced by M/A-COM con-

tains news and updates of recent developments in telecommunications engineering. For more information, write to M/A-COM DCC Inc., 11717 Exploration Lane, Germantown, MD 20874.

### Design and Manufacturing

*CAD/CAM Alert* is a monthly newsletter containing news, checklists, reviews, and recommendations in the computer-aided design and manufacturing field. A one-year subscription is \$95. Sample issues are available on request. For further information, write to *CAD/CAM Alert*, POB 404, Newton, MA 02161.

### Help Yourself

*Hi-Tek Connection* is a monthly newsletter covering microcomputer systems and their applications. It is specifically written in easy-to-understand language. The *HTC* costs \$40 a year with a 90-day money-back guarantee. For more information, write to Russell E. Marano, Hi-Tek Publications, POB 99, North Salem, NH 03073.

### Memorable Optics

*Optical Memory Newsletter* including Interactive Videodisks is a bimonthly publication that features book and software reviews, articles, and a conference calendar. A one-year subscription (six issues) is \$295. Discounts are available with multiple subscriptions. For details, write to *Optical Memory Newsletter*, POB 14817, San Francisco, CA 94114, or call (415) 621-6620.

## HIDE-A-WAY COMPUTER DESK

BRAND NEW



MODEL 1500—size: 20 x 24 x 30 H, 70 lbs.

The ultimate work/storage unit for your computer. This beautiful two part desk closes to become a stunning piece of furniture. Open—it holds your computer and monitor in one side and a printer and auxiliary pieces in the other half. Equipped with casters for added convenience. Each unit features rich, durable, care free finish and solid core construction. Designed for quick n'easy assembly that will take just minutes. Only \$129.95 including shipping and handling. Send your check or money order to:

**EMC Distributors,**  
366 Fifth Avenue, New York, N.Y. 10001.  
(NY residents please add sales tax.)  
**Satisfaction guaranteed.**

Dealer inquiries invited.

# FLIP FLOP™

Stop Wasting  
Half Your  
MEMORY/MONEY

5 1/4" FLIPPY KIT      8" FLIPPY KIT

**FLIP FLOP** A Daring, Quick, & Precise way to allow you to use both sides of your single-sided diskettes. Flip Flops are not temperamental. **FLIPPY KITS** will work with any sectoring and density required by your 5 1/4" or 8" single-sided disk drives. Covering of Just One Box of diskettes will pay back your investment. **LIVE** the legend: use both sides of your single-sided diskettes.

**SAVE TIME, SAVE SPACE, SAVE MONEY**

The technology for making a write-enable/protect cutout in one step along with a prealigned, accurate, and safe way to make the new index-hole cutouts next to hub-ring of diskettes for 2nd step.

**NO NEED TO MEASURE—NO NEED TO MAKE ALIGNMENT MARKS  
NO NEED TO USE PENCILS**

**5 1/4" FLIPPY KIT:** For Apple, IBM, Osborne, TRS-80, Atari, Commodore, Kanga, Victor, Franklin and other 5 1/4" single-sided drives      only \$29.95

**8" FLIPPY KIT:** For Altos, TRS-80, Wang, IBM, Xerox, Control Data, DEC, H-P, Data General, TI and other 8" single-sided drives      only \$34.95

Add \$2.50 for ship & hdg (AK, HI, add \$5, Foreign country add \$10)  
MA. residents add 5% sales tax. Send check or money order to:

**D/Punch Co., P.O. BOX 201 • NEWTON HILLS, MA 02161    Tel (617) 954-2126**  
Dealer inquiries invited.      Copyright 1988 D/Punch Corp.



### Pruning the Family Tree

*Genealogical Computing*, a bimonthly periodical produced by Data Transfer Associates Inc., specializes in hardware and software applications to lineage research. It also contains news, reviews, programs, and services. Subscriptions are \$14 a year in the U.S.; Canadian and foreign subscribers pay \$19. For further information, write to Data Transfer Associates Inc., 5102 Pommeroy Dr., Fairfax, VA 22032.

### Notes from North Star

*North Star Notes* is a newsletter designed to keep users of North Star Computers informed about the latest developments in hardware, software, and corporate activities. *North Star Notes* is free to anyone who wants to be on the mailing list. Send your requests to North Star Computers Inc., 14440 Catalina St., San Leandro, CA 94577, or call (415) 357-8500.

### Spread the Word

*The Spreadcalc News* contains listings, applications, reviews, and news releases about getting the most from your Visicalc investments. The annual subscription rate is \$25 (six issues). For details, write to Spreadsoft, POB 192, Clinton, MD 20735, or call (301) 856-1180.

### In Terre Haute

The Wabash Valley Computer Society meets every fourth Wednesday of the month at 7 p.m. at the Vigo County Public Library in Terre Haute, Indiana. Family

dues are \$10 a year and include a subscription to the *Journal of the Wabash Valley Computer Society*. Contact the Wabash Valley Computer Society, 203 Briarwood Dr., Terre Haute, IN 47803, or call (812) 877-3269.

### TRS-80 Color Computer Club

A TRS-80 Color Computer club in Durham, North Carolina, is welcoming new members. The club produces a monthly newsletter that contains features on the Color Computer. Membership is \$10 and the newsletter is 85 cents. For more details, write to Donald DeHart, 3632 Cheek Rd., Durham, NC 27704.

### LNW Information from Nebraska

*The LNW User*, a bimonthly newsletter for LNW-80 enthusiasts, is produced by the LNW User Group and contains programming news, hardware and software reviews, and a question-and-answer section. Subscriptions are \$12 a year and back issues are available. For further information, write to *The LNW User*, 4345 Manchester Rd., Grand Island, NE 68801.

### Central Ohio Amateurs Meet

The Amateur Computer Society of Central Ohio (ACSCO) meets on the first Wednesday of each month at 7:30 p.m. at the Barnett Rec. Center in Columbus, Ohio. Membership dues are \$10 a year and include a subscription to the newsletter, the *I/O*. To swap newsletters, send yours to TRS-80—ACSCO, c/o Cramer, POB

28355, Columbus, OH 43228. For additional information about the club's activities, write to Joel Sampson, 3009 Calvmet, Columbus, OH 43202, or call (614) 262-2995.

### Winnipeg PET Users Group

The Winnipeg PET Users Group (WPUG) meets on the first Wednesday of every month to exchange news about Commodore computers. Meetings include hardware and software demonstrations, speakers, and question-and-answer sessions. The \$15 membership fee entitles you to receive the WPUG newsletter and provides access to more than 3000

programs in the WPUG disk library. For more information, write to Larry Neufeld, WPUG, 9-300 Enniskillen Ave., Winnipeg, Manitoba R2V 0H9, Canada.

### File From Canada

*File*, a newsletter that examines ideas, processes, and technology in the publishing and direct-mail marketing industries, is produced six times a year by Creative Data Processing of Brauch & Neville Associates Ltd. For further information, contact Brauch & Neville Associates Ltd., 3390 Midland Ave., POB 351, Agincourt Post Office, Scarborough, Ontario M1S 3B9, Canada. ■

If you would like BYTE readers to know about your club or newsletter send the details accompanied by no more than one newsletter to Clubs and Newsletters, BYTE Publications, POB 372, Hancock, NH 03449. Overseas groups are encouraged to participate. Please allow at least three months for your announcement to appear.

## BYTE's Bits

### Porsche Will Go to Contest Winner

Seeq Technology of San Jose, California, will award a 1983 Porsche 944 to the person who comes up with the best application for one of its electrically erasable read-only memory (EEROM) chips. This chip, the 16K-bit 5-volt 5213, can be purchased for \$9.95 at Schweber Electronics stores with a limit of two to a customer until May 31. Possible applications include a remotely programmable private branch exchange (PBX) for telephone systems or even jukeboxes that tell you when to replace worn records.

To be eligible, you must come up with a good idea, build it, test it, and send the

schematic to Seeq by May 31, 1983. Complete rules and entry forms are available from local Schweber Electronics stores or from Seeq Technology, 1849 Fortune Dr., San Jose, CA 95131, (408) 942-1990.

### North American Book Distributor

In Dr. Michael Carter's review of *Personal Documentation for Professionals*, the North American distributor of the book was not mentioned. (See the October 1982 BYTE, page 385.) It can be ordered from Elsevier Science Publishing Co., 52 Vanderbilt Ave., New York, NY 10017. ■

# WE WILL BEAT OR MEET ALL PRICES ON ALL PRODUCTS IN THIS MAGAZINE TO PLACE ORDER CALL (213) 219-0808 NOW!

Visit our  
**NEW**  
Retail  
Showroom

## 48K APPLE COMPATIBLE COMPUTER

1 yr. Warranty

Introductory Price \$595  
Call for Availability

## ALL COMPUTERS

Apple II E	\$ Call
Commodore 64	399
Kaypro	1649
Osborne	Call
Sanyo MBC 1000	1599
Apple Compatible Computer	595
S-100 System	Call for lowest price
IBM PC	Call

## IBM PC PRODUCTS

### Ast Research

Combo Plus 64K w/clock, Par., Port,  
Serial Port, Software \$359  
Mega Plus 64K Expandable  
to 512 430

### Tandon

TM100-2 Dbl Side Dbl Density \$ 249

## 5 1/4" & 8" DISK DRIVES

### Shugart

SA400, 40 Track \$ 145  
SAB01R, Sgl Side/Dbl Den 369  
SAB51R, Dbl Side/Dbl Den 479

### Tandon

TM 100-1, Sgl Side/Dbl Den \$ 179  
TM 100-2, Dbl Side/Dbl Den 249  
TM 848-1, Sgl Side/Dbl Den 369  
TM 848-2, Dbl Side/Dbl Den 449

### Quime

DT-8 Dbl Side/Dbl Den \$ 465

### Siemens 8"

FDD 100-8, Sgl Side/Dbl Den \$ 209

### Mitsubishi

8" Dbl Side/Dbl Den \$ 409

## FOR FRANKLIN & APPLE

All Apple Products Not Seen in This Ad Are  
Available-Call for Guaranteed Lowest Price

Grappler +	\$118
Par. Interface Card & Cable	49
TG Joystick	39
18K Memory Card	44
80 Column Card (View Max 80)	169
RH Fan	69
RF Modulator	25

## UNBEATABLE PRINTER PRICING

### Star Micronics

Gemini 10 (100 cps) \$ 355  
Gemini 15 (115" carriage) 465

### C. Ioth

Prowriter 8510AP (120 cps) \$ 365  
Prowriter 8510AC (Serial) 549  
Starwriter F-10 40pu 1249

### Okidata

Microline 82A \$ 399  
Microline 82A 649  
Microline 84P 939  
Microline 84S 1050  
Microline 92 909

### Nec

Nec 8023 (price reduction) \$ 449  
Spinwriters Call

### Epson

FX8Q, 160 cps \$ 549

## SPECIALS OF THE MONTH

### 5 1/4" Disk Drive

TM100-2 Tandon  
90 Day Warranty

ONLY \$249.00

## MODEM

Smart Modem 300  
Hayes Top of the Line

ONLY \$195.00

## DRIVE FOR APPLE OR FRANKLIN

Micro Sci A-2  
Fully Compatible

\$249.00

## PRINTER

Gemini 10

Same as Epson MX80FT

\$325.00

## MONITOR

Dynax Hi-Ref Green Screen  
• 20MHz • Composite

ONLY \$109.00

### USI Amber 12"

• 1000 Lines

• Horizontal Resolution

\$149.00

All Products Carry at least a  
90 Day Warranty

## MODEMS

### Hayes

Smart Modem 300 \$ 199  
Smart Modem 1200 498

### Novation

D-Cat Call  
Apple Cat Call

## TERMINALS

### Televideo

925C Green Screen \$ 699  
950 Detachable Keyboard 899

### Adds

Viewpoint 1A, 2A, 3A Call

## DISKETTES

All packages of diskettes come with free library  
case and reinforced hub. Full 1 year warranty.  
Prices are for Packs of 10.

### 5 1/4" Disks

Sgl Side/Sgl Density \$18.50/10  
Sgl Side/Dbl Density 20.50/10  
Dbl Side/Dbl Density 26.50/10

### 8" Disks

Sgl Side/Sgl Density \$25.00/10  
Sgl Side/Dbl Den 29.00/10

## CABINETS & MAINFRAMES

### QT Computer Systems

DOC-8 Cabinet w/pwr. supply & fan  
ONLY \$208.00

DOC-88-H Dual Cabinet w/pwr. supply & fan  
ONLY \$259.00

### Mainframe

6 slot w/2, 8" cutouts, pwr. supply, fan,  
filter, Connector Cutouts  
ONLY \$549.00

### 5 1/4" Cabinets

Single Cabinet w/pwr. supply \$ 59  
Dual Cabinet w/pwr. supply 89

## DISK DRIVES FOR FRANKLIN & APPLE

### Rana Systems

Rana Elite I \$ 285  
Rana Elite II 439  
Rana Elite III 569  
Controller 89

### Micro Sci

A-2 (35 Track) \$ 249  
Controller 75  
Apple III Drives Available Call

### Quantin Research

Apple Mate \$ 249  
Controller 60

## MONITORS

### Dynax

12" Green Screen, 20MHz \$ 109

### BMC

12A (15MHz) Composite 84  
12EUN (20MHz) Composite 129  
9191 Color Composite 279

### Taxan

12" Green (18MHz) Composite \$ 129  
12" Amber (18MHz) Composite 129  
RGB 1 Color 318

### Zenith

ZVM 121 12" Green (15MHz) \$ 94

### USI

9" Green (20MHz) \$ 139  
12" Green (20MHz) 139  
12" Amber (20MHz) 149

## CABLES

IBM to Printer \$ 32  
Osborne to Printer 32  
Kaypro to Printer 32

Call for all cable configurations

## DISKETTE STORAGE

Mini Files—Holds 70 Disks \$16.50  
Maxi Files—Holds 70 Disks 24.00  
5 1/4" Library Cases 3.00  
8" Library Cases 4.00

Computer  
Components  
Unlimited

NEW RETAIL STORE:  
11976 Aviation Blvd.  
Inglewood, CA 90304

MAIL ORDER:  
P.O. Box 1936  
Hawthorne, CA 90250

ORDER DESK:  
(213) 219-0808

## No Surcharge for Credit Cards



All merchandise new. We accept MC, Visa, Wire  
Transfer, COD Call, Certified Check, P.O.'s from  
qualified firms, APO accepted, shipping:  
Minimum \$3.50 first 5 pounds; Tax: California Res.  
Only add 6.75% sales tax.

Mon.-Fri. 8 a.m. to 7 p.m.  
Sat. & Sun. 11 a.m. to 4 p.m.



# What's New?

## ELECTRONIC OFFICE



### Portable Computer with Networking Potential

Up to 15 battery-powered Athena 1 portable computers can be connected in a local-area network. This 15-pound machine carries 512K bytes of solid-state storage, dual low-power NSC-800 processors running CP/M, 64K bytes of main memory for computation, 4K bytes of communications memory, and a full-sized keyboard. Its 4-line by 80-character display performs as a window because it's backed by 24 lines of 80 characters held in memory. A 5¼-inch floppy-disk drive, two RS-232C ports, and a printer port are standard. Expansion capabilities include up to 1 megabyte of internal memory and space for two additional circuit boards.

Athena 1 costs \$3950. Address inquiries to Athena Computer & Electronic Systems, 31952

Camino Capistrano, San Juan Capistrano, CA 92675, (714) 661-2276. Circle 600 on inquiry card.

### DMS-15 Can Serve as Master Station

The DMS-15 can serve as a master in a Hinet local-area network. Hinet can support up to 32 users and address as many as 255. Manufactured by Digital Microsystems, and said to be an enhanced version of the portable Fox, DMS-15 comes with CP/M 2.0 and 15 megabytes of built-in Winchester-disk storage (formatted). It features DSC-3 (Z80A) architecture, 64K bytes of RAM (random-access read/write memory), a 9-inch display, one double-sided double-density 5¼-inch floppy-disk drive (614K bytes), a

Hinet interface, and four RS-232C serial ports.

A list price of \$7495 has been set for the DMS-15. The software to run the system as the Hinet master station costs \$500. Quantity discounts are offered. Contact Digital Microsystems, 1755 Embarcadero, Oakland, CA 94606, (415) 532-3686.

Circle 601 on inquiry card.

### Three Systems Support 5-11 Users

The C5002A, C8002A, and the Sundance 16 are 16-bit microcomputers that can support 5 to 11 users. Onyx Systems reports that each machine runs Unix System III. They will be marketed through OEMs (original equipment manufacturers), ISOs (independent sales organizations), and systems integrators.

An integrated computer/workstation, the Sundance 16 is available with VT100-type 132- or 80-column displays. Its 5¼-inch Winchester hard-disk storage capacities range from 7 to 21 megabytes, and 256K or 512K bytes of user memory with 12 megabytes of tape backup storage are offered. Retail prices begin at \$12,990.

The C5002A supports five users or devices with its five serial and one parallel port. Options include 512K bytes of additional RAM (random-access read/write memory), six more ports for users or devices, and the Omninet

network. Prices start at \$10,990.

Using its internal upgradable option for local networking, the C8002A can support 11 users or devices. Mass storage is provided by 8-inch Winchester drives with 20-, 40-, or 60-megabyte capacities. Other features include 12 megabytes of tape backup and 256K or 512K bytes of RAM. The Omninet network is available as an option. The base price is \$13,990.

For full details, contact Onyx Systems Inc., 25 East Trimble Rd., San Jose, CA 95131, (408) 946-6330. Circle 602 on inquiry card.

### Network to Connect Dissimilar Hosts

Tri-Data's Netway Family is designed to create a cohesive network using a variety of hosts and workstations, regardless of the local or remote protocols employed. The family comprises distributed-communications-oriented hardware and a multitasking/multiprogramming network DOS, called NCOS.

NNET networking software provides automatic alternative routing, online configuration from any workstation, and the ability to manage up to 254 processors. The NCOS operating system gives network and host transparency and has a user-friendly interface with help messages. It allows CP/M Plus to run as a task for applications development.



# Retail Showroom

1780 West 2300 South  
Salt Lake City, Utah 84119

# The Great Salt Lake Computer Company, Inc.

# Mail Orders

P.O. Box 26816  
Salt Lake City, Utah 84126



## QT 5 1/4" MAINFRAME



• Provisions for any 2 - 5 1/4" drives • 15 ea DB 25 cutout  
• 2 ea 50 pin • 2 ea 34 pin • 1 ea Centronic • EMI filter (fused)  
• 2 AC outlets • Avbl with 6 - 8 or 12 slot motherbd •  
Power supply (- 8V18A/ - 16V3A/ - 12V5A)

QTC-MF - MD6 (8 slot MB) \$720.00  
QTC-MF - MD12 (12 slot MB) \$765.00

## QT 8" MAINFRAME



• Provision for any 2 - 8" drives (hard or floppy) • 15 ea DB 25  
cutout • 2 ea 50 pin • 2 ea 34 pin • 1 ea Centronic • EMI filter  
(fused) • 2 AC outlets • Avbl with 6 - 8 or 12 slot motherbd  
• Power supply (- 8V18A/ - 16V3A/ - 5V8A/ - 5V1A/  
- 24V8A)

Desk Top Version  
QTC-MF - DD8 \$600.00  
QTC-MF - DD12 \$650.00

Rack Mount Version  
QTC-RMF-DD8 \$900.00  
QTC-RMF-DD12 \$950.00

## QT STANDARD MAINFRAME

• Provisions for any 2 - 5 1/4" drives  
• 15 ea DB 25 cutout • 2 ea 50 pin  
• 2 ea 34 pin • 1 ea Centronic  
• EMI filter (fused) • 2 AC outlets  
• Avbl with 6-8-12-18 or 22 slot MB  
• Power supply (- 8V18A/ - 16V3A)



Desk Top Version  
QTC-MF - 12 \$675.00  
QTC-MF - 18 \$720.00  
QTC-MF - 22 \$800.00

Rack Mount Version  
QTC-RMF - 12 \$775.00  
QTC-RMF - 18 \$820.00  
QTC-RMF - 22 \$900.00

## QT S-100 CARD CAGES

• Made of anodized steel • Card guides  
for ea MB • 1 - Indicates w/MB  
• 2 - Indicates w/MB - 1 ea fan  
• 3 - Indicates w/MB - 2 ea fans



QTC-CC4	\$20.00	CC12	\$60.00
CC4-1	\$75.00	CC12-1	\$165.00
CC6	\$25.00	CC12-2	\$200.00
CC6-1	\$90.00	CC12-3	\$225.00
CC8-2	\$115.00	CC18	\$75.00
CC8	\$35.00	CC18-1	\$220.00
CC8-1	\$100.00	CC18-2	\$250.00
CC8-1	\$135.00	CC18-3	\$290.00

## QT S-100 MOTHERBOARDS

• Silence Plus • Built in Termination • IEEE696 • Terminal  
strip for easy power connection

4 Slot Motherboards		8 Slot Motherboards	
QTC-MB4B	\$20.00	QTC-MB8B	\$30.00
QTC-MB4K	\$35.00	QTC-MB8K	\$50.00
QTC-MB4A	\$45.00	QTC-MB8A	\$65.00

8 Slot Motherboards		12 Slot Motherboards	
QTC-MB8B	\$35.00	QTC-MB12B	\$40.00
QTC-MB8K	\$65.00	QTC-MB12K	\$65.00
QTC-MB8A	\$85.00	QTC-MB12A	\$135.00

18 Slot Motherboards		22 Slot Motherboards	
QTC-MB18B	\$65.00	QTC-MB22B	\$75.00
QTC-MB18K	\$135.00	QTC-MB22K	\$150.00
QTC-MB18A	\$185.00	QTC-MB22A	\$200.00

## QT 8" THINLINE MAINFRAME



• Provisions for 2 ea 8" thinline drives • 15 ea DB 25 cutout  
• 2 ea 50 pin • 2 ea 34 pin • 1 ea Centronic  
• EMI filter (fused) • 2 AC outlets  
• Power supply (- 8V18A/ - 5V1A/ - 24V8A)

Cadillac Version  
QTC-IMF - DD8C (8 slot MB) \$500.00

Ford Version  
QTC-IMF - DD6F \$389.00

## QT DISK DRIVE CABINETS



### "All In One" Vertical Disk Drive Cabinet

For 1) 2 ea or 4 ea 8" thinline drive  
2) 2 ea standard 8" drives  
3) 1 ea hard disk + 1 ea standard 8"

• Power supply (- 5V6A/ - 5V1A/ - 24V8A)  
• Positive pressure fan w/filter • EMI filter  
• Power interface cable for any 8" drive

QTC-DDC88V For 2 standard size 8" drives \$325.00  
QTC-DDC88T For 2 thinline 8" drives \$325.00  
QTC-DDC8V For 1 ea 8" drive \$275.00

### Horizontal Disk Drive Cabinet

For 2 ea 8" standard size drives  
• Power supply (- 5V6A/ - 5V1A/ - 24V8A)  
• Interface cable for any 8" drive

QTC-DDC88H \$300.00

## DISK DRIVES

### 8" Disk Drives

801R Shugart SS/DD \$395.00  
851R Shugart DS/DD \$455.00  
DT8 (842) Dume DS/DD \$485.00  
BEST M-2894-63 MIT DS/DD \$408.00  
BUY (call for qty price)  
M-2896-63 MIT 8" thinline DS/DD \$475.00

### 5 1/4" Disk Drives

TM100-1 or B-51 for IBM \$200.00  
TM100-2 or B-52 for IBM \$270.00

## QT DISK DRIVE SUB ASSEMBLY

• Vertical or horizontal disk cabinet - 11 1/2" x 11 1/2" x 20" d  
5 1/2" x 17" w x 20" d

QTC-DDS + 0 w/2 ea SS/DD Siemens drives \$595.00  
QTC-DDS + 1 w/1 ea DS/DD MIT 2894-63 \$685.00  
QTC-DDS + 2 w/2 ea DS/DD MIT 2894-63 \$1150.00  
QTC-DDS + 3 w/2 ea SS/DD 801R Shugart \$975.00  
QTC-DDS + 4 w/2 ea DS/DD 8" thinline drives \$1150.00

## TERMINALS

Teletype 925C \$725.00  
Teletype 970 \$1095.00

## MONITORS

BMC12A (15 MHz) \$75.00  
BMC12EV (20 MHz) \$129.00  
BMC Color #9191 \$279.00  
Sanyo 12" Green (15 MHz) \$80.00

## PRINTERS

Star-Gemini \$355.00  
OK1-82A (120 cps) Serial + pad \$389.00  
OK1-83A (120 cps) Serial + pad \$649.00  
OK1-84A (200 cps) Serial \$1079.00  
OK1-92A (160 cps) \$519.00  
OK1-93A (160 cps) \$899.00  
NEC-8023A \$475.00  
BEST BUY  
Toshiba P-1350 (LTR quality) \$1575.00  
Tractor \$295.00  
Sheet feeder \$1095.00

## BOARD SETS

Best Bare Board Not Available

QTC-SBC 2/4 CPU  
QTC-EXP - III 256K Memory bd  
QTC-FDC 5/8 Floppy disk controller  
Bare Board Set ..... \$150.00  
1) Includes manuals & assembly instructions  
2) Parts available  
3) Monitor & B106 available

## QT CLOCK/CALENDAR

S-100 or Apple • Time in hrs, min, sec • AM/PM or Military  
Format • Date in Mo., Day, Yr, Day of Week & Leap Year  
recognition • 4 hard interrupts (1024 Hz 1Hz, 1 min, 1 hr)  
• On board battery (will last 14 mos w/no power on)

QTC-CCS-BB (S-100) \$60.00  
QTC-CCS-K (M) for S-100 \$100.00  
QTC-CCS-A (A + T) for S-100 \$125.00  
QTC-CCA-BB (for Apple) \$40.00  
QTC-CCA-A (for Apple) \$125.00

## CPU BOARDS

QTC-SBC 2/4 BB \$50.00  
QTC-SBC 2/4 A A-T \$265.00  
QTC-Z-80 BB \$28.00  
Teletek FDC-1 A-T \$595.00  
Teletek Systemstar A+T \$695.00

## MEMORY BOARDS

DYNAMIC (64K/256K or 1 MEG)  
QTC-EXP - III Bare Bd. \$65.00  
QTC-EXP - III 64K A-T \$460.00  
STATIC  
S-RAM 64K BB \$80.00  
S-RAM 64 A + T \$349.00  
S-RAM 128K A + T (Fully IEEE696) \$695.00

## I/O

QTC-I/O + BB 2 SER 3 PAR \$60.00  
QTC-I/O + A + T \$340.00  
QTC-ADA ADA Converter A+T \$375.00  
QTC-Dual GPIB-488 IEEE 488 Interface bd A+T \$475.00

## DISKETTES

5 1/4" soft sector (for Apple) \$17.00 for 10  
1 yr warranty - with hub ring  
5 1/4" soft sector DS/DD \$24.00 for 10  
5 1/4" plastic library case \$2.50 ea, \$20.00 for 10  
Flip file storage case (stores 70 diskettes) \$19.00 ea

## APPLE CORNER

Micro-SCI Drive \$269.00  
w/controller add \$79.00  
Rana Elite I \$299.00  
Rana Elite II \$439.00  
Rana Elite III \$569.00  
Rana Controller \$99.00  
QT Apple Compatible Drive \$235.00

In Continental U.S.  
(800) 545-2633

Inside Utah  
(801) 972-4848

We accept cash checks, credit cards, or Purchase Orders from qualified firms and institutions. Minimum  
prepaid order \$15.00. Export customers outside the U.S. or Canada please add 10% to all prices. Prices  
and availability subject to change without notice. Shipping and handling charges via UPS Ground  
50c/lb UPS Air \$1.00/lb minimum charge \$3.00

Circle 210 on inquiry card.



# What's New?

NCOS is standard; NNET costs \$500.

Netway hardware is built around the Netway 200 communications processor. It supports up to 32 workstations and host ports and renders remote and local networking facilities. System architecture includes multiple-DMA, an 800K-byte floppy-disk drive, a Centronics parallel printer port, and six serial I/O ports that support asynchronous, bisynchronous, and bit-oriented protocols. The single-unit price is \$6880. Integrated 10- or 15-megabyte Winchester drives are available.

Additional hardware elements include a Z80-based device-interface processor with 64K bytes of memory and a local network interface, composed of a shielded cable and an RJ-11 connector. Prices range from \$200 to \$420.

A host of other hardware and interface modules are available as options. For details on possible configurations, contact Tri-Data, 505 East Middlefield Rd., Mountain View, CA 94043, (415) 969-3700.

Circle 603 on Inquiry card.

## CDI Creates Office Systems Environments

Computer Development Inc. (CDI) will design and support an office communications system to your specific needs. Major components of CDI's modular approach to elec-

tronic communications include the Electronic Telecommunications (ET) System 3000 family of portable microcomputers and the Voice Com software package.

The System 3000 has a built-in microprocessor-controlled modem that comes with full communications software, software-controlled answer/originate modes, Touch-Tone and rotary-pulse auto-dialers, variable 300- to 1200-bps (bit-per-second) data rates, half- and full-duplex operation, interactive vocal and data communications abilities, and an error detection/correction protocol that automatically detects and corrects mistakes occurring during transmission.

Unlimited voice and data communications over ordinary telephone lines are achieved by Voice Com, which features single-keystroke operation and permits a document to be created, discussed, and edited simultaneously on all terminals online. It's part of the Commail electronic mail system. Commail also includes a communications system management program and a call handler/telephone link controller.

Basic ET System 3000 hardware is made up of dual Z80 processors, 64K bytes of RAM (random-access read/write memory), a 12-inch nonglare green-phosphor display, and a 72-key keyboard with a separate numeric/cursor control pad and 8 user-programmable function keys. Built-in diagnostics,

CP/M, and a Help key are supplied. Software includes BASIC, COBOL, Supercalc, and applications packages.

Many options can be connected to the System 3000, including intelligent modems, mathematics and high-speed processors, and floppy- and hard-disk drives. For complete details on available systems and services, contact, CDI, Suite 200, 6700 Southwest 105th, Beaverton, OR 97005, (800) 547-1831; in Oregon, (503) 646-1599.

Circle 604 on inquiry card.

## Integrated Office System

IOAS (integrated office automation system) is an integrated set of software modules for computers running MS-DOS, such as the IBM Personal Computer. Produced by Micro Architect, the IOAS line comprises a database manager, an applications system, and a word processor with a full-screen editor. Among the modules is the Exec-I executive information system. It's made up of seven applications: appointment, stock security, mailing list, check writer, personal finance, personal inventory, and memo. A graphics module and a spreadsheet interface are planned.

The IOAS system requires a dual-disk or a hard-disk system, monochrome display, 64K bytes of memory (94K bytes for

the word processor), and a 132-column printer. Each module is sold separately, and prices range from \$98 to \$398. A 25% discount is allowed after the first module is purchased. For ordering information, contact Micro Architect Inc., 96 Dothan St., Arlington, MA 02174, (617) 643-4713.

Circle 605 on inquiry card.

## Database System Has Unique Zoom Function

Powerbase is an easy-to-use relational database management system from GMS Systems Inc. Powerbase has a unique Zoom feature that lets you zero in on any information within the database and show the detailed components of that information up to 16 levels deep. Designed for IBM Personal Computers running PC-DOS, Powerbase offers a fast search, sort, and select feature, user-defined screens for data entry, user-specified reports, special keys for "sounds like" retrieval, a front-end editor, and the ability to handle arithmetic expressions written in algebraic form. As many as 65,000 records of 1760 bytes each can be accommodated, and each record can hold up to 32 fields of 80 characters. All files are random access by means of B-tree structure.

This system comes with daily planner, financial/insurance record inventory,

# What's New?

expense reporting, and telephone/mailling list directory applications programs. It requires 128K bytes of memory, PC-DOS, two 160K-byte floppy-disk drives or a hard disk, a cursor-addressable terminal, and an 80-column printer. It costs \$475, including user and reference manuals. Contact GMS Systems Inc., 12 West 37th St., New York, NY 10018, (212) 947-3590.

Circle 606 on inquiry card.

## Low-Cost Network

EXO Corporation reports that a fully functional network system can be achieved at a low cost with its Avalanche computer and EXO/Net, an enhanced version of CP/Net. The EXO system is a distributed network with sharing of disks, programs, databases, and printers, as well as full communications abilities. It supports up to 31 stations and one file server per channel. Individual computers in the network operate under CP/M when equipped with local disk storage. Stations are connected to a single twisted-pair cable up to 4000 feet long. The data rate is 800,000 bps (bits per second). Interfaces for other protocols to allow users access to mainframes and external databases are under development.

The file server runs the multitasking MP/M II oper-

ating system, which offers real-time capabilities and file protection with password access. Accounting, word processing, text editing, utilities, and electronic mail programs come standard.

The Avalanche is a single-board Z80A computer with 64K bytes of RAM (random-access read/write memory), RS-232C and RS-422A ports, and two parallel Centronics ports. It costs \$595. A version with a floppy-disk controller for up to four 5¼- or 8-inch disk drives sells for \$795. For \$1795, the Avalanche can be purchased with a separate hard-disk controller board. These products are supplied with integral voltage regulators for OEM (original equipment manufacturer) applications. Contact EXO Corp., 1265 Montecito Ave., Mountain View, CA 94043, (415) 969-8624. Circle 607 on inquiry card.

## Apple Nets Local Network Scheme

Apple Computer plans to market the Applenet, which will electronically link Lisa and Apple II/III computers so that they can exchange information and share central files. Network connections will be a drop cable and a cluster box supporting up to four computers. For large networks, cluster boxes can be connected to a twin axial network cable capable of 1 million-bit-per-second transmis-

sion. Two thousand feet of cable can support up to 32 cluster boxes for a total of 128 systems.

Applenet will employ baseband bus architecture with carrier-sense multiple access with collision detection (CSMA C/D) to avoid data loss during communication. All network components are located on an interface card that plugs

into the computer. The Applenet, which will use the Xerox Network Systems (XNS) protocol, will be sold through Apple dealers and Apple's National Accounts program. For full details, contact Apple Computer Inc., 20525 Mariani Ave., Cupertino, CA 95014, (408) 973-3019.

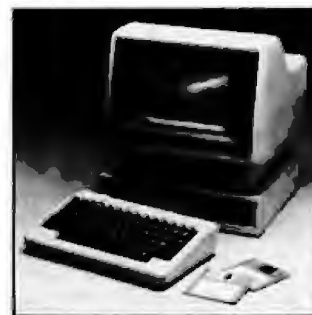
Circle 608 on inquiry card.

## SYSTEMS



## HP's First 16-Bit Personal Computer

The HP Series 200 Model 16 is Hewlett-Packard's first 16-bit personal computer. The Model 16 will be sold through direct sales and retail computer stores. Based on the Motorola MC68000 microprocessor, the Model 16 offers an 8-MHz system clock and a choice of 3½-inch micro-floppy-disk drives. It has a 9-inch display, a detached ASCII keyboard, 128K bytes of main memory, graphics capabilities, and built-in parallel and serial inter-



faces. The video screen features an 80-character by 25-line display format with a resolution of 300 by 400 pixels. Its keyboard is outfitted with five user-



# What's New?

definable softkeys (ten with shift) and a rotary control knob for rapid program editing, cursor positioning, and analog control of instruments. The Model 16 can be linked in a network that shares disk drives and printers.

Three languages are available for the Model 16: BASIC, HPL, and Pascal. HP BASIC includes such enhancements as subprograms, multidimensional arrays, unified I/O and mass storage, labeled common blocks, and external program control. Application packages cover computer-aided engineering tools, mathe-

matics modules, and business aids. The company is investigating the possibility of offering Digital Research's CP/M operating system on the Model 16 and plans to provide its own version of the Unix operating system in the future.

Among the Model 16 options are a tilt-and-swivel display accessory and a dual micro-floppy drive. Including the processor, display, keyboard, and 128K bytes of memory, this system costs \$3650. Contact your local Hewlett-Packard sales office for complete details. Circle 609 on inquiry card.

mentations of FORTRAN 77, RM/COBOL, Pascal, and SMC BASIC are supported. Business applications software to run with the 3300 includes a database-management system, an electronic spreadsheet, and word-processing packages.

The standard eight-user 3300 comes with an Integral 5¼-inch 33-megabyte Winchester hard-disk drive and lists for \$9600. A two-user version with 12 megabytes of Winchester storage costs \$7800. For multitasking, multiuser applications, the Codata 3300 can be purchased with an 8-inch 84-megabyte Winchester drive for \$13,500. Contact Codata Systems Corp., 285 North Wolfe Rd., Sunnyvale, CA 94086, (800) 521-6543; in California, (800) 221-2265. Circle 610 on inquiry card.

4.2K bytes of RAM (random-access read/write memory) that can be expanded to 36.2K bytes, a built-in RF (radio frequency) modulator, and monochrome display capabilities. For expansion, this system is equipped with a rear-panel peripheral interface connector for a variety of units especially designed for it, including an RS-232C interface, a digital tape drive, and a four-color printer/plotter. Later this year, Texas Instruments plans to release other peripherals, such as modems, printers, a wand input device, and a black-and-white monitor.

The TI-99/2 uses software on solid-state cartridges and cassettes. Initially, two cartridges are available: "Learn to Program" and "Learn to Program BASIC." In addition, 20 cassette-based programs covering education, personal management, and entertainment are scheduled for introduction this quarter. The suggested retail price of each cartridge is \$19.95, and most cassette-based programs cost \$9.95.

The TI-99/2 comes with a video cable and antenna switch for connection to any television, an interface cable that hooks directly to a cassette-tape player, an AC adapter, a user's manual, and a demonstration cassette. It costs \$99.95. For details, contact Texas Instruments Inc., Consumer Relations Department, POB 10508, M/S 5828, Lubbock, TX 79408, (800) 858-4565. Circle 611 on inquiry card.



## 68000 Unix-based System Uses Multibus Architecture

The Codata 3300 is an MC68000 Unix-based microcomputer from Codata Systems Corporation. This system comes with 320K bytes of parity-protected RAM (random-access read/write memory), expandable to 1.5 megabytes with memory management. Its Multibus architecture supports a variety of mass-storage configurations. Backup

data storage is available through quad-density floppy disks, cartridge tape, or 9-track tape drives.

All the software and programming languages developed for the Codata CTW-300 computer are fully compatible with the 3300. These include APL/68000, a BASIC-Plus-compatible interpreter, and Unisis, Codata's Unix superset. Standard Imple-



## 16-Bit Computer Costs Less Than \$100

The TI-99/2 Basic Computer from Texas Instruments may be the first 16-bit computer for less than \$100. Targeted at the technical enthusiast, engineer, and student, the TI-99/2 has a standard typewriter-like keyboard,

# What's New?

## PERIPHERALS



### Color Monitor with Headset for Privacy

A color monitor for personal and business computers featuring a non-glare screen, the Color-I Plus is manufactured by Amdek Corporation. The 13-inch Color-I Plus has a line resolution of 260 (horizontal) and 300 (vertical). It accepts a composite-video signal and comes with front compartment controls, a built-in audio amplifier, and a carrying handle. The Color-I

Plus is supplied with a headset for private operation. The unit's speaker automatically shuts off when the headset is connected.

The Color-I Plus costs \$449. For more information, contact Amdek Corp., Marketing Department, 2201 Lively Blvd., Elk Grove Village, IL 60007, (312) 364-1180. Circle 612 on inquiry card.

### Video Board Displays

#### Uppercase/Lowercase in 80 by 25 Format

The 82-018 stand-alone video-terminal board from John Bell Engineering displays 80 columns by 25 lines of uppercase and lowercase characters. This video board uses a 6502 microprocessor and has RS-232C I/O lines for direct connection to a computer or modem. The 82-018 transfers data at rates

ranging from 110 to 9600 bps (bits per second) through switch-selectable RS-232C lines. An on-board UART (universal asynchronous receiver/transmitter) is controlled by a five-position DIP (dual-inline pin) switch. Hardware features include 4K bytes of 6116-type RAM (random-access

read/write memory), 2716 EPROMs (erasable programmable read-only memories) for character generation and video program control, a 6545-1 display controller, an interrupt-driven serial input port, and a 1500-character buffer. Power requirements are +5 V (volts) at 700 mA (milliamperes), +12 V at 50 mA, and -12 V at 50 mA.

The 82-018 requires a parallel ASCII keyboard, a standard NTSC (National Television Standard Code) monitor, and power supply. It can be purchased fully assembled and tested for \$199.95 or as a bare board with EPROMs and crystal for \$89.95. Shipping and handling fees are additional. Complete source listings are included in the documentation. Both versions are available directly from John Bell Engineering Inc., 1014 Center St., San Carlos, CA 94070, (415) 592-8411. Circle 613 on inquiry card.

### Hard Disk for APC

NEC Information Systems is marketing a 12-megabyte hard-disk subsystem for its Advanced Personal Computer. This high-performance 5¼-inch drive stores 9.27 megabytes of formatted data and transfers data at a rate of 500K bytes per second. Track-to-track head movement time is 120 ms (milliseconds) and the access time averages 130 ms. The rotation rate is 3000 revolutions per

minute. This system's hardware features a direct-drive DC spindle motor, microprocessor controls, and LSI (large-scale integration) circuits. Mean time between failures is 12,000 power-on hours. It measures 6¼ inches high by 9⅞ inches wide by 15 inches deep.

The APC hard-disk subsystem costs \$2798. The 16-bit APC computer is 8086-compatible and supports CP/M-86, MS-DOS, and the UCSD p-System. Address inquiries to NEC Information Systems Inc., 5 Militia Dr., Lexington, MA 02173, (617) 862-3120.

Circle 614 on inquiry card.

### Combination Cards for IBM PC

The XPR Series of Multi-function Combination Cards for the IBM Personal Computer can be equipped with a parallel port, a serial RS-232C port, a clock/calendar with battery backup, or all three functions. The parallel port comes with required hardware and connectors for use as either a printer or as a SASI (Shugart Associates Standard Interface) hard-disk interface. The serial port, with a DB25 connector, can be used as COM1 or COM2. Both ports can be individually disabled. The clock/calendar option, coupled with its companion software, automatically provides current time and date information to the PC. The XPR comes on a single printed-circuit



# What's New?

board and with up to 256K bytes of memory.

The XPR is supplied with installation and reference manuals, internal cabling, connectors, mounting hardware, and a diagnostic disk. Prices range from \$350 to \$650 for one option and 64K to 256K

bytes of memory. Your second option costs \$45; the third is \$30. Quantity and dealer discounts are available. Contact IDE Associates, 44 Mall Rd., Burlington, MA 01803, (617) 272-7360.

Circle 615 on inquiry card.

knob. Frequency response is 300 to 3000 Hz.

Supertalker requires a 64K-byte IBM PC and a single disk drive. It comes with menu-driven software for creating and editing phrases, 32K bytes of RAM (random-access read/write memory), a loudspeaker, and a microphone. Supertalker II costs \$565 and is available at Mountain Computer retail stores. Mountain Computer Inc. is located at 300 El Pueblo Rd., Scotts Valley, CA 95066, (408) 438-6650.

Circle 617 on inquiry card.



## Supertalking IBM Personal Computers

Mountain Computer's Supertalker II gives your IBM Personal Computer a vocal outlet. Sound enters the Supertalker through a microphone and is then digitized and stored on a floppy disk for playback through a loudspeaker or the PC's speaker. This plug-in board is said to reproduce a human voice in a manner similar to an audio tape recorder, providing inflection not possible with voice synthesizers. A single floppy disk

can record up to 2 minutes of phrases or sentences, and voice output can be accessed with Supertalker's software or by user-developed BASIC programs.

A data-compression technique minimizes disk-storage requirements. Three digitizing rates, ranging from 2K to 4K bytes per second, control the quality of reproduction, and the volume is controlled by software or with a built-in control

(57.6 megabytes total). For the location of the dealer nearest you, or for more information, contact Xiten Systems, 16815 Hawthorne Blvd., Lawndale, CA 90260, (213) 370-3966.

Circle 618 on inquiry card.

## Voice-Response Unit with Modem

A low-speed modem now complements the single-board interactive voice-response unit for Apple II from Vynet Corporation. The basic element of the response unit, the V101-A Interactive Telephone Interface board, is designed to plug into an Apple peripheral slot and connect directly to the telephone network. It can answer on ring and dial and detect Touch-Tone signals. With this unit, users can call or be called by a computer and respond with Touch-Tone signals to computer inquiries for modifying program flow or updating the database, without terminals or dedicated lines. A set of 20 routines, resident in ROM (read-only memory), preprograms all functions to control interface hardware. Voice-response capabilities are provided by the V200-VSM (voice-synthesizer module). The V200-VSM, an LPC (linear-predictive coding) based unit, comes with a 300-word vocabulary on disk; a 1300-word option is available.

The modem option consists of the V103-A



## Winchester Storage for Apple and PC

Xiten Systems is offering an 11.3-megabyte Winchester-disk subsystem for Apple II/IIIe and IBM Personal Computers through a select network of IBM and Apple dealers. The Gallium 10 stores 14.4 megabytes of unformatted data and can be partitioned for DOS 3.3, CP/M, and Pascal when used with Apple computers. For the PC, it can operate under PC-DOS or CP/M-86. Its cabinet and power supply can support two Winchester-disk drives (28.8 megabytes total storage), and its controller can handle four drives in two cabinets

# What's New?

motherboard and the V200-LSM (low-speed modem). The V103-A fastens into a slot on the Apple and is cable-connected to the V101-A. The V200-LSM provides 300-bps (bit-per-second), Bell 103-compatible half- or full-duplex data-communications abilities. In systems equipped with both the V200-VSM and the V200-LSM, the V101-A permits voice and data communications to share a single telephone line.

System software comes in Applesoft, Pascal, or CP/M formats. The V101-A costs \$295, and the V103-A is \$19.95. Both the V200-VSM and the V200-LSM are \$149. Contact Vynet Corp., 160B Albright Way, Los Gatos, CA 95030, (408) 370-0555. For an online demonstration, call (800) 538-7002 or (408) 370-9764.

Circle 619 on inquiry card.

## **PUBLICATIONS**

### **Timex/Sinclair Sourcebook**

The Timex/Sinclair Sourcebook is a directory of more than 600 programs, hardware accessories, add-on memories, and books for Timex and Sinclair computers. Produced by Micro Design Concepts, the Sourcebook lists and describes mail-order products from almost 160 sources. Each listing provides such facts as program highlights, type of media, minimum

system configuration, price, and ordering information. The entries are organized by category: games, education, business, home/personal use, hardware, and books/catalog.

The 96-page Timex/Sinclair Sourcebook costs \$6.95, plus \$1.25 postage and handling; \$2.50 postage and handling outside the U.S. It's available from Micro Design Concepts, Department F, POB 280, Carrollton, TX 75006.

Circle 620 on inquiry card.

### **Report Studies Electronic Typewriters**

Seybold Publications has released a comparative study entitled *Electronic Typewriters: Getting Started for Less Than \$2000*. This analysis of the major products on the electronic typewriter market covers such manufacturers as IBM, Xerox, Exxon, Olivetti, Olympia, and Royal. A discussion of the role of the electronic typewriter in the automated office, a summary of functions available, a glossary of terms, and a comparison chart of model features are included.

For subscribers of the *Seybold Report on Office Systems*, this report costs \$75; nonsubscribers pay \$100. Order it directly from Seybold Publications Inc., POB 644, Media, PA 19063, (215) 565-2480. Circle 621 on inquiry card.

### **Directory Covers Products for IBM**

The *Directory of Independent IBM Personal Computer Hardware and Software* from Infopro is a comprehensive buyer's guide of software and hardware developed for the IBM Personal Computer. It contains descriptions and evaluations of more than 400 products and provides the addresses and telephone numbers of all the vendors profiled. All the software in the directory runs under the PC-DOS operating system.

This directory costs \$29.95. It's available at participating dealers or directly from Infopro Inc., POB 22, Bensalem, PA 19020, (215) 750-1023. Circle 622 on inquiry card.

### **Win at Home Video Games**

*How to Win at Home Video Games* analyzes 70 home-video games step by step so that you can develop game-winning strategies. It covers such games as Adventure, Donkey Kong, and Utopia designed for Atari, Intellivision, Odyssey 2, and Colecovision game systems. Descriptions and buying guide information are included.

This 4-color, 64-page book by the editors of *Consumer Guide* magazine costs \$3.98. It's published by Beekman House and distributed by Crown Publishers, One Park Ave., New York, NY 10016. Circle 644 on inquiry card.

### **Guide Spans Databases**

The current edition of the *Directory of Online Information Resources* covers more than 720 databases up and running in North America. This guide has subject, vendor, and producer indices, address and telephone information for all database producers and vendors, and database price information. It's completely revised semiannually.

Single copies of the directory costs \$22.50, plus \$1.50 postage and handling. A subscription price of \$60 (four issues) is available. To order, contact the CSG Press, 11301 Rockville Pike, Kensington, MD 20895, (301) 881-9400.

Circle 623 on inquiry card.

## **SOFTWARE**

### **Suspended Joins Interlogic Line**

Infocom has announced *Suspended*, the sixth game in the Interlogic product line. *Suspended* joins such adventure games as *Deadline*, *Starcross*, and the *Zork* trilogy. Interlogic games are highly interactive and feature a programming language that permits complete sentence communication between player and computer. The games run on virtually any computer, including DEC Rainbow, TI Professional Computers, Osborne 1, NEC APC, and 8-inch CP/M-based systems.



# What's New?

In *Suspended*, you and your six robot assistants must rescue the population of a planet deep in outer space. While in a limited state of cryogenic suspension, you must repair damage on the planet with your robots. The robots, which can act for you independently of one another, can be sent to different locations and make subsequent moves. *Suspended* is the first Interlogic game to have a functional game board with movable pieces. Estimated playing time is 30 hours.

*Suspended*, which was released early last month, is the brainchild of Michael Berlyn. It costs \$49.95 and is marketed through software distributors, major retail stores, and personal-computer manufacturers. Infocom Inc. has its headquarters at 55 Wheeler St., Cambridge, MA 02138, (617) 492-1031. Circle 624 on inquiry card.

## Commodore 64 Accounting System

Info-Designs has reprogrammed its Management Accounting System for the Commodore 64 computer. Currently, five modules are available: Accounts Receivable/Billing, Accounts Payable/Check-writing, General Ledger, Inventory Control, and Payroll. These programs work with one or two Commodore 1541 single-disk drives and a matrix printer. They cost \$199 each and are marketed

through more than 600 Commodore dealers nationwide. An electronic staff-scheduling and appointment handler program, called the Electronic Calendar, will be available in June. For full dealer and end-user information, contact your local Commodore regional office or Info-Designs Inc., 6905 Telegraph Rd., Birmingham, MI 48010, (313) 540-4010.

Circle 625 on inquiry card.

## Access 8086 Development Software

Genesis Microsystems' Access lets you run Intel Series-III 8086 development software on your Compaq or IBM Personal Computer at a substantial cost savings. A version for systems running CP/M-86 is also available. With Access, your computer can run such software as PL/M-86, FORTRAN-86, and Pascal-86. Access provides you with an operating system adapter program and a data link program for transferring files between your computer and Intel Series-II/III systems. A program that connects your computer to Intel's 957A debugger for downloading programs to your system is also available. It costs \$450.

For a complete 8086 development system, the manufacturer recommends a 128K-byte computer with MS-DOS, two 320K-byte floppy-disk drives (or a hard disk), a

monochrome display, and a text editor. Access costs \$950 and can be ordered directly from the manufacturer. For benchmark and price comparisons, contact Genesis Microsystems, POB 70280, Sunnyvale, CA 94086, (408) 241-3727.

Circle 626 on inquiry card.

## High-Quality Text Processor

The print quality of the Incredible Text Printer (ITP) from Datamed Research is said to be equivalent to the best stand-alone word processors and to exceed that of any other text processor. ITP has extensive, built-in automatic text-formatting capabilities and a series of menus to help you set up printing formats. Among its text-formatting options are underlining, boldface, subscript, superscript, variable character widths, tab and line drawing, and table and figure relocation. ITP automatically hyphenates words at the end of the line, creates indexes and tables of contents, and numbers sections, tables, and figures. It gives you extensive control over headings, subheadings, and footers, including centered and left and right justified fields. With this system, you can insert files from within other files, add pages, and generate personalized form letters or customized text from name and address files or entered from the console. Other features include

run-time entry of text or instructions from the console.

ITP runs on UCSD Pascal-compatible systems. It requires 56K bytes of memory, two floppy-disk drives or a hard disk, an external text editor, and a 24-line by 80-character display monitor. It costs \$249, which includes six months of free updates. A demonstration disk can be purchased for \$60, and the manual alone is \$30. Dealer terms are available. Datamed Research Inc. is located at 1433 Roscomare Rd., Los Angeles, CA 90077, (213) 472-8825. Circle 627 on inquiry card.

## User-Friendly Spreadsheet

The Timberline Spreadsheet is said to be a user-friendly system designed for small businesses with no prior computer experience. Timberline features an array of statistical calculation capabilities and six conditional statements for developing reports based on changing financial parameters. Conditional statements allow almost any set of conditions to be entered into the spreadsheet in an If . . . Then format. While it offers traditional financial calculations, Timberline is also flexible enough to calculate such equations as net present value and internal rate of return. Statistical calculations include linear regression, correlation coefficients, dependent vari-

# What's New?

able, analysis independent variable, and standard deviation.

The Timberline Spreadsheet's double-window display lets you view separate areas on the worksheet. Its editing function, based on user-definable commands, permits rows and columns to be inserted, deleted, or moved. Rows can also be sorted by alphabetic or numeric information, and blocks of data can be moved.

This package will run on computers using the UCSD p-System with a minimum of 64K bytes of memory and two floppy-disk drives. The Timberline Spreadsheet costs \$395 and can be purchased factory-direct from Timberline Systems Inc., 10550 Southwest Allen Blvd., Beaverton, OR 97005, (503) 643-9461.

Circle 628 on inquiry card.

## CP/M Graphics Conforms to GKS, VDI Standards

Digital Research designed CP/M Graphics architecture with standard interfaces at the programmer and device levels. The programmer interface conforms to the emerging ANSI and ISO Graphical Kernel System standard, which provides source-code portability. The device-level interface addresses ANSI VDI (Virtual Device Interface) to provide object code portability. The CP/M Graphics line is comprised of six prod-

ucts: GSX, GSS-4010, GSS-Kernel, GSS-Plot, GSS-Graph, and GSS-Draw.

GSX is required by all the packages in the line. It's the graphic system extension to the CP/M operating system. It provides graphic output through standard operating-system calls. Three components make up GSX: GDOS (Graphics Device Operating System), GIOS (Graphics Input/Output System), and the Gengraf utility, which configures a graphics application to run in the GSX environment.

Other programs let you use graphic software that currently exists only on mainframe computers, create portable graphics applications programs, produce programs for typical business, engineering, and scientific representations, and create and edit presentation-quality charts and diagrams. For complete details on the CP/M Graphics product line, contact Digital Research, POB 579, Pacific Grove, CA 93950, (408) 649-5500.

Circle 629 on inquiry card.

## Speechware: Software with the Gift of Gab

Centigram Corporation and Peachtree Software have teamed up to produce a line of talking software, known as Speechware. This speech-synthesis system works with hardware devised by Centigram and with

speech files created and edited by Peachtree Software, maker of the Peachpak 8 Accounting Series and other software packages. It's reported that this combination produces user-friendly software that's suitable for teaching people with limited computer knowledge how to process information. Speechware will provide voice capabilities to existing or forthcoming Peachtree software.

Centigram's Voiceware Development System is the hardware heart of Speechware. It offers bit rates averaging 3000 bps (bits per second), which reduces the amount of host computer overhead as well as the amount of mass storage needed to hold messages. Voiceware digitizes and compresses analog waves using a proprietary coding technique known as PWC (parametric waveform coding). Analyses of waveforms are done at variable-length intervals, with frame rates determined by the voiced or unvoiced events in the original speech. This results in a synthesized waveform that's nearly identical to the original. Voice output is achieved by means of Centigram's Sybil synthesizer board, which uses the General Instrument SPO250 chip. Sybil is compatible with the IBM Personal Computer.

For further details, contact Centigram Corp., 1153 Bordeaux Dr., Sunnyvale, CA 94086, (408) 734-3222.

Circle 630 on inquiry card.

## OEM Applications Sought for Image Recognition System

Sirius Software is seeking OEM (original equipment manufacturer) applications and will consider a variety of licensing agreements for its stand-alone, Multibus-based image-recognition system, called Floyd. This system uses a custom-designed video processor and an NSC 16032 central processor. The video processor demodulates and digitizes an incoming NTSC (National Television Standard Code) color signal, then it fills two 64K-byte memory planes 60 times a second. The central processor can access this memory continuously for real-time image analysis. Floyd's color resolution is 510 by 213 pixels through a 4-bit gray scale. Color is demodulated to red/yellow, blue/yellow format.

Floyd offers softswitch-selectable code conversions for linear, log, or inverse storage, and it has 8-bit color storage (256 colors) as red/yellow, blue/yellow vectors with softswitch-selected code conversion for hue correction. Video memory is 128K bytes, expandable to 256K bytes using 150-nanosecond RAMs (random-access read/write memories).

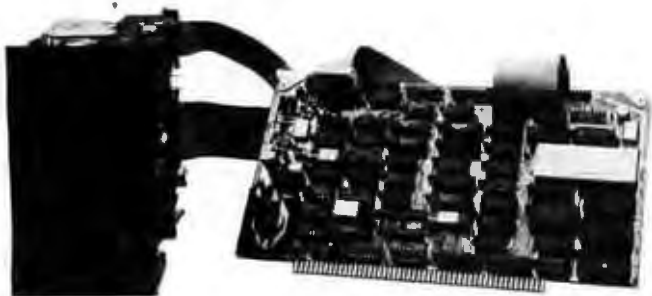
For complete technical specifications, contact Sirius Software, Research and Development Department, 10364 Rockingham Dr., Sacramento, CA 95827, (916) 366-1195.

Circle 631 on inquiry card.



# What's New?

## MISCELLANEOUS



### Hard-Disk Subsystem Has Error-Correcting Controller

Advanced Digital Corporation has unveiled a 5¼-inch Winchester hard-disk subsystem for S-100 microcomputers. This system is built around the company's HDC-1001 error-correcting hard-disk controller board, which features an onboard microprocessor, multiple burst detection, up to 9-bit single burst correction, and data rates approaching 5 megabytes per second. A built-in 32-bit computer-generated polynomial is said to be able to detect and correct errors before the user is even aware of them. The HDC-1001 can control up to four drives and as many as eight read/write heads and is IEEE 696 (S-100) compatible.

The Winchester subsystem comes with the HDC-1001 controller board, connector cable, CP/M BIOS disk, and drive mechanisms. It's available in 5-, 10-, 20-, and 40-megabyte versions. The 5-megabyte model uses Seagate Technology's ST506 drive, and the 10- and 20-megabyte units feature the miniscribe

drive. Prices begin at \$1800; quantity discounts are offered. Contact Advanced Digital Corp., 12700 B Knott Ave., Garden Grove, CA 92641, (714) 891-4004. Circle 632 on inquiry card.

### Tomorrowhouse Today

Tomorrowhouse is a turnkey home monitoring and control system from Compu-Home Systems. It's based on the Apple II computer and is made up of a plug-in circuit board, a junction box, hardware for hookups, all the programs needed to set up and control your house, and installation and user manuals.

Tomorrowhouse lets you schedule heating and cooling systems up to nine weeks in advance with as many as 48 changes per day. You can automate your lights, appliances, and hot tub for maximum energy conservation. Complex heating and

cooling and light/appliance schedules for different circumstances can be stored and recalled for execution whenever necessary. Verbal warnings and an easy-to-read graphics display of your home's floorplan with status information presented both graphically and verbally are provided by Tomorrowhouse. Convenience features include an appointment calendar, a voice wake-up call, and a record-keeping system that tracks each time Tomorrowhouse is booted or an alarm detected.

Tomorrowhouse is available in kit form or dealers can provide turnkey installation. For individuals with Apple computers, kit prices start at less than \$1000. For full details, contact Compu-Home Systems Inc., 3333 East Florida Ave., Denver, CO 80210, (303) 777-6600.

Circle 633 on inquiry card.

### Computer Camps

The following is a list of computer camps and where to send for complete information.

**Camp Compuquest**, POB 8161, Lexington, KY 40533, (606) 278-9933.

**Champlain College Computer Camp**, Shelley Richardson, Room #4A, Box 670, 163 South Willard St., Burlington, VT 05402, (802) 658-0800.

**Compu Camp**, 7101 York Ave. S, Edina, MN

55435, (612) 835-0064.

**Computer Camp**, Registrar, J. Hamilton Welch Academy, 3049 McGregor Blvd., Fort Meyers, FL 33901, (813) 334-6044.

**Computer Camp Inc.**, Suite G, 1235 Coast Village Rd., Santa Barbara, CA 93108, (800) 235-6965; in California, (805) 969-7871.

**Computer Camps International**, Suite D, 310 Hartford Turnpike, Vernon, CT 06066, (203) 871-9227.

**Computer Experience**, Performance Designs Inc., 1411 North Main St., POB 124, Bluffton, IN 46714, (219) 824-5120.

**Family Computer Camp**, Conference and Information Center, Clarkson College, Potsdam, NY 13676, (315) 268-6647.

**Hockaday Computer Camp**, 11600 Welch Rd., Dallas, TX 75229, (214) 363-6311.

**Lake Forest Computer Camp**, Lake Forest College, Sheridan and College Roads, Lake Forest, IL 60045, (312) 234-3100.

**Long Acres Computer Camp**, Route 1, Box 320, Spotsylvania, VA 22553, (703) 582-5382.

**National Computer Camp**, POB 585, Orange, CT 06477, (203) 795-9667.

**Tar Heel Career Camps Inc.**, POB 2328, Chapel Hill, NC 27514, (919) 967-6996.

**Timbertech Computer Camp**, 1287 Lawrence Station Rd., Sunnyvale, CA 94086, (408) 745-1110.

**Virginia Tech Computer Camp**, Carisa Blaylock, College of Education, 400 War Memorial Gym, Virginia Tech, Blacksburg, VA 24061, (703) 382-2123.

# What's New?



## Bulk Eraser Works Without Batteries, External Power

Nortronics' Model CMP-230 Computer Tape Bulk Eraser is a handheld unit with two strontium-ferrite magnets for quick erasures of standard-size cassette tapes. The magnets are divided into four quadrants of north and south poles and are positioned so that a cassette encounters 16 different flux fields as it passes

through. This unit operates without batteries or external power supplies.

The Model CMP-230 Bulk Eraser has a \$49.50 suggested retail price. It's manufactured by Nortronics Co., Inc., 8101 Tenth Ave. N, Minneapolis, MN 55427, (612) 545-0401.

Circle 634 on inquiry card.

## Tecmar Markets IBM PC Packages

Tecmar manufactures more than 60 peripherals and software packages for the IBM Personal Computer. Its hardware includes a high-speed, 5-megabyte removable-cartridge Winchester disk drive, a 15-megabyte Winchester system, high-resolution graphics, an Ethernet network interface, and a voice-recognition unit with a 100-word vocabulary. Tecmar's software includes such offerings as

the Coherent DOS (a Unix look-alike with real-time extensions and multiuser, multitasking capabilities) and support packages for laboratory hardware, an IEEE-488 interface, and an EPROM (erasable programmable read-only memory) gang programmer. For information, contact Tecmar Inc., 23600 Mercantile Rd., Cleveland, OH 44122, (216) 464-7410.

Circle 635 on inquiry card.



## Apple-Compatible Keyboard

The Model KB-200 detached keyboard is plug-compatible with the Apple II computer. Available directly from Key Tronic Corporation, the low-profile KB-200 has 83 keys, a combination cursor and standard numeric keypad, and an extra Return key for use as an Enter key. Cursor controls include diagonal movements. Eleven functions keys are provided for easy multiple-key functions, and a movable jumper causes the keyboard to output lower-case characters if the Apple is equipped to accept them. Standard fea-

tures include sculptured, nonglare keytops with double-shot molded keys, full key travel with positive tactile feedback, N-key roll-over, microprocessor electronics, solid-state capacitances, and a flexible cable.

With postage, the Model KB-200 costs \$298. Contact Key Tronic Corp., POB 14687, Spokane, WA 99214. For ordering information, call (800) 262-6006; in Washington state, or for technical information, call (509) 928-8000.

Circle 636 on inquiry card.



## Cursor-Positioning System Has Cordless Mouse

The Datawafer cursor-positioning system from Display Interface Corporation consists of an ultra-

thin position detector and a cordless mouse. The mouse is powered by a self-contained recharge-



# What's New?

able battery and is available with 1, 3, 4, 12, or 16 keys for inserting instructions and data. The Data-wafer, only 0.2 inch thick, detects and transmits position information any time the mouse is within 3 inches of its surface. It comes with passive position-detecting elements, or it's available with electronic circuitry for signal conversion and for interfacing with data-processing systems. The optional electronics package can be

supplied as a separate plug-in card, or it can be mounted on the bottom of the Datawafer, increasing its thickness to 0.75 inches.

Cursor and stylus versions of the positioning device are being developed, each of which will be completely interchangeable with the mouse. Complete information can be obtained from Display Interface Corp., 525 Post Rd., Milford, CT 06460, (203) 877-7661. Circle 637 on inquiry card.



## Portable Gold-Plating System

A compact, portable gold-plating system suitable for quick and safe replating of edge connectors or gold-plated surfaces has been introduced by Pace Inc. The PEP-220 Gold-Plating System is a self-contained package that includes noncontaminating electrode assemblies, conductive and platers tape, power cord, case, tray, and gold-

plating, electro-cleaning, and nickel-plating solutions. The unit comes with the PPS-76 power source, which provides precise DC outputs for each solution.

The PEP-220 is being marketed through Pace representatives. For further details, contact Pace Inc., 9893 Brewers Court, Laurel, MD 20707, (301) 490-9860.

Circle 638 on inquiry card.



## From the New England Woods

New England Wood Designs has introduced a line of handcrafted computer furniture, all in a variety of hardwoods and native pine. This line includes computer desks, printer stands, file drawers, and accessories.

The computer desk is available in two heights (26 or 29 inches) and can accommodate a disk drive and a number of accessories. It has adjustable shelves and a multiple-out-

let AC-power bar. It measures 42 inches long and 30 inches wide. The printer stand features a paper-feed slot and paper storage shelf. Its dimensions are 20 by 16 inches and 26 or 29 inches high.

Desk prices begin at \$350. The printer stand starts at \$160. For further information, contact New England Wood Designs, RFD 1, Box 53, Greenfield, NH 03047, (603) 924-7367.

## FOREIGN

### Bimonthly Lists Published Programs

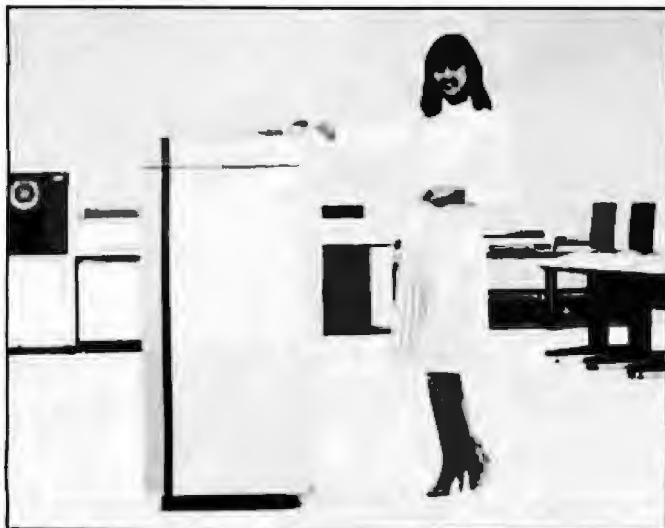
The Small Computer Program Index is a bimonthly index of printed program listings from a wide range of United Kingdom and American magazines and books. Subjects covered include science, social science, business and management, education, games, home applications, text and word processing, mathematics, statistics, and utilities. Most of the programs are in BASIC but are said to be equally ap-

plicable to mainframe computers that support BASIC, FORTRAN, and ALGOL.

The 1983 subscription price is \$45 (six issues and an index). For \$72, you can enter a subscription for 1983 and receive all the 1982 back issues. Small Computer Program Index is produced by Allm Books, 21 Beechcroft Rd., Bushey, Hertfordshire WD2 2JU, England; tel: Watford (0923).

Circle 639 on inquiry card.

# What's New?



## First 32-Bit Business Computer Unveiled

Mitsubishi Electric Corporation has announced the availability of the Model 500, Japan's first small-business computer using 32-bit architecture. System hardware includes 16 megabytes of logical space using a virtual storage-control system, a main-memory capacity of up to 8 megabytes, a magnetic disk drive capable of accommodating a large-capacity file of up to 4.8 gigabytes, and a 12-mega-byte-per-second transfer time. Up to 128 terminals (64 inline workstations and 64 online circuits) can be connected to the Model 500. For office automation, the Model 500 has Japanese word processing and business graphics capabilities. When running the DPS 10 processing system and relational database, the Model 500 is said to have the performance of a medium-sized general-purpose computer. DPS 10 enables five-dimensional multiprocessing: worksta-

tion, timesharing, transaction, remote-batch processing, and local-batch processing. High-level language support includes Mitsubishi's Duet conversational user language, COBOL, and FORTRAN.

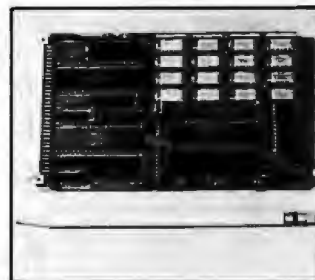
Options include an 8K-byte cache memory. For details, contact Mitsubishi Electric Corp., 2-3, Marunouchi 2-chome, Chiyoda-ku, Tokyo, 100 Japan; tel: Tokyo (218) 2171; Telex: J24532. Circle 640 on inquiry card.

## Survey Probes Users of Word Processors

The results of a recently conducted survey of 367 Canadian users of word-processing systems are available from Wordcom Centres Ltd. This survey examines the attitudes of operators, supervisors, and managers and their perceptions of the word-processing environment. The study begins by identi-

fying the decision-makers and highlighting the reasons contributing to the final selection of equipment. It then evaluates training, cost savings, service response time, and efficiency gained from the installation. In addition, this survey offers comparisons of the most frequently mentioned manufacturers and strives to show common denominators and the indicated results of certain approaches to the selection of people and systems.

Copies of this survey cost \$50 (Canadian). It's available from Wordcom Centres Ltd., Suite 100, 64 Shuter St., Toronto, Ontario M5B 2G7, Canada. Circle 641 on inquiry card.



## 128K-Byte Computer Packed on Eurocard

The Quark/100 from Megatel is an 8-bit, 128K-byte CP/M-compatible computer packed onto a single Eurocard. Megatel based the Quark/100 on the 6-MHz Zilog Z80B processor and used three PAL (programmable array logic) circuits and gate-array technology to squeeze all memory, disk, display, and I/O functions onto a standard 100

mm by 160 mm Eurocard.

The Quark/100 has a dual-mode alphanumeric/graphic video-display interface with a software-programmable character set. The display operates in an 80-column by 28-line format that's backed by a bit-mapped graphics mode using 24K bytes of dedicated RAM (random-access read/write memory). You can connect the Quark/100 to any standard display with its direct-drive and composite video outputs, and it has inputs for encoded or wire-only keyboards. Standard features include single- and double-density 5¼- or 8-inch floppy-disk interfaces, full-duplex and simplex RS-232C serial ports, a parallel port for a printer, and 22 general-purpose I/O lines for applications flexibility. For special-purpose peripherals, access to the central processor's address, data, and control buses is provided.

The Quark/100 is \$995 (U.S.). A complete package with a transistion board, connector, installation software, CP/M 2.2, and BIOS source listings costs \$995. A version with a color video-display interface with red/green/blue video outputs can be ordered. A 1-megabit-per-second network interface can be added to the Quark/100. Contact Megatel Computer Corp. Inc., 150 Turbine Dr., Toronto, Ontario M9L 2S2, Canada, (416) 745-7214.

Circle 642 on inquiry card.



# What's New?

## Energy-Management Module

An IEEE 696 (S-100) compatible energy-management module, the Model 100-EMM, is available from Fulcrum Computer Products Ltd. The module provides temperature-sensing facilities at four remote locations, relay or optoisolator on/off control for six external devices, and an eight-source fire or intruder alarm. Battery backup of the 100-EMM enables the alarm to operate independently of the host computer. The alarm has a 50-millisecond dwell period and three operating

conditions. Temperature-sensing functions are provided by means of four pairs of contacts connected to thermistor-sensing transducers. Six relays, rated at 28 amperes, operate independently under software control and can handle air conditioners, water heaters, and so on.

The 100-EMM will verify the condition of up to eight sensors for fire alarm or intruder systems. Sensor inputs are equipped with protection circuits that will withstand transient switching voltages. It's suitable for use in industrial-control applica-

tions. RFI (radio frequency interference) suppression circuits are included to eliminate false triggering from nearby radio sources.

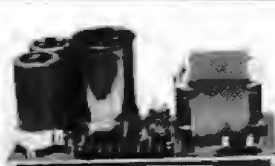
For further details on the 100-EMM module, con-

tact Fulcrum Computer Products Ltd., Fulcrum (Europe), Valley House, Purleigh, Essex CM3 6QH, England; tel: (0621) 828763; Telex: 995411. ■ Circle 643 on inquiry card.

## Where Do New Products Items Come From?

The information printed in the new products pages of BYTE is obtained from "new product" or "press release" copy sent by the promoters of new products. If in our judgment the information might be of interest to the personal computing experimenters and homebrewers who read BYTE, we print it in some form. We openly solicit releases and photos from manufacturers and suppliers to this marketplace. The information is printed more or less as a first-in first-out queue, subject to occasional priority modifications. While we would not knowingly print untrue or inaccurate data, or data from unreliable companies, our capacity to evaluate the products and companies appearing in the "What's New?" feature is necessarily limited. We therefore cannot be responsible for product quality or company performance.

## SUNNY LOW LOW COST POWER SUPPLIES (LINEAR & SWITCHING) FOR S-100, DISK DRIVES



### S-100 & DISK POWER SUPPLIES:

ITEM	IDEAL FOR	+5V OVP	-5V	+24V (OR +12V)	+8V	±16V	SIZE W x D x H	PRICE
S <sub>3</sub>	12 SLOT & 2 FLOPPY (1 Floppy & 1 Hard Disk)	5A	1A	5-7A PEAK	13A	3A	10" x 6" x 5"	102.95
S <sub>4</sub>	6 SLOT & 2 FLOPPY	4A	1A	4-5A PEAK	8A	3A	8 3/4" x 5" x 4 1/4"	92.95

### DISK POWER SUPPLIES: OPEN FRAME, ASSY. & TESTED, REGULATED, ADJUSTABLE & FUSES PROTECT.

ITEM	IDEAL FOR	+5V OVP	-5V	+24V (or +12V)	+8V Unreg.	±12V	SIZE W x D x H	PRICE
R <sub>0</sub>	2 x 8" SLIMLINE	2.5A		2.5A - 5A Peak			5" x 4" x 4"	49.95
R <sub>1</sub>	2 x 8" or 2 x 5 1/4" DISK	4A	1A	3A - 5A Peak	2A		8" x 4" x 3 3/4"	54.95
R <sub>2</sub>	3 x 8" (or 5 1/4") FLOPPY	6A	1A	6A - 8A Peak			10" x 4 3/4" x 3 3/4"	69.95
R <sub>3</sub>	or 1x Floppy & 1x Hard	6A	1A	6A - 8A Peak		1A	9" x 6 1/4" x 4 3/4"	81.95

AC & DC POWER CABLES WITH CONNECTOR FOR 2 DRIVES 6.00

### S-100 POWER SUPPLY KITS (OPEN FRAME WITH BASE PLATE, 3 HRS. ASSY. TIME)

ITEM	(IDEAL FOR)	+8V	-8V	+16V	-16V	+28V	SIZE: WxDxH	PRICE
KIT 1	15 CARDS	15A	---	2.5A	2.5A	---	12" x 5" x 4 3/4"	54.95
KIT 2	20 CARDS	25A	---	3A	3A	---	12" x 5" x 4 3/4"	61.95
KIT 3	DISK SYSTEM	15A	1A	3A	3A	5A	13 1/2" x 5" x 4 3/4"	69.95

### 6 SLOT MAINFRAME ASSY. & TESTED ONLY \$399.95 + SHIPPING \$18.00

EACH MAINFRAME (ITEM NO. 806 OR 516) CONTAINS: EMI FILTER • AC POWER CORD • POWER SWITCH & INDICATOR • RESET SWITCH • 4" COOLING FAN • S-100 BUS & SLOT CARD CAGE • (110/220 VAC, 50/60 HZ.) POWER SUPPLY FOR DISK DRIVES & S-100 SLOTS • 2 EA. DC POWER CABLES WITH CONNECTOR AND MOUNTING HARDWARE FOR DISK DRIVES • 9 EA. CUT-OUTS: 7 FOR DB25 CONNECTOR, 1 FOR 50 PIN CONNECTOR & 1 FOR CENTRONICS • CUSTOM FINISH & LOGO-LESS • COMPACT SIZE • LIGHTWEIGHT, 28 LBS.  
ITEM #806 FOR 2 EA. 8" THINLINE FLOPPY (TANDON TM848-1 & 848-2 OR EQUIV.), OR ONE HARD DISK, POWER SUPPLY • 8V/8A, ±16V/3A, ±5V/5A OVP, ±5V/1A & 24V/5A. SIZE: 12"(W) x 19.5"(D) x 9.8"(H).  
ITEM #516 FOR 2 EA. 5 1/4" FLOPPY (TANDON TM-100 - 1, 2, 3, 4 OR EQUIV.), OR ONE 5 1/4" FLOPPY & ONE 5 1/4" WINCHESTER HARD DISK (TANDON TM 600-2, 3 OR EQUIV.), POWER SUPPLY: ±8V/8A, ±16V/3A OVP, ±5V/5A OVP, ±12V/8A, 8A PEAK. SIZE: 13.75"(W) x 19.5"(D) x 7"(H).

SHIPPING FOR EA. PWR SUPPLY: \$5.50 IN CALIF., \$8.00 IN OTHER STATES; \$18.00 IN CANADA. FOR EA. TRANSFORMER: \$5.00 IN ALL STATES; \$12.00 IN CANADA. CALIF. RESIDENTS ADD 6.5% SALES TAX.

DEALER INQUIRIES INVITED



No. 806 & No. 516 Mainframes

MAILING ADDRESS:  
P.O. BOX 4296  
TORRANCE, CA 90510  
TELEX: 182558

SUNNY INTERNATIONAL  
(TRANSFORMERS MANUFACTURER)  
(213) 328-2425 MON-SAT 9-6

SHIPPING ADDRESS:  
22129 1/2 S. VERMONT AVE  
TORRANCE, CA 90502

# MICROMAIL<sup>®</sup>

## MONITORS

### AMDEK

Color I	\$340
Color II	\$650
Color III	\$390

### PRINCETON GRAPHICS SYSTEMS

Hi Res Color	\$590
--------------	-------

### NEC, DYNAX

ELECTROHOME ..... CALL

## PRINTERS

### C-ITOH

8X 110 (50 CPS) Matrix	\$240
410	\$460
1550 (15")	\$690
1110 (40 CPS) Letter Qual.	\$1390
1110 (55 CPS) Letter Qual.	\$1690

### EPSON (W/GRAFTRAX PLUS)

MX 80 FT	\$490
FX 80 FT	\$575
MX 100 FT	\$690
FX 100 FT	\$790

### OKIDATA

82A	\$440
#3A	\$690
84A	\$975
92A	\$575

### BROTHER HR-1

\$760

### SMITH CORONA

TP 1	\$560
------	-------

### STAR MICRONICS

Gemini 10	\$370
Gemini 15	\$540

### NEC

### SPINWRITER

7710-1	CALL	3510	CALL
7715-1		3515	
7720-1		3520...	
7725-1		3525..	
7730-1		3530.	

3550  
PC 8023A



### IBM PC IBM

PC System includes 64K IBM-PC with 320KB Floppy Disk Drive, Controller, Color Graphics Card, Monochrome Monitor. All for only ..... **\$2490**

LOTUS 1-2-3 Software ..... **CALL**

### HARD DISKS FOR APPLE AND IBM DAVONG

5 MB	\$1790
10 MB	\$1990
15 MB	\$2790

### MEMORY BOARDS

#### AST

Combo Plus, 4 function card, Fully pop. 256K... **\$590**  
Mega Plus, Fully pop 512K... **\$1080**

#### QUADRAM

Quad Card, Fully pop. 256K... **\$580**  
**Big Blue** ..... **\$470**  
**Hercules** graphics card ..... **\$490**

### TAVA CORP.



#### TRUMPCARD 1

256K Ram ..... **\$460**

#### TRUMPCARD 2

512K RAM ..... **\$650**

#### FDC

#### FOR IBM PC

W/Par. Port ..... **\$220**  
W/Ser. Port ..... **\$240**

#### DEC RAINBOW 100

Complete system 64K PC, Keyboard, Two Floppy Drives DS/DD, Monochrome Monitor ..... **\$2990**

#### APPLE IIe

64K System, W/Controller, Disk Drive, Monitor, 80 Column card, Stand **\$1790**

#### DISK DRIVE FOR APPLE

Slimline ..... **\$250**

#### KAPRO II COMPUTER

Complete System ..... **\$1690**

#### EPSON QX-10

64K Ram, Z-80 CPU, Monitor, Etc. **\$2200**  
11X 20 ..... **\$720**

# MICROMAIL

## (714) 838-9100

631 E. First St., Tustin, CA 92680

Prices subject to change without notice.

APPLE is a Trade Mark of Apple Computers, Inc.  
IBM is a Trade Mark of IBM Corp.



# Best Price • Good Quality • Swift Delivery • Export

Computer Channel

COMPUTER	
<b>*The Best Graphic Personal Computer*</b>	
LNW 801	Z80A, 65K, 480 = 187 1,050
<b>*Multitasker Business/Engineer*</b>	
CROMEMCO Best Price Anywhere	
CS1	5 1/2" floppy, Z80 3,198
CS1H	W/5 MB hard disk 8,598
CS102E	256K RAM, 68000 & Z80
CS1D2	no write controller 3,898
CS3D5E	512K RAM, 6800 & Z80
	two 5 1/2" floppy 4,388
	two 8" floppy 7,998
C10	84K, 12" monitor Z80A, keyboard 1,090
<b>*Professional/Word Process*</b>	
ZENITH NORTH STAR	Z80 80, 64K HORIZON, 1 quad drive, HD5 ADVANTAGE, 2 quad drives, 64K 3,999
CROMEMCO C10	64K, 12" monitor, 390K floppy CPM type O.S. + word processing + spreadsheet 1,850
<b>*18-bit CPU*</b>	
86000 EXPERT	
WICAT	1 to 12 users, 256KB to 4MB, 10MB to 474MB hard disk, graphic option 9,000 up
DUAL	fast, durable, industrial grade system, 86000, 512K RAM, 20MB hard disk, IBM floppy, UNX, S100 14,500
<b>SOFTWARE</b>	
dBASE II	Ashton Tate database 499
MICROSOFT BASIC 80	285
Micro Pro WORDSTAR	350
Digital Research CPM 2.2	139
Accounting Plus System Plus	399
Many other software	CALL

PRINTER	
<b>Integral Data System</b>	
MICROPRISM	75 cps excellent print/110 cps 64 x 64 graphic, RS232C/parallel 520
PRISM 80	200 cps, 80 col w/graphic 84 x 64 945
PRISM 132	200 cps, 132 col w/graphic 84 x 64 1,025
TI	810 SuperH graphic, color, friction 1,180
ORIDATA	MICROLINE 84 parallel 1,225
EPSON	FX 80 160cps 580
<b>*Laser Quality*</b>	
C.ITOH NEC	Starwriter F-10 40 cps 7710, 7730 3,250
	7720 KSR 3,695
	3510 1,500
	3530 1,650
QUAE DIABLO	11 1,400
	630 1,875
<b>TERMINAL</b>	
ZENITH	Z29 smart terminal 870
HAZELTINE	2T-1 w/modem telecom 530
	ESPRIT 6 585
	II 790
BECHIVE	DM5 II 895
IBM	3101 II 1,295
TELEVIDEO	870 1,119
VISUAL	60 825
	300 848
	650 graphic 2,385
WYSE	100 795
<b>MONITOR</b>	
ZENITH	12" green 114
AMDEK	COLOR IV 770 - 400 1,070
	COLOR II RGB 13" 899
	COLOR I 13" 340
	300 G 12" green 169
NEC	12" green 170
	1203 RGB 725
Electrohome	RGB 580 x 235 599
<b>MODEM</b>	
D.C. Hayes Smartmodem	300 baud 230
	300/1200 baud 570
Novation	CAT 300 baud 180
	Smart Cat 103/212 CALL

IBM PC	
AST	full line of memory card CALL
AMDEK	310 monitor 189
IDS	Microprism 480 520
EPSON	FX 80 160 cps CALL
NEC	3550 letter quality 1,348
C.ITOH	F-10 40 cps 1,345
ZENITH	RGB 640 x 480 w/cable 870
EASY WRITER II IUS	255
CP AIDS	Master Tax 1,195
LEGAL TIMEKEEPING STAR	775
Digital Research Peecol MT + 88	310
	Concurrent CPM 86 299
Peacenet	GL, AR AP 425
Structured Systems Accounting	700
<b>DIGITIZER/PLOTTER</b>	
HOUSTON INSTRUMENT DMP29, 40, 41 47	CALL
HP PAD DIGITIZER DT 11 11" x 11"	725
AMDEK	AMPLDT 11" x 14" 780
<b>DISK DRIVE</b>	
QUAE	QT142DS, 5 1/4" 500KB 230
<b>MITSUBISHI 8"</b>	
DS, DD	Quae & Shugart compatible
M2884-83	bare drive 410
8" subsystem	2 Mitsubishi bare drives, cabinet w/power supply fan assembled subsystem 1,099
manual	1,130
signal cable	75
	50
<b>CALL (212) 937-6363</b>	
free catalogue	
Prices subject to change. American Express, Visa, Mastercard add 3% F D B point of shipment. 20% re shipping fee for returned merchandise. Personal checks take 3 weeks to clear. COD in certified check only. NY residents add sales tax. Manufacturer's warranty only. International customers, please confirm price before order. Accept P.O. from Fortune 500 & schools.	
Computer Channel	TELEX: 42941B
21-55 44th Road	CSTNY
Long Island City, NY 11101	

# What's the Creator of the Walkman® Doing Now?

Getting ready for another smash hit, of course. Toshiaki Kamijo, creator of the Walkman®, has teamed up with the SORD Corporation, Japan's 2nd largest manufacturer of desktop computers, to develop an exciting new personal computer. So small it could rest on this magazine, light enough to tuck in your briefcase, and designed with an attention to quality that is unique, the M5 computer is a joy to own. Connect to a color TV or color monitor and enjoy instant BASIC, spreadsheet calculations (with optional FALC cartridge), or video games.

- M5 Computer** with BASIC-I Baseball and Zac Banic games, built-in RF modulator, all cables. 90 day warranty. Uses ordinary cassette recorder (not included). **\$159 postpaid.**
- FALC Cartridge.** Electronic spreadsheet for the whole family. Do business calculations, count calories, keep a data base of sports statistics, all with no programming. **\$40 postpaid.**
- BASIC-G Cartridge.** Advanced BASIC for the serious hobbyist. Extensive color graphics and music generation capabilities. **\$ 30 postpaid.**

Make checks payable to Colorado Chips. Colorado residents add sales tax. Dealer inquiries invited.

## Extra-Low IC Prices

<b>2716</b> . . . . . <b>\$3.40</b>	<b>2764</b> . . . . . <b>\$10.40</b>
SV 2K x 8 EPROM 450ns	8K x 8 EPROM 450ns
<b>2732</b> . . . . . <b>\$4.10</b>	<b>27128</b> . . . . . <b>\$38.25</b>
4K x 8 EPROM 450ns	18K x 8 EPROM 450ns

Colorado residents add tax. Add \$1 shipping per parts order. Send for catalog. Quantity prices available. Dealer inquiries invited.

# Colorado Chips

P.O. Box 111, Frisco, CO 80443

**PLEASE SEND ME:**

- \_\_\_ M5 computer systems.
- \_\_\_ FALC cartridges.
- \_\_\_ BASIC-G cartridges.

My check is enclosed.

- Please send more information.

Name \_\_\_\_\_

Address \_\_\_\_\_

City \_\_\_\_\_

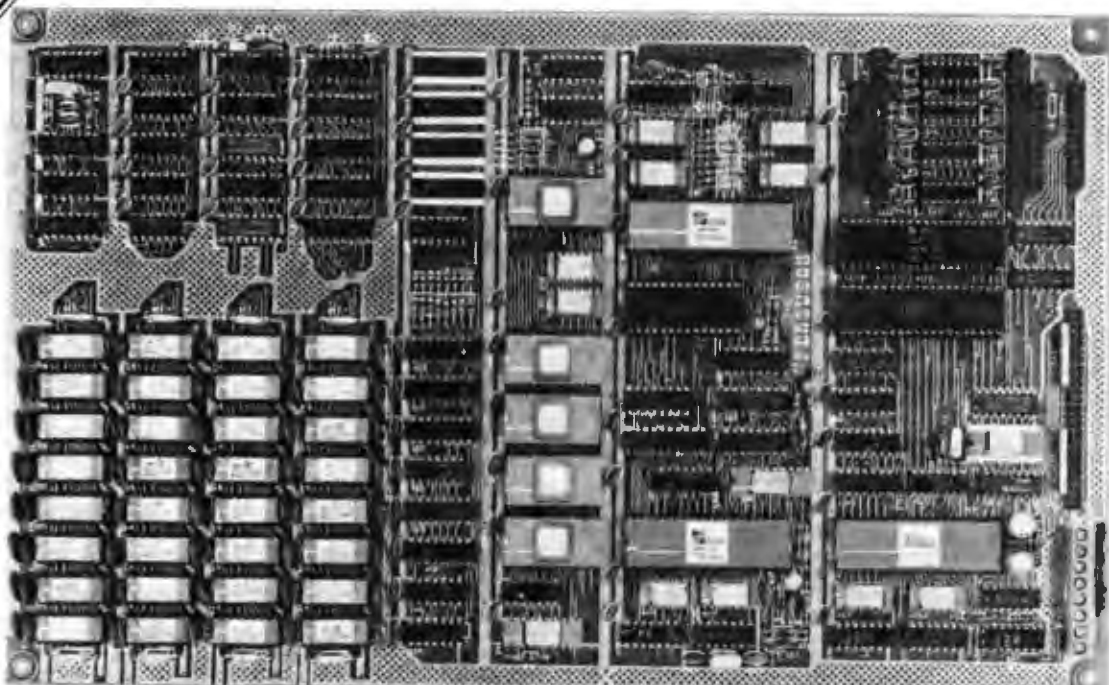
State \_\_\_\_\_ Zip \_\_\_\_\_

**"THE ORIGINAL BIG BOARD"**  
**OEM - INDUSTRIAL - BUSINESS - SCIENTIFIC**  
**SINGLE BOARD COMPUTER KIT!**  
**Z-80 CPU! 64K RAM!**  
 (DO NOT CONFUSE WITH ANY OF OUR FLATTERING IMITATORS!)

**NEW!**

**NEW LOWER PRICES**

**PARTIALLY ASSEMBLED KITS**  
 For All Sockets Installed  
 And Soldered Add \$50.  
 (Not For Blank PCB)



**WANT MORE INFO?**  
 Full Documentation and  
 Schematics — \$5.

**THE BIG BOARD PROJECT:** With thousands sold worldwide and over two years of field experience, the Big Board may just be one of the most reliable single board computers available today. This is the same design that was licensed by Xerox Corp. as the basis for their 820 computer.  
 The Big Board gives you the right mix of most needed computing features all on one board. The Big Board was designed from scratch to run the latest version of CP/M\*. Just imagine all the off-the-shelf software that can be run on the Big Board without any modifications needed.

**\$319<sup>00</sup>\*\*** (64K KIT BASIC I/O)

**SIZE:** 8 1/2 x 13 1/4 IN.  
**SAME AS AN 8 IN. DRIVE.**  
**REQUIRES: +5V @ 3 AMPS**  
 • -12V @ .5 AMPS.

**FULLY SOCKETED! FEATURES: (Remember, all this on one board!)**

**64K RAM**  
 Uses industry standard 4118 RAM's. All 64K is available to the user, our VIDEO and EPROM sections do not make holes in system RAM. Also, very special care was taken in the RAM array PC layout to eliminate potential noise and glitches.

**Z-80 CPU**  
 Running at 2.5 MHZ. Handles all 4116 RAM refresh and supports Mode 2 INTERRUPTS. Fully buffered and runs 8080 software.

**SERIAL I/O (OPTIONAL)**  
 Full 2 channels using the Z80 SIO and the SMC 8115 Baud Rate Generator. FULL RS232! For synchronous or asynchronous communication. In synchronous mode, the clocks can be transmitted or received by a modem. Both channels can be set up for either data-communication or data-terminals. Supports mode 2 Int. Price for all parts and connectors: \$39.95

**BASIC I/O**  
 Consists of separate parallel port (Z80 PIO) for use with an ASCII encoded keyboard for input. Output would be on the 80 x 24 Video Display.

**BLANK PC BOARD — \$119**  
 The blank Big Board PC Board comes complete with full documentation (including schematics), the character ROM, the PFM 3.3 MONITOR ROM, and a diskette with the source of our BIOS, BOOT, and PFM 3.3 MONITOR.

**24 x 80 CHARACTER VIDEO**  
 With a crisp, flicker-free display that looks extremely sharp even on small monitors. Hardware scroll and full cursor control. Composite video or split video and sync. Character set is supplied on a 2716 style ROM, making customized fonts easy. Sync pulses can be any desired length or polarity. Video may be inverted or true. 5 x 7 Matrix - Upper & Lower Case.

**FLOPPY DISC CONTROLLER**  
 Uses WD1771 controller chip with a TTL Data Separator for enhanced reliability. IBM 3740 compatible. Supports up to four 8 inch disc drives. Directly compatible with standard Shugart drives such as the SA800 or SA801. Drives can be configured for remote AC on-off. Runs CP/M\* 2.2.

**TWO PORT PARALLEL I/O (OPTIONAL)**  
 Uses Z-80 PIO. Full 16 bits, fully buffered, bi-directional. Uses selectable hand shake polarity. Set of all parts and connectors for parallel I/O: \$19.95

**REAL TIME CLOCK (OPTIONAL)**  
 Uses Z-80 CTC. Can be configured as a Counter or Real Time Clock. Set of all parts: \$9.95

**CP/M\* 2.2 FOR BIG BOARD**  
 The popular CP/M\* D.O.S. to run on Big Board is available for \$139.00.

**BIG BOARD SOFTWARE SPECIAL — \$149**  
 Through special arrangement with CDL we offer a powerful package of TDL Z-80 software that has a suggested retail of almost \$600. Includes: Extended Disk Business Basic, ZEDIT text editor, MACRO II Macro Assembler, LINKER, DEBUG I and DEBUG II. Supplied on 8 in. diskette with extensive manual.

**PFM 3.3 2K SYSTEM MONITOR**  
 The real power of the Big Board lies in its PFM 3.3 on board monitor. PFM commands include: Dump Memory, Boot CP/M\*, Copy, Examine, Fill Memory, Test Memory, Go To, Read and Write I/O Ports, Disc Read (Drive, Track, Sector), and Search PFM occupies one of the four 2716 EPROM locations provided. Z-80 is a Trademark of Zilog.

**Digital Research Computers**  
 (OF TEXAS)  
 P.O. BOX 401565 • GARLAND, TEXAS 75040 • (214) 271-3538

**TERMS:** Shipments will be made approximately 3 to 6 weeks after we receive your order. VISA, MC, cash accepted. We will accept COD's (for the Big Board only) with a \$75 deposit. Balance UPS COD. Add \$4.00 shipping.  
 USA AND CANADA ONLY

\*TRADEMARK OF DIGITAL RESEARCH. NOT ASSOCIATED WITH DIGITAL RESEARCH OF CALIFORNIA, THE ORIGINATORS OF CPM SOFTWARE  
 \*\*1 TO 4 PIECE DOMESTIC USA PRICE.



## COMMODORE VIC-20

**35K MEMORY MODULE 169.00**  
 • DYNAMIC RAM- TRANSPARENT REFRESH  
 • SELECTABLE 8K BLOCKS FOR  
 COMPATABILITY WITH ROM CARTRIDGES

Trade-ins accepted:  
 3K-\$5 8K-\$10 16K-\$20

## ATARI 400/800

**52K MEMORY EXPANSION 159.00**  
 Trade-ins accepted: 16K-\$15



512-441-3202

PO BOX 43006  
 AUSTIN, TX. 78745-0001

INCLUDE \$2.50 FOR SHIPPING ON PREPAID ORDERS. \$2.50 FOR C.O.D.

Circle 15 on inquiry card.



*Peripherals a Generation Ahead*  
**Voice Coil Actuated**  
**Dual 8" Floppy Disk Drive**

- FAST
- Apparent performance of a Hard Disc
- Equivalent of two standard drives

Model 299B (DS DD/SD)  
 Model 270/277 (SS DD/SD)

**PER SCI, INC.**



12624 Daphne Avenue  
 Hawthorne, CA 90250  
 (213) 777-4070  
 TELEX 687444

Circle 365 on Inquiry card.

Transmit **any** data between  
 almost two computers

Self instructing—Easy to modify

- Error correction • Progress indication
- Error count • Link quality measurement
- Non-locking • Auto receive

Microcomputers ..... \$150.00  
 5% discount for money order  
 or bank check.

10% discount if ordered by June 1, 1983

Documentation ..... \$10.00

Check or money order only.  
 Specify exact make and model of  
 computer and the diskette configuration

Mini and large machine users  
 write or call for prices.

**M,K,S** P.O. Box 09558  
 Columbus, Ohio 43209-0558  
 614-460-5251

Circle 273 on inquiry card.

*Business Systems Research & Development, Inc.*

P.O. Box 1253 / Tucker, Ga. 30085-1253 / 404-491-8864

**"dBase-Doc is now available"**

What is dBase-Doc? dBase-Doc is a completely  
 mechanized "system documentation facility" for  
 user-developed dBase-II application systems.  
 Here is a partial list of dBase-Doc capabilities:

1. **Logical Design Specifications** — interactive  
 data entry and reporting Process Descriptions,  
 and Data Dictionary object types.
2. **Data Dictionary** — interactive reporting of ob-  
 ject-type cross reference, summary, and direc-  
 tory reports
3. **Block Diagram Generator** — interactive entry of  
 diagram specifications, and either interac-  
 tive or "batch" block diagram reporting. May be  
 used to draw Hierarchical Analysis Diagrams,  
 data base Hierarchical Diagrams, and Data  
 Base Linkage Diagrams.
4. **Physical Design** — interactive entry of program  
 description and "statistics", and either batch or  
 interactive reporting of program folder docu-  
 mentation, and program-to-program cross ref.,  
 program-to-data-base cross ref., and other val-  
 uable cross-reference and "summary" reports
5. **Super-list** — use this print utility to list dBase-II,  
 assembler, PL/I, etc program source files.  
 Super-list allows you to "batch print one hun-  
 dred (or fewer) programs per execution.

dBASE-II is a registered trademark of Ashton-Tate,  
 Inc.

dBASE-DDC is a registered trademark of Business  
 Systems Research and Development.

Circle 78 on inquiry card.

## Bargain Boards™

Best prices around on



boards.



Include \$5.00 per board for shipping and handling.

6331 Fairmount Ave. #701  
 El Cerrito, Ca. 94530  
 (415) 524-8352

CompuPro is a registered trademark of General Electronics.

Circle 22 on Inquiry card.

## SAVE\$SAVE\$SAVE\$ LIMITED INTRODUCTORY OFFER NOT SOLD IN STORES

An Accounts Payable System for the small  
 business with an Apple II® Computer, at the  
 unbelievable low price of

**\$50**

Special Features Incl

- One time input of repetitive items
- Multiple General Ledger distributions per invoice, both debits &  
 credits
- Checking balance maintenance, allows manual and/or void  
 checks
- High speed machine language prog's & random access files
- Payroll & expense check pymts
- Cash requirements projection
- Optional remote work station input & processing at no extra cost

This program will be in stores in a few months at a much higher  
 price

**ACT NOW & SAVE!!**

We offer a 15 day money back trial period for you to review our  
 documentation & decide to keep or return the sealed disk & the  
 documents. Send check to

**ACCOUNTS PAYABLE RESEARCH & DEVELOPMENT CO**  
 8306 Wilshire Blvd., Suite 50  
 Beverly Hills, Ca. 90211

Include \$2.00 for Shipping & Handling  
 Ca. res. add sales tax for your county

The system requires an Apple II® 48K computer with Applesoft™ in  
 ROM, 1 disk drive (DOS 3.3) & a printer.  
 \*Trademarks or copyrighted programs of Apple Computer Co. Inc.

Circle 9 on inquiry card.

## \$\$ Printers \$\$

### EPSON

MX 80 .....	\$399
MX 80 FT III .....	489
MX 100 FT III .....	589
FX 80 .....	549

### STAR MICRONICS

Gemini 10 .....	329
Gemini 15 .....	509

### C. IOTH

8510 Prowriter Parallel .....	419
8510 Prowriter Serial .....	559
1550 Parallel .....	699
1550 Serial .....	749

Shipping and handling add 3%. CA residents add 6%.  
 "Other Printers Available"

### THE COMPUTER STORE

869 Sandcastle  
 CDM, CA 92625  
 714-862-1425

Circle 124 on inquiry card.

## WIREMASTER

Whip your wire wrap  
 and PC layout  
 problems with  
**WIREMASTER**



**WIREMASTER** is a software tool for design,  
 layout, and assembly of hardware. Your  
 schematic is fed to **WIREMASTER**, which  
 produces network maps, cross-references,  
 wire and parts lists, and debug checklists.  
**CHANGEMASTER** keeps track of fixes and  
 updates. **PLOTBOARD** and **PRINTBOARD**  
 give pictures of the layout. Post-processors  
 for wirewrap machines available. Runs on  
 CP/M, MSDOS, UNIX, and VMS. \$195.

AFTERTHOUGHT ENGINEERING 7286 Court-  
 ney Dr., San Diego, CA 92111, (619) 279-2888.

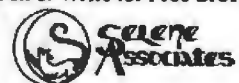
Circle 22 on Inquiry card.

## DEC RAINBOW MANAGER'S TOOLBOX™

Software for the "Electronic Desk"!

- ★ **REMIND** - Appointment calendar  
 and "tickler" file.
- ★ **PHONE** Telephone list manager
- ★ **CALC** Desk calculator
- ★ **MEMO** Simplified word processor  
 for writing memoranda

Package Price: **\$169**  
 Call or Write for Free Brochure



P.O. Box 19130  
 Minneapolis, MN 55419  
 (612) 825-5444

Circle 409 on inquiry card.

# NETRONICS NEW 16 BIT EXPLORER 88-PC ... \$399.95 IBM COMPATIBLE



**LEARN 16 BIT TECHNOLOGY IN EASY LOW-COST STEPS.** This 3-board system features (1) an 8088 mother board with a 5-slot expansion bus that will accept any hardware designed for the IBM personal computer and (2) a 64K (expandable to 256K) memory board that also features an IBM compatible RS 232 communications port. All circuits are functionally equivalent to the IBM except for the cassette ROMS. This means that all programs written in basic designed to run in an IBM can be compiled to run in this system and that any disk-operating system that will run on an IBM will work directly in the EXPLORER 88-PC. The system monitor ROM included in the Starter's system features a user-friendly operating system that allows easy program generation and debugging. The commands include display, modify memory, display modify registers, input/output data to I/O ports, block moves, single-step trace mode, go run with optional breakpoint and register reports, cassette load/save with file labels, plus a complete system test program that tests and reports condition of ROM, RAM, cassette interface, timer, DMA controller, interrupt controller, and the communications port. These test programs not only allow easy debugging of software but they serve as hardware and software learning tools.

The EXPLORER 88-PC STARTER'S KIT includes a mother board, memory I/O board, all components needed, sockets for ICs used, one 62-pin bus connector and complete assembly test instructions. All you need is a soldering iron, solder, a +5 volt @ 3 amps & -5 & +12 volt @ .5 amp power supply, and a standard RS 232 terminal (Netronics has 2 low-cost ones to choose from).

- Explorer 88-PC Starter's Kit...\$399.95 + 10.00 p&H (wired & tested, add 100.00).
- Extra 62-pin connectors @ 4.25 ea. + 1.00 p&H
- If you do not own a terminal you may want to consider using our IBM compatible keyboard (see photo) in conjunction with an IBM compatible color graphics board. This combination although not necessary at the introductory level may be desirable if you plan to expand the EXPLORER 88-PC to be fully IBM compatible. These items require additional power and are only available wired and tested as follows:
  - IBM compatible keyboard...\$279.95 + 10.00 p&H
  - IBM compatible color board...\$299.95 + 10.00 p&H
  - Additional ROM required...\$35.00



The EXPLORER 88-PC can be expanded at any pace you decide. Invest and learn at a pace that is comfortable for you. Netronics is dedicated to supplying the latest hardware and software to make this a meaningful learning experience. Hard disks, built-in modem board, optom burner, print buffer system plus more will be available shortly. The following items are available now:

- Deluxe heavy-duty steel cabinet that houses either two 5 1/4" floppies or a 5 1/4" hard disk with one floppy. This cabinet features a brush-finish front panel and a wood-grained sleeve that gives the unit a real professional look.
- EXPLORER 88-PC Cabinet...\$199.95 + 18.00 p&H
- A heavy-duty open frame power supply with fan that can be used in your own cabinet or installed into the Netronic cabinet is available as follows:
  - 10 amp power supply for system + 2 floppies...\$149.95 + 8.00 p&H
  - As above + extra power for 1 hard disk...\$169.95 + 8.00 p&H
  - IBM compatible disk controller board. Controls four 5 1/4" floppy drives (w/ 3 drive cable)
  - Available wired and tested only...\$250.00 + 8.00 p&H
  - The monitors and BIOS source listings are available on either disk or hard copy at \$35.00
- Please specify format and system required:
  - INTEL 8086 8088 user manual \$15.00 + 1.50 p&H
  - THE 8086 BOOK by RECTOR & ALEX...\$16.00 + 1.50 p&H
  - Special IBM compatible system: with keyboard, color graphics board, floppy disk control for 64K RAM cabinet, standard power supply and a single 5 1/4" floppy drive...\$1899.95 + 25.00 p & H

\*IBM PC is a registered trademark of IBM Corporation

## EXPLORER 88

Learn computing from the ground up. Start with the Explorer/88 Level 'A' kit which includes an expandable mother board. The kit includes the 8085 CPU, 2K Monitor program used to enter, test, run and save programs plus the parts to allow you to start programming. Just add a power supply and terminal or hex keyboard.  LEVEL 'A' Terminal version or  Hex Keyboard version 129.95 + 3.00 p&H. Add  Level 'B' 49.95 + 2.00 + two 100 pin connectors @ 4.25 ea. and have a powerful 5-100 computer. Add  Level 'C' 39.95 + 2.00 p&H = five 100 pin connectors to increase 5-100 slots to 6. Add memory using the JAWS 16-64K 5-100 board or add  Level 'D' 4K to main board 49.95 + 2.00 p&H.  Level 'E' 6.95 + 1.50 p&H adds device for 8K of 2716 eeproms. Need a power supply? Use the  5 amp AP-1 of 39.95 + 2.00 p&H. Select one of our low-cost terminals or use the  Hex keypad w/ display at 69.95 + 2.00 p&H.  Deluxe system cabinet 49.95 + 3.00 p&H.  Optional fan 16.00. New add  Microsoft BASIC & a powerful  Text editor/Assembler in ROMS, just 99.95 ea. Add  B\* floppy 499.95 + 12.00 p&H.  Floppy controller board 199.95 + 2.00 p&H.  Floppy cabinets & power supply 69.95 + 3.00 p&H.  Two drive cable 29.95 + 1.50 p&H. Hard disk also available (see insert.)



## ORDER A SPECIAL PRICE EXPLORER/88 PAK

- Beginner Pak (Save \$28.00)** - You get Level A (Terminal Version) with Monitor Source Listing (\$25 value) AP-1 5-amp power supply, Intel 8085 Users Manual... (Reg. \$199.95) SPECIAL \$169.95 plus \$4 p&H.
- Experimenter Pak (Save \$53.40)** - You get Level A (Hex Keypad/Display Version) with Hex Keypad/Display Intel 8085 User Manual, Level A Hex Monitor Source Listing and AP-1 5-amp. power supply. (Reg. \$279.95) SPECIAL \$219.95 plus \$6 p&H.
- Special Microsoft BASIC Pak (Save \$183.)** - You get Levels A (Terminal Version), B.O. (4K RAM), E. 8K Microsoft in ROM, Intel 8085 User Manual, Level A Monitor Source Listing and AP-1 5-amp. power supply. (Reg. \$439.70) SPECIAL \$329.95 plus \$7 p&H.  Add a Rom Version Test Editor/Assembler (Requires Levels B and D or 5100 Memory)...\$99.95 plus \$2 p&H.

**Starter B\* Disk System** - Includes Level A, B floppy disk controller, one CDC 8" disk-drive, two-drive cable, two 5100 connectors; just add your own power supplies, cabinets and hardware.  32K Starter System \$1045.95 plus \$13 p&H.  48K Starter System \$1095.95 plus \$13 p&H.  64K Starter System \$1145.95 plus \$13 p&H.

- Add to any of above Explorer steel cabinet, AP-1 live amp. power supply, Level C with two 5100 connectors, disk drive cabinet and power supply, two sub-D connectors for connecting your printer and terminal... (Reg. \$225.95) SPECIAL \$199.95 plus \$13 p&H.
- Complete 4K System. Wired & Tested... \$1650.00 plus \$26 p&H.

## 5-100 BOARDS

**JAWS MEMORY BOARD.** Features the INTEL 2822 for invisible refresh. Designed to be used with 8080, 8085 and 280 CPUs. Works in all well designed 5-100 computers, 10 day refund (or exchange wired unit for a kit) on wired units.

- 16K Kit 149.95\*  16K wired 179.95\*
- 32K Kit 199.95\*  32K wired 239.95\*
- 48K Kit 249.95\*  48K wired 289.95\*
- 64K Kit 299.95\*  64K wired 359.95\*

\*Add \$2.00 p&H to all above.

**4 DRIVE B\* FLOPPY CONTROLLER BOARD**  Single density (single or double sided) controller using the WD 1771. Includes two serial ports. Plugs into any 5-100 computer.

**8K 2716 EPROM BOARD.**  addressable on 8K page boundaries complete with sockets 69.95 + 2.00 p&H.

**5-100 ELECTRIC MOUTH.** Give your computer the power of speech. Uses National's DIGITALALKER with 143 words 99.95 + 2.00 p&H.  Second word set 39.95 + 1.00 p&H. Board accepts up to 4 word sets or your own custom word rom chips.

## UNIVERSAL SPEECH SYNTHESIZER



Use 90 preprogrammed words or generate your own words using phonemes. Perfect for any project that needs speech or for speech development system. Connects to any RS 232 serial or 8 bit parallel port or can be used in a stand alone mode.  Speak easy (board only) 159.95 + 3.00 p&H.  Cabinet and power transformer 29.00 + 2.00 p&H. **TRS 80 ELECTRIC MOUTH.** Plugs into the expansion slot on the TRS 80 models 1 or 3 (specify type)  with 143 word set 119.95 + 3.00 p&H. Includes separate power supply.  second word set 39.95 + 1.00 p&H, same specs as 8-100 model. **APPLE ELECTRIC MOUTH.** Same as above except this board plugs into any of the Apple expansion slots  with 143 word set 99.95 + 3.00 p&H.  second word set 39.95 + 1.00 p&H. Accepts 3 word sets or custom word ROMs.

## TERMINALS & VIDEO

**FASTERM 80** @ 199.95 + 3.00 p&H. Display format: 84 or 32 char/16 lines... 96 ASCII characters (w/1 case)... 8 baud rates, 150 to 19,200... line output: RS 232-C or 20 ma loop... video output: 1V P/P... cursor modes: home



& clear screen, erase to end of line, erase cursor line, cursor up and down, auto carriage return/line feed at end of line and auto scrolling... reverse video... blinking cursor... parity: off, even, or odd... stop bits: 1, 1.5, 2... data bits per character: 5, 6, 7 or 8... printer output, prints all incoming data... 1k on-board RAM... 2k on-board ROM... complete with power supply, cabinet & 56-key ASCII encoded keyboard.  Optional graphics mode: includes 34 Greek & math plus 30 special graphic characters. 19.95 prepaid.

**FASTERM VIDEO BOARD:** 99.95 + 3.00 p&H. **SMARTERM 80** @ 299.95 + 3.00 p&H. Display format: specify either 80 by 24 or 40 by 16... 320 ASCII characters (w/1 case)... 8 baud rates: 110 to 19,200... line output: RS232C or 20 ma current loop... video output: 1V P/P... coding features: insert/delete line, insert/delete character, forward/back tab... line or page trans... page print function... cursor positioning: up, down, right, left, plus absolute cursor positioning with read back... visual attributes: underline, blink, reverse video, half intensity & blank... graphics: 12,000 pixel resolution block plus line graphics... on-screen parity indicator... parity: off, even or odd... stop bits: 110 baud 2, all others 1... printer output... 60 or 50 Hz vertical re-

fresh... blinking block cursor... 2k on-board RAM... ASCII encoded keyboard: 56 keys, 120 characters... 4k on-board ROM... complete with power supply & cabinet.  **SMARTERM VIDEO BOARD:** 199.95 + 3.00 p&H.  **ZENITH VIDEO MONITOR** (green phosphor): 149.95 + 5.00 p&H.  **RF MODULATOR** (KX only): 8.95 + 1.00 p&H.  3-h. cable with DB 25 connectors 14.95 + 2.00 p&H.

## HARD DISK

Add up to four 5 or 12 megabyte hard disks to your 5-100 system. Automatically installs itself to any standard CPM 2.2 BIOS.  6 megabytes 2495.00 + 15.00 p&H.  12 megabytes 2995.00 + 15.00 p&H.  Disk to test your system compatibility 5.00.

## SOFTWARE

We are distributors for all Systems Plus & Micro pro software. Call for prices.  CPM 2.2 150.00  Microsoft Disk base 325.00.  Special Business Pac: includes CPM, BASIC, QL, AR, AP & Payroll 699.95 (saves 625.00).

## CLIP AND MAIL ENTIRE AD

\*p&H stands for postage & insurance. For Canadian orders double this amount. CP M is a reg. trademark of Digital Research.

**TO ORDER Call Toll Free**

**800-243-7428**

To order from Connecticut or for technical assistance call (203) 334-0375. Conn. residents add sales tax.

VISA  MASTERCARD (Bank No. \_\_\_\_\_)

Acct. No. \_\_\_\_\_

Exp. Date \_\_\_\_\_

**SEND ME THE ITEMS CHECKED IN AD**

Signature \_\_\_\_\_

Print Name \_\_\_\_\_

Address \_\_\_\_\_

City \_\_\_\_\_

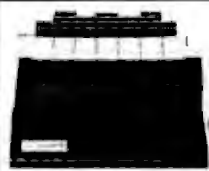
State \_\_\_\_\_

Zip \_\_\_\_\_



**NETRONICS R & D LTD.**  
333 Litchfield Road,  
New Milford, CT 06776





**GEMINI  
10 Printer  
\$299**

Gemini — 15 Printer . . . . . \$459  
 Brother HR-15 Daisy Wheel . . . CALL  
 Transtar 130 Daisy Wheel . . . . . CALL  
 Transtar 350 Color Printer . . . . . CALL  
 Epson FX 80 Printer . . . . . CALL  
 Super 5-A40 Half-height  
 Apple Compatible Drive . . . . . 285  
 Tandon 100-2 Add-on Drive . . . . . 275  
 Corona PCs . . . . . CALL

**CALL FOR BEST PRICES**

**MICRO MARKETING**

4688 Convoy Street, Suite 109  
 San Diego, CA 92111 Tel. (619) 565-0158

Circle 115 on Inquiry card.

**RGB COLOR BOARD NEW for APPLE IIe**

A new video board that provides the Apple IIe with RGB (red/green/blue) video signals for crisp, vivid display of color graphics and text, with exceptional resolution and color quality, is now available.

• Can be used with 80 column text so color graphics and text are displayed on one RGB monitor.

• Each text line can be set any one of 8 colors on any of 8 colors of background.

• Sync signals are  $\pm$  TTL composite or  $\pm$  TTL separate H & V, for universal RGB monitor compatibility.

• Plugs into slot 7 and comes with 5' of ribbon cable for signal output. Optional cable connector and longer length cable available.

**MODEL VCB-2e \$169.00**

Also available:  
**Model VCB-A2, RGB board for Apple II \$139.00**

**VTM-80, 80 Col. Bd. Apple II \$178.00**

**VSS-80 RGB soft switch for Apple II \$ 30.00**

For IBM PC: 8 foot, 16 color RGB interface cable assembly for SONY Profeel Monitors. \$ 99.00

**TELEMAX, INC.**

P.O. Box 339 Warrington, PA 18976  
 (215) 343-3000

Circle 444 on inquiry card.

**TRS-80 MODEL 16 AND  
68000 SYSTEMS  
RELATIONAL  
DATABASE  
MANAGEMENT SYSTEM  
(DBMS)**

**INFORMATION MANAGEMENT  
FOR BUSINESS SYSTEMS**

- Unique Features
- Easy to use Powerful
- Menu Driven
- English Subset Query Language
- 68000 Code Efficiency

**INTRODUCTORY PRICE \$595**

Send For Catalog.

**DATA MANAGEMENT SYSTEMS**

211 N. EL CAMINO REAL, 101C  
 ENCINITAS, CA 92024  
 or Phone: (619) 942-0744

IBM DB is a trademark of Tandy Corp

Circle 150 on Inquiry card.

**I WILL BEAT ANY COMPETITOR'S PRICE  
PROVIDED IT IS NOT BELOW MY COST  
TRY TO BEAT THESE IC PRICES:**

DYNAMIC RAM		
64K	200 ns	\$4.79
64K	150 ns	4.99
64K	120 ns	5.80
16K	200 ns	1.25
EPROM		
2764	250 ns	\$7.80
2732	450 ns	4.15
2716	450 ns	3.25
2532	450 ns	4.70
STATIC RAM		
8116F-J	150 ns	\$4.24
2016	100 ns	4.00
2114	200 ns	1.60
Z80A FAMILY		
CPU, CTC, or PID		\$3.39
DART		8.25
DMA or SIO-0		12.50

MasterCard VISA or UPS CASH COD  
 Factory New, Prime Parts

**MICROPROCESSORS UNLIMITED**

24 000 South Peoria Ave  
 BEGGS DR 74421  
 (918) 287-4961

Pages 211-2

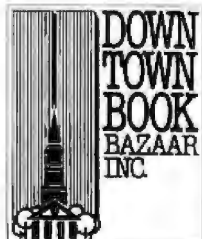
Prices subject to change. Call for volume pricing. Subject to availability quantities. Shipping & insurance extra. Cash required. (cash, check)

Circle 309 on Inquiry card.

**Save \$ on  
Computer Books!**

We offer a 10% discount on computer books from several publishers.

Fast, reliable service and low shipping charges for mail orders. Write for FREE catalog.



**DOWNTOWN  
BOOK BAZAAR,  
Dept. B  
P.O. Box 2490  
Brooklyn, N.Y.  
11202**

Circle 176 on Inquiry card.

**ScreenGen  
FULL SCREEN CONTROL**

An assembler subprogram you call from your programs to handle screen input/output as IBM mainframes do.

Define full screen format specifications outside your program, and call ScreenGen to retrieve the formats, and do all the I/O for you

- One command input/displays a full screen
- Use all of your CRT video attributes
- Define up to 24 function keys
- Define templates for display and input
- Validate input while keying Insert and delete characters to correct fields
- Tab fields forward and backward
- Draw figures using vertical field displays
- Save memory as only one format needs to be in memory at one time. Make the constants to display virtual, and they don't use any memory at all
- Build help screens. Call them with one function key then return to where you were

Available now for most popular —

BASIC	IBM PC and CP/M	\$99
COBOL	Apple II CP/M	\$75
FORTRAN	Shipping	\$ 4
PASCAL	Source code included	

Dealer inquiries welcome

**INTERDATA SYSTEMS INC.**

1051 Clinton Street, Buffalo, N.Y. 14206 Visa, M/C  
 (416) 493-8675 (call collect to order) Am. Express

Circle 238 on Inquiry card.

**IBM ← digital →**  
**PC-LINK  
DEC VT100<sup>®</sup> TERMINAL  
EMULATOR**

- A full featured DEC VT100<sup>®</sup> terminal emulator on IBM PC.
- Transfer text files between host and PC
- Very easy to learn! All DEC software can be accessed from IBM PC. You can use the standard DEC editor edit on PC without learning the intricacies of escape sequence.
- To use PC-Link program, the PC needs to have at least one disk drive, IBM DOS, IBM monochrome display, a RS232 port and telephone modem.
- \$40.00

Add \$5.00 for shipping

**SCREENWARE CORPORATION**  
 P.O. BOX 3662  
 NASHUA, NH 03061-3662  
 Tel. 603-888-4074



Circle 406 on Inquiry card.

**Let your  
Apple do the  
designing.**

**INTRODUCING THE ONLY ADVANCED  
DESIGN SOFTWARE FOR SMALL  
BUSINESSES & ENGINEERING STUDENTS**

A-BAR LINKAGE PROGRAMS INCLUDE (APPLE II PLUS (OR DOS 3.3))

**□3-Point Path/Motion Generation**  
 Designs linkages, plots and traces linkages. Allows operator to do complex designing without doing complex equations.

DESK and MANUAL ..... \$70  
 MANUAL ONLY ..... \$10

**□3-Point Motion Generation**

Same as above program without the path generation

DESK and MANUAL ..... \$60  
 MANUAL ONLY ..... \$10

**□Linkage Rotation**

Given the pivot location, this program can verify that the linkage will go thru 3, 4 or 5 path points

DESK and INSTRUCTIONS ..... \$25

Send check or money order to:

**RESEARCH & ENGINEERING  
INC. PO BOX 11407  
MILWAUKEE, WI 53211 (414) 964-3662**

Circle 328 on inquiry card.

**Maxell Floppy Disks**

**The Mini-Disks  
with maximum quality.**



Dealer inquiries invited. C.O.D.'s accepted. Call FREE (800) 235-4137



**PACIFIC EXCHANGES**  
 100 Foothill Blvd. San Luis  
 San Luis Obispo, CA 93401  
 In Cal. call (805) 592-5935 or  
 (805) 543-1037

Circle 347 on Inquiry card.

# True MAIL ORDER Prices

With so many so-called Mail Order establishments using "toll free" lines, and gaudy advertising, how can you, the customer, expect to receive true mail order savings? We have done away with large ads, and free phone lines to offer comparable service passing on the savings to you. Our reputation for low prices and satisfaction is outstanding.

DISKETTES	
<b>*Kangaroo: (w/library case)</b>	
SS/DD .....	\$19.35
DS/DD .....	\$28.00
— 10 yr. Warranty —	
<b>Elephant:</b>	
SS/DD .....	\$21.95
DS/DD .....	\$28.95
<b>Verbatim:</b>	
5 1/4" SS/DD .....	\$22.95
5 1/4" DS/DD .....	\$38.95
8" SS/DD .....	\$38.95
8" DS/DD .....	\$43.95
— Available soft/hard sector —	
Library Case 5 1/4" .....	\$1.75

MODEMS	
<b>Hayes:</b>	
MicroModem II	
with Terminal Program .....	\$285.00
without Terminal Program ..	\$255.00
<b>Hayes Smartmodem:</b>	
300 Baud .....	\$199.00
1200 Baud .....	\$505.00
<b>Novation:</b>	
J-Cat .....	\$104.00
Applecat II .....	\$285.00
Smartcat 1200 Baud .....	\$440.00
Hayes Chronograph .....	\$179.00

COMPUTER PRODUCTS FOR IBM	
<b>The Ultimate Peripheral MONTE CARLO™ CARD</b>	
64K .....	\$390.00
128K .....	\$450.00
192K .....	\$510.00
256K .....	\$570.00
<b>T &amp; G Products:</b>	
Joysticks .....	\$49.00
Trakball .....	\$49.00
<b>BUSINESS</b>	
<b>Visicorp:</b>	
Visidex .....	\$180.00
Visifiles .....	\$180.00
256K Visicalc .....	\$180.00
Visitrend/Plot .....	\$225.00
<b>ENTERTAINMENT:</b>	
<b>Infocom:</b>	
Zork I .....	\$27.00
Zork II .....	\$27.00
Zork III .....	\$27.00

PRINTERS	
<b>Okidata:</b>	
Microline 92 .....	\$565.00
Microline 93 .....	\$985.00
<b>Pacemark 2350</b>	
Parallel .....	\$2100.00
Serial .....	\$2200.00
<b>Pacemark 2410</b>	
Parallel .....	\$2400.00
Serial .....	\$2500.00
Call for prices on the entire line of Okidata Printers.	
Call for the New Epson FX Printers.	

TEC/C.ITOH	
Prowriter 1 Parallel .....	\$369.00
Prowriter 1 Parallel/Serial .....	\$489.00
Prowriter 2 Parallel .....	\$639.00
Prowriter 2 Parallel/Serial .....	\$689.00
F-10 Starwriter Parallel or Serial .....	\$1185.00
F-10 Printmaster Parallel or Serial .....	\$CALL
Brother HRI: .....	\$795.00
Smith Corona TPI: .....	\$559.00
<b>Star:</b>	
*Gemini 10 & 15 .. Call for low prices!	

TANDON DISK DRIVE SPECIAL	
TM-100-2 DS/DD 320K Bytes .....	\$245.00
TM-55 320K Bytes Half Height .....	\$239.00

<b>QuadRam Quadboard</b>	
64K .....	\$390.00
128K .....	\$450.00
192K .....	\$510.00
256K .....	\$570.00
<b>Kraft Products:</b>	
Joysticks .....	\$55.00
Game Paddle .....	\$29.00
<b>Davong Hard Disks</b>	
5 Megabyte .....	\$1450.00
10 Megabyte .....	\$1850.00
15 Megabyte .....	\$2250.00
<b>Maynard Electronics</b>	
Floppy Controllers w/Parallel ..	\$209.00
Floppy Controllers w/Serial ...	\$239.00

MONITORS	
<b>Amdek:</b>	
Color I .....	\$295.00
Color II .....	\$695.00
300G Green .....	\$155.00
300A Amber .....	\$155.00
310G Green .....	\$175.00
310A Amber .....	\$175.00
Zenith: 12" Green .....	\$ 99.00
USI: Amber .....	\$159.00
*Taxan: Amber .....	\$139.00
PGS: RGB Monitor .....	\$CALL
BMC: Green 12" .....	\$ 80.00

DISK DRIVES	
<b>Apple:</b>	
<b>Fourth Dimension:</b>	
w/o controller .....	\$250.00
w/ controller .....	\$319.00
<b>Rana Elite I:</b>	
w/o controller .....	\$270.00
w/ controller .....	\$339.00
<b>IBM:</b>	
*Tandon TM-55	
The New Thin-Line .....	\$235.00

COMPUTER PRODUCTS FOR APPLE	
<b>MBI:</b>	
VIP Graphics Card .....	\$119.00
Appletime ClockCard .....	\$ 85.00
<b>Silicon Valley Systems:</b>	
Final Analysis .....	\$149.00
Word Handler .....	\$115.00
<b>Continental:</b>	
Home Acct. ....	\$ 49.00
<b>On-Line:</b>	
Screenwriter II Pro .....	\$139.00
<b>Visicorp:</b>	
Visidex .....	\$180.00
Visifiles .....	\$180.00
Visicalc .....	\$180.00
Visitrend/Plot .....	\$225.00
<b>Denver Software:</b>	
Financial Partner .....	\$139.00
Pascal Tutor .....	\$ 82.00
Pascal Programmer .....	\$189.00
<b>Stoneware:</b>	
DB Master .....	\$149.00
DB Utility Pak .....	\$ 65.00
<b>T &amp; G Products:</b>	
Joysticks .....	\$42.00
Select-a-Port .....	\$42.00
Game Paddles .....	\$28.00
<b>Davong Hard Disks</b>	
5 Megabytes .....	\$1450.00
10 Megabytes .....	\$1850.00
15 Megabytes .....	\$2250.00
<b>Ram Cards</b>	
Microsoft 16K .....	\$75.00
Generic 16K .....	\$80.00
CP/M Microsoft Z80 Card .....	\$259.00
80 Column Cards Videx w/soft ..	\$269.00

Send orders and inquiries to:

## Computer Apparatus™

P. O. Box 32063 • Aurora, Colorado 80041

Telephone Inquiries: (303) 759-9251

Monday thru Friday — 9:00 a.m. to 5:00 p.m. (Mountain Standard Time)

**We built our reputation on low prices for the informed computer user.**

DELIVERIES: 2 - 4 weeks average.  
 PERSONAL CHECKS: Cashier's check and money order will receive shipping preference.  
 VISA & MASTERCARD: Add 4% to total.  
 CATALOG: Send for full pricing details.  
 Prices subject to change without notice  
 SHIPPING: UPS add \$2.00 plus 2% of order total.



## Floppy Disks





**BEST PRICES IN THE U.S.**

Dealer Inquiries Invited • C.O.D. Accepted  
**TOLL FREE 800-652-8168**  
**CALIF. 213-706-1626**




**U.S. EXCHANGE**

**5015 Kanan Road  
 Agoura Hills, CA  
 91301**

Circle 489 on Inquiry card.

## C LANGUAGE PROGRAMMERS

**c-systems  
 C COMPILER  
 c-window™**

The first c language source level program testing and debugging tool

- Single step by c source line.
- Set breakpoints at line numbers.
- Display and alter variables by symbol name, using c expression syntax.
- No more printf or assembler level debugging!

**c-window™** is a support package for the **c-systems C COMPILER** for 8086/8088 based systems

Contact: **c-systems** Fullerton, CA 92634  
 P.O. Box 3253 714-637-5362

TM c-systems

Circle 83 on Inquiry card.

## SAVE UP TO 50% ON Floppy Disks & Computer Supplies

We Discount the Top Brands

**3M-Scotch® • Verbatim®  
 Memorex • BASF • Maxell®**

We also stock  
**Ribbons • Paper • Labels  
 Cleaning Kits • Printwheels  
 Storage Products**

Call, write, or utilize Reader Service for our FREE new DISCOUNT catalog

**LYBEN COMPUTER SYSTEMS**  
 27204 Harper  
 St. Clair Shores, MI 48081  
 (313) 777-7780

Offering Reliability and Same Day Service.

Circle 267 on Inquiry card.

## S-100 COLOR GRAPHICS \$199

256H-192V • **IMAGER-I** • 16 COLORS

A P P L E  
 N E A T  
 S E R I O U S

• USES TMS 9918A (IBM TEXAS INSTRUMENTS)  
 • 32 PREHINTED PLANES FOR 3D SHADATION  
 • 3 GRAPHIC MODES  
 • TEXT MODE  
 • 32 SQUARE/RECTANGULAR FAST MOVING SPRITES  
 • SPRITE COINCIDENCE DETECTION  
 • ON BOARD JOYSTICK & PUSHBUTTON LOGIC  
 • COMPATIBLE VIDEO OUTPUT (NTSC)  
 • ON BOARD RF MOD CONVERSION INSTRUCTIONS  
 • MEETS IEEE 696 SPECIFICATIONS  
 • HIGH QUALITY PC CONSTRUCTION  
 • SAMPLE PROGRAMS INCLUDED IN MANUAL

G A M E S

NEAR FINAL COPY - \$0  
 DEALER INQUIRY SERVICE - CHECK OR MONEY ORDER OR C.O.D.  
 MASSACHUSETTS RESIDENTS PLEASE ADD 9% SALES TAX

CALL (800) 343-1292  
 MASS (800) 322-0453




**TechniGraphic Designs**  
 P.O. BOX 239-DRAFTON, MASSACHUSETTS 01919

Circle 442 on Inquiry card.

## SMITH-CORONA TP-1

Letter Quality Daisy Wheel Printer



- SERIAL OR PARALLEL INTERFACE
- MICROPROCESSOR ELECTRONICS

**ORDER TOLL FREE \$549**

FREE SHIPPING

(800) 531-5475 (if outside of Texas)  
 (512) 250-1523 (in Texas)  
**CompuAdd Corp.**  
 13010 RESEARCH BLVD #101  
 AUSTIN, TEXAS 78750

Circle 108 on inquiry card.

## Hoffman DISKETTES

	Box of 10	
<b>5 1/4"</b>	Sgl Side/Sgl Density	\$17.50
	Sgl Side/DbI Density	20.00
	DbI Side/DbI Density	24.00
<b>8"</b>	Sgl Side/Sgl Density	20.00
	Sgl Side/DbI Density	25.50
	DbI Side/DbI Density	30.00

Certified 100% error free  
 Hub rings on 5 1/4" diskettes  
 Specify soft, 10 or 16 sector on 5 1/4" diskettes  
 Shipping/Handling \$1.50 per box  
 California residents add appropriate tax

**ORDER NOW!**  
 Check/Money Order/VISA/MasterCard/C.O.D.

 **Hoffman COMPUTER PRODUCTS**  
 1720 FLOWER AVE. DEPT 8814 • DUARTE, CA 91916  
 (714) 303-1671

Circle 217 on inquiry card.

## Computer Sale

Franklin ACE 1000 w/Color .....	\$ 965
1000 System w/Monitor .....	1375
ACE 1200 w/Color .....	1890
Drives for Apple and Franklin	
Quantin 5 .....	249
Thin Line .....	279
Franklin Color Kit .....	38.95
<small>Shipping and handling add 3% CA residents add 9%</small>	

**THE COMPUTER STORE**  
 869 Sandcastle  
 CDM, CA 92625  
 714-862-1425

Circle 125 on Inquiry card.

## IBM® DISKETTES

<b>5 1/4" Diskette 1D</b> Single Side Double Density <del>\$29.00</del>	<b>5 1/4" Diskette 2D</b> Double Side Double Density <del>\$39.00</del>
Soft* Box of 10	Soft* Box of 10

\* Add \$1.75 for Plastic Library Case  
 8" and other brands also available.

 **COD ACCEPTED**  
**DEALER INQUIRIES INVITED**



**CALL TOLL FREE 800-848-1101**  
 In N.Y.S. (716) 631-3925  
**BETSY BYTES Division**  
 BB International, Inc.  
 P.O. Box 584  
 Buffalo, N.Y. 14221

**TERMS:** Prepaid orders receive free shipping within continental U.S.A. Add 3% (\$2.00 minimum) shipping and handling charge on all COD and credit card orders. N.Y. res. add 7% tax.

Circle 63 on inquiry card.

## 5 1/4" Tandon Drives

<ul style="list-style-type: none"> <li>• <b>TM 100-1</b> (single sided, 40 TRK, single or double density) <b>\$189</b> Free Shipping</li> <li>• <b>TM 100-2</b> (double sided, 40 TRK/side single or double density) <b>\$259</b> Free Shipping</li> <li>• <b>TM 100-4</b> (double sided, 80 TRK/side 96 TPL, double density) <b>\$349</b> Free Shipping</li> </ul>	
---	--

**ORDER — TOLL FREE**

**1-800-531-5475 (if outside of Texas)**  
**(512) 250-1523 (if inside of Texas)**

\*If we can't ship the next working day, we won't take the order.\*

Master Card/Visa or check  
 Texas Residents add 5% sales tax.

**CompuAdd Corp.**  
 13010 Research Blvd - #101  
 Austin, Texas 78750

Circle 109 on Inquiry card.

**PRICE BREAKTHROUGH!  
A HIGH QUALITY PRINTER FOR ONLY**

**\$399.**



## THE NEW D-92 DUAL MODE MODULAR PRINTER

### WE DARE YOU TO COMPARE!

But don't just look at the price, consider the features, reliability and flexibility of the D-92 dual mode modular printer.

#### FEATURES

- 7x9 Font For Data Processing printing
- 11x9 Font For Crisp Clear Business Letters
- 100 CPS Bidirectional Printing
- Short Line Seeking Logic
- 800 Character Buffer
- Six Different Character Sizes
- 100% Duty Cycle
- Parallel Interface

### RELIABILITY

All *Data Impact Products* printers are built with superior materials right here in the United States. Each unit is inspected, tested and burned in at the factory to insure superior quality.

- Other measures of reliability
- 100 Million Character User-Replaceable Printhead
  - 5 Million Character Ribbon Cartridge
  - Easy Access and Serviceable Single Circuit Board
  - Full Factory Warranty

### FLEXIBILITY

The D-92 was built with your future in mind. The highly modular design provides several upgradeable options such as:

- Adjustable Tractor Feed
- Dot Addressable Graphics
- 2K Buffer
- X-ON/X-OFF
- RS232 Serial Interface
- 9600 Baud
- Single Sheet Feeder
- Sound Cover

Naturally, *Data Impact Products* printers will interface with all popular computers whether it is IBM, Osborne, TRS, Apple, Atari, etc.

Act now to take advantage of our special promotional discount for options

For more information call

**1-800-327-1525**



**DATA IMPACT PRODUCTS, INC.**

745 ATLANTIC AVE., BOSTON, MA 02110 TEL: 617-482-4214

TELEX: 951047 DIP INC BSN Circle 164 on Inquiry card.





# wabash<sup>®</sup> diskettes

for  
as  
low  
as

## \$1.39 each!

### Now...Get High Quality at a Low Price

Wabash means quality products that you can depend on. For over 16 years, Wabash has been making high quality computer products. Wabash diskettes are made to provide error-free performance on your computer system. Every Wabash diskette is individually tested and is 100% certified to insure premium performance.

### Why Wabash is Special

The quality of Wabash diskettes is stressed throughout the entire manufacturing process. After coating, all Wabash diskettes go through a unique burnishing process that gives each diskette a mirror-smooth appearance. Wabash then carefully applies a lubricant that is specially formulated to increase diskette life. This saves you money, since your discs may last longer. It also assists your disk drives in maintaining constant speed which can reduce read and write errors.

### Special Seal...Helps Prevent Contamination

To keep out foreign particles, a unique heat seal bonds the jacket and liner together. A special thermal seal which avoids contamination from adhesives, is then used to fold and seal the jacket. This results in outstanding performance and true reliability. Wabash then packages each diskette, (except bulk pack) in a super strong and tear resistant Tyvek<sup>®</sup> envelope. The final Wabash product is then shrink-wrapped to insure cleanliness and reduce contamination during shipment.

### Each Diskette is 100% Critically Tested

Since each step in the Wabash diskette manufacturing process is subject to strict quality control procedures, you can be sure Wabash diskettes will perform for you. And every Wabash diskette meets the ultra-high standards of ANSI, ECMA, IBM and ISO in addition to the many critical quality control tests performed by Wabash. Wabash does all of this testing to provide you with consistently high quality diskettes. Reliability and data integrity - that's what Wabash quality is all about.

### Flexible Disc Quantity Discounts Available

Wabash diskettes are packed 10 discs to a carton and 10 cartons to a case. The economy bulk pack is packaged 100 discs to a case without envelopes or labels. Please order only in increments of 100 units for quantity 100 pricing. With the exception of bulk pack, we are also willing to accommodate your smaller orders. Quantities less than 100 units are available in increments of 10 units at a 10% surcharge. **Quantity discounts** are also available. Order 500 or more discs at the same time and deduct 1%; 1,000 or more saves you 2%; 2,000 or more saves you 3%; 5,000 or more saves you 4%; 10,000 or more saves you 5%; 25,000 or more saves you 6%; 50,000 or more saves you 7% and 100,000 or more discs earns you an 8% discount off our super low quantity 100 price. Almost all Wabash diskettes are immediately available from CE. Our warehouse facilities are equipped to help us get you the quality product you need, when you need it. If you need further assistance to find the flexible disc that's right for you, call the Wabash diskette compatibility hotline. Dial toll-free 800-323-9868 and ask for your compatibility representative. In Illinois or outside the United States dial 312-593-6363 between 9 AM to 4 PM Central Time.

Circle 104 on Inquiry card.

### SAVE ON WABASH DISKETTES

Product Description	Part #	CE quant. 100 price per disc (\$)
8" SSSD IBM Compatible (128 B/S, 26 Sectors)	F111	1.99
8" Same as above, but bulk pack w/o envelope	F111B	1.79
8" SSSD Shugart Compatible, 32 Hard Sector	F31A	1.89
8" SSDD IBM Compatible (128 B/S, 26 Sectors)	F131	2.49
8" DSDD Soft Sector (Unformatted)	F14A	3.19
8" DSDD Soft Sector (256 B/S, 26 Sectors)	F144	3.19
8" DSDD Soft Sector (512 B/S, 15 Sectors)	F145	3.19
8" DSDD Soft Sector (1024 B/S, 8 Sectors)	F147	3.19
5 1/4" SSSD Soft Sector w/Hub Ring	M11A	1.59
5 1/4" Same as above, but bulk pack w/o envelope	M11AB	1.39
5 1/4" SSSD 10 Hard Sector w/Hub Ring	M41A	1.59
5 1/4" SSSD 16 Hard Sector w/Hub Ring	M51A	1.59
5 1/4" SSDD Lanier No-problem compatible	M51F	2.99
5 1/4" SSDD Soft Sector w/Hub Ring	M13A	1.89
5 1/4" Same as above, but bulk pack w/o envelope	M13AB	1.69
5 1/4" SSDD Soft Sector Flippy Disk (use both sides)	M18A	2.79
5 1/4" SSDD 10 Hard Sector w/Hub Ring	M43A	1.89
5 1/4" SSDD 16 Hard Sector w/Hub Ring	M53A	1.89
5 1/4" DSDD Soft Sector w/Hub Ring	M14A	2.79
5 1/4" DSDD 10 Hard Sector w/Hub Ring	M44A	2.79
5 1/4" DSDD 16 Hard Sector w/Hub Ring	M54A	2.79
5 1/4" SSQD Soft Sector w/Hub Ring (98 TPI)	M15A	2.69
5 1/4" DSQD Soft Sector w/Hub Ring (95 TPI)	M16A	3.79

SSSD = Single Sided Single Density; SSDD = Single Sided Double Density; DSDD = Double Sided Double Density; SSQD = Single Sided Quad Density; DSQD = Double Sided Quad Density; TPI = Tracks per inch

### Buy with Confidence

To get the fastest delivery from CE of your Wabash computer products, send or phone your order directly to our Computer Products Division. Be sure to calculate your price using the CE prices in this ad. Michigan residents please add 4% sales tax or supply your tax I.D. number. Written purchase orders are accepted from approved government agencies and most well rated firms at a 30% surcharge for net 30 billing. All sales are subject to availability, acceptance and verification. All sales are final. Prices, terms and specifications are subject to change without notice. All prices are in U.S. dollars. Out of stock items will be placed on backorder automatically unless CE is instructed differently. Minimum prepaid order \$50.00. Minimum purchase order \$200.00. International orders are invited with a \$20.00 surcharge for special handling in addition to shipping charges. All shipments are F.O.B. Ann Arbor, Michigan. No COD's please. Non-certified and foreign checks require bank clearance.

For shipping charges add \$8.00 per case or partial-case of 100 8-inch discs or \$6.00 per case or partial-case of 100 5 1/4-inch mini-discs for U.P.S. ground shipping and handling in the continental United States.

**Mail orders to:** Communications Electronics, Box 1002, Ann Arbor, Michigan 48106 U.S.A. If you have a Master Card or Visa card, you may call and place a credit card order. Order toll-free in the U.S. Dial 800-521-4414. If you are outside the U.S. or in Michigan, dial 313-994-4444. Order your Wabash diskettes from Communications Electronics today.

Copyright 1982 Communications Electronics

Ad #110582



**Order Toll-Free!** **wabash**  
**800-521-4414** **error-free**  
In Michigan 313-994-4444 **diskettes**

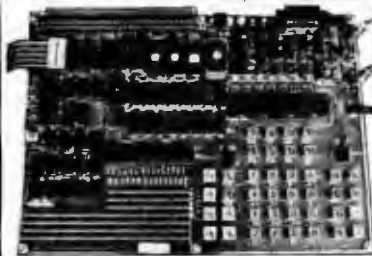
**COMMUNICATIONS**  
**ELECTRONICS™**

**Computer Products Division**

854 Phoenix □ Box 1002 □ Ann Arbor, Michigan 48106 U.S.A.  
Call TOLL-FREE (800) 521-4414 or outside U.S.A. (313) 994-4444



**EPROM PROGRAMMER,  
EMULATOR AND Z80  
COMPUTER ALL IN ONE  
\$495 SYSTEM, \$299 KIT**



- 2758, 2716/2616 plus 2732/2532, 2764/2564, 27128 personality modules & simulator adapters.
- 5-100 memory board extension (see Byte 1983 Feb. Issue p. 498)
- KIT does not include chassis nor power supplies (+5v, +25v, ±12v)

**Yang Electronic Systems, Inc.**  
307 Compton Ave., Laurel Md. 20707  
**(301) 778-0076**

Circle 483 on inquiry card.

**TeleVideo® Users!**

**92 WORDSTAR®  
COMMANDS**



with the TV 2000

- FEATURES**
- 48 single key commands
  - 41 unified commands
  - 5 MacroStar® commands
  - Soft switch activated
  - No loss of TeleVideo® attributes
  - Excellent user acceptance
- INCLUDES**
- Replacement ROM
  - 48 keycaps with legends
  - User oriented manual

**WordTech Systems**  
932 Mountain View Dr. Suite 114  
Lafayette, California 94549  
(415) 254-7747

Designed for 825 and 150  
terminates and 500 series  
computers

Suggested retail price \$220

Trademark WordStar® MacroStar® registered - Copyright © WordTech Systems, Inc.  
© WordTech® MacroStar® registered

Circle 486 on inquiry card.

**NEW PRODUCT!**



**CP/M Z80-A  
SINGLE BOARD COMPUTER**

- On board video • Wide fine and thin line graphics
- 128K of RAM • Sasi interface • Floppy disk controller for up to four 5-1/4 and four 8 inch drives, single/double density simultaneously • 4 serial ports • Full Centronics printer port • Expansion bus • Extended track buffer • 16K printer buffer
- DMA • Compact size (8-1/4 x 12-1/4)

**\$750.00** 3-6 weeks delivery

**INSIGHT ENTERPRISES CORPORATION**  
373 N Western Ave., Suite 12,  
Los Angeles, CA 90004 (213) 461-3262  
Dexter, Oem, International Inquiries Welcome

Circle 227 on inquiry card.

**IBM PC DISK DRIVES**

- TANDON TM100-2 GR
- CDC 9409 (D/S, 320 KB) .....\$249
- 8400 SERIES 8" THINLINE FLEX DISK SUB-SYSTEM (UP TO 2 4 MB, 3740 FORMAT, ATTRACTIVE DESIGN, 3 1/2" H x 19" W x 16" D) From \$1,130
- MAYNARD DISK CONTROLLER .....\$165

**IBM RAM &  
MULTIFUNCTION CARDS**

- QUADRAM ..... Call
- AST ..... Call
- TALL TREE SYSTEMS ..... Call
- BIG BLUE ..... \$475

**APPLE® DISK DRIVES**

- DATADRIVE ..... \$275
- APPLETTE I & II ..... Call
- (UTILIZES 1/2 HT. DRIVES)

**MICROXPRESS**

305 S. State College, Suite 135  
Anaheim, California 92806  
(714) 632-8512



Circle 147 on inquiry card.

**DISKETTES  
maxell. VERBATIM**

- |                   |                   |
|-------------------|-------------------|
| 100% ERROR FREE   | DATALIFE          |
| 5% SS/DD          | 5% SS/DD          |
| 28.95<br>(BOX 10) | 24.95<br>(BOX 10) |

**CAPTAINS SPECIAL**

BUY ONE BOX MAXELL GET 10% OFF 2nd BOX

**CAPTAINS SPECIAL**

VERBATIM HEAD CLEANING KIT 8.95 KIT

with order of disks MX-80 CARTRIDGE 4.95 EA.

**MEGA-BYTE**

ADD 2.00 SHIP 5% TAX IN FLA. 800-327-1013

4055 S.W. 45th STREET FORT LAUD., FLA 33314 305-567-1128

Circle 289 on inquiry card.

**CROSS ASSEMBLERS  
AND MICRO SIMULATORS  
written in FORTRAN IV**

Write, assemble, run and debug microprocessor software on most any hardware - no other hardware needed. Programs for any of the following target microprocessors:

- |         |         |         |         |
|---------|---------|---------|---------|
| MC68000 | MCS6502 | 8080/85 | CDP1802 |
| MC6809  | MC6805  | MC6801  | MC6800  |

Now you can assemble and run microprocessor programs on most any system that supports FORTRAN, then download to a hardware or target micro. Assembler and simulator can be run separately or together.

Assemblers are two-pass, with exact manufacturers' instruction set, plus macros, conditional assembly, long error messages, etc. Simulator can load object code, run, trace, modify, disassemble, save, and more. All programs can be run in either batch mode or interactively.

Target Processor	Assembler Package	Simulator Package
MC68000	\$750	\$1000
MCS6502	500	600
8080/85	400	500
CDP1802	400	500
MC6809	500	600
MC6805	500	600
MC6801	500	600
MC6800	400	500

Visa/MasterCard accepted. Package prices include FORTRAN source on tape, printed using manual and shipping. Free IMMEDIATE OVERNIGHT DELIVERY is available for prepaid orders. Call for details and program availability. Quantity prices available.

**IDI INTELLIGENT DEVICES, INC.**  
P O Box 183 Olaton, CO 80435  
(303) 468-0112

Circle 232 on inquiry card.

**AAA CONSTRUCTION**



**OPEN THE HANDYMAN'S DOOR FOR BIG SYSTEM SALES WITH CONSTRUCTION ESTIMATION SOFTWARE (CES-II)**

- Versatile - Runs on almost any 84K system.
  - Easy to Learn-Well documented with complete sample job
  - Easy to Use -On screen menu at all times.
  - Large data base historical costs files.
  - Assembly costs intermixed with single line item costs.
  - Unlimited quantity entries with units calculations.
  - Sell to all types Contractors, Subcontractors, Architects, Developers, Project Managers, Reps, Material Suppliers.
- CONTRACT RECORDS, INC.** • (404) 875-3533  
441-C Arthur Place NE • Atlanta, Georgia 30324

Circle 137 on inquiry card.

**TYCOMP**

- PRINTERS**
- ProWriter - 300 - Per
  - ProWriter - 600 - Ser
  - ProWriter II - 700 - Per
  - ProWriter II - 775 - Ser
  - Epson FX-80 - Call!
  - OKIDATA - ML97 - 570 -
  - OKIDATA - ML93 - 999 -
  - Star-Gemini 10 and 15 - Call
- CALL FOR APPLE II E & IBM-PC LOW - LOW PRICES!!**
- MBI - MONTE CARLO CARD - CALL**
- U.S. ROBOTICS - 1200 BAUD MODEMS CALL! CALL! CALL!**

Plus a full line of letter quality and Dot Matrix Printers

**MONITORS**

Princeton Graphics - Call

AMDEK 300 - 179<sup>00</sup>

AMDEK Color I - 389<sup>00</sup>

AMDEK Color II - 675<sup>00</sup>

**A LARGE MAGAZINE AD DOES NOT ALWAYS INSURE YOU THE CUSTOMER WITH FAST SERVICE AND COMPETITIVE PRICING. WE OFFER LOW PRICES! SUPPORT! AND EFFICIENT FRIENDLY SERVICE!**

CALL (803) 877-2468 MASTERCARD AND VISA ACCEPTED  
ORDERS - CALL COLLECT

**TYCOMP**  
700 W. Poinsett St.  
Greer, S.C. 29651  
WRITE FOR FREE CATALOG



Circle 486 on inquiry card.

**Z80\* SBC 8671 Basic Controller**

A complete self contained control computer.

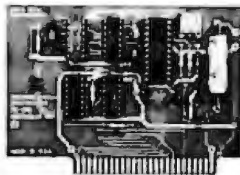
Features: Zilog Z8671 microprocessor with 2K basic interpreter. Sockets for 48K of on board user memory. 48 parallel I/O lines, RS 232 & 20MA current loop serial communications, and more ...

NOW ONLY  
Custom & Dem versions also available  
**\$285.00**  
\*Z8 is a Trademark of Zilog Corp

**LA** Lehmann & Associates  
P.O. Box 566, Maumee, Ohio  
(419) 891-0887

Circle 259 on inquiry card.

## SPEECH SYNTHESIZERS

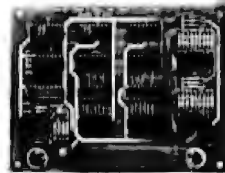


JBE's Speech Synthesizers use the Votrax SC-01 Phoneme Synthesizer chip. The SC-01 phonetically synthesizes continuous speech of unlimited vocabulary. The SC-01 contains 64 different phonemes and 4 levels of inflection accessed by an 8 bit code. It requires 10 bytes per second for continuous speech. Both boards have an audio amp for direct connection to an 8 ohm speaker.

Documentation includes basic user programs, a phoneme chart and listing of coded words to help you get started. Documentation for the Apple II<sup>®</sup> Speech Synthesizer includes a disk with text to speech program.

81-088 Apple II Speech Synthesizer **\$129.95**  
 81-120 Parallel Input Speech Synthesizer **\$149.95**  
 Prices include the SC-01 Chip  
 SC-01 sold separately for **\$ 39.95**

## A-D & D-A CONVERTER



JBE A-D & D-A Converter can be used with any system having parallel ports.

- Interfaces with JBE Parallel I/O Board
- D-A Conversion time — 50µs
- A-D Conversion time — 20µs
- 5VDC power supply
- Parallel inputs & outputs include 8 data bits, strobe lines & latches
- Analog inputs & outputs are medium impedance 0 to 5 volt range.

79-287 **ASSM. \$79.95**  
 Bare Board **\$39.95**

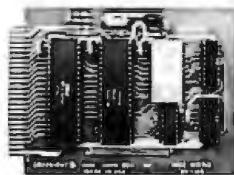
## SOLID STATE SWITCH



Your computer can control power to your printer, lights, stereo & any 120VAC appliances up to 720 watts (8 amps at 120VAC). Input 3 to 15VDC • 2-14MA TTL compatible • Isolation — 1500V • Non zero crossing • Comes in 1 or 4 channel version

79-282-1 **ASSM. \$13.95**  
 Bare Board **\$6.95**  
 79-282-4 **ASSM. \$49.95**  
 Bare Board **\$24.95**

## 6502 MICROCOMPUTER

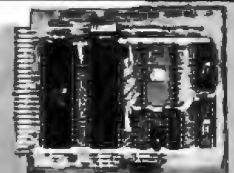


6502 MPU, 6522 VIA, 2716 EPROM, 2114 RAM single board computer. Single 5 volt power supply at 400 Ma. Two independent 8 bit I/O ports with hand-shake lines. RC controlled 1 MHz clock.

Complete documentation. I/O lines use 50 pin edge connector. Data and address lines are not accessible. Mod. for 2532 is included. EPROM is not included. 1K RAM, 2K EPROM, 2 I/O ports.

80-153 **Assm. \$110.95**

## Z-80 MICROCOMPUTER

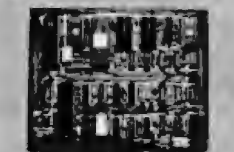


Z-80 MPU, Z-80 PIO, 2716 EPROM, 2114 RAM single board computer. Single 5 volt power supply at 300 Ma. Two independent 8 bit I/O ports with hand-shake lines. RC controlled 2MHz clock.

Complete documentation. I/O lines use 50 pin edge connector. Data and address lines are not accessible. Mod. for 2532 is included. EPROM is not included. 1K RAM, 2K EPROM, 2 I/O ports.

80-260 **Assm. \$129.95**

## VIDEO TERMINAL BOARD

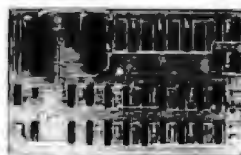


This is a complete stand alone Video Terminal board. All that is needed besides this board is a parallel ASCII keyboard, standard NTSC monitor, and a power supply.

- 6502 Microprocessor
- 6545-1 CRT controller
- 2716 EPROM char. gen.
- 2716 EPROM program
- 4K RAM (6116)
- RS232 I/O for direct connection to computer or modem
- 80 columns X 25 line display
- Size 6.2" X 7.2"
- Output for speaker (bell)
- Power +5 700 Ma.  
 +12 50 Ma.  
 -12 50 Ma.

This board is available assembled and tested. 82-018A \$109.95  
 Bare board with EPROMS and crystal. 82-018B \$ 89.95  
 Both versions come with complete documentation.

## MINI VIDEO 40 X 24



This board can be used to add a video display to your AIM or other computer. It can also, with the addition of a parallel keyboard, 5V power supply and video monitor, be used as a home computer. It will run Tom Pittman's Tiny Basic. The 2716 character gen. will produce 256 8x8 characters, ASCII upper and lower case and graphic characters. The 44 pin expansion connector can be used to add up to 6K of memory or extra I/O ports. Power requirements: 5 volts 600 MA 3 waits.

Documentation includes schematic, parts list, connector pin outs, and source listing for video display and Monitor. Control character response:

- H back space
- I up one line
- J line feed
- L clear screen and home
- M carriage return
- U forward space non destructive

The cursor is flashing *underline* type.

82-140A assm. W/O EPROMS **\$149.95**  
 Character Gen. A7 **\$ 19.95**  
 Tiny Basic + Monitor **\$39.95**  
 GPIO Parallel Input **\$ 19.95**  
 Bare Board with doc. **\$ 79.95**

## JBE I MICROCOMPUTER



JBE's 7.75 x 11.75 6502 base Microcomputer has the capacity for 16K of EPROM, 4K of RAM, 8 Parallel Ports and 1 Serial Port. Monitor and Tiny Basic are also available.

Both versions include sockets for 2716s or 2532s, 8 16 pin sockets for I/O interfacing and a DB25 connector for RS232.

All address and data lines are brought off the board to the 50 pin edge connector (connect to the Apple II bus.)

This board also features power on reset and cassette interface.

81-030C Fully Populated **\$399.95**  
 81-030M Partially Populated **\$299.95**  
 2716 EPROM (with Tiny Basic) **\$ 19.95**

## 81-260 "SLIM"



Single board large scale integration Microcomputer. This 4.5 x 6.5 board uses the 6502 Microcomputer, two 6522 VIA's four 2114 RAM's, 2516, 2716 or 2532 EPROM. The fully buffered 2244 pin bus is similar to the KIM<sup>®</sup>, SYM<sup>®</sup>, and AIM<sup>®</sup> expansion connector. The four 8 bit I/O ports connect through 16 pin dip sockets. This board was designed for control and is ideal for Personal and OEM use.

- 6502 MPU
- Two 6522 VIA's
- Four 2114 RAM's (2K bytes)
- One EPROM 2516 or 2532
- Crystal clock 1 MHz
- Requires 5V 1AMP power
- 4.5 x 6.5 card
- Power on reset
- Fully buffered-expandable
- Solder mask-both sides

Use your Apple II Computer JBE 6522 Parallel Interface card and EPROM Programmer for development system for SLIM.

81-260A **Assm. \$199.95**

## PERIPHERALS FOR SLIM



RAM EPROM Memory (32K)  
 81-330A Assm. W/O Memory **\$99.95**  
 81-330B Bare Board **\$49.95**

6 Slot Mother Board  
 81-320A Assembled **\$99.95**  
 81-320B Bare Board **\$49.95**

24 Hour Real Time Clock  
 81-350A Assembled **\$149.95**  
 81-350B Bare Board **\$ 49.95**

Analog I/O Interface  
 81-036A Assembled **\$199.95**  
 81-036B Bare Board **\$ 49.95**

12 Port Parallel I/O (6-6522'S)  
 82-036A Assembled **\$189.95**  
 82-036B Bare Board **\$ 49.95**

Tiny Basic + Monitor EPROM **\$39.95**



# JOHN BELL ENGINEERING, INC.

ALL PRODUCTS ARE AVAILABLE FROM JOHN BELL ENGINEERING, INC. • 1014 CENTER ST., SAN CARLOS, CA 94070  
 ADD SALES TAX IN CALIFORNIA • ADD 5% SHIPPING & HANDLING 3% FOR ORDERS OVER \$100

(415) 592-9411

WILL CALL HOURS: 9am - 4pm

10% OUTSIDE U.S.A.

ADD \$1.50 FOR C.O.D.



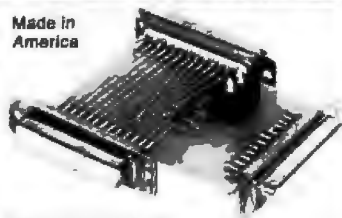
#245





## RS-232 DATA TAP...

Made in America



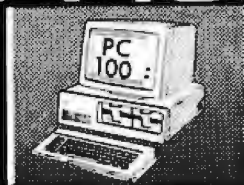
### RS-232 DATA TAP...

Can be used to monitor the data which is being transmitted and received on a RS-232 line. Drives a printer, CRT or any other RS-232 receive type device. Requires no AC power or batteries to operate. **ORDER NOW!** Only \$34.95, plus \$1.75 shipping and handling. (IL res. add 5% sales tax); we accept MC or VISA. FREE Illustrated catalog of problem solving equipment! Phone: 815/538-5827. Make checks payable to:

**B&B electronics**  
Box 475B, MENDOTA, IL 61342

Circle 58 on inquiry card.

# VT100



OUR **PC100™** SOFTWARE PACKAGE TURNS YOUR **IBM PC** INTO A **DEC® VT100** or **VT52** Compatible terminal

Requires: 64k.1 drive, monochrome or color adpt with 25x80 display, async adpt, and IBM DOS or QUNIX™ 14

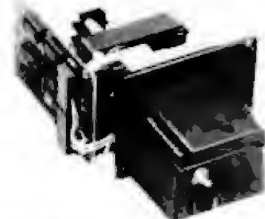
PRICED: \$88. (Std. VT100 functional)  
Optional: Local Printer & Copy to/from Disk.

**GMS 7525 MITCHELL RD.**  
SUITE 101  
EDEN PRAIRIE, MN 55344

CALL OR WRITE  
(612) 937-8194

(IBM is a registered trademark of International Business Machines. DEC, VT are registered trademarks of Digital Equipment Corp. QUNIX is a trademark of Quantum Software Systems. PC100, GMS are trademarks of General Micro Systems.)

Circle 205 on inquiry card.



### 350 Char/Sec Low Cost Loader

Solid state photoelectronic components read all standard 5, 6, 7 or 8-level tapes. Smooth, quiet AC drive. Reliable high-speed paper tape data entry. Data amplifiers and "character ready" output available for CMOS or TTL interfaces. Standard interface or to your interface specifications. Fanfold boxes available.

Addressmaster Corporation, 418 Junipero Serra Drive, San Gabriel, CA 91776, Telephone: (213) 285-1121, Telex: 874770 Addressmaster SGAB

Circle 14 on inquiry card.

## Full Size Keyboard Conversion

For Your ZX81/TS1000

SUN KD-81  
\$69.95



Easy To Install  
No Soldering - No Modifications

41 Keys with Full Size Space Bar • Allows Touch Typing Same Key Layouts as Sinclair • Two Color Keysteps  
Keyboard Case Holds Both Keyboard and Computer Commands and Graphics Spilled Out on Keysteps  
16K Piggyback RAM Module P/N MX-15 \$49.95

**SUNTRONICS CO., INC.**

In Calif Call 213-844-1149

Outside Calif Call 1-800-421-5775

Or send Check or M.O. to:

P.O. Box 1957 Hawthorne CA 90250

California residents add 6 1/2% sales tax.

Add \$4.00 shipping handling USA/Outside call include applicable data.

Circle 429 on inquiry card.



Powerful — Economical — Professional  
Peripherals for your Apple II®

A/D 12-Bit, 16 Channel \$450.00

- Simple CPU Selection of Channels AD 12/160x
- Range: 10 : 5 : 25 : 5 : 10
- High-Speed 25 µ sec. Conversion
- Full Software Support — Disk or PROM
- Adjustable Bipolar Reference

Ultra ROM Board/Editor \$190.00  
APR 1/2

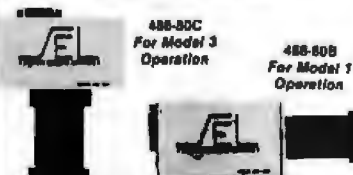
- 32K of Bank Switchable ROM Space
- Powerful G/P/E (Global Program) Line Editor in Firmware
- Totally Transparent — Remove or insert with a few keystrokes — without Data!
- Appropriate Extensions including "IF, THEN, ELSE"

12842 Volcan Ave.  
Van Nuys, CA 91405  
Tel: 754 7034



Circle 30 on inquiry card.

IEEE-488 TO TRS-80® INTERFACE  
Everything needed to add powerful BASIC GPIB-488 controller capability to TRS-80 Model 1 or 3, Level 2 or DOS with a minimum of 16K.



Model 488-80B or 488-80C Price: \$375.  
+ shipping, insurance & tax  
WHEN ORDERING SPECIFY DISK OR TAPE

**SCIENTIFIC ENGINEERING LABORATORIES**

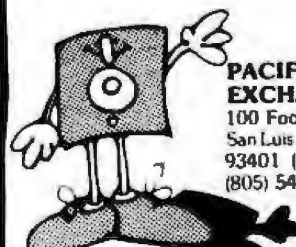
11 Neil Drive • Old Bethpage, NY 11804  
Telephone: (516) 694-3370

\*Trademark of Tandy Corp  
There is no affiliation between Scientific Engineering Laboratories and Tandy Corp or Radio Shack

Circle 404 on inquiry card.

**dysan**  
**Dysan CORPORATION**

Solve your disc problems, buy 100% surface tested Dysan diskettes. All orders shipped from stock, within 24 hours. Call toll FREE (800) 235-4137 for prices and information. Visa and MasterCard accepted.



**PACIFIC EXCHANGES**  
100 Foothill Blvd.  
San Luis Obispo, CA  
93401 (In Cal call  
(805) 543-1037)

Circle 347 on inquiry card.

## FAST Factory Floppy Disc Drive Repair

Specialists in the repair of:

Shugart  
Tandon  
PerSci

**PERSci, Inc.**



12624 Daphne Avenue  
Hawthorne, CA 90250  
(213) 777-4070  
TELEX 687444

Circle 356 on inquiry card.

## 5 1/4" Disc Drive 100% Apple® Compatible



\$228.00 ea. w/o controller  
\$288.00 ea. w/ controller

Replacement parts for Apple® II:

Computer Case \$145.00 ea.  
Keyboard \$ 95.00 ea.  
Switch Power Supply \$125.00 ea.

Call or send check/money order to:

**VSC TECHNOLOGIES INC.**

1212 E. Main Street  
Alhambra, CA 91801  
Phone: 213-281-4914  
Telex: 69-1300

\*Apple is a registered trademark of APPLE COMPUTERS INC. (Add 7% for shipping & handling.)

Circle 480 on inquiry card.

# WE WILL NOT BE UNDERSOLD

## TERMINALS

Zenith ZT-1	\$595.00
Zenith Z-18	\$679.00
Televideo 910+	\$599.00
Televideo 925	\$779.00
Televideo 950	\$978.00
Sanyo CRK-1100	CALL

## COMPUTERS

Sanyo MBC 1000 64K	CALL
Sanyo MBC 1200	CALL
Sanyo MBC 2000 dual 5 1/4"	CALL
Sanyo MBC 3000 dual 8"	CALL
Sanyo MBC 4000 16 BIT	CALL
ALL SANYO COMPUTERS INCLUDE	
WordStar, MailMerge, CalcStar, SpellStar, InfoStar	
Franklin Ace 1000 64K	CALL
Franklin Ace 1200 128K	CALL
Call for our Special System Packages!	

## TELECOMMUNICATIONS

Novation Cat	\$139.00
Novation J Cat	\$119.00
Novation D Cat	\$155.00
Novation Apple Cat	\$289.00
Novation Apple Cat 1200 baud	\$829.00
Novation Smart Cat	\$199.00
Novation Smart Cat 1200 baud	\$495.00
Hayes Micromodem I	\$299.00
Hayes Smartmodem	\$238.00
Hayes Smartmodem 1200 baud	\$569.00
Hayes Chronograph	\$229.00
Signalman Mark I	\$89.00
Signalman-IBM	\$189.00

## DISKETTES

Verex 5 1/4"	\$23.95
Verbatim 5 1/4"	\$26.95
Verbatim 8"	\$36.95
Verbatim Head Cleaning Diskette	\$9.95
Maxell MD 1 5 1/4"	\$29.95
Maxell MD2 5 1/4"	\$44.95
Maxell FD 1 8"	\$37.85
Maxell FD2 8"	\$44.95
5 1/4" File Box	\$19.95
8" File Box	\$21.85

## MONITORS

Sanyo 9" B&W	\$159.00
Sanyo 9" Green	\$185.00
Sanyo 12" B&W	\$179.00
Sanyo 12" Green	\$198.00
Sanyo 13" Color	\$399.00
SMD 13" Color	\$339.00
Comrex 13" Color	\$329.00
Armdak 13" Color	\$329.00
Zenith 13" Color RGB	\$589.00
Zenith 12" Green	\$99.00
Electrohome 13" Color RGB	\$569.00
Texan 12" Amber	\$139.00
Texan 12" Green	\$129.00
Texan 12" Medium Res Color	\$319.00
Texan 12" Hi Res Color	\$529.00

The CPU Computer Corporation  
Announces:

## CPU net

The Local Area Network that uses real CP/M™ for Apples. CPU net™ allows you to run hundreds of popular CP/M™ programs, on your Apple terminals, without disk drives!

Call for more information.

**\$2995.00**

## APPLE ACCESSORIES

16K Card by Microsoft	\$79.00
32K Card by Saturn	\$199.00
64K Card by Saturn	\$419.00
128K Card by Saturn	\$585.00
SoftCard Plus by Microsoft	CALL
Keyboard Enhancer by Videx	\$125.00
Videtermin by Videx	\$259.00
Game Paddle by TG	\$49.00
Joystick by TG	\$49.00
Plaso ID-12 Card	\$159.00
Plaso EP-12 Card	\$159.00
Plaso AP-12 Card	\$159.00
Plaso NE-12 Card	\$159.00
System Saver by Kensington	\$75.00
Microbuffer II 16K (Apple)	\$229.00
Microbuffer II 32K (InLine)	\$299.00
Microbuffer II 64K (InLine)	\$319.00
Add-Ram 16K by ALS	\$79.00
Z-Card w/CPM by ALS	\$225.00
Z-Card 64K by ALS	\$299.00
Smarterm by ALS	\$249.00
Smarterm II by ALS	\$149.00
Dir Cheap Video by ALS	\$75.00
Color II Card by ALS	\$149.00

## APPLE SOFTWARE

MICROPRO	
WordStar	\$379.00
MailMerge	\$190.00
SpellStar	\$190.00
DataStar	\$259.00
CalcStar	\$115.00
VISICORP	
VisiCalc	\$199.00
VisiTerm	\$89.00
VisiDex	\$199.00
VisiPlot	\$169.00
VisiFile	\$199.00
VisiSchedule	\$259.00
VisiTrend/Plot	\$259.00
VisiLink	\$199.00
VisiCalc Business Model	\$89.00
MISCELLANEOUS	
MicroTerminal	\$69.00
Screenwriter II	\$99.00
Dictionary	\$79.00
DB Master	\$169.00
PFS Filing System	\$99.00
PFS Report	\$75.00
PFS Graph	\$99.00
Easy Writer Pro	\$199.00
Easy Mailer Pro	\$79.00
Z-Term Pro	\$129.00
Word Handler	\$149.00
MultiPlan by Microsoft	\$229.00
dBase II	\$489.00
HowardSoft Tax Preparer	\$149.00

## IBM PC HARDWARE

Quadram 128K Ram Card	\$599.00
Quadram 192K Ram Card	\$719.00
Quadram 256K Ram Card	\$795.00
Microsoft 64K Ram Card	\$399.00
Microsoft 192K Ram Card	\$699.00
Microsoft 256K Ram Card	\$799.00
Joystick by TG	\$49.00
Tandon TM 100-2 Raw Drive	\$279.00

## TO ORDER CALL TOLL FREE

1-800-343-6522

For fast delivery, send certified checks, money orders, or call to arrange direct bank wire transfers. Personal or company checks require one to three weeks to clear. All prices are mail order only and are subject to change without notice. Call for shipping charges.

## IBM PC SOFTWARE

INFORMATION UNLIMITED	
Easy Writer	\$289.00
Easy Speller	\$149.00
Easy Filer	\$319.00
VISICORP	
VisiCalc 256K	\$189.00
VisiDex	\$209.00
VisiFile	\$259.00
VisiTrend/Plot	\$259.00
VisiSchedule	\$259.00
VisiWord	\$329.00
MICROPRO	
WordStar	\$379.00
MailMerge	\$195.00
MISCELLANEOUS	
SuperCalc	\$279.00
SuperWriter	\$299.00
Home Accountant + dBase II	\$129.00
	\$495.00

## DISK DRIVES

CCI 121 add-on for Sanyo MBC 1000	\$369.00
CCI 100 for the TRS 80 Model I	
5 1/4" 50 track	\$299.00
Corvus 6M with Mirror	\$2895.00
Corvus 10M with Mirror	\$3879.00
Corvus 20M with Mirror	\$4579.00
Rana Systems for the Apple II	
Elite One 40 track	CALL
Elite Two 80 track	CALL
Elite Three 80 track, double side	CALL
Elite Controller	CALL
Sanyo EFD 160	\$699.00

## RAM

16K Ram Kit for Apple II and TRS 80. 4116 chips	
200 nano seconds	\$17.50

## PRINTERS

NEC 3510 Serial	\$1595.00
NEC 3530 Parallel	\$1629.00
NEC 3550 for the IBM PC	\$1985.00
NEC 7710 Serial	\$2250.00
NEC 7720 KBR	\$2675.00
NEC 7730 Parallel	\$2250.00
Epson MX 80	CALL
Epson MX 80 FT	CALL
Epson MX 100 FT	CALL
Epson FX Series	CALL
Epson RX Series	CALL
IDS Microprism	CALL
IDS Prism 80	CALL
IDS Prism 132	CALL
Okidata 82A	\$479.00
Okidata 83A	\$729.00
Okidata 84	\$1149.00
Sanyo PR 5500 Letter Quality	\$859.00
Brother HR 1 Letter Quality	\$899.00
Toshiba P 1350 160 CPS Letter Quality	CALL

Call For More IBM Software And Accessories

CP/M is a registered trademark of Digital Research.

## SPECIAL OF THE MONTH

**SANYO PR 5500  
LETTER QUALITY  
PRINTER  
18 CPS—DAISY WHEEL  
BI-DIRECTIONAL  
SCALLS**



# The CPU Shop

DEALER INQUIRIES PLEASE CALL 1-800-343-7036

420-438 Rutherford Ave., Dept. BY-5, Charlestown, Massachusetts 02129



Hours 9 AM - 9 PM (EST) Mon.-Fri. (Sat. till 6)  
Technical information call 617/242-3361

TWX- 710-348-1796

Massachusetts Residents call 617/242-3361  
Massachusetts Residents add 5% Sales Tax

Circle 140 on Inquiry card.

BYTE May 1983 553



# Cables EIA RS 232-C

Quality cables with immediate delivery and low prices.

Conductor	Price
1-4	\$12.00 + 18/ft.
5-7	12.50 + 27/ft.
8-12	13.50 + 33/ft.
13-16	14.75 + 44/ft.
17-25	17.00 + 55/ft.

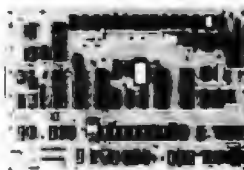
Specify: Male or female connectors, length of cable and pins to be connected. OEM & quantity discounts available to qualified customers. On prepaid orders add \$5.00 for shipping/handling. We also supply connector parts, bulk cable, IBM, DEC Compatible & Centronic cables.

## Communication Cable Company

319 Louella Ave. Wayne, PA 19087  
215-964-9404

Circle 103 on Inquiry card.

## ONE BOARD CP/M SYSTEM FOR NETWORKS



### Features:

- 8 1/2" x 11 1/2" inches
- 10 MHz 8085 CPU
- 64K RAM
- 880 KB/DISK
- Network Port
- CRT Controller
- 8272 FD Controller
- Winchester Interface
- 2 RS-232 Channels

Documentation \$30  
CP/M floppy disk Op. Systems \$180  
Check or Money Order

**autocontrol**  
CORPORATION

11400 Dismark Rd.  
Maryland Heights, MO 63042  
(314) 739-0995

Circle 54 on Inquiry card.

## FLY BOARD Programable INTERFACE for the Apple II

The FLY BOARD is an interfacing system designed for Apple Owners who want to learn computer interfacing. The FLY BOARD is programable through BASIC or Assembly.

### Fly Board's Hardware:

6522 VIA

2K bytes RAM

2 - 36" DIP Jumper Cables

### Support Materials Included:

- User's Manual expertly written to guide the novice and integrate the expert
- Summary Card outline of a garage
- Engineer's Notebook 126 page electronic notebook
- 8822 Data Sheet captures advanced features

only  
**129<sup>00</sup>**

Ready to use  
add \$2  
for shipping

SHAVE SYSTEMS  
P.O. Box 957  
Ipswich, MA 01938

VISA, M.C.  
or check  
(818) 646-6505

Circle 417 on Inquiry card.

## POWER PROTECTION FOR YOUR SYSTEM



The Datasaver™ AC Power Backup fits most desktop and portable microcomputer systems. Call Cuesta Systems, Inc. at (805) 541-4160 for product information and application literature. VISA/Mastercard orders call (800) 851-6055.

**INSTANT POWER**

Circle 143 on Inquiry card.

## \$73.80\* Single Board Computer



7 1/2" single board, model MCS11

6800 MPU, serial I/O, parallel I/O, RAM, EROM, 44-pin 4 1/2" x 6 1/2" PCB

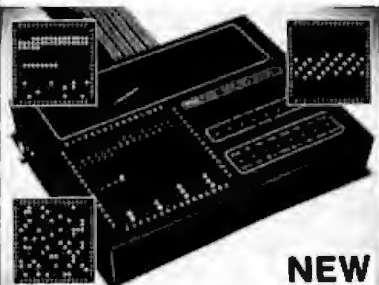
**EXPANSION MODULES**  
RAM, ROM, CMOS RAM/battery, analog I/O, serial I/O, parallel I/O, counter/timer, 488 GPIB, EROM programmer, power fail detect/power on reset

**WINTERK**

Winter Corp.  
1801 South Street  
Lafayette, IN 47904  
317-742-8428

Circle 488 on Inquiry card.

## DEBUG FAST



**NEW**

**NEW QUICK LOW-COST μP DEBUG AID.** If you program, engineer, test, or repair micros, try this new invention and save endless time and effort. Shows you program flow, address, data, I/O, timing, and stability info on 256 LEDs. Telescopic and microscopic views. Easy, quick, rugged, portable. A smart alternative or addition to multi-thousand dollar instruments. MICRO VIEW™ is just \$749 complete. Order today on 14-day trial or circle our number for color brochure. Micro Logic Corp., POB 174, MS-1, 100 2nd St. Hackensack, NJ 07602. (201) 342-6518

Circle 297 on Inquiry card.

## BREAKTHROUGH

Originate/Answer UDS 212 LP Modem

~~\$495~~

\$395



### IMMEDIATE DELIVERY

- Compatible with Bell 212 modems (1200 bps only)
- Telco powered - no AC connection required
- Simplified controls - 10%/data and originate/answer only
- Direct-connect to dial-up network

**INNOVATIVE COMM.**

1171 W. Dundee Road  
Wheeling, IL 60090  
Sales - (312) 459-8888  
Service - (312) 459-8874

Circle 236 on Inquiry card.

## R T L

## Relocatable Threaded Language **\$150**

RTL is a new language which retains the speed and extensibility of Fortran but adds many additional advantages as a result of its more structured dictionary. Names, code, and variables are all stored in separate areas for easy generation of headerless, romable code. All code is relocatable. RTL supports local variables, multitasking, redirected I/O, and even allows definitions to be changed retroactively. All source code is included. Versions are currently available or under development for 68000, 6809, 8080, 280, 8086, 8088, and 6502.

RTL Programming Aids  
10844 Deerwood SE  
Lowell, MI 49331  
(616) 897-5672

Circle 396 on Inquiry card.

STOP LOSING MONEY IN THE BOARD ROOMS

## LOGICSIM



CP/M based  
professional  
logic  
simulator

- For engineering work stations
- For gate-array, custom and all other IC designers
- For digital system engineers

Now logic-simulation, design-to-assembly TTL, CMOS, PALs logic, ROM's and RAM's, three-state and tri-state gates, mixed-signal modes, propagation delays, setup and race analysis, reproducible post-mortem Booth TTY memory history plus numerous other features, make LOGICSIM comparable to industry standard simulators.

Try it now. Send us a \$30 check for LOGICSIM demo copy and 1 user's Manual.

Please specify 8" IBM 3740, 5" APPLE II (12/16 series), CP/M based 50k to 64k systems (APPLE's with CP/M) cards. Introductory price \$375.

For more information, call (408) 578-8096. Or write:  
E-Z ASSOCIATES, 5588 Starrs Dr., San Jose, CA 95123

Circle 179 on Inquiry card.

# THE MOST VERSATILE MICROCOMPUTER YOU CAN BUY ISN'T SOLD IN ANY STORE.

Before you start hunting from store to store for the ideal microcomputer, consider this: you won't find it.

That's because the world's most versatile micro is available *only* from the manufacturer. It's Lobo's MAX-80™. And, dollar for dollar ... feature for feature, there isn't another system that even comes close. Here's why.

## LOOK WHAT \$945 BUYS!

- 128k RAM standard.
- CP/M Plus included (CP/M 2.2 compatible). As a low-cost option you can get LDOS, and run most TRS-80 Model III software. The MAX-80 with CP/M and LDOS gives you access to more software than any other system!
- 5MHz Z-80B processor increases the speed of program execution by 250% over Model III or SoftCard/Apple.
- All disk interfaces built in. Plug in any combination of 5¼" floppies, 8" floppies, and Winchester disks.
- Software-selectable 24 x 80 (under CP/M), 16 x 64, and 16 x 32 (under LDOS) screen formats. For full compatibility with CP/M and TRS-80 applications.
- Two RS-232C serial ports for modems, printers, or what-have-you.
- Centronics-type parallel port. For any printer using this standard interface.
- Extra-rugged construction with heavy-duty case and sculptured full-stroke keyboard.
- Built-in numeric keypad with 4 programmable function keys.
- 1-year limited warranty on hardware.
- Plus: all characters (both text and graphics) are software definable; built-in clock/calendar with battery backup; and buffered I/O expansion port.

## HOW TO GET ONE... FAST!

At just \$945, the MAX-80 could be everything you've been looking for in a computer. Order yours today by calling Lobo's toll-free number. And, while you're at it, check the great prices on Lobo's superb peripherals.

Then, feel free to go window shopping again. You'll be amazed at how good you feel at having bought a MAX-80 in the first place.

### CPU and Accessories

MAX-80 computer with CP/M Plus	\$ 945
300102 12" (diag.) high-resolution anti-glare green phosphor monitor	\$ 175
300104 12" (diag.) high-resolution anti-glare amber screen monitor	\$ 195
LDOS operating system (version 5)	\$ 69

### Dual 5¼" Floppy Disk Systems

003120 single-sided, 40 track; 180kB per diskette	\$ 690
003420 double-sided, 80 track; 720kB per diskette	\$1,175

### Dual 8" Floppy Disk Systems

NOTE: Lobo CP/M permits reading and writing standard single-sided, single density CP/M disks with either of these systems.

Prices subject to change without notice.

004120 single-sided, double density; 577kB per diskette	\$1,185
004220 double-sided, double density; 1155kB per diskette	\$1,485

### Winchester Disk Systems

005020 5¼" system: 4.8MB hard disk plus 720kB floppy (double density only)	\$2,405
005520 8" system: 8MB hard disk plus 1155kB floppy (double density only)	\$3,085

© 1983 Lobo Systems

MAX-80 is a registered trademark of Lobo Systems Incorporated  
CP/M Plus and CP/M 2.2 trademarks of Digital Research Corp.

TRS-80 Model III trademark of Tandy Corp.  
SoftCard trademark of Microsoft Corp.  
Apple trademark of Apple Computer  
LDOS trademark of Logical Systems Inc.

ALL PRICES INCLUDE SHIPPING WITHIN THE U.S.A.  
California residents add 6% sales tax.  
Payable by credit card, check, money order, or certified C.O.D.

### The Lobo Warranty

All Lobo hardware products carry a limited 1-year parts and labor warranty. Call or write for complete warranty statement.



**ORDER NUMBERS:**  
(805) 683-1576 (800) 235-1245  
(800) 322-6103 (In Calif.)

Telex 658482

Hours: 7AM-5PM Pacific Time

**LOBO**  
SYSTEMS INC.



Dept. B583

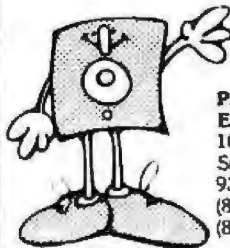
358 S. Fairview Ave., Goleta, CA 93117





# Verbatim flexible disks

Call Free (800) 235-4137 for prices and information. Dealer inquiries invited. C.O.D. and charge cards accepted.



VISA

**PACIFIC EXCHANGES**  
100 Foothill Blvd.  
San Luis Obispo, CA  
93401. In Cal. call  
(800) 592-5935 or  
(805) 543-1037

Circle 347 on inquiry card.

## SPECIAL OFFER!



### TURBO-MICRO COMPUTER

Complete System With Networking Capability

- 1 to 16 independent users
- 20 to 80 M.Byte hard disk
- CP/M or TurboDos Operating System
- 100% CP/M Compatible
- S-100 BUS Structure, master/slave concept

3.2 M.Byte Desk Top Turbo-Micro Computer, 1 to 5 users ..... \$2995.00  
20 M.Byte Hard Disk Desk Top Turbo-Micro Computer, 1 to 5 users ..... \$4995.00  
20 M.Byte Hard Disk Stand-Alone Turbo-Micro Computer, 1 to 16 users ..... \$8895.00

Write or call for complete information and price package.

C.D.S.

SAN DIEGO, CA 92111 (619) 571-5916

Circle 20 on inquiry card.

## IBM Quality Printing for Your Computer



Complete system with top-quality IBM Electronic typewriter is ready to plug into your computer. Or you can convert your own IBM Electronic or Selectric.

- IBM approved since 1978.
- For all popular computers.
- No special software required.
- Money back guarantee.

### MORE SUPER SPECIALS!

Smith-Corona IP-1 \$629 Telexvideo 925 \$788  
Telex Systemstar \$792 Andex DP950GA \$1388  
Software, other products Call Star Printers Call

Call our professionals for best service and price



• We export to all countries.

**IPEX**  
IPEX INTERNATIONAL, INC.  
5115 Douglas Fir Road  
Calabasas, CA 91302 U.S.A.  
Telex: TWX 910-494-2100

(213) 710-1444

IBM and Selectric are trademarks of IBM Corp.

Circle 240 on inquiry card.

## ANALOG ↔ DIGITAL DIGITAL ↔ ANALOG CONVERSION MODULES SOFTWARE GAIN CONTROL

High accuracy - custom board test - 2 to 15 kHz conversion time - 10 bit - simple and hold amplifier - 8 channel differential - 16-channel - analog to digital amplifier - programmable gain instrumentation - custom board test - 5/100 - 2 to 15 kHz conversion time - multiple high and low inputs - gain from 1 to 1024 - 12-bit - sample and hold amplifier - 8-channel differential - 16-channel - analog to digital high accuracy - programmable gain instrumentation - custom board test - 5/100 - 2 to 15 kHz

For additional details about the AD-100-4 and other fine California Data Corporation 100% individually tested, high reliability products, circle the reader service card number below or for faster response write or call us

**CALIFORNIA DATA CORPORATION**  
3475 Old Conejo Road, Suite C-10  
Newbury Park, CA 91320  
(805) 498-3651

Circle 86 on inquiry card.



## SAVE 50% on Scotch Diskettes

Dealer inquiries invited

**5 1/4" Specify Soft 10 or 16 Sector prices/10**

7440 1 side/dbl dens \$22.30  
745 2 sides/dbl dens \$31.00  
746 1 side/quad 96 tpi \$33.80  
747 2 sides/quad 96 tpi \$45.50

**8" Specify Soft or 32 Sector**

740 1 side sgl/dens \$23.60  
741 1 side/dbl dens \$29.00  
743 2 sides/dbl dens \$37.80

Checks-VISA-MC-C.O.D./Add \$2 Shipping  
Call or write for our complete list

**LYBEN COMPUTER SYSTEMS**  
27204 Harper Ave., St. Clair Shores, MI 48081  
Phone (313) 777-7780

Authorized Distributor  
Information Processing Products **3M**

Circle 268 on inquiry card.

## BOOKKEEPING AND PAYROLL FOR SMALL BUSINESS

For CP/M and MS-DOS Systems Source code provided

	LIST	PLAN-A	PLAN-B	PLAN-C
Bookkeeping	\$300	\$275	\$225	\$225
Payroll	\$400	\$375	\$300	\$300

Other CP/M, MS-DOS, Apple and MDOS software available with same terms. Write or call for full spec sheets or further information.

### PLANS:

- A - Phone support, exchange privileges, 90 days
- B - Phone support, exchange privileges, 30 days
- C - Support limited to supplied documentation, no exchange except for bad disk replacement

(Additional support available at \$20/hour)

### TERMS:

Prices include cash discount. Add 4% for charge or C.O.D. orders. Visa and MasterCard accepted. Add \$4.00 for shipping and handling.

Suite 14  
3322 Main  
Pkwy S.W.  
**daman** (206) 883-8113  
Mantoloking, AL 38801

Circle 146 on inquiry card.

## NEW REPLACEMENT RIBBON CARTRIDGES

**EPSON MX 70-80 \$4.75 ea.**  
**MX 100 10.75 ea.**

Please add \$ .75 ea shipping/handling

WE HANDLE MOST POPULAR CARTRIDGES,  
SEND FOR PRICE LIST

## LABELS

\$12.00/5000

STOCK #10350-1 15/16" x 3 1/2" x 1 wide.

White - pressure sensitive - pin feed - 4 1/4" corner, packed 5000 per box

Add \$2.50 per box handling/shipping

COMPLETE LINE OF OTHER LABELS AVAILABLE. SEND FOR PRICE LIST

TERMS: MIN. ORDER \$12.00.

VISA & MC (add 4%) check or money order  
C.O.D. add \$2.00 CA residents add Sales Tax

**S.W. COMPUTER SUPPLY CO.**

25422 TRABUCO RD. SUITE #200 A  
EL TORO, CA. 92630 • (714) 768-0370

Circle 398 on inquiry card.

## FORECASTING

**EASI/ARIMA** - The first and only microcomputer program to develop and run ARIMA (Box-Jenkins) models...all automatically. Designed for the stock or commodity trader. Create a database or read Compu Trac files directly. Requires no knowledge of statistics. \$300.

**TWG/ARIMA** - The statistician's version of EASI/ARIMA. Complete control and more options, such as seasonal models and Box-Cox transformations. \$300.

ELF is our general purpose statistical package. \$200

All are for the Apple II\* with 48K of memory, Applesoft\* and DOS 3.3

Visa and MasterCard accepted.

Call or write:

*The Wrenchendon Group*  
3907 Lakota Road  
P.O. Box 10114  
Alexandria, VA 22310  
(703) 960-2587

\*Trademark of Apple Computer, Inc.

Circle 485 on inquiry card.

## PROGRAMMABLE COMMUNICATIONS TRANSLATOR

The PCT-100 is an in-line RS-232C communications translator and is completely IBM compatible. Your system requires no hardware or software modifications to interface and quickly program the PCT-100. PCT-100.

- TRANSMIT OR RECEIVE TRANSLATION
- COMPATIBILITY AND MACRO-FUNCTION ALSO FOR WORD PROCESSING, ACCOUNTING AND OTHER SOFTWARE PACKAGES
- INTELLIGENT BIT DIRECTIONAL CHARACTER SEQUENCE TRANSLATION
- DEC-FAMILY OR IBM-PC/XT COMPATIBILITY
- "TPI-READ" AND DATA BUFFERING
- REMOVED PROTOCOL COMMANDS (E.G. CTS/RTS, XON/XOFF)
- Baud Rate ADAPTATION
- PRINTER FORMAT CORRECTION

Buy the PCT-100 as a complete stand-alone module for full support terminal or printer, or as a stand-alone module with a full plug-in supply. Either way, you've added a powerful upgrade to your system at an unbeatable price.

PCT-100-PCH (PRINTED CIRCUIT BOARD ONLY) ..... \$ 99  
PCT-100-ASH (PRINTED CIRCUIT BOARD WITH CASE) ..... \$ 149  
PCT-100-MS (FULL PLUG-IN MODULE SUPPLY) ..... \$ 59

IBM, IBM PC, IBM PC XT, IBM PC AT, IBM PS/2, and IBM are trademarks of International Business Machines Corporation.

DEALER INQUIRIES INVITED

**COMMUNICATIONS TRANSLATOR**  
1975 SOUTH LAKOTA ROAD, ALEXANDRIA, VA 22310  
(703) 960-2587

(PLEASE ALLOW 4 TO 6 WEEKS FOR DELIVERY)

Circle 292 on inquiry card.

# Alspa Computer, Inc.

The price-performance leader. Includes Z80A, 1 or 2 full 8" drives (double density, double sided), 3 serial and 1 parallel port, and winchester port. Prices start at less than \$2000. DEALER and OEM inquiries invited.

## SPECIALS on INTEGRATED CIRCUITS

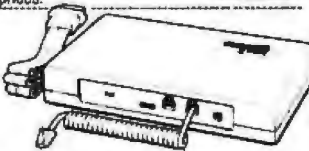
6502	7.45	10/ 6.95	50/ 6.55	100/ 6.15
6502A/6512A	8.40	10/ 7.95	50/ 7.35	100/ 6.90
6520 PIA	5.15	10/ 4.90	50/ 4.45	100/ 4.15
6522 VIA	6.45	10/ 6.10	50/ 5.75	100/ 5.45
6532	7.90	10/ 7.40	50/ 7.00	100/ 6.60
2114-L200		2.45	25/ 2.30	100/ 2.15
2716 EPROM		4.90	5/ 4.50	10/ 4.00
2532 EPROM		7.90	5/ 7.45	10/ 6.90
6116 2Kx8 CMOS RAM		7.80	5/ 7.45	10/ 6.90
4116 RAM				8 for 14
Zero Insertion Force 24 pin Socket (Scanbel)				2.00

## Hewlett Packard

Write or call for prices.



## Anchor Automation Signalman Modems



## FREE SOURCE MEMBERSHIP WITH SIGNALMAN

All Signalman Modems are Direct Connect, and include cables to connect to your computer and to the telephone. Signalman Modems provide the best price-performance values, and start at less than \$100. Dealer and OEM inquiries invited.

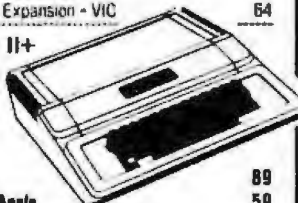
Mark I RS232	(99)	79
Mark II for Atari 850	(99)	79
Mark IV for CBM/PET with software	(189)	119
Mark V for Osborne (software available)	(129)	93
Mark VI for IBM Personal Computer	(279)	195
Mark VII Auto Dial/Auto Answer	(179)	119
Mark VII Bell 212 Auto Dial/Answer	(399)	319

DC HAYES Smartmodem	219
DC Hayes Smartmodem 1200	545



Apple Emulator for Commodore 64	89
Screenmaker 80 COLUMN CARD for C64	155
Solid Oak 2 Level Stand for C64 or VIC	29
C64/VIC Switch (networking)	135
BACKUP V1.0 tape copier for C64 or VIC	20
CARDBOARD/6 Motherboard - VIC	79
CARDAPTER/1 Atari VCS Adapter - VIC	69
CARDPRINT Printer Interface - C64/VIC	64
CARDBOARD/3s Motherboard - VIC	32
CARDETTE/1 Cassette Interface - C64/VIC	32
CARDRITER Lightpen - C64/VIC	32
CARDRAM/16 RAM Expansion - VIC	64

We carry Apple II+ from Bell & Howell



Apple Emulator for Commodore 64	89
16K RAM Card for Apple	59
Solid Oak 2 Level Stand for Apple	29
Super Serial Card	149
Thunderclock Plus	119
Z80 Softcard and CP/M (Microsoft)	235
Parallel Printer Interface/Cable	79
Apple Dumping (Microtek) Printer Interface	115
Apple Dumping with 16K Buffer	160
Grappler + Interface	140
TG Products for Apple in stock	
DC Hayes Micromodem II	299
Vindex 80 Column Card	239
Hayden Software for Apple 20% OFF	
PE Writer Word Processor	120

# Commodore

See us for Personal, Business, and Educational requirements. Educational Discounts available.

## PETSCAN \$245 base price

Allows you to connect up to 30 CBM/PET Computers to shared disk drives and printers. Completely transparent to the user. Perfect for schools or multiple word processing configurations. Base configuration supports 2 computers. Additional computer hookups \$100 each.

## Commodore COMMUNICATES!

## COMPACT \$115

Intelligent Terminal Package includes ACIA hardware based interface, DB25 Cable and STCP Software with remote telemetry, transfer to/from disk, printer output, XON-XOFF control, user program control, status line.

## VE-2 IEEE to Parallel Interface 110

Includes case, power supply, full 8-bit transmission, and switch selectable character conversion to ASCII.

VIC 20 Products		VIC Sargon (f Chess)	32
BACKUP V1.0	20	VIC 808F	32
VIC RAM Cards (in stock)		Meteor Run (UMI)	39
VIC SuperExpander	53	VIC Radar Retroco	24
VIC 16K RAM	69	Amek (UMI)	20
Thorn EMI Software		Snakman	15
NES Software		Rubik's Cube	13
VIC Omega Race	32	Programmers Reference 15	15
Spiders of Mars (UMI)	39	Renaissance (UMI)	39
Programmers Aid	45	VIC Adventure Series	
		VICTORY Software for VIC and C64	
Street Sweepers	12	Maze in 3-D	12
Night Rider	11	Cosmic Debris	12
Treasures of Bat Cave	12	Grave Robbers Advent.	11
Games Pack I	12	Games Pack II	12
Victory Casino	8	Adventure Pack I	12
Adventure Pack II	12	Trak	11

Commodore 64 Programmers Reference Guide	17
Computer's First Book of PET/CBM	17
POWER ROM Utilities for PET/CBM	78
WordPro 3+ - 32K CBM, disk, printer	195
WordPro 3+/64	69
WordPro 4+ - 8032 disk, printer	300
SPELLMASTER spelling checker for WordPro	170
VISICALC for PET, ATARI, or Apple	190
PETRIX PET to Epson Graphics Software	40
SM-KIT enhanced PET/CBM ROM UTILITIES	35
Programmers Toolkit - PET ROM Utilities	35
Branding Iron EPROM Programmer for CBM	75
PET Spacemaker II ROM Switch	36
2 Meter PET to IEEE or IEEE to IEEE Cable	40
Dust Cover for PET, CBM, 4040, or 8050	8
VIC or C64 Parallel Printer Interface	64
CmC IEEE-RS232 Printer Interface - PET	120
SAD! Intelligent IEEE-RS232 or parallel	235
ZRAM - CBM 64K RAM, Z80, CP/M	550
Programming the PET/CBM (Computer) - R. West	20
Computer's First Book of VIC	11
Whole PET Catalog (Midnight Gazette)	8
Color Chart Video Board for PET	125
PET Fun and Games (Cursor)	11
Disk ICU - Disk Recovery System for PET/CBM	40
Copy-Writer Word Processor for C64, PET/CBM	70

## FlexFile for PET CBM, C64 \$110

Database, Report Writer with Calculations, Mailing Lists	
FBNTH for PET full FIG model - Cargill/Riley	\$50
Metacompiler for FORTH for independent object code	30
XMMRM PASCAL for PET/CBM/C64	85
EARL for PET/CBM Disk-based ASSEMBLER	85
Super Graphics - BASIC Language Exercises	45
Fast machine language graphics routines for PET/CBM	
RAM/ROM for PET/CBM	4K \$75 8K \$90

## DISK SPECIALS

Scotch (3M) 5" ss/dd	10/ 2.25	50/ 2.10	100/ 2.05
Scotch (3M) 5" ds/dd	10/ 3.15	50/ 2.90	100/ 2.85
Scotch (3M) 8" ss/sd	10/ 2.40	50/ 2.20	100/ 2.15
Scotch (3M) 8" ss/dd	10/ 2.95	50/ 2.70	100/ 2.65

## We stock VERBATIM DISKS

Write for Dealer and OEM prices.

BASF 5" or 8"	10/ 2.00	20/ 1.95	100/ 1.85
NEW BASF Qualimetric Disks also in stock.			
Wabash 5" ss/sd	10/ 1.80	50/ 1.75	100/ 1.70
Wabash 5" ss/dd	10/ 2.00	50/ 1.95	100/ 1.90
Wabash 8" ss/sd	10/ 2.00	50/ 1.95	100/ 1.90

## We stock MAXELL DISKS

Write for dealer and OEM prices.

Disk Storage Pages	10 for \$5	Hub Rings 50 for \$6
Disk Library Cases	8"-3.00	5"-2.25
Head Cleaning Kits	11	

## CASSETTES—AGFA PE-611 PREMIUM

High output, low noise, 5 screw housings.	
C-10	10/ 61 50/ 58 100/ 50
C-30	10/ 85 50/ 82 100/ 70

## SPECIALS

Zenith ZVM-121 Green Phosphor Monitor	100
BMC 12A 12" Green Monitor	80
VDTRAX Personal Speech System	280
VDTRAX Type-N-Talk	160
VOICE BOX Speech Synthesizer (Apple or Atari)	
Prowriter 8510 parallel	369
Okidata 92	520
Daisywriter 2000	1050
Many printers available (Star-Gemini, Brother, OKI, etc.)	
We stock AMDEK Monitors	
Amdek DXY-100 Plotter	600
A P Products	15% OFF
Watanabe Intelligent Plotter 990	6-pen 1290
ISOBAR 4 Output Surge Suppressor/Noise Filter	49
We stock Electrohome Monitors	
dBASE II (8" format)	300
Panasonic TR-120M1P 12" Monitor (20 MHz)	149
Panasonic CT-160 Dual Mode Color Monitor	285

USI Video Monitors—Green or AMBER 20 MHz N- rez. Dealer and OEM inquiries invited.

## ALL BOOK and SOFTWARE PRICES DISCOUNTED

Synertek SYM-1 Microcomputer	SALE 189
KTM-2/80 Synertek Video and Keyboard	349

## ZENITH data systems

Z29 Terminal (now detached keyboard)	680
ZT-1 Intelligent Communications Terminal with Monitor	479
Z100 16-bit/8-bit System	CALL

We stock entire Zenith line



## ATARI SPECIALS

## WE STOCK ENTIRE LINE—write for prices.

Atari 1200	749	OIX	34
Voice Box	100	Anchor Modem—Atari	79
Inside Atari DOS	18	Atari Graphics (Computer)	11
Thorn EMI Software		First Book of Atari	11
EduFun Software		APX Software	

## WRITE FOR CATALOG

Add \$1.25 per order for shipping. We pay balance of UPS surface charges on all prepaid orders. Prices listed are on cash discount basis. Regular prices slightly higher. Prices subject to change.

252 Bethlehem Pike Colmar, PA 18915 215-822-7727 **A B Computers**



**\$99 SINGLE BOARD  
COMPUTER/CONTROLLER**



**MODEL MCG-85 FEATURES:**

- 8085A CPU
- 2K System Monitor ROM
- 256 Bytes of RAM
- RS232C Port
- Parallel & Serial I/O
- Two 8 Bit Prog Ports
- One 6 Bit Prog Port
- 1 1/2 x 6 1/2 PCB
- Automatic Baud Rate
- 5 Interrupts
- 14 Bit Counter/Timer
- Onboard Prototyping
- 6.144 MHz Crystal
- Onboard Expansion
- 4K ROM &/or
- 4K RAM or CMOS RAM

**STOCK \$99 Kit \$135 A&T.**  
Expansion Boards available. Visa, M.C., Amex & COD accepted.

**ATLANTIS COMPUTERS**  
31-14 Broadway  
Astoria, N.Y. 11106  
212/728-6700

Circle 59 on Inquiry card.

**ELECTRONIC  
COMPONENTS**



**FREE CATALOG**  
156 PAGE

**MANUFACTURERS OF QUALITY  
ELECTRONIC COMPONENTS**

**WE STOCK What We Catalog!**

**MOUSER ELECTRONICS**  
11433 WOODSIDE AVE SANTEE, CA 92071  
PHONE (619) 449-2222 TWX 910-331-1175

Circle 318 on Inquiry card.

**DISK DRIVES**

(For PC, Mod I & III)

TANDON TM100-1	\$189
TANDON TM100-2	\$249
TANDON TM100-4	\$339
Case and PS	\$ 45

**PC EXPANSIONS**

**MAYNARD**  
DISK CONTROLLER ..... \$155  
PP add \$50 SP add \$70  
All cables, hardware and instructions included - no soldering.

**QUADRAM**  
Four Function 256K capacity  
with 64K installed ..... \$399

**AST**  
ComboPlus:  
64K+SPC+SuperDrive  
+SuperSpool ..... \$395  
MegaPlus:  
64K+SC+SuperDrive  
+SuperSpool ..... \$395  
User installed.  
2nd S, or P ..... \$ 35

**VLM Computer Electronics**  
10 Park Place • Morristown, NJ 07960  
(201) 267-3268 Visa, MC, Check or COD

Circle 478 on inquiry card.



**Scotch**  
DISKETTES

Call Toll-Free  
1-800-328-DISC for prices and information. Dealer inquiries invited. C.O.D. and charge cards accepted. All orders shipped from stock, within 24 hours. Call toll FREE



**North Hills Corporation**  
3564 Rolling View Dr.  
White Bear Lake, MN 55110  
1-800-328-DISC  
MN Call Collect 1-612-770-0488

Circle 329 on Inquiry card.

**ULTRA-RES (1) GRAPHICS**

- \*IEEE-696 S/100 Monochrome \$495.00 (2)  
-512 x 512 Pixel  
-Single Board
- \*IEEE-696 S/100 Monochrome \$695.00 (2)  
-1024 x 1024 Pixel  
-Expandable to 8 x 1024 x 1024 Pixel
- \*IEEE-696 S/100 Eight Color \$1250.00 (2)  
-3 x 512 x 512 Pixel  
-8 Color RGB TTL  
-2 Board System
- \*MultiBus (3) Eight Color \$1995.00 (2)  
-3 x 1024 x 1024 Pixel  
-8 Color RGB TTL  
-Single Board
- \*IBM PC Monochrome \$695.00 (2)  
-1024 x 1024 Pixel  
-Expandable to 8 x 1024 x 1024

FEATURES INCLUDE—Software Drivers, Hardware Zoom, Programmable Display Resolution, Windowing, Multi-Controller Capability, NEC UPD7220 Graphic Controller.

- 1) ULTRA-RES Trademark CSD Incorporated
- 2) Sterling Prices
- 3) MultiBus Trademark Intel Corporation

**C.S.D. Incorporated**  
P.O. Box 253 Sudbury, Massachusetts 01778  
(617) 443-2750

Circle 84 on Inquiry card.

**DISKETTES  
3M Scotch BRAND**

**AT SUPER LOW PRICES  
WE WILL SHIP YOUR  
ORDER WITHIN 24 HOURS  
AND WE PAY THE  
SHIPPING CHARGES**



DEALER INQUIRIES INVITED

**CALL TOLL FREE  
800 922-8193**

IN CALIFORNIA  
800 468-1068



Tayco Business Forms  
Computer Supplies  
Post Office Box 605  
Newbury Park, CA 91320

Circle 440 on inquiry card.



**DIET MONITOR**

—for the IBM PC (and soon to be released for APPLE 2)  
**IS THE MOST SOPHISTICATED  
NUTRITIONAL ANALYSIS SYSTEM  
AVAILABLE.**

- \* comes with over 750 foods and 28 important nutrients.
- \* Menu driven. Gives you 6 easy to read analysis reports, including graphs and recommendations on how to improve your diet.
- \* versions for professional use and home use. Home version available for \$69.00

**CALL: CAMRASS CORPORATION (201) 328-8917**  
WRITE: P.O. BOX 118, BOONTON, N.J.  
Master/visa, check or C.O.D.

Circle 87 on Inquiry card.

Serial ← ||||| → Parallel



**Convert What You Have  
To What You Want!**

- RS232 Serial
- 8 Reed Relays
- Latched Outputs
- Centronics Parallel
- Handshaking Signals
- Compact 3 1/2 x 4 1/2 x 1 1/2

No longer will your peripheral choices be limited by the type of port you have available! Our new High Performance 700 Series Converters provide the missing link. Based on the latest in CMOS technology, these units feature full board rate selection to 18.2K, with handshaking signals to maximize transfer efficiency. Detailed documentation allows simplified installation. Order the Model 770 (SerPar) or Model 775 (ParSer) Today!

Buyer Products Company (800) 487-1865  
1521 1/2 Pine Street  
Post Office Box 2233  
Oxnard, California 93020  
only \$89.00  
Company Order #1000  
CA Residents 4% tax  
UPS Shipping \$3.00  
**CALL (805) 487-1865 or 487-1868**  
For FAST Delivery

Circle 192 on Inquiry card.

**FREE! FREE! FREE! FREE! FREE!**

**SEND FOR OUR NEW  
1983  
PARTS CATALOG**  
THOUSANDS OF  
SURPLUS ELECTRONIC  
PARTS, SUPPLIES AND  
DEVICES.  
**ALL ELECTRONICS CORP.**  
905 S. Vermont Ave.  
P.O. Box 20406  
Los Angeles, Cal. 90006

Circle 23 on Inquiry card.

# CHECK OUR NEW ★ LOW PRICES ★

## Apple Compatible Products



**FD-1 Floppy Disk Controller . . . \$99.95**  
Runs DOS 3.3 with any standard Shugart compatible 5 1/4" Disk Drive. (2 Drives Each Card)



**ASCII KEYBOARD A&T . . . \$99.00**  
Plug in compatible with Apple II, has shiftlock, under score, { } and back slash characters.

**SUN-722 Apple Prototype Board . . . \$13.75**  
Double Sided with gold contacts, holes drilled on .15" x .1" centers.

**ALS 280 CPU Card w/CP/M & manuals . . \$149.00**  
**280 CP/M card kit w/o manual or software . . \$4.00**  
**ALS 80 Column Video Card w/manuals . . . \$159.00**  
**80 Column Video Card w/o manual, compatible w/ Videx . . . \$98.00**  
**16K RAM Card Kit . . . \$42.00**  
**AP-II Mother Board (Apple Compatible) . . \$84.00**  
**AP-II Computer Case (Apple look-alike) . . \$119.00**  
**5A Switching Power Supply (voltage & size Apple Compatible) . . . \$133.00**  
**Parallel Interface Card (Centronics comp.) . . \$44.99**

## New for IBM PC

**PCM1 64K Memory Card, Expand. to 256K w/Parity Check . . . \$259.00**  
**PCM2 256K Memory Card, Expand. to 512K w/Parity Check . . . \$569.00**  
**PCM1+SIO PCM1 64K Card w/(1) Async Serial Port . . . \$319.00**  
**PCM1 PIO PCM1 64K Card w/(1) Centronics Parallel Port . . . \$309.00**  
**PC-DUAL I/O (2) Serial RS232 Ports, (2) IBM PC Compatible Ports and Real Time Clock w/Batt. Backup . . . \$189.00**

### ★ SPECIAL ★

**PCM1-DUAL I/O Includes both PCM1 64K and PCM-I/O cards . . . \$399.00**

## Diskettes and Storage Cases

**5 1/4" SS/DD Wabash 40 track w/hub rings . . \$24.00**  
**8" SS/DD Soft with Library Case . . . \$26.00**  
**8" DS/DD Soft Memorex, Box of 10 . . . \$44.99**  
**5 1/4" Case for 40 Disks . . . \$24.99**  
**8" Case for 40 Disks . . . \$36.99**  
**5 1/4" Case for 90 Disks . . . \$41.99**  
**8" Case for 90 Disks . . . \$54.99**

## 64K 6MHz Static RAM/EPROM



**64KSM A&T without RAM . . . \$155.00**  
**64KSM A&T with 64K RAM (32 - 6116's) . . \$339.00**  
S-100 Board Uses 6MHz 6116's, 1/2A max. power, Bank Select plus Extended Addressing allow for multi-memory board set up, 4 Independent 16K Blocks make easy use with multi-user systems, Any 2K RAM may be replaced by 2716 EPROM.

## 256K/1M Byte Dynamic RAM

**256KDM A&T without RAM . . . \$290.00**  
**256KDM A&T with 64K RAM (8-4164s) . . \$340.00**  
**256KDM A&T w/ 256K RAM (32-4164s) . . \$489.00**  
S-100 Board, 4 Banks uses either 64Kx1 or 256Kx1 RAMS. Allows for 64K to 1M Byte RAM on just one S-100 Card. 24 Bit Addressing, Phantom Mode, Error Trap Opt., Parity Check, 4MHz Transparent Refresh, Front Panel Operation. Optional M1 Wait for 6MHz Operation.

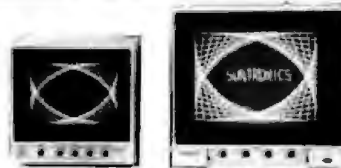
## NEC Computers & Monitors

**We are an Authorized NEC Service Center**  
Call for Official Service Agreement

**PC8001A Keyboard Computer . . . \$789.00**  
**PC8012 I/O Expansion Unit . . . \$499.00**  
**PC8031 Disk Drive Subsystem . . . \$769.00**  
**JC1203RGB 13" Color Monitor . . . \$720.00**  
This Monitor is excellent for use with IBM PC

**JC1203 13" Composite Color Monitor . . . \$349.00**  
**NEC CP/M V2.2 with manuals . . . \$150.00**  
**Select Word Processing Sys with Teach . . \$350.00**  
**NEC Report Mgr for Database Mgmt . . . \$150.00**

## Video Monitors



**SAMWOOD GREEN 8" 18MHz . . . \$121.00**  
**SAMWOOD AMBER 9" 18MHz . . . \$125.00**  
**SAMWOOD GREEN 12" 12MHz . . . \$130.00**  
**SAMWOOD AMBER 12" 12MHz . . . \$134.00**  
Composite video I/O, 780 lines resolution, 75/10K ohm impedance.

## Terminals

**TELEVIDEO 912 . . . \$860.00**  
**TELEVIDEO 925 . . . \$789.00**  
**TELEVIDEO 950 . . . \$996.00**  
**ADDS VIEWPOINT 3A/PLUS . . . \$545.00**

## S-100 Products

**SBC-880 Z80A CPU, A&T . . . \$195.00**  
**SBC-880 Z80A CPU, Kit . . . \$175.00**  
4MHz Z80A CPU Board with Serial/Parallel Ports  
**UFDC-1 Floppy Controller, A&T . . . \$245.00**  
**UFDC-1 Floppy Controller, Kit . . . \$225.00**  
The UFDC-1 Floppy Controller uses the WD1795 chip which runs either and/or 8" 5 1/4" Disk Drives.  
**CLOCK CALENDAR A&T . . . \$115.00**  
**CLOCK CALENDAR Kit . . . \$95.00**  
This S-100 Clock Calendar Board has 4 Interrupts, Time, Day of Week and Battery Backup.  
**SUN-721 S-100 Prototype Board . . . \$17.85**  
Double Sided with gold contacts and holes drilled on .15" x .1" spacing.

## S-100 Computer Systems

**SYSTEM I . . . \$2459.00**  
Z80A CPU with Serial/Parallel Ports, Floppy Disk Controller with Dual 8" SSDD Drives, 64K RAM, CPM, Clock and 1M Byte Storage.

**SYSTEM II . . . \$2659.00**  
Z80A CPU with Serial/Parallel Ports, Floppy Disk Controller with Dual 8" DSDD Drives, 64K RAM, CPM, Clock and 2M Byte Storage.

## S-100 Mainframes 6-12 Slots

**DMF8800T 6 Slot, Dual Thin 8" Drives . . \$699.00**  
**DMF8800 6 Slot, Dual Std. 8" Drives . . \$699.00**  
**DMF5550 6 Slot, Up to 3-5 1/4" Drives . . \$679.00**  
**DMF2200 6, 8, 12, 18, 22 Slot MB . . . Call**  
All Mainframe Power Supplies rated at 8V @ 18A, ±18V @ 23A, 24V @ 5A, 12V @ 5A & 5V @ 5A.  
All cabinets made of strong steel with aluminum covers & incl EMI A/C power filter w/detachable power cord, quiet fan for pos. air pressure (blows dust out, not in), back panel has individual covers with (12) DB25 cutouts, (2) Centronics 36 pin cutouts, (1) 34 pin & (1) 50 pin flat ribbon cutout, (2) A/C convenience outlets (1 switched & 1 unswitched), keyed power, lighted reset switches, & tan cover with black face match most decors.

## Mother Boards & Card Cages

SLOTS	Bare Bd	KIT	A & T	w/CAGE
6	\$12.00	\$34.00	\$49.00	\$74.00
8	16.00	45.00	70.00	105.00
12	22.00	85.00	100.00	140.00

10MHz, No termination Required!

## Printers

**Prowriter 1 C. Itoh, 120cps, Parallel . . . \$455.00**  
**Prowriter 2 C. Itoh, 120cps, Parallel . . . \$689.00**  
**Starwriter C. Itoh, 40cps, Ser/Par . . . \$1369.00**  
**Printmaster C. Itoh, Serial/Parallel . . . \$1529.00**  
**NEC Spinwriters 3500, 5500, 7700 . . . Call**

## Disk Drives

**TM100-1 Tandon 5 1/4" SSDD, 40 track . . \$215.00**  
**TM100-2 Tandon 5 1/4" DSDD, 40 track . . \$289.00**  
**TM100-4 Tandon 5 1/4" DSDD, 80 track . . \$400.00**  
**TM848-1 Tandon 8" Thin Line . . . \$397.00**  
**Mitsubishi 5 1/4" Thin DSDD, 40 track . . \$310.00**  
**Mitsubishi 8" Thin DSDD, 77 track . . . \$450.00**

## EPROMs, RAMs, CPUs, & Misc

P/N	1-7	8 up	P/N	1-7	8 up
2716	\$3.95	\$3.95	8118P-3(150nS)	\$6.10	\$5.75
2732	4.75	4.40	2114L-2(200nS)	1.82	1.62
2532	7.85	5.95	4164	6.25	6.25
2764	9.95	9.95	Z80A CPU	5.29	5.29



**SUNTRONICS CO., INC.**

12621 Crenshaw Blvd., Hawthorne, CA 90250

STORE HOURS: MON-FRI 9:00am to 8:00pm  
SATURDAY 10:00am to 5:00pm

CALIFORNIA **213-644-1149**  
(In Tech Info and Call orders)

OUTSIDE CALIFORNIA TOLL FREE **1-800-421-5775**  
(Under Deal Order)

Mail Order—Minimum Order \$10. Send Check or Money Order to: P.O. BOX 1957 Dept. B, HAWTHORNE, CA 90250  
Visa or MasterCard (please include expiration date). Add \$2.00 postage and handling for first 3 pounds plus \$0 for each additional pound to your order. California residents add 6% sales tax.



**SHIELDED DATA CABLES**  
 Comes with 100 on inquiry card  
 Help Protect Your Signals With Shielded Data Cable  
 EIA RS 232 Shielded Cable Specify end gender, length & pin  
 interconnects up to 9 conductors \$11.00 - 40/ft.

**TERMINALS**

Manufacturer	Description	Unit Price	Box Price
Mazettec	— Equil Systems		
ESPRIT I	Full featured terminal w/green screen	\$595	\$489
ESPRIT II	Terminal w/detachable keyboard	\$645	\$565
ESPRIT III	Teletype 950 emulator	\$895	\$775

**LOW SPEED MODEMS**

As Modem  
 Novation "Includes FREE Subscription To The SOURCE"  
 J-CAT 0-300 baud Direct connect modem \$149 \$120  
 ACOUSTIC 0-300 baud Acoustic connect modem \$189 \$135  
 AUTOCAT 0-300 baud Direct connect modem \$249 \$189  
 103 SMARTCAT 0-300 baud auto ans. modem \$249 \$189

**HIGH SPEED MODEMS**

103/212 SMARTCAT 0-300/1200 baud modem \$595 \$449  
 212/AUTOCAT 0-300 baud/1200 baud modem \$695 \$565

**UNIVERSAL DATA SYSTEMS**

212LP Telex powered 1200 baud modem \$495 \$395

**PRINTERS**

OKI-DATA AL82A 9 1/2" carriage 120 cps printer \$649 \$399  
 AL83A 15" carriage 120 cps printer \$695 \$650  
 AL82P (parallel) 9 1/2" carriage near letter quality \$699 \$325  
 AL83P (parallel) 9 1/2" carriage near letter quality \$799 \$399  
 AL83P (parallel) 15" carriage near letter quality \$1249 \$888  
 AL93S (serial) 15" carriage near letter quality \$1349 \$989  
 Tractor for AL 82/82 \$50

Some price may vary. E.O.D. as USA and MasterCard Add 15.00 per order for postage and handling - Add \$10.00 per shipment. An inquiry to U.S. Serial Machine Corporation and its sales line 1-800-361-Carriers Michigan 48024

**ELECTROSONICS**  
 P.O. Box 1141 • MI Clemens, MI 48044 • (313) 286-8969  
 Monday-Friday 9 a.m. - 5 p.m. EST • Saturday 'til Noon

Circle 188, 189 on Inquiry card.

**PConnection**  
 Three functions in one card slot—  
 Modem, Calendar clock, Serial port!

The PConnection is a premium telecommunication's card for the IBM PC with a direct connect Bell 103/113 modem, a real time clock, and a serial I/O port for expanded communications capabilities. The PConnection gives you all three functions in a single card slot!

The PConnection has autodial (Touch Tone or pulse) and autoanswer, plus a built-in speaker for time status monitoring. Software selectable protocol and modes.

The real time clock can be used to autodial predetermined phone numbers at preset times. Excellent for polling and remote monitoring applications.

PConnection (plug-in modem) - \$275 Enhanced PConnection with real time clock and additional RS-232 \$375 Another quality modem from

*the microperipherals corporation*  
 2565 152nd Avenue N.E.  
 Redmond, WA 98052  
 (206) 881-7544

IBM is a registered trademark of International Business Machines Corporation

Circle 308 on Inquiry card.

**wabash®**

When it comes to  
**Flexible Disks, nobody  
 does it better than  
 Wabash.**

MasterCard, Visa Accepted.  
 Call Free: (800) 235-4137



**PACIFIC EXCHANGES**  
 100 Foothill Blvd  
 San Luis Obispo, CA  
 93401 (In Cal call  
 (805) 543-1037)

Circle 347 on Inquiry card.

**NEW!** The Apple users group software library bonanza at truly affordable prices. For the first time enjoy your Apple to its fullest capacity using specially packed disks with over 60 outstanding programs each. Not available from any other source!

• Applesoft • 3.3 DOS

**APPLEWARE INC.** offers an extensive variety of interesting, useful and entertaining programs indispensable to the serious computerist including:

Business	Educational	Graphics
Games	Music	Science
Utilities	Data Base	Finance

Library disks 1, 2 & 3 are mixed categories and new disks 4 (Games), 5 (Utilities), 6 (Graphics) & 7 (Integer) at \$59.95 each. Why pay more?

Order direct from this ad and Save up to \$136. Buy disk library package 1, 2 & 3 and get a special bonus disk FREE — over 200 programs for \$179.95 + shipping. For best value, get all 8 disks for \$349, postage prepaid, for over \$30 of our best programs at 65¢ each! Call now toll free: 1-800-327-8864  
 Florida: 1-305-987-8865  
 6400 Hayes St  
 Hollywood, FL 33024



Circle 42 on Inquiry card.

**HOW TO REPAIR THE APPLE\***

A comprehensive guide to repair your Apple II\* or Apple II plus\* computer

With repair rates soaring and outrageous repair bills being charged for even simple repairs, THIS GUIDE CAN SAVE YOU MONEY!

**ONLY \$39.95**

**DATA-LINE (602) 820-0082**  
 2961 S. LAS PALMAS  
 MESA, ARIZONA 85202

\*Trademark of APPLE COMPUTER INC.

Circle 153 on Inquiry card.

**8087 SUPPORT**

For the  
**IBMPC and CP/M-86.**

8087 CHIP.... CALL  
**APPLICATIONS**

FFTs..... \$75  
 MATRIXPAK..... \$75

87/88 GUIDE VOLUME I... \$19.95

**LANGUAGE SUPPORT**

87MACRO™	\$150
87BASIC™	\$150
87PASCAL™	\$150
87FORTRAN™	\$150

IBM Personal Computer is a registered trademark of IBM Corp. CP/M-86 is a trademark of Digital Research, Inc. 8087 is a trademark of Intel Corp. 87-BASIC, 87MACRO, 87BASIC, 87PASCAL, 87FORTRAN and MacroWare are trademarks of MacroWare Inc.

**MicroWare**  
 P.O. Box 79  
 Kingston, MA  
 02364  
 (617) 746-7341

Circle 311 on Inquiry card.

**Electronic Circuit Analysis**

- DC and AC analysis
- Very fast, machine language
- Infinite circuits on multiple passes
- Worst case, sensitivity analysis
- Dynamic modification
- 64 Nodes, 127 branches
- Compare circuits
- Log or linear sweep
- Full file handling
- Frequency response, magnitude and phase
- Complete manual with examples
- TRS-80 (TRS-DOS) \$90.00
- CP/M \$150.00

**Tatum Labs**  
 P.O. Box 722  
 Hawleyville, CT  
 06440  
 (803) 426-2184

Circle 439 on Inquiry card.

**NEW IBM® PC SOFTWARE**

**ONLY \$68 FOR ALL THREE!!**

**PERSONALPAC™:** 3 menu-driven "user friendly" time savers.

**BILLTIME:** Program expense categories w/o programming experience. Easily add, delete, update bills. Sort several ways.

**BANKBAL:** Reconcile checkbook fast! Flexible and handles all types of income and expenses.

**APPTCAL:** Keep track of all engagements. Easily add, delete, update, and list appointments.

**USE AT HOME OR AT THE OFFICE**  
 Sold on PC DOS-formatted diskette. Send check, money order or C.O.D. to:

**SEARS ELECTRONICS INC.**  
 "time saving software designers"  
 Tirrell Hill, Goffstown, NH 03045  
 (603) 497-3074

Circle 408 on Inquiry card.

**BASF FlexyDisks®**

**5 1/4"**  
 Specify soft.  
 10 or 16 sector

	Price/10	Price/100
1 side/double density	\$20.00	\$185.00
2 sided/double density	34.50	325.00

**8"** Specify soft or 32 sector

	Price/10	Price/100
1 side/single density	\$21.00	\$195.00
1 side/double density	29.50	275.00
2 sided/double density	34.50	325.00

Certified Check - Money Order - Personal Check Allow up to 2 weeks for personal checks to clear. Add \$3.00 to each order for U.S. shipping charges. NJ Residents add 6% NJ Sales Tax

**DATA EXCHANGE, INC.**  
 280 Dukas Parkway, P.O. Box 85  
 Somerville, N.J. 08876 • (201) 725-6680  
 Dealer Inquiries Invited

Circle 149 on Inquiry card.

## SIEMENS 1 MEGABYTE

8" Double Sided/Double Density

1-\$299.00 ea.\*

2-\$289.00\* 10-\$269.00\*

FDD200-8  
Floppy  
Disk Drive  
Shugart  
Compatible



Shipping Wgt.  
15 lbs.  
Factory New  
and Packaged

Fully Guaranteed  
90 Day Warranty  
Service  
Contracts  
Available  
Full  
Documentation

## DUAL DOUBLE SIDED 8" SUBSYSTEM ASSEMBLED & TESTED \$850.00 complete

### Includes:

2-Siemens, FDD200-8 Disk Drives Strong, Thick, Aluminum Cabinet, Rugged Heavy Duty Power Supply, Whisper Quiet 4" Fan, Etc.

## MONTHLY SPECIAL — \$279.00 Communications Text Storage System ASC II 8 Level (RS-232/EIA)

5 Level Baudot — CL or TTL also available

- Auto Disk Data Handler
- File Based Text Storage w/Full Directory
- Std. Connection between Comm. Cir. & Data Terminal
- Built in File Text Editor
- Local or Remote Control for Read/Write

### INCLUDES:

5 1/4" Min-Disk Drive (SA400)  
Self Contained Power Supply 115 VAC  
Micro Processor & Disk Controller w/Perm. Program  
Std. Communications Interface w/Selectable Data Rate  
Operating Manual With Commands



## KEYBOARD by KEYTRONIC \$14.95 each

66 Keys Unencoded, Low Profile, Gold Plated Card Edge Connectors.

## REGULATORS

All 7800 (LM340T) Series	3 for \$2.00
All 7900 (LM320T) Series	3 for \$2.25
LM323k, 5 Volt, 3 Amp.	\$2.95 each
LM350k, Adjustable 3 Amp.	\$4.95 each

## CONNECTORS

50 Pin Edge, ST, for S-100 Bus	\$3.49
34 Pin, Edge, Ribbon for SA400 Drive	\$2.95
50 Pin, Edge, Ribbon for FDD200-8 Drive	\$3.95
50 Pin, RA, PC, MT Amp #206973-1	\$3.49

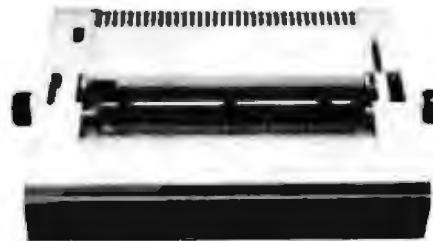
\*Orders accepted by Visa/MasterCharge (add 3%) Money Order or certified check. Price does not include shipping charges. Specify method of shipment desired and include approximate shipping charge. N.J. residents add 5% sales tax.

## QUME 55CPS—HIGH SPEED DAISEY WHEEL LETTER QUALITY PRINTERS

\$950.00 ea.\*

Quantity Pricing Available

Includes Power Supply



Shipping  
Wgt.  
46 lbs.

Proportional Spacing, 2K Buffer, RS-232 and Centronics Parallel

The Qume Sprint 3-55 with Interface is Compatible with most Computers having RS-232 or Centronics Parallel A or B, such as Radio Shack, Apple, IBM, etc. Also works with most popular word processing programs like Micropro™ Wordstar.

These Qume Printers were used by a major typesetting company under maintenance until replaced by laser printers on an exchange basis. We had their technicians refurbish and completely exercise them to give you many years of reliable service at a price you can live with.

## COMPUTER POWER ADAPTOR \$12.95 ea.

In Line Type                      Output: No Load — 14.0 VDC  
Input — 115V 60 Hz              2.0 Amps — 11.5 VDC  
Capacitor Filtered, F.W. Bridge, UL Listed

## SWITCHING POWER SUPPLY \$55.00 ea.

15 Amps @ + 5 VDC Regulated  
3 Amps @ + 12 VDC and — 12 VDC  
Current Protected Fan Cooled, Fused

## CAPACITORS/BRIDGES

.1 uI Monolithic	100 for \$12.95
.1 uI Disk	100 for \$6.95
25 Amp 400 Volt	3 for \$4.95
10 Amp 200 Volt	3 for \$2.95

## ELECTRONIC TAPE READER Decitek Model 26167-002 \$24.95

Includes Stepper Motor & Electronics

## OPTO DEVICES

4N26 (Trans. Out.) — \$89	T1L31 (Infra. Red. Em.) — \$59
MCA2-55 (Darlington) — \$99	ILD-74
H11AX (Trans. Out.) — \$89	(Dual Trans. Out.) — \$1.99 ea.
H11CX (SCR Out.) — \$99	

### LED'S

Red - all sizes — 10 for \$89  
Green or Yellow — 5 for \$89  
Micro Red — 100 for \$5.95  
Panel Mounts — 10 for \$59

### DISPLAYS:

HP5082-7340 — \$5.95 ea.  
Hexidecimal  
FND560 & 567 — \$1.49 ea.

## HOBB-Y-TRONIX, INC.

Division of Tape Industries, Inc.

957 Ball Ave., Union, N.J. 07083  
(201) 687-1330



## S-100 COLOR GRAPHICS! MICROSPRITE

THE STATE-OF-THE-ART COLOR GRAPHICS BOARD FOR THE S-100 BUS.

- Display consists of backdrop and pattern planes plus 32 sprite planes
- Each pixel in a plane can be colored or can be transparent to reveal the underlying planes!
- Prioritized planes eliminate the need for hidden object routines in applications requiring 3D simulation
- Sprites are moved on screen by changing two-byte pointers thus simplifying animation applications
- Up to 15 colors or 8 gray levels with a resolution of 256 pixels horizontally and 192 pixels vertically
- Standard NTSC video output connects directly to color monitor or to RF modulator for use with regular color receiver
- One text and three graphics display modes
- On-board 16K byte display RAM separate from system RAM
- High quality PC board with solder masks, silkscreen and gold plated contact fingers
- Meets or exceeds all aspects of IEEE-696 (S-100) standard
- Documentation includes comprehensive user's manual with demonstration programs and Texas Instrument's manual for the new TMS9918A Video Display Processor used on the board
- Typical applications include business graphics, industrial process monitoring, drafting/design aid, educational systems and video game development.

**\$249.95**  
Assembled & tested

**MicroDynamics**

Corporation

PO Box 17577  
Memphis TN 38117  
(601) 755-0619

We pay UPS ground shipping in the continental U.S. UPS air add \$2.00 CDD add \$1.50 Foreign add \$15.00 TN residents add 6% sales tax. VISA & MASTERCARD welcome

## APPLE II COMPATIBLE DISK DRIVES

ONLY..... \$239.00  
CONTROLLER CARD..... \$ 75.00  
JUST PLUG IN AND RUN

### VERBATIM

5 1/4" DISKETTES SS DD SOFT  
PER BOX OF 10..... \$23.99

### EPSON PRINTERS

MX80FT..... \$463.00  
OTHER MODELS..... CALL

### TELEVIDEO

910..... \$559.00  
925..... \$719.00  
950..... \$929.00

### MONITORS

12" 20 MHz  
GREEN..... \$129.00  
AMBER..... \$129.00

### IBM PERSONAL COMPUTER COMPATIBLE SYSTEM SUPPORT CARD + MEMORY

64K..... \$429.00

MAIL ORDER: P.O. BOX D  
SANTA CLARA, CA 95055  
(408) 988-7508

PRICES SUBJECT TO CHANGE. CALL FOR OUR PRICES  
SUBJECT TO AVAILABILITY ON HAND.

# maxell®

## Floppy Discs

CALL NOW - TOLL FREE  
1-800-328-DISC

Dealer inquiries invited. C.O.D.'s and charge cards accepted.

All orders shipped from stock, within 24 hours. Call toll FREE.



North Hills Corporation

3564 Rolling View Dr.  
White Bear Lake, MN 55110

1-800-328-DISC

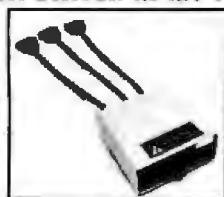
MN Call Collect 1-612-770-0485

Circle 305 on Inquiry card.

Circle 29 on inquiry card.

Circle 330 on Inquiry card.

## DATA SWITCH IN KIT FORM



MODEL 1200 RS-232

Bidirectional Data Switch with 3-2' Extension  
Cables now available in Kit Form

Model 1200 gives the terminal or microprocessor user a second interface for a Printer, Plotter, Modem, Cassette or Tape Drive. It operates at any speed, requires no external power and isolates the two output devices from each other, while providing 2 RS-232 interfaces from the terminal or microprocessor. Built in data cables save money. The Kit consists of 3-RS-232 Male connectors with all pins, switch, cable, pre-drilled Enclosure, all necessary hardware, and assembly instructions. To order: Specify #1200 Kit \$99.50 Assembled & Tested: Specify #1200 \$129.00

CALL Terminal Data Corp.

11878 Coakley Circle, Rockville, MD (301) 881-7655

Circle 449 on Inquiry card.

## compubag™

—the executive carryall



The Compu-bag, the ideal carrying case for your computer accessories. The forward compartment holds box of 10 5 1/4" diskettes. Main compartment—an

8 1/2 X 11 lined with up to 3 inches of materials. Made of high quality calskin, heavy duty zippers and brass findings. Available in: Brown, Black or Burgundy—just \$79.95.

Send your check or money order to:

EMC Distributors  
366 Fifth Avenue  
New York, N.Y. 10001  
Telephone 212-594-6673

dealer inquiries invited

Circle 190 on Inquiry card.

# flexible discs

LOWEST PRICES

wabash

MEMOREX

Scotch

DEALER INQUIRIES INVITED

FOR  
ORDERS  
CALL COLLECT  
(614) 866-3462

datamaster  
A DIVISION OF  
KOP International Corp.  
3145 ZIMMER DR. COLUMBUS, OHIO 43227

Circle 155 on Inquiry card.

## Votrax SC-01A SPEECH SYNTHESIZER

**Votrax** \$50 Each

Order in Ones or Thousands

The SC-01A Speech Synthesizer is a completely self-contained solid state device. This single chip phonetically synthesizes continuous speech of unlimited vocabulary.

The SC-01A contains 64 different phonemes which are accessed by a 6-bit code. Computer interfaces and text-to-speech algorithms also available for product development.

Votrax is a trademark of Federal Screw Works

Call 1-800-645-3479, in N.Y. 1-516-374-6793

MICROMINT INC.

917 Midway  
Woodmere, N.Y. 11598



Call for quantity pricing.

Circle 433 on Inquiry card.

## COMPUTER SUPPLIES FOR ALL MAKES & MODELS

### DISKETTES

• MEMOREX • WABASH

5 1/4" S/S D/D  
MIN. ORDER 50 **\$237**

### RIBBONS

EPSON **\$464**  
MX70/MX80  
EPSON **\$784**  
MX100  
MIN. ORDER 8

LABELS • CONTINUOUS FORMS

CALL TOLL FREE 1-800-248-2418  
IN N.Y. STATE (212) 967-3433

TERMS - VISA OR MC  
DEALER INQUIRIES INVITED

**WORLDWIDE  
COMPUTER SUPPLIES**  
159 MAIN ST., S.I., N.Y. 10307

Circle 489 on Inquiry card.

## Expand Your

Network Capabilities



With the new ASCI Four Port intelligent switch all your RS-232C networking problems can be solved. Whenever your switching applications the ASCI switch allows you to switch with ease. Because the switch is intelligent it allows you to change between peripherals from your keyboard. The code can even be imbedded in your text. When you consider the time you saved due to the simplicity of installation, the elimination of extra cabling and the exclusion of knob turning the ASCI Four Port intelligent switch is the perfect way to expand your net working capabilities.



Advanced Systems Concepts, Inc.  
P.O. BOX 0 • ALTADENA CALIFORNIA 91704  
(213) 793-8971

Circle 19 on Inquiry card.

# BASIS 108

APPLE COMPATIBLE  
COMPUTER  
CALL FOR LOWEST PRICE

# OKIDATA

82A 83 84 92 93

CALL FOR LOWEST PRICES

# Legend Industries

128K RAM CARD  
WITH VIDEX MEM EXP 80  
**\$359<sup>00</sup>**



APPLE COMPATIBLE  
COMPUTER  
CALL FOR LOWEST PRICE



## POWER STRIP

W/SURGE  
PROTECTION  
**\$25<sup>00</sup>**

## SMITH-CORONA TP-1



LETTER QUALITY  
DAISY WHEEL  
**\$575<sup>00</sup>**

## SOFTWARE

WE HAVE IT ALL!  
OVER 500 TITLES

IBM • APPLE • CP/M  
PARTIAL LISTING

ARCADE MACHINE	35.00
AZTEC	29.00
BEAGLE BROS:	
APPLE MECHANIC	22.00
DOS BOSS	17.50
FLEX TEXT	22.00
PRONTO DOS	15.00
TIP DISK #1	15.00
UTILITY CITY	22.00
BPI, GL, AR, INV	299.00
EDUWARE	\$CALL
HOME ACCOUNTANT	55.00
HOME ACCT (IBM)	109.00
INFOSTAR 8"	289.00
LEARNING COMPANY	\$CALL
PEACHTREE	\$CALL
PIG PEN (Apple & IBM)	21.00
SNACK ATTACK	21.00
SPINNAKER (For children)	\$CALL
THIEF	21.00
TUBEWAY	25.00
WORD HANDLER	129.00
WORD STAR (Any format)	289.00
ZORK I, II, III (Apple & IBM)	27.00
ZORK I, II, III (8" CPM)	35.00

## HARDWARE

WE CARRY MOST  
PRODUCTS. PLEASE  
CALL IF NOT LISTED

PARTIAL LISTING

APPLE PADDLES	15.00
FLIP 'N' FILE	20.00
LIBRARY CASE	2.50
GRAFTRAX PLUS	55.00
MICROSOFT 16K RAMCARD	59.00
WILDCARD	119.00
MX-PLUS (Fingerprint)	45.00
SMARTMODEM (300)	229.00
SMARTMODEM (1200)	\$CALL
MICROMODEM II	269.00
QUENTIN DRIVES	\$CALL
MICRO SCI DRIVES	\$CALL
C-TOUCH 8510 PRINTER	459.00
GEMINI 10 PRINTER	399.00
GEMINI 15 PRINTER	599.00
MICROBUFFER 16K	139.00
MICROBUFFER (IN LINE)	
32K PARALLEL	245.00
64K PARALLEL	299.00
WIZARD SOB 16K	209.00
WIZARD BPO 16K	149.00
PKASO	149.00
CORVUS	\$CALL

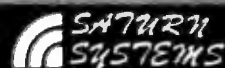


## IBM-APPLE II- APPLE III

Visilink (Apple)	179.00
Visicalc (IBM or Apple)	179.00
Desktop Plan II (Apple)	179.00
Desktop Plan (IBM)	249.00
Visidex (IBM or Apple)	179.00
Visifile (Apple)	179.00
Visifile (IBM)	249.00
Visiplot (Apple)	145.00
Visischedule (Apple)	229.00
Visiterm (Apple)	75.00
Visitrend/Plot (Apple)	229.00

## 16K RAM CARD

Compatible with  
DOS 3.3, CP/M  
Visicalc, PASCAL  
2 YR. WARRANTY **\$39<sup>00</sup>**



64K **\$319<sup>00</sup>**  
128K **459<sup>00</sup>**  
V-C Expand 80 **99<sup>00</sup>**

## Mountain Computer

CPS Card	159.00
Mtn Cables	\$CALL
Ramplus-32K	145.00
Rom Writer	145.00
Clock	195.00
Music System	299.00
Super Talker	149.00
Expansion Chassis	559.00
Card Reader	\$CALL
A/D-D/A	269.00
Visicalc Expander	65.00



## MICROFAZER QUADBOARD QUAD 512+

## Verbatim

5 1/4" (10) SS/DD	\$25.95
5 1/4" (100) SS/DD	239.00
8" (10) SS/DD	39.00
8" (10) DS/DD	45.00

## KENSINGTON MICROWARE



### SYSTEM SAVER

- Surge Suppression
- Dual Outlet
- U.L. Listed
- Fits Apple Stand

**\$65**

## TG Products

PADDLES (Apple II & IIe)	\$29 <sup>00</sup>
JOYSTICK (Apple II & IIe)	40 <sup>00</sup>
JOYSTICK (Apple III & IBM)	45 <sup>00</sup>
SELECT-A-PCRT (Apple II & IIe)	47 <sup>00</sup>
TRAKBALL (Apple II & IIe)	49 <sup>00</sup>

## KRAFT SYSTEMS

PADDLES (Apple II & IIe)	\$39 <sup>00</sup>
JOYSTICK (Apple II, IBM TRS-80)	47 <sup>00</sup>
JOYSTICK (Atari, Commodore)	15 <sup>00</sup>
QUICK VIS (Apple II & IIe)	16 <sup>00</sup>

## MONITORS

AMDEK	\$CALL
BMC 12" Green Au	88 <sup>00</sup>
BMC 12" Green Eu	129 <sup>00</sup>
BMC 9191 Color	289 <sup>00</sup>
TAXAN Amber	149 <sup>00</sup>
TAXAN RGB III	549 <sup>00</sup>
USI PI 1	99 <sup>00</sup>
USI PI 3	169 <sup>00</sup>

## Videx

80 Column	\$239 <sup>00</sup>
Enhancer II	119 <sup>00</sup>
Softswitch	25 <sup>00</sup>
Function Strip	59 <sup>00</sup>
Inverse Video	19 <sup>00</sup>
Applewriter Pre-Boot	19 <sup>00</sup>
Visicalc 80 Software	49 <sup>00</sup>
Visicalc 80 w/mem. exp.	74 <sup>00</sup>

# EPSON RIBBONS

MX 80 \$ 7<sup>00</sup>ea or 3 for 20<sup>00</sup>  
MX 100 11<sup>00</sup>ea or 3 for 32<sup>00</sup>

DEALER  
INQUIRIES  
INVITED



COMPUTER  
DISCOUNT  
PRODUCTS

MAIL ORDERS & RETAIL STORE  
860 S. Winchester Blvd  
San Jose, CA 95128  
**(408) 985-0400**

HOURS: MON-FRI 8AM - 5PM - SAT & SUN 10AM - 4PM

PRICES SUBJECT TO CHANGE - ALL ORDERS FOB SAN JOSE



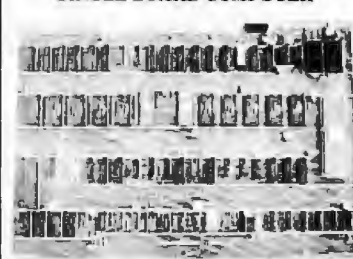
# Future Shock!

age **65**  
years worked **40**  
retirement benefits **0**

The U.S. Department of Labor has a free booklet that will help you answer these questions and a lot more. Send for it today  
Write: Pensions, Consumer Information Center, Pueblo, Colorado 81008

U.S. Department of Labor

## NEW! M-65000 SINGLE BOARD COMPUTER



### FEATURES:

16 bit Motorola 68000 CPU operating @ 10MHz, 512K bytes of on board fast write RAM, 128K bytes of on board EPROM space, 7 levels of protected memory management, 2 memory expansion buses (up to 512K), 2 serial communication ports (RS-232C), 16-bit bidirectional parallel port, 488 peripheral expansion bus, 16 I/O channels / timers with real time interrupt, on board real time clock, software compatible with Motorola M68000 board.

### PRICE:

Base board with documentation ..... \$79.95  
M68000 DMI compatible module in 2704 EPROM ..... \$119.00  
M68000 CPU & memory map PROM ..... \$119.00  
Shipping and handling (Domestic) ..... \$3.00  
(Foreign) ..... \$18.00

**EMS** International  
Microcomputer  
Systems  
P.O. Box 1023, Irvine, CA 92714

714-553-0133

Circle 185 on Inquiry card.

## Printer Cables

— Parallel —  
ALDOS ATTACHE ATARI \$39.00\*  
CENTRONICS COLUMBIA \$39.00\*  
EAGLE \$39.00\*  
IBM-PC \$39.00\*  
KAYPRO \$39.00\*  
OSBORNE \$39.00\*  
SANYO \$39.00\*  
TI-99 \$39.00\*  
FREE SHIPPING

— SERIAL —  
ATTACHE COM RS232C (DB25P) 19 conductor 1-8, 20)

## CABLES UNLIMITED

PO Box 93065  
Pasadena, Calif.  
91109

\*CA Residents Add 6% Sales Tax (\$2.40)

Circle 532 on Inquiry card.

## Scotch Diskettes

Rely on Scotch® diskettes to keep your valuable data safe. Dependable Scotch diskettes are tested and guaranteed error-free. The low abrasivity saves your read/write heads. They're compatible with most diskette drives.



(800)235-4137



PACIFIC EXCHANGES  
3184 Franklin Street  
San Jose, CA 95128  
In Calif. call (415) 281-1117  
Outside CA call (800) 235-4137

Dealer Inquiries Invited

Circle 347 on Inquiry card.

## SIGNALMAN MODEMS

300 BAUD \$89  
DIRECT CONNECT

300 BAUD \$149  
AUTO ANSWER/ORIGINATE  
HAYES COMPATIBLE

300/1200 BAUD \$319  
AUTO ANSWER/ORIGINATE  
HAYES COMPATIBLE

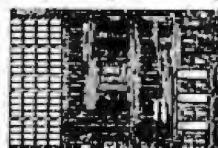
GEMINI 10 PRINTER  
GRAPHICS \$329 100 CPS

CALL (619) 436-8317  
IMAGE COMPUTER

\* VISA/MC ADD 3%

Circle 533 on Inquiry card.

## The Mega Super Computer



Price Computer with a Purchase of a RAM Disk

- 8008 Running at 5MHz, a Versatile CPU, a Main chip 9511 or 9512 RAM, a 16 Pin Ports on Mega Expander Bus, a CTC, DMA, a 2 Parallel Ports—each have stacking, a Serial Ports—with or without hand shaking runs 150 to 19K2 Baud. Runs most terminals, printers, and modems.
- NOVA CPU 3.0
- Hard Disk Interface hooks directly to Prime Drivers.
- Floppy Disk Controller—Handles Single Density IBM compatible disks and Dual Density 1 or 2 sided supports 8" or 5 1/4" in various combinations—3 Drives equal over 4 Mega Bytes of Storage (WD2277)
- 512K Bytes of 4K D-Ram with parity configurable as a HIGH SPEED ELECTRONIC DISK or 8 banks of 4K for multi-user or courtesy office applications.
- All this on a state-of-the-art 4 layer card—with accurate documentation—10" x 18"
- Prices: Base Board with Documentation ..... \$399  
4K Base System A & I ..... \$895  
512K Base System A & I ..... \$1595  
CPU 2.2 System A & I ..... \$125  
512K Base Kit ..... \$3299  
Manual ..... \$25  
NEW

**MEGA CO.**

2519 S. Park Street, Madison, WI 53713 (608)255-7400

Circle 534 on Inquiry card.

## A NO-COMPROMISE S-100 SYSTEM THAT YOU CAN AFFORD, STARTING AT \$2850

**Features:** Fully integrated S-100 system, with CP/M 2.2. 2 Thinline Mitsubishi 8" DS-DD drives. Ingrand enclosure with 3 expansion slots. Teletek System-master single board computer. Freedom 100 terminal with 7 x 9 dot char, P-31 phosphor, detachable keyboard, 10 Func. keys. Mainframe has full 1 year warranty.

\*\*All this for only \$2850\*\*

**Options:** 7 or 10 slot full height enclosures. Hard disks 5 to 25 Mb. LQ Printer. \$ call

## TOTAL ACCESS

Suite 202, 2054 University Ave.  
Berkeley, CA 94704  
(415) 540-8066

Circle 459 on Inquiry card.

## MICRO SOLUTIONS

### 8 To 16 BIT UPGRADE

### TRUE 16 BIT PROCESSING

- Z8001 Microprocessor (upgradable to Z8003)
- 2 Kx16 Eprom with Monitor Program (E/Rom optional)
- 16 Vectored Interrupts
- Full IEEE-696 (S100) Compliance
- All Z8001 Features available
- Battery backup time of day clock
- Requires ram capable of word transfers

Model M8000 CPU Board ..... 1425  
Model M8000 EE optional E-Rom ..... 75\*

**SPECIAL** (valid May 31 - 6/5) M8000 EE Free with purchase of M8000 CPU Board

To order  
Call 1-800-821-8558, in New Mexico 1-505-523-0975  
or write

Micro Solutions Inc. Visa and Master Card welcome  
Suite 191 B Include check or money order  
1609 El Paseo Rd New Mexico residents add  
Las Cruces, NM 88001 4.5% sales tax

Circle 523 on inquiry card.

## DAISY WHEEL PRINTERS SMITH-CORONA TP-1



\$529

- BROTHER HR-15 (2 colors) \$AVE
- BROTHER HR-1 (16 cps) \$749
- KAY-PRO-10 \$CALL
- KAY-PRO 11 \$CALL
- C-ITOH F-10 (40 cps) \$1295
- IBM PC \$CALL
- OSBORNE COMPUTER \$CALL
- SANYO MEC-1000 (incl software) \$1585
- GEMINI-10 \$289
- GEMINI-15 \$445
- FRANKLIN-ACE \$899

## MICRO MART

5375 Neary Villa Rd #115, San Diego CA 92123  
(619) 268-0189

Circle 531 on Inquiry card.

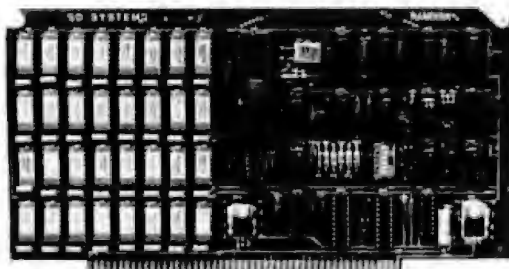
# JADE

Computer Products

**CP/M 3.0 PLUS  
FREE!**  
With Purchase  
OF THREE BOARD SET

**CP/M 3.0 PLUS  
On EPROM!**

## RAM DISC



The RAM DISC from SD Systems is a "solid-state disk drive" for IEEE696/S-100 systems. It allows programs to execute from high speed RAM, circumventing the mechanical problems and speed limitations of floppy disk drives. RAM DISC increases system performance substantially in disk intensive applications; compiling and sorting times are reduced to a fraction of the time required for a disk based compile or sort. CP/M plus support provided, 256K storage per board, "install" programs available for CP/M and MP/M.

MEM-66256A RAM DISK \_\_\_\_\_ \$799.95

## ROM DISC

SD Systems ROM DISC is a 128K EPROM/ROM board which is similar in concept to the RAM DISC. Like the RAM DISC it allows execution of software at high speed directly from memory, without the use of disk drives. The ROM DISC however is non-volatile memory ideally suited for use with the new CP/M Plus, which is now available in EPROM. With the new RAM DISC/ROM DISC combination you can now create a system which avoids some of the problems and pitfalls associated with magnetic media.

MEM-12850A ROM DISC Board \_\_\_\_\_ \$295.00  
CP/M Plus On EPROM:  
SFC-55009059E Unbanked, RS232 \_\_\_\_\_ \$400.00  
SFC-55009058E Unbanked, VDB8024 \_\_\_\_\_ \$400.00  
SFC-55009057E Banked, RS232 \_\_\_\_\_ \$400.00  
SFC-55009056E Banked, VDB8024 \_\_\_\_\_ \$400.00

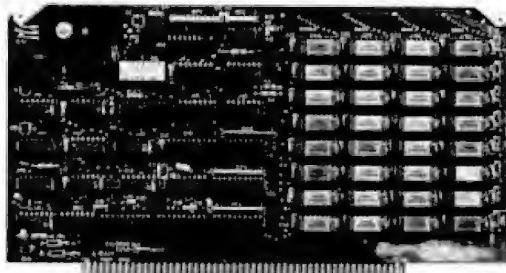
## SBC 200

SD Systems' SBC-200 is an S-100 bus compatible single board computer based on the 4MHz Z80A CPU. It contains a synchronous/asynchronous serial port with software programmable baud rates, a parallel I/O port, a four-channel counter-timer, and 1K on-board RAM. Up to 8K of firmware may be added to the board's 4 EPROM sockets.

The SBC 200 is the ideal heart of a system composed of the other boards in the SD product line, or can stand alone in process control applications.

CPC-30200A SBC-200 \_\_\_\_\_ \$399.95

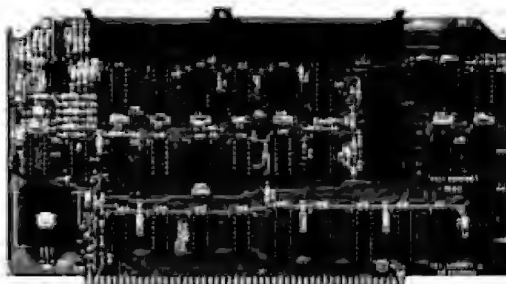
## EXPANDORAM III



SD Systems new ExpandoRAM III is a high density S-100 memory board utilizing the new 64K x 1 dynamic RAM chips. It allows memory sizes of 64K, 128K, 192K, or 256K all on a single S-100 board. Memory address decoding is done by a programmed bipolar ROM so the memory map may be dip-switch configured to work with either MP/M, CP/M, or OASIS-type systems. The ExpandoRAM III marks a new generation of highly reliable and versatile dynamic RAM boards suitable for expanding current S-100 systems, or for use in new multi-user systems.

MEM-65064A 64K \_\_\_\_\_ \$495.00  
MEM-65128A 128K \_\_\_\_\_ \$595.00  
MEM-65192A 192K \_\_\_\_\_ \$675.00  
MEM-65256A 256K \_\_\_\_\_ \$755.00

## VERSAFLOPPY II



SD Systems' Versafloppy II is a reliable field-proven S-100 double-density floppy disk controller. For full software compatibility it can also read and write standard IBM 3740 single density format. The versafloppy II controls single or double sided drives, in single or double density format, 5 1/4" or 8" in any combination and up to 4 drives simultaneously.

The Versafloppy II is faster, more stable and more tolerant of bit shift and "jitter" than most other controllers. All control and diagnostic firmware is included.

IOD-1160A Versafloppy II \_\_\_\_\_ \$359.95

## CP/M 3.0 PLUS

SD Systems' implementation of Digital Research's CP/M 3.0 Plus is a unique combination of hardware and software that optimizes the powerful new features of CP/M Plus. CP/M Plus requires 192K of memory for optimum performance, making it an ideal match for the 256K ExpandoRAM III.

In addition to the many powerful new features of CP/M Plus, you will realize performance increases of 5 to 7 times that of a CP/M 2.2 system.

SFC-55009059F Unbanked, RS232 \_\_\_\_\_ \$250.00  
SFC-55009058F Unbanked, VDB8024 \_\_\_\_\_ \$250.00  
SFC-55009057F Banked, RS232 \_\_\_\_\_ \$250.00  
SFC-55009056F Banked, VDB8024 \_\_\_\_\_ \$250.00  
SFC-55009057D Manual \_\_\_\_\_ \$50.00

## FREE!\* CP/M 3.0

SAVE! \$800.00 on THREE BOARD SET

S-100 board set with MHz Z-80A, 64K of RAM expandable to 256K, serial and parallel I/O ports, double-density disk controller for 5 1/4" and 8" disk drives, new and improved CP/M 3.0 manual set, system monitor, control and diagnostic software. Includes SD Systems SBC-200, 64K ExpandoRAM III, Versafloppy II and FREE CP/M 3.0 - all boards are assembled and tested.

\*64K Board Set with FREE CP/M 3.0 \_\_\_\_\_ \$1195.00

\*256K Board Set with FREE CP/M 3.0 \_\_\_\_\_ \$1395.00

Place Orders Toll Free

Continental U.S.

Inside California

800-421-5500

800-262-1710

For Technical Inquiries or Customer Service call:

213-973-7707

**JADE**  
Computer Products

4901 W. Rosecrans, Hawthorne, CA 90250



Circle 242 on inquiry card.



## S-100 MEMORY BOARDS

### 64K STATIC RAM - Jade

Uses new 2K x 8 static RAMs, fully supports IEEE 696 24 bit extended addressing, 200ns RAMs, lower 32K or entire board phantomable, 2716 EPROMs may be subbed for RAMs, any 2K segment of upper 8K may be disabled, low power typically less than 500ma.

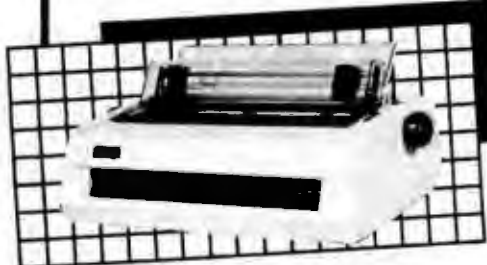
MEM-99152B Bare board	\$49.95
MEM-99152K Kit less RAM	\$89.95
MEM-32152K 32 kit	\$199.95
MEM-56152K 56K kit	\$389.95
MEM-64152K 64K kit	\$299.95
Assembled & Tested	add \$50.00

## LETTER QUALITY PRINTERS

### Letter Quality Printer - COMREX

Uses standard daisy wheels and ribbon cartridges, 16 CPS bi-directional printing, semi-automatic paper loader (single sheet or fan fold), 10/12/15 pitch, up to 18" paper, built-in noise suppression cover.

PRD-11001 Centronics parallel	\$999.95
PRD-11002 RS-232C serial model	\$999.95
PRA-11000 Tractor Option	\$118.95



### 380Z by D.T.C.

Based on the same quality mechanism as the Comrex printer, the 380Z contains electronic enhancements that allow it to print at speeds up to 32 CPS. Other features include a 48K buffer, proportional spacing, and Diablo 1640/1650/830 compatible protocol. Comes with printwheel, ribbon and users manual. Serial, parallel, and IEEE 488 interfaces standard.

PRD-11300 380Z printer	\$1295.00
PRA-11000 Tractor option	\$169.95
PRA-1200 Cut sheet feeder	\$899.95
Cable Please specify	\$49.95

### Printers From Jade

OKIDATA 82 10" 120 CPS	CALL
OKIDATA 92 10" 180 CPS with Graphics	CALL
OKIDATA 93 15" 180 CPS with Graphics	CALL
OKIDATA 83 15" 120 CPS with Tractor	CALL
OKIDATA 84 15" 200 CPS with Graphics	CALL
OKIDATA 2350 15" 350 CPS	CALL
OKIDATA 2410 15" 350 CPS, Two color	CALL
DAISYWRITER 2000 48K Daisywheel	\$1395.00
GEMINI 10 100 CPS 10" with Graphics	\$349.95
GEMINI 15 100 CPS 15" with Graphics	\$499.95

### PRINTER PALS - FMJ

Desk top printer stand and paper rack. Fits all printers.	
PRA-99080 10" Printer pal	\$29.95
PRA-99100 15" Printer pal	\$39.95
PRA-99700 for Letter Quality	\$49.95

## S-100 I/O BOARDS

### The BUS PROBE - Jade

Inexpensive S-100 Diagnostic Analyzer

TSX-200B Bare board	\$59.95
TSX-200K Kit	\$129.95
TSX-200A A & T	\$159.95

### I/O-4 - SSM Microcomputer

2 serial I/O ports plus 2 parallel I/O ports

IOI-1010B Bare board w/manual	\$35.95
IOI-1010K Kit with Manual	\$179.95
IOI-1010A A & T	\$249.95

### I/O-5 - SSM Microcomputer

Two serial & 3 parallel ports, 110-19.2K Baud

IOI-1015A A & T	\$289.95
-----------------	----------

### INTERFACER 4 - CompuPro

3 serial, 1 parallel, 1 Centronics parallel

IOI-1840A A & T	\$314.95
IOI-1830C CSC	\$414.95

## S-100 EPROM BOARDS

### PB-1 - SSM Microcomputer

2708, 2716 EPROM board with on-board programmer

MEM-99510K Kit with manual	\$194.95
MEM-99510A A & T with manual	\$219.95

### PROM-100 - SD Systems

2708, 2716, 2732 EPROM programmer with software

MEM-99520K Kit with software	\$169.95
MEM-99520A A & T with software	\$249.95

## VIDEO MONITORS

### VIDEO MONITOR - Jade

1000 lines ultra-high resolution, 20 MHz ultra-high band width, 9" or 12", Amber or Green phosphor the finest monitors we sell.

VDM-750920 9" Green	\$89.95
VDM-750910 9" Amber	\$129.95
VDM-751220 12" Green	\$129.95
VDM-751210 12" Amber	\$139.95

### 12" GREEN SCREEN - Zenith

15MHz, 40 or 80 column	
VDM-201201 12" Green	\$114.95

## DUAL DISK SUB-SYSTEMS

### DISK Sub-Systems - Jade

Handsome metal cabinet with proportionally balanced air flow system, rugged dual drive power supply power cable kit, power switch, line cord, fuse holder, cooling fan, neoprene rubber feet, all necessary hardware to mount 2-8" disk drives, power supply, and fan. Does not include signal cable

#### Dual 8" Sub-Assembly Cabinet

END-000420 Bare cabinet	\$49.95
END-000421 Cabinet kit	\$199.95
END-000431 A & T	\$249.95

#### 8" Sub-Systems - Single Sided, Double Density

END-000423 Kit w/2 Siemens FD100-8Ds	\$650.00
END-000424 A & T w/2 Siemens FD100-8Ds	\$895.00
END-000433 Kit w/2 Shugart SA-801Rs	\$999.95
END-000434 A & T w/2 Shugart SA-801Rs	\$1195.00

#### 8" Sub-Systems - Double Sided, Double Density

END-000426 Kit w/2 Qume DT-8s	\$1224.95
END-000427 A & T w/2 Qume D-8s	\$1424.95
END-000436 Kit w/2 Shugart SA-851Rs	\$1274.95
END-000434 A & T w/2 Shugart SA-801Rs	\$1195.00

## S-100 MOTHERBOARDS

### ISO-BUS - Jade

Silent, simple and on sale - a better motherboard

6 Slot (8 1/2" x 8 1/2")	
MBS-061B Bare board	\$22.95
MBS-061K Kit	\$39.95
MBS-061A A & T	\$69.95

12 Slot (8 1/2" x 8 1/2")	
MBS-121B Bare board	\$34.95
MBS-121K Kit	\$69.95
MBS-121A A & T	\$109.95

18 Slot (14 1/2" x 8 1/2")	
MBS-181B Bare board	\$54.95
MBS-181K Kit	\$99.95
MBS-181A A & T	\$149.95

## S-100 CPU BOARDS

### The BIG Z - Jade

2 or 4 MHz switachable Z-80 CPU board with serial I/O accommodates 2708, 2716, or 2732 EPROM, baud rates from 75 to 9600.

CPU-30201B Bare board w/manual	\$35.00
CPU-30201K Kit with Manual	\$149.95
CPU-30201A A & T with Manual	\$199.95

### 2810 Z-80 CPU - C.C.S.

2 or 4 MHz Z-80 CPU with serial I/O port & on board monitor PROM, front panel compatible

CPU-30400A A & T with PROM	\$299.95
----------------------------	----------

### CPU-Z CompuPro

2 or 4 MHz Z80A CPU, 24 bit addressing

CPU-30500A 2/4 MHz A & T	\$279.95
CPU-30500C 3/6 MHz CSC	\$374.95

### 8085/8088 - CompuPro

Both 8 & 16 bit CPUs, standard 8 bit S-100 bus, up to 8 MHz, accesses 16 Megabytes of memory

CPU-20510A 6 MHz A & T	\$399.95
CPU-20510C 6/8 MHz CSC	\$497.95

## PLACE ORDERS TOLL FREE

Continental U.S.  
**800-421-5500**

Inside California  
**800-262-1710**

For Technical Inquires  
or Customer Service call:  
**213-973-7707**

We accept cash, checks, credit cards, or Purchase Orders from qualified firms and institutions. Minimum prepaid order \$15.00 California residents add 8 1/2% tax. Export customers outside the US or Canada please add 10% to all prices. Prices and availability subject to change without notice. Shipping and handling charges via UPS Ground 50¢/lb. UPS Air \$1.00/lb. minimum charge \$3.00

## 5 1/4" DISK DRIVES

Tandon TM100-1 single-sided double-density 48 TPI MSM-551001 _____	\$219.95 ea 2 for \$199.95 ea
Shugart SA400L single-sided double-density 40 track MSM-104000 _____	\$234.95 ea 2 for \$224.95 ea
Tandon TM100-2 double-sided double-density 48 TPI MSM-551002 _____	\$294.95 ea 2 for \$269.95
TEAC FD55A single-sided double-density 40 track MSM-660551 _____	\$299.95 ea 2 for \$239.95

## 5 1/4" Cabinets With Power Supply

END-000218 Single cab w/power supply _____	\$69.95
END-000226 Dual cab w/power supply _____	\$94.95

## 8" SLIMLINE SUB-SYSTEMS

### Dual Slimline Sub-Systems — Jade

Handsome vertical cabinet with scratch resistant baked enamel finish, proportionally balanced air flow system, quiet cooling fan, rugged dual drive power supply, power cables, power switch, line cord, fuse holder, cooling fan all necessary hardware to mount 2-8" slimline disk drives. Does not include signal cable.

#### Dual 8" Slimline Cabinet

END-000820 Bare cabinet _____	\$59.95
END-000822 A & T w/o drives _____	\$179.95

#### Dual 8" Slimline Sub-Systems

END-000823 Kit w/2 SS DD Drives _____	\$919.95
END-000824 A & T w/2 SS DD Drives _____	\$949.95
END-000833 Kit w/2 DS DD Drives _____	\$1149.95
END-000834 A & T w/2 DS DD Drives _____	\$1179.95

## 8" DISK DRIVES

Siemens FDD 100-8 single-sided double-density MSF-201120 _____	\$274.95 ea 2 for \$249.95 ea
Shugart SAB01R single-sided double-density MSF-10801R _____	\$394.95 ea 2 for \$389.95 ea
Shugart SAB51R double-sided double density MSF-10851R _____	\$554.95 ea 2 for \$529.95 ea
Qume DT-8 double-sided double-density MSF-750080 _____	\$524.95 ea 2 for \$499.95 ea
Tandon TM8481 single-sided double-den thin-line MSF-558481 _____	\$379.99 ea 2 for \$369.95 ea
Tandon TM848-2 double-sided double-den thin-line NEF-558482 _____	\$494.95 ea 2 for \$484.95
NEC FD1185 double-sided double-den thin-line MSF-851185 _____	\$484.95 ea 2 for \$449.95



## MODEMS

### Smart Buy in MODEMS — Signalman

1200 and/or 300 baud, direct connect, automatic answer or originate selection, auto-answer/auto-dial on deluxe models 9v battery allows total portability, full one year warranty.

IOM-5600A 300 baud direct connect _____	\$89.95
IOM-5610A 300 baud Deluxe _____	\$149.95
IOM-5620A 1200/300 baud Deluxe _____	\$389.95
IOM-5650A 300 baud for Osborne _____	\$119.95
IOM-5630A 300 baud card for IBM _____	\$269.95
IOM-5690A 1200 baud option for IBM _____	\$129.95

### SMARTMODEM — Hayes

Sophisticated direct-connect auto-answer/auto-dial modem, touch-tone or pulse dialing RS-232C interface programmable

IOM-5500A Smartmodem 1200 _____	\$674.95
IOM-5400A Smartmodem 300 _____	\$224.95
IOM-1500A Hayes Chronograph _____	\$219.95
IOM-1100A Micromodem 100 _____	\$384.95
IOM-2010A Micromodem II w/Term prgm _____	\$329.95
IOM-2012A Terminal program for MMII _____	\$89.95

### 1200 BAUD SMART CAT — Novation

103/212 Smart Cat & 103 Smart Cat, 1200 & 300 baud, built-in dialer, auto re-dial if busy, auto answer/disconnect, direct connect, LCD readout displays mode analog/digital loopback self tests, usable with multi-line phones.

IOM-5241A 300 baud 103 Smart Cat _____	\$229.95
IOM-5251A 1200 baud 212/103 Smart Cat _____	\$549.95

### J-CAT™ MODEM — Novation

1/5 the size of ordinary modems, Bell 103, manual or auto-answer, automatic answer/originate, direct connect, built-in self-test, two LEDs and audio beeps provide status information.

IOM-5261A Novation _____	\$149.95
--------------------------	----------

## S-100 DISK CONTROLLERS

### DISK 1 — CompuPro

8" or 5 1/4" DMA disk controller, single or double density, single or double sided, 10MHz

IOD-1810A A & T _____	\$449.95
IOD-1810C CSC _____	\$534.95

### 2422 DISK CONTROLLER — C.C.S.

5 1/4" or 8" double density disk controller with on-board boot loader ROM, free CP/M 2.2 & manual set

IOD-1300A A & T with CP/M 2.2 _____	\$399.95
-------------------------------------	----------

### DOUBLE D — Jade

High reliability double density disk controller with on-board Z-80A, auxiliary printer port, IEEE S-100 can function in multi-user interrupt driven bus.

IOD-1200B Bare board & hwr man _____	\$59.95
IOD-1200K Kit w/hwr & slwr man _____	\$299.95
IOD-1200A A & T w/hwr & slwr man _____	\$325.00
SFC-59002001F CP/M 2.2 with Double D _____	\$99.95

## DISK TUBS

### DISKETTE STORAGE BOXES

Clear Plexiglass storage boxes for up to 75 Diskettes	
MMA-505 Holds 75 5 1/4" _____	\$19.95
MMA-508 Holds 50 8" _____	\$24.95

## SINGLE BOARD COMPUTER

### SUPERQUAD — Adv. Micro Digital

Single board, standard size S-100 computer system 4MHz Z-80A, single or double density disk controller for 5 1/4" or 8" drives, 64K RAM, extended addressing up to 4K of EPROM, 2 serial & 2 parallel I/O ports, real time interrupt clock, CP/M compatible

CPC-30800A A & T _____	\$724.95
IOX-4232A Serial I/O adapter _____	\$29.95

## EPROM ERASERS

### ULTRA-VIOLET EPROM ERASERS

Inexpensive erasers for industry or home

XME-3100A Spectronics w/o timer _____	\$69.50
XME-3101A Spectronics with timer _____	\$94.95
XME-3200A Logical Devices _____	\$49.95

## APPLE II ACCESSORIES

### DISK DRIVE — Apple Compatible

Totally Apple compatible, 143,360 bytes per drive on DOS 3.3 full one year factory warranty, half-track capability reads all Apple software, plugs right into Apple controller as second drive, DOS 3.3, 3.2.1 Pascal, & CP/M compatible.

MSM-123200 Add on Apple Drive _____	\$249.95
MSM-123100 Controller _____	\$99.95

### CP/M 3.0 CARD for Apple — A.L.S.

The most powerful card available for your Apple! 6MHz Z-80B, additional 64K of RAM, CP/M plus 3.0 100% CP/M 2.2 compatibility, C basic, CP/M Graphics, 300% faster than any other CP/M for Apple One year warranty

CPX-62610A A.L.S. CP/M Card _____	\$349.95
-----------------------------------	----------

### Z-CARD for Apple II — A.L.S.

Two computers in one, Z-80 & 8502, more than doubles the power and potential of your Apple, includes Z-80 CPU card CP/M 2.2 and complete manual set, Pascal compatible utilities are menu-driven, one year warranty.

CPX-62600A A & T with CP/M 2.2 _____	\$159.95
--------------------------------------	----------

### SMARTERM II — A.L.S.

80 column x 24 line video card for Apple II, addressable 25th status line, normal/inverse or high/low video, 128 ASCII characters, upper and lower case, 7 x 9 dot matrix with true descenders, standard Data Media terminal control codes, CP/M Pascal & Fortran compatible, 50/60 Hz, 40/80 column selection from keyboard Best 80 Column Card!

IOV-2500A ALS Smarterm II _____	\$169.95
---------------------------------	----------

### 16K RAM Card — for Apple II

Expand your Apple II 64K, use as language card, full 1 year warranty, Why spend \$175.00?

MEX-16700A Save over \$115.00 _____	\$49.95
-------------------------------------	---------

### SERIAL I/O CARD — A.L.S.

Full feature serial card for modems & printers, baud rates from 110 to 19,200, CTS/RTS & X-on/X-off protocols auto line feed, RS-232C cable interface included

IOI-1000A A & T Dispatcher Card _____	\$129.95
---------------------------------------	----------

# JADIE

Computer Products

4901 West Rosecrans, Hawthorne, California 90250



# CALIFORNIA DIGITAL

Post Office Box 3097 B • Torrance, California 90503

★ **FREE** ★  
 Plastic library case supplied with all diskettes purchased from California Digital  
**\$19.95**  
 New Low Price



5 1/4" DISKETTES WITH LIBRARY CASE  
**\$26.50**

Your Choice  
**SCOTCH MEMOREX VERBATIM**

Private labeled for California Digital by one of the most respected producers of magnetic media. Each diskette is certified double density at 40 tracks. To ensure extended media life all diskettes are manufactured with a registered hub. Each box of diskettes is supplied with a free plastic library case. Disk sector: CAL 501. Two sector: CAL 516.



Single Side Double Density				
	Soft Sector	10 Sector	16 Sector	
SCOTCH	744D-0	744D-10	744D-16	26.50
MEMOREX	3481	3483	3485	26.50
VERBATIM	525-01	525-10	NA	26.50
MAXELL	MD1	MH1-10	MH1-16	29.85
DYSAN	104/1D	107/1D	NA	45.00

Double Side Double Density				
SCOTCH	745-0	745-10	745-16	42.50
VERBATIM	550-01	550-10	NA	42.50
MAXELL	MD2-D	MH2-10D	MH2-16D	45.00
DYSAN	104/2D	107/2D	NA	49.50
DYSAN 96	204/2D	NA	NA	59.50

EIGHT INCH DISKETTES					
Single Side Single Density			Single Side Double Density		
SCOTCH	740-0	29.50	SCOTCH	741-0	39.00
MEMOREX	3060	29.50	MEMOREX	3090	35.00
DYSAN	3740/1	39.50	DYSAN	3740/D	57.50
Thirty Two Sector			Double side Double Density		
SCOTCH	740-32	29.50	SCOTCH	743-0	47.50
MEMOREX	3114	39.50	DYSAN	3740/2D	65.00

**Microswitch ASCII KEYBOARD \$79**  
 Each keyboard contains 81 high reliability Hall Effect keys. Outputs seven bit parallel ASCII MIC-81SD5 3 Lbs.



**HITEK KEYBOARD \$24.95**



This Hitek keyboard is the same unit used by Lear Siegler in their middle line CRT terminals. The keyboard features 58 unencoded metal on metal contacts (MK-58). Matching numeric cluster with 15 keys is available for \$9.95 (MK-15). Buy both of these units for only \$29.90 and save \$5.00 (MK-5815).

## MEMORY

16K DYNAMIC <b>1.95</b> 4116 150ns.	2732 EPROM <b>4.95</b> 450ns.
64K DYNAMIC <b>6.95</b> 4164 150ns.	16K STATIC <b>4.95</b> 6116 200ns.



## 2764 EPROM SALE \$9.95

DYNAMIC MEMORY		
4027 4K dynamic 250ns	CM-4027250	1.50 30 100 0
4116 1600ns 16K	ICM-4116150	1.00 1.00 1.75
4164 150ns 16K	ICM-4116250	1.00 1.00 1.75
4188 150ns 8Kx 32K (1600K)	CM-4188150	1.75 1.00 1.50
42256 150ns 256K	ICM-41256150	0.00 0.00 0.00
STATIC MEMORY		
27128 200ns 1K x 8	ICM-27128200	0.00 1.00 1.10
27128 450ns 16 circuit	ICM-27128450	0.00 1.00 1.10
27128 450ns 2K x 8	ICM-27128500	0.00 1.00 1.10
2714 300ns 1K x 8	ICM-2714300	1.00 1.00 1.10
3064 765 450ns 4K x 4	ICM-4064450	3.00 3.25 2.00
5257 300ns 4K x 8	ICM-5257300	1.50 2.25 1.00
6116 16 200ns 2K x 8	CM-6116200	0.00 4.00 3.00
6116 P3 150ns 2K x 8	CM-6116150	0.00 5.75 3.00
6167 2167 100ns 16K x 1 (1600K)	CM-6167100	6.00 9.50 7.50
EPROMS		
2708 450ns 1K x 8	ICE-2708	4.00 0.75 4.00
2716 450ns 2K x 8	ICE-2716	4.00 0.75 4.00
2718 450ns 4K x 8	ICE-2718	4.00 0.75 4.00
2718 450ns 8K x 8	ICE-2718	4.00 0.75 4.00
2722 450ns 16K x 8	ICE-2722	4.00 0.75 4.00
2732 450ns 32K x 8	ICE-2732	0.00 0.00 7.00
2732 450ns 64K x 8	ICE-2732	10.00 0.00 8.00
2732 450ns 128K x 8	ICE-2732	10.00 0.00 8.00
2764 450ns 16K x 8	ICE-2764	4.00 0.75 4.00
2764 450ns 32K x 8	ICE-2764	4.00 0.75 4.00

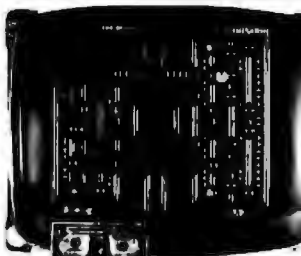
## CONNECTORS



S-100 Gold \$2.95			DB25P \$2.50		
5-100 125# connectors	male	100	17 1/2 pin	male	100-01 71#
male solder 240# 100	02.00	02.00	17 1/2 pin	female	100-02 01-00 61-00
male wire 150# 100	02.00	02.00	17 1/2 pin	male	100-03 01-00 1.00
female wire 150# 100	02.00	02.00	17 1/2 pin	female	100-04 01-00 1.00
Shield 140# 100	02.00	02.00	17 1/2 pin	male	100-05 01-00 1.00
Shield 140# 100	02.00	02.00	17 1/2 pin	female	100-06 01-00 1.00
140# Connect (standard)	2.00	4.00	17 1/2 pin	male	100-07 01-00 1.00
140# 140# Connect	2.00	4.00	17 1/2 pin	female	100-08 01-00 1.00
140# 140# Connect	2.00	4.00	17 1/2 pin	male	100-09 01-00 1.00
140# 140# Connect	2.00	4.00	17 1/2 pin	female	100-10 01-00 1.00
140# 140# Connect	2.00	4.00	17 1/2 pin	male	100-11 01-00 1.00
140# 140# Connect	2.00	4.00	17 1/2 pin	female	100-12 01-00 1.00
140# 140# Connect	2.00	4.00	17 1/2 pin	male	100-13 01-00 1.00
140# 140# Connect	2.00	4.00	17 1/2 pin	female	100-14 01-00 1.00
140# 140# Connect	2.00	4.00	17 1/2 pin	male	100-15 01-00 1.00
140# 140# Connect	2.00	4.00	17 1/2 pin	female	100-16 01-00 1.00
140# 140# Connect	2.00	4.00	17 1/2 pin	male	100-17 01-00 1.00
140# 140# Connect	2.00	4.00	17 1/2 pin	female	100-18 01-00 1.00
140# 140# Connect	2.00	4.00	17 1/2 pin	male	100-19 01-00 1.00
140# 140# Connect	2.00	4.00	17 1/2 pin	female	100-20 01-00 1.00

INTERCONNECT CIRCUIT SOCKETS  
 Low Profile Wire Wraps  
 8 pin 1.10 0.50 0.40 1.01  
 14 pin 1.10 0.50 0.40 1.01  
 18 pin 1.10 0.50 0.40 1.01  
 24 pin 1.10 0.50 0.40 1.01  
 30 pin 1.10 0.50 0.40 1.01

**23" COMPOSITE MONITOR \$159**



Ideal monitor for classroom demonstrations.

Ever try getting a classroom of students around a 17" monitor? Here is your opportunity to purchase a 23" high resolution monitor at a tremendous price. This new screen standard composite video signal generator by most popular computer manufacturers Apple and IBM. Attach a your computer and see second year old streaming clean graphics in video screen mode. MOT-8023 24 lbs. Monitor is open frame and for easily should be protected. Wood grained enclosure for above \$30.00 additional CAL-DNC23 15 lbs.



	Eight Inch Single Sided		
	One	Two	Ten
SHUGART SA801R	\$395	385	375
SIEMENS FDD100-8	259	259	225
TANDON 848-1 SLIMLINE	379	369	359

	Eight Inch Double Sided		
	One	Two	Ten
SHUGART SA851R	525	495	475
QUME DATA TRACK 8	525	495	475
OLIVETTI 802/851	369	359	349
TANDON 848-2 SLIMLINE	495	485	475
SHUGART 860 THINLINE	569	549	539

	Five Inch Single Sided		
	One	Two	Ten
SHUGART SA400	215	209	199
TANDON TM 100-1	209	199	195

	Five Inch Double Sided		
	One	Two	Ten
SHUGART SA450	349	329	315
TANDON TM 100-2	295	269	259
TANDON 96TPI TM100-4	369	355	350
OLIVETTI 502 3/4 height	239	225	215

Three Inch Rigid Floppy				
HTACH-AMDEK	call for pricing			
Five Inch Winchester				
SEAGATE 506 6 Megabyte	759	725	695	
SEAGATE 512 12 Megabyte	995	960	960	
TANDON 603SE 14 Megabyte	995	960	895	
WESTERN DYNAX removable	995	960	950	

Upon request, all drives are supplied with power connectors and manual



**\$750 Eight Inch Subsystem**

Two Siemens FDD100-8 disk drives with power supply, 4" exhaust fan complete with all necessary power cables. Same as above but with:

Shugart 801R	MSD2061	1105	Oliveri 802	CAL2363	1250
Shugart 851R	MSD2651	1450	Oliveri 851R	MSD80T	1450

**ECLIPSE 100 \$695**

## INDUSTRIAL S-100 MAINFRAME

Suitable for hospital and industrial applications. Constructed from 304 brushed stainless steel. Modular 500 watt toroid power supply provides -8 volts at 30 Amps and ±16 volts at 4 Amps. Supplied with standard 18 slot. For easy mother board Auxiliary switched AC receptacles. The Eclipse 100 can be either table or rack mounted. Provisions for internally mounting a ten megabyte Winchester disk drive. The Eclipse 100 is the perfect mainframe to fit the void left by the now defunct TEI Corporation. EPS-100 50 lbs.

TOLL FREE ORDER LINE  
**(800) 421-5041**  
 TECHNICAL & CALIFORNIA  
**(213) 679-9001**



Shipping: First 100 pounds \$4.00. Each additional \$4.00. For ten orders: 10% shipping. Excess will be refunded. California residents add 6% sales tax. COD's discouraged. Open accounts extended to state supported educational institutions and companies with a "strong" line of credit. Warehouse: 15008 Englewood Blvd., Midvale by appointment.





# Do Kay Computer Products, Inc.

VISIT OUR RETAIL STORE

3250 KELLER STREET, #9 • SANTA CLARA, CA 95050

## 16K APPLE\* II RAM CARD

**BARE BOARD** 14.00  
**KIT**  
**ASSEMBLED** 42.50

\*Apple is a trademark of Apple Computer, Inc.

### INTERFACE

BT25	1.85
BT28	1.95
BT95	.95
BT96	.95
BT97	.95
BT98	.95
DM8131	2.90
DP8304	2.25
DS8835	1.99
DS8836	.99

### DYNAMIC RAMS

TMS 4027	250ns	.79
UPD 411	300ns	2.89
MM 5280	300ns	2.89
MK4108	200ns	1.74
MM 5298	250ns	1.74
4027	250ns	2.00
4116	200ns	CALL
4116	150ns	CALL
4164	200ns	CALL
4164	150ns	CALL

### STATIC RAMS

2101	450ns	-1.80
5101	450ns	3.99
2102-1	450ns	.76
2102L-2	250nsLP	1.44
2111	450ns	2.48
2112	450ns	2.58
2114	450ns	1.74
2114L-4	450nsLP	1.84
2114L-3	300nsLP	1.84
2114L-2	200nsLP	1.94
2147	55ns	4.89
TMS4044-4	450ns	3.15
TMS4044-3	300ns	3.45
TMS4044-2	200ns	3.89
MK4118	250ns	9.69
TMM2016	200ns	4.15
TMM2018	150ns	4.89
HM8116-4	200ns	CALL
HM8116-3	150ns	CALL
HM8116-2	120ns	CALL
Z8132	300ns	32.95

LP = LOW POWER

### RESISTORS

1/4 WATT 5% CARBON FILM  
 ALL STANDARD VALUES  
 FROM 1 OHM TO 10 MEG OHM  
 50 PCS. SAME VALUE .0200  
 100 PCS. SAME VALUE .0150  
 1000 PCS. SAME VALUE .0125

### 8500

1 MHz	
6502	5.25
6504	6.85
6505	7.60
6507	9.86
6520	3.95
6522	4.95
6532	5.95
6545	16.95
6551	10.95
2 MHz	
6502A	8.95
6522A	9.95
6532A	11.90
6545A	27.90
6551A	11.90
3 MHz	
8502B	11.90

**We Will Beat Any Competitors' Prices!**

74LS00	.23	74LS123	.49	74LS253	.58
74LS01	.23	74LS124	1.24	74LS257	.58
74LS02	.23	74LS125	.44	74LS258	.58
74LS03	.23	74LS126	.44	74LS259	1.19
74LS04	.23	74LS132	.54	74LS260	.58
74LS06	.23	74LS136	.54	74LS266	.58
74LS08	.23	74LS137	.89	74LS273	1.48
74LS10	.23	74LS138	.49	74LS275	3.20
74LS11	.25	74LS139	.49	74LS279	.48
74LS12	.25	74LS145	1.19	74LS280	1.79
74LS13	.36	74LS147	2.39	74LS283	.69
74LS14	.36	74LS148	1.29	74LS290	.74
74LS15	.29	74LS151	.39	74LS283	.78
74LS20	.23	74LS153	.39	74LS295	.98
74LS21	.23	74LS154	1.89	74LS298	.88
74LS22	.23	74LS155	.59	74LS324	1.74
74LS26	.29	74LS156	.69	74LS352	1.28
74LS27	.23	74LS157	.44	74LS353	1.28
74LS28	.29	74LS158	.49	74LS383	1.34
74LS30	.23	74LS160	.88	74LS364	1.89
74LS32	.25	74LS161	.84	74LS365	.48
74LS33	.48	74LS162	.68	74LS366	.48
74LS38	.29	74LS163	.64	74LS367	.44
74LS40	.23	74LS165	.79	74LS386	.44
74LS42	.43	74LS166	1.69	74LS374	.98
74LS47	.49	74LS168	1.89	74LS377	1.24
74LS48	.74	74LS169	1.74	74LS378	1.15
74LS49	.74	74LS170	1.45	74LS379	1.34
74LS51	.23	74LS173	.68	74LS385	1.80
74LS54	.23	74LS174	.44	74LS388	.44
74LS65	.28	74LS175	.39	74LS390	1.15
74LS63	1.19	74LS181	1.89	74LS393	1.15
74LS73	.34	74LS189	8.79	74LS395	1.15
74LS74	.34	74LS190	.79	74LS399	1.48
74LS75	.34	74LS191	.79	74LS424	.37
74LS76	.34	74LS192	.64	74LS447	.37
74LS78	.45	74LS193	.84	74LS490	1.94
74LS83	.59	74LS194	.68	74LS668	1.69
74LS86	.65	74LS195	.68	74LS669	1.89
74LS88	.35	74LS196	.78	74LS670	1.48
74LS90	.35	74LS187	.78	74LS674	9.45
74LS91	.79	74LS221	.74	74LS682	2.99
74LS92	.54	74LS240	.89	74LS683	2.99
74LS93	.54	74LS251	.89	74LS684	2.99
74LS96	.74	74LS242	.98	74LS685	2.99
74LS96	.69	74LS243	.98	74LS688	2.39
74LS107	.35	74LS244	.79	74LS688	2.99
74LS109	.35	74LS245	1.48		
74LS112	.35	74LS247	.74	81LS95	1.48
74LS113	.35	74LS248	.89	81LS96	1.48
74LS114	.35	74LS249	.89	81LS97	1.48
74LS122	.39	74LS251	.58	81LS98	1.48

### UARTS

AY3-1014	5.85
AY5-1013	3.90
AY5-1015	6.90
TR1602	3.80
IM8402	7.85
IM8403	8.85
INS8250	10.49

### LEDS

Jumbo Red	10/1.00
Jumbo Green	8/1.00
Jumbo Yellow	8/1.00

### DIP SWITCHES

4 Position	.85
5 Position	.90
6 Position	.90
7 Position	.90
8 Position	.95

### EXAR

XR 2206	3.75
XR 2207	3.75
XR 2208	3.90
XR 2211	5.25
XR 2240	3.25

### RCA

CA 3010	.95
CA 3013	1.99
CA 3023	2.75
CA 3035	2.49
CA 3039	1.25
CA 3046	1.25
CA 3053	1.45
CA 3059	2.90
CA 3060	2.90
CA 3065	1.75
CA 3080	1.10
CA 3081	1.85
CA 3082	1.65
CA 3083	1.85
CA 3086	.80
CA 3089	2.10
CA 3130	1.25
CA 3140	1.15
CA 3146	1.75
CA 3160	1.15
CA 3401	.59
CA 3800	3.45

## APPLE\* II COMPATIBLE DISK DRIVE

**225.95**  
**CONTROLLER CARD**  
**79.95**

## 5 1/4" FLOPPY DISK FLIP FILE

CAPACITY 75 EA  
**19.95**

## APPLE SUPER COOLING FANS

**49.95**  
 WITH SURG PROTECH  
**69.95**

## APPLE PADDLES

**9.95**

**APPLE UPGRADE**  
**4116 - 200ns**  
**8/10.00**

**Do Kay Computer Products, Inc.**  
 3250 Keller Street, #9  
 Santa Clara, CA 95050  
 (800) 538-8800

Calif Residents Local Phone  
 (800) 848 8008 408) 988 0697

**STORE HOURS:**  
 MON-FRI 8:30 A.M.-5:30 P.M.  
 SAT 10:00 A.M.-3:00 P.M.



**TERMS:** For shipping include \$2.00 for UPS Ground. \$3.00 for UPS Blue Label Air. \$10.00 minimum order. Bay Area residents add 6 1/2% Sales Tax. California residents add 6% Sales Tax. We reserve the right to limit quantities and substitute manufacturer. Prices subject to change without notice. Send SASE for complete list.

# APPLE II USERS DISK DRIVE!

- Includes metal cabinet
- Color matches Apple
- 35 tracks/single side
- Includes cable
- Use with Apple II controller

## 225.95

CONTROLLER CARD . . . . . 79.95

## EPROM ERASERS

HOLDS 15 EPROMS  
ERASES IN 20 MINUTES

### 59.95

## Z80 SERIES

<b>2.5 MHz</b>		Z80A-DMA	21.95
Z80-CPU	3.35	Z80A-DART	15.95
Z80-PIO	3.35	Z80A-SIO0	20.95
Z80-CTC	3.35	Z80A-SIO1	20.95
Z80-DMA	12.49	Z80A-SIO2	20.95
Z80-DART	14.98	Z80A-SIO9	18.95
Z80-SIO0	18.95		
Z80-SIO1	18.95		
Z80-SIO2	16.95		
Z80-SIO9	16.95		
<b>4.0 MHz</b>			
Z80A-CPU	4.90		
Z80A-PIO	4.90		
Z80A-CTC	4.90		
		<b>8.0 MHz</b>	
		Z80B-CPU	14.95
		Z80B-PIO	12.95
		Z80B-CTC	12.95
		<b>ZILOG</b>	
		Z8132	32.95
		Z8671	38.95

# Do Kay Computer Products, Inc.

VISIT OUR RETAIL STORE

3250 KELLER STREET, #9 • SANTA CLARA, CA 95050

## 5 1/4" DISKETTES ATHANA OR NASHUA

SSSD . . . . . 18.95  
SSDD . . . . . 22.95  
DSDD . . . . . 27.95

**BULK  
SSDD SOFT  
\$1.65 EA**

### LINEAR

LM301	32	LM741	.29
LM308	75	LM747	75
LM308K	1.25	LM748	49
LM311	.64	LM1310	2.45
LM317T	1.85	MC1330	1.69
LM317K	1.70	MC1350	1.25
LM318	1.49	MC1358	1.69
LM323K	3.75	LM1414	1.49
LM324	.59	LM1458	.55
LM337K	3.90	LM1488	.85
LM339	.79	LM1489	.86
LM377	2.25	LM1800	2.45
LM380	1.25	LM1889	2.45
LM386	1.00	LM3900	.59
LM555	.38	LM3909	.95
LM556	.85	LM3914	3.70
LM565	.95	LM3915	3.70
LM566	1.45	LM3916	3.70
LM567	.99	75451	.35
LM723	.49	75452	.35
LM733	.95	75453	.35

**ORDER TOLL FREE**  
**(800) 538-8800**  
**(800) 848-8008**  
(CALIFORNIA RESIDENTS)  
ALL MERCHANDISE IS 100% GUARANTEED

## Disc Controllers

1771	15.95
1791	27.95
1793	29.95
1795	49.95
1797	49.95
6843	32.95
6872	39.00
UPD7065	34.95
1681	17.95

### 6800 1 MHz

6800	4.75
6802	7.89
6808	8.45
6809	11.95
6809E	17.95
6810	2.89
6820	3.50
6821	2.95
6828	13.95
6840	7.95
6843	32.95
6844	24.95
6845	13.95
6847	11.95
6850	3.20
6852	3.50
6860	9.89
6862	11.90
6875	6.89
6880	1.80
6883	22.95

### 2 MHz

68800	9.95
68802	21.95
68809	28.95
68809E	28.95
6810	7.89
6810	11.95
68845	33.95
68850	11.95

### 3 MHz

68000	57.95
-------	-------

## IC Sockets

### IC SOCKETS

	ST	W/W
8 PIN	.10	.49
14 PIN	.12	.50
18 PIN	.15	.57
18 PIN	.20	.85
20 PIN	.25	.99
22 PIN	.25	1.30
24 PIN	.25	1.40
28 PIN	.35	1.50
40 PIN	.40	1.80

ST = Soldertail  
W/W = Wirewrap

## Power Supplies

MOUNTED ON PC BOARD  
MANUFACTURED BY CONVER  
+5 VOLT 4 AMP  
±12 VOLT 1 AMP

### 34.95



### CLOCK CIRCUITS

MM5314	4.90
MM5369	3.90
MM5375	4.90
MM58167	8.90
MM58174	10.95
MSM5832	6.90

### MISC.

11 C 90	12.95
3242	6.95
MC 3470	7.95
MC 3480	8.95
ULN 2003	5.95
CA 3146	1.75
2513-001 up	9.69
2513-002 low	9.69

### CRYSTALS

32.768 KHz	1.90	6.144	2.69
1.00 Hz	4.50	6.5536	2.69
1.8432	4.50	8.0	2.89
2.0	3.90	10.0	2.89
2.097152	3.90	12.0	2.89
2.4576	2.69	14.31818	2.69
3.2768	2.89	15.0	2.89
3.579545	2.89	16.0	2.89
4.0	2.89	17.430	2.89
5.0	2.89	18.0	2.89
5.0688	2.89	18.432	2.89
5.185	2.69	20.0	2.69
5.7143	2.69	22.1164	2.69
6.0	2.69		

### VOLTAGE REGULATORS

7805T	75	7908T	85
7808T	75	7912T	85
7812T	75	7915T	85
7815T	75	7924T	95
7824T	85		
		7905K	1.39
7806K	1.29	7912K	1.39
7812K	1.29	7915K	1.39
7815K	1.29	7924K	1.39
7824K	1.29		
7905T	85		

T = TO-220  
K = TO-3

### 8000

8035	4.95	8251	4.99
8039	5.95	8253	6.99
8080A	3.89	8253-5	7.89
8085A	5.89	8255	4.39
8086	24.95	8255-5	5.19
8088	34.95	8257	7.89
8155	7.75	8259	6.85
8156	8.75	8272	39.00
8185	29.00	8275	29.00
8202	27.95	8279	8.88
8206	3.45	8279-5	9.89
8212	1.79	8282	6.49
8214	3.75	8283	6.49
8216	1.69	8284	5.49
8224	2.19	8286	6.49
8226	1.79	8287	6.49
8228	3.34	8289	24.95
8237	19.00	8289	39.00
8238	4.39	8741	34.95
8243	4.39	8748	14.95
8250	10.49	8755	29.95

### CONNECTORS

RS232	Male	3.00
RS232	Female	3.50
RS232	Female Right Angle	4.95
RS232	Hood	1.20
	30 pin Edge	2.49
	44 pin Edge	2.49
	50 pin Edge	2.69
	86 pin Edge	3.90
	100 pin ST	3.90
	100 pin W/W	4.90

**Do Kay Computer Products, Inc.**  
3250 Keller Street, #9  
Santa Clara, CA 95050  
(800) 538-8800  
Local Phone (408) 988 0697

STORE HOURS:  
MON-FRI 8:30 A.M. - 5:30 P.M.  
SAT 10:00 A.M. - 3:00 P.M.

TERMS: For shipping include \$2.00 for UPS Ground. \$3.00 for UPS Blue Label Air. \$10.00 minimum order. Bay Area residents add 6 1/2% Sales Tax. California residents add 6% Sales Tax. We reserve the right to limit quantities and substitute manufacturer. Prices subject to change without notice. Send SASE for complete list.



# U.S. MICRO SALES

★ MADE IN U.S.A. BY AMERICANS ★

## UNIVERSAL POWER SUPPLY



For Big Board, Apple or Aim 65  
 +5VDC @ 3 Amps  
 +12VDC @ .750 Amps  
 -12VDC @ .750Amps  
 -5VDC @ .500 Amps  
 Dimensions: 4" x 4" x 11"

**\$69.95**

## DISK DRIVE POWER SUPPLY

For 2 - 8" or 5" Drives  
 + 5VDC @ 4 Amps  
 +24VDC @ 3 Amps  
 - 5VDC @ 1 Amp



AC Cables for 2 Drives \$7.50

Dimensions: 4" x 4" x 11"

**\$59.95**

## S-100 POWER SUPPLY



+8VDC @ 30 Amps  
 +16VDC @ 6 Amps  
 -16VDC @ 6 Amps  
 PC Board Design  
 Dimensions: 5" x 6" x 11"

**\$89.50**

## S-100 MOD KIT by XOR

For test or systems applications  
 Complete S-100 12 Slot Main-  
 frame with Disk Drive Power Supply  
 for 4 Drives



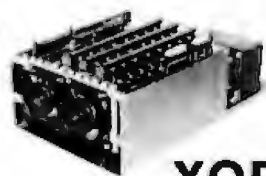
### SPECIFICATIONS

Unregulated	Regulated
+8V @ 30A	+5V @ 5A
±16V @ 6A	+24V @ 3A
	-5V @ 1A

\$225.00 Kit with 12 S-100 Bus Connectors  
 \$255.00 Assem. and Tested with 12 Bus Connectors  
 \$15.00 AC/DC Drive Cable Set for 2 Drives  
 Dimensions 6" x 10" x 18" - Shipping Weight 25 lbs.

Cooling Power  
 4 1/8"

Low Velocity  
 Whisper Fans  
 Only \$18.00 ea.  
 Finger Guards  
 \$2.50 each.



**XOR**  
 S-100 MOD

## California Computer Systems SPECIAL!



**CCS SYSTEM 2410 . . \$1995.00**

- Includes CP/M® 2.2
- 2-Serial/1-Parallel Port
- DMA Disk Controller
- Hardware Vectored Interrupts
- 2-Real Time Clocks
- Supports CP/M®, MP/M®, OASIS

**CCS 2300 System, A & T . . 1695.00**

- 2810 CPU . . . . . Only-255.00
- 2422 Disk Controller . . . . . Only-330.00
- 2066 64K . . . . . Only-360.00
- 2300A Mainframe NEW! . . . . . Only-399.00
- CCS Apple Boards . . . . . Call Toll Free For Prices

# CUSTOMER SERVICE HOTLINE 1 - (714) 898-5525

## DUAL DRIVE SUBSYSTEMS



HORIZONTAL OR VERTICAL

Fully Assembled and Tested Units

**ONE YEAR P + L WARRANTY**

On Shugart and Mitsubishi Subsystems

w/two Mitsubishi DS/DD . . . . .	\$1170.00
w/two Shugart 801R SS/DD . . . . .	975.00
w/two Shugart 851R DS/DD . . . . .	1225.00
w/two Siemens 120-8 SS/DD . . . . .	675.00
w/two Qume DT-8 DS/DD . . . . .	1250.00
Cabinet A & T w/Power Supply and Accs. . . . .	235.00
Cabinet Top and Bottom . . . . . Only -	69.50

All cabinets A & T and subsystems include an AC/DC wiring and 50 pin data cable except the horizontal model which includes the internal 50 pin cable and requires an external 50 pin cable part # C-6000-01 \$ 28.99

5 1/4" Subsystems	
w/two 48TPI SS/DD . . . . .	495.00
w/two 48TPI DS/DD . . . . .	595.00
w/two 96TPI DS/DD . . . . .	695.00

## ★ SPECIAL ★

OF THE MONTH ON  
**MITSUBISHI DS/DD SUBSYSTEM\***



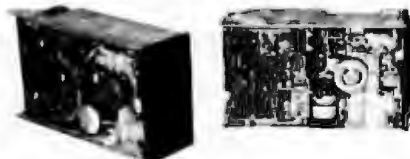
**2.4 MEGABYTES . . . ONLY \$1095.00**

Fully assembled and tested horizontal drive cabinet including fused power supply, fused AC input, fan, all AC and DC cables, 50 pin data cable and **ONE FULL YEAR PARTS AND LABOR WARRANTY** on the complete subsystem including the Mitsubishi 2894 double sided double density drives.

Add \$15.00 for shipping material.  
 \*OFFER EXPIRES JULY 31st 1983

## FLOPPY DRIVES

Buy a set at these reduced prices



8" Shugart 801R SS/DD . . . . .	\$369.00
8" Shugart 851R DS/DD . . . . .	495.00
8" Qume DT-8 DS/DD . . . . .	519.00
8" Mitsubishi 2894 DS/DD . . . . .	465.00
8" Mitsubishi Slimline DS/DD . . . . .	465.00
8" Tandon 848-1 Thinkline SS/DD . . . . .	370.00
8" Tandon 848-2 Thinkline DS/DD . . . . .	470.00
8" Siemens 120-8 SS/DD . . . . .	235.00
5 1/4" Mitsubishi 95 DS/DD Full . . . . .	315.00
5 1/4" Mitsubishi 95 DS/DD 1/2 Height . . . . .	315.00

All Shugart and Mitsubishi drives will have a 1 year parts and labor warranty Qume drives - Full 6 months - All others 90 days.

# ★★★ SYSTEM SPECTACULAR !!! ★★★

OFFER EXPIRES JULY 31st, 1983



The total system includes the XOR S-100-4 Computer System, the ADDS Viewpoint 3A+ terminal, the Star Micronics Gemini 10 printer, and all AC/DC, serial, and RS232 cables with CP/M 2.2 software, manuals and our full SIX MONTH parts and labor warranty.

Order Part #S-1500-01 . . . . . **\$2595.00**

And now a complete system package is available from U.S. Micro Sales featuring the famous S-100-4 Computer System. 64K based Z-80A @ 4MHZ with two Tandon 8" floppies to provide over 1.2 Megabytes of formatted storage. The new ADDS Viewpoint 3A+ with green screen and detachable keyboard makes the perfect terminal with features like reverse video, 1/2 intensity, visual highlighting, and full auxiliary port use. For a printer you'll get the new Gemini 10 dot matrix 80 column by Star Micronics with features like 100 CPS print speed, serial and parallel interfacing, 4K ram buffer, self test, bi-directional print, and single or multi-sheet feed. What more could be asked for?? A full six month parts and labor warranty on the COMPLETE system - warranty includes the disk drives, terminal and printer. We service what we sell. Call your order in today TOLL FREE.

**Visit Our Retail Stores**  
**ORDER TOLL FREE**  
 ☆ EAST ☆ WEST ☆  
**1 (800) 435-9357 1 (800) 854-8174**  
 in Ill. (815) 485-4002 in Calif. 1 (714) 898-1492

**U.S.A. MICRO SALES**  
 ☆ MADE IN U.S.A. BY AMERICANS ☆

**TERMS:** We accept VISA/MC, prepay, check or money order. Please allow personal check two weeks to clear before shipment. \$5.00 handling charge on all orders under \$50.00. 15% Restocking Fee. All orders shipped via U.P.S. unless otherwise specified. All UPS C.O.D. orders over \$100.00 require a Cashiers Check. ☆ Our products carry a full 6 months parts and labor warranty excluding tubes, printers and terminals which carry the full O.E.M. factory warranty. **PRICES SUBJECT TO CHANGE WITHOUT NOTICE.**

☆ EAST ☆ 11 Edison Drive, New Lenox, Illinois 60451  
 ☆ WEST ☆ 15392 Assembly Lane, Huntington Beach, CA 92649

**TERMINALS**

Adds Viewpoint 3A+: A low cost high performance terminal w/green screen and detachable keyboard. Features include ☆ Reverse video ☆ 1/2 intensity ☆ Visual highlighting ☆ Full auxiliary port use ☆ 150 — 19.2K baud rate.

#T-1000-04 ..... \$519.00

Teleideo 910+: Save your eyes on a great green screen w/features like ☆ Built-in self test ☆ Full editing ☆ Tab options ☆ cursor control ☆ 16 visual attributes like, reverse video, monitor mode and 1/2 intensity.

#T-1000-05 ..... \$569.00

Teleideo 925: From the hobbyist to the basic professional this popular terminal will fit your needs. ☆ Detachable keyboard ☆ Numeric keypad ☆ Green screen ☆ Self test ☆ Time of day display ☆ Programmable function keys ☆ 912/920 emulation hardware/software programmable configurations

#T-1000-08 ..... \$739.00

Teleideo 950 #T-1000-09 ..... \$939.00

**PRINTERS**

C-flo® Starwriter F-10: The best you can get in a daisy-wheel letter quality printer with removable print head and speed to 45 C.P.S. Order serial or parallel models — same price. No extra charge for the quiet-low profile design.

F-10 Starwriter Parallel #M-2000-47 ..... \$1475.00  
 F-10 Starwriter Serial #M-2000-31 ..... \$1475.00

Okidata Microline: New versatility, correspondence quality printing and speed make the ML92 and ML93 the best printer values in their categories. Both printers provide multi-speed print modes: bi-directional high speed mode with short line seeking logic at 160cps, emphasized and enhanced mode printing at 80cps, and high resolution correspondence quality printing at 40cps. Dot-addressable graphics is standard. Both serial and parallel interfaces are standard and BOTH prices include full tractor assembly at no extra charge.

ML92 #M-2000-10 ..... \$ 629.00  
 ML93 #M-2000-11 ..... \$ 965.00

Epson FX-80: This is the latest entry from the manufacturer that has taken the printer market by storm by offering the highest quality at very reasonable prices.

One quick glance at the features below should convince you that Epson has created a real winner with the new FX80:

- Burst print speed of 160 cps, continuous speed of 110cps • 11x9 character matrix; 18x18 in emphasized and double size modes • User definable characters
- Internal RAM can function as either 2K print buffer or user-definable character set storage area • Standard Centronics parallel interface • Programmable left margin; 32 horizontal tab stops and 8 sets of 16 vertical tabs.

Introductory offer #M-2000-70 ..... \$599.00  
 Above w/Serial/Int #M-2000-71 ..... \$699.00

The 4 slot S-100 systems below are equipped with the XOR Z-80 4MHZ three board set. Each can run 8" or 5" disk simultaneously. In addition to the high speed XOR mini format, they can read KPRO, IBM and Morrow 5" disk formats. Each has a modular dual power supply sub chassis. They are fan cooled. Standard IO is 2 serial ports and one centronics parallel. Expansion IO is available.

**TWIN 5 1/4" MINI**



★ System less boards and drives ..... \$ 425.00  
 ★ Mini 48TPI SS/DD ..... \$1395.00  
 ★ Mini 48TPI DS/DD ..... \$1495.00  
 ★ Mini 96TPI DS/DD ..... \$1650.00

**5 1/4" HARD DISK**  
 ★ NEW PRODUCT SPECIAL ★



**SALE**

★ w/1 48TPI + 5 Meg ..... ~~\$2395.00~~  
 ★ w/1 96TPI + 5 Meg ..... \$2495.00  
 ★ w/2 96TPI + 5 Meg ..... \$2750.00  
 ★ w/2 96TPI + 10 Meg ..... \$2995.00  
 ★ w/2 96TPI + 20 Meg ..... \$3445.00

**8" MITSUBISHI/TANDON**



★ System less boards + drives ..... \$ 395.00  
 ★ w/2 Mitsubishi DS/DD ..... \$1895.00  
 ★ w/2 Tandon SS/DD ..... \$1725.00


The 12 slot commercial grade S-100 systems below have all of the features listed above plus a massive 30 amp power supply capable of the expansion we expect you will do. All units are cooled by four inch fans. Each system must pass 2 days of constant read and write disk testing without a single error before shipment. **One year complete system warranty is included.**

**BASIC PROFESSIONAL**




★ w/no drives (full board set) ..... \$1350.00  
 ★ w/2 Mitsubishi ..... \$2295.00  
 ★ w/2 Shugart 801R ..... \$2125.00  
 ★ w/2 Shugart 851R ..... \$2425.00  
 ★ w/2 Qume ..... \$2450.00  
 ★ w/2 Mitsubishi/wide ..... \$2295.00

**IOmega S-100-12+**



★ w/1 Iomega + 1 Floppy ..... \$3395.00  
 ★ w/1 Iomega + 2 Floppies ..... \$3715.00  
 ★ w/2 Iomega + 1 Floppy ..... \$3995.00

**PROFESSIONAL 8" HARD DISK TO MP/M**



★ w/20 Meg + 1 Floppy ..... \$4395.00  
 ★ w/40 Meg + 1 Floppy ..... \$4950.00  
 ★ w/85 Meg + 1 Floppy ..... \$5395.00  
 ★ Add Tape Backup ..... \$1495.00  
 ★ Add MP/M ..... \$ 695.00  
 ★ Add per User ..... \$ 250.00



\*Minimum Price of each IC, by way of manufacturer

MICROPROCESSOR COMPONENTS

Digitalker

Table with columns: Part No., Price, Part No., Price, Part No., Price. Lists various microprocessor chips like 8086, 8088, 80286, 80386.

Table with columns: Part No., Price, Part No., Price, Part No., Price. Lists microprocessor chips from the Z80, Z80A, Z80B, Z8000 series.

Table with columns: Part No., Price, Part No., Price, Part No., Price. Lists dynamic RAMs and static RAMs.

DT1050 - Applications: Teaching aids, appliances, clocks, automotive, telecommunications, language translators, etc. The DT1050 is a standard DIGITALTALKER...

DT1050 DigitalTalker™ \$34.95 ea.

DT1057 - Expands the DT1050 vocabulary from 137 to over 280 words. Incl. 2 ROMs in add specs.

DT1057 \$24.95 ea.

RADIO CONTROL CIRCUITS

Ideas to use for: Toys, hobby crafts, robots, trailers - Barrier alarms - 70 data bits - Remote control program controller - Consumer remote data links - Energy-saving, remotely activated lighting systems



LM18218 RC Encoder/Transmitter Chip \$1.95

A complete RF receiver/decoder, used at either 27MHz, 48MHz or 72MHz. It provides 4 independent channels when used with LM1871...

LM1872M RC Receiver/Decoder Chip \$2.40

SRX1504 49.435MHz Crystal (LM1872M) \$3.95

SRX1505 49.850MHz Crystal (LM1871M) \$3.95

Table with columns: Part No., Price, Part No., Price, Part No., Price. Lists various 74LS logic chips.

Table with columns: Part No., Price, Part No., Price, Part No., Price. Lists various 8000/8000 series chips.

Table with columns: Part No., Price, Part No., Price, Part No., Price. Lists various 8000/8000 series chips.

Table with columns: Part No., Price, Part No., Price, Part No., Price. Lists various 8000/8000 series chips.

Table with columns: Part No., Price, Part No., Price, Part No., Price. Lists various 74S logic chips.

Table with columns: Part No., Price, Part No., Price, Part No., Price. Lists various 8000/8000 series chips.

Table with columns: Part No., Price, Part No., Price, Part No., Price. Lists various 8000/8000 series chips.

Table with columns: Part No., Price, Part No., Price, Part No., Price. Lists various 8000/8000 series chips.

Table with columns: Part No., Price, Part No., Price, Part No., Price. Lists various CA-LINEAR chips.

Table with columns: Part No., Price, Part No., Price, Part No., Price. Lists various CD-CMOS chips.

Table with columns: Part No., Price, Part No., Price, Part No., Price. Lists various CD-CMOS chips.

Table with columns: Part No., Price, Part No., Price, Part No., Price. Lists various CD-CMOS chips.

IC SOCKETS

Table with columns: Part No., Price, Part No., Price, Part No., Price. Lists various IC sockets.

\$10.00 Minimum Order - U.S. Funds Only. California Residents Add 6 1/2% Sales Tax. Shipping - Add \$5 plus \$1.50 Insurance.

Jameco Electronics logo and address: 1355 SHOREWAY ROAD, BELMONT, CA 94002. Phone: (415) 582-8097. Telex: 176043.

LINEAR

Table with columns: Part No., Price, Part No., Price, Part No., Price. Lists various linear ICs.

**Portable Speakers For "Walkman" Style Stereos**



**Portable Stereo Speakers with Carrying Case**  
After searching every jogging or other outdoor activity, just plug these portable stereo speakers into your stereo and you and your friends can enjoy your favorite tapes reproduced in your very own speakers. Great for mobile rooms, the stretch of your car. They weigh just 1 lbs. and measure 5 1/2" x 4 1/4" x 2 1/2". This unit uses 3" x 5" 60mm speakers with a 3" of magnet. Speaker system includes two speakers, a carrying case, auxiliary speaker connector cable and signal connector cable. Uses 8 AA batteries. Can be used with both portable stereos shown below, and is compatible with most portable stereo cassette and FM stereo units.  
**Part No. TSU-012 \$29.95**  
**AM3-8 AA Alkaline Batteries \$8 for \$7.90**

**Stereo Cassette Player with FM Stereo Tuner Pack**  
• Lightweight Headphones  
• CrossMetal/Normal Tape Selector  
• Anti-Rolling Mechanism

**Model TWF-802 \$69.95**  
**AM24-4 AA Alkaline Batteries \$453.95**

**CREDIT CARD AM/FM RADIO**  
**World's Thinnest Stereo Hi-Fi**  
This is a pocket-size AM/FM stereo radio with a folding stereo head phone. It weighs just 3 oz. and measures 4 1/2" x 7 1/2" x 1 1/2". Comes complete with radio, headphones and headphone case. Uses two AA alkaline batteries.  
**Part No. TCR-808 \$29.95 each**

**JOYSTICKS**  
JS-5K 5K Linear Taper Pots \$5.25  
JS-100K 100K Linear Taper Pots \$4.95  
JS-150K 150K Linear Taper Pots \$4.75  
JVC-40 40K (2) Video Controller in Case \$9.95  
JS KNOB Knob for JS5K,100K,150K \$4.95 ea.  
JVC KNOB Knob for JVC-40 \$9.95 ea.

**ATARI**  
**ATARI PADDLES**  
JSP (2) \$4.95 pair  
**TV GAME SWITCH**  
Used on Atari. Cosmetically blemished. 100% functional.  
**TGS-1 \$2.95 ea.**

**BOOKS**  
**NATIONAL SEMICONDUCTOR - IN FERREL - INTEL**

30001	National CMOS Data Book (1982)	96 pp	\$6.95
30002	National TTL Data Book (1982)	170 pp	\$6.95
30003	National Linear Data Book (1982)	1378 pp	\$14.95
30004	National TTL Logic Data Book (1981)	624 pp	\$9.95

**30006 Above (3) 30001,3,5 as set \$24.95**

30008	National Memory Data Book (1982)	1326 pp	\$6.95
30009	National Data Book (1982)	1326 pp	\$6.95
30010	National Linear Data Book (1982)	1378 pp	\$14.95
30011	National Linear Application Handbook (1982)	728 pp	\$14.95
30012	National PAL Data Book (1982)	1176 pp	\$6.95
30013	Logic Data Book (1981)	684 pp	\$7.95
30014	Intel Component Data Book (1982)	1420 pp	\$14.95
30015	Intel Peripheral Device Handbook (1981)	520 pp	\$9.95

**Universal Computer Keyboard Enclosures**  
DTE-8 Panel Width 7.5" \$24.95  
DTE-11 Panel Width 10.13" \$27.95  
DTE-14 Panel Width 13.5" \$29.95  
DTE-20 Panel Width 19.25" \$34.95

**KEYBOARDS - POWER SUPPLIES**

<b>DATAMETRIC 73-KEY KEYBOARD (ASCHI)</b> 17 1/2" L x 6 1/2" W x 1 1/2" H Apple Compatible 12-line keyboard with 12-line keyboard 51-key numeric keypad. 35-key function keys. Includes 30-pin Part No. MS201 (P/N 811-1) Extension \$49.95 each	<b>MICRO SWITCH 65-KEY KEYBOARD</b> 22 1/2" L x 5 1/2" W x 1 1/2" H Word Processing Keyboard. 29 Pin Edge Card Connector. Supply Voltage +5VDC. High keyboard is DWRTY. Additional Key Pad for Curve and word processing function. Part No. 855D16-1 \$29.95 each
<b>STACKPOLE 62-KEY KEYBOARD</b> 17 1/2" L x 6 1/2" W x 1 1/2" H 62-key keyboard. Includes numeric keypad. Keyboard is not mounted on a stack board. (See kit or individually available) Part No. K-52 (P/N 871-1) Extension \$34.95 each	<b>HI-TEK 14-KEY NUMERIC KEYPAD</b> 3 1/2" L x 2 1/4" W x 1 1/4" H 8081 assembly. Chertek gray keypad, matches HI-TEK K-52 Keyboard plate. Mounted on printed circuit board. Part No. K-14 \$9.95 each
<b>ALPS 29-KEY CALCULATOR KEYBOARD</b> 9 1/2" L x 4 1/2" W x 1 1/2" H Features one 8-position decimal index switch, one 5-position switch, and two 2-position switches. Part No. MS28740 (P/N 871-1) Extension \$4.95 each	<b>POWER SUPPLY + 5VDC @ 1 AMP REGULATED</b> 24-pin D-sub connector. 115VAC/60Hz. 1.0Amp. 5VDC. Output voltage adjustable. Includes fuse. 3.5" x 6.5" x 1.5" case. Includes 30-pin connector. Part No. P551194 \$19.95 each
<b>POWER SUPPLY + 5VDC @ 3 AMP REGULATED</b> 24-pin D-sub connector. 115VAC/60Hz. 3.0Amp. 5VDC. Output voltage adjustable. Includes fuse. 3.5" x 6.5" x 1.5" case. Includes 30-pin connector. Part No. P551194 \$29.95 each	<b>POWER SUPPLY + 5VDC @ 7.5 AMP 12VDC @ 1.5 AMP SWITCHING</b> 15-pin D-sub connector. 115VAC/60Hz. 7.5Amp. 5VDC. 12VDC. Output voltage adjustable. Includes fuse. 3.5" x 6.5" x 1.5" case. Includes 30-pin connector. Part No. P55410 \$49.95 each
<b>POWER SUPPLY 4-Channel Switching - Apple Compatible</b> 15-pin D-sub connector. 115VAC/60Hz. 4.0Amp. 5VDC. 12VDC. Output voltage adjustable. Includes fuse. 3.5" x 6.5" x 1.5" case. Includes 30-pin connector. Part No. FCS-60A \$69.95 each	<b>POWER SUPPLY Adjustable Switching 4-24VDC to 3 Amps</b> 4-pin D-sub connector. 115VAC/60Hz. 3.0Amp. 4-24VDC. Output voltage adjustable. Includes fuse. 3.5" x 6.5" x 1.5" case. Includes 30-pin connector. Part No. JZ224 Kit \$79.95 each JZ224 Kit \$89.95 each

**JUMPER AND CABLE ASSEMBLIES**

**STANDARD DIP JUMPERS**

Part No.	Description	QTY	PRICE
J101	10-pin jumper	100	\$1.99
J102	12-pin jumper	100	\$2.25
J103	14-pin jumper	100	\$2.50
J104	16-pin jumper	100	\$2.75
J105	18-pin jumper	100	\$3.00
J106	20-pin jumper	100	\$3.25
J107	22-pin jumper	100	\$3.50
J108	24-pin jumper	100	\$3.75
J109	26-pin jumper	100	\$4.00
J110	28-pin jumper	100	\$4.25

**STANDARD DB25 SERIES CABLES**

Part No.	Cable Length	Connectors	Price
DB25-1	4 feet	1 DB25P 25	\$7.95
DB25-2	6 feet	1 DB25P 25	\$9.49
DB25-3	8 feet	2 DB25P 25	\$13.49
DB25-4	10 feet	1 DB25P 25	\$13.75
DB25-5	6 feet	2 DB25P 25	\$13.95

**BUG BOX™ STORAGE SYSTEMS**

**BUG CAGE™ (BUC 001)** - 1 with Bug Beam

**LSI BIG BUG BOX™** - Designed to store large IC's. Features: Capacitance and (Bioses) + stored in this compact compartment measuring 1 1/4" x 1 1/2" x 1 1/2". Includes a 30-pin connector and 30-pin connector. Includes a 30-pin connector and 30-pin connector.

**LSI BIG BUG BOX™** - Same as above, but with 30-pin connector.

**BUG TRAY™** - Same as Bug Cage. Measuring 1 1/4" x 1 1/2" x 1 1/2". Includes a 30-pin connector and 30-pin connector.

**BUG BAG™** - Same as Bug Cage. Measuring 1 1/4" x 1 1/2" x 1 1/2". Includes a 30-pin connector and 30-pin connector.

**CAGE KEEPER™** - Pins column of Bug Boxes in Bug Cage.

**BUG TAGS™** - Self adhesive, easy-to-read labels for marking Bug Bags and LSI Big Bug Boxes.

**ameco ELECTRONICS**  
1355 SHOREWAY ROAD, BELMONT, CA 94002  
800 PHONE ORDERS WELCOME - (415) 592-8097 Telex: 176043

**Call for Quantity Discounts**

**NEW! Telex Number 176043**

**8K, 16K, 32K, 64K EPROM Programmer**



**J664-EPROM PROGRAMMER**  
8K TO 64K EPROMS - 24 AND 28 PIN PACKAGES  
Self-Contained - Requires No Additional Supplies for Operation

• Programs, erases and checks for properly programmed EPROMs • Emulates PROMs in EPROMs • 808232C Compatible Interface for address program loading • Loads data into RAM by keyboard • Changes data in RAM by keyboard • Loads RAM from an EPROM • Compares EPROMs for correct addresses • Checks EPROMs • Power in off 110VAC 60Hz • 100 ohm termination • Lockout • Color-coded light bar panel • Mounted on a bread board • Size 10 1/2" x 7 1/2" x 1 1/2" x 1 1/2" • 5 1/2" x 1 1/2" x 1 1/2"

**J664-A EPROM Programmer \$995.00**  
Acceptance & Tester (Includes 10156 Manual)

**J665 - 80232C INTERFACE OPTION** - The J665 80232C interface is a 28-pin D-sub connector. It is used to connect the J664 to a computer. It is used to connect the J664 to a computer. It is used to connect the J664 to a computer.

**J664-RS EPROM Prog. w/4645 option \$1195.00**  
Includes: Manual (with J664 Manual)

**EPROM JUMPER MODULES** - The J664 is a JUMPER MODULE. It is used to connect the J664 to a computer. It is used to connect the J664 to a computer. It is used to connect the J664 to a computer.

Part No.	EPROM	EPROM MANUFACTURER	PRICE
J664A	2708	AMI Micro Systems	\$14.95
J664B	2716	Intel	\$14.95
J664C	162716	Motorola	\$14.95
J664D	746573	Intel	\$14.95
J664E	7710	AMD	\$14.95
J664F	773212	Intel	\$14.95
J664G	2708	Motorola	\$14.95
J664H	2716	Motorola	\$14.95
J664I	162716	Motorola	\$14.95

**8" Floppy Disk Drive**

- Shugart 801R compatible
- Single-Sided
- 77 Tracks
- 400/800K Bytes Capacity
- Industry Standard

**FDD100-8** Buy 1 for \$269.95 each  
**FDD100-8** Buy 2 for \$259.95 each  
**FDD100-8** Buy 10 for \$249.95 each

**5 1/4" Mini-Floppy Disk Drive**  
For TRS-80 MODEL I (Industry Standard)  
Features single or double density recording mode. Features single or double density recording mode. Features single or double density recording mode.

**FD200** Single-sided, 40 tracks, 280K bytes capacity \$179.95  
**FD250** Double-sided, 34 tracks, 420K bytes capacity \$199.95

**EXPAND YOUR MEMORY**

**TRS-80 to 16K, 32K, or 48K**

**Model 1** - From 4K to 16K Requires (1) One Kit  
**Model 2** - From 4K to 48K Requires (3) One Kit  
**Color** - From 4K to 16K Requires (1) One Kit

**TRS-16K to 250K for Model I** \$12.95  
**TRS-16K to 250K for Model II** \$19.95

**TRS-80 Color 32K or 64K Conversion Kit \$54.95**

All comes complete with 8 each 4164 2 (2000) 64K dynamic RAMs and conversion documentation. Converts TRS-80 color computers with D and E circuit boards, and all new color computers to 32K. Minor modifications to 32K memory will allow the use of all 64K of the dynamic RAM providing you have a FLEX DOS operating system.

**Sprite-style Fan**

- 36cm free air delivery
- 3.125" sq. x 1.65" depth
- 10 ips cool. duty at 20°C
- 115V 50/60Hz

**PWS2107U** \$9.95 ea.  
**PWS2107F** \$14.95 ea.

**Muffin-style Fan**

- 105cm free air delivery
- 4.08" sq. x 1.50" depth
- 10 ips cool. duty at 20°C
- 115V 50/60Hz

**MUZA1-U** \$9.95 ea.  
**MUZA1-N** \$14.95 ea.

**Mostek DC/DC Converter**  
+5 VOLTS TO -9 VOLTS  
Input: +5V Output: 5V regulated at 20mA.  
Printed circuit mounting. Specifications on request.  
DC-10 - \$2.95 ea. or \$24.95



# ADVANCED COMPUTER PRODUCTS

SEND \$2.00 for 1985 CATALOG

## LINEAR

## 7400

7805K	35.95	LM131AN	81.90	7400 S 1V	1075	5.38	7418 J 5 160
7806G	1.99	LM1458CN	49	7401 22	1172	34	7418 J 9 80
78M G	1.99	MC1488N	80	7402 52	1173	480	7418 J 87
LM1084H	2.99	MC1493N	99	7403 27	1179	48	7418 J 87
LM1084CN	99	LM1498N	89	7404 27	1182	55	7418 J 87
LM1084H	1.99	LM1500N	95	7405 15	1185	85	7418 J 105
LM1084H	1.99	LM1500N	95	7406 16	1185	85	7418 J 105
LM1084H	3.25	LM1500N	3.10	7407 36	1186	35	7418 J 105
LM1084H	1.99	LM1500N	3.10	7408 24	1189	170	7418 J 275
LM1084H	1.99	LM1500N	3.10	7409 23	1190	30	7418 J 70
LM1084H	1.99	LM1500N	3.10	7410 22	1191	37	7418 J 70
LM1084H	1.99	LM1500N	3.10	7411 25	1192	45	7418 J 70
LM1084H	1.99	LM1500N	3.10	7412 25	1193	45	7418 J 70
LM1084H	1.99	LM1500N	3.10	7413 29	1194	50	7418 J 70
LM1084H	1.99	LM1500N	3.10	7414 29	1195	55	7418 J 70
LM1084H	1.99	LM1500N	3.10	7415 29	1196	55	7418 J 70
LM1084H	1.99	LM1500N	3.10	7416 29	1197	55	7418 J 70
LM1084H	1.99	LM1500N	3.10	7417 29	1198	55	7418 J 70
LM1084H	1.99	LM1500N	3.10	7418 29	1199	55	7418 J 70
LM1084H	1.99	LM1500N	3.10	7419 29	1200	55	7418 J 70
LM1084H	1.99	LM1500N	3.10	7420 29	1201	55	7418 J 70
LM1084H	1.99	LM1500N	3.10	7421 35	1202	32	7418 J 225
LM1084H	1.99	LM1500N	3.10	7422 29	1203	32	7418 J 225
LM1084H	1.99	LM1500N	3.10	7423 29	1204	105	7418 J 225
LM1084H	1.99	LM1500N	3.10	7424 29	1205	30	7418 J 300
LM1084H	1.99	LM1500N	3.10	7425 29	1206	30	7418 J 300
LM1084H	1.99	LM1500N	3.10	7426 29	1207	30	7418 J 300
LM1084H	1.99	LM1500N	3.10	7427 29	1208	30	7418 J 300
LM1084H	1.99	LM1500N	3.10	7428 29	1209	30	7418 J 300
LM1084H	1.99	LM1500N	3.10	7429 29	1210	30	7418 J 300
LM1084H	1.99	LM1500N	3.10	7430 29	1211	30	7418 J 300
LM1084H	1.99	LM1500N	3.10	7431 35	1212	35	7418 J 300
LM1084H	1.99	LM1500N	3.10	7432 35	1213	35	7418 J 300
LM1084H	1.99	LM1500N	3.10	7433 35	1214	35	7418 J 300
LM1084H	1.99	LM1500N	3.10	7434 35	1215	35	7418 J 300
LM1084H	1.99	LM1500N	3.10	7435 35	1216	35	7418 J 300
LM1084H	1.99	LM1500N	3.10	7436 35	1217	35	7418 J 300
LM1084H	1.99	LM1500N	3.10	7437 35	1218	35	7418 J 300
LM1084H	1.99	LM1500N	3.10	7438 35	1219	35	7418 J 300
LM1084H	1.99	LM1500N	3.10	7439 35	1220	35	7418 J 300
LM1084H	1.99	LM1500N	3.10	7440 35	1221	35	7418 J 300
LM1084H	1.99	LM1500N	3.10	7441 35	1222	35	7418 J 300
LM1084H	1.99	LM1500N	3.10	7442 35	1223	35	7418 J 300
LM1084H	1.99	LM1500N	3.10	7443 35	1224	35	7418 J 300
LM1084H	1.99	LM1500N	3.10	7444 35	1225	35	7418 J 300
LM1084H	1.99	LM1500N	3.10	7445 35	1226	35	7418 J 300
LM1084H	1.99	LM1500N	3.10	7446 35	1227	35	7418 J 300
LM1084H	1.99	LM1500N	3.10	7447 35	1228	35	7418 J 300
LM1084H	1.99	LM1500N	3.10	7448 35	1229	35	7418 J 300
LM1084H	1.99	LM1500N	3.10	7449 35	1230	35	7418 J 300
LM1084H	1.99	LM1500N	3.10	7450 35	1231	35	7418 J 300
LM1084H	1.99	LM1500N	3.10	7451 35	1232	35	7418 J 300
LM1084H	1.99	LM1500N	3.10	7452 35	1233	35	7418 J 300
LM1084H	1.99	LM1500N	3.10	7453 35	1234	35	7418 J 300
LM1084H	1.99	LM1500N	3.10	7454 35	1235	35	7418 J 300
LM1084H	1.99	LM1500N	3.10	7455 35	1236	35	7418 J 300
LM1084H	1.99	LM1500N	3.10	7456 35	1237	35	7418 J 300
LM1084H	1.99	LM1500N	3.10	7457 35	1238	35	7418 J 300
LM1084H	1.99	LM1500N	3.10	7458 35	1239	35	7418 J 300
LM1084H	1.99	LM1500N	3.10	7459 35	1240	35	7418 J 300
LM1084H	1.99	LM1500N	3.10	7460 35	1241	35	7418 J 300
LM1084H	1.99	LM1500N	3.10	7461 35	1242	35	7418 J 300
LM1084H	1.99	LM1500N	3.10	7462 35	1243	35	7418 J 300
LM1084H	1.99	LM1500N	3.10	7463 35	1244	35	7418 J 300
LM1084H	1.99	LM1500N	3.10	7464 35	1245	35	7418 J 300
LM1084H	1.99	LM1500N	3.10	7465 35	1246	35	7418 J 300
LM1084H	1.99	LM1500N	3.10	7466 35	1247	35	7418 J 300
LM1084H	1.99	LM1500N	3.10	7467 35	1248	35	7418 J 300
LM1084H	1.99	LM1500N	3.10	7468 35	1249	35	7418 J 300
LM1084H	1.99	LM1500N	3.10	7469 35	1250	35	7418 J 300
LM1084H	1.99	LM1500N	3.10	7470 35	1251	35	7418 J 300
LM1084H	1.99	LM1500N	3.10	7471 35	1252	35	7418 J 300
LM1084H	1.99	LM1500N	3.10	7472 35	1253	35	7418 J 300
LM1084H	1.99	LM1500N	3.10	7473 35	1254	35	7418 J 300
LM1084H	1.99	LM1500N	3.10	7474 35	1255	35	7418 J 300
LM1084H	1.99	LM1500N	3.10	7475 35	1256	35	7418 J 300
LM1084H	1.99	LM1500N	3.10	7476 35	1257	35	7418 J 300
LM1084H	1.99	LM1500N	3.10	7477 35	1258	35	7418 J 300
LM1084H	1.99	LM1500N	3.10	7478 35	1259	35	7418 J 300
LM1084H	1.99	LM1500N	3.10	7479 35	1260	35	7418 J 300
LM1084H	1.99	LM1500N	3.10	7480 35	1261	35	7418 J 300
LM1084H	1.99	LM1500N	3.10	7481 35	1262	35	7418 J 300
LM1084H	1.99	LM1500N	3.10	7482 35	1263	35	7418 J 300
LM1084H	1.99	LM1500N	3.10	7483 35	1264	35	7418 J 300
LM1084H	1.99	LM1500N	3.10	7484 35	1265	35	7418 J 300
LM1084H	1.99	LM1500N	3.10	7485 35	1266	35	7418 J 300
LM1084H	1.99	LM1500N	3.10	7486 35	1267	35	7418 J 300
LM1084H	1.99	LM1500N	3.10	7487 35	1268	35	7418 J 300
LM1084H	1.99	LM1500N	3.10	7488 35	1269	35	7418 J 300
LM1084H	1.99	LM1500N	3.10	7489 35	1270	35	7418 J 300
LM1084H	1.99	LM1500N	3.10	7490 35	1271	35	7418 J 300
LM1084H	1.99	LM1500N	3.10	7491 35	1272	35	7418 J 300
LM1084H	1.99	LM1500N	3.10	7492 35	1273	35	7418 J 300
LM1084H	1.99	LM1500N	3.10	7493 35	1274	35	7418 J 300
LM1084H	1.99	LM1500N	3.10	7494 35	1275	35	7418 J 300
LM1084H	1.99	LM1500N	3.10	7495 35	1276	35	7418 J 300
LM1084H	1.99	LM1500N	3.10	7496 35	1277	35	7418 J 300
LM1084H	1.99	LM1500N	3.10	7497 35	1278	35	7418 J 300
LM1084H	1.99	LM1500N	3.10	7498 35	1279	35	7418 J 300
LM1084H	1.99	LM1500N	3.10	7499 35	1280	35	7418 J 300
LM1084H	1.99	LM1500N	3.10	7500 35	1281	35	7418 J 300

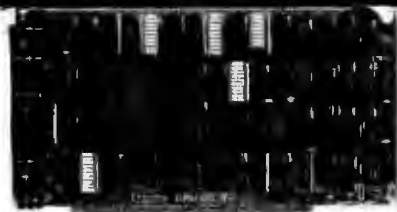
7400 S 1V	1075	5.38	7418 J 5 160
7401 22	1172	34	7418 J 9 80
7402 52	1173	480	7418 J 87
7403 27	1179	48	7418 J 87
7404 27	1182	55	7418 J 87
7405 15	1185	85	7418 J 105
7406 16	1185	85	7418 J 105
7407 36	1186	35	7418 J 105
7408 24	1189	170	7418 J 275
7409 23	1190	30	7418 J 70
7410 22	1191	37	7418 J 70
7411 25	1192	45	7418 J 70
7412 25	1193	45	7418 J 70
7413 29	1194	50	7418 J 70
7414 29	1195	55	7418 J 70
7415 29	1196	55	7418 J 70
7416 29	1197	55	7418 J 70
7417 29	1198	55	7418 J 70
7418 29	1199	55	7418 J 70
7419 29	1200	55	7418 J 70
7420 29	1201	55	7418 J 70
7421 35	1202	32	7418 J 225
7422 29	1203	32	7418 J 225
7423 29	1204	105	7418 J 225
7424 29	1205	30	7418 J 300
7425 29	1206	30	7418 J 300
7426 29	1207	30	7418 J 300
7427 29	1208	30	7418 J 300
7428 29	1209	30	7418 J 300
7429 29	1210	30	7418 J 300
7430 29	1211	30	7418 J 300
7431 35	1212	35	7418 J 300
7432 35	1213	35	7418 J 300
7433 35	1214	35	7418 J 300
7434 35	1215	35	7418 J 300
7435 35	1216	35	7418 J 300
7436 35	1217	35	7418 J 300
7437 35	1218	35	7418 J 300
7438 35	1219	35	7418 J 300
7439 35	1220	35	7418 J 300
7440 35	1221	35	7418 J 300
7441 35	1222	35	7418 J 300
7442 35	1223	35	7418 J 300
7443 35	1224	35	7418 J 300
7444 35	1225	35	7418 J 300
7445 35	1226	35	7418 J 300
7446 35	1227	35	7418 J 300
7447 35	1228	35	7418 J 300
7448 35	1229	35	7418 J 300
7449 35	1230	35	7418 J 300
7450 35	1231	35	7418 J 300
7451 35	1232	35	7418 J 300
7452 35	1233	35	7418 J 300
7453 35	1234	35	7418 J 300
7454 35	1235	35	7418 J 300
7455 35	1236	35	7418 J 300
7456 35	1237	35	7418 J 300
7457 35	1238	35	7418 J 300
7458 35	1239	35	7418 J 300
7459 35	1240	35	7418 J 300
7460 35	1241	35	7418 J 300
7461 35	1242	35	7418 J 300
7462 35	1243	35	7418 J 300
7463 35	1244	35	7418 J 300
7464 35	1245	35	7418 J 300
7465 35	1246	35	7418 J 300
7466 35	1247	35	7418 J 300
7467 35	1248	35	7418 J 300
7468 35	1249	35	7418 J 300
7469 35	1250	35	7418 J 300
7470 35	1251	35	7418 J 300
7471 35	1252	35	7418 J





THERE ARE NO BETTER BOARDS — THERE ARE NO BETTER PRICES!

# CompuPro FROM PRIORITY ONE ELECTRONICS



## CPU BOARDS CO-PROCESSOR 8086/8087

18 bit 8 or 10 MHz 8086 CPU with sockets for 8087 and 80130

Part No.	Description	List Price	Our Price
8087108A	A&T 8MHz 8086 only	\$750.00	\$469.00
8087108C	CSC 10MHz 8086 only	\$850.00	\$764.00
8087108A7	A&T with 8087 option	\$1050.00	\$830.00
8087108C7	CSC with 8087 option*	\$1150.00	\$1086.00

### (816) DUAL PROCESSOR 8085-8086

6 or 8 MHz provides true 18 Bit Power with a standard 8 bit S-100 bus

80871012A	A&T 6MHz	\$495.00	\$439.00
80871012C	CSC 6/8 MHz	\$595.00	\$529.00

### 68K - 68000 16 BIT CPU

16 bit 8 or 10 MHz on-board sockets for 2716, 2732, or 2784 EPROMs for up to 8K x 16 of memory

8087104A	A&T 8MHz	\$895.00	\$826.00
8087104C	CSC 10MHz	\$850.00	\$786.00

### FORTH OPERATING SYSTEM FOR 68K CPU

Requires a DISK 1, 64K of CompuPro memory, and an INTERFACER 3 or 4.

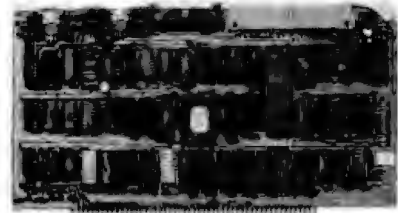
8087080K5	FORTH operating system		\$200.00
-----------	------------------------	--	----------

### CPUZ - Z808 CPU NOW 6MHz!

3/8 MHz Z808 CPU with 24 Bit Addressing. FASTEST Z80 CPU AVAILABLE!

8087106A	3/8 MHz A&T	\$325.00	\$280.00
8087106C	3/8 MHz CSC	\$425.00	\$376.00

## DMA DISC CONTROLLER CP/M 2.2 FOR FREE!\*



\*When 2 or more 8" disk drives are purchased with Disk 1 Controller.

### DISK CONTROLLERS

#### DISK 1 FLOPPY CONTROLLER - OUR BEST!

Fast DMA, Soft Sector, Controls Up to Four 8" or 5 1/4" Single or Double Density Drives.

80870112PM	A&T w/CPM 2.2 & BIOS	\$670.00	\$495.00
------------	----------------------	----------	----------

\*When purchased with two 8" disk drives only.

80870112PM	CSC w/CPM 2.2 & BIOS	\$770.00	\$596.00
------------	----------------------	----------	----------

8087117A	Disk 1 Controller A&T	\$495.00	\$448.00
----------	-----------------------	----------	----------

8087117C	Disk 1 Controller CSC	\$595.00	\$560.00
----------	-----------------------	----------	----------

8087CP000	CP/M 2.2 for Z80/8085 w/manual & BIOS 8" S/D disk		\$174.00
-----------	---	--	----------

8087CP004	CP/M 2.2 for 8086 w/manual & BIOS 8" S/D disk.		\$296.00
-----------	--	--	----------

### DISK 2/SELECTOR CHANNEL HARD DISK CONTROLLER

Fas! DMA 2 board set, controls 4 Shugart 4000 series or Fujitsu 2300 type drives. Includes CP/M 2.2

8087117A	Assembled & Tested	\$795.00	\$750.00
----------	--------------------	----------	----------

8087117C	CSC	\$895.00	\$850.00
----------	-----	----------	----------



### CMOS RAM SALE!

#### RAM 17 - 64K CMOS STATIC RAM

12 MHz, RAM 17, 2 Wait, DMA Compatible 24 Bit Addressing

Part No.	Description	List Price	Our Price
8087176AA	64K A&T 12MHz	\$499.00	\$469.00
8087176CA	64K CSC 12MHz	\$599.00	\$560.00

#### RAM 16 - 32K x 16 BIT CMOS STATIC RAM

8 and/or 16 Bit

(816) 12 MHz, RAM 16, 32K x 16 or 64K x 8

IEEE/696 16 Bit 2 Wait, 24 Bit Addressing

8087109A	64K A&T 12MHz	\$550.00	\$510.00
----------	---------------	----------	----------

8087109C	64K CSC 12MHz	\$650.00	\$610.00
----------	---------------	----------	----------



#### NEW! RAM 21 - 128K STATIC RAM

816 RAM 21 12MHz, 128K x 8 or 64K x 16

IEEE/696 8 or 16 Bit, 1.2 Amps, 24 Bit Addressing

8087109A	128K A&T	\$1095.00	\$998.00
----------	----------	-----------	----------

8087109C	128K CSC	\$1245.00	\$1126.00
----------	----------	-----------	-----------

### M-DRIVE SOLID STATE DISK DRIVE, 3500% FASTER!

Not really, but the next best thing for CompuPro 8085/88 Users. Call for Details on M-Drive.

M-Drive requires a 8MHz CPU 8085/88 dual processor, Disk 1 DMA disk controller and System Support 1 Multifunction Board.

M-Drive requires a 8MHz CPU 8085/88 dual processor, Disk 1 DMA disk controller and System Support 1 Multifunction Board.

M-Drive requires a 8MHz CPU 8085/88 dual processor, Disk 1 DMA disk controller and System Support 1 Multifunction Board.

M-Drive requires a 8MHz CPU 8085/88 dual processor, Disk 1 DMA disk controller and System Support 1 Multifunction Board.

M-Drive requires a 8MHz CPU 8085/88 dual processor, Disk 1 DMA disk controller and System Support 1 Multifunction Board.

M-Drive requires a 8MHz CPU 8085/88 dual processor, Disk 1 DMA disk controller and System Support 1 Multifunction Board.

M-Drive requires a 8MHz CPU 8085/88 dual processor, Disk 1 DMA disk controller and System Support 1 Multifunction Board.

M-Drive requires a 8MHz CPU 8085/88 dual processor, Disk 1 DMA disk controller and System Support 1 Multifunction Board.

M-Drive requires a 8MHz CPU 8085/88 dual processor, Disk 1 DMA disk controller and System Support 1 Multifunction Board.

M-Drive requires a 8MHz CPU 8085/88 dual processor, Disk 1 DMA disk controller and System Support 1 Multifunction Board.

M-Drive requires a 8MHz CPU 8085/88 dual processor, Disk 1 DMA disk controller and System Support 1 Multifunction Board.

M-Drive requires a 8MHz CPU 8085/88 dual processor, Disk 1 DMA disk controller and System Support 1 Multifunction Board.

M-Drive requires a 8MHz CPU 8085/88 dual processor, Disk 1 DMA disk controller and System Support 1 Multifunction Board.

M-Drive requires a 8MHz CPU 8085/88 dual processor, Disk 1 DMA disk controller and System Support 1 Multifunction Board.

M-Drive requires a 8MHz CPU 8085/88 dual processor, Disk 1 DMA disk controller and System Support 1 Multifunction Board.

M-Drive requires a 8MHz CPU 8085/88 dual processor, Disk 1 DMA disk controller and System Support 1 Multifunction Board.

M-Drive requires a 8MHz CPU 8085/88 dual processor, Disk 1 DMA disk controller and System Support 1 Multifunction Board.

M-Drive requires a 8MHz CPU 8085/88 dual processor, Disk 1 DMA disk controller and System Support 1 Multifunction Board.

M-Drive requires a 8MHz CPU 8085/88 dual processor, Disk 1 DMA disk controller and System Support 1 Multifunction Board.

M-Drive requires a 8MHz CPU 8085/88 dual processor, Disk 1 DMA disk controller and System Support 1 Multifunction Board.

M-Drive requires a 8MHz CPU 8085/88 dual processor, Disk 1 DMA disk controller and System Support 1 Multifunction Board.

M-Drive requires a 8MHz CPU 8085/88 dual processor, Disk 1 DMA disk controller and System Support 1 Multifunction Board.

M-Drive requires a 8MHz CPU 8085/88 dual processor, Disk 1 DMA disk controller and System Support 1 Multifunction Board.

M-Drive requires a 8MHz CPU 8085/88 dual processor, Disk 1 DMA disk controller and System Support 1 Multifunction Board.

M-Drive requires a 8MHz CPU 8085/88 dual processor, Disk 1 DMA disk controller and System Support 1 Multifunction Board.

M-Drive requires a 8MHz CPU 8085/88 dual processor, Disk 1 DMA disk controller and System Support 1 Multifunction Board.

M-Drive requires a 8MHz CPU 8085/88 dual processor, Disk 1 DMA disk controller and System Support 1 Multifunction Board.

M-Drive requires a 8MHz CPU 8085/88 dual processor, Disk 1 DMA disk controller and System Support 1 Multifunction Board.

M-Drive requires a 8MHz CPU 8085/88 dual processor, Disk 1 DMA disk controller and System Support 1 Multifunction Board.

M-Drive requires a 8MHz CPU 8085/88 dual processor, Disk 1 DMA disk controller and System Support 1 Multifunction Board.

M-Drive requires a 8MHz CPU 8085/88 dual processor, Disk 1 DMA disk controller and System Support 1 Multifunction Board.

M-Drive requires a 8MHz CPU 8085/88 dual processor, Disk 1 DMA disk controller and System Support 1 Multifunction Board.

M-Drive requires a 8MHz CPU 8085/88 dual processor, Disk 1 DMA disk controller and System Support 1 Multifunction Board.

M-Drive requires a 8MHz CPU 8085/88 dual processor, Disk 1 DMA disk controller and System Support 1 Multifunction Board.

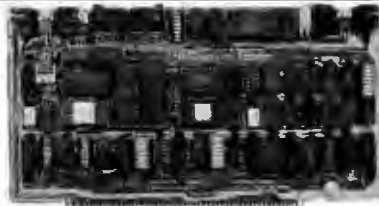
M-Drive requires a 8MHz CPU 8085/88 dual processor, Disk 1 DMA disk controller and System Support 1 Multifunction Board.

M-Drive requires a 8MHz CPU 8085/88 dual processor, Disk 1 DMA disk controller and System Support 1 Multifunction Board.

M-Drive requires a 8MHz CPU 8085/88 dual processor, Disk 1 DMA disk controller and System Support 1 Multifunction Board.

M-Drive requires a 8MHz CPU 8085/88 dual processor, Disk 1 DMA disk controller and System Support 1 Multifunction Board.

M-Drive requires a 8MHz CPU 8085/88 dual processor, Disk 1 DMA disk controller and System Support 1 Multifunction Board.



### I/O BOARDS

#### SYSTEM SUPPORT 1 MULTIFUNCTION BOARD

Serial port (software prog. baud), 4K RAM included, 16 levels of interrupt, real time clock, optional math processor

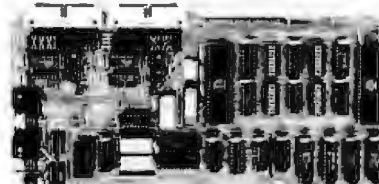
Part No.	Description	List Price	Our Price
8087102A	Assembled & Tested	\$450.00	\$385.00
8087102C	CSC	\$550.00	\$485.00
80871021	Math Chip		\$106.00
80871022	Math Chip		\$106.00
8087102A1	A&T w/8231 Math Chip		\$570.00
8087102C1	CSC w/8231 Math Chip		\$670.00
8087102A2	A&T w/8232 Math Chip		\$570.00
8087102C2	CSC w/8232 Math Chip		\$670.00

### MPX CHANNEL BOARDS

I/O Multiplexer, using 8085A-2 CPU on board w/16K RAM

8087100A10	Assembled & Tested	\$649.00	\$564.00
------------	--------------------	----------	----------

8087100C11	CSC	\$749.00	\$674.00
------------	-----	----------	----------



### INTERFACER 1

Two Serial I/O

8087133A	Assembled & Tested	\$295.00	\$250.00
----------	--------------------	----------	----------

8087133C	CSC	\$370.00	\$329.00
----------	-----	----------	----------

### INTERFACER 2

Three parallel, one serial I/O board

8087106A	Assembled & Tested	\$325.00	\$280.00
----------	--------------------	----------	----------

8087106C	CSC	\$399.00	\$359.00
----------	-----	----------	----------

### INTERFACER 3

Eight-channel multi-user serial I/O board

8087148A	Assembled & Tested	\$699.00	\$626.00
----------	--------------------	----------	----------

8087148C	CSC 200 hr. 8 port	\$849.00	\$748.00
----------	--------------------	----------	----------

8087145A	Assembled & Tested	\$599.00	\$558.00
----------	--------------------	----------	----------

8087145C	CSC 200 hr. 5 port	\$699.00	\$626.00
----------	--------------------	----------	----------



### INTERFACER 4

Three Serial, 1 Parallel, 1 Centronics Parallel

8087107A	Assembled & Tested	\$450.00	\$390.00
----------	--------------------	----------	----------

8087107C	CSC	\$540.00	\$470.00
----------	-----	----------	----------

### S-100 MOTHERBOARDS

Active termination, 6-12-20 Slot

8087153A	A&T 6 slot, 2 lbs.	\$140.00	\$125.00
----------	--------------------	----------	----------

8087153C	CSC 6 slot, 2 lbs.	\$190.00	\$165.00
----------	--------------------	----------	----------

8087154A	A&T 12 slot, 3 lbs.	\$175.00	\$155.00
----------	---------------------	----------	----------

8087154C	CSC 12 slot, 3 lbs.	\$240.00	\$220.00
----------	---------------------	----------	----------

8087155A	A&T 20 slot, 4 lbs.	\$265.00	\$235.00
----------	---------------------	----------	----------

8087155C	CSC 20 slot, 4 lbs.	\$340.00	\$310.00
----------	---------------------	----------	----------

RETAIL STORE PHONE NUMBERS: (Chatsworth:) (213) 709-5464 - (Irvine:) (714) 660-1411

Circle 368 on inquiry card.



**WORLD'S BEST SELLING TERMINAL**  
Extra Memory Pages  
**FREE!**

- 80P017822P\* \$748.00  
\*TeleVideo 925 w/free 2nd page memory kit, a \$95.00 Value!
- 80P017854P\* \$848.00  
\*TeleVideo 950 w/free 2nd, 3rd & 4th page memory kit, \$285.00 value!
- 80T1011 \$848.00  
With emulators & foreign languages



**BEST BUYS!**

**1200 BAUD AUTO-DIAL**  
HAYES SMARTMODEM COMPATIBLE



**MODEMS**  
**\$495.00**

The **AUTO DIAL 212A** Modem is a direct connect 0-300 or 1200 baud modem capable of dialing and calling for you. The **AUTO DIAL 212A** is compatible in function to the DC Hayes **SMARTMODEM**.

Part No.	Description	List Price	SALE Price
80Q88AM1212A	0-300/1200 baud dialing modem	\$599.00	<b>\$495.00</b>

**FREEDOM 50**

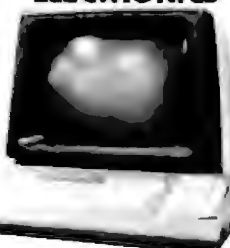
- 9 cursor control keys
- 7 editing function keys
- Programmable protection
- Multi-emulations
- Green screen 12"
- Tilt Base
- 5 function keys

80L10F50 (Sh. Wt. 34 lbs.)  
List Price: \$599.00

**SALE PRICE:**

**\$475**

**LIBERTY ELECTRONICS**



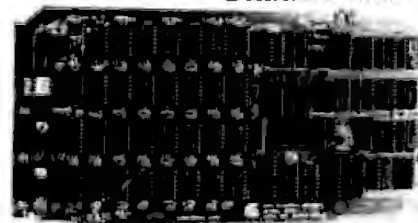
**FREEDOM 100**

Contains all of the above features of the **FREEDOM 50** plus 5 additional function keys, 7 character sets, 15 special graphics symbols, and block mode transmission. (Sh. Wt. 34 lbs.)

80L10F100 **SALE PRICE: \$525.00**  
List Price \$649.00



**64K**  
**IEEE/S-100**  
**DYNAMIC RAM**



**2 or 4MHz BANK SELECTABLE**

- 2 or 4MHz operation • Designed to IEEE proposed S-100 bus standard • Operates with either an 8080 or 2-80 based S-100 system providing processor transparent refreshes with both • Bank-select system allows system memory expansion • Any 16K block can be made bank-independent • All 64K can be made bank-enabled on and reset • Supports DMA • Jumper-selectable Phantom input • Assembled & Tested • Uses Popular 4116 RAMs

REGULAR LIST PRICE IS \$375.00

**\$175.00 ea.**  
**4/\$640.00**

80CCS20853 (Sh. Wt. 2 lbs.)

**DUAL QUME 8" FLOPPY DRIVE,**  
**CABINET, DMA S-100**  
**CONTROLLER,**  
**AND CP/M®**  
**FROM**

**CompuPro**

**ABSOLUTELY THE MOST COST EFFECTIVE**  
**DISK SUBSYSTEM EVER OFFERED**  
**BY PRIORITY ONE ELECTRONICS!!**



**YOU SAVE**  
**\$149.77!!**

- 2 Double-sided 8" QUMC VIII disk drives
  - DMA floppy controller (expandable to 4 drives)
  - CP/M 2.2 w/bug fix for the Disk I Controller
  - Cabinet w/ sales literature, setup & internal disk cables
  - 1 external disk controller (sold)
- (Shipping freight collect)
- | Part No.  | List Price |
|-----------|------------|
| 80BT2085P | \$2325.00  |
| 80BT171A  | \$495.00   |
| 80T1CPM80 | \$175.00   |
| 80C80S60A | \$ 19.77   |
- 83014 77

**CABINET AND 2 QUME DT8 DOUBLE SIDED DRIVES**  
**PROVIDE 2.4 MBYTES OF MASS STORAGE!!**

**CompuPro™ UN-SYSTEM 816**

**FOR THOSE WHO DEMAND EXCELLENCE!**



Each CompuPro system contains the same nucleus of common hardware and software. This insures compatibility between systems as well as allowing you to expand as your needs grow. The following is a list of the basic hardware components as well as software.

- HARDWARE:**
- Desk top Enclosure 20 slots
  - Floppy disk enclosure with 2 Qume DT8 drives
  - DMA Floppy Controller
  - 8085/8088 CPU operates 8 or 16 software
  - Memory in the form of RAM 12s
  - System support 1 (Clock/calendar, RAM/ROM/math processor options, RS-232C Serial port, dual interrupt controllers, triple interval timers, and more)
  - All internal cables

- SOFTWARE:**
- CP/M 2.2™ and CP/M 86™
  - M Drive Software - allows the use of memory as another disk drive
  - Sorcim's SUPERCALC 86™
  - Ashton Tale's DBase II

**DIG DEEP!! Now is the time to buy the CompuPro UN-SYSTEM 816!!**

SAVE MONEY, and have an UN-SYSTEM 816 for your very own!! All UN-SYSTEMS contain the very same components as the SYSTEM 816s listed in our Winter 1983 Engineering Selection Guide, but are not installed or configured. All it takes is your professional computer experience and knowledge to have the highest performing S-100 computer system on the market today. BEWARE! This is not for the novice and inexperienced user, as it requires a well-matured knowledge in system integration procedures.

**So, WHY WAIT? Don't Pass Up This Incredible Deal!!**

Each component of the UN-SYSTEM 816 has been assembled and individually tested. Final installation and configuration are the sole responsibility of the purchaser.

**UN-SYSTEM 816/A**  
**ENTRY LEVEL - SINGLE USER**

Disk storage: 2.4 Megabytes. Expandable to 4.8 Megabytes  
Main memory: 128K - expandable to 1 Megabyte  
Serial Ports: 4 / Parallel Ports: 1  
Centronics/Epson ports: 1  
Software: CP/M 2.2™, CP/M-86™, M-Drive, SuperCalc-86, dBase  
Component List Price: \$6705.00

**OUR SALE PRICE: \$4795.00**  
**SAVE \$1910.00!!**

**UN-SYSTEM 816/B**  
**ENHANCED HIGH PERFORMANCE SINGLE USER SYSTEM**

Disk Storage: 2.4 Megabytes. Expandable to 4.8 Megabytes.  
Main memory: 256K - expandable to 1 Megabyte  
Serial ports: 6  
Software: CP/M 2.2™, CP/M-86™, M-Drive, SuperCalc-86™, dBase II™  
Component List Price: \$8497.00

**OUR SALE PRICE: \$5795.00**  
**SAVE \$2702.00!!**

**UN-SYSTEM 816/C**  
**HIGH PERFORMANCE MULTI-USER SYSTEM**

Disk storage: 2.4 Megabytes. Expandable to 4.8 Megabytes.  
Main memory: 384K - expandable to 1 Megabyte  
Serial ports: 9  
Software: CP/M 2.2™, CP/M-86™, MP/M-8-16™, M-Drive, SuperCalc-86™, dBase II™  
Component List Price: \$10,636.00

**OUR SALE PRICE: \$7595.00**  
**SAVE \$3041.00!!**

**VISA PRIORITY ONE ELECTRONICS MasterCard**

**ORDER TOLL FREE (800) 423-5922 - CA, AK, HI CALL (213) 709-5111**  
Terms: U.S. VISA, MC, BAC, Check, Money Order, U.S. Funds Only. CA residents add 6% Sales Tax. MINIMUM PREPAID ORDER \$15.00. Include MINIMUM SHIPPING & HANDLING of \$3.00 for the first 3 lbs. plus 40¢ for each additional pound. Orders over 50 lbs. sent freight collect. Just in case, please include your phone number. Prices subject to change without notice. We will do our best to maintain prices through May, 1983. Credit Card orders will be charged appropriate freight. If you haven't received your Winter '83 Engineering Selection guide, send \$1.00 for your copy today! Sale prices for prepaid orders only.

**RETAIL STORE PHONE NUMBERS: (Chatsworth:) (213) 709-5464 - (Irvine:) (714) 660-1411**  
Circle 368 on inquiry card.



## SIEMENS FDD100-8

# 8" FLOPPY DISK DRIVE

### SINGLE SIDED, DOUBLE DENSITY SHUGART 801R COMPATIBLE

**90 DAY WARRANTY!**

**ONCE AGAIN YOU  
RECEIVE THE  
BENEFIT OF OUR  
UNEQUALLED PUR-  
CHASING POWER!**



Eq. **\$225.00**  
2-9 **\$199.00**  
10+ **CALL**

**ORDER NOW AND SAVE!**

DEM INQUIRIES INVITED  
(Include \$7.00 per drive for shipping)  
#SIEFDD1008

## NEW LOW PRICES!



### 5 1/4" DISK DRIVES

#0 MP101*	Single-Sided Double-Density 48 TPI	\$200.00
#0 MP102*	Double-Sided Double-Density 48 TPI	\$270.00
#0 MP101*	Single-Sided Double-Density 96 TPI	\$275.00
#0 MP102*	Double-Sided Double-Density 96 TPI	\$400.00

\*Replace "1" when ordering, with "M" for MPI style bezel or "S" for Shugart style bezel. (Shipping Weight 5 lbs.)

### 2" HIGH 8" DISK DRIVES



The first 2" high 8" disk drive allows for mounting under the keyboard on CRT, etc.  
NO AC Required +5V +24VDC only  
FAST 3 msec track-to-track

#0 MP141M	1/2 High 1 side double-density	\$380.00
#0 MP142M	1/2 High 2 side double-density	\$480.00
#0 MP141S	Full height 1 side single drive, dble-density	\$365.00
#0 MP142S	Full height 2 sided single drive, dble-density	\$460.00
#0 MP141D	Full height 1 side dual drive, dble-density	\$700.00
#0 MP142D	Full height 2 side dual drive, dble-density	\$820.00

(Shipping Weight: 11 lbs per drive)

## S-100 DUAL 8" SUBSYSTEM

#0 CCS2422A	S-100 Disk Controller with CP/M 2.2	1 \$399.00
#0 SIEFDD1000	Siemens Double Density 8" drive	2 \$398.00
#0 IIFDE002	Dual Horizontal Cabinet with Power Supply and Data Cable	1 \$295.00

**1 \$35.00**  
**\$1127.00**

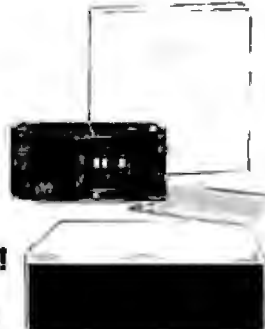
SAVE \$132.00!!

# \$995.00

(Include \$30.00 for shipping)

**DON'T MISS OUT!**

Order No. #PDBSIESUB1



## BUY DRIVE AND CABINET TOGETHER AND SAVE!



**INTERNATIONAL INSTRUMENTATION, INC.**



### DUAL 8" SIEMENS FDD100B, DUAL 8" CABINET POWER SUPPLY AND INTERNAL POWER CABLES

IF BOUGHT SEPARATELY: \$890.00

# PRICED AT: \$675.00

#PDBSIESUB1  
**ENVIRONMENT MONITOR PANEL**

Temperature and voltage monitor with visual and audible alarm for overtemp condition. Direct Digital Readout of internal temperature in C on standard 0-9V

#0 IIFDE002	CABINET ONLY (SH Wt 38 lbs.)	\$295.00
#0 PDBSIESUB1	2-Drives, Cabinet & disk environment monitor	\$775.00
#0 IIFDE002EM	Cabinet only with disk environment monitor	\$375.00
#0 PDBSIESUB1AE	Dual Data Cable	\$ 31.15
#0 PCCS0200S	External Data Cable	\$ 10.71

8-INCH THIN LINE

Exactly one-half the height of any other model  
Proprietary, high-resolution, read-write heads patented by Tandon  
D.C. only operation - no A.C. required  
Industry standard interface  
Three millisecond track-to-track access time (9 lbs.)

### TANDON 8" DRIVES

#0 TNDTM8481	Single Sided, 500KB	2 or more \$370.00 ea.
#0 TNDTM8482	Double Sided, 1000KB	2 or more \$405.00 ea.

### TANDON 5 1/4" DRIVES

#0 TNDTM1001	Single Sided, 250KB (5 lbs.)	\$220.00 ea.
<b>2 or More: \$200.00 each</b>		
#0 TNDTM1002	Double Sided, 500KB	\$295.00 ea.
<b>2 or More: \$270.00 each</b>		
#0 TNDTM1003	Single Sided, 500KB	\$295.00 ea.
<b>2 or More: \$270.00 each</b>		
#0 TNDTM1004	Double Sided, 1000KB	\$395.00 ea.
<b>2 or More: \$375.00 each</b>		

## OUR FINEST 8" DUAL DISK DRIVE CABINET



*International Instrumentation Incorporated*

**Compare these features listed  
and you'll see why this cabinet  
is our  
FINEST DISK CABINET**

**FEATURES**

- Positive pressure forced air cooling for reliable disk drive operation
- AC input via 3 wire 7 foot international cord/socket set
- AC input EMI filtered to six amps to help prevent disk crashes due to power spikes and line noise
- 14 gauge main chassis
- Integral power supply with 5V @ 6A-5V @ 1A/24V @ 6A
- Double-sided custom PC power board and supply
- Each DC supply and AC separately fused



### STANDARD UNIVERSAL DISK ENCLOSURE

#0 IIFDE004	List Price	DBR Price
	\$495.00	\$425.00

With augmented power supply to handle Tandon 8Kline, or Winchester disk drives. Includes the disk environment monitor

#0 IIFDE004ANG	\$733.00	\$525.00
----------------	----------	----------

With Disk Environment Monitor for cool, reliable operation.

#0 IIFDE004EM	\$584.95	\$405.00
---------------	----------	----------

## Tandon



8-INCH THIN LINE

Exactly one-half the height of any other model  
Proprietary, high-resolution, read-write heads patented by Tandon  
D.C. only operation - no A.C. required  
Industry standard interface  
Three millisecond track-to-track access time (9 lbs.)

### TANDON 8" DRIVES

#0 TNDTM8481	Single Sided, 500KB	2 or more \$370.00 ea.
#0 TNDTM8482	Double Sided, 1000KB	2 or more \$405.00 ea.

### TANDON 5 1/4" DRIVES

#0 TNDTM1001	Single Sided, 250KB (5 lbs.)	\$220.00 ea.
<b>2 or More: \$200.00 each</b>		
#0 TNDTM1002	Double Sided, 500KB	\$295.00 ea.
<b>2 or More: \$270.00 each</b>		
#0 TNDTM1003	Single Sided, 500KB	\$295.00 ea.
<b>2 or More: \$270.00 each</b>		
#0 TNDTM1004	Double Sided, 1000KB	\$395.00 ea.
<b>2 or More: \$375.00 each</b>		

## DUAL 8" HALF HEIGHT FLOPPY CABINET

- 24V @ 4A 5V @ 3A
- -5V @ 800ma
- Fan cooled
- Sockets power connections
- All supplies regulated

INTERNATIONAL INSTRUMENTATION, INC.

List Price **SALE**

#0 IIFD1002 Dual Thin Line Cabinet (12 lbs.) \$225.00 **\$165.00**

### BUY THE CABINET & DRIVES AND SAVE! With 2 Tandon Thinlines

#0 PDBSIESUB1	Cabinet w/2 TNDTM8481 - 1 sided (30 lbs.)	\$895.00
#0 PDBSIESUB2	Cabinet w/2 TNDTM8482 - 2 sided (30 lbs.)	\$1115.00

### With 2 MPI Thinlines

#0 PDBSIESUB1	Cabinet w/2 MP141M - 1 sided (30 lbs.)	\$820.00
#0 PDBSIESUB2	Cabinet w/2 MP142M - 2 sided (30 lbs.)	\$1080.00

**Options**

#0 IIFD1002KIT	MPI drive adaptor mounting kit (2 lbs.)	\$24.00
#0 IIFD1002KIT	Shugart / AC/DC power connector kit (2 lbs.)	\$14.00

(For full size single SA801 or compatible drives)



**SANYO**  
**12" DATA DISPLAY MONITOR**  
 24 Lines x 64 Characters  
 BQSY00M2112 List Price: \$160.00  
**SAVE OVER 50% !!**  
**SALE PRICE: \$75.00 !!**  
**SAVE \$85.00!!**  
 (Sh. Wt. 16 lbs.)



**LOWEST COST PRINTERS AVAILABLE**  
**\$299.00 !!**

**COEX 80 F/T by star**



• 80 cps • 10, 12 or 18.5 cps • 3 selectable line spacing • Vertical format control • Centronics parallel or RS232 serial interface • Uses a standard Underwood spooled ribbon • Friction and tractor feed (Shipping Weight 21 lbs.)

Model	Interface	List Price	Our Price
BQCOX80F7	Parallel int.	\$399.00	\$299.00
BQCOX80F26R	Serial int.	\$399.00	\$329.00
BQCOX80FJ17P	Apple parallel interface w/cable		\$49.95

**\$229.00**

**AXIOM**  
 AXIOM CORPORATION

**SAVE \$160.00!!**



• 5 x 7 dot Matrix • Parallel interface (Centronics) • Tractor Feed • Dot Addressable Graphics • Up to 3-Part Paper • Self Test • One Year Warranty • 30 CPS 80 Column Unidirectional • Uses Regular Paper

BQAXMBP100A Dot Matrix Printer \$389.00 **\$229.00**

**star MICROTECH INC.**

**gemi-10**

**100CPS DOT MATRIX PRINTER**



• Centronics parallel interface • 9 x 9 character matrix • 6 x 6 block graphic matrix • Bit image (7 or 8) x 480 dot matrix (single density) (7 or 8) x 960 dot matrix • Bi-directional printing with logic seeking • 40, 48, 66, 80, 96, or 132 characters per line • 96 ASCII characters • 5, 6, 8, 5, 10, 12, or 17 characters per inch • 1/6, 1/8, n/72, n/144 Line pitch • Sprocket or friction feed • Uses a standard underwood ribbon

**BQGEN10 80 Column\* Printer** List Price: \$399.00  
**SALE PRICE: \$359.00**  
 (Shipping Weight 20 lbs.)

**BQGEN15 132 Column\* Printer** List Price: \$649.00  
**SALE PRICE: \$489.00**  
 (Shipping Weight 26 lbs.)  
 \*Based on 10 characters per inch

**SERIAL INTERFACE CARD FOR GEMINI 10 & 15**  
 BQGENSERINT Serial Interface Module (Sh. Wt. 1 lb.) **\$89.00**

**IBM MULTICARD**

**Vista™ MEMORY & I/O CARD**



• 64K RAM Expandable to 256K • One RS232 Serial Port • One Parallel Printer Port • Real Time Clock Calendar with Battery Backup (Sh. Wt. 1 lb.)

BQVIS025085 List Price: \$595.00  
**SALE PRICE: \$399.00**

**IBM MAXICARD**

**Vista PERSONAL COMPUTER RAM CARD**  
 POPULATED IN 64K, 256K, or 576K



**INCLUDING SUPERCALC 85™ FREE**

• Runs at full speed with no wait states • Parity can be disabled at User's option • On board parity bit on each Byte • Fully expanded, a full 576KB on one card • One board fills entire primary RAM address space available • Full Vista 120 Day Warranty

64K	\$199.00	BQV16057004 List Price: \$379.00	SAVE \$180.00
256K	\$449.00	BQV160570250 List Price: \$789.00	SAVE \$340.00
576K	\$950.00	BQV160570570 List Price: \$1299.00	SAVE \$349.00

\*Available with 256K & 576K boards only (Sh. Wt. 8 lbs.)  
 (IBM is a trademark of International Business Machines)

**EIA/RS232 WALL PLATES**

(Does not include connectors)

BQHWPR221 Single punched **4/\$10.00**  
 BQHWPR252 Dual Punched **4/\$12.00**



**RS-232 "D" SUB-MINIATURE CONNECTORS**

	1-8	10-24	25-99	100-UP	
BQCNDB25P	25 Pin Male	\$2.75	\$2.50	\$2.25	\$1.95
BQCNDB25S	25 Pin Female	\$4.00	\$3.50	\$3.25	\$3.00
BQCNDBS1212	1 Pc. Gray Hood	\$1.05	\$1.40	\$1.25	\$1.15
BQCNBP25H	2 Pc. Gray Hood	\$1.50	\$1.25	\$1.10	\$1.00
BQCNDBS1220	2 Pc. Black Hood	\$1.75	\$1.50	\$1.35	\$1.20
BQCNOD20410	Hardware set 2/Pr.	\$1.00	\$ .80	\$ .78	\$ .80

**TEXAS INSTRUMENTS**

**16 PIN GOLD AND TIN DIP SOLDER TAIL SOCKETS**

	TIN	GOLD
QTY	BQT1516LP	BQT1616LP
50	\$ 8.00	\$ 10.00
1000	\$ 60.00	\$ 80.00
4500	\$225.00	\$315.00

(Sh. Wt. 4 lbs.)  
 (Sh. Wt. 4 lbs.)  
 (Sh. Wt. 15 lbs.)

**DIRECT CONNECT MODEM**

**\$79.00**

**MURA**

**0 - 300 BAUD MURA MM-100**



• 0 - 300 baud • RS232C interface • Full duplex • Carrier detect indicator • Bell 103 compatible • Low voltage • Originate/Answer switch selectable

Model	List Price	SALE
BQMMUR100 0 - 300 baud modem (Shipping Weight: 2 lbs.)	\$99.95	\$79.00
BQCNDR2326F RS232 cable		\$16.95

**ULTRA MAGNETICS**

**5 1/4" FLOPPY DISKETTES**

**DOUBLE DENSITY!**

**SINGLE SIDED**

**40 TRACKS — BOX OF \$25.00**

**DOUBLE DENSITY: 10 BOXES: \$40.00**

**ORDER INFORMATION:**

BQULTS1401	Soft Sector	BOXES: 2	\$40.00
BQULTS1410	10 Sector	BOXES: 10	\$180.00
BQULTS1416	16 Sector	BOXES: 10	\$180.00

**SALE!**

Description	Box of 10	2 Boxes	10 Boxes
BQULTS2401 Soft sector, 40 track, 2 side	\$35.00	\$60.00	\$280.00
BQULTS2410 10 sector, 40 track, 2 side	\$30.00	\$50.00	\$220.00
BQULTS2416 16 sector, 40 track, 2 side	\$40.00	\$70.00	\$320.00

(Sh. Wt. 2 lbs.) (Sh. Wt. 4 lbs.) (Sh. Wt. 20 lbs.)

**PRIORITY ONE ELECTRONICS**

9161 DEERING AVE. CHATSWORTH, CA 91311

**ORDER TOLL FREE (800) 423-5922 - CA, AK, HI CALL (213) 709-5111**

Terms: U.S. VISA, MC, BAC, Check, Money Order, U.S. Funds Only. CA residents add 6% Sales Tax. MINIMUM PREPAID ORDER \$15.00. Includes MINIMUM SHIPPING & HANDLING of \$3.00 for the first 3 lbs. plus 40¢ for each additional pound. Orders over 50 lbs. sent freight collect. Just in case, please include your phone number. Prices subject to change without notice. We will do our best to maintain prices through May, 1983. Credit Card orders will be charged appropriate freight. If you haven't received your Winter '83 Engineering Selection guide, send \$1.00 for your copy today! Sale prices for prepaid orders only.



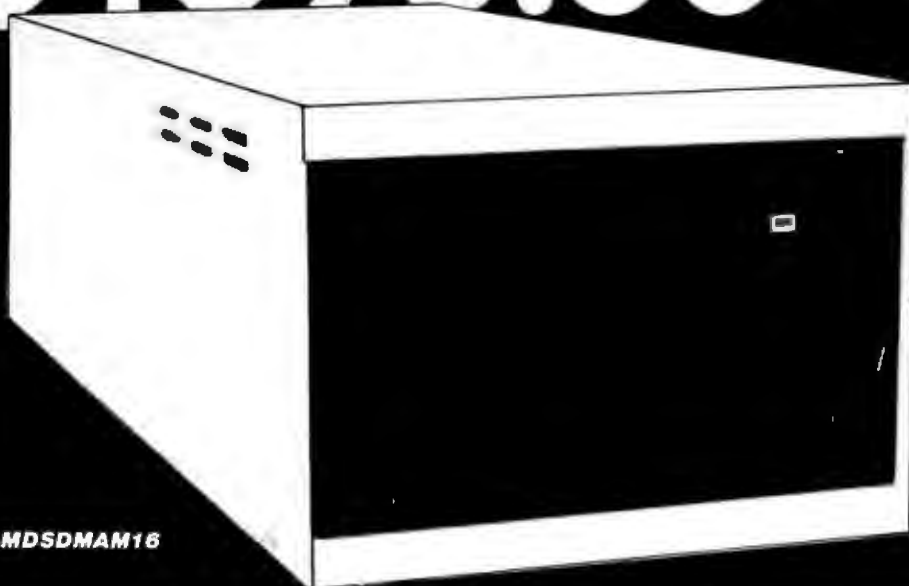
# 16,000,000 BYTES OF STORAGE

## S-100 16MBYTE DMA HARAD DISK SUBSYSTEM

# \$1595.00

**MORROW  
DESIGNS**

**SAVE OVER 45% !!**



**BQMDSDMAM16**

There are price barriers to be broken, and then there are PRICE BARRIERS TO BE **S-H-A-T-T-E-R-E-D!!** Priority One Electronics prides itself on breaking price barriers — but never like the one you see here! We're talking about 16 **M-E-G-A-B-Y-T-E-S** FOR ONLY **\$1595.00!!**

That's the storage capacity of THIRTY TWO Shugart SA801Rs — at one tenth the price! And there can be no comparisons between the performance of this system and floppy disk drives!

### PURE SPEED

That's what you get when you operate this subsystem. Imagine data access virtually without wait! By using DMA technology, the actual time required to send and retrieve data is greatly reduced. With the additional speed and high density of the 5¼" Winchester disk drive from COMPUTER MEMORIES, you will have enormous files at your own fingertips without the frustration of searching for the right floppy disk! The throughput of this subsystem is further increased by having all low level disk drive routines resident on the DMA controller, thus relieving the computer for other tasks.

### COMPATIBILITY

MORROW DESIGNS engineers have invested thousands of man-hours to assure that this M16 hard disk subsystem will be compatible with almost all S-100 IEEE/696 computer systems. Each M16 hard disk subsystem is supplied with CP/M 2.2™, and MICROSOFT BASIC V5.2™. MORROW DESIGNS has even included an INSTALL program on 8" disk so you can easily custom configure your M16 subsystem to operate flawlessly with any system that is fully IEEE/696 compatible and has no other DMA devices on line. North Star compatible INSTALL package available by special order.

### EXPANDABLE

The M16 subsystem can grow with your needs. The DMA controller can operate up to four drives at one time. Just imagine — 64 MBytes on line! Also, as technologies progress, you will be prepared with a controller designed with the future in mind!

### KEY FEATURES:

#### DISK DRIVE:

- DISCUS M16: Computer Memories CM15616, 16Mb formatted capacity
- Same physical size and mounting as the minifloppy
- Same DC voltages as the minifloppy
- Band actuator and stepper motor head positioning
- 5.0 megabit/second transfer rate
- Same track capacity as a double density 8 inch floppy
- 170 millisecond random average access time, reduceable to 95 ms via a simple software algorithm

#### CONTROLLER:

- Fully compatible with high speed 6MHz and 8 MHz CPUs of today and tomorrow
- DMA bus arbitration as outlined by the IEEE 696 standard
- Controls 1 to 4 soft sealed Winchester drives
- Variable sector length (256, 512, 1024, or 2048 byte sectors)
- Automatic CRC generation and checking
- Addresses 1 to 16 heads
- Addresses an infinite number of tracks
- 24-bit address burst DMA transfers
- Due to this high transfer rate, a minimum CPU speed of 2.5MHz is required

**WITH CP/M 2.2™ AND MICROSOFT BASIC V5.2™**

# NO KIDDING!

16,000,000 BYTES FOR

# ONLY \$1595.00

LIST PRICE: \$2995.00

(Shipping Weight 20 lbs.)

# SAVE \$1400.00!!

BQMDSDMAM16 16 MB Subsystem  
BQMDSDMAM16NS With NorthStar INSTALL package

# DON'T WAIT!!!

## WE HAVE PURCHASED ANOTHER PRODUCTION RUN — AS WE SOLD OUT THE LAST ONE IN LESS THAN A MONTH!!

**RETAIL STORE PHONE NUMBERS: (Chatsworth:) (213) 709-5464 - (Irvine:) (714) 660-1411**

Circle 370 on Inquiry card.

# LAST CHANCE FOR SCOPE REBATE!!

**BK PRECISION** DYNASCAN CORPORATION

## BKP1535 SPECIFICATIONS

• 35MHz response, useable beyond 50MHz • 2 mV/cm vertical sensitivity • Signal delay line for accurate view of high frequency pulse leading edge • Alternate trigger capability • Automatic or manual selection of CHOP AND ALTERNATE dual-trace display • Variable hold-off for accurate pulse train display • Video sync separator standard • Built-in triggering filters • PDA CRT with P31 phosphor • 10:1/ref/direct probes included • Differential input capability

**35 MHz  
DUAL TRACE - TRIGGERED**

BQBKP1535 List Price: \$950.00

**\$695.00**

(Shipping Weight 20 lbs.)

**SAVE \$330.00!!  
INCLUDING REBATE**

**\$75.00  
REBATE!**



2 PROBES INCLUDED

(Valid through 6/30/83)

**DIRECT FACTORY  
CONSUMER REBATE  
CERTIFICATE INCLUDED!**

**BK PRECISION** DYNASCAN CORPORATION

## BKP1530 SPECIFICATIONS:

• Delayed sweep operation for sweep expansion up to 1000V • 5 mV division sensitivity selectable 2 mV to 20MHz • Variable hold-off pulse train display • Single-sweep for nonrepetitive waveforms • Built-in triggering filters • Video sync separator standard • CHOP or ALTERNATE display • Differential input capability • 11.7 nS rise time for short duration pulses • Alternate trigger capability • Front panel x-y operation • 10:1/reference/direct probes included

**30 MHz  
DUAL TRACE - DELAYED SWEEP**

BQBKP1530 List Price: \$875.00

**\$625.00**

(Shipping Weight 20 lbs.)

**SAVE \$300.00!!  
INCLUDING REBATE**

**\$50.00  
REBATE!**

**TAXAN**

**12" RGB COLOR MONITOR  
380 HORIZONTAL LINE RESOLUTION**

BQTAXR001

List Price \$399.00

(Sh. Wt. 29 lbs.)

**\$329**

BQTAXIB000  
Interface cable to IBM \$19.00

BQTAXIB001  
Apple IIe & IIc cable \$19.00

**WITH APPLE II RGB INTERFACE**

BQPB0TAXR001

List Price: \$528.00

**\$359.00**

**12" RGB SUPER HIGH  
RESOLUTION MONITOR**

**630 HORIZONTAL LINE RESOLUTION**

- 18MHz bandwidth
- Linear RGB input provides unlimited color combinations
- Compatible with APPLE III and IBM PC

BQTAXR003

LIST PRICE:

\$699.00

(Sh. Wt. 29 lbs.)

**SALE PRICE: \$595.00**

**SUPER HIGH RESOLUTION RGB MONITOR**

**WITH AN APPLE INTERFACE CARD**

BQPB00003001 **\$695.00**

**HIGH RESOLUTION  
12" GREEN OR AMBER  
VIDEO MONITOR**



- >18 MHz bandwidth
- 800 line horizontal resolution
- Composite video input

BQTAXR012M Green

BQTAXR012WY Amber

LIST PRICE: \$179.00

(Shipping Weight 19 lbs.)

**SALE PRICE: \$129.00**

**hp HEWLETT  
PACKARD**

**H-P QUALITY & PERFORMANCE  
AT OUR LOW PRICES!**

## SERIES 10 Programmable Calculators



- RPN Logic
- Continuous Memory
- Convenient Design
- Automatic Turn-off Function
- LCD
- Self Diagnosis
- Rugged Construction

Part No.	Description	List Price	SALE PRICE
BQ HP-10C	Scientific (Shipping Weight 3 lbs.)	\$ 70.00	<b>\$59.00</b>
BQ HP-11C	Advanced Scientific (Shipping Weight 3 lbs.)	\$ 90.00	<b>\$79.00</b>
BQ HP-12C	Advanced Financial (Shipping Weight 3 lbs.)	\$120.00	<b>\$99.00</b>
BQ HP-15C	Advanced Scientific w/matrices (Sh. Wt. 3 lbs.)	\$120.00	<b>\$99.00</b>
BQ HP-16C	For Digital Electronics & Computer Science (3 lbs.)	\$120.00	<b>\$99.00</b>

## HP-41C/CV - Handheld Computer System

Part No.	Description	List Price	SALE PRICE
BQ HP-41C	Handheld computer w/HP821061 memory module included (5 lbs.)	\$195.00	<b>\$159.00</b>
BQ HP-41CV	Handheld Computer w/5X Memory (5 lbs.)	\$275.00	<b>\$219.00</b>
BQ HP82104A	Plug-in Card Reader (Sh. Wt. 5 lbs.)	\$195.00	<b>\$159.00</b>
BQ HP82153A	Optical Wand (Sh. Wt. 5 lbs.)	\$125.00	<b>\$ 99.00</b>
BQ HP82161A	Digital Cassette Drive (Sh. Wt. 5 lbs.)	\$450.00	<b>\$349.00</b>
BQ HP82162A	Thermal Printer/Plotter (Sh. Wt. 5 lbs.)	\$450.00	<b>\$349.00</b>
BQ HP82163A	Video Interface (Sh. Wt. 5 lbs.)	\$225.00	<b>\$179.00</b>

### ENHANCEMENT MODULES:

BQ HP82180A	HP-IL Module	\$125.00	<b>\$85.00</b>
BQ HP82178A	Quad RAM	\$ 75.00	<b>\$59.00</b>
BQ HP82180A	Extended Functions/Memory Module	\$ 75.00	<b>\$59.00</b>
BQ HP82181A	Extended Memory Module	\$ 75.00	<b>\$59.00</b>
BQ HP82162A	Time Module	\$ 75.00	<b>\$59.00</b>



BQ HP-75C (Sh. Wt. 9 lbs.) List: \$995.00

## HP-75C PORTABLE COMPUTER

**SALE  
PRICE**

**\$795.00**

- Accepts 48K of applications ROM
- Touch-type typewriter-like keyboard
- Powerful BASIC Language
- Uses same peripherals as Series 40



**PRIORITY ONE ELECTRONICS**

9161 DEERING AVE. CHATSWORTH, CA 91311



**ORDER TOLL FREE (800) 423-5922 - CA, AK, HI CALL (213) 709-5111**

Terms U.S. VISA, MC, BAC, Check, Money Order, U.S. Funds Only. CA residents add 8 1/4% Sales Tax. MINIMUM PREPAID ORDER \$15.00. INCLUDE MINIMUM SHIPPING & HANDLING OF \$3.00 for the first 3 lbs. plus 40¢ for each additional pound. Orders over 50 lbs. sent freight collect. Just in case, please include your phone number. Prices subject to change without notice. We will do our best to maintain prices through May, 1983. Credit Card orders will be charged appropriate freight if you haven't received your Winter '83 Engineering Selection guide, send \$1.00 for your copy today! Sale prices for prepaid orders only.









**2732** 32K EPROM

**\$495**

**2764** 64K EPROM

**\$995**

**CAPACITORS**

**TANTALUM**

	6V	10V	15V	20V	25V	35V	50V
.22uF						.40	
.27						.40	
.33						.40	.45
.47			.35			.50	
.68						.45	.50
1.0		.40	.45	.45	.45		
1.5			.45		.50	.80	
1.8						.75	
2.2		.25	.40	.45		.65	.85
2.7		.40	.45				.90
3.3		.45	.50	.55	.60	.65	.90
3.9		.45					
4.7	.45	.55		.60	.65	.65	.90
6.0			.60				
6.8			.70		.75		
8.2							1.00
10	.55	.65	.80	.85	.90	1.00	
12	.65		.85	.90			
15	.75	.85	.90				
18			1.25				
22		1.00	1.35				
27			2.25				
33		1.50					
47	1.95						
56	1.75						
100		3.25					
270	3.75						

**DISC**

50V .05	470	50V .05	
50V .05	560	50V .05	
50V .05	680	50V .05	
50V .05	820	50V .05	
50V .05	.001uF	50V .05	
60V .05	.0015	50V .05	
50V .05	.0022	50V .05	
50V .05	.005	50V .05	
50V .05	.01	50V .07	
50V .05	.02	50V .07	
50V .05	.05	50V .07	
50V .05	.1	12V .10	
	.1	50V .12	

**MONOLITHIC**

1uF-mono 50V .18 47uF-mono 50V .25

**ELECTROLYTIC**

	RADIAL		AXIAL	
.47uF	50V .14	1uF	50V .14	
1	25V .14	4.7	18V .14	
2.2	35V .15	10	18V .14	
4.7	50V .15	30	50V .16	
10	50V .15	22	18V .14	
47	35V .18	47	50V .20	
100	16V .18	100	15V .20	
220	35V .20	100	35V .25	
470	25V .30	150	25V .25	
2200	18V .60	220	25V .30	
		330	16V .40	
		500	16V .42	
		1000	16V .60	
		1500	16V .70	
		2200	16V .85	
25,000uF 30V	3.95	6000	16V .85	

**COMPUTER GRADE**

**WIREWRAP CARDS**

FR-4 Epoxy Glass Laminate  
With Gold-Plated Contact Fingers

**S-100 BUSS**

P100-1	Bare — No Foil Pads	15.95
P100-2	Horizontal BUSS	22.95
P100-3	Vertical BUSS	22.95
P100-4	Single Foil Pads Per Hole	23.95

**APPLE**

P500-1	Bare — No Foil Pads	15.95
P500-3	Horizontal BUSS	22.95
P500-4	Single Foil Pads Per Hole	23.95

**IBM**

IBM-PR	BUSS Lines + Pads	55.00
--------	-------------------	-------

**GENERAL PURPOSE**

22/44 PIN (.156" SPACING)

P441-3	Vertical BUSS, 4.5" x 6"	13.95
P442-3	Vertical BUSS, 4.5" x 9"	14.95
36/72 PIN (.1" SPACING)		
P721-3	Vertical BUSS, 4.5" x 6"	13.95
P722-3	Vertical BUSS, 4.5" x 9"	14.95

**IF YOU CAN FIND A PRICE LOWER ELSEWHERE, LET US KNOW AND WE WILL MEET OR BEAT THEIR PRICE! (SEE TERMS BELOW)**

**OPTO-ISOLATORS**

4N36	1.00	MCA-7	1.50
4N37	1.10	MCA-255	1.75
4N2E	.89	IL-1	1.25
4N33	1.73	ILA-30	1.25
4N35	1.25	ILO-74	2.75
4N37	1.25	M11C5	1.25
MCT-2	1.00	TIL-111	1.00
MCT-6	1.50	TIL-113	1.75

**DIODES**

1N751	5.1 volt zener	.25
1N759	12.0 volt zener	.25
1N4148	(1N814) switching	25/1.00
1N4004	400PIV rectifier	10/1.00
KBP02	200PIV 1.5amp bridge	.45
KBP04	400PIV 1.5amp bridge	.55

**MUFFIN FANS NEW UN-USED**

4.68" Square	14.95
3.125" Square	14.95

**SWITCHES**

SPDT mini-toggle	1.25
DPDT mini-toggle	1.50
SPDT push-button	1.49

**TRANSISTORS**

2N918	.50	MP53706	.15
MP8818	.25	2N3772	1.85
2N2103	.50	2N3903	.25
2N2218	.50	2N3904	.10
2N2218A	.50	2N3906	.10
2N2219	.50	2N4122	.25
2N2219A	.50	2N4123	.25
2N2222	.25	2N4248	.25
PN2222	.10	2N4304	.75
MP82389	.25	2N4401	.25
2N2484	.25	2N4402	.25
2N2905	.50	2N4403	.25
2N2907	.25	2N4867	1.00
PN2907	1.25	PN4918	.25
2N3055	.70	2N5065	.25
3055T	.80	PN5129	.25
2N3393	.30	PN5139	.25
2N3414	.25	2N5209	.25
2N3563	.40	2N6028	.35
2N3565	.40	2N6043	1.75
PN3565	.25	2N6048	1.75
MP83638	.25	MP8-A05	.25
MP83640	.25	MP8-A06	.25
PN8643	.25	MP8-A55	.25
PN8644	.25	TIP29	.85
MP83704	.15	TIP31	.75
		TIP32	.79

**HEAT-SINKS**

TO-3 style	.95
TO-220 style	.35

**IC SOCKETS**

8 pin ST	1-.99	100
14 pin ST	.13	.11
16 pin ST	.17	.08
18 pin ST	.20	.18
20 pin ST	.23	.27
22 pin ST	.20	.27
24 pin ST	.30	.27
28 pin ST	.40	.32
40 pin ST	.49	.39
64 pin ST	4.25	caD
ST - SOLDERTAIL		
8 pin WW	.59	.49
14 pin WW	.69	.52
16 pin WW	.49	.49
18 pin WW	.69	.60
20 pin WW	1.09	.98
22 pin WW	1.39	1.28
24 pin WW	1.49	1.35
28 pin WW	1.69	1.49
40 pin WW	1.99	1.69
WW - WIREWRAP		
16 pin ZIF	6.75	call
24 pin ZIF	9.95	call
28 pin ZIF	10.95	call
ZIF = TEXTTOOL (Zero Insertion Force)		

**DIP SWITCHES**

4 POSITION	.25
5 POSITION	.30
6 POSITION	.30
7 POSITION	.95
8 POSITION	.95



**LED LAMPS**

Jumbo Red	.10	.09
Jumbo Green	.18	.15
Jumbo Yellow	.18	.15

**LED DISPLAYS**

HP 5082-7760	.6"	CC	1.20
MAN 72	.3"	CA	.99
MAN 74	.3"	CC	.99
FND-357 (358)	.375"	CC	1.25
FND-500 (503)	.5"	CC	1.48
FND-507 (510)	.5"	CA	1.48

**BYPASS CAPS**

.01 UF DISC	100/6.00
.1 UF DISC	100/8.00
.1 UF MONOLITHIC	100/15.00

**RESISTORS**

1/2 WATT 5% CARBON FILM ALL STANDARD VALUES FROM 1 OHM TO 10 MEG OHM

50 PCS. SAME VALUE	.025
100 PCS. SAME VALUE	.02
1000 PCS. SAME VALUE	.015

**VISIT OUR RETAIL STORE**

HOURS: M-W-F, 9-5 T-Thu., 9-9 Sat. 11-3

PLEASE USE YOUR CUSTOMER NUMBER WHEN ORDERING  
TERMS: For shipping include \$2 for UPS Ground or \$3 for UPS Blue Label Air. Items over 5 pounds require additional shipping charges. Foreign orders, include sufficient amount for shipping. There is a \$10 minimum order. Bay Area and Los Angeles Counties add 6% Sales Tax. Other California residents add 6% Sales Tax. We reserve the right to substitute manufacturer. Not responsible for typographical errors. Prices are subject to change without notice. We will match or beat any competitor's price provided it is not below our cost.



**JDR Microdevices**

1224 S. Bascom Avenue  
San Jose, CA 95128

800-538-5000 • 800-662-6279 (CA)  
(408) 995-5430 • Telex 171-110

© 1983 JDR MICRODEVICES, INC.

**2716** 16K EPROM

**\$3<sup>95</sup>**

**TMS2532** 32K EPROM

**\$5<sup>95</sup>**

**MICROCOMPUTER  
HARDWARE HANDBOOK**

FROM ELCOMP — \$14.95  
over 800 pages of manufacturers data  
on most commonly used IC's.  
Includes:  
TTL — 74/74LS and 74F  
CMOS  
Voltage Regulators  
Memory — RAM, ROM, EPROM  
CPU's — 6800, 6500, Z80, 8080,  
8085, 8086/8  
MPU support & interface — 6800,  
6500, Z80, 8200, etc.

**DISK DRIVES  
TANDON**

**TM100-1** 5 1/4" (FOR IBM) SS/DD **229.00**  
**TM100-2** 5 1/4" (FOR IBM) DS/DD **295.00**

**SHUGART**

**SA 400L** 5 1/4" (40 TRACK) SS/DD **199.95**  
**SA 400** 5 1/4" (35 TRACK) SS/DD **189.95**

**SIEMENS**

**FD100-8** 8" SS/DD  
(801 REPLACEMENT) **259.00**

**PERTEC**

**FD-200** 5 1/4" SS/DD **179.95**  
**FD-250** 5 1/4" DS/DD **199.95**

**MPI**

**MP-52** 5 1/4" (FOR IBM) DS/DD **295.00**

NOTE: Please include sufficient amount for shipping on above items.

**CABINETS FOR 5 1/4"  
DISK DRIVES**

**CABINET #1 \$29.95**

- ★ DIMENSIONS 8 1/2" x 5 1/2" x 3 1/2"
- ★ COLOR MATCHES APPLE
- ★ FITS STANDARD 5 1/4" DRIVES, INCL. SHUGART
- ★ INCLUDES MOUNTING HARDWARE AND FEET

**CABINET #2 \$79.00**

- ★ COMPLETE WITH POWER SUPPLY, SWITCH, LINE CORD, FUSE & STANDARD POWER CONNECTOR
- ★ DIMENSIONS: 11 1/2" x 5 1/2" x 3 1/2"
- ★ +5V @ 1 AMP, +12V @ 1.5 AMP
- ★ FITS STANDARD 5 1/4" DRIVES
- ★ PLEASE SPECIFY GRAY OR TAN

NOTE: Please include sufficient amount for shipping on above items.

**JDR SPRING SPECIALS**

**SA400 \$189.95**

- ★ 35 TRACKS
- ★ REPEAT OF A SELLOUT
- ★ LIMITED SUPPLY (AGAIN)
- ★ MODIFY FOR USE IN APPLE (EXPERIENCED TECHNICIANS)
- ★ USE WITH CABINET #1 TO MAKE A BEAUTIFUL APPLE COMPATIBLE DRIVE  
MODIFICATION INSTRUCTIONS \$1.00  
34 PIN EDGE CARD CONNECTOR MATES TO RIBBON CABLE \$3.25

**MEMORY SALE**

**2114** 450NS (TMS4045) **8/9.95** 100 FOR **.99 ea.**  
**2114** 250NS (TMS4045) **8/10.95** 100 FOR **1.99 ea.**  
**2102L-4** LOW POWER 450NS **.55 ea.** 100 FOR **.49 ea.**

**4164** 200NS **5.95** **Z80A-CPU** 4MHZ **4.95**  
**HM6116-4** 200NS **4.75** **8080** 2MHZ **3.95**  
**TMM2016** 200NS **4.15** **8085** 3MHZ **5.95**  
**2732** 450NS **4.95** **8086** 5MHZ **29.95**  
**TMS2532** 450NS **5.95** **6800** 1MHZ **3.95**  
**2764** 450NS **9.95** **68000** 8MHZ **59.95**

**COMPONENTS**

**LM1488** or **LM1489** **.69 ea.** **7805T** or **7812T** **.75 ea.**  
**16 PIN LOW PROFILE ST IC SOCKETS** 100/8.00  
**16 PIN TOOLED WIRE WRAP IC SOCKETS** **.49 EA.**

SPRING SPECIALS ARE GOOD ONLY UNTIL MAY 31, 1983

**TRANSFORMERS**

**FRAME STYLE**

**1.5VAC** 2amp **4.95**  
**1.5VAC CT** 2amp **5.95**  
**1.5VAC CT** 4amp **7.95**  
**1.5VAC CT** 8amp **10.95**  
**1.2VAC CT** 2amp **7.95**

**PLUG CASE STYLE**

**1VAC** 250ma **3.95**  
**1VAC** 500ma **4.95**  
**1VAC** 1amp **5.95**  
**1VAC** 2amp **8.95**

**DC ADAPTER**

**5, 12 VDC** selectable with universal adapter **8.95**

NOTE: Please include sufficient amount for shipping on above items.

**POWER SUPPLY**

**MODEL 2 \$39<sup>95</sup>**

MOUNTED ON PC BOARD  
MANUFACTURED BY CONVER

+5 VOLT 4 AMP  
±12 VOLT 1 AMP

NOTE: Please include sufficient amount for shipping on above items.

**CONNECTORS**

**RS232 MALE** 2.50  
**RS232 FEMALE** 3.25  
**RS232 FEMALE**  
**RIGHT ANGLE** 5.25  
**RS232 HOOD** 1.25  
**9-100 ST** 3.95  
**9-100 WW** 4.95  
**44 pin ST** 2.95  
**44 pin WW** 4.95  
**72 pin ST** 5.95  
**72 pin WW** 7.95

**RIBBON CABLE**

CONTACTS	SINGLE COLOR		COLOR CODED	
	1'	10'	1'	10'
10	.50	4.40	.83	7.30
20	.65	5.70	1.25	11.00
26	.75	6.60	1.32	11.60
34	.98	8.60	1.65	14.50
40	1.32	11.80	1.92	16.80
50	1.38	12.10	2.50	22.00

**D-SUBMINIATURE**

DESCRIPTION	SOLDER		RIGHT ANGLE SOLDER		RIBBON CABLE		HOODS	
	MALE DBxxP	FEMALE DBxxS	MALE DBxxPR	FEMALE DBxxSR	MALE IDBxxP	FEMALE IDBxxS	BLACK HOOD-B	GREY HOOD
CONTACTS 9	2.08	2.66	1.85	2.18	3.37	3.69	—	1.60
15	2.69	3.63	2.20	3.03	4.70	5.13	—	1.60
25	2.50	3.25	3.00	4.42	6.23	6.84	1.25	1.25
37	4.80	7.11	4.83	6.19	9.22	10.08	—	2.85
50	6.05	9.24	—	—	—	—	—	3.50

For order instructions see "IDC Connectors" below.

**IDC CONNECTORS**

DESCRIPTION	SOLDER HEADER	RIGHT ANGLE SOLDER HEADER	WW HEADER	RIGHT ANGLE WW HEADER	RIBBON HEADER SOCKET	RIBBON HEADER	RIBBON EDGE CARD
ORDER BY	IDHxxS	IDHxxSR	IDHxxW	IDHxxWR	IDSxx	IDMxx	IDExx
CONTACTS 10	.82	.85	1.88	2.05	1.15	—	2.25
20	1.29	1.35	2.98	3.28	1.86	5.50	2.38
26	1.68	1.78	3.84	4.22	2.43	6.25	2.65
34	2.20	2.31	4.50	4.45	3.15	7.00	3.25
40	2.58	2.72	5.28	4.80	3.73	7.50	3.80
50	3.24	3.39	6.63	7.30	4.65	8.50	4.74

ORDERING INSTRUCTIONS: Insert the number of contacts in the position marked "xx" of the "order by" part number listed. Example: A 10 pin right angle solder style header would be IDH10SR.



# SPRING APPLE SALE!

## FD-35 DISK DRIVE

By MA Systems

- ★ Direct Replacement for Apple Disk II
- ★ Compatible with Apple Controller or other Apple compatible controllers
- ★ Specially designed electronics with low power consumption
- ★ DOS 3.3 and 3.2 compatible
- ★ Owner's Manual and Warranty Card included
- ★ 90-day Warranty

**NEW INTRODUCTORY OFFER**  
**\$229.95**  
 CONTROLLER CARD \$89.95

## APPLE II KEYBOARD \$99.95

From the Keyboard Co.

- ★ Brand New Rev. 7 keyboard — NOT an imitation
- ★ Special Purchase — Supply very limited
- ★ Includes Encoder Board and Cable

## APPLE COMPATIBLE POWER SUPPLY \$99.95

- ★ Compact Switching Design
- ★ All Outputs regulated
- ★ Short Circuit and Overload Protection
- ★ Complete with Apple-type plug-in power cord
- ★ Apple Compatible — Yet higher output allows more disk drives and cards without overheating
- ★ +5V @ 5A, +12V @ 3A, -5V @ .5A, -12V @ .5A
- ★ Shielded enclosure: 10 3/4" x 3 1/2" x 2 3/8"

## VIEWMAX 80

A Full Function 80 column card for Apple II\*

2 YEAR WARRANTY

**\$199.95**

## NEW IMPROVED

## JDR COOLING FAN FOR YOUR APPLE II

- ★ Easy modification — no modification of Apple required
- ★ Eliminates overheating problems
- ★ Switch on front controls fan, Apple, and extra outlet
- ★ Rotron whisper fan is the quietest, most reliable on the market

## NOW WITH SURGE SUPPRESSION

**\$69.95**

WITHOUT SURGE SUPPRESSION \$59.95

## INTERFACE CARDS

By Perisoft

### PRINTERLINK \$79.00

- ★ Centronics Standard Parallel Interface for Apple II
  - ★ Simple to use — Yet supports custom driver applications from ROM or Disk
  - ★ Includes card, cable and user's manual
  - ★ 1 Year Warranty
- ### MESSENGER \$119.00
- ★ Serial I/O for Apple II
  - ★ Connects virtually any RS-232 serial device
  - ★ 6 switch selectable drivers:
    - 4 printer drivers
    - Terminal Driver — 40 or 80 driver
  - ★ Includes card, cable and user's manual
  - ★ 1 Year Warranty

## OKIDATA PRINTERS

- ★ 120 cps, 9x9 Dot Matrix
- ★ 50% faster than EPSON
- ★ Parallel and Serial interfaces are standard

**ML-82A . . . . . \$479.50**

**ML-83A . . . . . \$699.95**

**ML-84 PARALLEL . . . \$1059.00**

CALL FOR PRICES ON 82A TRACTOR OPTION AND 82A, 83A GRAPHICS OPTION. CABLES AND INTERFACE CARDS AVAILABLE

## JDR 16K RAMCARD

For Apple II\*

- ★ Expand your 48K Apple to 64K
- ★ Fully compatible with Apple Language System — Use in place of Apple Language card
- ★ Provides extra memory for Visicalc™
- ★ Run PASCAL, FORTRAN, Integer Basic with appropriate software
- ★ Highest quality card features gold edge connector, sockets for all IC's

NOW WITH 2 YEAR WARRANTY

ASSEMBLED & TESTED WITH WARRANTY . . . . . **\$44.95**

KIT — INCLUDES ALL PARTS & INSTRUCTIONS . . . **\$40.95**

BARE PC CARD WITH INSTRUCTIONS . . . . . **\$14.95**

## MONITORS

GREEN PHOSPHOR

**NEC JB1201M \$169.95**

**ZENITH ZVM-121 \$119.95**

COLOR

**AMDEK COLOR 1 \$335.00**

**ORDER TOLL FREE**

**800-538-5000**

**800-662-6279**

(CALIFORNIA RESIDENTS)

## 5 1/4" DISKETTES

**ATHANA SS SD SOFT . . . 24.**

**MEMOREX SS SD SOFT 28.**

**VERBATIM SS DD SOFT 29.**

**VERBATIM 10 SECT HARD 29.**

## NASHUA

TOP QUALITY — LOW PRICE

Single Sided, Single Density

Soft Sectors with Hub Ring

**\$19.95 BOX OF 10**



## JDR Microdevices

1224 S. Bascom Avenue

San Jose, CA 95128

800-538-5000 • 800-662-6279 (CA)

(408) 995-5430 • Telex 171-110

© 1983 JDR MICRODEVICES, INC.

## VISIT OUR RETAIL STORE

HOURS: M-W-F, 9-5 T-Th., 9-9 Sat. 11-5

PLEASE USE YOUR CUSTOMER NUMBER WHEN ORDERING  
 TERMS: For shipping include \$2 for UPS Ground or \$3 for UPS Biz Label Air. Items over 5 pounds require additional shipping charge. Foreign orders, include sufficient amount for shipping. There is a \$5 minimum order. Bay Area and Los Angeles Counties add 6 1/2% Sales Tax. Other California residents add 6% Sales Tax. We reserve the right to substitute manufacturer. Not responsible for typographic errors. Prices are subject to change without notice. We will match any competitor's price provided it is not below our cost.

\* APPLE IS A TRADEMARK OF APPLE COMPUTER CO.

# Unclassified Ads

**FOR SALE:** Three Teletype Model 43 teleprinters (all with upper/lowercase) and three Texas Instruments Model 745 portable teleprinters. Two Model 43s have RS-232C and 20-mA current loop interfaces, one has modem. The TI Model 745s are Silent 700 with built-in modems. RS-232C serial parts and 20-mA current loop. All systems are approximately 1-2 years old, in very good condition. Teletype Model 43: \$450. TI Model 745: \$500. Tom Radt, (714) 947-3440.

**FOR SALE:** BYTE September 1975 to February 1979 (January 1976 issue missing) \$125. Also, first 14 issues of Knowledge Magazine, \$35. All in mint condition, shipping included. William Bates, 2246 Connell Terrace, Baldwinsville, NY 13027.

**FOR SALE:** Sinclair ZX80 with 1K RAM 4K BASIC ROM. Comes complete with cassette and TV cables, power supply, TV connector, and manual. Includes software cassette with various programs. 385 Michael Kuchta, 166 Menden Ave., Southington, CT 06489.

**FREE:** Electronic components and subassemblies, approximately 300 lbs. of recent vintage parts for donation to a qualified nonprofit organization. Also, BYTE Vol 1, numbers 1, 4, 13, and 14, Vol 2, number 1 through current, best offer 55 issues of Interface Age, Vol 2 through 7, best offer Ray Robertson, 7 Mechanic St., Dover, NJ 07801, (201) 361-1231.

**FOR SALE:** One RCA VIP 4K RAM (1802 Cosmac) single-board computer with all documentation and the following boards: color, sound, expansion, any BASIC, and RCA keyboard, best realistic offer. Also, BYTE magazine issues between 1/78 and 1/1/82, best offer. Would also like to trade Atari 400/800 public-domain programs. Henry Wil, 248 Perry St., Dover, NJ 07801, (201) 366-8366.

**WANTED:** I am looking for a serial interface for the Olivetti Praxis 35 electronic typewriter. It must be compatible with an RS-232C connection. Send your price for the interface. I will also pay a reasonable price for a tested schematic. Kenyon M. Churn, 6580 Santana St. #3B, Coral Gables, FL 33146.

**FOR SALE:** Hewlett-Packard HP-85 microcomputer with 32K main memory, HP-B-inch double-sided double-density disk drive, 2.36 million bytes permanent-storage drive unit, includes HP-48 interface cable with all ROMs. Has full graphics, fast thermal printer, HP-85 carrying case, financial and standard packs \$6500. Carter Melbane, POB 1722, Wilmington, NC 28401.

**WANTED:** Used HP-7225 plotter, 85-13038 Graphics Presentation Pac, and 17601A Opt 085 Personality Module. C.B. Campbell, 222 Glenview Dr., Des Moines IA 50317.

**FOR SALE:** Zenith Z-89 processor logic board (85-2208-1) with 64K RAM and latest ROMs, excellent working condition; 5500 Three single-density disk I/O boards (85-2219-1) for Heath/Zenith HZ-2-89; 350, N. McLann, West 507 Euclid, Spokane WA 99205, (509) 328-4185.

**FOR SALE:** Zenith 19-inch monitor (CV1950) with RGB, video, and audio inputs. Used once: \$400. Also, a Commodore KMH-Godbout II 8K memory, and documentation \$200. Marvin Green, 22282 Southwest Stafford, Tualatin, OR 97062.

**FOR SALE:** Tektronix 4014-1 19-inch high-resolution graphics terminal. As is: \$400 or best offer. Steve Light, Dairy Hill, South Royalty, VT 05068, (802) 763-8894.

**FOR SALE:** Intersect Computer Model 10, 64K intelligent terminal, still in factory box, list \$1300, sale price \$500. Bill O'Neil, 806 Parma, Coral Gables, FL 33146, (305) 532-1761.

**FOR SALE:** Vector Graphic System-8 complete with extensive software, Z80, 64K, two Microplots 320K drives and a Hayes Micromodem CPM 2.2, ASM Scope, MBASIC-5, FORTRAN, Peachtree Accounting, Memote II word processing, Eucuplion II and Scratchpad spreadsheets, GBASE II, Microstat statistics, Stargraph graphs, Crossalk comm, and others, also, 100-plus Memorex disks. First-quality system for serious computing. \$3250. Leons Kovars, Suite 112, 445 Union Blvd., Lakewood, CO 80228, (303) 989-7906.

**FOR SALE:** TRS-80 Color Computer, Extended Color BASIC, 32K. All original equipment plus joysticks, recorder, dust cover and software available in cartridges and cassettes. Extras, like new, hardware alone: \$725. Total value over \$1000, asking \$500. Will negotiate. Mike Smith, 2457 Pioneer Rd., Evanston, IL 60201, (312) 869-9829 after 6 p.m. CT.

**FOR SALE:** Netronics ELF II microcomputer trainer, two 4K memory boards, grant board, and kluge board. Software on cassette. ELF-BUG monitor, tiny BASIC, assembler, disassembler, and text editor. Documentation includes RCA 1802 users manual, short course on tiny BASIC, all schematics, and additional software. All in excellent condition. Worth over \$500. Best offer: Robert Widlicka, 1420 Plain #1, Las Cruces, NM 88001, (505) 522-3075 or 846-4401.

**FOR SALE:** Liquid-pipeline program for HP-41C calculator. Computes pressures and horsepower required at each pump station for a multi-pump station pipeline. Allows for peaks and control points on pipeline profile. 50 pairs of profile points and 10 pump-station locations can be input. Output can be formatted to print suction and discharge heads for plotting hydraulic gradient. Magnetic cards with documentation. \$30. Shashi Menon, P.E. Box 2533 Corona CA 91720.

**WANTED:** SS-50 disk controller (preferably GIMIX #8B or #8B) and DOS (Flex 7.0) for 6800. Send details and price. Charlie Hoffpau, 2603 Perry Lane, Alvin TX 77511.

**FOR SALE:** ASP 33 Teletype with acoustic coupler \$400. Commodore 8096 96K (with UCSD Pascal compiler) \$1600. Commodore 9000 Super PET with BASIC, FORTRAN, APL, Pascal assembler \$1600. Commodore 8050 dual disk drive and controller \$1400. Epson MX-100 printer with Galtran and IEEE interface \$800. Software free with above computers, business programs, games, and more. Andrew Ring, 267 Middle Rd., Yarmouth, ME 04096.

**WANTED:** All kinds of programs in French for the Apple II or CP/M. Bin-Ex exchanges are also possible. Bob Grattan, 107 Howard St., Ashland, VA 23005.

**FOR SALE:** Graduate student who owns a Sinclair ZX81 with 64K module has over 500 programs available to sell, trade, etc. Would also like to exchange tips and information. Programs are predominantly oriented for business, household, and games. Craig Passman, POB 4131, Hammond, LA 70402.

**FOR SALE:** Digital Group System 5, Z80, 32K, two 8-inch disk drives, full keyboard, 9-inch monitor, printer/visual interface, CP/M-compatible, MCOZ ManBASIC, Opus, CBASIC, utilities, and software: \$2750. Sandra Vainier, Cafeteria 51 DF 11700 Mexico, (905) 596-2782.

**WANTED:** Documentation and software for Wang 2200-W5F4A SN EF-2064. Will pay reasonable charge for original or duplicate copy or I will provide deposit while I copy. Jim Erod, 1315 Birch Creek Dr., Kingwood TX 77339, (713) 358-0024.

**FOR SALE:** Intel 8051 single-chip microcomputer System Design Kit (SDK-51) with complete hardware reference manual, monitor listing and 8051 assembly-language programming manual. Originally \$1200 from Intel. Make an offer, check or money order. Tom Lee, Apt. B, 633 South 8th St., San Jose, CA 95112, (408) 946-3000 ext. 501 days and 294-0607 evenings.

**FOR SALE:** SWTPC system boards, MPA7 motherboard, 6800 with Percom 6809 adapter, 6845 video-graphic board, 64K dynamic memory board, MPLA. All populated except memory board. Will trade for 5 1/4-inch disk drive or printer. R. Naud, 637 Cameron Ave., Windsor Ontario N9B 1Z7, Canada.

**FOR SALE:** SWTPC 6800 with two 16K and three 4K RAM, serial/parallel, control and clock/calendar boards, MF-68 disk-interface board, Microtek MT80P printer, Microterm ACT-1 terminal, and disk software \$900 or best offer. Will sell individual items, send for complete list. Jim Hall, 2063 108th Ave., Osgo, MI 49078, (616) 694-9760.

**FOR SALE:** Ohio Scientific CAP with minifloppy. Color graphics, sound, modem and printer ports, PIA ports, all necessary cables, and assorted disks complete with operating system. Also, various game and utility programs. Best offer takes all. Andrew Hunt, 34 Sams South Dr., Pawling, NY 12564, (914) 855-1073.

**FOR SALE:** Commodore 2022 tractor-feed printer. Upper-case and lowercase, PET graphics, expanded characters, and formatted lines. Includes PET to IEEE cable, manual, and several programs. 1495 John E. Barnes, 13 Acorn Dr., Wilmington, DE 19808, (302) 772-4085 days, 999-7831 evenings.

**WANTED:** Self-study courses on computers by Sytek, Heathkit, or NRI. Should be complete and in good condition. Send description of course and price. Dan Williams, POB 1321, Collegedale, TN 37315.

**FOR SALE:** BYTE 24 issues from 1978 to 1980. Interface Age 4 issues from 1977 to 1978. Knowledge Magazine 27 issues from 1978 to 1980. Computer News 3 issues from 1977. Creative Computing 1 issue from 1977. ROM 1 issue from 1977. Personal Computing 1 issue from 1979. Best offer: Norman Rabek, Rt. 2, Box 56, Burnsville NC 28714.

**FOR SALE:** Osborne 1 including all software \$1500. Also, Epson MX-80 II FT printer and cable \$550. Prices include shipping and insurance. Used only a few months. Thomas Bailey, 1626 Adams Ave., San Diego CA 92116, (619) 296-6801.

**FOR SALE:** OSI C24P → with 6502 at 2MHz, 24K RAM, expandable to 48K, 8-inch disk drive, OS-65D V3.3 DOS, 32 by 32 or 32 by 64 video display, 256 by 512 effective screen resolution, RS-232C, and two OSI I/O buses for additional external I/O. Also, EPROM programmer, high-speed analog I/O, home security or AC remote-control systems and lots of software. System works fine, in very good condition. Paid over \$2200, will sell for \$1200 or best offer. Tom Grant, 4343 Old Fort Rd., Klamath Falls, OR 97601, (503) 883-2876.

**FOR SALE:** SSM V83A video board for S-100 bus with 80 by 24 display, many screen attributes, and graphics. Includes disk of software drivers for intelligent terminal emulation for V83A from SSM. A little over 1 year old, perfect working order. Cost \$490 new, \$375 or best offer. Howard Spindel, 20877 Southwest Winema Dr., Tualatin, OR 97062, (503) 692-5778.

**FOR SALE:** Two Tandon TM-100-I drives mounted in an external cabinet including power supply \$400 or best offer. IBM 64K memory board \$200 or best offer. Terry Selick, POB 649, Bendure, IL 61008.

**WANTED:** Public-domain CP/M 2.2 utilities, etc., and 8080 ASM source code, if possible. Will pay reasonable copying and handling charges. Will also swap what I have. Need Norm Star 5 1/4-inch format, OS/DD preferred. Send description and usage with any known bugs. Philip Bone, 27 Snaith Dr., Spring Valley, NY 10977, (914) 425-2550 evenings.

**WILL SHARE:** Apple II software found useful by a school guidance/counseling department. Includes information on selecting a career, commercial programs helpful to counselors and has storing, retrieving, and sorting capabilities. Send large SASF for information. Keith L. Dneberg, Guidance Dept., Auburn Adventist Academy, 5000 Auburn Way South, Auburn, WA 98002.

**FOR SALE:** Two years of BYTE magazine, numbers 1 through 24. Good to excellent condition. Best offer: John Steiner, 508 4th Ave. NW, Riverside, MD 58078, (701) 282-2293.

**WANTED:** 6809 Flex user would like to correspond with other users to exchange programs and ideas. Need business applications, games, scientific programs, and control applications. I have several disk utilities running under TSC Flex C-3. Severin, POB 2023, Beaverton, OR 97075, (503) 646-1545.

**FOR SALE:** IBMASL 22-slot, S-100 system with 28-amp supply, front panel, Cromemco ZPU processor board (280 has 2 or 4 MHz), SDS Expander with 48K installed, Wameco EPROM board for 2708s or 2716s, Godbout #106 active terminator board, also, original MSAL 8080 processor and 9K RAM boards. All in working order with original boxes and manuals. \$700 plus postage. Tom Lowery, Rt. 2, Box 706, Georgetown, KY 40324, (502) 863-6165.

**FOR SALE:** CompuColor II, 16K RAM (expandable), screen refresh RAM, 27K system ROM including BASIC, built-in 5 1/4-inch floppy-disk drive, built-in high-resolution color monitor 128 by 128 eight-color graphics, 32 by 64 ASCII, upper and lowercase, sound board, RS-232C port, and a 101-key keyboard. Software includes Star Trek database, chess, income tax, sound effects, music, etc. Complete manuals and schematics. Operating system listing. Originally over \$2000. Will sell for \$599. Vick Bennisen, 7 Georgetown Dr., Amherst, NH 03031, (603) 673-9073.

**FOR SALE:** TRS-80 Model I, 16K, Level II, tape system with 42 tapes of \$300 worth of software: assembler, debugger, people's Pascal, Flux compiler, Duryonquest, Asteroids, Microchess, FSI Barget Simulator, Typing Tutor, The Game of Life, and more \$650 or trade for Apple. Fred Sarni, 14872 Sycamore Manor Dr., Chestertown, MD 20617, (314) 532-7799.

**FOR SALE:** SWTPC 6800 8K RAM, MPS, MPLA, 3200 Thomas Video RAM, 575 Jameco keyboard with case \$110. DC3 Disk Controller \$150, 64K dynamic RAM with 64K \$360. OC3 540 CT-64 \$75 as is. Ray Utter, Box 5207, Virginia Beach, VA 23455.

**WANTED:** A deal on a good quality printer with suitable interface, allowing it to run with Commodore PET 4032 and Paper Mite word processor. Correspondence or letter quality OK. M. Bilk, 412 Hollybrook Dr., Midland MI 48640, (517) 431-7607, weekends or after 5 p.m. on weekdays.

**FOR SALE:** Oxyx 20 MB hard-disk computer, almost new, in perfect condition. Two Teletype 950 terminals with a detachable keyboard. One Diablo 630 Printer. R. W. Peterson, (504) 387-1463.

**FOR SALE:** SOROC IO-170, mint condition, just burned in \$550 or best offer. David Foir, 13 Bellevue Ave., Pennell, PA 19047, (215) 752-4101.

**WANTED:** I am trying to find chess programs which run on CP/M 2.2 with no graphics (Teletype 950 terminal). Please send specs, documentation and cost of your software (for 8-inch floppy). A. B. Muller, 793 K Tramway Lane, Albuquerque, NM 87122.

**UNCLASSIFIED POLICY:** Readers who have computer equipment to buy, sell, or trade or who are requesting or giving advice may send a notice to BYTE for inclusion in the Unclassified Ads section. To be considered for publication, an advertisement must be non-commercial (individuals or bona fide computer clubs only), typed, double-spaced on plain white paper, contain 75 words or fewer, and include complete name and address. This service is free of charge; notices are printed once only as space permits. Your confirmation of placement is appearance in an issue of BYTE as we engage in no correspondence. Please allow at least three months for your ad to appear. Send your notices to Unclassified Ads, BYTE/McGraw-Hill, POB 372, Hancock, NH 03449.



# Unclassified Ads

**FOR SALE:** Anderson-Jacobson Model B41 110 communicating Selectric typewriter. RS-232C cable included. Excellent condition, prints ASCII text at 14.5 cps. Asking \$800. Will consider trade for Epson dot-matrix printer, preferably MX100 John Kennedy, 3300 Carnageway Dr #402, Arlington Heights, IL 60004, (312) 322-6039 or 577-2282

**WANTED:** Atan 400/800 owners who would like to swap programs and conversation about computers, science facilities, electronics, etc., by cassette tape. Will also tape for conversations with other computer buffs. Bill Wheat, Apt 1103, Arrowbend Dr., Williamson, NY 14589.

**FOR SALE:** SSM CBIA and SSM #04. Both boards have sockets and other components installed, but have few integrated circuits, \$60. Greg Bober, 20126 Doyle Court, Grosse Pointe Woods, MI 48236, (313) 894-2133.

**FOR SALE:** HP-85A computer with the following options: 16K RAM module, HP-IB interface, 5 1/4-inch floppy disk and controller, 12 software packs including Visicalc Plus and Graphics Pac. Also includes ROM drawer and following ROMs: IO, Advanced Pgm, Mass Storage, Matrix, Assembler, and Plotter/Printer. Less than one year old. Asking \$4500. Gary Derbyshire, 220 East Mermaid Lane #115, Philadelphia, PA 19118, (215) 242-3138.

**FOR SALE:** 192K bytes of DEC core memory (MF-11 Lp), with all control boards, three backplanes, cables, and documentation. Each backplane holds 64K bytes. Memory in perfect working order and still under DEC maintenance. Over 40 boards in all, including spare 8K memory core. Came out of PDP-11/50 (fns 40, 45 also). Lists for \$250 per 8K words. Used price \$1000. Charles Vlau, 424 Commercial St., Braintree, MA 02174, (617) 848-3669 evenings.

**WANTED:** People interested in sharing ideas about the Commodore VIC-20. The possibility exists of forming a user group to span the continent. D. Piette, 2351 Workman, Montreal, Quebec H3J 2N3, Canada.

**WANTED:** Video Brain Computer (Uimtech) with APLUS cartridge. Also, Video Brain peripherals (Expander I cassette interface, Expander 2 modem, printer, joysticks, cartridges, etc.), schematics, manuals, or any information on where I may obtain these items. Correspondence from Video Brain owners or user groups welcome. Please send list of hardware and software with reasonable price information. Patrick King, Box 14165, San Antonio, TX 78214.

**NEEDED:** Statistical programs: general statistics, analyses of variance and regression, nonparametric statistics, pharmacokinetic programs, etc. to be run on a Sibus computer under either CP/M, MS-DOS or CP/M-86. Nils G. Svedmyr, Viktor Rydbergsg 48/357, S-412 81 Göteborg, Sweden. Tel +46 31 204576.

**FOR SALE:** Two Anderson Jacobson 1245 coupler/modems Bell 103 and Bell 202 modes, (300-bps full duplex and 1200-bps half duplex). These were \$700 each new, will sell for \$350 each. Alan Selfridge, 2592 Middlefield Rd., Palo Alto, CA 94301, (415) 327-1140.

**WANTED:** I own a Sinclair ZX81, and would like to trade information with other ZX81 owners. Greg E. Sedbrook, 1004 East 2nd, Del Rio, TX 78840.

**FOR REPAIR:** Printed circuit boards for Qume Sprint 3 (45.55 cps), Sprint 5, Diablo Htype II, and Diablo Model 630. Also, Sprint 9 (45.55 cps) carriage, assembly and motor encoder. Please quote a price for repair. Don Kim, 5515 Livingston Rd., Oxon Hill, MD 20745, (301) 587-0365.

**FOR SALE:** Two Helium-Neon Lasers. 2-milliwatt visible red output, \$100 each or will trade. Electronics and laser knowledge required for safe operation. Jim Bonner, 1005 North Dickson St., Tusculumba, AL 35674, (205) 383-1844.

**FOR SALE:** IBM Selectric printer purchased as a Datel (1035 terminal). It includes a printer (which also doubles as a Selectric typewriter), complete Datel and IBM documentation, and an EPROM set and documentation to convert from correspondence code to parallel ASCII. \$425. Gene Nelson, 74 Brant St. #4, Amherst, NY 14226, (716) 835-8997 or 831-2328.

**NEEDED:** Physics teacher needs Perci 277 disk drive in working condition. W.C. Johnson-Chamberlain, Craven Community College, Box 659, Beaufort, NC 28516.

**SURPLUS:** Sinclair ZX81 owners, 32K memory boards with four VO ports, 312 Board, 46-pin connector, and schematic. \$16. D.L. Beduhn, 411 Clarence Lane, Stoughton, WI 53589.

**FOR SALE:** Synetix 2022 294K double-drive RAM disk emulator for Apple II, new with warranty, software for DOS 3.3, Pascal, and CP/M \$795. Apple grayscale low-resolution luminance board (see 11/82 Crimp & Electric) assembled and tested with software \$100. Michael Gilbert, 73 Spaulding St., Amherst, MA 01002, (413) 253-2786.

**FOR SALE:** Rockwell AIM-65, 28K of static RAM, plus assembler and PLAS PROMs, all documents, one year old. \$425. Ron Dial, 63 Maplewood Ave., Cranston, RI 02920, (401) 943-7408.

**FOR SALE:** Doublevision 80-column card for Apple II, with Doublevision version of Apple PIE 2.0 word-processing software \$200. Also, Integer BASIC firmware card \$50. Dr. Steven Souza, Department of Physics and Astronomy, Williams College, Williamstown, MA 01267.

**FOR SALE:** Intelligent Systems Corporation color-graphic computer systems: Compucolor II with 16K user memory, 5 1/4-inch disk drive, and 72-key keyboard. Intecolor 3651 with 32K user memory, 8-inch disk drive, and 117-key keyboard. Common components for above systems: B-color/113-inch RGB display, Disk BASIC/FCS (DOS) in ROM, RS-232C interface, extensive software, and complete documentation. Will pay insured shipping inside U.S. Darryl Nadvornick, 14818 Elaine Ave., Norwalk, CA 90650.

**WANTED:** Zlog ZDS 1/40 Development System number 05-6013-06. Please send price and full details. Willy Adams, 52 Boerdensstraat, B730 Harelbeke, Belgium, Tel. 056/ 223117.

**FOR SALE:** OSI 8K Superboard computer, 4.5A power supply, RF modulator and programs. \$300. Studio II video game and cartridge \$30. Tom Rezachek, 6337-82nd St. S, Cottage Grove, MN 55016.

## BOMB

### BYTE's Ongoing Monitor Box

Article #	Page	Article	Author(s)
1	14	Little Big Computer	Malloy
2	49	Build an RS-232C Code-Activated Switch	Ciarcia
3	60	Local Area Networks	Saal
4	82	The Fortune 32:16 Business Computer	Barry
5	104	The Movable Conference	Lerch
6	124	Electronic Publishing: The New Newsletter	Bechhoefer
7	134	What a Concept!	Feigel
8	154	Achieving Greater White-Collar Productivity in the New Office	Goldfield
9	176	Word Tools for the IBM Personal Computer	Shuford
10	220	A Comparison of Five Database Management Programs	Abbott
11	232	Stalking the East-Asian Microcomputer	Lemmons
12	242	An Inexpensive Letter-Quality Printer	Brown
13	263	Painter Power, An Electronic Paintbrush for Artists	Pappas, Murray
14	266	BYTE West Coast; Ferment in Silicon Valley	Lemmons
15	272	NAPLPS: A New Standard for Text and Graphics, Part 4: More Advanced Features and Conclusions	
16	286	Better Software Manuals	Fleming
17	298	User's Column: Uterior Motives, Lobo, Buying Your First Computer, JRT Update	Sohr
18	342	Design Philosophy Behind Motorola's MC68000, Part 2	Pournelle
19	368	Building a Hard-Disk Interface for an S-100 System, Part 3	Starnes
20	402	Using IBM's Marvelous Keyboard	Cruce, Alexander
21	418	Strongly Typed Languages	Glasco, Sargent
22	438	The Ins and Outs of the TRS-80 Color Computer	McCoy
23	452	A Conceptual Approach to Real-Time Programming	Stearman
24	474	Regression Fitting to Economic Indexes	Wyss
25	482	Sorting Algorithms for Microcomputers	Merrill, Barron, Diehr

### Apple Shines

Apple created quite a stir in the microcomputing world long before it officially announced the Lisa and Apple IIe. Evidently these new products generated just as much interest among BYTE readers. Gregg Williams won first place in the February BOMB contest for his Product Description of "The Lisa Computer System." As a staff member he is ineligible for the \$100 prize. Second place goes to Robin Moore for his review of "Apple's Enhanced Computer: The Apple IIe." He will receive the \$50 award. Chris Morgan, Gregg Williams, and Phil Lemmons earned third place for their interview with three key members of Apple's engineering team: "An Interview with Wayne Rosing, Bruce Daniels, and Larry Tesler."

# Reader Service

Inquiry No.	Page No.	Inquiry No.	Page No.	Inquiry No.	Page No.	Inquiry No.	Page No.
2	181 NATIONAL COMP. 185	107	COMPONENTS EXPRESS 491			275	MANX SOFTWARE 42
1	1 SUPER WAREHOUSE 243	108	COMPUADD 546	501	ELLIS COMPUTING 48		MARTIN MARIETTA CORP. 490
524	3M DATA RECORDING 113	109	COMPUADD 546	190	EMC DISTRIBUTORS 562	525	MARYMAC INDUSTRIES 491
3	800 SOFTWARE 155	110	COMPUART 25	191	EMERY AIR FREIGHT 330	280	MASON COMPUTERS 22
4	A.S.T. RESEARCH 312, 313	111	COMPUGIFT INC. 358	192	EMPIRICAL RESRCH.GRP. 256	281	MAYNARD ELECTRONICS 160
5	AB COMPUTERS 557	498	COMPUPROGDOBOUT 99	182	ENGINEERING SPECIALTIES 568	282	MC NEILL 514
12	ABC DATA PRODUCTS 30	112	COMPUPROGDOBOUT 369	183	EPSON AMERICA 223	283	MC NEILL 514
7	ABC DATA PRODUCTS 497		COMPUPROGDOBOUT 500, 501	184	ESPRIT SYS. INC. 211	284	MC NEILL 514
8	ABRAMS CREATIVE SERV. 548		COMPUPROGDOBOUT 502	185	ESSEX PUBLISHING 461	502	MC/N INC. 483
9	ACCOUNTS PAYABLE RESRCH 542	113	COMPUERVE 257	186	EXECUTIVE PERIPH. SYS. 251		MCGRAW-HILL/BYTE BOOK CO.
10	ACTION COMPUTER 246	373	COMPUSHACK 252, 253	187	EXPROTEK 158	208	
11	ACTION COMPUTER 248	114	COMPUISOFT PUBL.-B 422	151	FACIT DATAROYAL 419		MCGRAW-HILL BOOK CO. 462
8	ACTIVE ELECTRONICS 463	116	COMPUTER APPARATUS 545	188	FENWAL PROTECTION SYS. 366		MCGRAW-HILL BOOK STORE 214
14	ADDMASTER CORP. 552	117	COMPUTER CHANNEL 540	199	FIGURE LOGIC BUS. EQUIP. 463	515	MEDISOFT 415
15	ADV. PROCESSOR SYS. 542	118	COMPUTER COMPNTS.UNLTD. 523	200	FORMULA INT'L. 309	534	MEGA CO. 383, 584
16	ADV. COMP. PROD. 576, 577	119	COMPUTER DISCOUNT PROD. 563	201	FOX & GELLER INC. 339	288	MEGABYTE INDUSTRIES 550
17	ADV. DIGITAL CORP. 389	120	COMPUTER ENTREPRENEUR 365	202	FRANKLIN COMP. CORP. 287	290	MEMORY MERCHANT 199
18	ADV. LOGIC SYSTEMS 151	505	COMPUTER EXCHANGE 200, 201	504	FROBCO 324		MEMOTECH 145
19	ADV. SYS. CONCEPTS 582	508	COMPUTER EXCHANGE 200, 201	203	G-H COMPUTER SYS. 398	521	METASOFT CORP. 380
522	ADISA CORP 363	507	COMPUTER EXCHANGE 200, 201	204	GARDEN OF EDEN COMP. 548	292	METHOD SYSTEMS 558
21	ADVENTURE INT'L. 516	122	COMPUTER INNOVATIONS 64	205	GENERAL MICRO SYSTEMS 552	293	MICRO ADE 548
22	AFTERTHOUGHT ENG. 542	123	COMPUTER MAIL ORDER 424, 425	207	GENIE COMP. CORP. 45	294	MICRO AGE COMP. STORE 288
	ALF PRODUCTS, INC. 170	126	COMPUTER PERIPH. INC. 423	208	GIFFORD COMP. SYS. 187	295	MICRO BUSN. WORLD 291
23	ALL ELECTRONICS CORP. 558	127	COMPUTER PLUS 378	209	GILTRONIX INC. 260	296	MICRO CONTROL SYS. 315
24	ALPHA BYTE COMP. PROD. 46, 47	128	COMPUTER SCIENCE PRESS 370	210	GREAT SALT LAKE COMP. 625		MICRO INK, INC. 483
25	ALPHA BYTE COMP. PROD. 332	130	COMPUTER SOLUTIONS 26	211	GTEK INC. 24	287	MICRO LOGIC 554
26	ALLOS COMP. SYS. 299	131	COMPUTER SPCLTIES. 173	528	HAYDEN SOFTWARE 277	298	MICRO MANAGEMENT SYS. 427
27	AMANUENSIS 484	124	COMPUTER STORE, THE 542	212	HAYES MICROCOMP. PROD. 78	115	MICRO MARKETING 544
28	AMER SQUARE COMP. 149	125	COMPUTER STORE, THE 546	213	HAYES MICROCOMP. PROD. 304, 305	531	MICRO MART 584
29	AMERICAN MITAC CORP. 582		COMPUTER WAREHOUSE 195	215	HEATH COMPANY 345	299	MICRO MIDWEST 398
31	APPARAT INC. 121	513	COMPUTERS & MORE 415	458	HOBBY-TRONIX INC. 561	300	MICRO MINT 459
32	APPLE COMPUTER INC. CH. 1	132	COMPUTERLINE INT'L-A 350, 351	216	HOFFMAN COMP. PROD. 238	433	MICRO MINT 592
42	APPLEWARE, INC. 560	133	COMPUTERLINE INT'L-B 357	217	HOFFMAN COMP. PROD. 548	301	MICRO PRO. INT'L. 472, 473
43	APPLIED SOFTWARE TECH 377	134	COMPUTING 453	30	HOLLYWOOD HARDWARE 552	302	MICRO-SCI 108
518	ARBITUS TOTALSOFT INC. 476	135	COMPUVIEW PROD. INC. 65	218	HUMAN SOFT 283	523	MICRO SOLUTIONS 564
45	ARK MICROSYSTEMS 216	136	CONCURRENT CORP. 388	219	I.B.C. 19	304	MICRO WORKS, THE 120
46	ARTIFICIAL INT'L. RESRCH. 396	137	CONTRACT MICROS 550		I.D.S. 393	147	MICRO XPRESS 550
47	ASHTON-TATE 29	138	COST PLUS COMP. 548	220	I.T.M. 480	537	MICROCOMP. BUSN. IND. 191
48	ASHTON-TATE 152, 153	139	COUGAR MOUNTAIN SOFT 363	221	IBM CORP. 122, 123	538	MICROCOMP. BUSN. IND. 280, 281
48	ASHTON-TATE 259	140	CPU SHOP, THE 553	222	IBM/SMALL SYS. DIV. 436, 437	305	MICRODYNAMICS 562
50	ASPEN SFTW. CO. 118	141	CREATIVITY UNLTD. 412	223	IDE CORP. 171	306	MICROHOUSE 12, 13
	AT&T LONG LINES 387	142	CROMEMCO 2	224	IMS INTERNATIONAL 129	509	MICROLOG 302
51	ATARI 174, 175	143	CUESTA SYSTEMS 554	533	IMAGE COMP. PROD. 584	374	MICROMAIL 539
53	ATLANTIS COMP. SERV. 558	144	CUSTOM COMP. TECH. 488	225	INCDMM 517	307	MICROPERIPH. CORP. THE 483
54	AUTOCONTROL INC. 554	145	CYBERNETICS INC. 362	235	INFO. REDUCTION RESEARCH 308	308	MICROPERIPH. CORP. THE 560
	AUTOMATED EQUIPMNT. 395	146	CYBORG CORP. 78	226	INMAC 181	309	MICROPROCESSORS UNLTD 544
55	AVOCET 221	148	DAMAN 556	236	INNOVATIVE COMM. 554		MICROSOFT 117
56	B&B ELECTR. 552	497	DATA ACQUISITIONS 101	227	INSIGHT ENTERPRISES 550		MICROSOFT 337
	BARGAIN BOARDS 542	148	DATA ELECTRONICS INC. 288		INSTITUTE -SCTF. ANALYSIS 157	310	MICROTECH EXPORTS 282
57	BASF SYSTEMS 255	149	DATA EXCHANGE 560		INT'L. INST. OF APPLD. TECH. 193	517	MICROTYPE 476
58	BASIS, INC. 119	233	DATA MAIL 180	228	INT'L. MICRO SYS. 87	311	MICROWARE 580
59	BAUSCH & LOMB INSTR. SYS. 289	150	DATA MANAGEMENT SYS. 544	230	INTEGRAL QUALITY 126	229	MILLER MICROCOMP. SERV. 258
61	BAY TECHNICAL ASSOC. 199		DATA-ED 381	231	INTEGRAND 394	312	MK RESEARCH 548
62	BELL, JOHN ENGR. 551	153	DATA-LINE 560	232	INTELLIGENT DEVICES INC. 550	273	MKS 542
63	BETSY BYTES 546	155	DATAMASTERS 562	234	INTERACTIVE STRUCT. 159	313	MOORE BUSN. FORMS 484
64	BHRT 267	156	DATASMITH 517	237	INTERCONTN. MICROSYS. 72	314	MORROW DESIGNS 230, 231
65	BI-COMM SYSTEM 142	512	DATASOUTH SYS. CORP. 323	338	INTERDATA SYSTEMS INC. 544	316	MOUNTAIN VIEW PRESS 213
66	BIBLIOGRAPHIC RETRIEVAL 303	157	DATASOUTH COMP. CORP. 458	239	INTERTEC DATA SYS. 11	317	MOUSE SYSTEMS 15
72	BLAT RESRCH & DEVELP. 172	158	DATASOUTH COMP. CORP. 319	240	IPEX INT'L. 556	318	MOUSER ELECTRONICS 558
73	BOTTOM LINE, THE 197	159	DECISION RESOURCES 27	241	IRONSIDES COMP. CORP. 349	319	MTI SYSTEMS CORP. 254
74	BT ENTERPRISES 398	160	DIGISOFT 497	510	J.C. SYSTEMS 66	320	MULLEN COMP. PROD. 279
76	BUNKER-RAMO 498	161	DIGITAL DIMENSIONS 390	516	J&L SOFTWARE 478	321	MUSYS 96
77	BUSINESS MANAGER 325	162	DIGITAL LABORATORIES 381	242	JADE COMP. PROD. 585	322	NEC HOME ELECTR. USA 77
78	BUSINESS SYS. RSCH. DEV. 542		DIGITAL MARKETING 6	243	JADE COMP. PROD. 586, 587	323	NEC HOME ELECTR. USA 79
	BYTE BACK ISSUES 508	18	DIGITAL RESEARCH 151	244	JAMECO ELECTR. 574, 575	324	NEC HOME ELECTR. USA 187
	BYTE PUBL. INC. 432	163	DIGITAL RESEARCH 327	245	JDR MICRODEVICES 584, 585	325	NEC INFORMATION SYS. 271
81	BYTE COMP. SYS. 442		DIGITAL RESEARCH COMP. 541	246	JDR MICRODEVICES 586, 587		NETRONICS 543
82	BYTEWRITER 116	164	DIP INC. 547	247	JDR MICRODEVICES 588	326	NETWORK CONSLTNG CORP. 162
83	C-SYSTEMS 546		DISCOUNT SOFTWARE 186, 189		JRT SYSTEMS 217	327	NEW GENERATION SYS. 479
84	C.S.D. INC. 569	165	DISWASHER COMP. PERF. 353	249	JUKI INDUSTRY OF AM 311	328	NK INC. 544
532	CABLES UNLTD. 564		DMA 455	250	JVB ELECTRONICS 546	329	NORTH HILLS CORP. 558
85	CAB-TEK, INC. 513	527	DOCUTEL OLIVETTI 275	251	KADAK PRODUCTS, LTD. 324	330	NORTH HILLS CORP. 562
86	CALIF. DATA CORP. 556	175	DOKAY COMP. PROD. INC. 570, 571	253	KENSINGTON MICROWARE 163	331	NORTH STAR COMPUTERS 111
	CALIF. DIGITAL 566, 569		DOW JONES SOFTWARE 292	254	KERN PUBLISHING 131	332	NORTHWEST DIGITAL SYS. 367
	CALIF. MICROCOMP. 308		DOW JONES SOFTWARE 293	255	KEYTRONICS CORP. 137	333	NORTHWEST INSTR. SYS. 89
87	CAMRASS CORP. 568	176	DOWNTOWN BOOK BAZAAR 544	514	LABORATORY MICROSYS. 415	334	NOVATION 206, 209
	CDX CORP. 336	530	DYPUNCH 521	256	LANIER BUSN. PROD. 492, 493	335	NUMERICAL CONTROLS 317
89	CDR SYSTEMS 398	177	DUAL SYS. CONTROL CORP. 166	257	LASER MICRO 489	337	OASIS SYSTEMS 328, 329
20	CDS 556	529	DY-4 SYSTEMS 90	258	LEADING EDGE PROD. CH	338	OCTAGON COMP. SYS. 85
90	CENTENNIAL SOFTWARE 475	178	DYSAN CORP. 359	259	LEHMANN & ASSOC. 550	339	OMEGA MICROWARE, INC. 139
91	CHECKMATE 300		E. ARTHUR BROWN CO. 412		LIBERTY COMP. SALES 391	340	OPEN SYSTEMS INC. 135
93	CHIPS & DALE 483	179	EZ ASSOC. 554	261	LIGO RESEARCH INC. 115	341	OPTIMAL TECHNOLOGY 496
94	CHRISLIN INDUSTRIES 443	180	EAST SIDE SOFTWARE 179	262	LOBO DRIVES INT'L 555	342	OPTRONICS TECH 168
95	CMC INT'L. 447	181	EASTERN ENTERPRISES 461	263	LOGICAL DEVICES 504	343	ORTHOCODE GROUP 382
96	CMC INT'L. 467	182	ECOSOFT 508	265	LOMAS DATA PRODUCTS 421	344	ORyx SOFTWARE 397
97	COGITATE 308	183	EDGE MICROSYSTEMS 412	266	LOTUS DEVELOPMENT 227		OSBORN/MCGRAW-HILL 169
98	COLONIAL DATA SERV. 378	184	EDUCATIONAL MICROCOMP 429	267	LYBEN COMP. SYS. 546	345	OSM COMPUTER 23
99	COLORADO CHIPS 540	185	EDUCATIONAL MICROCOMP 564	268	LYBEN COMP. SYS. 556		OWENS ASSOC. 454
488	COLORADO COMP. PERIPH. 548	186	ELECTRONIC CONTROL 216	289	LYCO COMPUTER 449	346	PACIFIC COMPUTERS 382
101	COLUMBIA DATA PROD. 102, 103	187	ELECTRONIC SPCLTIES 516	290	MACMILLAN BOOK CLUBS 364, 365	347	PACIFIC EXCHANGES 544, 548, 552, 556, 560, 564
102	COLUMBIA NATIONAL 172		ELEG. & CTRL. ENG. BOOK CLUB 480, 481	270	MACROTECH COMP. PROD. 461		PALOMAR COMP. EQUIP. 416, 417
103	COMMUNICATION CABLE 554	188	ELECTROSONICS 580	271	MACROTECH INT'L. 17	353	PAN AMERICAN ELEC. INC. 514
104	COMMUNICATIONS ELECTR. 549	189	ELECTROSONICS 560	272	MAILCOMP INC. 441	355	PERSCI 542
106	COMPAQ COMPUTER CORP. 127			274	MANNESMANN TALLY 71	356	PERSCI 552

To get further information on the products advertised in BYTE, fill out the reader service card with your name and address. Then circle the appropriate numbers for the advertisers you select from the list. Add a 20-cent stamp to the card, then drop it in the mail. Not only do you gain information, but our advertisers are encouraged to use the marketplace provided by BYTE. This helps us bring you a bigger BYTE. The index is provided as an additional service by the publisher, who assumes no liability for errors or omissions. \*Correspond directly with company.



# Reader Service

Inquiry No.	Page No.	Inquiry No.	Page No.	Inquiry No.	Page No.	Inquiry No.	Page No.
368	PRIORITY ONE 578, 579	402	SCION CORP. 5	432	SUPERSOFT 285	483	TRIOLOG 451
369	PRIORITY ONE 580, 581	405	SCION CORP. 5	434	SYSTEMS STRATEGIES 20	484	TRISTAR DATA SYS. 422
370	PRIORITY ONE 582, 583	*	SCOTSDALE SYSTEMS 347	435	TAB BOOKS 433	485	TSK ELECTR. CORP. 241
375	PROFIT SYSTEMS 113	406	SCREENWARE 544	437	TALLGRASS TECH. 73	486	TYCOMP COMPANY 550
378	PROGRAMMERS SFTW. EX. 82	407	SD SYSTEMS 106	438	TARBELL ELECTR. 471	487	U.S. MICRO SALES 572, 573
377	PROGRAMMING INT'L. 340, 341	408	SEARS ELECTRONICS INC. 580	439	TATUM LABS 560	488	U.S. ROBOTICS 130
378	PROMETHEUS PRODUCTS 207	409	SELENE ASSOC. 542	371	TAVA CORP. 229	489	U.S. EXCHANGE 546
379	PROMETHEUS ENTERPR. 400, 401	410	SEMI DISK SYSTEM 295	372	TAVA CORP. 245	490	UNIVERSAL DATA SYS 39
380	PROXIMITY DEVICES CORP. 150	411	SENTINEL COMP. PROD. 56	440	TAYCO BUSINESS FORMS 558	471	VANDATA 114
381	FRYOR COMP. SUPPLIES 142	412	SHERATON HOTELS	441	TECMAR INC. 83	472	VICTOR TECHNOLOGIES 383
382	QUANTEX DIV. 41	413	WORLDWIDE 375	442	TECHNIGRAPHIC DESIGNS 546	473	VICTOR TECHNOLOGIES 218, 219
383	QUADRAM CORP. 57	415	SIERRA DATA SCIENCES 62, 63	443	TELECON SYSTEMS 326	474	VIDE 21
384	QUADRAM CORP. 68, 69	418	SIGEN CORP. 479	444	TELEMAX INC. 544	477	VISTA COMPUTER CO 108
506	QUADRAM CORP. 91	418	SLUDER 496	445	TELETEK 43	477	VISUAL TECH. INC. 87
385	QUADRAM CORP. 360, 361	417	SNAVE SYSTEMS 554	448	TELETEX COMMUNICATIONS 9	478	VLM COMPUTER ELECTR. 558
388	QUARK ENGINEERING 185	418	SOFTWARE ARTS 439	447	TELEVID COMMUNICATIONS 333	479	VOTRAX 301
490	QUBIE DISTRIBUTING 321	419	SOFTWARE BANC 107	448	TELEVIDED SYSTEMS INC. 80, 81	480	VSC TECHNOLOGY 552
387	QUCES 307	128	SOFTWARE STORE, THE 505	449	TERMINAL DATA SYS. 562	481	WAREHOUSE SOFTWARE 184
388	QUICK-N-EASI PROD. INC. 479	420	SOFTWARE SUPPORT INC. 505	450	TERMINALS TERRIFIC 34	482	WASHINGTON COMP. SERV. 442
389	RACET COMPUTES LTD. 184	421	SONICS MICRO SYS. 93	451	TEXAS COMP. SYS. 435	482	WASHINGTON COMP. SERV. 458
390	RADIO SHACK CIV	540	STAR LOGIC 318	452	TEXAS INSTRUMENTS 177	*	WESTICO INC. 205
252	RCA AMER. COMM. 238	422	STAR MICRONICS 31	454	TEXAS INSTRUMENTS 296, 297	483	WESTWARE 32
392	RED BARON COMP. PROD. 132, 133	528	STAR SOFTWARE 235	455	THUNDERHAWK CORP. 178	484	WILD HARE COMP. SYS. 399
394	REMOTE MEASUREMENT SYS. 244	423	STARBUCK DATA CO. 288	456	THUNDERHAWK CORP. 178	485	WINCHENDON GRP., THE 556
395	RIXON 431	424	STEMMOS LTD. 475	457	TIMESHARING DEV. INC. 396	486	WINTEK CORP. 554
495	ROCKY MT. MICRO INC. 181	425	STM CORP. 143	458	TINNEY, RBT. GRAPHICS 457	487	WINTERHALTER & ASSOC. 228
396	RTL PROGRAMMING AIDS 554	426	SUNBELT COMP. PROD. 548	520	TINNEY, RBT. GRAPHICS 478	488	WORDTECH SYSTEMS 550
397	S C DIGITAL 261	427	SUNNY INT'L. 538	519	TOSHIBA AMERICA 445	489	WORLDWIDE COMP. SUPP. 582
398	SAW COMPUTER SUPPLY 556	428	SUNTRONICS 559	459	TOTAL ACCESS 564	491	WYNDHAM GROUP 471
399	S-100 DIV. 686 CORP. 274	429	SUNTRONICS 552	480	TRANSTAR 379	492	X COMP 35
401	SAGE COMP. TECH. 247	430	SUPERSOFT 105	481	TRANSWAVE CORP. 125	493	YANG ELECTRONIC 550
403	SATURN SYSTEMS 85	431	SUPERSOFT 147	482	TRIOLOG 450	494	ZOBEX 33
404	SCIENTIFIC ENG. 552						

\*Correspond directly with company

## NATIONAL ADVERTISING SALES REPRESENTATIVES:

### NEW ENGLAND

ME, NH, VT, MA, RI, EASTERN CANADA  
 Paul McPherson, Jr. (617) 262-1160  
 McGraw-Hill Publications  
 607 Boylston Street  
 Boston, MA 02116

### ATLANTIC

NJ (NORTH), NY, NYC, CT  
 Eugene Duncan (212) 997-2096  
 McGraw-Hill Publications  
 1221 Ave of the Americas - 39th Floor  
 New York, NY 10020

Dick McGurk (212) 997-3588

McGraw-Hill Publications  
 1221 Ave of the Americas - 39th Floor  
 New York, NY 10020

### EAST

PA (EAST), NJ (SOUTH), MD, VA, W, VA,  
 DE, D.C.  
 Daniel Ferro (215) 496-3833  
 McGraw-Hill Publications  
 Three Parkway  
 Philadelphia, PA 19102

### SOUTHEAST

NC, SC, GA, FL, AL, TN,  
 Maggie McClelland (404) 252-0626  
 McGraw-Hill Publications  
 4170 Ashford Dunwoody Road - Suite 420  
 Atlanta, GA 30319

### MIDWEST

IL, MO, KS, IA, ND, SD, MN, WI, NB  
 Jack Anderson (312) 751-3740  
 McGraw-Hill Publications  
 Blair Building  
 645 N. Michigan Ave  
 Chicago, IL 60611

### GREAT LAKES, OHIO REGION

MI, OH, PA (ALLEGHENY), KY, IN  
 Dennis Reilly (313) 352-9760  
 McGraw-Hill Publications  
 4000 Town Center - Suite 770  
 Southfield, MI 48075

### SOUTHWEST, ROCKY MOUNTAIN

UT, CO, WY, OK, TX, AR, MS, LA  
 Alan Morris (214) 458-2400  
 McGraw-Hill Publications  
 Prestonwood Tower - Suite 907  
 5151 Beltline  
 Dallas, TX 75240

### SOUTH PACIFIC

Southern CA, AZ, NM, LAS VEGAS  
 Page Goodrich (714) 857-6292  
 McGraw-Hill Publications  
 3301 Red Hill Ave  
 Building #1, Suite 222  
 Costa Mesa, CA 92626

Karen Niles (213) 480-5243, 487-1140

McGraw-Hill Publications  
 3200 Wilshire Blvd.  
 Los Angeles, CA 90010

### NORTH PACIFIC

HI, WA, OR, ID, MT, NORTHERN CALIF.,  
 NV (EXCEPT LAS VEGAS) W. CANADA  
 David Jern (415) 362-4600  
 McGraw-Hill Publications  
 425 Battery St.  
 San Francisco, CA 94111

Bill McAfee (415) 964-0624

McGraw-Hill Publications  
 1000 Elwell Court - Suite 225  
 Palo Alto, CA 94303

### WEST COAST SURPLUS AND RETAIL ACCOUNTS

Tom Harvey (805) 964-8577  
 3463 State St. - Suite 256  
 Santa Barbara, CA 93105

## European Advertising Sales Representatives:

Mrs. Maria Sarmiento  
 Pedro Telxelra 8, Off. 320  
 Iberia Mart 1  
 Madrid 4, Spain  
 45 52 891

Mr. Andrew Karnig  
 Andrew Karnig & Associates  
 Kungsholmsgatan 10  
 112 27 Stockholm, Sweden  
 08 51 68 70

Mr. Elio Gonzaga  
 McGraw-Hill Publishing Co.  
 Via Baracchini 1  
 20123 Milan, Italy  
 86 90 617

Mrs. Gurlt Gepner  
 McGraw-Hill Publishing Co.  
 115 Yosephthal St.  
 Bat Yam, Israel  
 866 561 321 39

Mr. Fritz Krusebecker  
 McGraw-Hill Publishing Co.  
 Liebigstrasse 27C  
 D-6000 Frankfurt/Main 1  
 West Germany  
 72 01 81

Mr. Hans Csokor  
 Publimedia  
 Reissnerstrasse 61  
 A-1037 Vienna, Austria

Mr. Michael Sales  
 McGraw-Hill Publishing Co.  
 17 rue Georges Bizet  
 F 75116 Paris  
 France  
 720 33 42

Mr. Simon Smith  
 McGraw-Hill Publishing Co.  
 34 Dover St.  
 London W1X 3RA  
 England  
 01 493 1451

Far East/Pacific  
 Seavex Ltd.  
 05-49/50 Tanglin Shopping Center  
 19 Tanglin Rd. Singapore 1024  
 Republic of Singapore

Seavex, Ltd.  
 Room 102, Yu Yuet Lai Bldg.  
 43-55 Wyndham St. Central  
 Hong Kong

Nikkei/McGraw-Hill Publishing Co  
 Nikkei Annex Bldg  
 2-1-2 Uchikanda  
 Chiyoda-Ku  
 Tokyo, Japan



# GUARANTEED TOUGH.

**LEADING  
EDGE.**

Circle 258 on inquiry card.

225 Turnpike Street, Canton, Massachusetts 02021

Toll-free: 1-800-343-6833; in Massachusetts (617) 828-8150. Telex 951-624.



# All You Want in a Computer At a Price You'd Never Expect



## Introducing the New TRS-80® Model 4 Personal Computer From Radio Shack

64K Model 4  
With Two Disk Drives  
And RS-232C

# 1999<sup>00</sup>

Cat No 26-1069

- High-Performance 4 MHz Z80A
- Runs Thousands of Model III TRSDOS™ LDOS™ and CP/M™ Plus Applications
- 80-Column by 24-Line Video Display With Upper and Lower Case
- 64K RAM Is Expandable to 128K—Use It As a Super-Fast RAM-Based "Disk Drive"
- Advanced Job Control Language Allows Completely Unattended Operation
- Sound is Accessible From BASIC or JCL
- Includes Print Spooler (Disk or Memory)
- 70-Key Keyboard Includes Datapad, Plus CONTROL, CAPS and 3 Function Keys
- New Microsoft BASIC Includes CHAIN And COMMON for Larger Programs
- Communications Package Allows Model 4 to be Used As Host or Terminal
- Forms Control, Routing and Linking, and Filtering Using Advanced TRSDOS 6.0
- Reverse Video Highlights Corrections
- Options Include 640 x 240 Graphics, Hard Disk System and CP/M-Plus\*

With its new advanced operating system and Microsoft™ BASIC, Model 4 is already an amazing value. But consider these other built-in features: two 184K, 5 1/4" double-density disk drives, hi-res monitor, parallel printer and RS-232C interfaces. Don't pay more later to add these features to another personal computer. We *include* what most charge extra for!

See the fantastic new TRS-80 Model 4 at your nearby Radio Shack store, Computer Center or participating dealer—today.

## Radio Shack®

The biggest name in little computers™

A DIVISION OF TANDY CORPORATION

Circle 390 on Inquiry card.

**Send me a free TRS-80 Computer Catalog today!**

Mail To: Radio Shack, Dept. 83-A-164  
300 One Tandy Center, Fort Worth, Texas 76102

NAME \_\_\_\_\_  
ADDRESS \_\_\_\_\_  
CITY \_\_\_\_\_ STATE \_\_\_\_\_ ZIP \_\_\_\_\_  
PHONE \_\_\_\_\_

\*Available soon! Retail prices may vary at individual stores and dealers. LDOS is a trademark of Logical Systems Inc. CP/M Plus is a registered trademark of Digital Research, Inc. Microsoft is a registered trademark of Microsoft Inc.